



SAR Test Report

Report No.: AGC00068131106FH01

FCC ID : 055PROFILE
APPLICATION PURPOSE : Original Equipment
PRODUCT DESIGNATION : Mobile Phone
BRAND NAME : iSWAG
MODEL NAME : Profile
CLIENT : SWAGTEK
DATE OF ISSUE : Dec.09, 2013
STANDARD(S) : IEEE Std. 1528:2003
: 47CFR § 2.1093
: IEEE/ANSI C95.1
REPORT VERSION : V1.0

Attestation of Global Compliance(Shenzhen) Co., Ltd.



CAUTION:

This report shall not be reproduced except in full without the written permission of the test laboratory and shall not be quoted out of context.

Report Revise Record

Report Version	Revise Time	Issued Date	Valid Version	Notes
V1.0	/	Dec.09, 2013	Valid	Original Report

The test plans were performed in accordance with IEEE Std. 1528:2003; 47CFR § 2.1093; IEEE/ANSI C95.1 and the following specific FCC Test Procedures:

- KDB 447498 D01 General RF Exposure Guidance v05r01
- KDB 648474 D04 SAR Handsets Multi Xmitter and Ant v01
- KDB 865664 D01 SAR measurement 100 MHz to 6 GHz v01
- KDB 941225 D01 SAR test for 3G devices v02
- KDB 941225 D02 Guidance for 3GPP R6 and R7 HSPA v02v01
- KDB 941225 D03 SAR Test Reduction GSM GPRS EDGE v01
- KDB 941225 D06 Hot Spot SAR v01
- KDB 248227 D01 SAR meas for 802 11 a b g v01r02

Test Report Certification	
Applicant Name	: SWAGTEK
Applicant Address	: 10205 NW 19th Street, STE 101, Miami, FL33172, USA
Manufacturer Name	: Kingtech Telecom (Shenzhen) Co., Ltd.
Manufacturer Address	: Floor 3, Building A, No.3, Road 1 of Shangxue Dengxinkeng Industry Park, Bantian Street, Longgang District, Shenzhen City, PRC
Product Designation	: Mobile Phone
Brand Name	: iSWAG
Model Name	: Profile
Different Description	: N/A
EUT Voltage	: DC3.7V by battery
Applicable Standard	: IEEE Std. 1528:2003 47CFR § 2.1093 IEEE/ANSI C95.1
Test Date	: Dec.06, 2013
Performed Location	Attestation of Global Compliance(Shenzhen) Co., Ltd.
	2 F, Building 2, No.1-No.4, Chaxi Sanwei Technical Industrial Park, Gushu, Xixiang Street, Bao'an District, Shenzhen, China
Report Template	: AGCRT-US-3G/SAR (2013-03-01)

Tested By Sun YIN
Sun Yin Dec.09, 2013

Checked By Angela Li
Angela Li Dec.09, 2013

Authorized By Solger Zhang
Solger Zhang Dec.09, 2013

TABLE OF CONTENTS

1. SUMMARY OF MAXIMUM SAR VALUE	5
2. GENERAL INFORMATION	7
2.1. EUT DESCRIPTION.....	7
2.2. TEST PROCEDURE	9
2.3. TEST ENVIRONMENT.....	9
2.4. TEST CONFIGURATION AND SETTING	10
3. SAR MEASUREMENT SYSTEM	11
3.1. SPECIFIC ABSORPTION RATE (SAR)	11
3.2. SAR MEASUREMENT PROCEDURE	12
3.3. COMOSAR SYSTEM DESCRIPTION.....	13
3.4. COMOSAR E-FIELD PROBE	15
3.5. ISOTROPIC E-FIELD PROBE SPECIFICATION	15
3.6. ROBOT.....	15
3.7. VIDEO POSITIONING SYSTEM	16
3.8. DEVICE HOLDER	16
3.9. SAM TWIN PHANTOM.....	17
4. TISSUE SIMULATING LIQUID.....	18
4.1. THE COMPOSITION OF THE TISSUE SIMULATING LIQUID.....	18
4.2. TISSUE CALIBRATION RESULT.....	19
4.3. TISSUE DIELECTRIC PARAMETERS FOR HEAD AND BODY PHANTOMS.....	20
5. SAR MEASUREMENT PROCEDURE	21
5.1. SAR SYSTEM VALIDATION PROCEDURES	21
5.2. SAR SYSTEM VALIDATION.....	22
6. EUT TEST POSITION	24
6.1. DEFINE TWO IMAGINARY LINES ON THE HANDSET.....	24
6.2. CHEEK POSITION	25
6.3. TITLE POSITION	25
6.4. BODY WORN POSITION.....	26
7. SAR EXPOSURE LIMITS	27
8. TEST EQUIPMENT LIST	28
9. MEASUREMENT UNCERTAINTY	29
10. CONDUCTED POWER MEASUREMENT	30
11. TEST RESULTS	35
11.1. SAR TEST RESULTS SUMMARY	35
APPENDIX A. SAR SYSTEM VALIDATION DATA	55
APPENDIX B. SAR MEASUREMENT DATA.....	61
APPENDIX C. TEST SETUP PHOTOGRAPHS &EUT PHOTOGRAPHS	183
APPENDIX D. PROBE CALIBRATION DATA	196
APPENDIX E. DIPOLE CALIBRATION DATA.....	206

1. SUMMARY OF MAXIMUM SAR VALUE

The maximum results of Specific Absorption Rate (SAR) found during testing for EUT are as follows:

Highest Report standalone SAR Summary

Exposure Position	Frequency Band	Highest Reported 1g-SAR(W/Kg)	Highest Reported 1g-SAR(W/Kg)
Head	GSM 835	0.162	0.317
	PCS 1900	0.317	
	WCDMA Band II	0.573	0.573
	WCDMA Band V	0.278	
Body- worn	GSM 835	0.739	0.756
	PCS 1900	0.756	
	WCDMA Band II	1.130	1.276
	WCDMA Band V	1.276	

Maximum Scaling standalone SAR Summary

Exposure Position	Frequency Band	Frequency(MHz)	Maximum Scaling 1g-SAR(W/Kg)
Body Back	WCDMA Band V	835	1.389

Exposure Position	Test Mode	Highest Reported 1g-SAR(W/Kg)	Highest Reported 1g-SAR(W/Kg)
Head	802.11b	0.185	0.185
	Hotspot	0.174	
Body	802.11b	0.152	0.152
	Hotspot	0.133	

Highest Simultaneous transmission SAR Summary

Exposure Position	Frequency Band	Highest Reported 1g-SAR(W/Kg)	Highest Reported 1g-SAR(W/Kg)
Head	GSM 835+Bluetooth	0.218	0.758
	GSM 835+WLAN	0.347	
	GSM 835+ Hotspot	0.336	
	PCS 1900+Bluetooth	0.373	
	PCS 1900+WLAN	0.502	
	PCS 1900+ Hotspot	0.491	
	WCDMA Band II +Bluetooth	0.629	
	WCDMA Band II+WLAN	0.758	
	WCDMA Band II+ Hotspot	0.747	
	WCDMA Band V +Bluetooth	0.334	
	WCDMA Band V+WLAN	0.463	
	WCDMA Band V+ Hotspot	0.452	
Body- worn	GSM 835+Bluetooth	0.795	1.428
	GSM 835+WLAN	0.891	
	GSM 835+ Hotspot	0.872	
	PCS 1900+Bluetooth	0.812	
	PCS 1900+WLAN	0.908	
	PCS 1900+ Hotspot	0.889	
	WCDMA Band II +Bluetooth	1.186	
	WCDMA Band II+WLAN	1.282	
	WCDMA Band II+ Hotspot	1.263	
	WCDMA Band V +Bluetooth	1.332	
	WCDMA Band V+WLAN	1.428	
	WCDMA Band V+ Hotspot	1.409	

This device is compliance with Specific Absorption Rate (SAR) for general population/uncontrolled exposure limits (1.6W/Kg) specified in FCC 47 CFR part 2 (2.1093) and ANSI/IEEE C95.1, and had been tested in accordance with measurement methods and procedures specified in IEEE 1528-2003 and the relevant KDB files like KDB 941225 D01 , KDB 941225 D03 ,KDB 865664 D02....etc.

2. General Information

2.1. EUT Description

General Information	
Product Designation	Mobile Phone
Test Model	Profile
Hardware Version	A15_21663_MB_V1.3
Software Version	N/A
Device Category	Portable
RF Exposure Environment	Uncontrolled
Antenna Type	Internal
GSM and GPRS	
Support Band	<input checked="" type="checkbox"/> GSM 850 <input checked="" type="checkbox"/> PCS 1900 (U.S. Bands) <input checked="" type="checkbox"/> GSM 900 <input checked="" type="checkbox"/> DCS 1800 (Non-U.S. Bands)
GPRS Type	Class B
GPRS Class	Class 12(1Tx+4Rx, 2Tx+3Rx, 3Tx+2Rx, 4Tx+1Rx)
TX Frequency Range	GSM 850 : 824.2~848.8MHz; PCS 1900: 1850.2~1909.8MHz;
RX Frequency Range	GSM 850 : 869~894MHz PCS 1900: 1930~1990MHz
Release Version	R99
Type of modulation	GMSK for GSM/GPRS
Antenna Gain	1.0dBi
Max. Average Power (Max. Peak Power)	GSM850: 31.42dBm(32.27dBm- Peak Power) PCS1900: 28.33dBm(29.29dBm-Peak Power)
WCDMA	
Support Band	U.S. Bands: <input checked="" type="checkbox"/> UMTS FDD Band II <input checked="" type="checkbox"/> UMTS FDD Band V Non-U.S. Bands: <input type="checkbox"/> UMTS FDD Band I <input type="checkbox"/> UMTS FDD Band III <input type="checkbox"/> UMTS FDD Band VIII
HS Type	HSPA(HSUPA/HSDPA)
TX Frequency Range	WCDMA FDD Band II: 1852.4 -1907.6MHz WCDMA FDD Band V: 826.4-846.6MHz

RX Frequency Range	WCDMA FDD Band II: 1930-1990MHz WCDMA FDD Band V: 869-894MHz
Release Version	Rel-6
Type of modulation	QPSK
Antenna Gain	0.8dBi
Max. Average Power (Max. Peak Power)	Band II: 22.77dBm (23.68dBm- Peak Power) Band V: 22.82dBm (23.63dBm- Peak Power)
Bluetooth	
Bluetooth Version	<input type="checkbox"/> V2.0 <input type="checkbox"/> V2.1 <input type="checkbox"/> V2.1+EDR <input checked="" type="checkbox"/> V3.0 <input type="checkbox"/> V3.0+HS <input checked="" type="checkbox"/> V4.0
Operation Frequency	2402~2480MHz
Type of modulation	<input checked="" type="checkbox"/> GFSK <input checked="" type="checkbox"/> π/4-DQPSK <input checked="" type="checkbox"/> 8-DPSK
Avg. Burst Power	1.21dBm
Antenna Gain	1.2dBi
WIFI	
WIFI Specification	<input type="checkbox"/> 802.11a <input checked="" type="checkbox"/> 802.11b <input checked="" type="checkbox"/> 802.11g <input checked="" type="checkbox"/> 802.11n(20) <input checked="" type="checkbox"/> 802.11n(40)
Operation Frequency	2412~2462MHz
Avg. Burst Power	11b:12.22dBm,11g:9.68dBm,11n(20):9.52dBm,11n(40):5.04dBm
Antenna Gain	1.2dBi
Accessories	
Battery	Brand name: iSWAG Model No. : Profile Voltage and Capacitance: 3.7 V & 1500mAh
Adapter	Brand name: iSWAG Model No. : Profile Input: AC 100-240V, 50/60Hz, 0.1A Output: DC 5V,700mA
Earphone	Brand name: iSWAG Model No. : Profile

Note: The sample used for testing is end product.

2.2. Test Procedure

1	Setup the EUT and simulators as shown on above.
2	Turn on the power of all equipment.
3	EUT Communicate with 8960, and test them respectively at U.S. bands

2.3. Test Environment

Ambient conditions in the laboratory:

Items	Required	Actual
Temperature (°C)	18-25	21± 2
Humidity (%RH)	30-70	55±2

2.4. Test Configuration and setting

The EUT is a model of GSM Portable Mobile Station (MS). It supports GSM/GPRS, BT, WIFI, and support hot spot mode.

For WWAN SAR testing, the device was controlled by using a base station emulator. Communication between The device and the emulator were established by air link. The distance between the EUT and the antenna is larger than 50cm, and the output power radiated from the emulator antenna is at least 30db smaller than the output power of EUT.

For WLAN testing, the EUT is configured with the WLAN continuous TX tool through engineering command.

Antenna Location:

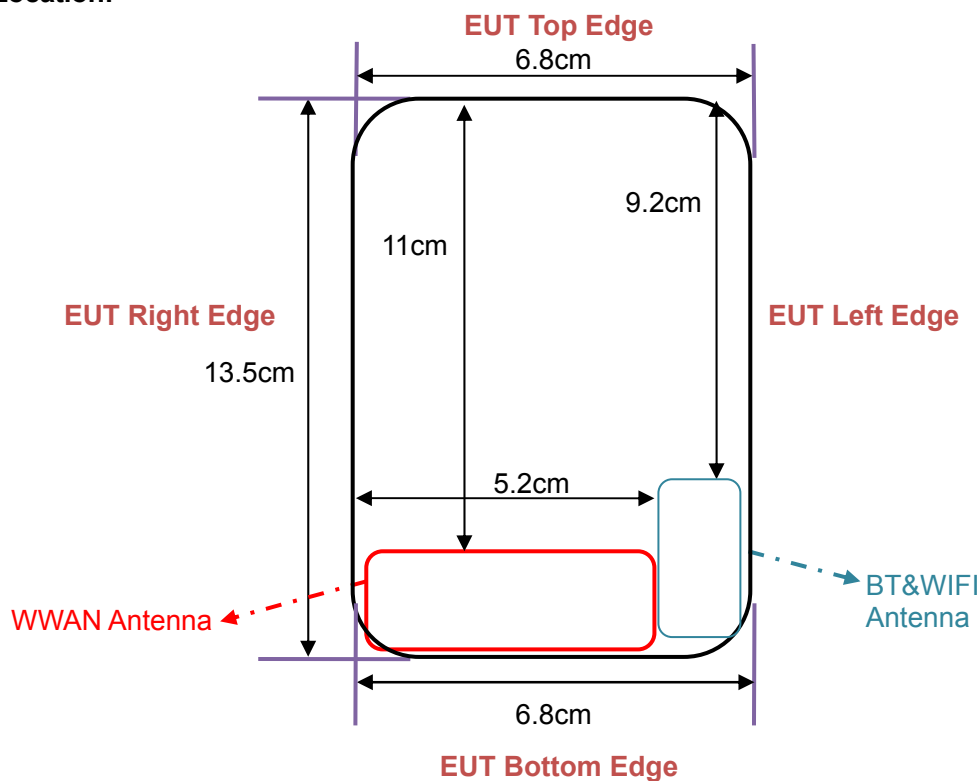

The separation distance for antenna to edge:

Antenna	To Top Side(cm)	To Bottom Side(cm)	To Left Side(cm)	To Right Side(cm)
WWAN	11	0	2	0
BT/WIFI	9.2	0	0	5.2

The simultaneous transmission possibilities are listed as below:

Simultaneous TX Combination	Configuration	Head	Body	Hotspot
1	GSM835(Voice)+ BT/WIFI	Yes	Yes	Yes
2	PCS1900(Voice)+ BT/WIFI	Yes	Yes	Yes
3	WCDMA Band II(Voice)+ BT/WIFI	Yes	Yes	Yes
4	WCDMA Band V(Voice)+ BT/WIFI	Yes	Yes	Yes

3. SAR MEASUREMENT SYSTEM

3.1. Specific Absorption Rate (SAR)

SAR is related to the rate at which energy is absorbed per unit mass in object exposed to a radio field. The SAR distribution in a biological body is complicated and is usually carried out by experimental techniques or numerical modeling. The standard recommends limits for two tiers of groups, occupational/controlled and occupational/uncontrolled, based on a person's awareness and ability to exercise control over his or her exposure. In general, occupational/controlled exposure limits are higher than the limits for general population/uncontrolled.

The SAR definition is the time derivative (rate) of the incremental energy (dW) absorbed by (dissipated in) an incremental mass (dm) contained in a volume (dv) of given mass density (ρ). The equation description is as below:

$$SAR = \frac{d}{dt} \left(\frac{dW}{dm} \right) = \frac{d}{dt} \left(\frac{dW}{\rho dV} \right)$$

SAR is expressed in units of Watts per kilogram (W/Kg)

SAR can be obtained using either of the following equations:

$$SAR = \frac{\sigma E^2}{\rho}$$

$$SAR = c_h \left. \frac{dT}{dt} \right|_{t=0}$$

Where

SAR	is the specific absorption rate in watts per kilogram;
E	is the r.m.s. value of the electric field strength in the tissue in volts per meter;
σ	is the conductivity of the tissue in siemens per metre;
ρ	is the density of the tissue in kilograms per cubic metre;
c_h	is the heat capacity of the tissue in joules per kilogram and Kelvin;

$\left. \frac{dT}{dt} \right|_{t=0}$ is the initial time derivative of temperature in the tissue in kelvins per second

3.2. SAR Measurement Procedure

The EUT is set to transmit at the required power in line with product specification, at each frequency relating to the LOW, MID, and HIGH channel settings.

Pre-scans are made on the device to establish the location for the transmitting antenna, using a large area scan in either air or tissue simulation fluid.

The EUT is placed against the Universal Phantom where the maximum area scan dimensions are larger than the physical size of the resonating antenna. When the scan size is not large enough to cover the peak SAR distribution, it is modified by either extending the area scan size in both the X and Y directions, or the device is shifted within the predefined area.

The area scan is then run to establish the peak SAR location (interpolated resolution set at 1mm^2) which is then used to orient the center of the zoom scan. The zoom scan is then executed and the 1g and 10g averages are derived from the zoom scan volume (interpolated resolution set at 1mm^3).

When multiple peak SAR location were found during the same configuration or test mode, Zoom scan shall performed on each peak SAR location, only the peak point with maximum SAR value will be reported for the configuration or test mode.

3.3. COMOSAR System Description

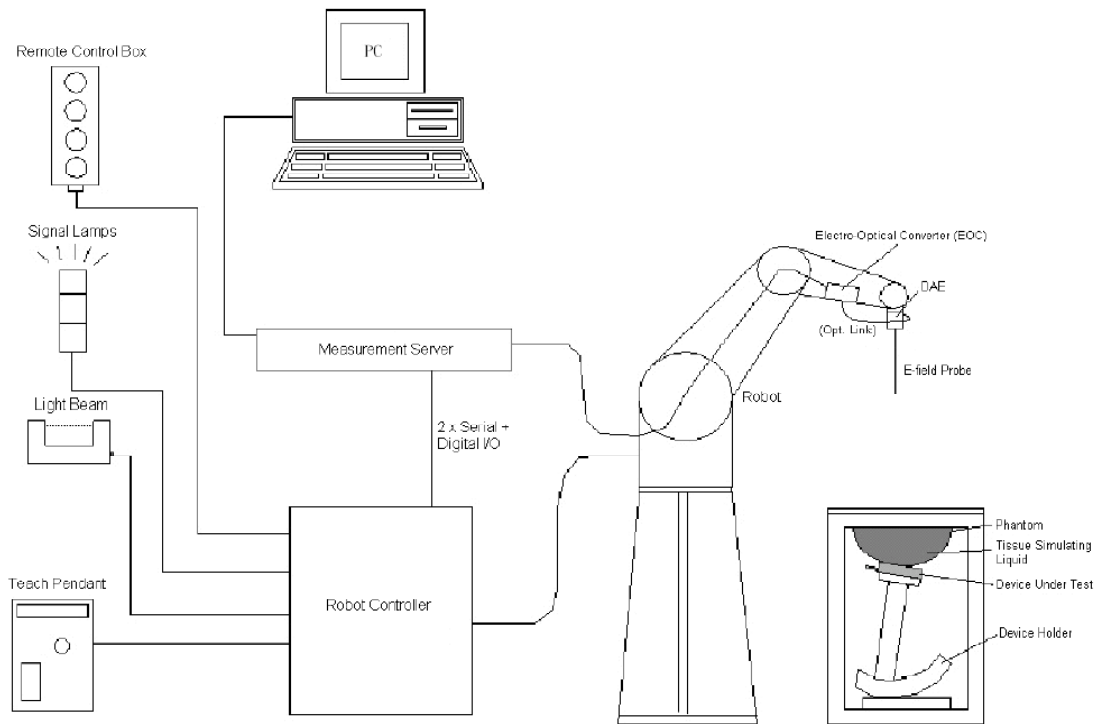

The COMOSAR system for performing compliance tests consists of the following items:

A standard high precision 6-axis robot with controller, teach pendant and software.

An arm extension for accommodating the data acquisition electronics (DAE).

A data acquisition electronics (DAE) which performs the signal amplification, signal multiplexing, AD-conversion, offset measurements, mechanical surface detection, collision detection, etc. The unit is battery powered with standard or rechargeable batteries. The signal is optically transmitted to the EOC.

The Electro-optical converter (EOC) performs the conversion from optical to electrical signals for the digital Communicate to the DAE. To use optical surface detection, a special version of the EOC is required. The EOC signal is transmitted to the measurement server.

The Light Beam used is for probe alignment. This improves the (absolute) accuracy of the probe positioning.

A computer running WinXP and the Opensar software.

Remote control and teach pendant as well as additional circuitry for robot safety such as warning lamps, etc.

The phantom, the device holder and other accessories according to the targeted measurement.

3.3.1. Applications

Predefined procedures and evaluations for automated compliance testing with all worldwide standards, e.g., IEEE 1528, OET 65, IEC 62209-1, IEC 62209-2, EN 50360, EN 50383 and others.

3.3.2. Area Scans

Area scans are defined prior to the measurement process being executed with a user defined variable spacing between each measurement point (integral) allowing low uncertainty measurements to be conducted. Scans defined for FCC applications utilize a 10mm² step integral, with 1mm interpolation used to locate the peak SAR area used for zoom scan assessments.

When an Area Scan has measured all reachable points, it computes the field maxima found in the scanned area, within a range of the global maximum. The range (in dB) is specified in the standards for compliance testing. For example, a 2 dB range is required in IEEE 1528-2003, EN 50361 and IEC 62209 standards, whereby 3 dB is a requirement when compliance is assessed in accordance with the ARIB standard (Japan).

3.3.3. Zoom Scan (Cube Scan Averaging)

Zoom Scans are used to assess the peak spatial SAR values within a cubic averaging volume containing 1 g and 10 g of simulated tissue. A density of 1000 kg/m³ is used to represent the head and body tissue density and not the phantom liquid density, in order to be consistent with the definition of the liquid dielectric properties, i.e. the side length of the 1 g cube is 10mm, with the side length of the 10 g cube 21,5mm.

The zoom scan integer steps can be user defined so as to reduce uncertainty, but normal practice for typical test applications utilize a physical step of 7x7x7 (5mmx5mmx5mm) providing a volume of 30mm in the X & Y axis, and 30mm in the Z axis.

3.3.4. Uncertainty of Inter-/Extrapolation and Averaging

In order to evaluate the uncertainty of the interpolation, extrapolation and averaged SAR calculation algorithms of the Post processor, COMOSAR allows the generation of measurement grids which are artificially predefined by analytically based test functions. Therefore, the grids of area scans and zoom scans can be filled with uncertainty test data, according to the SAR benchmark functions of IEEE 1528. The three analytical functions shown in equations as below are used to describe the possible range of the expected SAR distributions for the tested handsets. The field gradients are covered by the spatially flat distribution f1, the spatially steep distribution f3 and f2 accounts for H-field cancellation on the phantom/tissue surface.

$$f_1(x, y, z) = A e^{-\frac{z}{2a}} \cos^2 \left(\frac{\pi \sqrt{x'^2 + y'^2}}{2 \cdot 5a} \right)$$

$$f_2(x, y, z) = A e^{-\frac{z}{a}} \frac{a^2}{a^2 + x'^2} \left(3 - e^{-\frac{2z}{a}} \right) \cos^2 \left(\frac{\pi y'}{2 \cdot 3a} \right)$$

$$f_3(x, y, z) = A \frac{a^2}{\frac{a^2}{4} + x'^2 + y'^2} \left(e^{-\frac{2z}{a}} + \frac{a^2}{2(a + 2z)^2} \right)$$

3.4. COMOSAR E-Field Probe

The SAR measurement is conducted with the dissymmetric probe manufactured by SATIMO. The probe is specially designed and calibrated for use in liquid with high permittivity. The dissymmetric probe has special calibration in liquid at different frequency. SATIMO conducts the probe calibration in compliance with international and national standards (e.g. IEEE 1528, EN62209-1, IEC 62209, etc.) Under ISO17025. The calibration data are in Appendix D.

3.5. Isotropic E-Field Probe Specification

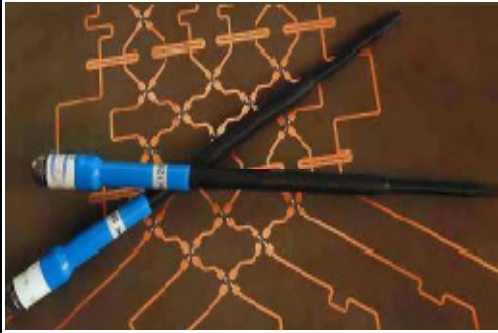
Model	EP165	
Manufacture	SATIMO	
Frequency	0.03GHz-3 GHz Linearity:±0.2dB(30 MHz-3 GHz)	
Dynamic Range	0.01W/Kg-100W/Kg Linearity:±0.2dB	
Dimensions	Overall length:330mm Length of individual dipoles:4.5mm Maximum external diameter:8mm Probe Tip external diameter:5mm Distance between dipoles/ probe extremity:2.7mm	
Application	High precision dosimetric measurements in any exposure scenario (e.g., very strong gradient fields). Only probe which enables compliance testing for frequencies up to 3 GHz with precision of better 30%.	

3.6. Robot

The COMOSAR system uses the KUKA robot from SATIMO SA (France).For the 6-axis controller COMOSAR system, the KUKA robot controller version from SATIMO is used.

The XL robot series have many features that are important for our application:

- High precision (repeatability 0.02 mm)
- High reliability (industrial design)
- Jerk-free straight movements
- Low ELF interference (the closed metallic construction shields against motor control fields)
- 6-axis controller



3.7. Video Positioning System

The video positioning system is used in OpenSAR to check the probe. Which is composed of a camera, LED, mirror and mechanical parts. The camera is piloted by the main computer with firewire link.

During the process, the actual position of the probe tip with respect to the robot arm is measured, as well as the probe length and the horizontal probe offset. The software then corrects all movements, such that the robot coordinates are valid for the probe tip.

The repeatability of this process is better than 0.1 mm. If a position has been taught with an aligned probe, the same position will be reached with another aligned probe within 0.1 mm, even if the other probe has different dimensions. During probe rotations, the probe tip will keep its actual position.

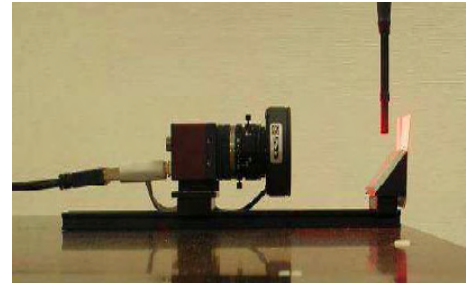

3.8. Device Holder

The COMOSAR device holder is designed to cope with different positions given in the standard. It has two scales for the device rotation (with respect to the body axis) and the device inclination (with respect to the line between the ear reference points). The rotation center for both scales is the ear reference point (EPR).

Thus the device needs no repositioning when changing the angles.

The COMOSAR device holder has been made out of low-loss POM material having the following dielectric parameters: relative permittivity $\epsilon_r = 3$ and loss tangent $\delta = 0.02$. The amount of dielectric material has been reduced in the closest vicinity of the device, since measurements have suggested that the influence of the clamp on the test results could thus be lowered.

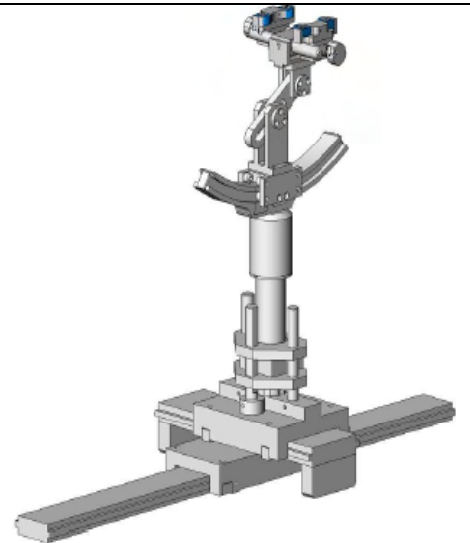

3.9. SAM Twin Phantom

The SAM twin phantom is a fiberglass shell phantom with 2mm shell thickness (except the ear region where shell thickness increases to 6mm). It has three measurement areas:

- Left head
- Right head
- Flat phantom

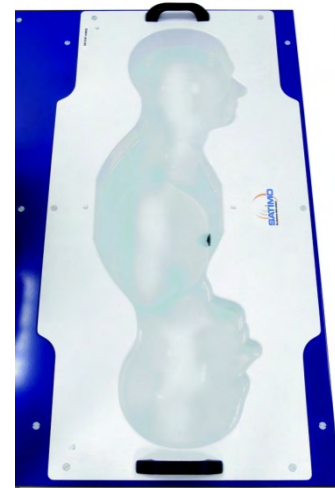

The bottom plate contains three pair of bolts for locking the device holder. The device holder positions are adjusted to the standard measurement positions in the three sections. A white cover is provided to tap the phantom during off-periods to prevent water evaporation and changes in the liquid parameters. On the phantom top, three reference markers are provided to identify the phantom position with respect to the robot.

4.2. Tissue Calibration Result

The dielectric parameters of the liquids were verified prior to the SAR evaluation using COMOSAR Dielectric Probe Kit and R&S Network Analyzer ZVL6 .

Tissue Stimulant Measurement for GSM 835					
Frequency (MHz)	Parts	Description	Dielectric Parameters		Tissue Temp [°C]
835MHz	Head	Reference result ±5% window	ϵ_r 41.50 39.425-43.575	δ [s/m] 0.90 0.855-0.945	N/A
		Dec.06, 2013	40.55	0.86	21
835MHz	Body	Reference result ±5% window	ϵ_r 55.20 52.44-57.96	δ [s/m] 0.97 0.9215-1.0185	N/A
		Dec.06, 2013	53.88	0.94	21

Tissue Stimulant Measurement for PCS 1900					
Frequency (MHz)	Parts	Description	Dielectric Parameters		Tissue Temp [°C]
1900MHz	Head	Reference result ±5% window	ϵ_r 40.00 38.00-42.00	δ [s/m] 1.40 1.33-1.47	N/A
		Dec.06, 2013	39.97	1.38	21
1900MHz	Body	Reference result ±5% window	ϵ_r 53.30 50.635-55.965	δ [s/m] 1.52 1.444-1.596	N/A
		Dec.06, 2013	52.68	1.49	21

Tissue Stimulant Measurement for 2450MHz					
Frequency (MHz)	Parts	Description	Dielectric Parameters		Tissue Temp [°C]
2450MHz	Head	Reference result ±5% window	ϵ_r 39.2 37.24-41.16	δ [s/m] 1.80 1.71-1.89	N/A
		Dec.06, 2013	38.56	1.83	21
	Body	Reference result ±5% window	ϵ_r 52.7 50.065-55.335	δ [s/m] 1.95 1.8525-2.0475	N/A
		Dec.06, 2013	52.34	1.91	21

4.3. Tissue Dielectric Parameters for Head and Body Phantoms

The head tissue dielectric parameters recommended by the IEEE SCC-34/SC-2 in P1528 have been incorporated in the following table. These head parameters are derived from planar layer models simulating the highest expected SAR for the dielectric properties and tissue thickness variations in a human head. Other head and body tissue parameters that have not been specified in P1528 are derived from the tissue dielectric parameters computed from the 4-Cole-Cole equations described in Reference [12] and extrapolated according to the head parameters specified in P1528.

Target Frequency (MHz)	head		body	
	ϵ_r	σ (S/m)	ϵ_r	σ (S/m)
300	45.3	0.87	58.2	0.92
450	43.5	0.87	56.7	0.94
835	41.5	0.90	55.2	0.97
900	41.5	0.97	55.0	1.05
915	41.5	1.01	55.0	1.06
1450	40.5	1.20	54.0	1.30
1610	40.3	1.29	53.8	1.40
1800 – 2000	40.0	1.40	53.3	1.52
2450	39.2	1.80	52.7	1.95
3000	38.5	2.40	52.0	2.73
5800	35.3	5.27	48.2	6.00

(ϵ_r = relative permittivity, σ = conductivity and $\rho = 1000$ kg/m³)

5. SAR MEASUREMENT PROCEDURE

5.1. SAR System Validation Procedures

Each SATIMO system is equipped with one or more system validation kits. These units, together with the predefined measurement procedures within the SATIMO software, enable the user to conduct the system performance check and system validation. System kit includes a dipole, and dipole device holder.

The system check verifies that the system operates within its specifications. It's performed daily or before every SAR measurement. The system check uses normal SAR measurement in the flat section of the phantom with a matched dipole at a specified distance. The system validation setup is shown as below.

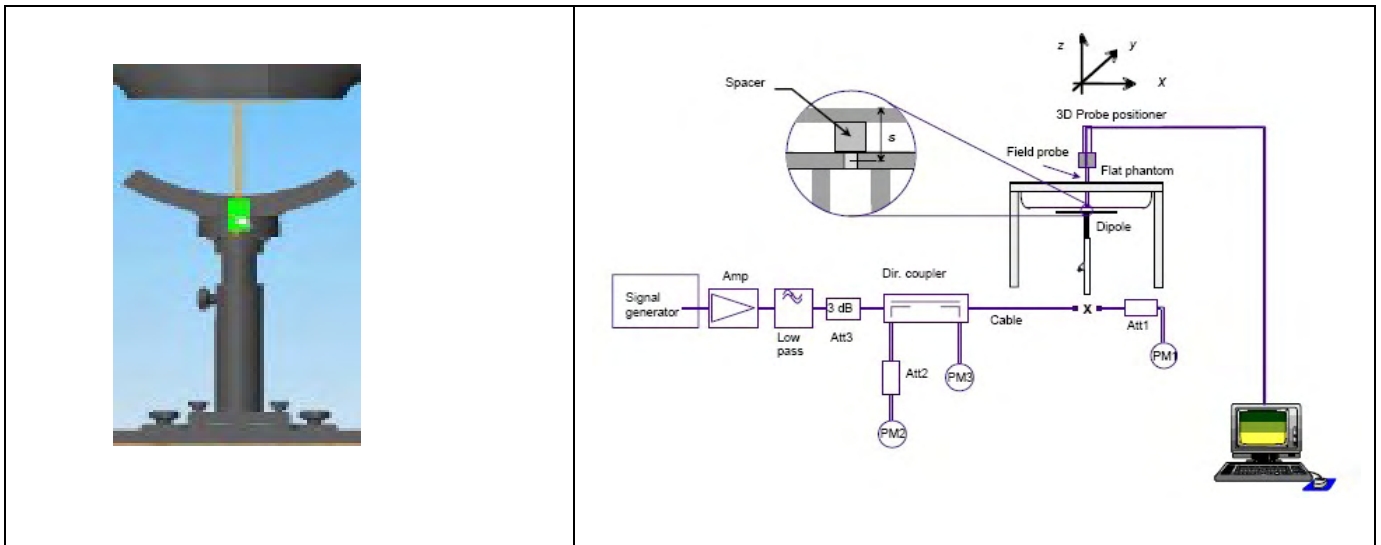

5.2. SAR System Validation
5.2.1. Validation Dipoles

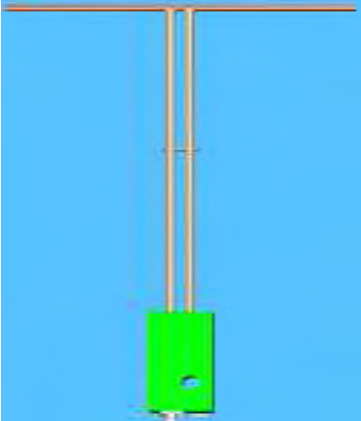
	<p>The dipoles used is based on the IEEE-1528 standard, and is complied with mechanical and electrical specifications in line with the requirements of both IEEE and FCC Supplement C. the table below provides details for the mechanical and electrical Specifications for the dipoles.</p>
---	---

Frequency	L (mm)	h (mm)	d (mm)
900 MHz	149	83.3	3.6
1900MHz	68	39.5	3.6
2450MHz	51.5	30.4	3.6

5.2.2. Validation Result

System Performance Check at 835 MHz &1900MHz&2450MHz for Head				
Validation Kit: SN 46/11DIP 0G900-185				
Frequency [MHz]	Description	SAR [w/kg] 1g	SAR [w/kg] 10g	Tissue Temp.[°C]
835 MHz	Reference result ± 10% window	10.9 9.81 to 11.99	6.99 6.29 to 7.69	N/A
	Dec.06, 2013	10.99	6.84	21.0
Validation Kit: SN 46/11DIP 1G900-187				
Frequency [MHz]	Description	SAR [w/kg] 1g	SAR [w/kg] 10g	Tissue Temp.[°C]
1900 MHz	Reference result ± 10% window	39.7 35.73 to 43.67	20.5 18.45 to 22.55	N/A
	Dec.06, 2013	40.36	20.97	21.0
Validation Kit: SN 46/11DIP 2G450-189				
Frequency [MHz]	Description	SAR [w/kg] 1g	SAR [w/kg] 10g	Tissue Temp.[°C]
2450 MHz	Reference result ± 10% window	52.4 47.16 to 57.64	24.0 21.6 to 26.4	N/A
	Dec.06, 2013	50.37	23.69	21
Note: All SAR values are normalized to 1W forward power.				

6. EUT TEST POSITION

This EUT was tested in **Right Cheek, Right Titled, Left Cheek, Left Titled, Front Face and Rear Face.**

6.1. Define Two Imaginary Lines on the Handset

(1)The vertical centerline passes through two points on the front side of the handset the midpoint of the width w_t of the handset at the level of the acoustic output, and the midpoint of the width w_b of the handset.

(2)The horizontal line is perpendicular to the vertical centerline and passes through the center of the acoustic output. The horizontal line is also tangential to the face of the handset at point A.

(3)The two lines intersect at point A. Note that for many handsets, point A coincides with the center of the acoustic output; however, the acoustic output may be located elsewhere on the horizontal line. Also note that the vertical centerline is not necessarily to the front face of the handset, especially for clamshell handsets, handsets with flip covers, and other irregularly shaped handsets.

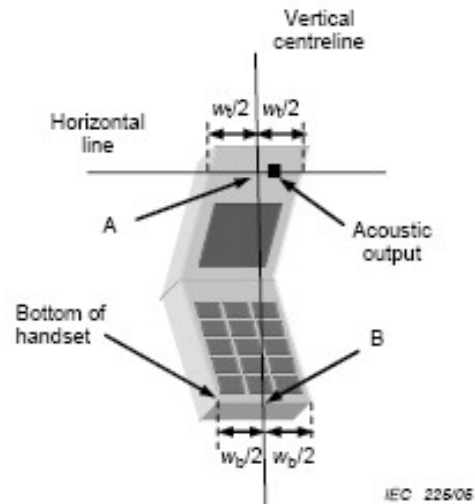
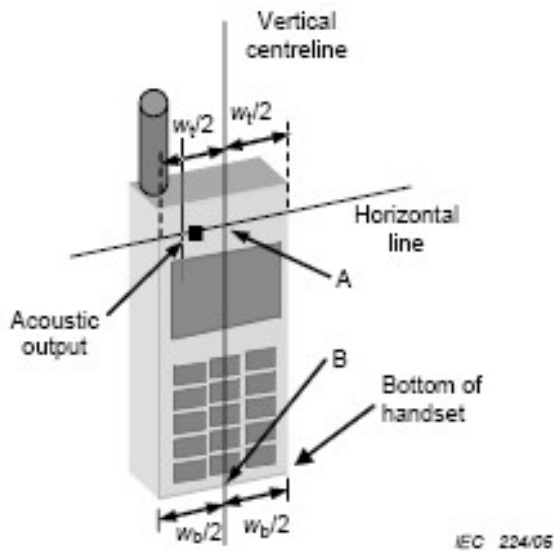

6.2. Cheek Position

- (1) To position the device with the vertical center line of the body of the device and the horizontal line crossing the center piece in a plane parallel to the sagittal plane of the phantom. While maintaining the device in this plane, align the vertical center line with the reference plane containing the ear and mouth reference point (M: Mouth, RE: Right Ear, and LE: Left Ear) and align the center of the ear piece with the line RE-LE.
- (2) To move the device towards the phantom with the ear piece aligned with the the line LE-RE until the phone touched the ear. While maintaining the device in the reference plane and maintaining the phone contact with ear, move the bottom of the phone until any point on the front side is in contact with the cheek of the phantom or until contact with the ear is lost

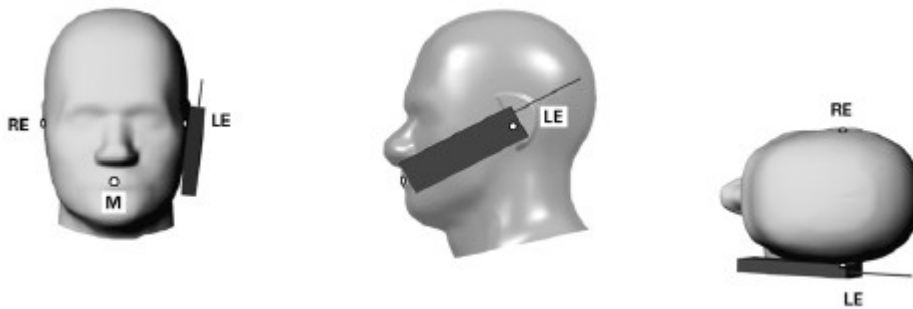

6.3. Title Position

- (1) To position the device in the "cheek" position described above.
- (2) While maintaining the device in the reference plane described above and pivoting against the ear, moves it outward away from the mouth by an angle of 15 degrees or until with the ear is lost.



6.4. Body Worn Position

- (1) To position the EUT parallel to the phantom surface.
- (2) To adjust the EUT parallel to the flat phantom.
- (3) To adjust the distance between the EUT surface and the flat phantom to **5mm** (Hotspot mode the distance of **10mm**).

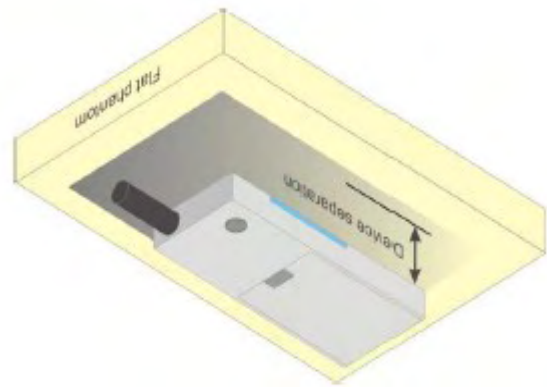
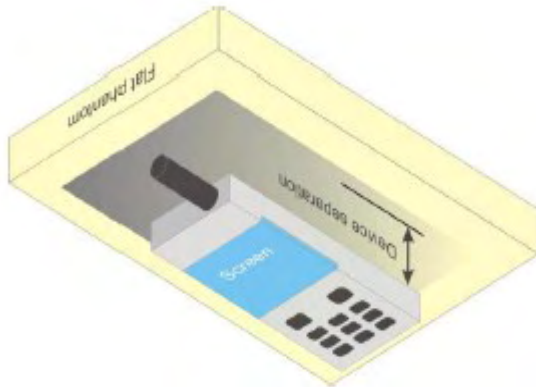

7. SAR EXPOSURE LIMITS

SAR assessments have been made in line with the requirements of IEEE-1528, FCC Supplement C, and comply with ANSI/IEEE C95.1-1992 “Uncontrolled Environments” limits. These limits apply to a location which is deemed as “Uncontrolled Environment” which can be described as a situation where the general public may be exposed to an RF source with no prior knowledge or control over their exposure.

Limits for General Population/Uncontrolled Exposure (W/kg)

Type Exposure	Uncontrolled Environment Limit
Spatial Peak SAR (1g cube tissue for brain or body)	1.60 W/kg

8. TEST EQUIPMENT LIST

Equipment description	Manufacturer/ Model	Identification No.	Current calibration date	Next calibration date
SAR Probe	SATIMO	SN 04/13 EP165	01/31/2013	01/30/2014
Phantom	SATIMO	SN_4511_SAM90	Validated. No cal required.	Validated. No cal required.
Liquid	SATIMO	-	Validated. No cal required.	Validated. No cal required.
Comm Tester	R&S - CMU200	069Y7-158-13-712	02/28/2013	02/27/2014
Comm Tester	Agilent-8960	GB46310822	10/22/2013	10/21/2014
Multimeter	Keithley 2000	1188656	02/28/2013	02/27/2014
Dipole	SATIMO SID900	SN46/11 DIP 0G900-185	12/09/2011	12/08/2013
Dipole	SATIMO SID1900	SN46/11 DIP 1G900-187	12/09/2011	12/08/2013
Dipole	SATIMOSID2450	SN46/11 DIP 2G450-189	12/09/2011	12/08/2013
Amplifier	Aethercomm	SN 046	12/08/2012	12/07/2013
Signal Generator	Agilent-E4421B	MY43351603	05/13/2013	05/12/2014
Power Probe	NRP-Z23	US38261498	02/28/2013	02/27/2014
SPECTRUM ANALYZER	Agilent/E4440A	MY44303916	10/22/2013	10/21/2014
Power Attenuator	BED	DLA-5W	07/30/2013	07/29/2014
Network Analyzer	Rhode & Schwarz ZVA	SN100132	02/28/2013	02/27/2014

Note: Per KDB 50824 Dipole SAR Validation Verification, AGC Lab has adopted 3 years calibration intervals. On annual basis, every measurement dipole has been evaluated and is in compliance with the following criteria:

1. There is no physical damage on the dipole;
2. System validation with specific dipole is within 10% of calibrated value;
3. Return-loss is within 20% of calibrated measurement;
4. Impedance is within 5Ω of calibrated measurement.

9. MEASUREMENT UNCERTAINTY

SATIMO Uncertainty									
Measurement uncertainty for 30 MHz to 3 GHz averaged over 1 gram / 10 gram.									
Error Description	Sec	Tol (±%)	Prob. Dist.	Div.	(Ci) 1g	(Ci) 10g	Std. Unc. (1g) (±%)	Std. Unc. (10g)(±%)	(Vi) Ve ff
Measurement System									
Probe Calibration	E.2.1	6	N	1	1	1	6	6	∞
Axial Isotropy	E.2.2	3	R	$\sqrt{3}$	$(1-C_p)^{1/2}$	$(1-C_p)^{1/2}$	1.22474	1.22474	∞
Hemispherical Isotropy	E.2.2	5	R	$\sqrt{5}$	$\sqrt{C_p}$	$\sqrt{C_p}$	2.04124	2.04124	∞
Boundary Effects	E.2.3	1	R	$\sqrt{3}$	1	1	0.57735	0.57735	∞
Linearity	E.2.4	5	R	$\sqrt{5}$	1	1	2.88675	2.88675	∞
System Detection Limits	E.2.5	1	R	$\sqrt{3}$	1	1	0.57735	0.57735	∞
Readout Electronics	E.2.6	0.5	N	1	1	1	0.5	0.5	∞
Response Time	E.2.7	0.2	R	$\sqrt{3}$	1	1	0.11547	0.11547	∞
Integration Time	E.2.8	2	R	$\sqrt{3}$	1	1	1.1547	1.1547	∞
RF Ambient Noise	E.6.1	3	R	$\sqrt{3}$	1	1	1.73205	1.73205	∞
Probe Positioner Mechanical Tolerance	E.6.2	2	R	$\sqrt{3}$	1	1	1.1547	1.1547	∞
Probe Positioning with Respect to Phantom Shell	E.6.3	1	R	$\sqrt{3}$	1	1	0.57735	0.57735	∞
Extrapolation, interpolation and Integration Algorithms for Max. SAR Evaluation	E.5.2	1.5	R	$\sqrt{3}$	1	1	0.86603	0.86603	∞
Dipole									
Device Positioning	8,E.4.2	1	N	$\sqrt{3}$	1	1	0.57735	0.57735	N-1
Power Drift	8.6.6.2	2	R	$\sqrt{3}$	1	1	1.1547	1.1547	∞
Phantom and Tissue Parameters									
Phantom Uncertainty	E.3.1	4	R	$\sqrt{3}$	1	1	2.3094	2.3094	∞
Liquid Conductivity (target)	E.3.2	5	R	$\sqrt{5}$	0.64	0.43	1.84752	1.2413	∞
Liquid Conductivity (meas.)	E.3.3	2.5	N	1	0.64	0.43	1.6	1.075	∞
Liquid Permittivity (target)	E.3.2	3	R	$\sqrt{3}$	0.6	0.49	1.03923	0.8487	∞
Liquid Permittivity (meas.)	E.3.3	2.5	N	1	0.6	0.49	1.5	1.225	M
Combined Standard Uncertainty			RSS				8.09272	7.9296	
Expanded Uncertainty (95%CONFIDENCE INTERVAL)			k				16.18544	15.8592	

10. CONDUCTED POWER MEASUREMENT

GSM BAND

Mode	Frequency(MHz)	Avg. Burst Power(dBm)	Duty cycle Factor(dBm)	Frame Power(dBm)
Maximum Power <1>				
GSM 835	824.2	31.27	-9	22.27
	836.6	31.42	-9	22.42
	848.8	31.36	-9	22.36
GPRS 835 (1 Slot)	824.2	31.21	-9	22.21
	836.6	31.4	-9	22.4
	848.8	31.23	-9	22.23
GPRS 835 (2 Slot)	824.2	28.36	-6	22.36
	836.6	28.41	-6	22.41
	848.8	28.34	-6	22.34
GPRS 835 (3 Slot)	824.2	26.56	-4.26	22.3
	836.6	26.32	-4.26	22.06
	848.8	26.41	-4.26	22.15
GPRS 835 (4 Slot)	824.2	25.34	-3	22.34
	836.6	25.28	-3	22.28
	848.8	25.52	-3	22.52
PCS1900	1850.2	28.33	-9	19.33
	1880	28.25	-9	19.25
	1909.8	28.23	-9	19.23
GPRS1900 (1 Slot)	1850.2	28.29	-9	19.29
	1880	28.22	-9	19.22
	1909.8	28.14	-9	19.14
GPRS1900 (2 Slot)	1850.2	25.33	-6	19.33
	1880	25.55	-6	19.55
	1909.8	25.43	-6	19.43
GPRS1900 (3 Slot)	1850.2	24.22	-4.26	19.96
	1880	24.16	-4.26	19.90
	1909.8	24.14	-4.26	19.88
GPRS1900 (4 Slot)	1850.2	22.67	-3	19.67
	1880	22.52	-3	19.52
	1909.8	22.58	-3	19.58
Maximum Power <2>				
GSM 835	836.6	31.37	-9	22.37
PCS1900	1850.2	28.23	-9	19.23

Note 1:

The Frame Power (Source-based time-averaged Power) is scaled the maximum burst average power based on time slots. The calculated methods are show as following:

Frame Power = Max burst power (1 Up Slot) – 9 dB

Frame Power = Max burst power (2 Up Slot) – 6 dB

Frame Power = Max burst power (3 Up Slot) – 4.26 dB

Frame Power = Max burst power (4 Up Slot) – 3 dB

UMTS BAND II

Mode	Frequency (MHz)	Avg.Burst Power
WCDMA 1900 RMC	1852.4	22.73
	1880	22.77
	1907.6	22.72
WCDMA 1900 AMR	1852.4	22.29
	1880	22.27
	1907.6	22.17
HSDPA Subtest 1	1852.4	22.35
	1880	22.25
	1907.6	22.31
HSDPA Subtest 2	1852.4	22.36
	1880	22.32
	1907.6	22.35
HSDPA Subtest 3	1852.4	22.31
	1880	22.35
	1907.6	22.47
HSDPA Subtest 4	1852.4	22.36
	1880	22.28
	1907.6	22.30
HSUPA Subtest 1	1852.4	22.29
	1880	22.21
	1907.6	22.18
HSUPA Subtest 2	1852.4	22.22
	1880	22.12
	1907.6	22.27
HSUPA Subtest 3	1852.4	22.25
	1880	22.33
	1907.6	22.31
HSUPA Subtest 4	1852.4	22.43
	1880	22.2
	1907.6	22.18
HSUPA Subtest 5	1852.4	22.66
	1880	22.49
	1907.6	22.29

UMTS BAND V

Mode	Frequency (MHz)	Avg.Burst Power
WCDMA 835 RMC	826.4	22.82
	835.0	22.73
	846.6	22.68
WCDMA 835 AMR	826.4	22.25
	835.0	22.16
	846.6	22.05
HSDPA Subtest 1	826.4	22.23
	835.0	22.17
	846.6	22.24
HSDPA Subtest 2	826.4	22.22
	835.0	22.25
	846.6	22.23
HSDPA Subtest 3	826.4	22.25
	835.0	22.22
	846.6	22.31
HSDPA Subtest 4	826.4	22.34
	835.0	22.23
	846.6	22.34
HSUPA Subtest 1	826.4	22.26
	835.0	22.14
	846.6	22.03
HSUPA Subtest 2	826.4	22.14
	835.0	22.07
	846.6	22.05
HSUPA Subtest 3	826.4	22.13
	835.0	22.12
	846.6	22.08
HSUPA Subtest 4	826.4	22.14
	835.0	22.12
	846.6	22.14
HSUPA Subtest 5	826.4	22.21
	835.0	22.29
	846.6	22.13

WIFI

Mode	Data Rate (Mbps)	Channel	Frequency(MHz)	Avg. Burst Power(dBm)
802.11b	1	01	2412	11.68
		06	2437	11.91
		11	2462	12.22
802.11g	6	01	2412	6.66
		06	2437	9.68
		11	2462	6.81
802.11n(20)	6.5	01	2412	7.17
		06	2437	9.52
		11	2462	7.63
802.11n(40)	13.5	03	2422	4.13
		06	2437	4.62
		09	2452	5.04

Bluetooth_V3.0

Modulation	Channel	Frequency(MHz)	Average Power (dBm)
GFSK	0	2402	0.59
	39	2441	1.17
	78	2480	1.21
$\pi/4$ -DQPSK	0	2402	-0.53
	39	2441	0.12
	78	2480	-0.49
8-DPSK	0	2402	-0.52
	39	2441	-0.08
	78	2480	-0.58

According to 3GPP 25.101 sub-clause 6.2.2 , the maximum output power is allowed to be reduced by following the table.

Table 6.1aA: UE maximum output power with HS-DPCCH and E-DCH

UE Transmit Channel Configuration	CM(db)	MPR(db)
For all combinations of ,DPDCH,DPCCH HS-DPDCH,E-DPDCH and E-DPCCH	$0 \leq CM \leq 3.5$	$MAX(CM-1,0)$
Note: CM=1 for $\beta_d/\beta_d=12/15$, $\beta_{ns}/\beta_c=24/15$.For all other combinations of DPDCH, DPCCH, HS-DPCCH, E-DPDCH and E-DPCCH the MPR is based on the relative CM difference.		

The device supports MPR to solve linearity issues (ACLR or SEM) due to the higher peak-to average ratios (PAR) of the HSUPA signal. This prevents saturating the full range of the TX DAC inside of device and provides a reduced power output to the RF transceiver chip according to the Cubic Metric (a function of the combinations of DPDCH, DPCCH, HS-DPCCH, E-DPDCH and E-DPCCH).

When E-DPDCH channels are present the beta gains on those channels are reduced firsts to try to get the power under the allowed limit. If the beta gains are lowered as far as possible, then a hard limiting is applied at the maximum allowed level.

The SW currently recalculates the cubic metric every time the beta gains on the E-DPDCH are reduced. The cubic metric will likely get lower each time this is done .However, there is no reported reduction of maximum output power in the HSUPA mode since the device also provides a compensation for the power back-off by increasing the gain of TX_AGC in the transceiver (PA) device.

The end effect is that the DUT output power is identical to the case where there is no MPR in the device.

11. TEST RESULTS

11.1. SAR Test Results Summary

11.1.1. Test position and configuration

Head SAR was performed with the device configured in the positions according to IEEE1528, and Body SAR was performed with the device 5mm from the phantom; Body SAR was also performed with the headset attached and without. The overall device length and width(13.5cm×6.8cm) are >9cm×5cm, Hotspot mode with a test separation distance of 10mm.

11.1.2. Operation Mode

- According to KDB 447498 D01 v05r01 ,for each exposure position, if the highest 1-g SAR is ≤ 0.8 W/kg, testing for low and high channel is optional.
- Per KDB 865664 D01 v01r01,for each frequency band, if the measured SAR is ≥ 0.8 W/Kg, testing for repeated SAR measurement is required , that the highest measured SAR is only to be tested. When the SAR results are near the limit, the following procedures are required for each device to verify these types of SAR measurement related variation concerns by repeating the highest measured SAR configuration in each frequency band.
 - (1) When the original highest measured SAR is ≥ 0.8 W/Kg, repeat that measurement once.
 - (2) Perform a second repeated measurement only if the ratio of largest to smallest SAR for the original and first repeated measurements is > 1.20 or when the original or repeated measurement is ≥ 1.45 W/Kg.
 - (3) Perform a third repeated measurement only if the original, first and second repeated measurement is ≥ 1.5 W/Kg and ratio of largest to smallest SAR for the original, first and second measurement is ≥ 1.20 .
- Body-worn exposure conditions are intended to voice call operations, therefore GSM voice call mode is selected to be test.
- According to KDB 648474 D04 v01r01,when the reported SAR for a body-worn accessory measured without a headset connected to the handset is ≤ 1.2 W/Kg, SAR testing with a headset connected is not required.
- According to 941225 D06, when the overall device length and width are >9cm×5cm, Hotspot mode with a test separation distance of 10mm. For device with form factors smaller than 9cm×5cm, Hotspot mode with a test separation distance of 5mm. Body SAR was also performed with the headset attached and without.
- According to 248227 D01, SAR is not required for 802.11g channels when the maximum average output power is less than 1/4dB higher than measured on the corresponding 802.11b channels.
- Maximum Scaling SAR in order to calculate the Maximum SAR values to test under the standard Peak Power, Calculation method is as follows:
Maximum Scaling SAR =tested SAR (Max.) \times [GSM standard Peak Power (mw)/ tested Max. Peak Power (mw)]

11.1.3. SAR Test Results Summary

SAR MEASUREMENT								
Ambient Temperature (°C) : 21 ± 2						Relative Humidity (%): 55		
Liquid Temperature (°C) : 21 ± 2						Depth of Liquid (cm):>15		
Product: Mobile Phone								
Test Mode: GSM835 with GMSK modulation								
Configuration			Antenna Position	Frequency		Power Drift (<±5%)	SAR (1g) (W/kg)	Limit (W/kg)
SIM	Position	Status		channel	MHz			
<1>	Left Head	Cheek	Fixed	128	824.2	--	--	--
				190	836.6	-0.02	0.161	1.6
				251	848.8	--	--	--
		Tilted	Fixed	128	824.2	--	--	--
				190	836.6	-0.02	0.154	1.6
				251	848.8	--	--	--
	Right Head	Cheek	Fixed	128	824.2	--	--	--
				190	836.6	-0.10	0.157	1.6
				251	848.8	--	--	--
		Tilted	Fixed	128	824.2	--	--	--
				190	836.6	-0.03	0.162	1.6
				251	848.8	--	--	--
<2>	Right	Tilted	Fixed	190	836.6	0.97	0.157	1.6

Note: when the 1-g SAR is ≤ 0.8 W/kg, testing for low and high channel is optional. refer to KDB 941225.

SAR MEASUREMENT								
Ambient Temperature (°C) : 21 ± 2						Relative Humidity (%): 55		
Liquid Temperature (°C) : 21 ± 2						Depth of Liquid (cm):>15		
Product: Mobile Phone								
Test Mode: GSM835 with GMSK modulation								
Configuration			Antenna Position	Frequency		Power Drift (<±5%)	SAR (1g) (W/kg)	Limit (W/kg)
SIM	Position	Status		channel	MHz			
<1>	Body back	MS	Fixed	128	824.2	--	--	--
				190	836.6	-0.03	0.739	1.6
				251	848.8	--	--	--
	Body Front	MS	Fixed	128	824.2	--	--	--
				190	836.6	-0.01	0.159	1.6
				251	848.8	--	--	--

Note: when the 1-g SAR is ≤ 0.8 W/kg, testing for low and high channel is optional. refer to KDB 941225.

SAR MEASUREMENT								
Ambient Temperature (°C) : 21 ± 2						Relative Humidity (%): 55		
Liquid Temperature (°C) : 21 ± 2						Depth of Liquid (cm):>15		
Product: Mobile Phone								
Test Mode: PCS1900 with GMSK modulation								
Configuration			Antenna Position	Frequency		Power Drift (<±5%)	SAR (1g) (W/kg)	Limit (W/kg)
SIM	Position	Status		channel	MHz			
<1>	Left Head	Cheek	Fixed	512	1850.2	--	--	--
				661	1880.0	-0.05	0.317	1.6
				810	1909.8	--	--	--
		Tilted	Fixed	512	1850.2	--	--	--
				661	1880.0	-0.04	0.222	1.6
				810	1909.8	--	--	--
	Right Head	Cheek	Fixed	512	1850.2	--	--	--
				661	1880.0	-0.02	0.303	1.6
				810	1909.8	--	--	--
		Tilted	Fixed	512	1850.2	--	--	--
				661	1880.0	0.01	0.232	1.6
				810	1909.8	--	--	--
<2>	Left	Cheek	Fixed	661	1880.0	0.35	0.275	1.6

Note: when the 1-g SAR is ≤ 0.8 W/kg, testing for low and high channel is optional. refer to KDB 941225.

SAR MEASUREMENT								
Ambient Temperature (°C) : 21 ± 2						Relative Humidity (%): 55		
Liquid Temperature (°C) : 21 ± 2						Depth of Liquid (cm):>15		
Product: Mobile Phone								
Test Mode: PCS 1900 with GMSK modulation								
Configuration			Antenna Position	Frequency		Power Drift (<±5%)	SAR (1g) (W/kg)	Limit (W/kg)
SIM	Position	Status		channel	MHz			
<1>	Body Back	MS	Fixed	512	1850.2	--	--	--
				661	1880.0	0.02	0.756	1.6
				810	1909.8	--	--	--
	Body front	MS	Fixed	512	1850.2	--	--	--
				661	1880.0	-0.01	0.213	1.6
				810	1909.8	--	--	--

Note: when the 1-g SAR is ≤ 0.8 W/kg, testing for low and high channel is optional. refer to KDB 941225.

SAR MEASUREMENT								
Ambient Temperature (°C) : 21 ± 2						Relative Humidity (%): 55		
Liquid Temperature (°C) : 21 ± 2						Depth of Liquid (cm):>15		
Product: Mobile Phone								
Test Mode: WCDMA Band II with QPSK modulation								
Configuration			Antenna Position	Frequency		Power Drift (<±5%)	SAR (1g) (W/kg)	Limit (W/kg)
SIM	Position	Status		channel	MHz			
<1>	Left Head	Cheek	Fixed	9262	1852.4	--	--	--
				9400	1880	-0.05	0.492	1.6
				9538	1907.6	--	--	--
		Tilted	Fixed	9262	1852.4	--	--	--
				9400	1880	-0.03	0.392	1.6
				9538	1907.6	--	--	--
	Right Head	Cheek	Fixed	9262	1852.4	--	--	--
				9400	1880	0.10	0.573	1.6
				9538	1907.6	--	--	--
		Tilted	Fixed	9262	1852.4	--	--	--
				9400	1880	-0.01	0.407	1.6
				9538	1907.6	--	--	--

Note: when the 1-g SAR is ≤ 0.8 W/kg, testing for low and high channel is optional. refer to KDB 941225.

SAR MEASUREMENT								
Ambient Temperature (°C) : 21 ± 2						Relative Humidity (%): 55		
Liquid Temperature (°C) : 21 ± 2						Depth of Liquid (cm):>15		
Product: Mobile Phone								
Test Mode: WCDMA Band II with QPSK modulation								
Configuration			Antenna Position	Frequency		Power Drift (<±5%)	SAR (1g) (W/kg)	Limit (W/kg)
SIM	Position	Status		channel	MHz			
<1>	Body	RMC (towards grounds)	Fixed	9262	1852.4	-0.09	0.964	1.6
				9400	1880	-0.03	1.130	1.6
				9538	1907.6	-2.03	1.110	1.6
		RMC (towards phantom)	Fixed	9262	1852.4	--	--	--
				9400	1880	-0.01	0.411	1.6
				9538	1907.6	--	--	--

Note: when the 1-g SAR is ≤ 0.8 W/kg, testing for low and high channel is optional. refer to KDB 941225.

SAR MEASUREMENT								
Ambient Temperature (°C) : 21 ± 2						Relative Humidity (%): 55		
Liquid Temperature (°C) : 21 ± 2						Depth of Liquid (cm):>15		
Product: Mobile Phone								
Test Mode: WCDMA Band V with QPSK modulation								
Configuration			Antenna Position	Frequency		Power Drift (<±5%)	SAR (1g) (W/kg)	Limit (W/kg)
SIM	Position	Status		channel	MHz			
<1>	Left Head	Cheek	Fixed	4132	826.4	--	--	--
				4182	835.0	-0.05	0.243	1.6
				4233	846.6	--	--	--
		Tilted	Fixed	4132	826.4	--	--	--
				4182	835.0	-0.06	0.254	1.6
				4233	846.6	--	--	--
	Right Head	Cheek	Fixed	4132	826.4	--	--	--
				4182	835.0	-0.02	0.278	1.6
				4233	846.6	--	--	--
		Tilted	Fixed	4132	826.4	--	--	--
				4182	835.0	0.01	0.254	1.6
				4233	846.6	--	--	--

Note: when the 1-g SAR is ≤ 0.8 W/kg, testing for low and high channel is optional. refer to KDB 941225.

SAR MEASUREMENT								
Ambient Temperature (°C) : 21 ± 2						Relative Humidity (%): 55		
Liquid Temperature (°C) : 21 ± 2						Depth of Liquid (cm):>15		
Product: Mobile Phone								
Test Mode: WCDMA Band V with QPSK modulation								
Configuration			Antenna Position	Frequency		Power Drift (<±5%)	SAR (1g) (W/kg)	Limit (W/kg)
SIM	Position	Status		channel	MHz			
<1>	Body	RMC (towards grounds)	Fixed	4132	826.4	-0.59	1.191	1.6
				4182	835.0	-0.03	1.276	1.6
				4233	846.6	-1.67	1.243	1.6
		RMC (towards phantom)	Fixed	4132	826.4	--	--	--
				4182	835.0	-0.01	0.256	1.6
				4233	846.6	--	--	--
		HSPA Earphone (towards grounds)	Fixed	4132	826.4	-0.34	1.113	1.6
				4182	835.0	-0.02	1.172	1.6
				4233	846.6	1.96	1.382	1.6

Note: when the 1-g SAR is ≤ 0.8 W/kg, testing for low and high channel is optional. refer to KDB 941225.

Repeated SAR<1>								
Ambient Temperature (°C) : 21 ± 2						Relative Humidity (%): 55		
Liquid Temperature (°C) : 21 ± 2						Depth of Liquid (cm):>15		
Product: Mobile Phone								
Test Mode: GSM835 with GMSK modulation								
Configuration			Antenna Position	Frequency		Power Drift (<±5%)	SAR (1g) (W/kg)	Limit (W/kg)
SIM	Position	Status		channel	MHz			
<1>	Body back	MS	Fixed	128	824.2	--	--	--
				190	836.6	0.84	0.721	1.6
				251	848.8	--	--	--

Repeated SAR<1>								
Ambient Temperature (°C) : 21 ± 2						Relative Humidity (%): 55		
Liquid Temperature (°C) : 21 ± 2						Depth of Liquid (cm):>15		
Product: Mobile Phone								
Test Mode: PCS 1900 with GMSK modulation								
Configuration			Antenna Position	Frequency		Power Drift (<±5%)	SAR (1g) (W/kg)	Limit (W/kg)
SIM	Position	Status		channel	MHz			
<1>	Body Back	MS	Fixed	512	1850.2	--	--	--
				661	1880.0	1.24	0.734	1.6
				810	1909.8	--	--	--

Repeated SAR<1>								
Ambient Temperature (°C) : 21 ± 2						Relative Humidity (%): 55		
Liquid Temperature (°C) : 21 ± 2						Depth of Liquid (cm):>15		
Product: Mobile Phone								
Test Mode: WCDMA Band II with QPSK modulation								
Configuration			Antenna Position	Frequency		Power Drift (<±5%)	SAR (1g) (W/kg)	Limit (W/kg)
SIM	Position	Status		channel	MHz			
<1>	Body	RMC (towards grounds)	Fixed	9262	1852.4	-0.57	0.820	1.6
				9400	1880	-0.79	1.008	1.6
				9538	1907.6	1.36	0.945	1.6

Repeated SAR<1>								
Ambient Temperature (°C) : 21 ± 2						Relative Humidity (%): 55		
Liquid Temperature (°C) : 21 ± 2						Depth of Liquid (cm):>15		
Product: Mobile Phone								
Test Mode: WCDMA Band V with QPSK modulation								
Configuration			Antenna Position	Frequency		Power Drift (<±5%)	SAR (1g) (W/kg)	Limit (W/kg)
SIM	Position	Status		channel	MHz			
<1>	Body	RMC (towards grounds)	Fixed	4132	826.4	0.94	1.058	1.6
				4182	835.0	1.60	1.089	1.6
				4233	846.6	0.04	1.043	1.6

Repeated SAR<2>								
Ambient Temperature (°C) : 21 ± 2						Relative Humidity (%): 55		
Liquid Temperature (°C) : 21 ± 2						Depth of Liquid (cm):>15		
Product: Mobile Phone								
Test Mode: GSM835 with GMSK modulation								
Configuration			Antenna Position	Frequency		Power Drift (<±5%)	SAR (1g) (W/kg)	Limit (W/kg)
SIM	Position	Status		channel	MHz			
<1>	Body back	MS	Fixed	128	824.2	--	--	--
				190	836.6	-0.22	0.672	1.6
				251	848.8	--	--	--

Repeated SAR<2>								
Ambient Temperature (°C) : 21 ± 2						Relative Humidity (%): 55		
Liquid Temperature (°C) : 21 ± 2						Depth of Liquid (cm):>15		
Product: Mobile Phone								
Test Mode: PCS 1900 with GMSK modulation								
Configuration			Antenna Position	Frequency		Power Drift (<±5%)	SAR (1g) (W/kg)	Limit (W/kg)
SIM	Position	Status		channel	MHz			
<1>	Body Back	MS	Fixed	512	1850.2	--	--	--
				661	1880.0	0.02	0.734	1.6
				810	1909.8	--	--	--

Repeated SAR<2>								
Ambient Temperature (°C) : 21 ± 2						Relative Humidity (%): 55		
Liquid Temperature (°C) : 21 ± 2						Depth of Liquid (cm):>15		
Product: Mobile Phone								
Test Mode: WCDMA Band II with QPSK modulation								
Configuration			Antenna Position	Frequency		Power Drift (<±5%)	SAR (1g) (W/kg)	Limit (W/kg)
SIM	Position	Status		channel	MHz			
<1>	Body	RMC (towards grounds)	Fixed	9262	1852.4	0.31	0.806	1.6
				9400	1880	-1.03	0.982	1.6
				9538	1907.6	0.84	0.833	1.6

Repeated SAR<2>								
Ambient Temperature (°C) : 21 ± 2						Relative Humidity (%): 55		
Liquid Temperature (°C) : 21 ± 2						Depth of Liquid (cm):>15		
Product: Mobile Phone								
Test Mode: WCDMA Band V with QPSK modulation								
Configuration			Antenna Position	Frequency		Power Drift (<±5%)	SAR (1g) (W/kg)	Limit (W/kg)
SIM	Position	Status		channel	MHz			
<1>	Body	RMC (towards grounds)	Fixed	4132	826.4	-0.27	0.924	1.6
				4182	835.0	1.39	1.065	1.6
				4233	846.6	0.07	0.881	1.6

SAR MEASUREMENT								
Ambient Temperature (°C) : 21 ± 2						Relative Humidity (%): 55		
Liquid Temperature (°C) : 21 ± 2						Depth of Liquid (cm):>15		
Product: Mobile Phone								
Test Mode: 802.11b								
Configuration			Antenna Position	Frequency		Power Drift (<±5%)	SAR (1g) (W/kg)	Limit (W/kg)
Test Mode	Position	Status		channel	MHz			
802.11b	Left Head	Cheek	Fixed	1	2412	--	--	--
				6	2437	-0.87	0.185	1.6
				11	2462	--	--	--
		Tilted	Fixed	1	2412	--	--	--
				6	2437	-0.52	0.166	1.6
				11	2462	--	--	--
	Right Head	Cheek	Fixed	1	2412	--	--	--
				6	2437	-1.12	0.106	1.6
				11	2462	--	--	--
		Tilted	Fixed	1	2412	--	--	--
				6	2437	0.47	0.067	1.6
				11	2462	--	--	--

Note1: when the 1-g SAR is ≤ 0.8 W/kg, testing for low and high channel is optional.
Note2: IEEE802.11b support DBPSK, DQPSK, CCK modulation mode, IEEE802.11g/n support OFDM, 16-QAM, 64-QAM modulation mode.

SAR MEASUREMENT								
Ambient Temperature (°C) : 21 ± 2						Relative Humidity (%): 55		
Liquid Temperature (°C) : 21 ± 2						Depth of Liquid (cm):>15		
Product: Mobile Phone								
Test Mode: 802.11b								
Configuration			Antenna Position	Frequency		Power Drift (<±5%)	SAR (1g) (W/kg)	Limit (W/kg)
Test Mode	Position	Status		channel	MHz			
802.11b	Body Back	MS	Fixed	1	2412	--	--	--
				6	2437	0.34	0.152	1.6
				11	2462	--	--	--
	Body front	MS	Fixed	1	2412	--	--	--
				6	2437	-0.84	0.114	1.6
				11	2462	--	--	--

Note1: when the 1-g SAR is ≤ 0.8 W/kg, testing for low and high channel is optional.
Note2: IEEE802.11b support DBPSK, DQPSK, CCK modulation mode, IEEE802.11g/n support OFDM, 16-QAM, 64-QAM modulation mode.

SAR MEASUREMENT								
Ambient Temperature (°C) : 21 ± 2						Relative Humidity (%): 55		
Liquid Temperature (°C) : 21 ± 2						Depth of Liquid (cm):>15		
Product: Mobile Phone								
Test Mode: Hotspot								
Configuration			Antenna Position	Frequency		Power Drift (<±5%)	SAR (1g) (W/kg)	Limit (W/kg)
Test Mode	Position	Status		channel	MHz			
Hotspot	Left Head	Cheek	Fixed	1	2412	--	--	--
				6	2437	-0.87	0.174	1.6
				11	2462	--	--	--
		Tilted	Fixed	1	2412	--	--	--
				6	2437	-0.52	0.065	1.6
				11	2462	--	--	--
	Right Head	Cheek	Fixed	1	2412	--	--	--
				6	2437	-1.12	0.062	1.6
				11	2462	--	--	--
		Tilted	Fixed	1	2412	--	--	--
				6	2437	0.47	0.078	1.6
				11	2462	--	--	--

Note1: when the 1-g SAR is ≤ 0.8 W/kg, testing for low and high channel is optional.

SAR MEASUREMENT								
Ambient Temperature (°C) : 21 ± 2						Relative Humidity (%): 55		
Liquid Temperature (°C) : 21 ± 2						Depth of Liquid (cm):>15		
Product: Mobile Phone								
Test Mode: Hotspot								
Configuration			Antenna Position	Frequency		Power Drift (<±5%)	SAR (1g) (W/kg)	Limit (W/kg)
Test Mode	Position	Status		channel	MHz			
Hotspot	Body Back	MS	Fixed	1	2412	--	--	--
				6	2437	0.34	0.133	1.6
				11	2462	--	--	--
	Body front	MS	Fixed	1	2412	--	--	--
				6	2437	-0.84	0.115	1.6
				11	2462	--	--	--

Note1: when the 1-g SAR is ≤ 0.8 W/kg, testing for low and high channel is optional.

Simultaneous Multi-band Transmission Evaluation:
Application Simultaneous Transmission information:

Position	Simultaneous state
Head	1.WWAN(voice)+WLAN 2.4GHz band
	2.WWAN(voice)+Bluetooth
	3.WWAN(voice)+ HOTSPOT 2.4GHz band
Body	4. WWAN(voice)+WLAN 2.4GHz band
	5. WWAN(voice)+Bluetooth
	6.WWAN(voice)+ HOTSPOT 2.4GHz band

NOTE:

1. WLAN and BT share the same antenna, and cannot transmit simultaneously.
2. Simultaneous with every transmitter must be the same test position.
3. Based upon KDB 447498 D01 v05, BT SAR is excluded as below table.
4. Based upon KDB 447498 D01 v05,for handsets the test separation distance is determined by the smallest distance between the outer surface of the device and the user; which is 0mm for head SAR AND 5mm for body-worn SAR.
5. If the test separation distance is <5mm, 5mm is used for excluded SAR calculation.
6. For minimum test separation distance $\leq 50\text{mm}$,Bluetooth standalone SAR is excluded according to $[(\text{max. power of channel, including tune-up tolerance, mW}) / (\text{min. test separation distance, mm}) \cdot \sqrt{f \text{ (GHz)}} / x] \leq 3.0$ for 1-g SAR and ≤ 7.5 for 10-g extremity SAR
7. KDB 447498 / 4.3.2 (2) when standalone SAR test exclusion applies to an antenna that transmits simultaneously with other antennas, the standalone SAR must be estimated according to following to determine simultaneous transmission SAR test exclusion:
 - a) $(\text{max. power of channel, including tune-up tolerance, mW}) / (\text{min. test separation distance, mm}) \cdot \sqrt{f \text{ (GHz)}} / x$ W/kg for test separation distances ≤ 50 mm; Where $x = 7.5$ for 1-g SAR, and $x = 18.75$ for 10-g SAR.
 - b) 0.4W/Kg for 1-g SAR and 1.0W/Kg for 10-g SAR, when the separation distance is >50mm.

		Maximum Average Power		Antenna to user (mm)	SAR exclusion threshold (mW)	SAR testing required (Yes/No)	Head (0mm gap)	Body (5mm gap)
		dBm	mW					
BT	Head	1.21	1.321	5	10	NO	0.0555 W/kg	0.0555 W/kg
	Body			5	10	NO		

Maximum test results (WWAN) with BT and WIFI SAR:

BT: Head (0 cm gap): 0.0555 W/kg and Body (0.5 cm gap): 0.0555 W/kg
WIFI: Head (0 cm gap): 0.185 W/kg and Body (0.5 cm gap): 0.152 W/kg
HOTSPOT: Head (0 cm gap): 0.174 W/kg and Body (10 cm gap): 0.133 W/kg

WIFI

Head					
Conditions (SAR1+SAR2)	Position	Max. SAR1	Max. SAR2	SAR Summation	Limit (W/kg)
GSM835+WIFI (voice)	Right Cheek	0.162	0.067	0.229	1.6
GSM835+WIFI (voice)	Left Cheek	0.161	0.185	0.346	1.6
PCS1900+WIFI (voice)	Left Cheek	0.317	0.185	0.502	1.6
WCDMA Band II +WIFI (voice)	Right Cheek	0.537	0.106	0.643	1.6
WCDMA Band II +WIFI (voice)	Left Cheek	0.492	0.185	0.677	1.6
WCDMA Band V +WIFI (voice)	Right Cheek	0.278	0.106	0.384	1.6
WCDMA Band V +WIFI (voice)	Left Cheek	0.243	0.185	0.428	1.6
Body					
Conditions (SAR1+SAR2)	Position	Max. SAR1	Max. SAR2	SAR Summation	Limit (W/kg)
GSM835+ WIFI (voice)	Body Back (MS)	0.739	0.152	0.891	1.6
PCS1900+ WIFI (voice)	Body Back (MS)	0.756	0.152	0.908	1.6
WCDMA Band II +WIFI (voice)	RMC (towards grounds)	1.130	0.152	1.282	1.6
WCDMA Band V +WIFI (voice)	RMC (towards grounds)	1.276	0.152	1.428	1.6

HOTSPOT

Head					
Conditions (SAR1+SAR2)	Position	Max. SAR1	Max. SAR2	SAR Summation	Limit (W/kg)
GSM835+HOTSPOT (voice)	Right Cheek	0.162	0.078	0.240	1.6
GSM835+HOTSPOT (voice)	Left Cheek	0.161	0.174	0.335	1.6
PCS1900+HOTSPOT (voice)	Left Cheek	0.317	0.174	0.491	1.6
WCDMA Band II +HOTSPOT (voice)	Right Cheek	0.537	0.062	0.599	1.6
WCDMA Band II +HOTSPOT (voice)	Left Cheek	0.492	0.174	0.666	1.6
WCDMA Band V +HOTSPOT (voice)	Right Cheek	0.278	0.062	0.340	1.6
WCDMA Band V +HOTSPOT (voice)	Left Cheek	0.243	0.174	0.417	1.6
Body					
Conditions (SAR1+SAR2)	Position	Max. SAR1	Max. SAR2	SAR Summation	Limit (W/kg)
GSM835+ HOTSPOT (voice)	Body Back (MS)	0.739	0.133	0.872	1.6
PCS1900+ HOTSPOT (voice)	Body Back (MS)	0.756	0.133	0.889	1.6
WCDMA Band II +HOTSPOT (voice)	RMC (towards grounds)	1.130	0.133	1.263	1.6
WCDMA Band V +HOTSPOT (voice)	RMC (towards grounds)	1.276	0.133	1.409	1.6

APPENDIX A. SAR SYSTEM VALIDATION DATA

Test Laboratory: AGC Lab

Date: Dec.06, 2013

System Check Head 835 MHz

DUT: Dipole 900 MHz Type: SID 900

Communication System CW; Communication System Band: D835 (835.0 MHz); Duty Cycle: 1:1; Conv.F=5.30

Frequency: 835 MHz; Medium parameters used: $f = 835$ MHz; $\sigma=0.86$ mho/m; $\epsilon_r = 40.55$; $\rho = 1000$ kg/m³ ;

Phantom section: Flat Section ; Input Power=10dBm

Ambient temperature (°C): 21, Liquid temperature (°C): 21

SATIMO Configuration:

Probe: EP165; Calibrated: 01/31/2013

- Sensor-Surface: 4mm (Mechanical Surface Detection)
- Phantom: Flat Phantom; Type: Elliptical Phantom
- Measurement SW: OpenSAR V4_02_01

Configuration/System Check GSM 835 Head/Area Scan: Measurement grid: dx=8mm,dy=8mm

Configuration/System Check GSM 835 Head/Zoom Scan: Measurement grid: dx=8mm, dy=8mm, dz=5mm

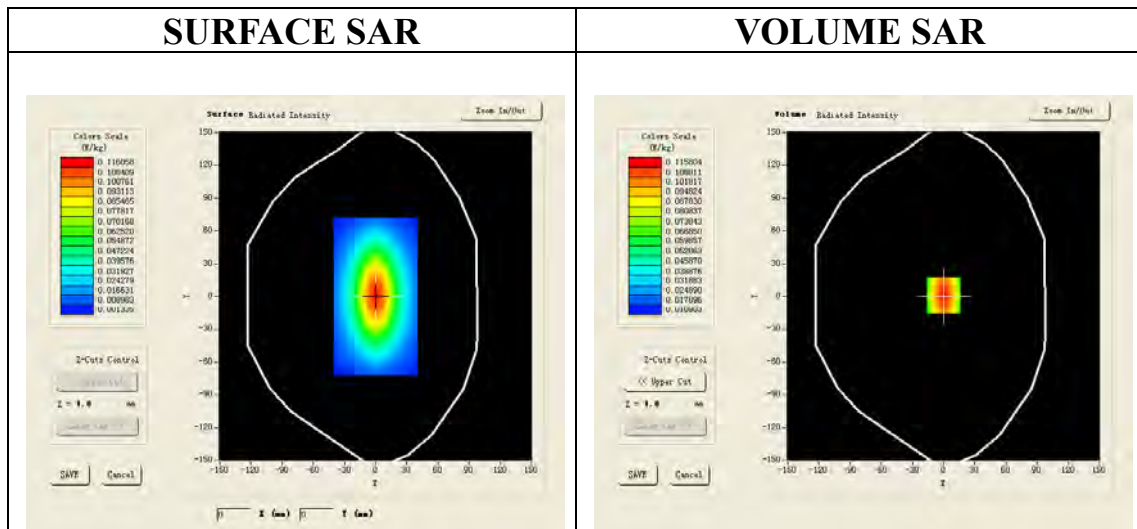

Maximum location: X=0.00, Y=1.00

SAR 10g (W/Kg)	0.068421
SAR 1g (W/Kg)	0.109857

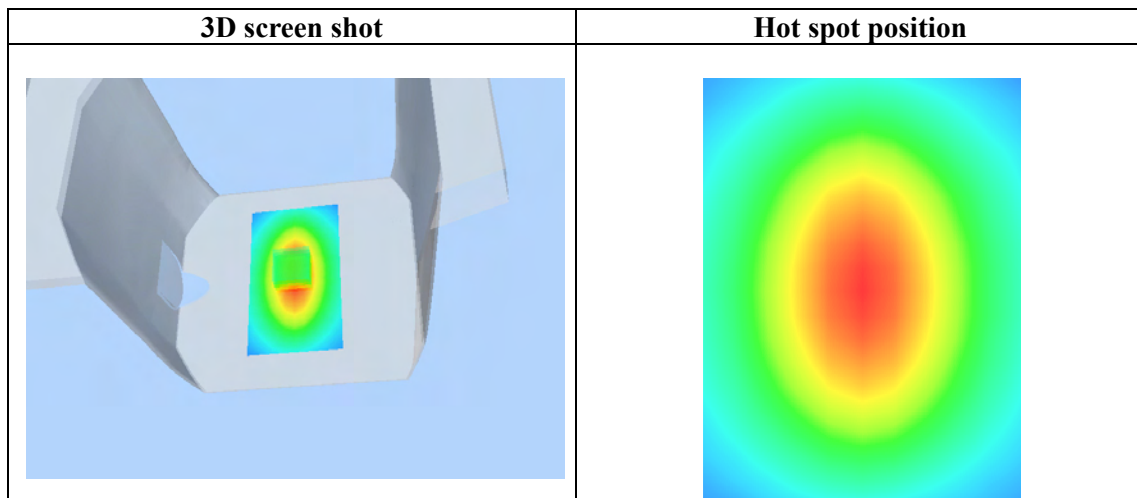
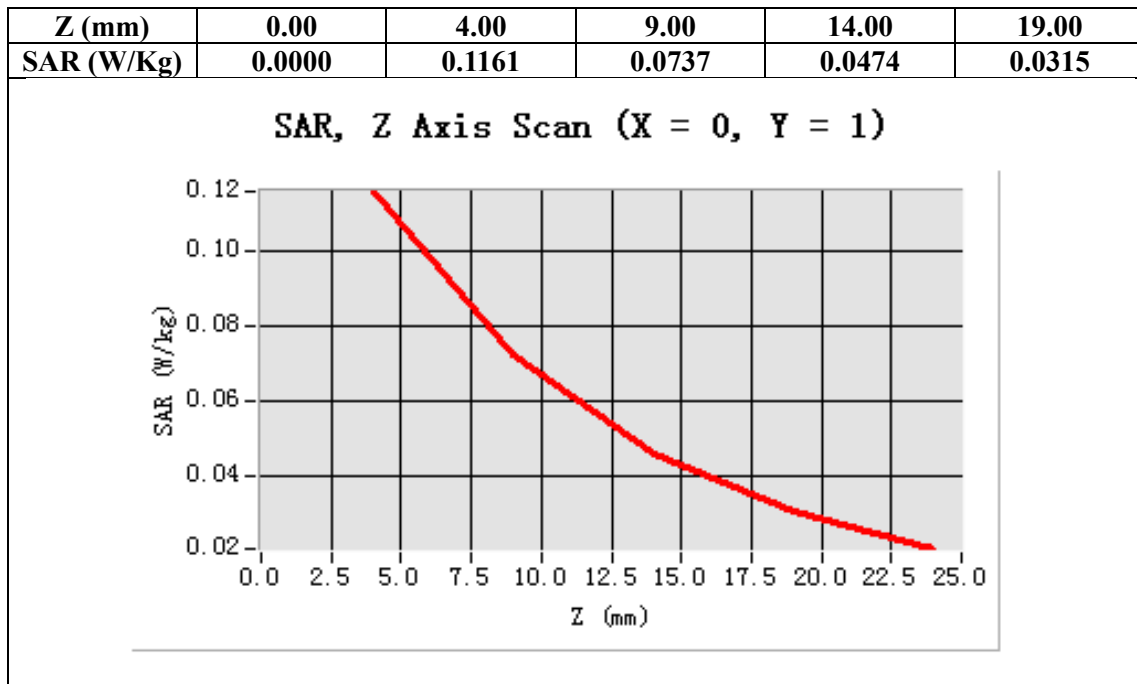

Test Laboratory: AGC Lab
System Check Head 1900MHz

Date: Dec.06, 2013

DUT: Dipole 1900 MHz; Type: SID 1900

Communication System: CW; Communication System Band: D1900 (1900.0 MHz); Duty Cycle:1:1; Conv.F=4.72
Frequency: 1900 MHz; Medium parameters used: $f = 1900$ MHz; $\sigma=1.38$ mho/m; $\epsilon_r=39.97$; $\rho= 1000$ kg/m³ ;
Phantom section: Flat Section ; Input Power=10dBm
Ambient temperature (°C): 21, Liquid temperature (°C): 21

SATIMO Configuration:

Probe: EP165; Calibrated: 01/31/2013

- Sensor-Surface: 4mm (Mechanical Surface Detection)
- Phantom: Flat Phantom; Type: Elliptical Phantom
- Measurement SW: OpenSAR V4_02_01

Configuration/System Check PCS1900 Head/Area Scan: Measurement grid: dx=8mm,dy=8mm
Configuration/System Check PCS1900 Head/Zoom Scan: Measurement grid: dx=8mm, dy=8mm, dz=5mm

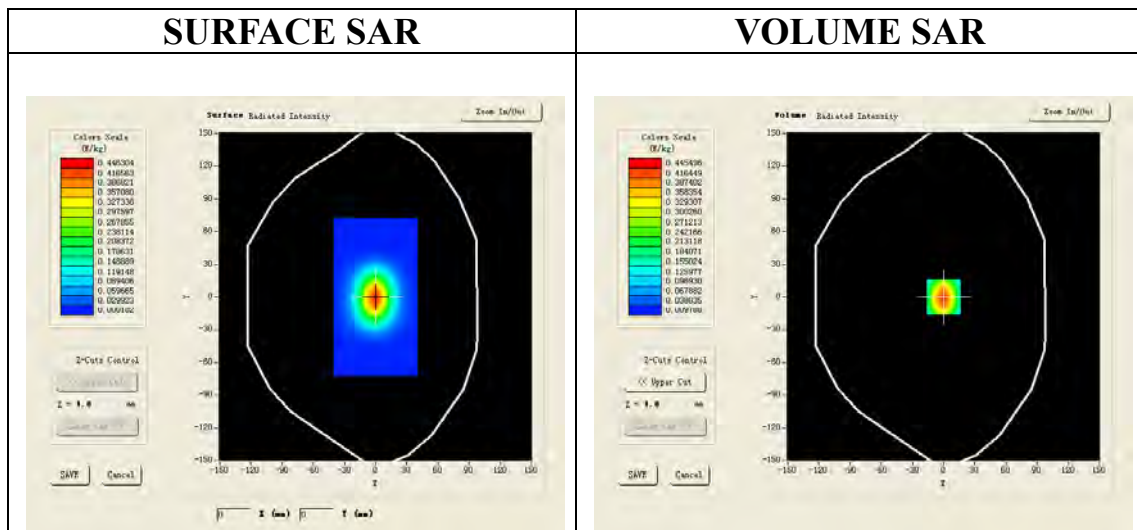

Maximum location: X=0.00, Y=0.00

SAR 10g (W/Kg)	0.209675
SAR 1g (W/Kg)	0.403645

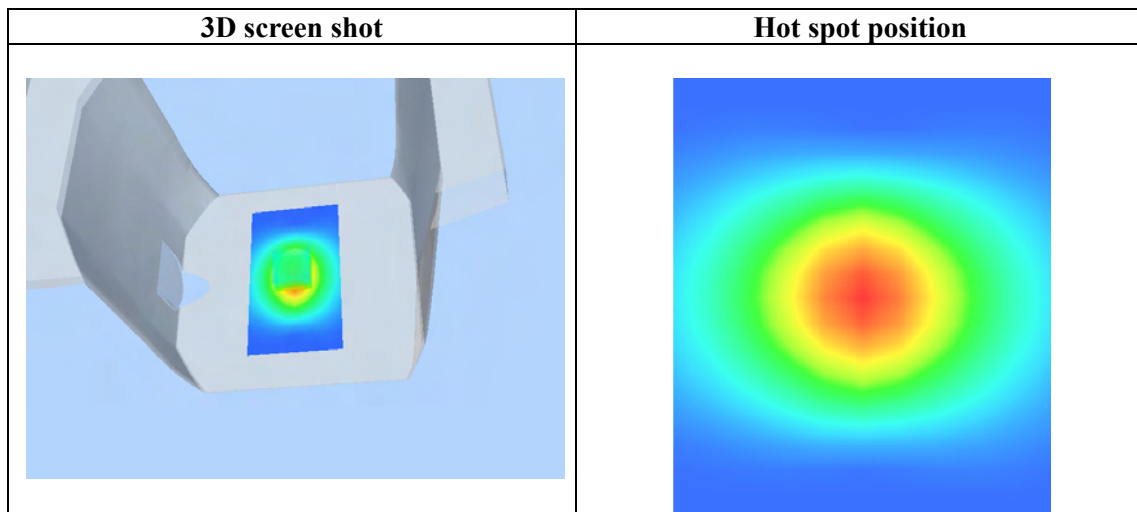
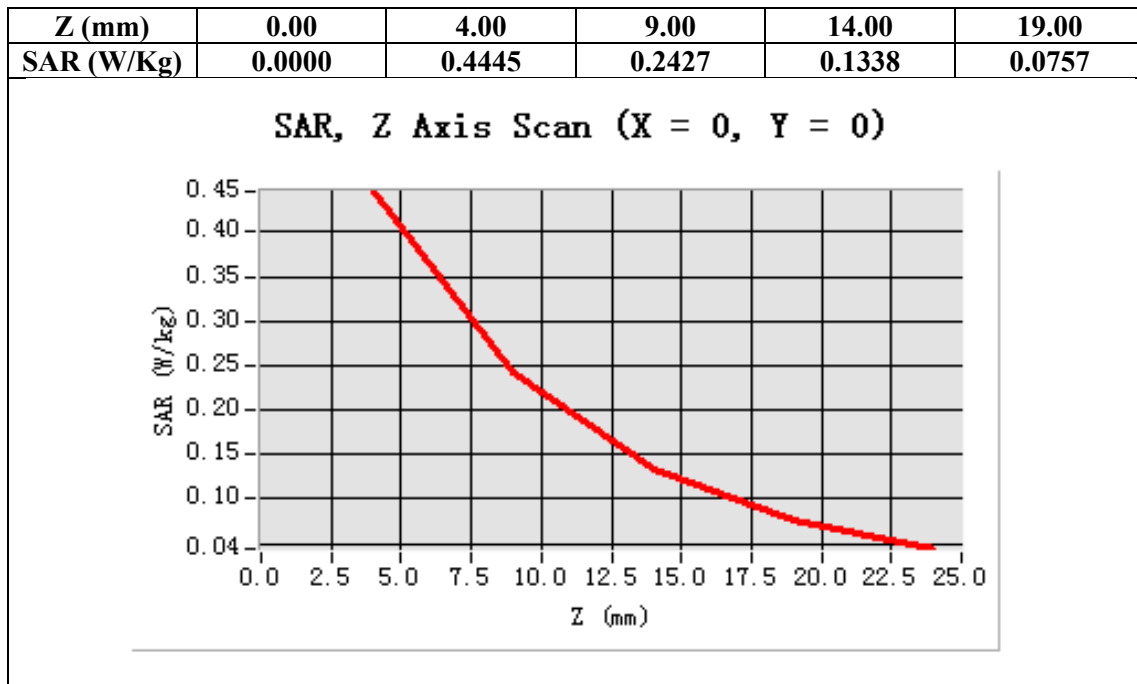

Test Laboratory: AGC Lab
System Check Head 2450 MHz
DUT: Dipole 2450 MHz Type: SID 2450

Date: Dec.06, 2013

Communication System: CW; Communication System Band: D2450 (2450.0 MHz); Duty Cycle: 1:1; Conv.F=4.19
Frequency: 2450 MHz; Medium parameters used: $f = 2450$ MHz; $\sigma = 1.83$ mho/m; $\epsilon_r = 38.56$; $\rho = 1000$ kg/m³ ;
Phantom section: Flat Section; Input Power=10dBm
Ambient temperature (°C): 21, Liquid temperature (°C): 21

SATIMO Configuration:

Probe: EP165; Calibrated: 01/31/2013

- Sensor-Surface: 4mm (Mechanical Surface Detection)
- Phantom: Flat Phantom; Type: Elliptical Phantom
- Measurement SW: OpenSAR V4_02_01

Configuration/System Check 2450 MHz Head/Area Scan: Measurement grid: dx=8mm,dy=8mm
Configuration/System Check 2450 MHz Head/Zoom Scan: Measurement grid: dx=8mm, dy=8mm, dz=5mm

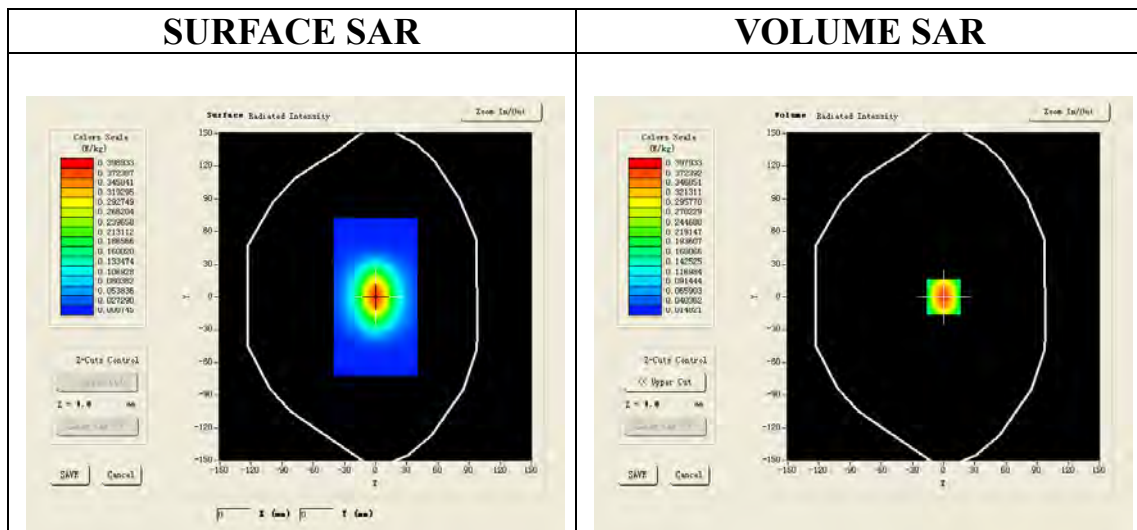

Maximum location: X=0.00, Y=0.00

SAR 10g (W/Kg)	0.225876
SAR 1g (W/Kg)	0.495726

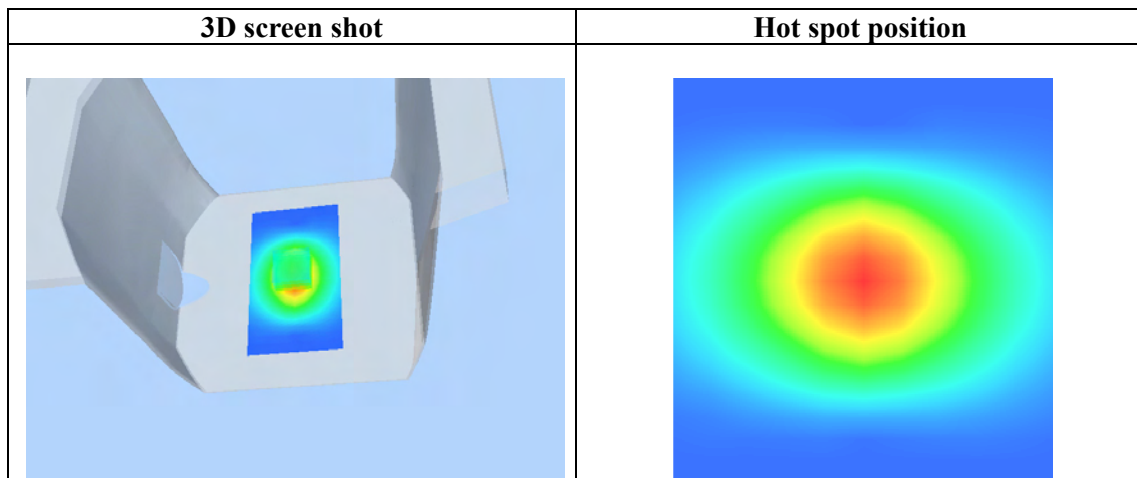
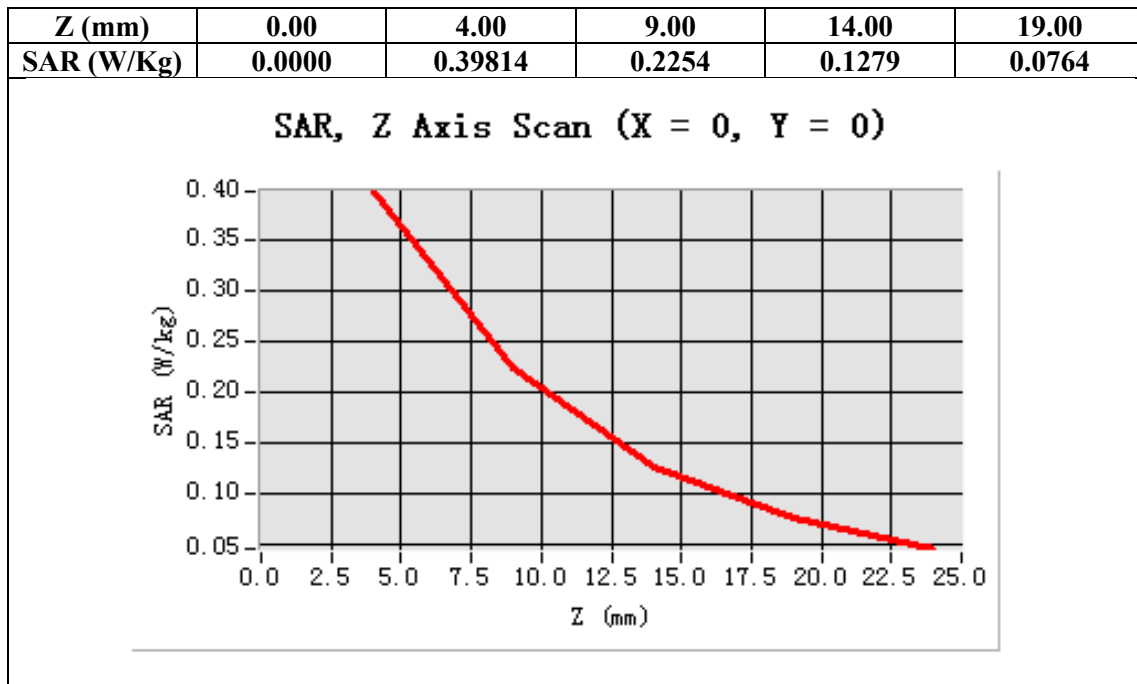

APPENDIX B. SAR MEASUREMENT DATA

Test Laboratory: AGC Lab
GSM 835 Mid-Touch-Left <SIM 1>
DUT: Mobile Phone; Type: Profile

Date: Dec.06, 2013

Communication System: Generic GSM; Communication System Band: GSM 835; Duty Cycle: 1:8.3; Conv.F=5.30
Frequency: 836.6 MHz; Medium parameters used: $f = 835$ MHz; $\sigma=0.86$ mho/m; $\epsilon_r = 40.55$; $\rho = 1000$ kg/m³ ;
Phantom section: Left Section
Ambient temperature (°C): 21.0, Liquid temperature (°C): 21.0

SATIMO Configuration:

Probe: EP165; Calibrated: 01/31/2013

- Sensor-Surface: 4mm (Mechanical Surface Detection)
- Phantom: Flat Phantom; Type: Elliptical Phantom
- Measurement SW: OpenSAR V4_02_01

Configuration/GSM 835 Mid-Touch-Left/Area Scan (6x8x1): Measurement grid: dx=8mm, dy=8mm
Configuration/GSM 835 Mid-Touch-Left/Zoom Scan (5x5x7)/Cube 0: Measurement grid: dx=8mm, dy=8mm, dz=5mm

Area Scan	sam_direct_droit2_surf8mm.txt
ZoomScan	5x5x7,dx=8mm dy=8mm dz=5mm,Very fast
Phantom	Left head
Device Position	Cheek
Band	GSM 835
Channels	Middle
Signal	TDMA (Crest factor: 8.0)

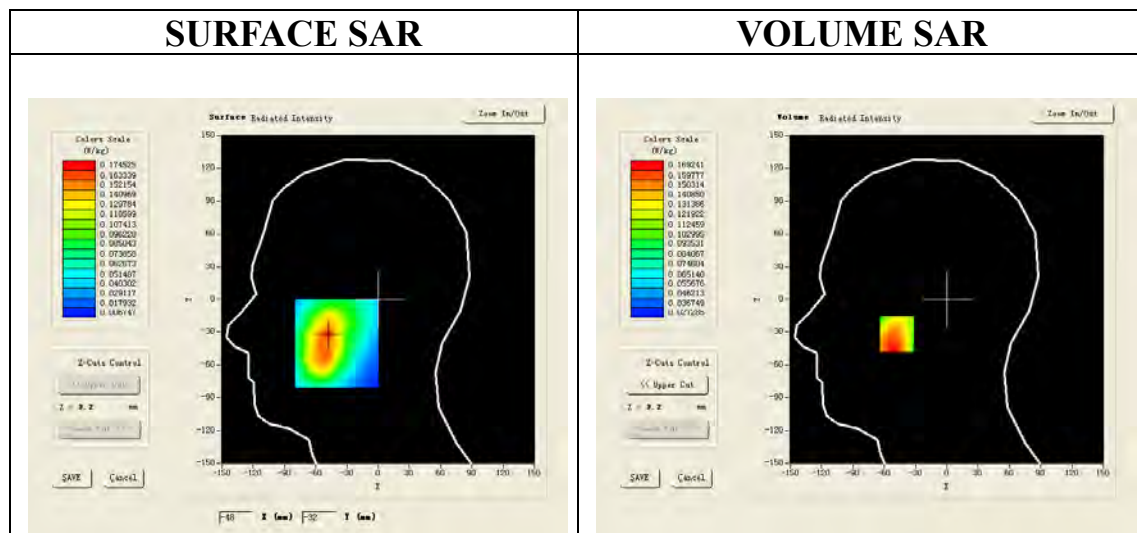

Maximum location: X=-48.00, Y=-32.00

SAR 10g (W/Kg)	0.113440
SAR 1g (W/Kg)	0.161494

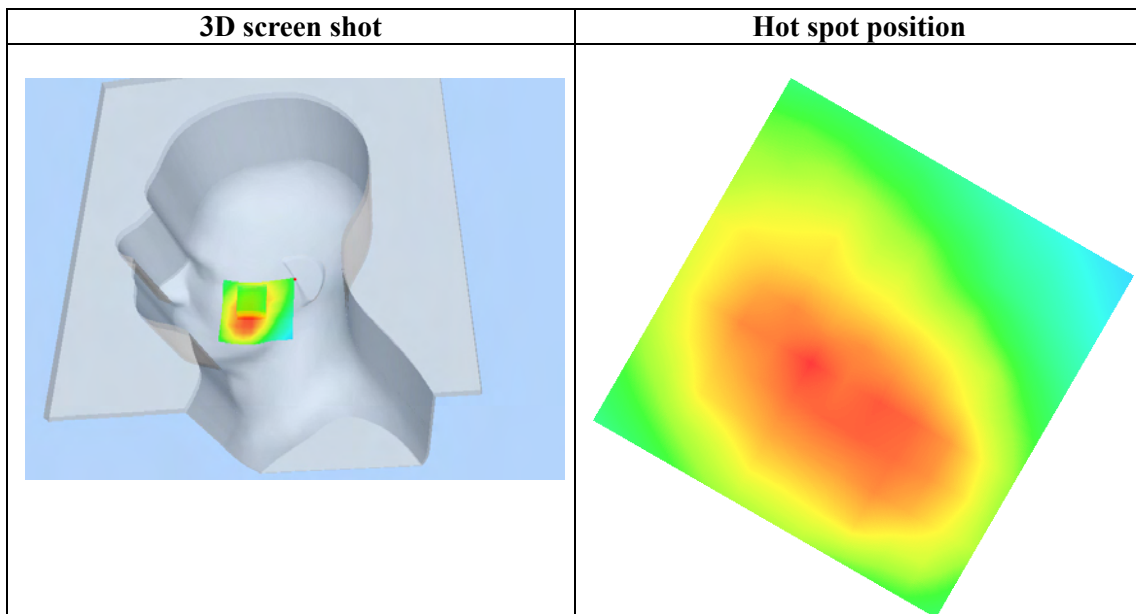
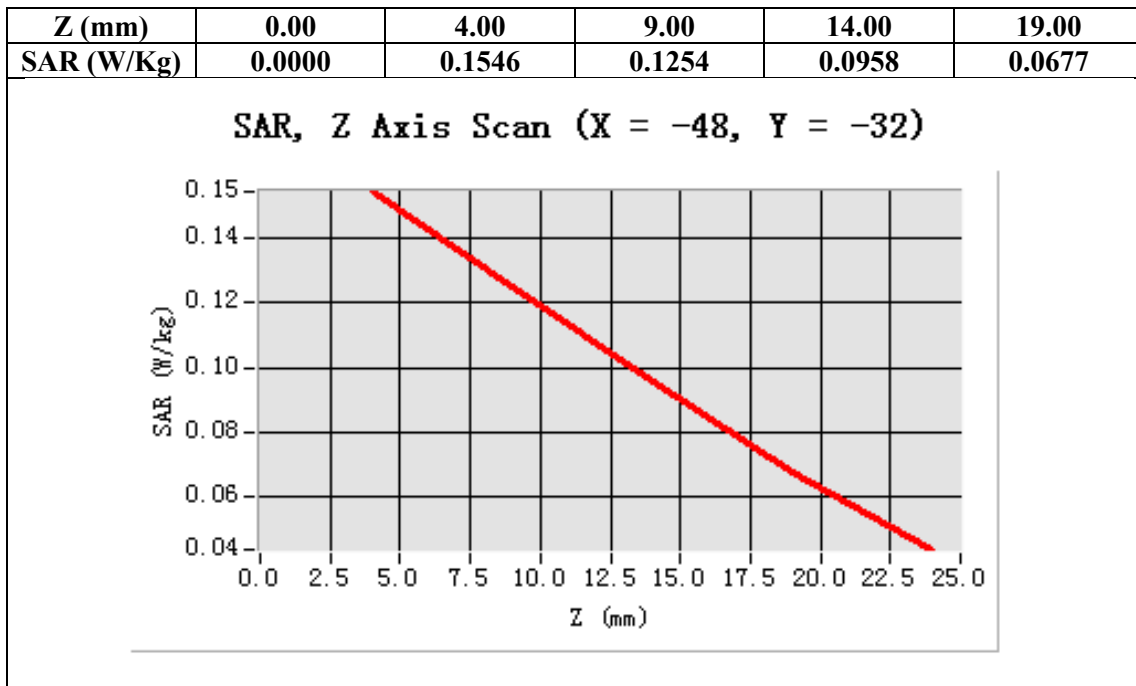

Test Laboratory: AGC Lab
GSM 835 Mid-Tilt-Left <SIM 1>
DUT: Mobile Phone; Type: Profile

Date: Dec.06, 2013

Communication System: Generic GSM; Communication System Band: GSM 835; Duty Cycle: 1:8.3; Conv.F=5.30;
Frequency: 836.6 MHz; Medium parameters used: f = 835 MHz; $\sigma=0.86$ mho/m; $\epsilon_r=40.55$; $\rho= 1000$ kg/m³ ;
Phantom section: Left Section
Ambient temperature (°C): 21.0, Liquid temperature(°C): 21.0

SATIMO Configuration:

Probe: EP165; Calibrated: 01/31/2013

- Sensor-Surface: 4mm (Mechanical Surface Detection)
- Phantom: Flat Phantom; Type: Elliptical Phantom
- Measurement SW: OpenSAR V4_02_01

Configuration/GSM 835 Mid-Tilt-Left/Area Scan (6x8x1): Measurement grid: dx=8mm, dy=8mm
Configuration/GSM 835 Mid-Tilt-Left/Zoom Scan (5x5x7)/Cube 0: Measurement grid: dx=8mm, dy=8mm,dz=5mm;

Area Scan	sam_direct_droit2_surf8mm.txt
ZoomScan	5x5x7,dx=8mm dy=8mm dz=5mm,Very fast
Phantom	Left head
Device Position	Tilt
Band	GSM 835
Channels	Middle
Signal	TDMA (Crest factor: 8.0)

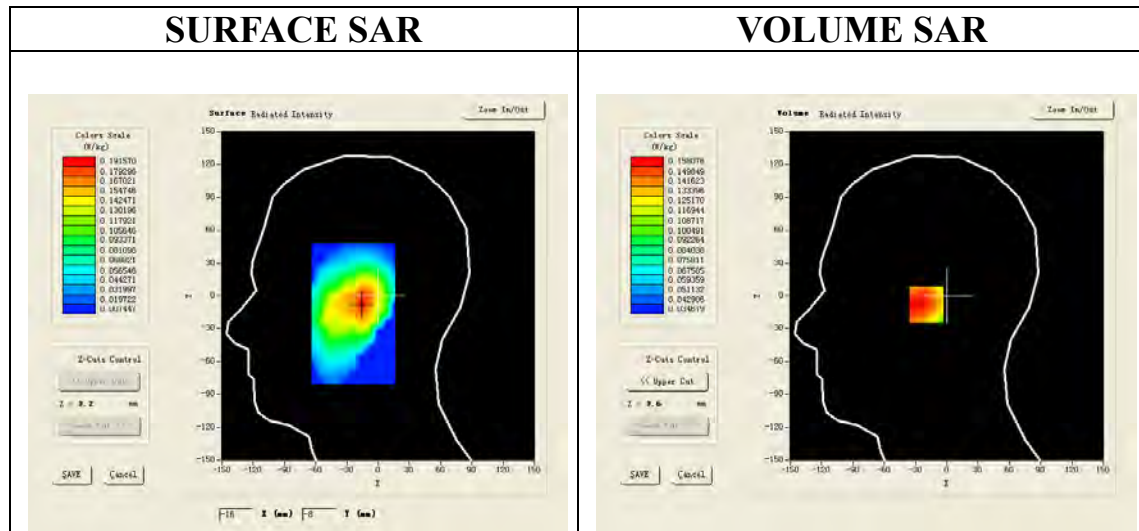

Maximum location: X=-16.00, Y=-8.00

SAR 10g (W/Kg)	0.116268
SAR 1g (W/Kg)	0.153953

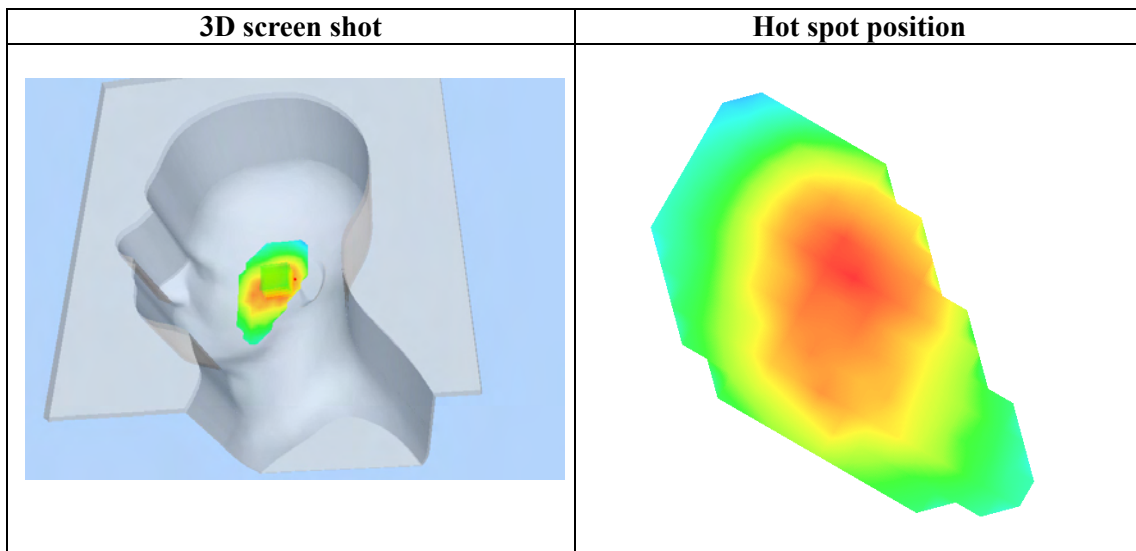
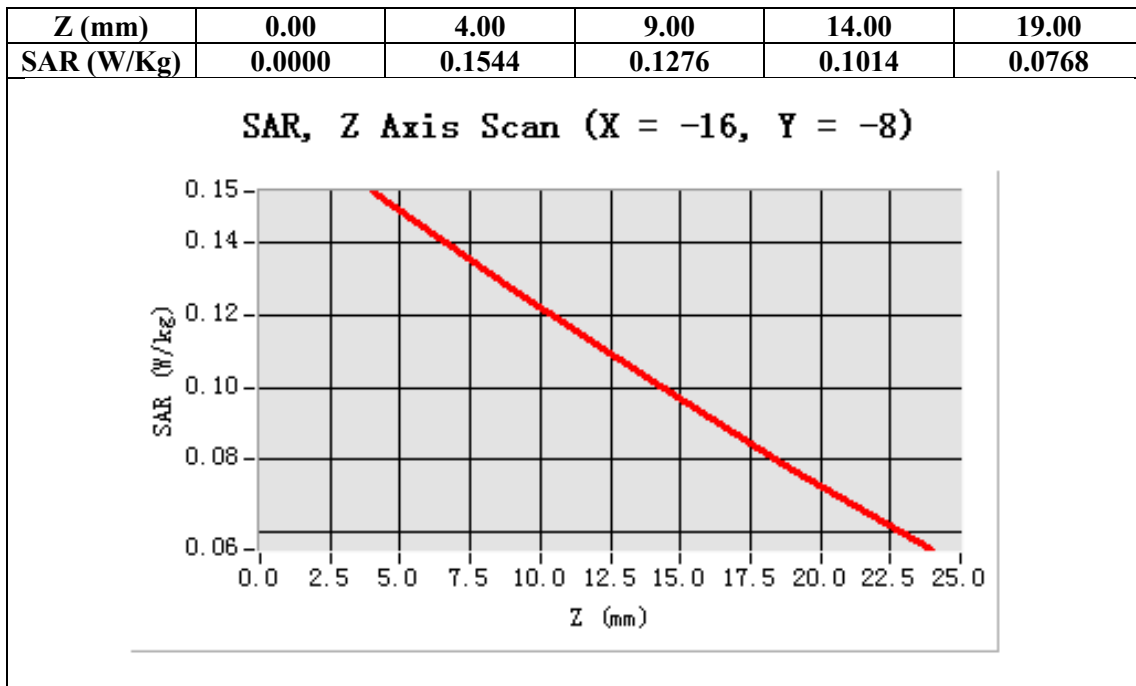

Test Laboratory: AGC Lab
GSM 835 Mid-Touch-Right <SIM 1>
DUT: Mobile Phone; Type: Profile

Date: Dec.06, 2013

Communication System: Generic GSM; Communication System Band: GSM 835; Duty Cycle: 1:8.3; Conv.F=5.30;
Frequency: 836.6 MHz; Medium parameters used: $f = 835$ MHz; $\sigma = 0.86$ mho/m; $\epsilon_r = 40.55$; $\rho = 1000$ kg/m³ ;
Phantom section: Right Section
Ambient temperature (°C): 21.0, Liquid temperature (°C): 21.0

SATIMO Configuration:

Probe: EP165; Calibrated: 01/31/2013

- Sensor-Surface: 4mm (Mechanical Surface Detection)
- Phantom: Flat Phantom; Type: Elliptical Phantom
- Measurement SW: OpenSAR V4_02_01

Configuration/GSM 835 Mid-Touch-Right/Area Scan: Measurement grid: dx=8mm, dy=8mm
Configuration/GSM 835 Mid-Touch-Right/Zoom Scan: Measurement grid: dx=8mm, dy=8mm, dz=5mm;

Area Scan	sam_direct_droit2_surf8mm.txt
ZoomScan	5x5x7,dx=8mm dy=8mm dz=5mm,Very fast
Phantom	Right head
Device Position	Cheek
Band	GSM 835
Channels	Middle
Signal	TDMA (Crest factor: 8.0)

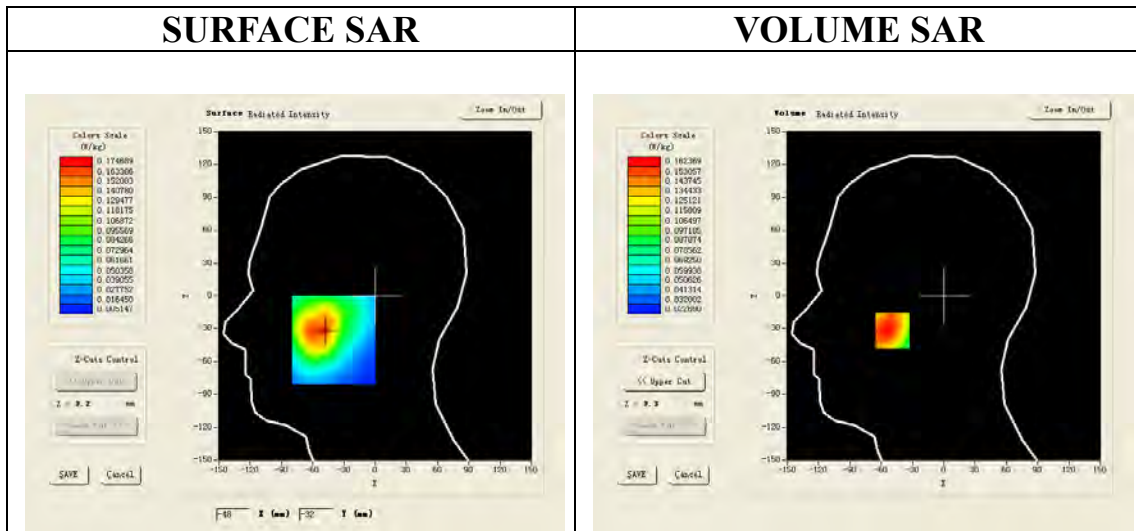

Maximum location: X=-49.00, Y=-32.00

SAR 10g (W/Kg)	0.111224
SAR 1g (W/Kg)	0.157116

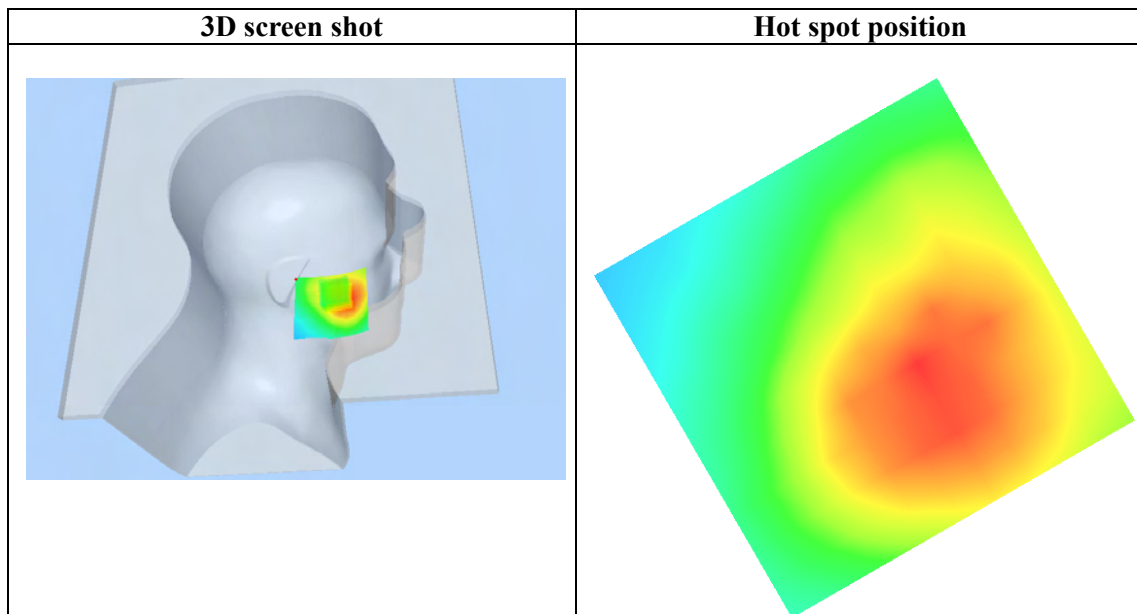
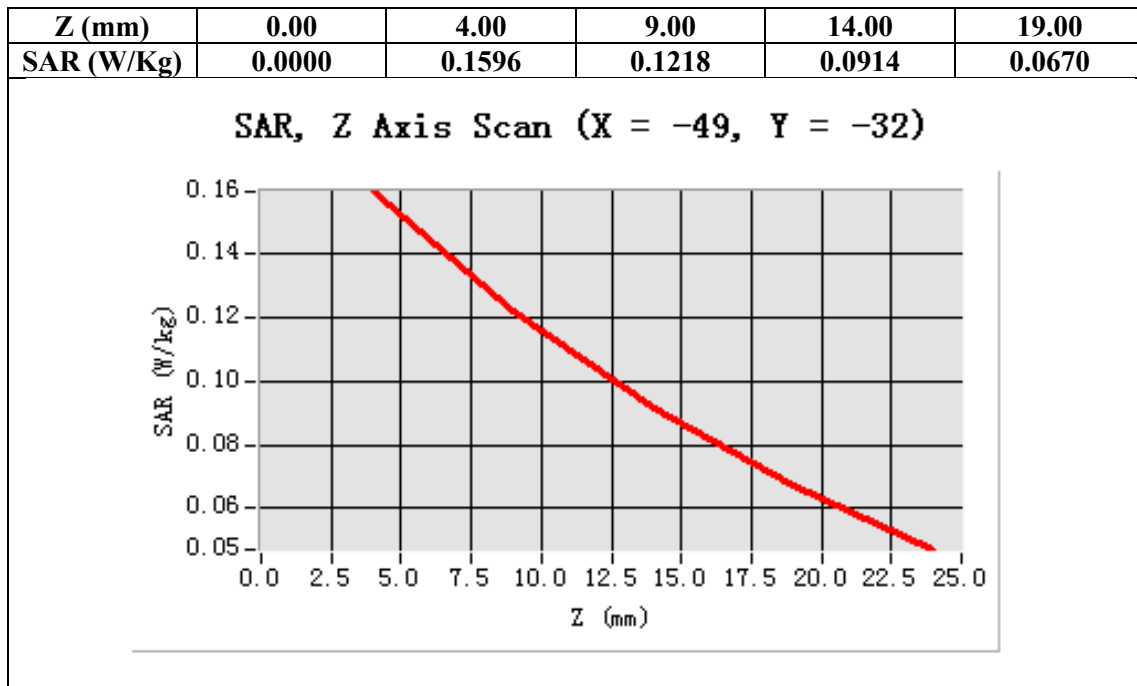

Test Laboratory: AGC Lab
GSM 835 Mid-Tilt-Right <SIM 1>
DUT: Mobile Phone; Type: Profile

Date: Dec.06, 2013

Communication System: Generic GSM; Communication System Band: GSM 835; Duty Cycle: 1:8.3; Conv.F=5.30;
Frequency: 836.6 MHz; Medium parameters used: $f = 835$ MHz; $\sigma = 0.86$ mho/m; $\epsilon_r = 40.55$; $\rho = 1000$ kg/m³ ;
Phantom section: Right Section
Ambient temperature (°C): 21.0, Liquid temperature (°C): 21.0

SATIMO Configuration:

Probe: EP165; Calibrated: 01/31/2013

- Sensor-Surface: 4mm (Mechanical Surface Detection)
- Phantom: Flat Phantom; Type: Elliptical Phantom
- Measurement SW: OpenSAR V4_02_01

Configuration/GSM 835 Mid-Tilt-Right/Area Scan: Measurement grid: dx=8mm, dy=8mm

Configuration/GSM 835 Mid-Tilt-Right/Zoom Scan: Measurement grid: dx=8mm, dy=8mm, dz=5mm;

Area Scan	sam_direct_droit2_surf8mm.txt
Zoom Scan	5x5x7,dx=8mm dy=8mm dz=5mm,Very fast
Phantom	Right head
Device Position	Tilt
Band	GSM 835
Channels	Middle
Signal	TDMA (Crest factor: 8.0)

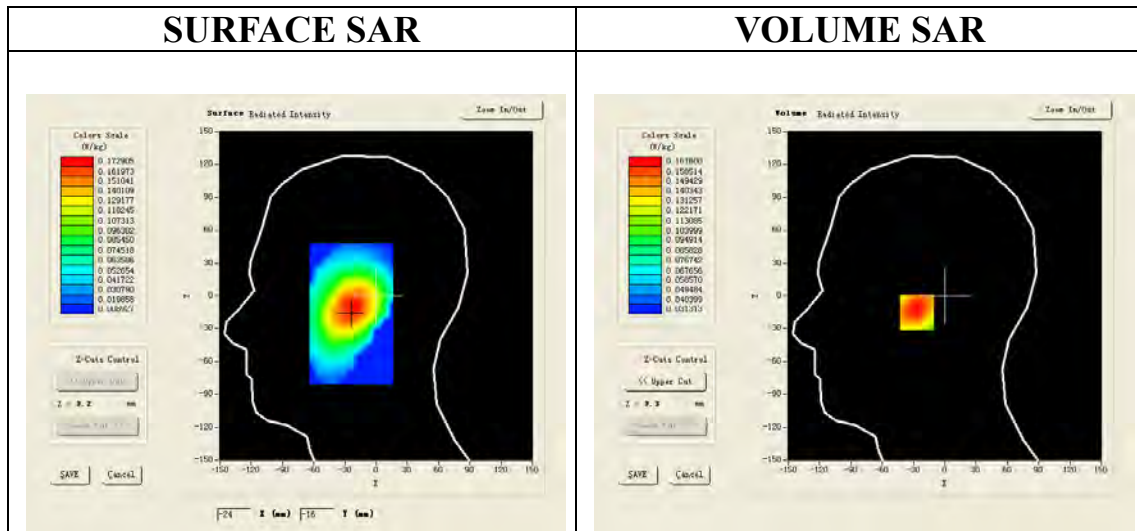

Maximum location: X=-23.00, Y=-15.00

SAR 10g (W/Kg)	0.113026
SAR 1g (W/Kg)	0.161983

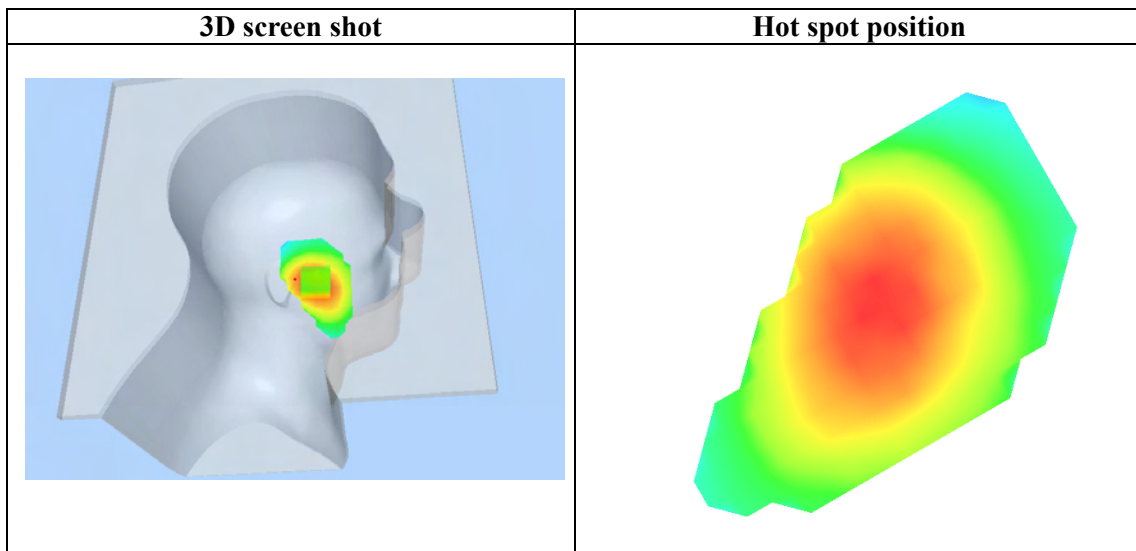
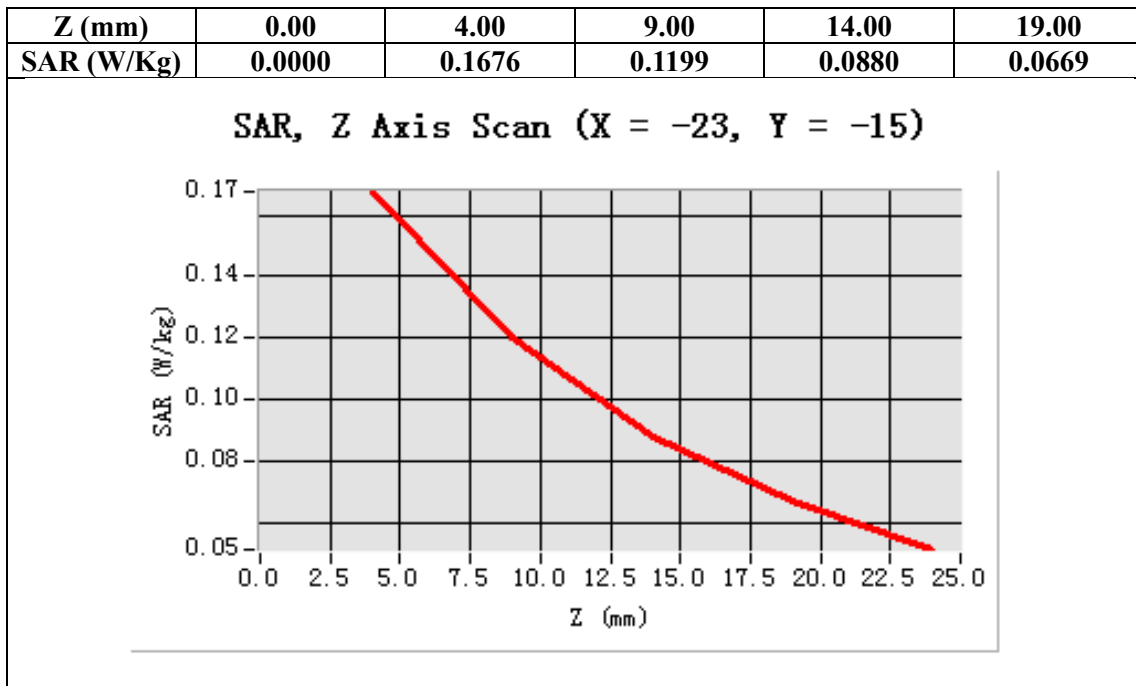

Test Laboratory: AGC Lab
GSM 835 Mid-Tilt-Right <SIM 2>
DUT: Mobile Phone; Type: Profile

Date: Dec.06, 2013

Communication System: Generic GSM; Communication System Band: GSM 835; Duty Cycle: 1:8.3; Conv.F=5.30;
Frequency: 836.6 MHz; Medium parameters used: $f = 835$ MHz; $\sigma = 0.86$ mho/m; $\epsilon_r = 40.55$; $\rho = 1000$ kg/m³ ;
Phantom section: Right Section
Ambient temperature (°C): 21.0, Liquid temperature (°C): 21.0

SATIMO Configuration:

Probe: EP165; Calibrated: 01/31/2013

- Sensor-Surface: 4mm (Mechanical Surface Detection)
- Phantom: Flat Phantom; Type: Elliptical Phantom
- Measurement SW: OpenSAR V4_02_01

Configuration/GSM 835 Mid-Tilt-Right/Area Scan: Measurement grid: dx=8mm, dy=8mm

Configuration/GSM 835 Mid-Tilt-Right/Zoom Scan: Measurement grid: dx=8mm, dy=8mm, dz=5mm;

Area Scan	sam_direct_droit2_surf8mm.txt
Zoom Scan	5x5x7,dx=8mm dy=8mm dz=5mm,Very fast
Phantom	Right head
Device Position	Tilt
Band	GSM 835
Channels	Middle
Signal	TDMA (Crest factor: 8.0)

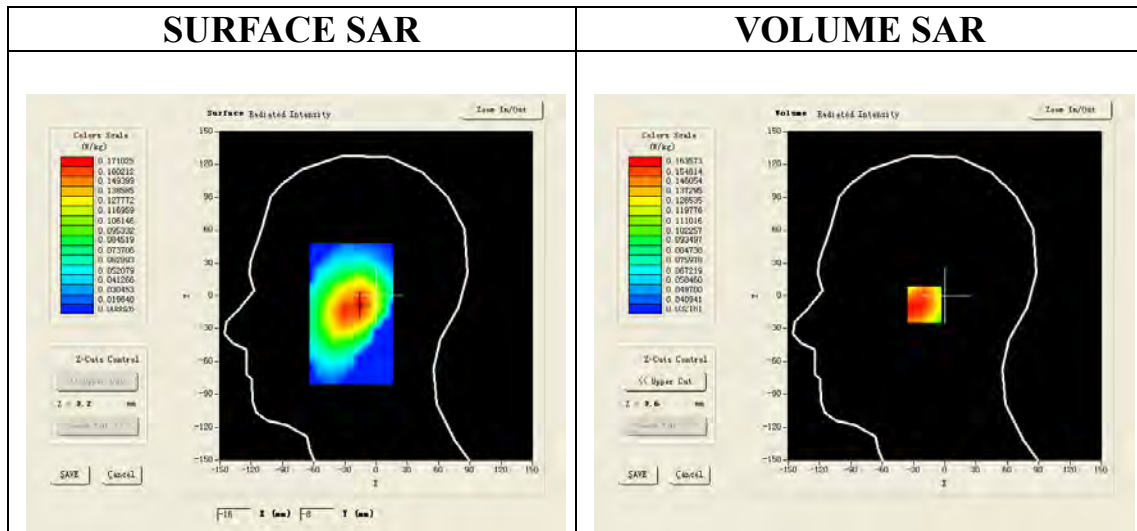

Maximum location: X=-16.00, Y=-8.00

SAR 10g (W/Kg)	0.114247
SAR 1g (W/Kg)	0.157475

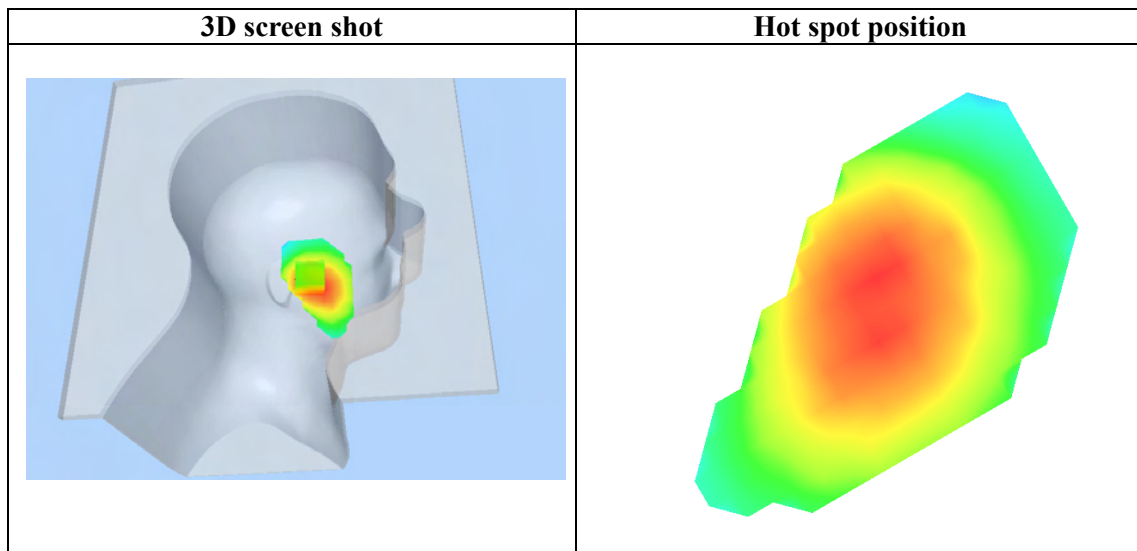
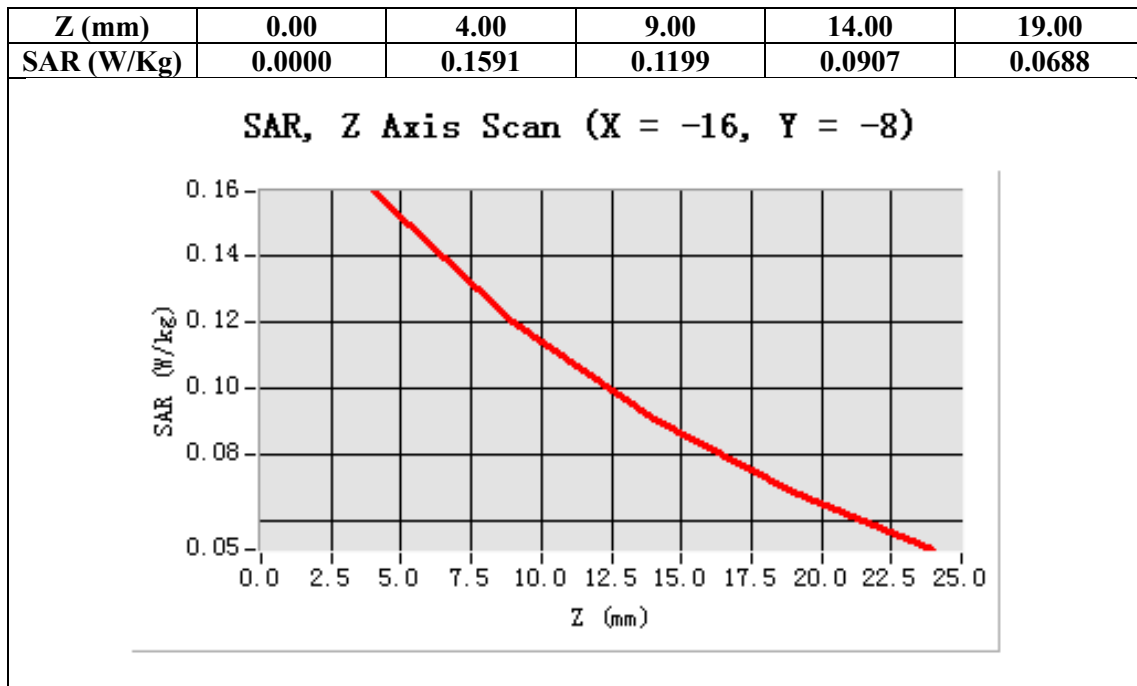

Test Laboratory: AGC Lab
GSM 835 Mid- Body- Back <SIM 1>
DUT: Mobile Phone; Type: Profile

Date: Dec.06, 2013

Communication System: Generic GSM; Communication System Band: GSM 835; Duty Cycle: 1:8.3; Conv.F=5.46;
Frequency: 836.6 MHz; Medium parameters used: $f = 835$ MHz; $\sigma = 0.94$ mho/m; $\epsilon_r = 53.88$; $\rho = 1000$ kg/m³ ;
Phantom section: Flat Section
Ambient temperature (°C): 21.0, Liquid temperature (°C): 21.0

SATIMO Configuration:

Probe: EP165; Calibrated: 01/31/2013

- Sensor-Surface: 4mm (Mechanical Surface Detection)
- Phantom: Flat Phantom; Type: Elliptical Phantom
- Measurement SW: OpenSAR V4_02_01

Configuration/GSM 835 Mid-Body-Back/Area Scan (6x8x1): Measurement grid: dx=8mm, dy=8mm
Configuration/GSM 835 Mid-Body-Back/Zoom Scan (5x5x7)/Cube 0: Measurement grid: dx=8mm, dy=8mm, dz=5mm;

Area Scan	surf_sam_plan.txt
ZoomScan	5x5x7,dx=8mm dy=8mm dz=5mm,Very fast
Phantom	Validation plane
Device Position	Body Back
Band	GSM 835
Channels	Middle
Signal	TDMA (Crest factor: 8.0)

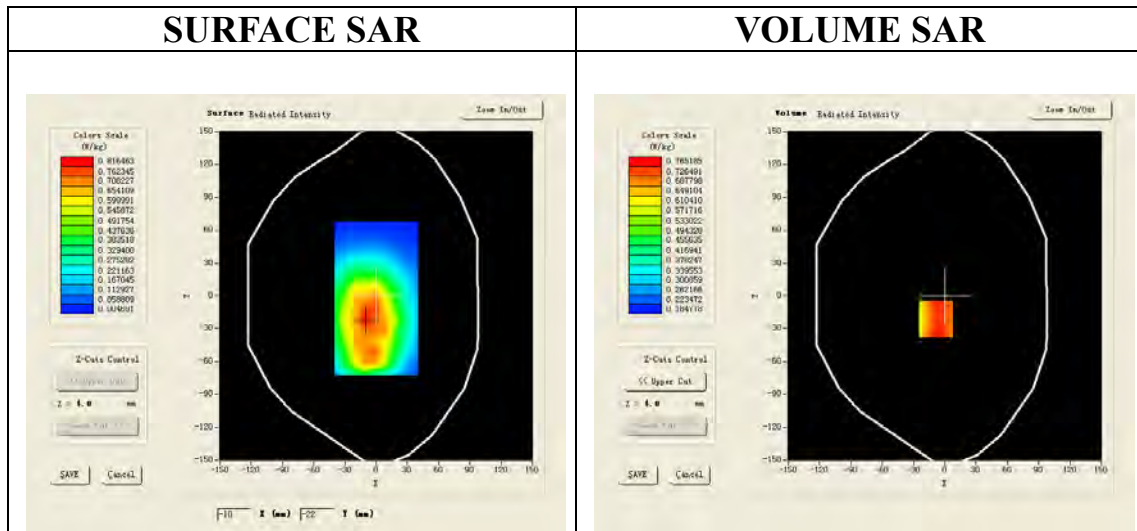

Maximum location: X=-9.00, Y=-21.00

SAR 10g (W/Kg)	0.554478
SAR 1g (W/Kg)	0.739032

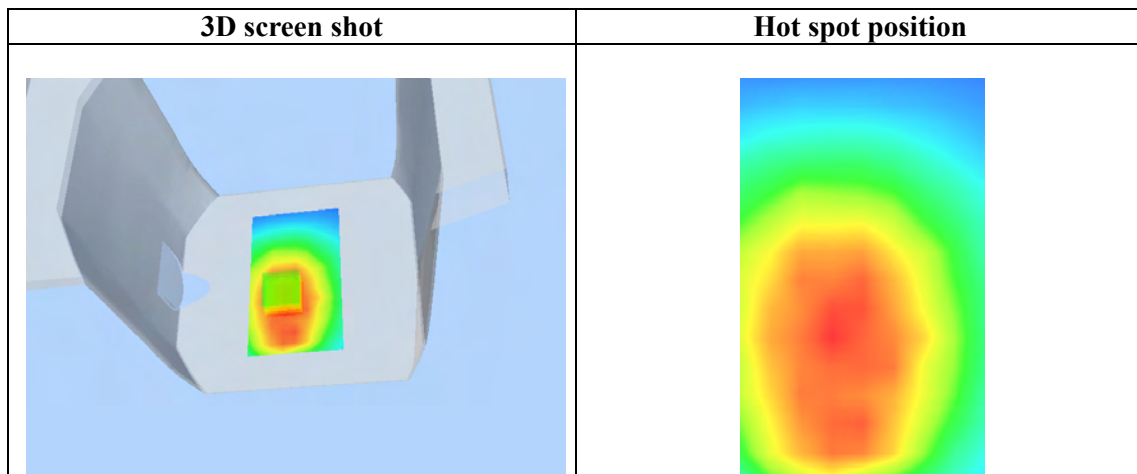
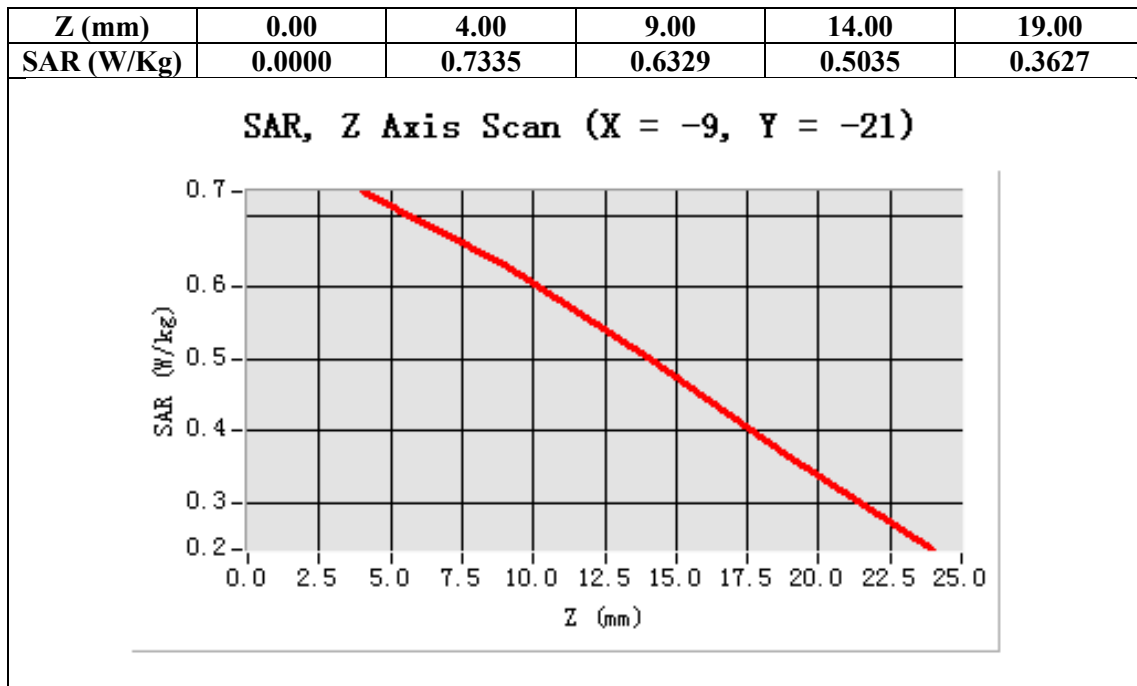

Test Laboratory: AGC Lab
GSM 835 Mid- Body- Front (MS) <SIM 1>
DUT: Mobile Phone; Type: Profile

Date: Dec.06, 2013

Communication System: Generic GSM; Communication System Band: GSM 835; Duty Cycle: 1:8.3; Conv.F=5.46;
Frequency: 836.6 MHz; Medium parameters used: $f = 835$ MHz; $\sigma = 0.94$ mho/m; $\epsilon_r = 53.88$; $\rho = 1000$ kg/m³ ;
Phantom section: Flat Section
Ambient temperature (°C): 21.0, Liquid temperature (°C): 21.0

SATIMO Configuration:

Probe: EP165; Calibrated: 01/31/2013

- Sensor-Surface: 4mm (Mechanical Surface Detection)
- Phantom: Flat Phantom; Type: Elliptical Phantom
- Measurement SW: OpenSAR V4_02_01

Configuration/GSM 835 Mid-Body- Front /Area Scan (6x8x1): Measurement grid: dx=8mm, dy=8mm
Configuration/GSM 835 Mid-Body- Front Zoom Scan (5x5x7)/Cube 0: Measurement grid: dx=8mm, dy=8mm, dz=5mm;

Area Scan	surf_sam_plan.txt
ZoomScan	5x5x7,dx=8mm dy=8mm dz=5mm,Very fast
Phantom	Validation plane
Device Position	Body Front
Band	GSM 835
Channels	Middle
Signal	TDMA (Crest factor: 8.0)

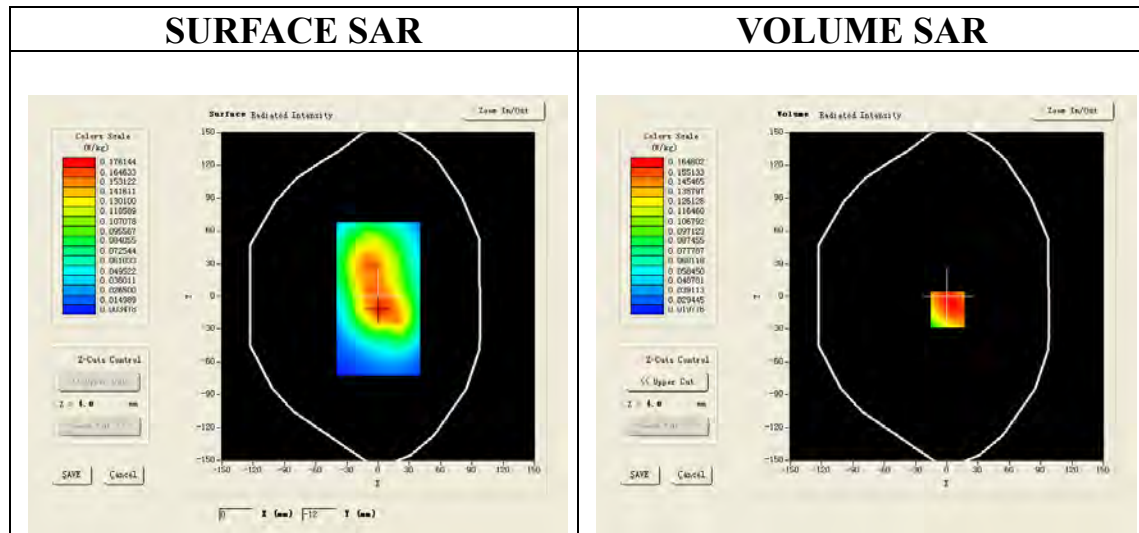

Maximum location: X=1.00, Y=-12.00

SAR 10g (W/Kg)	0.107508
SAR 1g (W/Kg)	0.159184

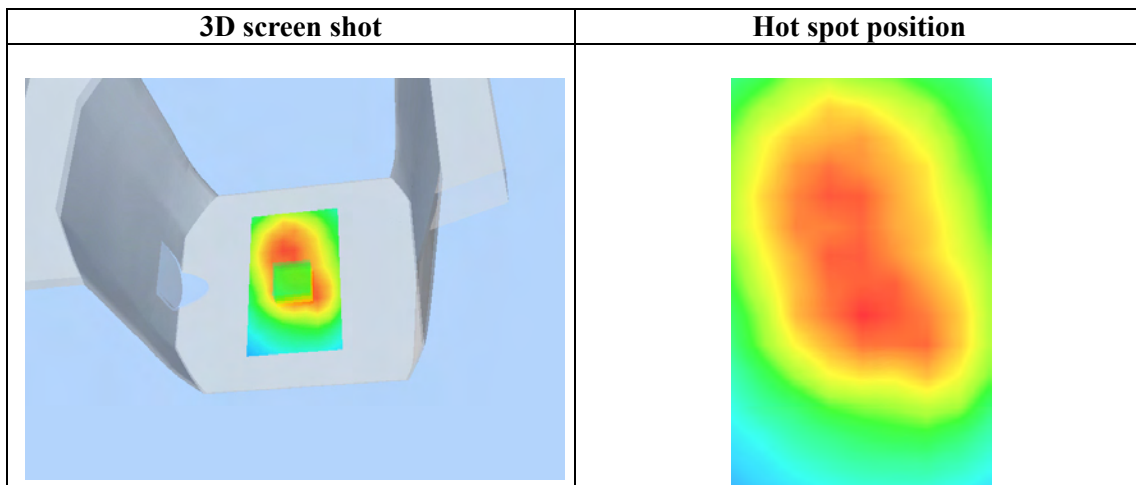
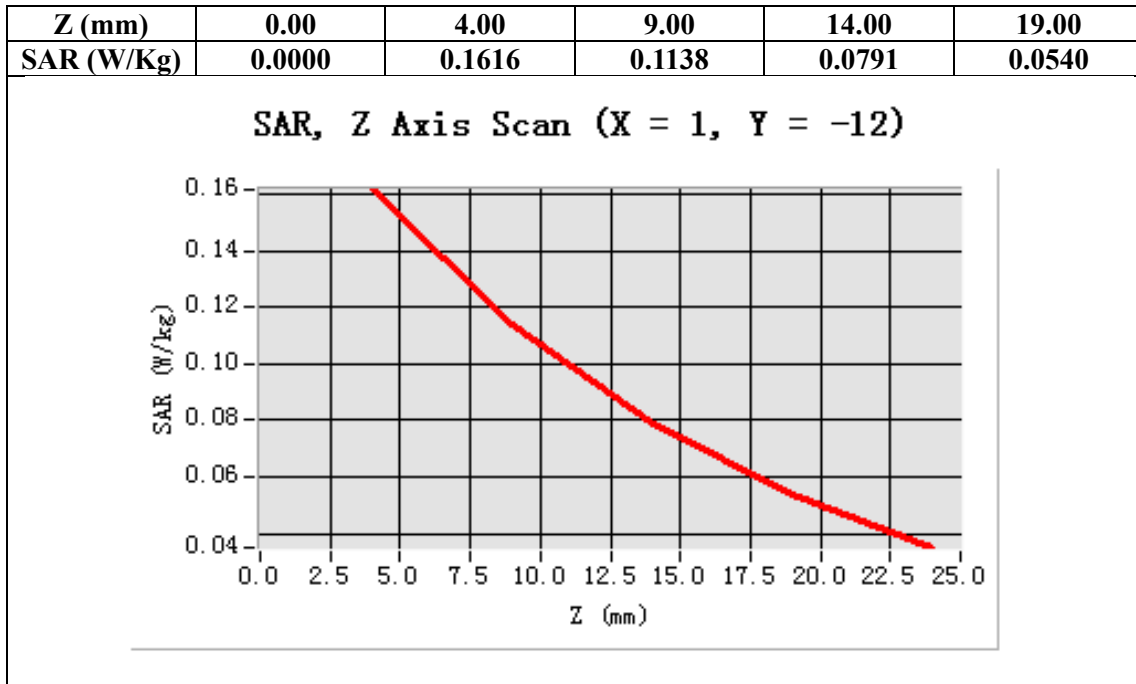

Test Laboratory: AGC Lab
PCS 1900 Mid-Touch-Left <SIM 1>
DUT: Mobile Phone; Type: Profile

Date: Dec.06, 2013

Communication System: Generic GSM; Communication System Band: PCS 1900; Duty Cycle: 1:8.3; Conv.F=4.72;
Frequency: 1880 MHz; Medium parameters used: $f = 1900$ MHz; $\sigma = 1.38$ mho/m; $\epsilon_r = 39.97$; $\rho = 1000$ kg/m³ ;
Phantom section: Left Section
Ambient temperature (°C): 21.0, Liquid temperature (°C): 21.0

SATIMO Configuration:

Probe: EP165; Calibrated: 01/31/2013

- Sensor-Surface: 4mm (Mechanical Surface Detection)
- Phantom: Flat Phantom; Type: Elliptical Phantom
- Measurement SW: OpenSAR V4_02_01

Configuration/PCS1900 Mid-Touch-Left/Area Scan: Measurement grid: dx=8mm, dy=8mm
Configuration/PCS1900 Mid-Touch-Left/Zoom Scan: Measurement grid: dx=8mm, dy=8mm, dz=5mm;

Area Scan	sam_direct_droit2_surf8mm.txt
ZoomScan	5x5x7,dx=8mm dy=8mm dz=5mm,Very fast
Phantom	Left head
Device Position	Cheek
Band	PCS 1900
Channels	Middle
Signal	TDMA (Crest factor: 8.0)

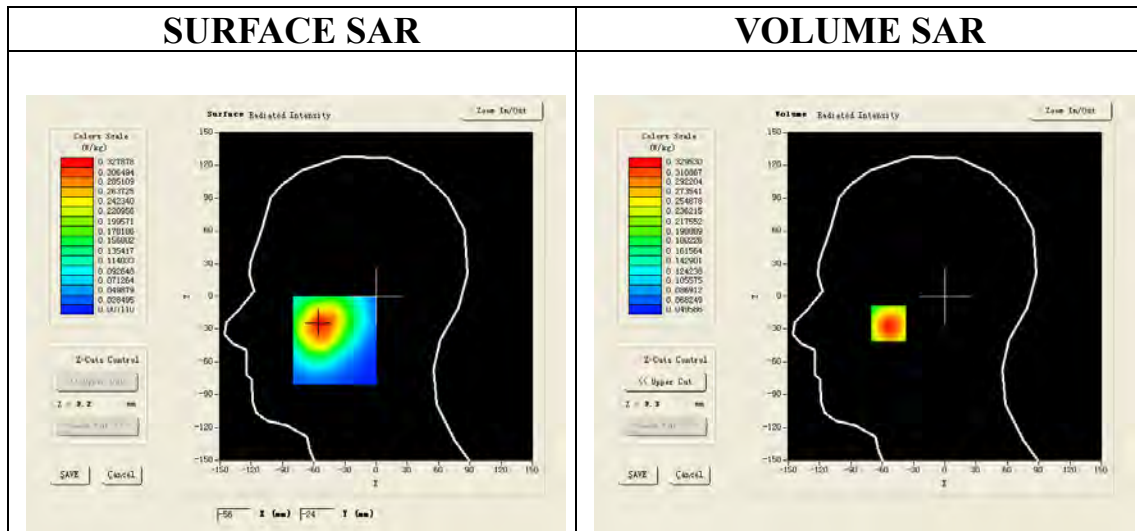

Maximum location: X=-54.00, Y=-25.00

SAR 10g (W/Kg)	0.215829
SAR 1g (W/Kg)	0.316741

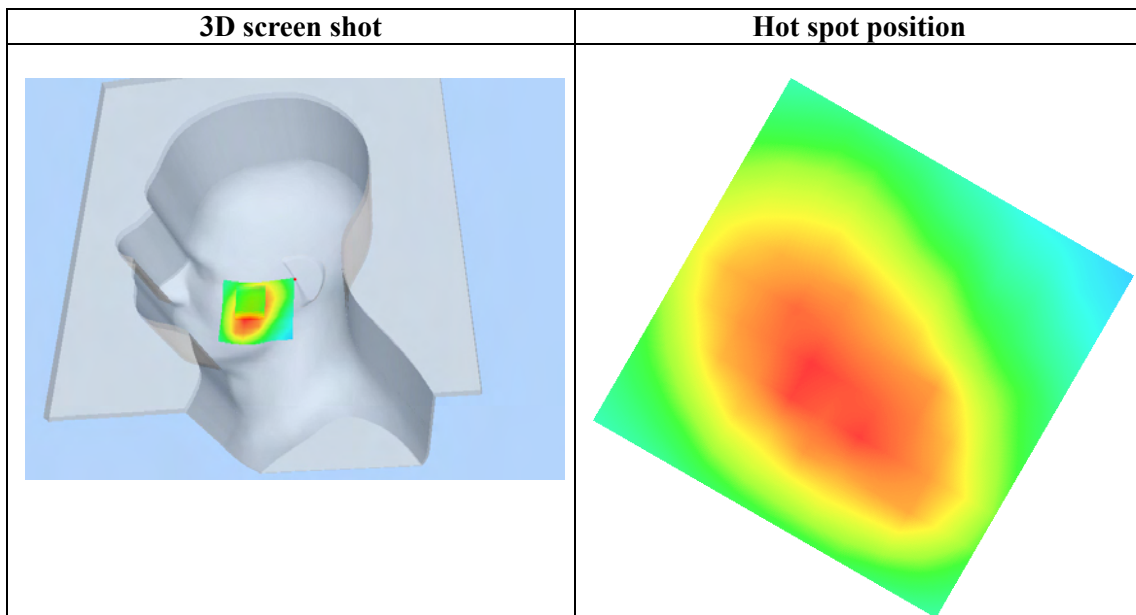
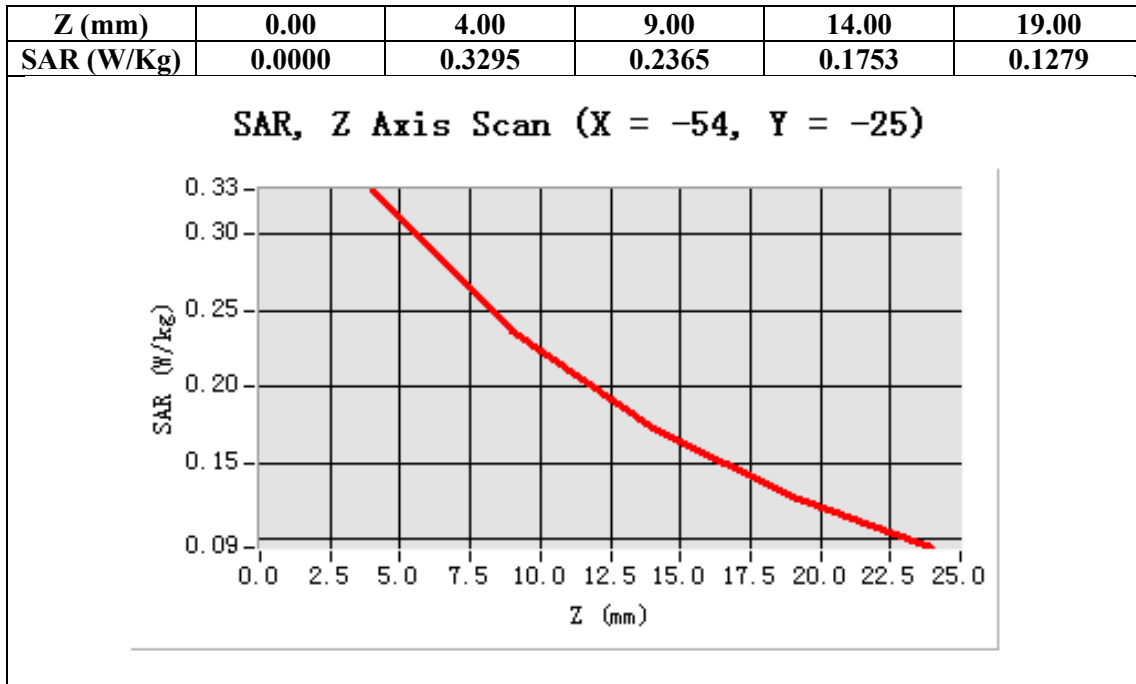

Test Laboratory: AGC Lab
PCS 1900 Mid-Tilt-Left <SIM 1>
DUT: Mobile Phone; Type: Profile

Date: Dec.06, 2013

Communication System: Generic GSM; Communication System Band: PCS 1900; Duty Cycle: 1:8.3; Conv.F=4.72;
Frequency: 1880 MHz; Medium parameters used: $f = 1900$ MHz; $\sigma = 1.38$ mho/m; $\epsilon_r = 39.97$; $\rho = 1000$ kg/m³ ;
Phantom section: Left Section
Ambient temperature (°C): 21.0, Liquid temperature (°C): 21.0

SATIMO Configuration:

Probe: EP165; Calibrated: 01/31/2013

- Sensor-Surface: 4mm (Mechanical Surface Detection)
- Phantom: Flat Phantom; Type: Elliptical Phantom
- Measurement SW: OpenSAR V4_02_01

Configuration/PCS1900 Mid-Tilt-Left/Area Scan: Measurement grid: dx=8mm, dy=8mm
Configuration/PCS1900 Mid-Tilt-Left/Zoom Scan: Measurement grid: dx=8mm, dy=8mm,dz=5mm;

Area Scan	sam_direct_droit2_surf8mm.txt
ZoomScan	5x5x7,dx=8mm dy=8mm dz=5mm,Very fast
Phantom	Left head
Device Position	Tilt
Band	PCS 1900
Channels	Middle
Signal	TDMA (Crest factor: 8.0)

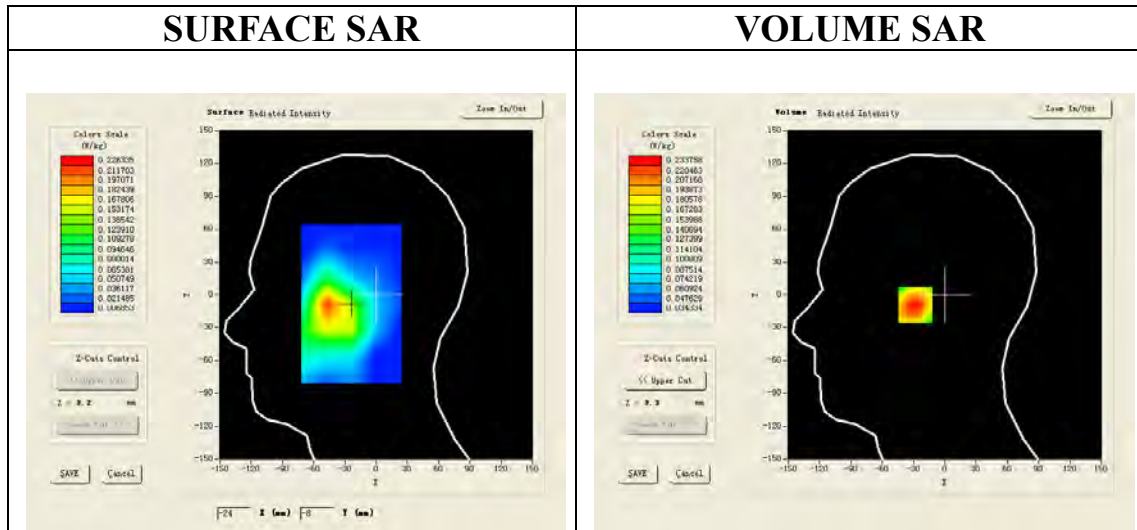

Maximum location: X=-25.00, Y=-9.00

SAR 10g (W/Kg)	0.143975
SAR 1g (W/Kg)	0.221746

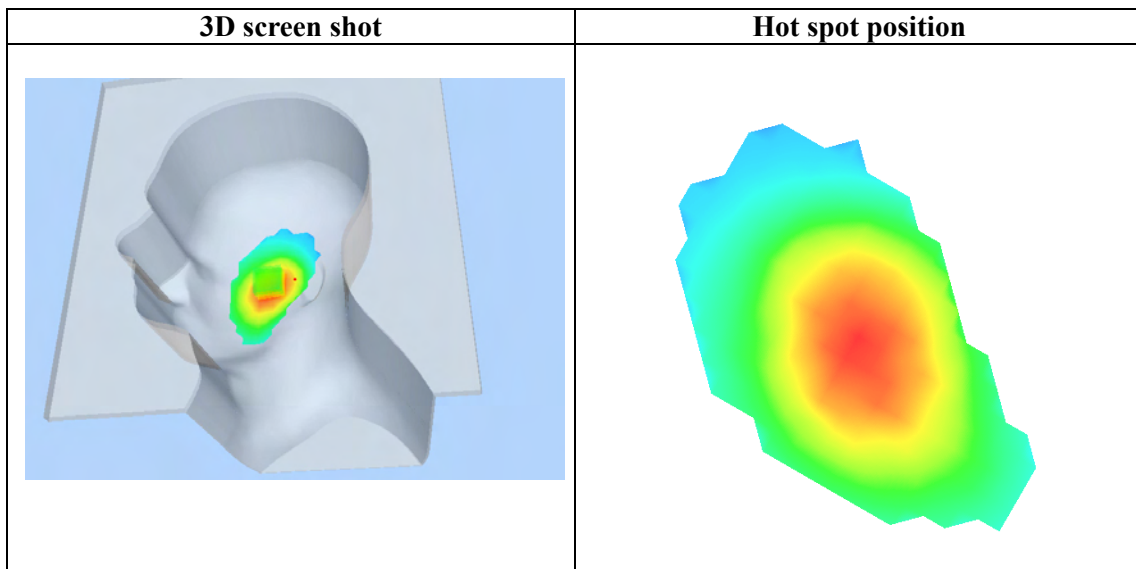
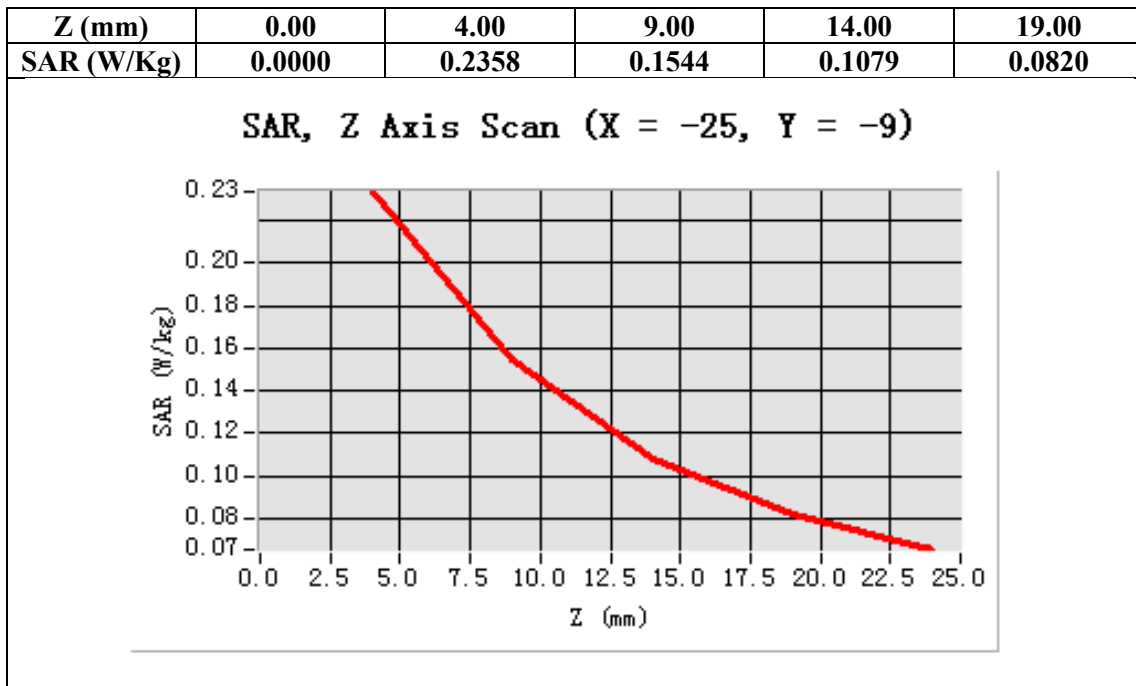

Test Laboratory: AGC Lab
PCS 1900 Mid-Touch-Right <SIM 1>
DUT: Mobile Phone; Type: Profile

Date: Dec.06, 2013

Communication System: Generic GSM; Communication System Band: PCS 1900; Duty Cycle: 1:8.3; Conv.F=4.72;
Frequency: 1880 MHz; Medium parameters used: $f = 1900$ MHz; $\sigma = 1.38$ mho/m; $\epsilon_r = 39.97$; $\rho = 1000$ kg/m³ ;
Phantom section: Right Section
Ambient temperature (°C): 21.0, Liquid temperature (°C): 21.0

SATIMO Configuration:

Probe: EP165; Calibrated: 01/31/2013

- Sensor-Surface: 4mm (Mechanical Surface Detection)
- Phantom: Flat Phantom; Type: Elliptical Phantom
- Measurement SW: OpenSAR V4_02_01

Configuration/PCS1900 Mid-Touch-Right/Area Scan: Measurement grid: dx=8mm, dy=8mm
Configuration/PCS1900 Mid-Touch-Right/Zoom Scan: Measurement grid: dx=8mm, dy=8mm, dz=5mm;

Area Scan	sam_direct_droit2_surf8mm.txt
ZoomScan	5x5x7,dx=8mm dy=8mm dz=5mm,Very fast
Phantom	Right head
Device Position	Cheek
Band	PCS 1900
Channels	Middle
Signal	TDMA (Crest factor: 8.0)

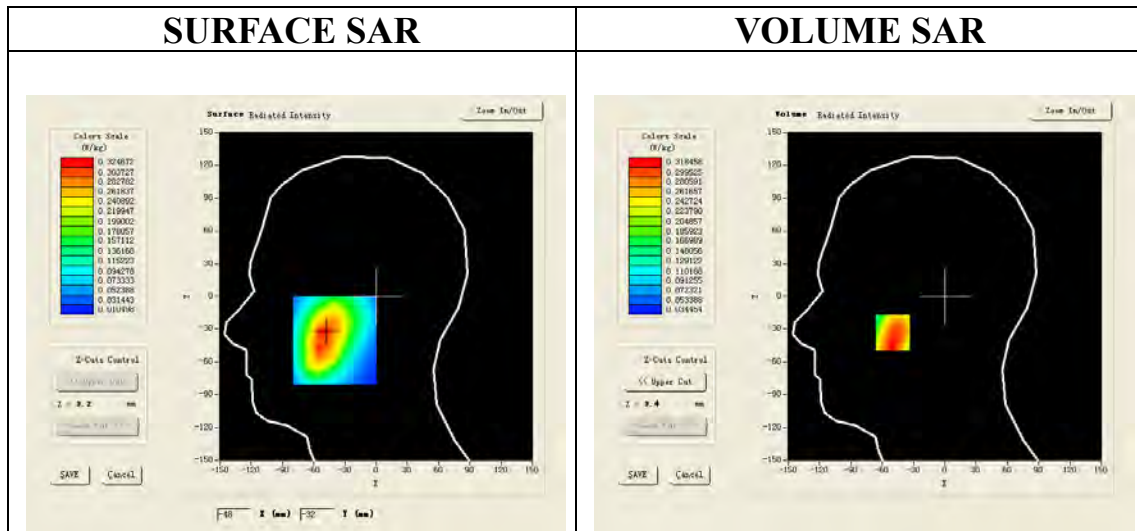

Maximum location: X=-50.00, Y=-33.00

SAR 10g (W/Kg)	0.208023
SAR 1g (W/Kg)	0.302715

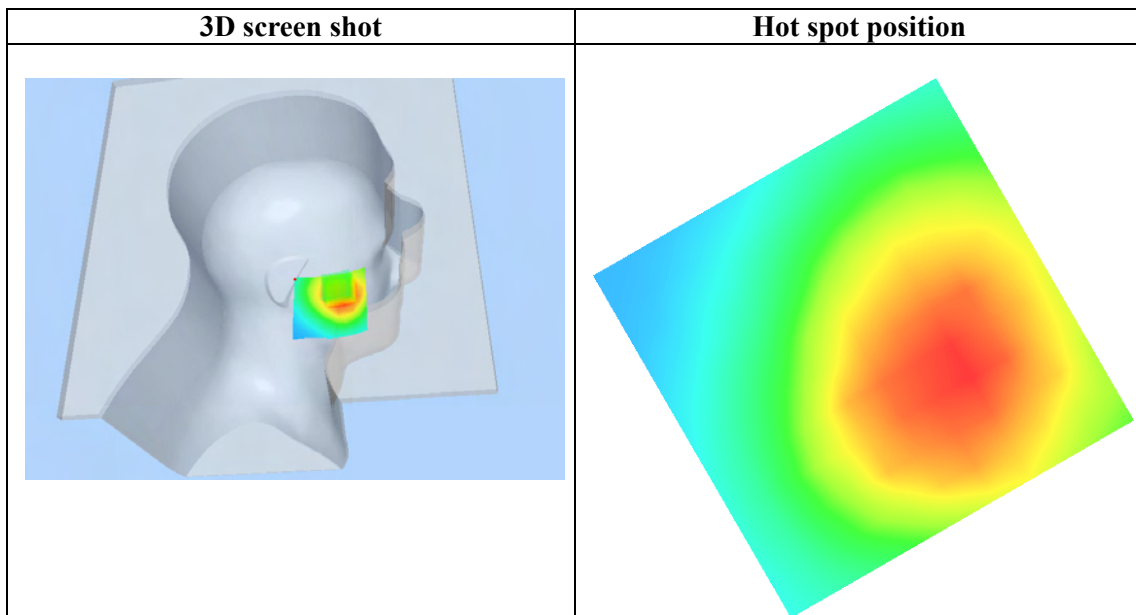
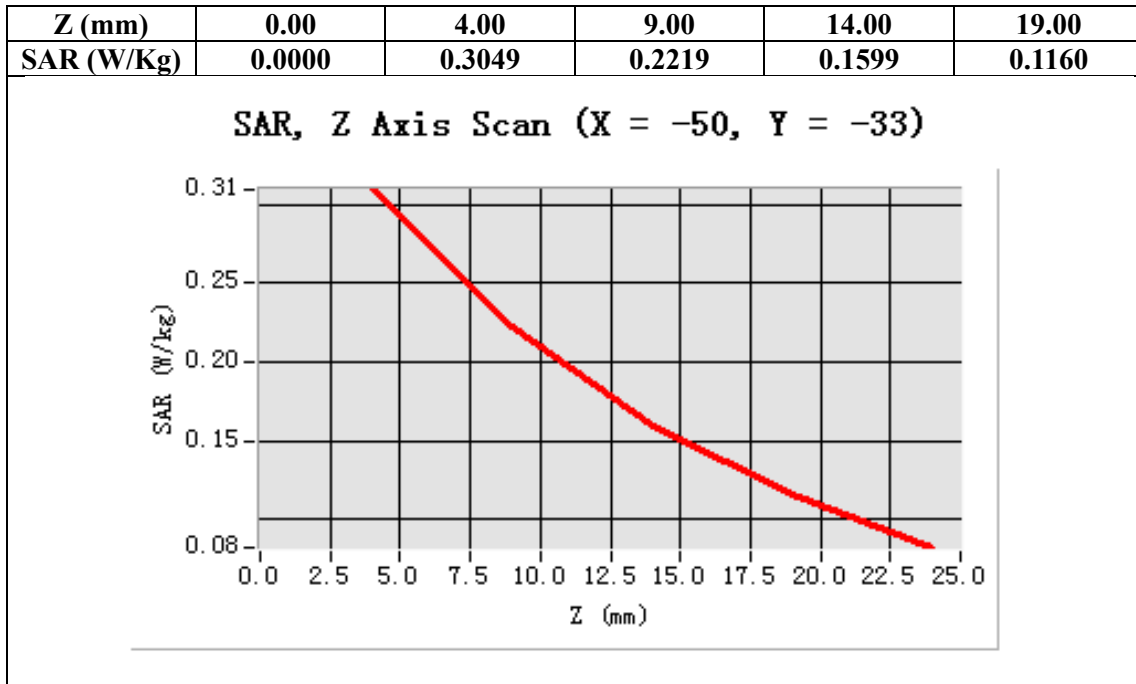

Test Laboratory: AGC Lab
PCS 1900 Mid-Tilt-Right <SIM 1>
DUT: Mobile Phone; Type: Profile

Date: Dec.06, 2013

Communication System: Generic GSM; Communication System Band: PCS 1900; Duty Cycle: 1:8.3; Conv.F=4.72;
Frequency: 1880 MHz; Medium parameters used: $f = 1900$ MHz; $\sigma = 1.38$ mho/m; $\epsilon_r = 39.97$; $\rho = 1000$ kg/m³ ;
Phantom section: Right Section
Ambient temperature (°C): 21.0, Liquid temperature (°C): 21.0

SATIMO Configuration:

Probe: EP165; Calibrated: 01/31/2013

- Sensor-Surface: 4mm (Mechanical Surface Detection)
- Phantom: Flat Phantom; Type: Elliptical Phantom
- Measurement SW: OpenSAR V4_02_01

Configuration/PCS1900 Mid-Tilt-Right/Area Scan: Measurement grid: dx=8mm, dy=8mm
Configuration/PCS1900 Mid-Tilt-Right/Zoom Scan: Measurement grid: dx=8mm, dy=8mm, dz=5mm;

Area Scan	sam_direct_droit2_surf8mm.txt
ZoomScan	5x5x7,dx=8mm dy=8mm dz=5mm,Very fast
Phantom	Right head
Device Position	Tilt
Band	PCS 1900
Channels	Middle
Signal	TDMA (Crest factor: 8.0)

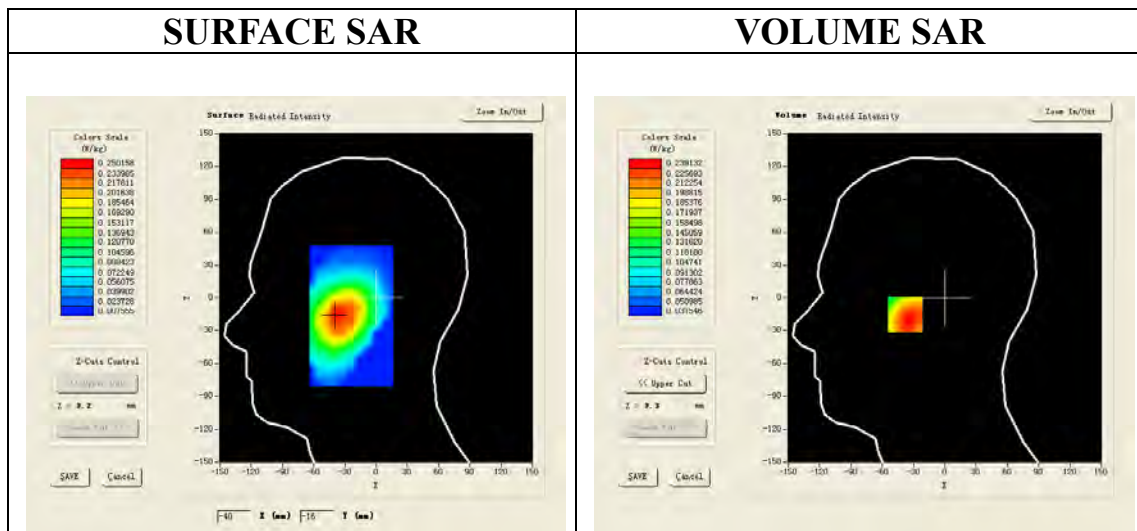

Maximum location: X=-38.00, Y=-15.00

SAR 10g (W/Kg)	0.162964
SAR 1g (W/Kg)	0.231750

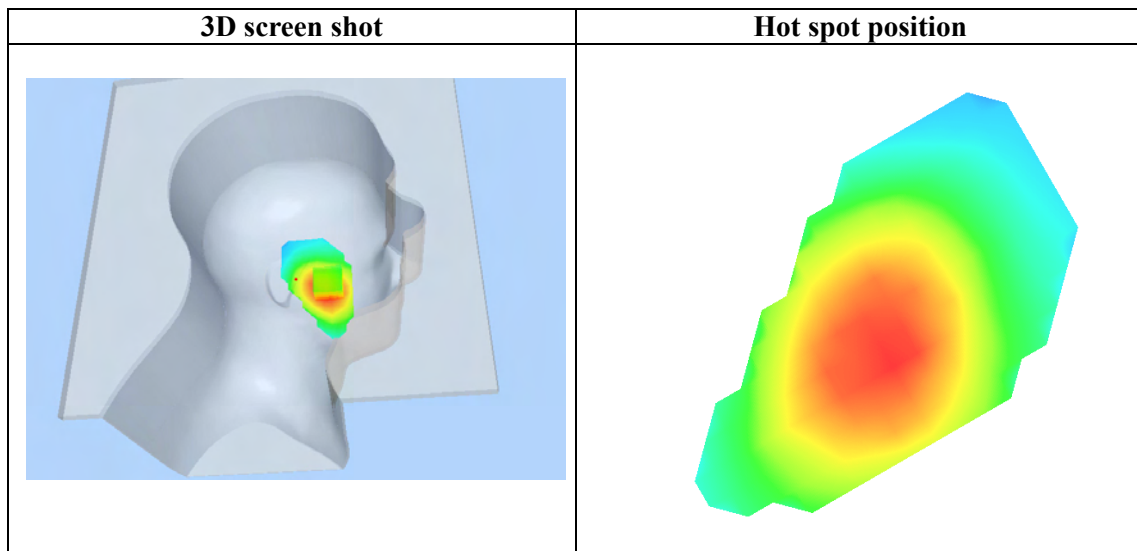
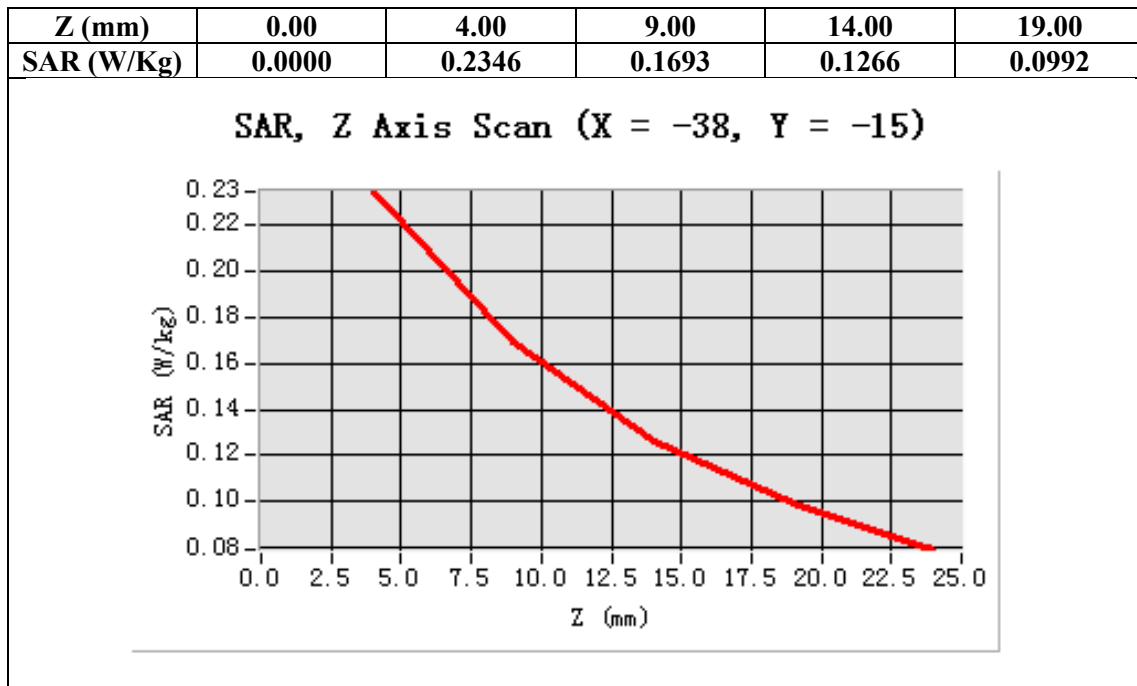

Test Laboratory: AGC Lab
PCS 1900 Mid-Touch-Left <SIM 2>
DUT: Mobile Phone; Type: Profile

Date: Dec.06, 2013

Communication System: Generic GSM; Communication System Band: PCS 1900; Duty Cycle: 1:8.3; Conv.F=4.72;
Frequency: 1880 MHz; Medium parameters used: $f = 1900$ MHz; $\sigma = 1.38$ mho/m; $\epsilon_r = 39.97$; $\rho = 1000$ kg/m³ ;
Phantom section: Left Section
Ambient temperature (°C): 21.0, Liquid temperature (°C): 21.0

SATIMO Configuration:

Probe: EP165; Calibrated: 01/31/2013

- Sensor-Surface: 4mm (Mechanical Surface Detection)
- Phantom: Flat Phantom; Type: Elliptical Phantom
- Measurement SW: OpenSAR V4_02_01

Configuration/PCS1900 Mid-Touch-Left/Area Scan: Measurement grid: dx=8mm, dy=8mm
Configuration/PCS1900 Mid-Touch-Left/Zoom Scan: Measurement grid: dx=8mm, dy=8mm, dz=5mm;

Area Scan	sam_direct_droit2_surf8mm.txt
ZoomScan	5x5x7,dx=8mm dy=8mm dz=5mm,Very fast
Phantom	Left head
Device Position	Cheek
Band	PCS 1900
Channels	Middle
Signal	TDMA (Crest factor: 8.0)

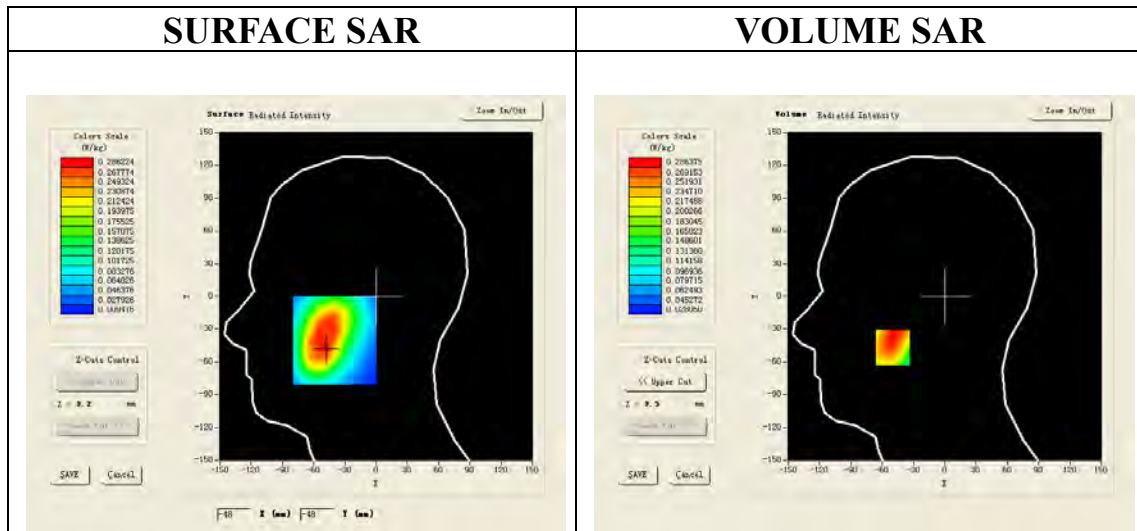

Maximum location: X=-50.00, Y=-47.00

SAR 10g (W/Kg)	0.183755
SAR 1g (W/Kg)	0.274793

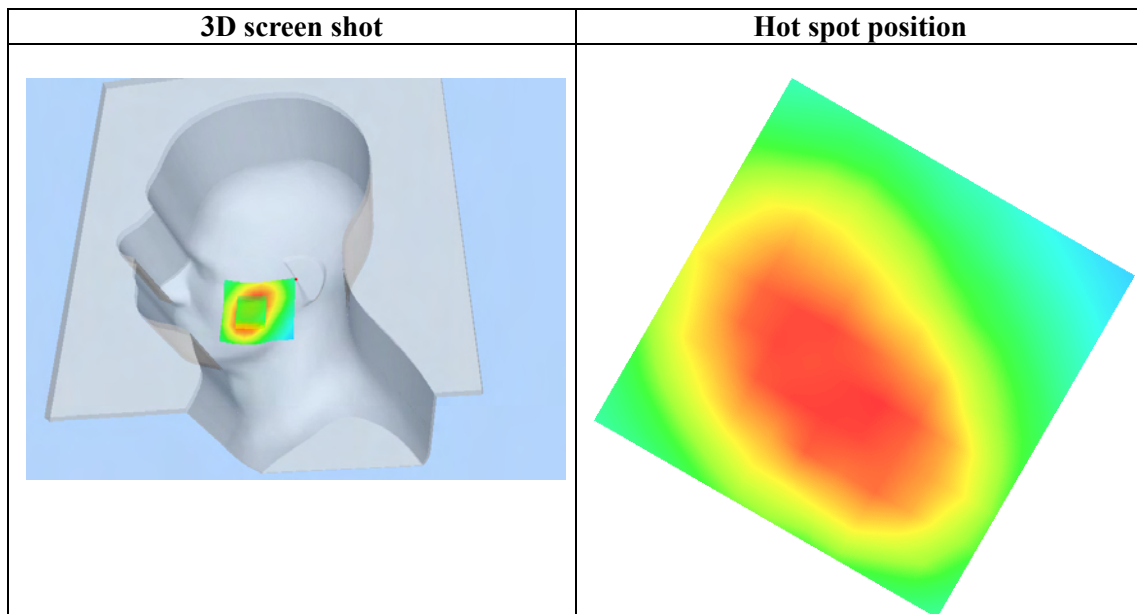
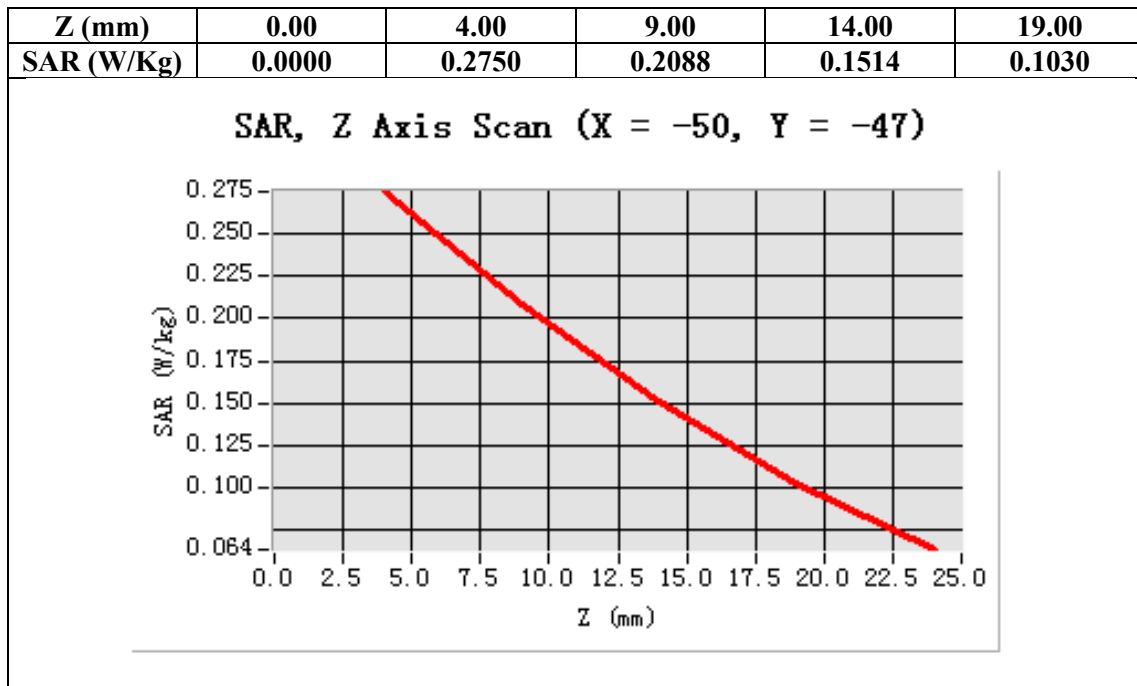

Test Laboratory: AGC Lab
PCS 1900 Mid-Body- Back <SIM 1>
DUT: Mobile Phone; Type: Profile

Date: Dec.06, 2013

Communication System: Generic GSM; Communication System Band: PCS 1900; Duty Cycle: 1:8.3; Conv.F=4.84;
Frequency: 1880 MHz; Medium parameters used: $f = 1900$ MHz; $\sigma = 1.49$ mho/m; $\epsilon_r = 52.68$; $\rho = 1000$ kg/m³ ;
Phantom section: Flat Section
Ambient temperature (°C): 21.0, Liquid temperature (°C): 21.0

SATIMO Configuration:

Probe: EP165; Calibrated: 01/31/2013

- Sensor-Surface: 4mm (Mechanical Surface Detection)
- Phantom: Flat Phantom; Type: Elliptical Phantom
- Measurement SW: OpenSAR V4_02_01

Configuration/PCS1900 Mid-Body-Back/Area Scan: Measurement grid: dx=8mm, dy=8mm
Configuration/PCS1900 Mid-Body-Back/Zoom Scan: Measurement grid: dx=8mm, dy=8mm, dz=5mm;

Area Scan	surf_sam_plan.txt
ZoomScan	5x5x7,dx=8mm dy=8mm dz=5mm,Very fast
Phantom	Validation plane
Device Position	Body Back
Band	PCS 1900
Channels	Middle
Signal	TDMA (Crest factor: 8.0)

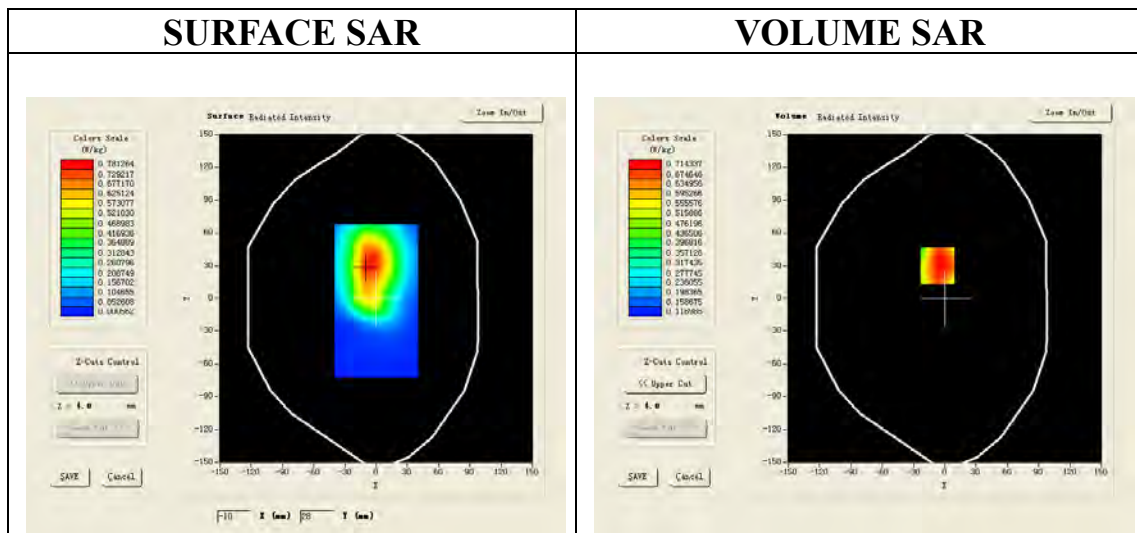

Maximum location: X=-7.00, Y=30.00

SAR 10g (W/Kg)	0.554641
SAR 1g (W/Kg)	0.756250

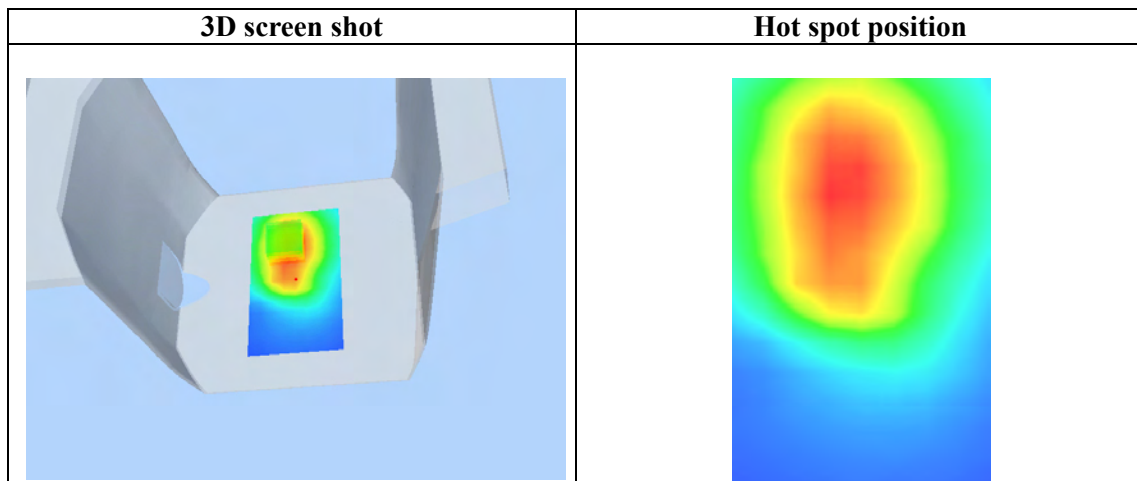
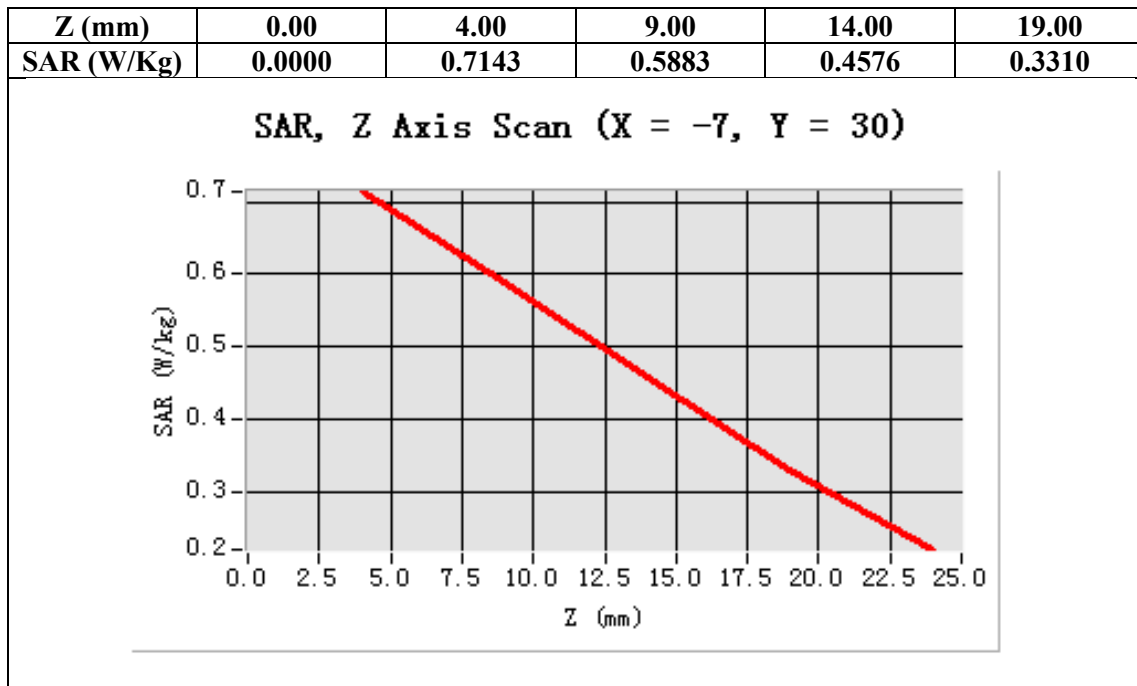

Test Laboratory: AGC Lab
PCS 1900 Mid-Body -Front (MS) <SIM 1>
DUT: Mobile Phone; Type: Profile

Date: Dec.06, 2013

Communication System: Generic GSM; Communication System Band: PCS 1900; Duty Cycle: 1:8.3; Conv.F=4.84;
Frequency: 1880 MHz; Medium parameters used: $f = 1900$ MHz; $\sigma = 1.49$ mho/m; $\epsilon_r = 52.68$; $\rho = 1000$ kg/m³ ;
Phantom section: Flat Section
Ambient temperature (°C): 21.0, Liquid temperature (°C): 21.0

SATIMO Configuration:

Probe: EP165; Calibrated: 01/31/2013

- Sensor-Surface: 4mm (Mechanical Surface Detection)
- Phantom: Flat Phantom; Type: Elliptical Phantom
- Measurement SW: OpenSAR V4_02_01

Configuration/PCS1900 Mid-Body- Front /Area Scan: Measurement grid: dx=8mm, dy=8mm
Configuration/PCS1900 Mid-Body- Front /Zoom Scan: Measurement grid: dx=8mm, dy=8mm, dz=5mm;

Area Scan	surf_sam_plan.txt
ZoomScan	5x5x7,dx=8mm dy=8mm dz=5mm,Very fast
Phantom	Validation plane
Device Position	Body Front
Band	PCS 1900
Channels	Middle
Signal	TDMA (Crest factor: 8.0)

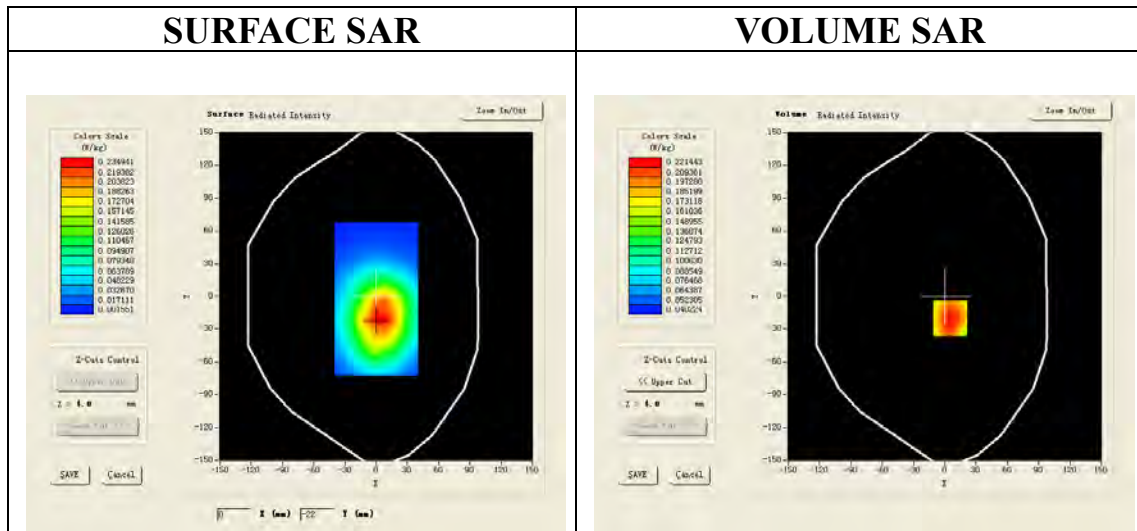

Maximum location: X=5.00, Y=-20.00

SAR 10g (W/Kg)	0.149653
SAR 1g (W/Kg)	0.212514

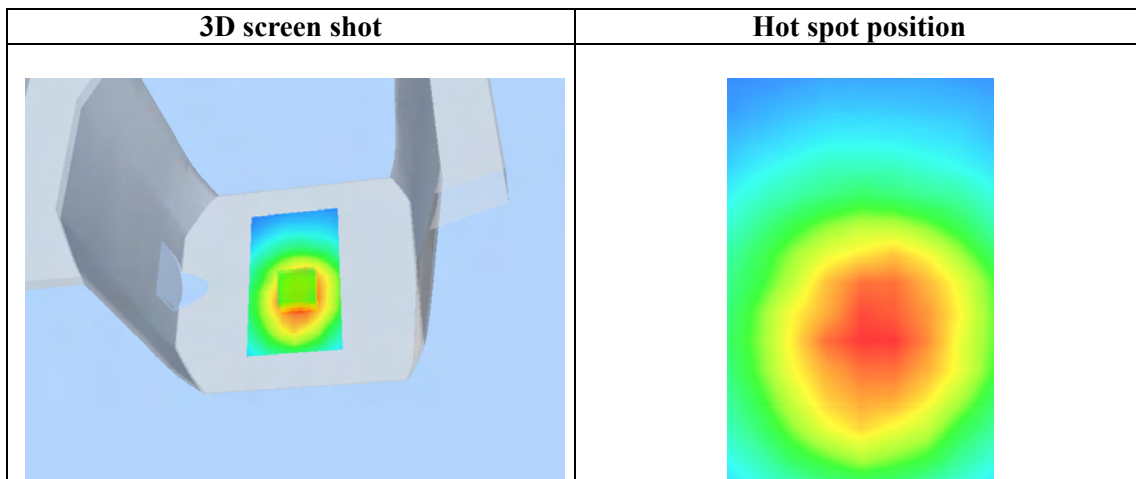
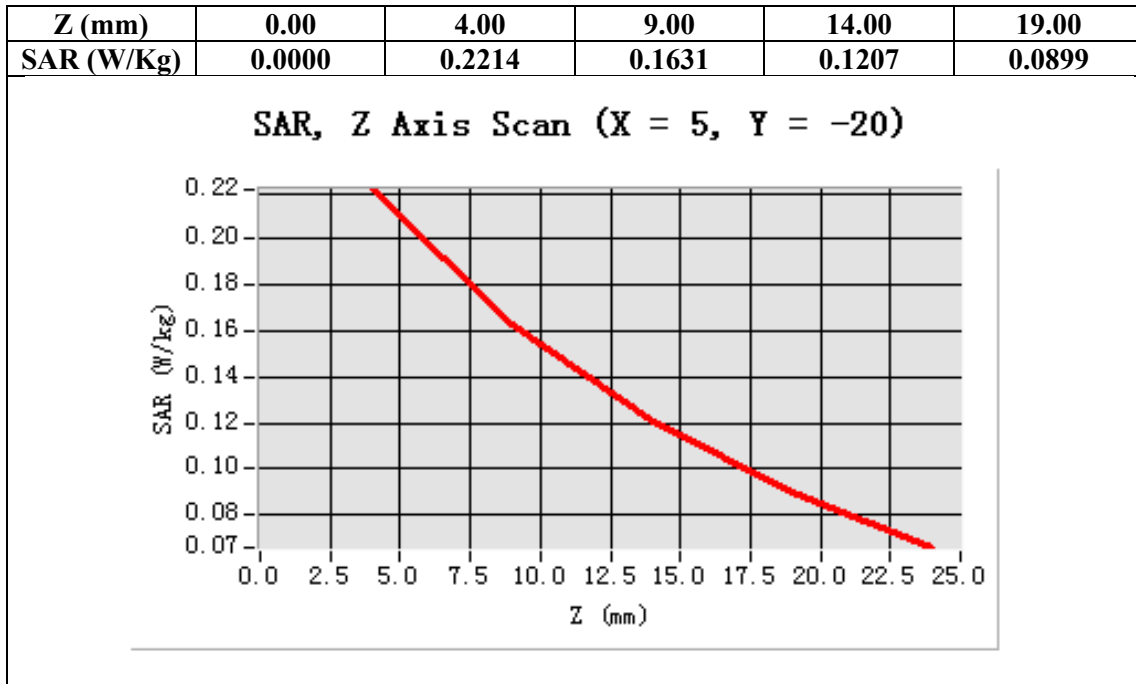

Test Laboratory: AGC Lab
WCDMA Band II Mid-Touch-Left (RMC)
DUT: Mobile Phone; Type: Profile

Date: Dec.06, 2013

Communication System: UMTS; Communication System Band: Band II UTRA/FDD ;Duty Cycle:1:1;Conv.F=4.72
Frequency: 1880 MHz; Medium parameters used: $f = 1900$ MHz; $\sigma = 1.38$ mho/m; $\epsilon_r = 39.97$; $\rho = 1000$ kg/m³ ;
Phantom section: Left Section
Ambient temperature (°C):21, Liquid temperature (°C):21

SATIMO Configuration:

Probe: EP165; Calibrated: 01/31/2013

- Sensor-Surface: 4mm (Mechanical Surface Detection)
- Phantom: Flat Phantom; Type: Elliptical Phantom
- Measurement SW: OpenSAR V4_02_01

Configuration/ WCDMA Band II Mid-Touch-Left/Area Scan: Measurement grid: dx=8mm, dy=8mm
Configuration/ WCDMA Band II Mid-Touch-Left/Zoom Scan: Measurement grid:
dx=8mm,dy=8mm,dz=5mm;

Area Scan	sam_direct_droit2_surf8mm.txt
ZoomScan	5x5x7,dx=8mm dy=8mm dz=5mm,Very fast
Phantom	Left head
Device Position	Cheek
Band	WCDMA Band II
Channels	Middle
Signal	TDMA (Crest factor: 1.0)

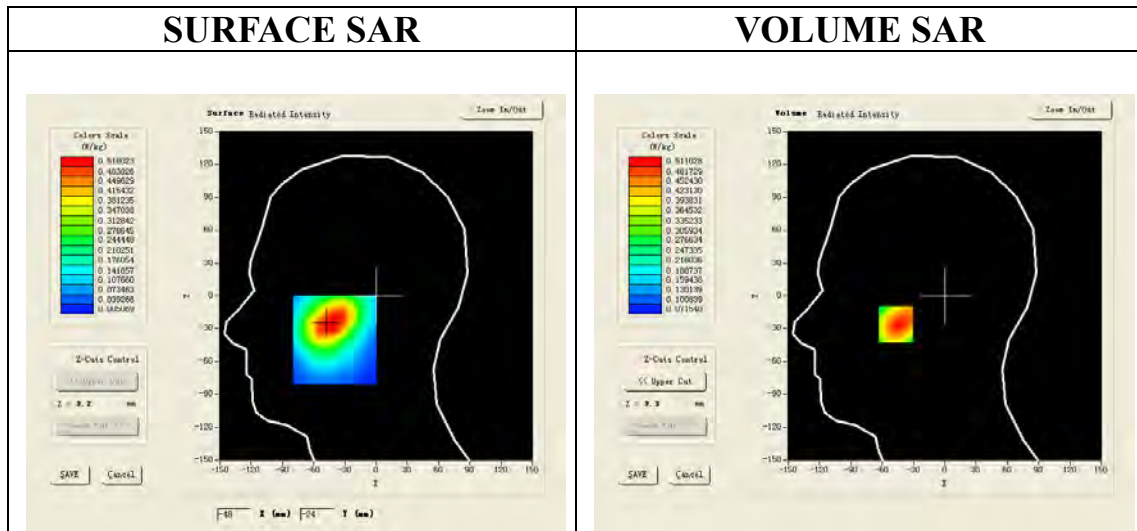

Maximum location: X=-47.00, Y=-26.00

SAR 10g (W/Kg)	0.336701
SAR 1g (W/Kg)	0.491654

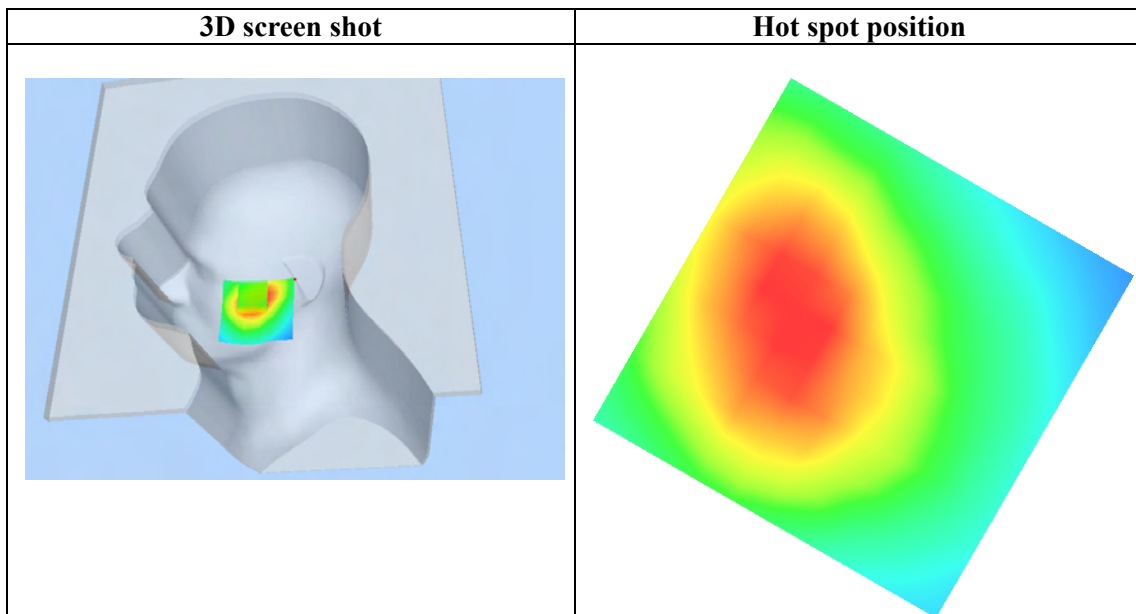
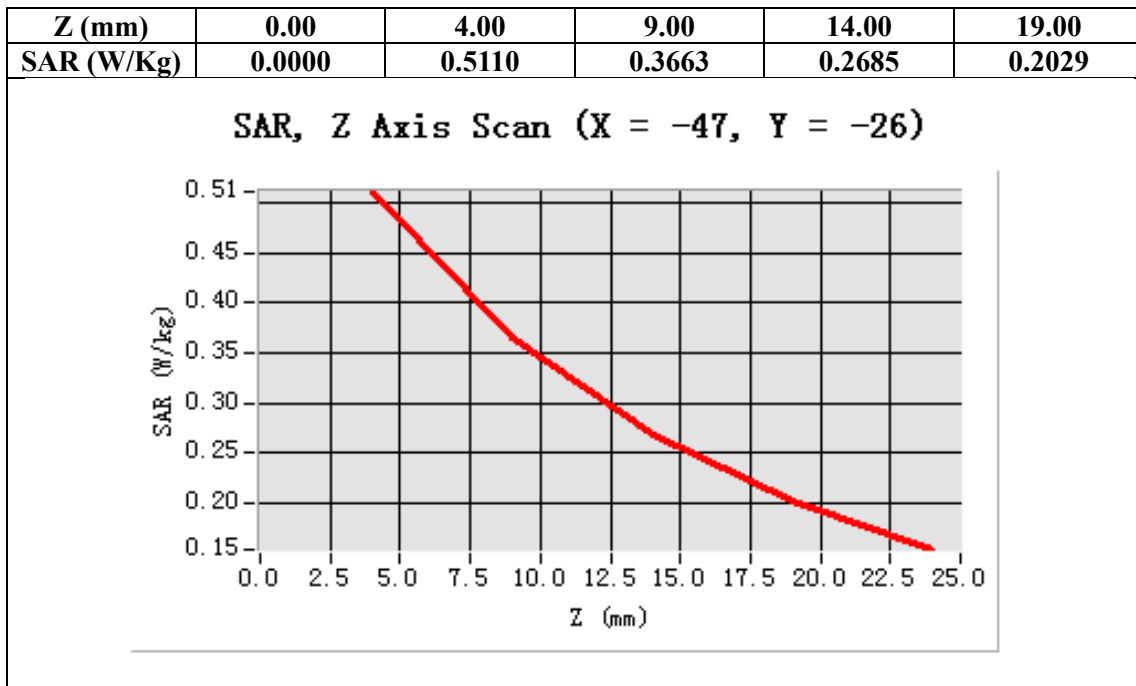

Test Laboratory: AGC Lab
WCDMA Band II Mid-Tilt-Left (RMC)
DUT: Mobile Phone; Type: Profile

Date: Dec.06, 2013

Communication System: UMTS; Communication System Band: Band II UTRA/FDD ;Duty Cycle:1:1; Conv.F=4.72
Frequency: 1880 MHz; Medium parameters used: $f = 1900$ MHz; $\sigma = 1.38$ mho/m; $\epsilon_r = 39.97$; $\rho = 1000$ kg/m³ ;
Phantom section: Left Section
Ambient temperature (°C):21, Liquid temperature (°C):21

SATIMO Configuration:

Probe: EP165; Calibrated: 01/31/2013

- Sensor-Surface: 4mm (Mechanical Surface Detection)
- Phantom: Flat Phantom; Type: Elliptical Phantom
- Measurement SW: OpenSAR V4_02_01

Configuration/ WCDMA Band II Mid-Tilt-Left/Area Scan: Measurement grid: dx=8mm, dy=8mm
Configuration/ WCDMA Band II Mid-Tilt-Left/Zoom Scan: Measurement grid: dx=8mm, dy=8mm, dz=5mm;

Area Scan	sam_direct_droit2_surf8mm.txt
ZoomScan	5x5x7,dx=8mm dy=8mm dz=5mm,Very fast
Phantom	Left head
Device Position	Tilt
Band	WCDMA Band II
Channels	Middle
Signal	TDMA (Crest factor: 1.0)

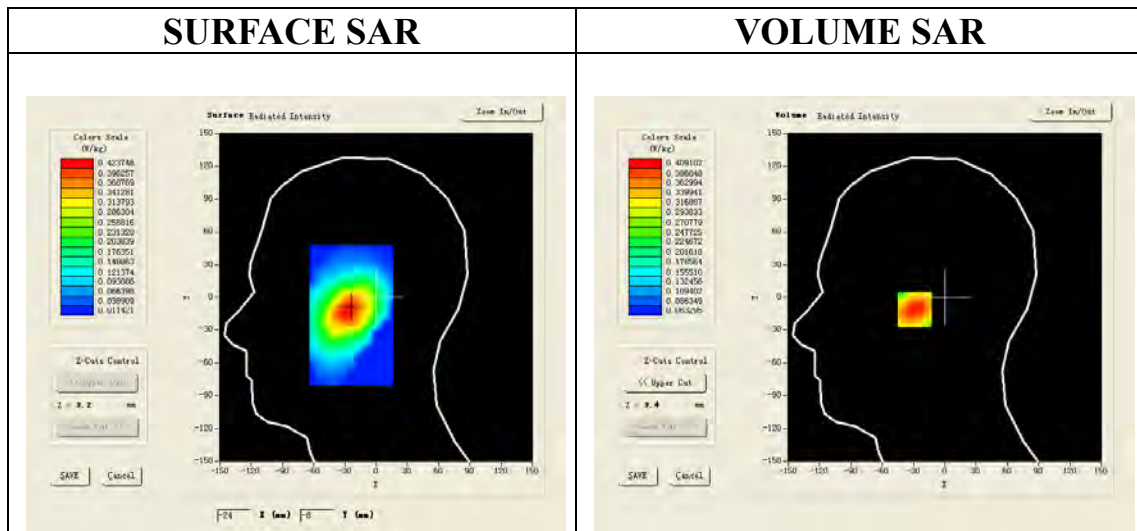

Maximum location: X=-26.00, Y=-11.00

SAR 10g (W/Kg)	0.281491
SAR 1g (W/Kg)	0.391791

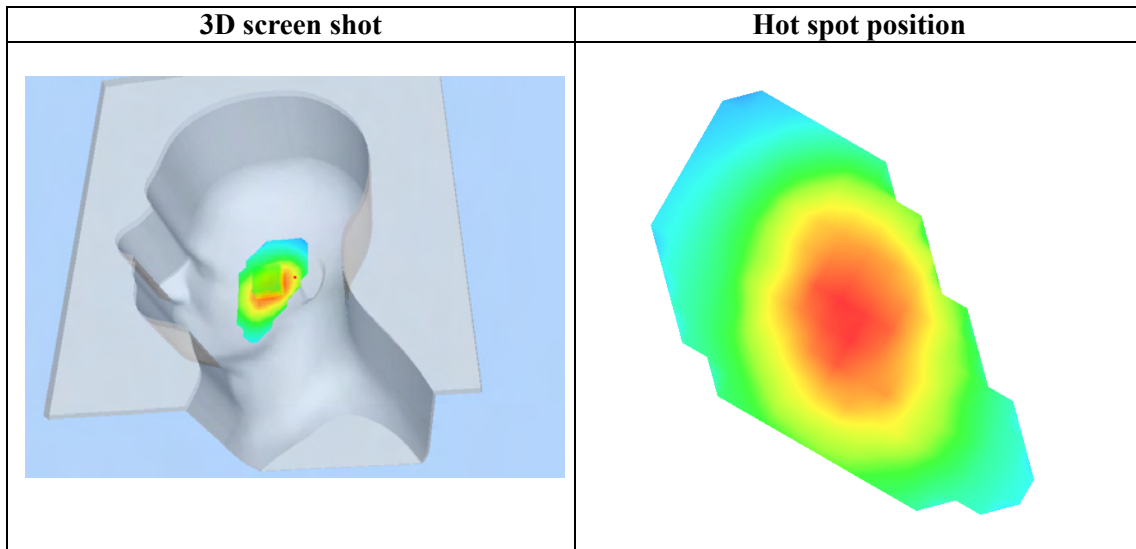
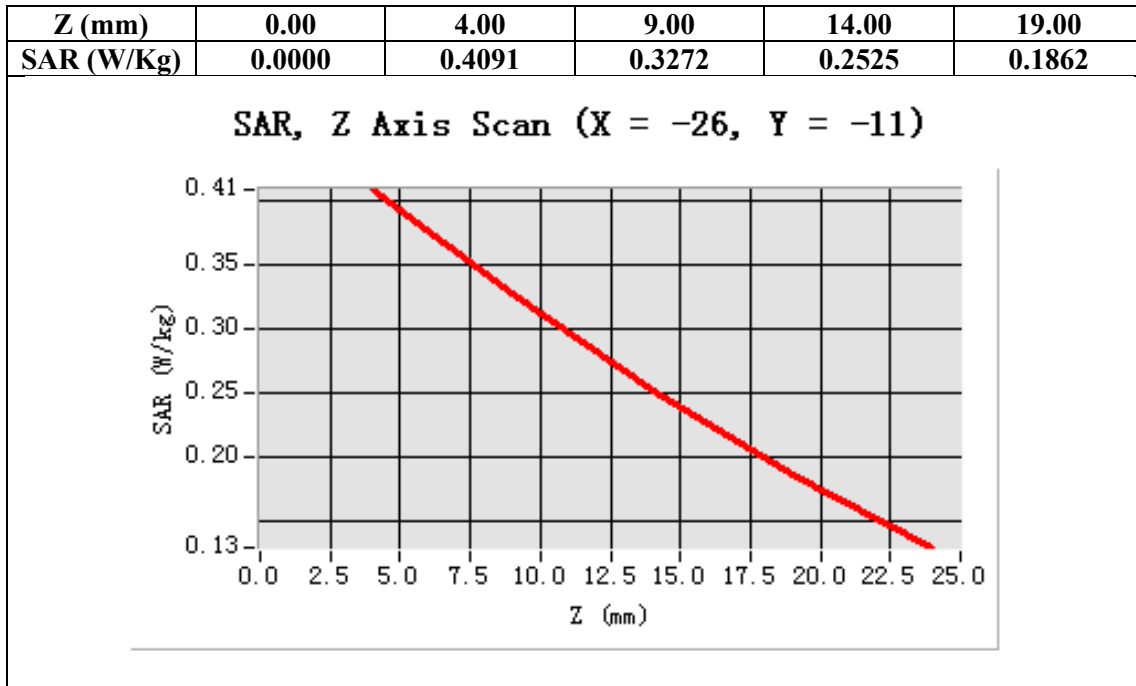

Test Laboratory: AGC Lab
WCDMA Band II Mid-Touch-Right (RMC)
DUT: Mobile Phone; Type: Profile

Date: Dec.06, 2013

Communication System: UMTS; Communication System Band: Band II UTRA/FDD ;Duty Cycle:1:1; Conv.F=4.72
Frequency: 1880 MHz; Medium parameters used: $f = 1900$ MHz; $\sigma = 1.38$ mho/m; $\epsilon_r = 39.97$; $\rho = 1000$ kg/m³ ;
Phantom section: Right Section
Ambient temperature (°C):21, Liquid temperature (°C):21

SATIMO Configuration:

Probe: EP165; Calibrated: 01/31/2013

- Sensor-Surface: 4mm (Mechanical Surface Detection)
- Phantom: Flat Phantom; Type: Elliptical Phantom
- Measurement SW: OpenSAR V4_02_01

Configuration/ WCDMA band II Mid-Touch-Right/Area Scan: Measurement grid: dx=8mm, dy=8mm
Configuration/ WCDMA band II Mid-Touch-Right/Zoom Scan: Measurement grid: dx=8mm, dy=8mm, dz=5mm;

Area Scan	sam_direct_droit2_surf8mm.txt
ZoomScan	5x5x7,dx=8mm dy=8mm dz=5mm,Very fast
Phantom	Right head
Device Position	Cheek
Band	WCDMA band II
Channels	Middle
Signal	TDMA (Crest factor: 1.0)

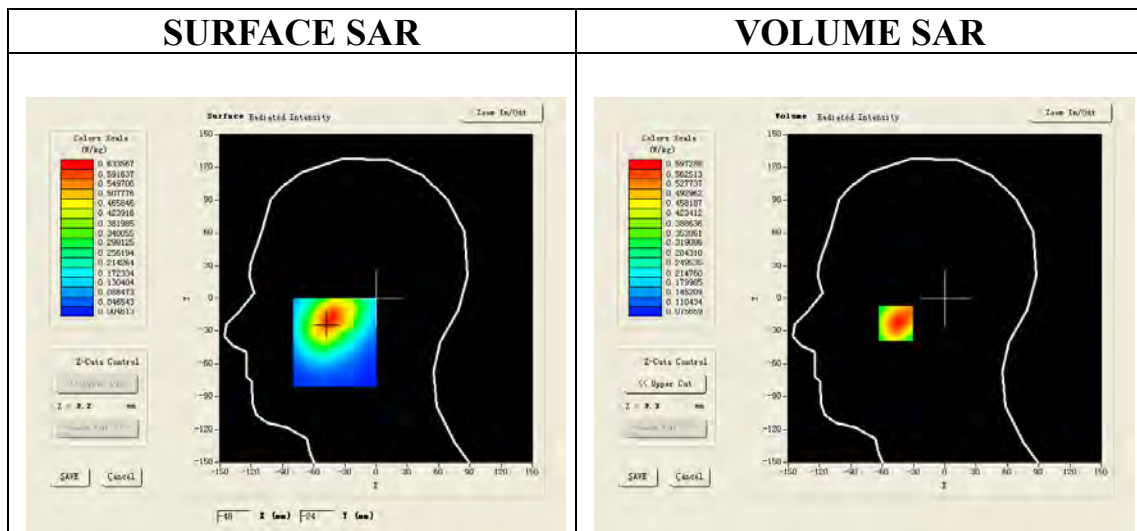

Maximum location: X=-47.00, Y=-23.00

SAR 10g (W/Kg)	0.397372
SAR 1g (W/Kg)	0.572618

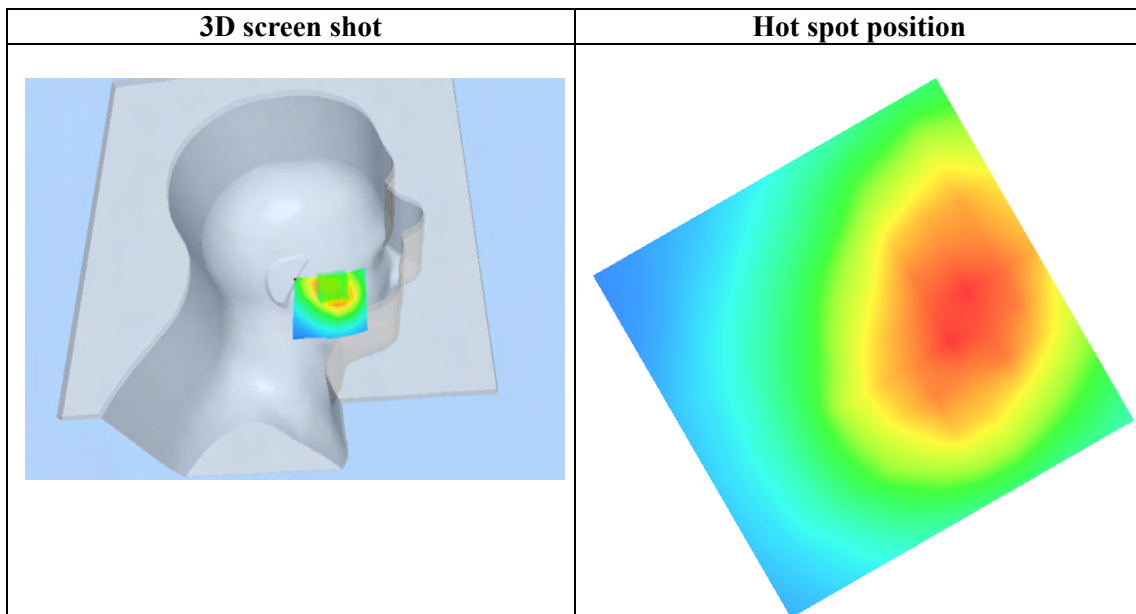
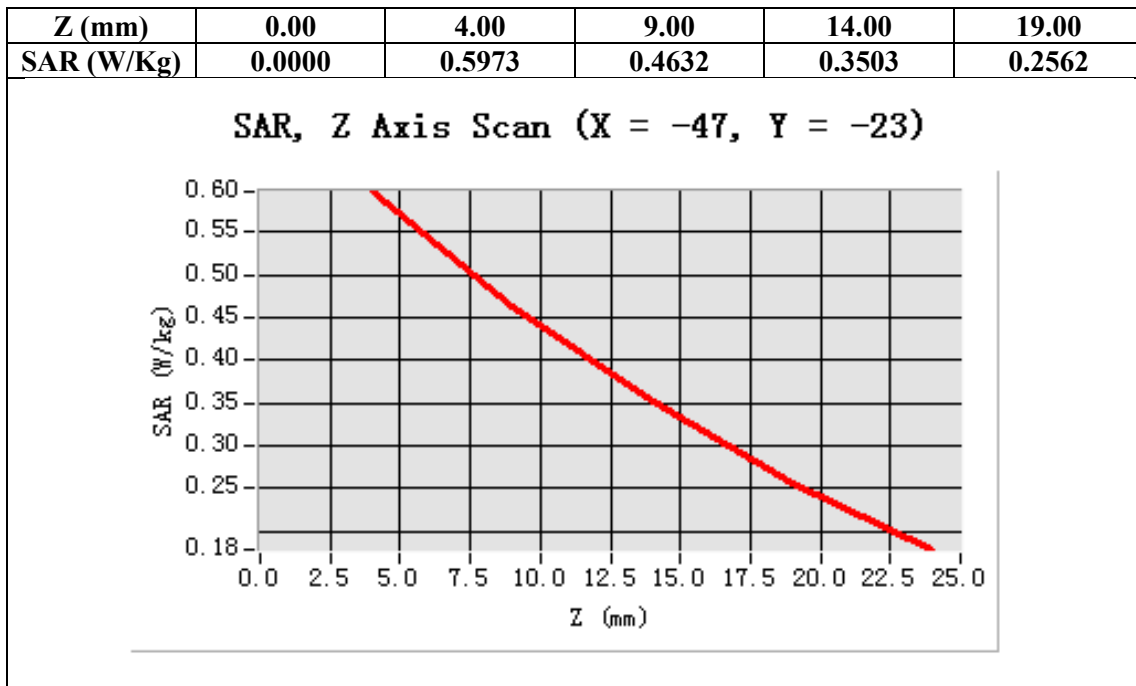

Test Laboratory: AGC Lab
WCDMA Band II Mid-Tilt-Right <RMC>
DUT: Mobile Phone; Type: Profile

Date: Dec.06, 2013

Communication System: UMTS; Communication System Band: Band II UTRA/FDD ;Duty Cycle:1:1; Conv.F=4.72
Frequency: 1880 MHz; Medium parameters used: $f = 1900$ MHz; $\sigma = 1.38$ mho/m; $\epsilon_r = 39.97$; $\rho = 1000$ kg/m³ ;
Phantom section: Right Section
Ambient temperature (°C):21, Liquid temperature (°C):21

SATIMO Configuration:

Probe: EP165; Calibrated: 01/31/2013

- Sensor-Surface: 4mm (Mechanical Surface Detection)
- Phantom: Flat Phantom; Type: Elliptical Phantom
- Measurement SW: OpenSAR V4_02_01

Configuration/PCS1900 Mid-Tilt-Right/Area Scan: Measurement grid: dx=8mm, dy=8mm
Configuration/PCS1900 Mid-Tilt-Right/Zoom Scan: Measurement grid: dx=8mm, dy=8mm, dz=5mm;

Area Scan	sam_direct_droit2_surf8mm.txt
ZoomScan	5x5x7,dx=8mm dy=8mm dz=5mm,Very fast
Phantom	Right head
Device Position	Tilt
Band	WCDMA band II
Channels	Middle
Signal	TDMA (Crest factor: 1.0)

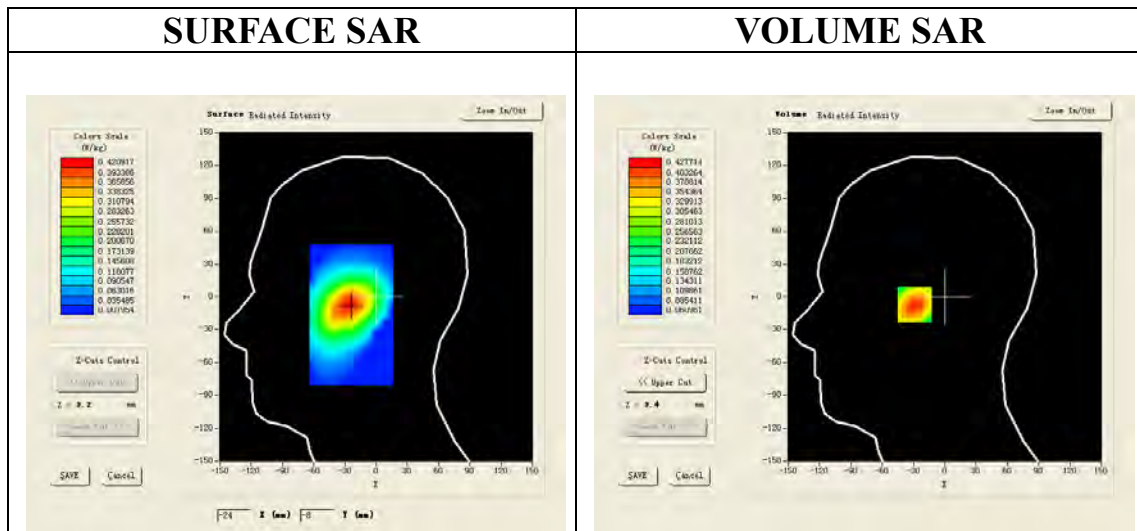

Maximum location: X=-26.00, Y=-7.00

SAR 10g (W/Kg)	0.278472
SAR 1g (W/Kg)	0.407193

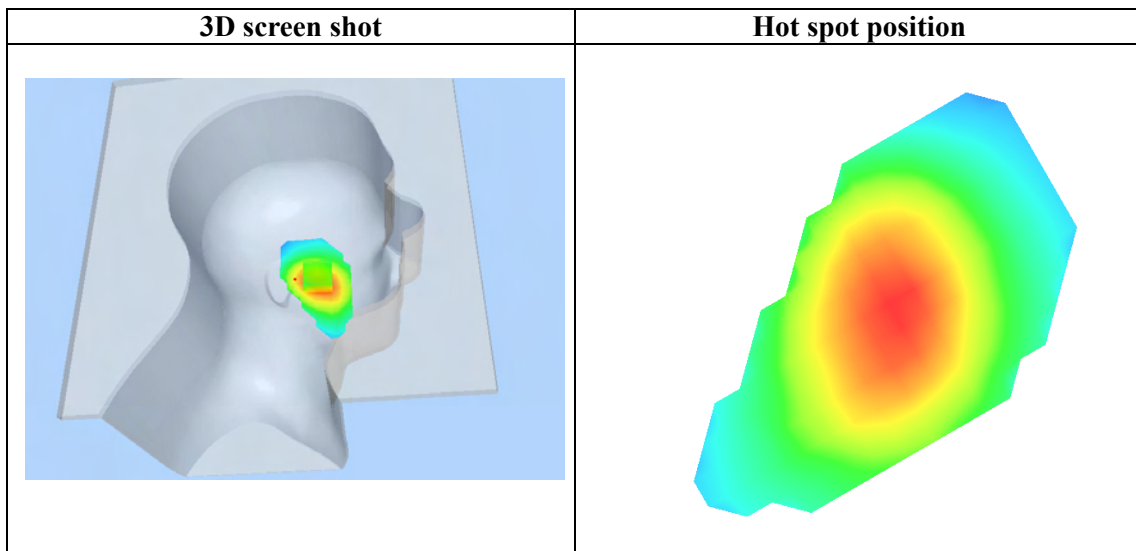
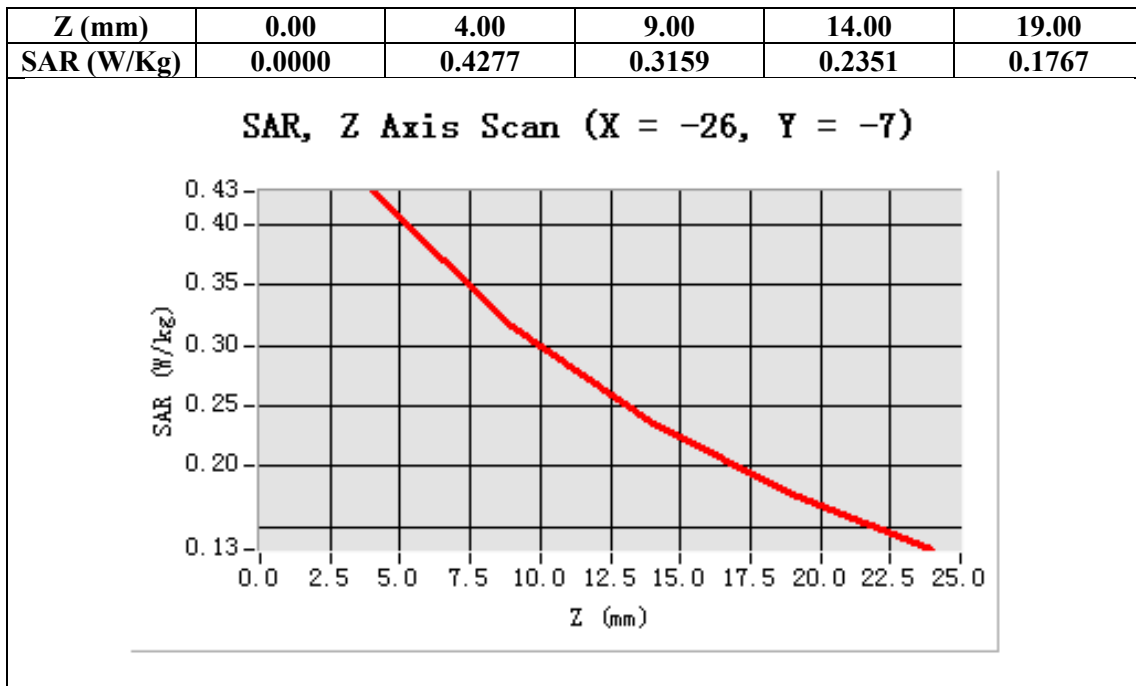

Test Laboratory: AGC Lab
WCDMA Band II Low-Body-Towards Grounds (RMC)
DUT: Mobile Phone; Type: Profile

Date: Dec.06, 2013

Communication System: UMTS; Communication System Band: Band II UTRA/FDD ;Duty Cycle:1:1; ConvF=4.84
Frequency: 1852.4 MHz; Medium parameters used: $f = 1900$ MHz; $\sigma=1.49$ mho/m; $\epsilon_r = 52.68$; $\rho= 1000$ kg/m³ ;
Phantom section: Flat Section
Ambient temperature (°C):21, Liquid temperature (°C):21

SATIMO Configuration:

- Probe: EP165; Calibrated: 01/31/2013
- Sensor-Surface: 4mm (Mechanical Surface Detection)
- Phantom: Flat Phantom; Type: Elliptical Phantom
- Measurement SW: OpenSAR V4_02_01

Configuration/ WCDMA band II Low-Body-back/Area Scan: Measurement grid: dx=8mm, dy=8mm
Configuration/ WCDMA band II Low-Body-back/Zoom Scan: Measurement grid: dx=8mm, dy=8mm, dz=5m;

Area Scan	surf_sam_plan.txt
ZoomScan	5x5x7,dx=8mm dy=8mm dz=5mm,Very fast
Phantom	Validation plane
Device Position	Body Back
Band	WCDMA band II
Channels	Low
Signal	TDMA (Crest factor: 1.0)

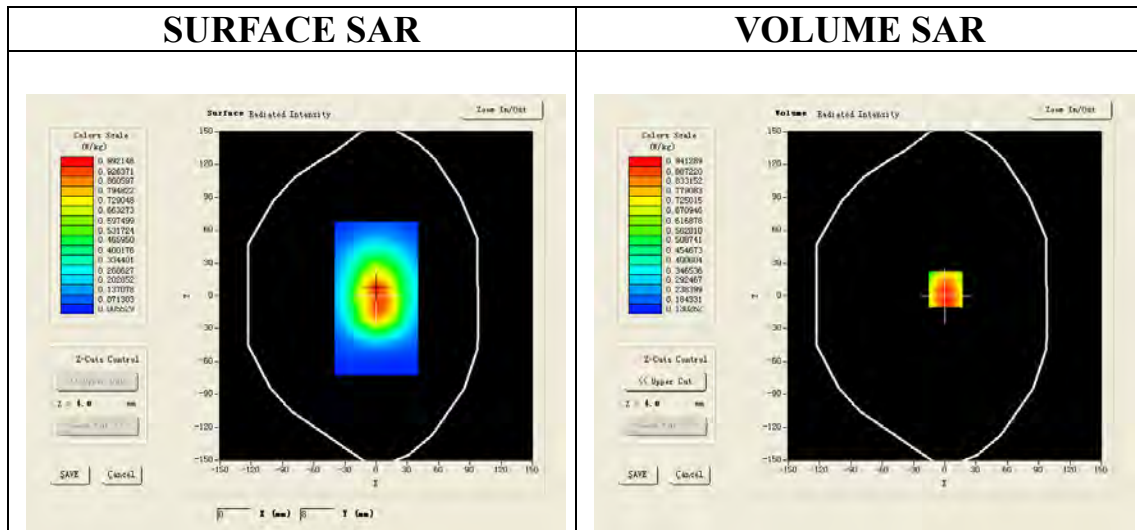

Maximum location: X=1.00, Y=6.00

SAR 10g (W/Kg)	0.652846
SAR 1g (W/Kg)	0.964108

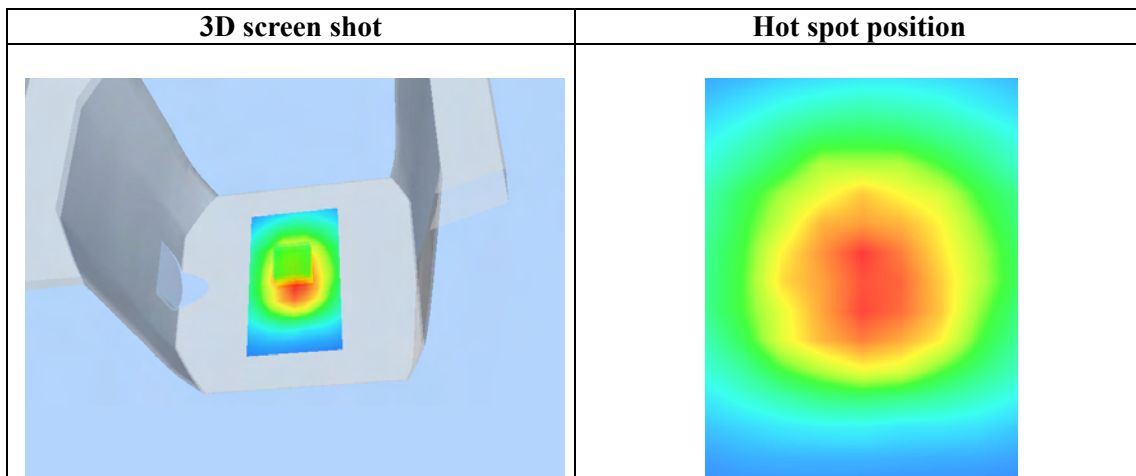
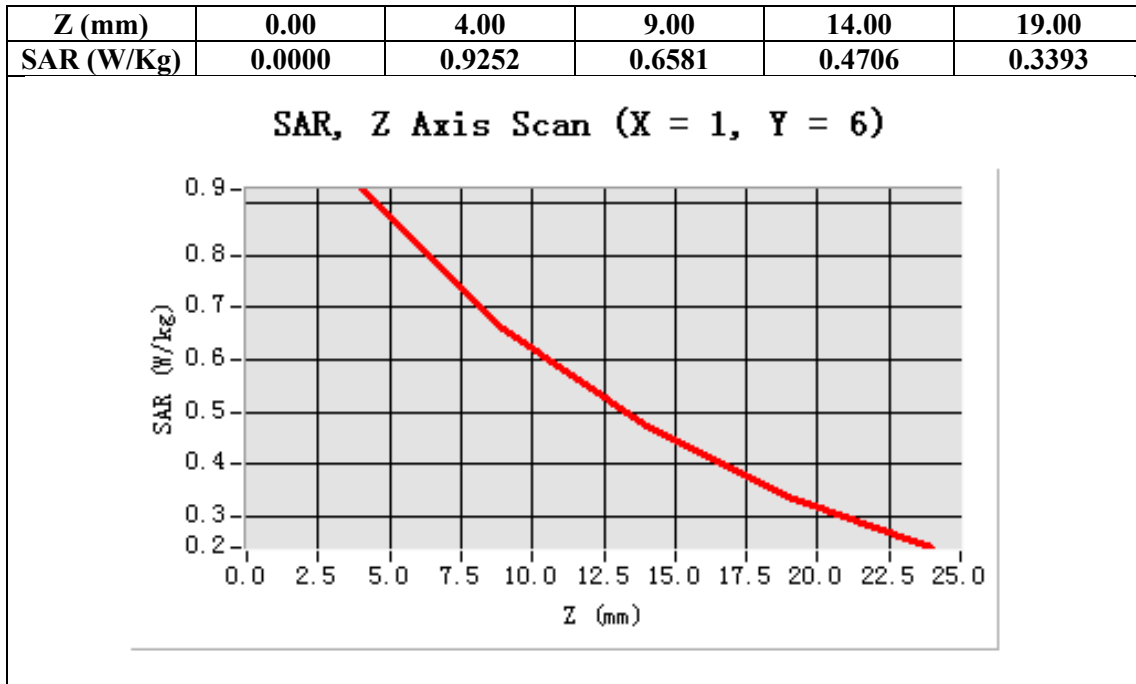

Test Laboratory: AGC Lab
WCDMA Band II Mid-Body-Towards Grounds (RMC)
DUT: Mobile Phone; Type: Profile

Date: Dec.06, 2013

Communication System: UMTS; Communication System Band: Band II UTRA/FDD ;Duty Cycle:1:1; ConvF=4.84
Frequency: 1880 MHz; Medium parameters used: $f = 1900$ MHz; $\sigma = 1.49$ mho/m; $\epsilon_r = 52.68$; $\rho = 1000$ kg/m³ ;
Phantom section: Flat Section
Ambient temperature (°C):21, Liquid temperature (°C):21

SATIMO Configuration:

Probe: EP165; Calibrated: 01/31/2013

- Sensor-Surface: 4mm (Mechanical Surface Detection)
- Phantom: Flat Phantom; Type: Elliptical Phantom
- Measurement SW: OpenSAR V4_02_01

Configuration/ WCDMA band II Mid-Body-back/Area Scan: Measurement grid: dx=8mm, dy=8mm
Configuration/ WCDMA band II Mid-Body-back/Zoom Scan: Measurement grid: dx=8mm, dy=8mm, dz=5m;

Area Scan	surf_sam_plan.txt
ZoomScan	5x5x7,dx=8mm dy=8mm dz=5mm,Very fast
Phantom	Validation plane
Device Position	Body Back
Band	WCDMA band II
Channels	Middle
Signal	TDMA (Crest factor: 1.0)

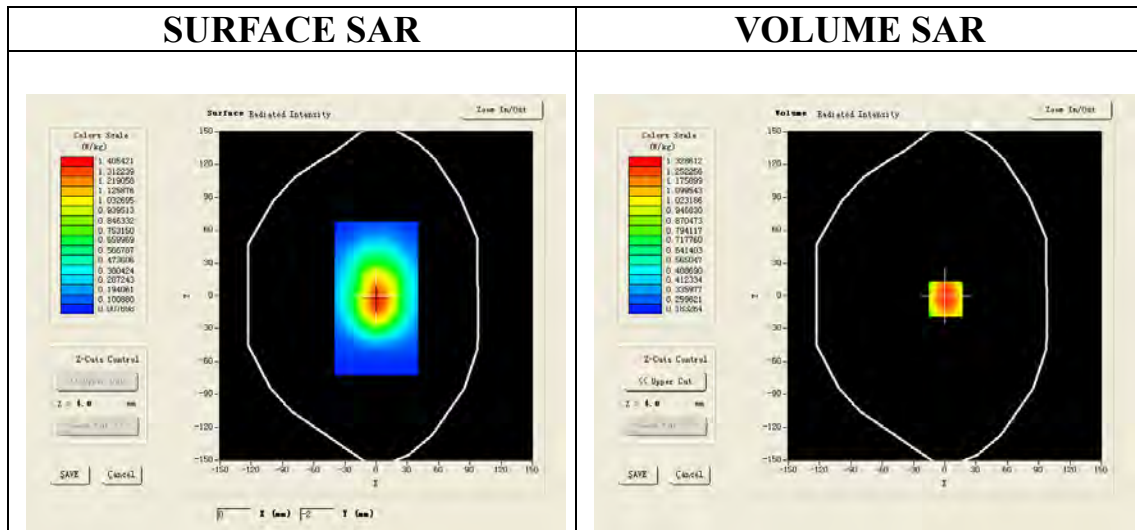

Maximum location: X=1.00, Y=-3.00

SAR 10g (W/Kg)	0.914128
SAR 1g (W/Kg)	1.129937

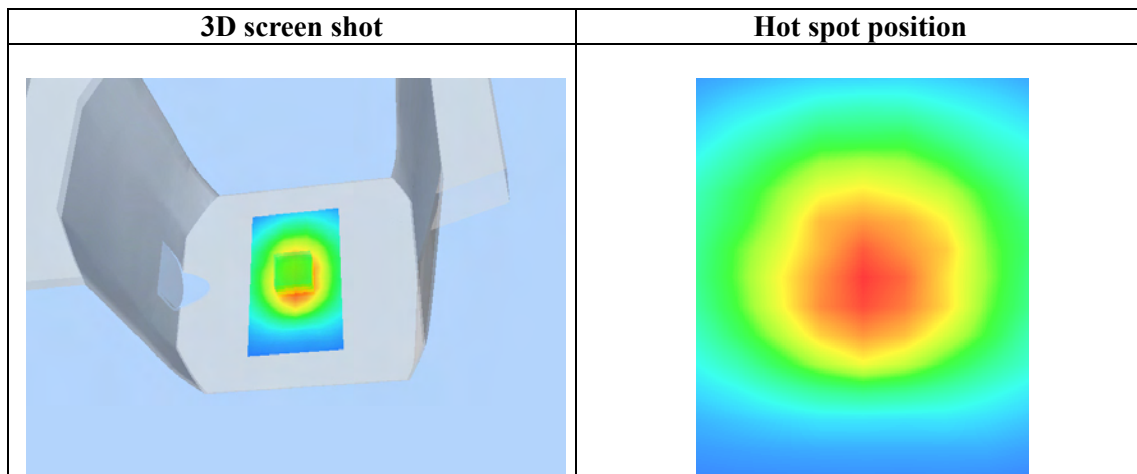
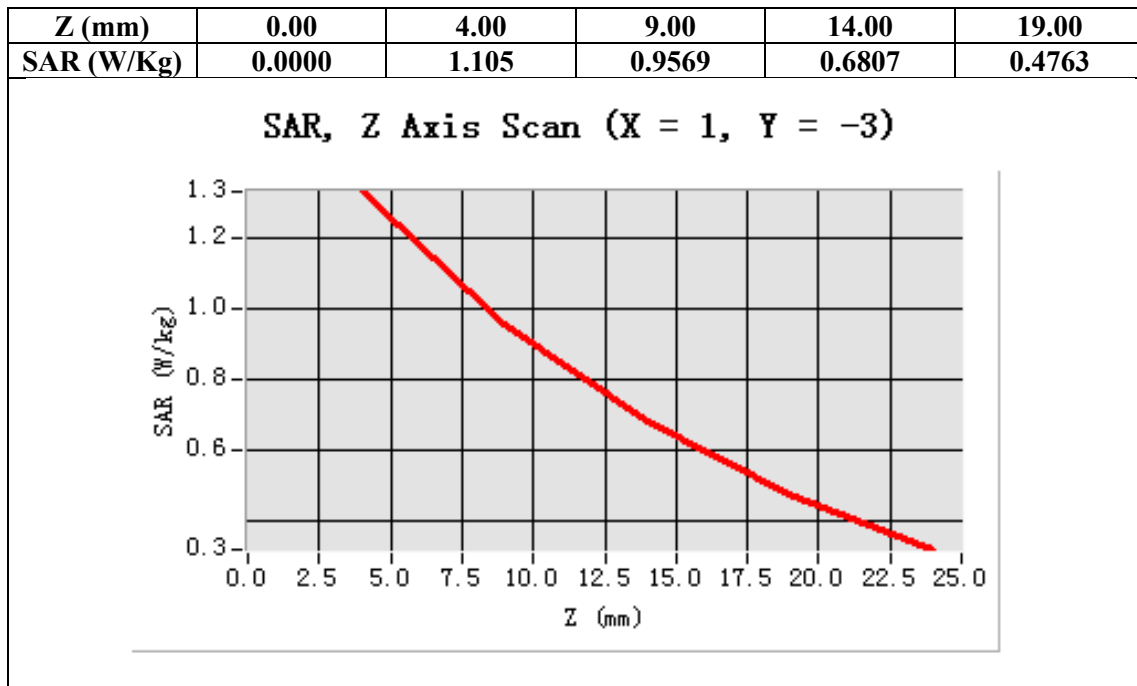

Test Laboratory: AGC Lab
WCDMA Band II High-Body-Towards Grounds (RMC)
DUT: Mobile Phone; Type: Profile

Date: Dec.06, 2013

Communication System: UMTS; Communication System Band: Band II UTRA/FDD ;Duty Cycle:1:1; ConvF=4.84
Frequency: 1907.6 MHz; Medium parameters used: $f = 1900$ MHz; $\sigma=1.49$ mho/m; $\epsilon_r =52.68$; $\rho= 1000$ kg/m³ ;
Phantom section: Flat Section
Ambient temperature (°C):21, Liquid temperature (°C):21

SATIMO Configuration:

Probe: EP165; Calibrated: 01/31/2013

- Sensor-Surface: 4mm (Mechanical Surface Detection)
- Phantom: Flat Phantom; Type: Elliptical Phantom
- Measurement SW: OpenSAR V4_02_01

Configuration/ WCDMA band II High-Body-back/Area Scan: Measurement grid: dx=8mm, dy=8mm
Configuration/ WCDMA band II High-Body-back/Zoom Scan: Measurement grid: dx=8mm, dy=8mm, dz=5m;

Area Scan	surf_sam_plan.txt
ZoomScan	5x5x7,dx=8mm dy=8mm dz=5mm,Very fast
Phantom	Validation plane
Device Position	Body Back
Band	WCDMA band II
Channels	High
Signal	TDMA (Crest factor: 1.0)

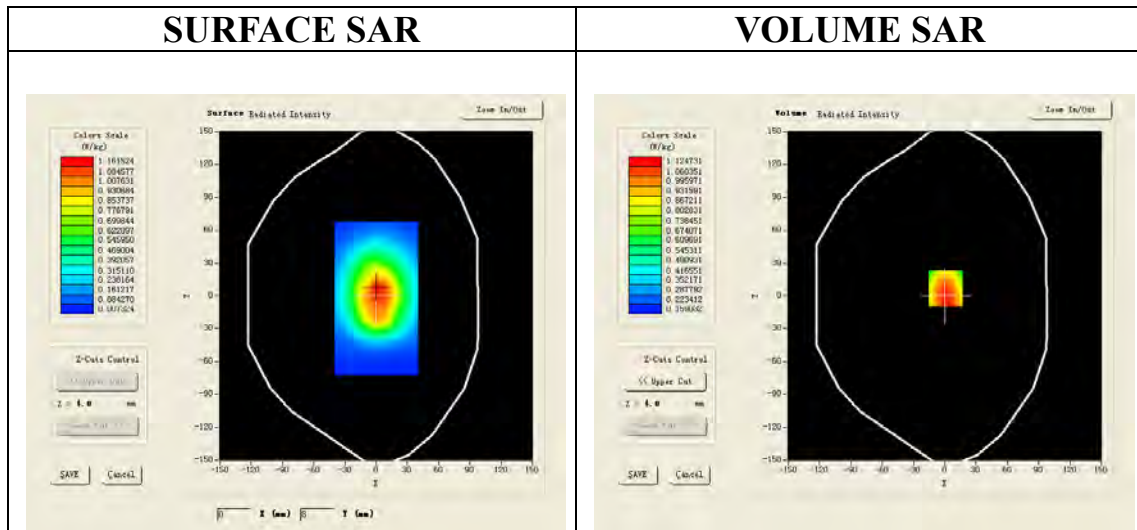

Maximum location: X=1.00, Y=7.00

SAR 10g (W/Kg)	0.786337
SAR 1g (W/Kg)	1.110284

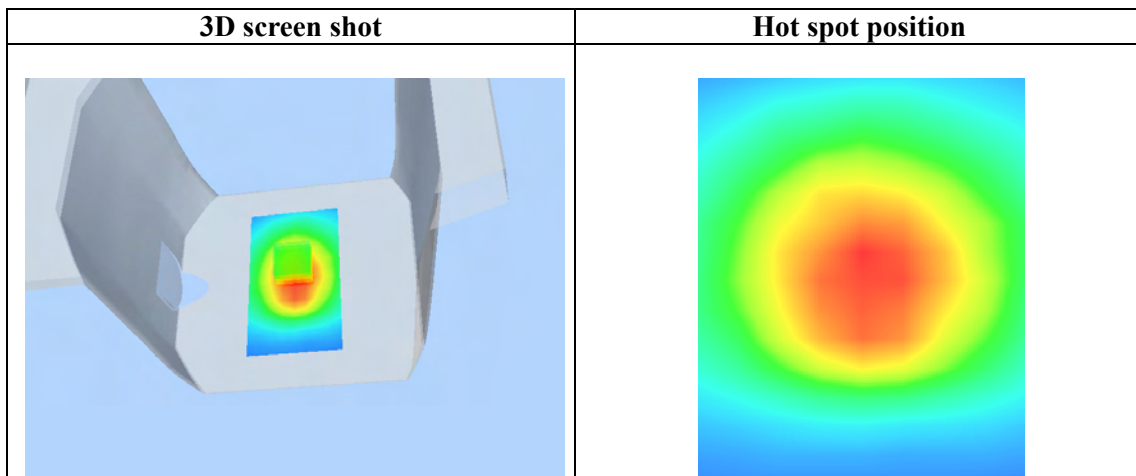
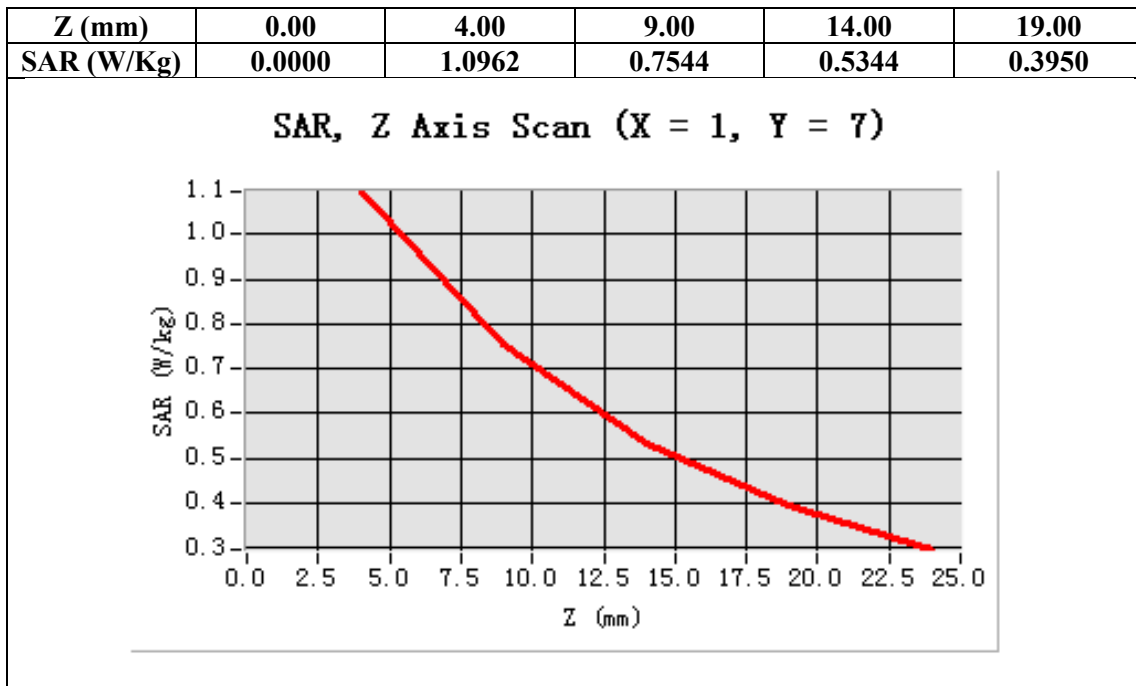

Test Laboratory: AGC Lab
WCDMA Band II Mid-Body-Towards Phantom (RMC)
DUT: Mobile Phone; Type: Profile

Date: Dec.06, 2013

Communication System: UMTS; Communication System Band: Band II UTRA/FDD ;Duty Cycle:1:1; ConvF=4.84
Frequency: 1880 MHz; Medium parameters used: $f = 1900$ MHz; $\sigma=1.49$ mho/m; $\epsilon_r = 52.68$; $\rho= 1000$ kg/m³ ;
Phantom section: Flat Section
Ambient temperature (°C):21, Liquid temperature (°C):21

SATIMO Configuration:

Probe: EP165; Calibrated: 01/31/2013

- Sensor-Surface: 4mm (Mechanical Surface Detection)
- Phantom: Flat Phantom; Type: Elliptical Phantom
- Measurement SW: OpenSAR V4_02_01

Configuration/ WCDMA band II Mid-Body-Front/Area Scan: Measurement grid: dx=8mm, dy=8mm
Configuration/ WCDMA band II Mid-Body-Front/Zoom Scan: Measurement grid: dx=8mm, dy=8mm, dz=5mm;

Area Scan	surf_sam_plan.txt
ZoomScan	5x5x7,dx=8mm dy=8mm dz=5mm,Very fast
Phantom	Validation plane
Device Position	Body Front
Band	WCDMA band II
Channels	Middle
Signal	TDMA (Crest factor: 1.0)

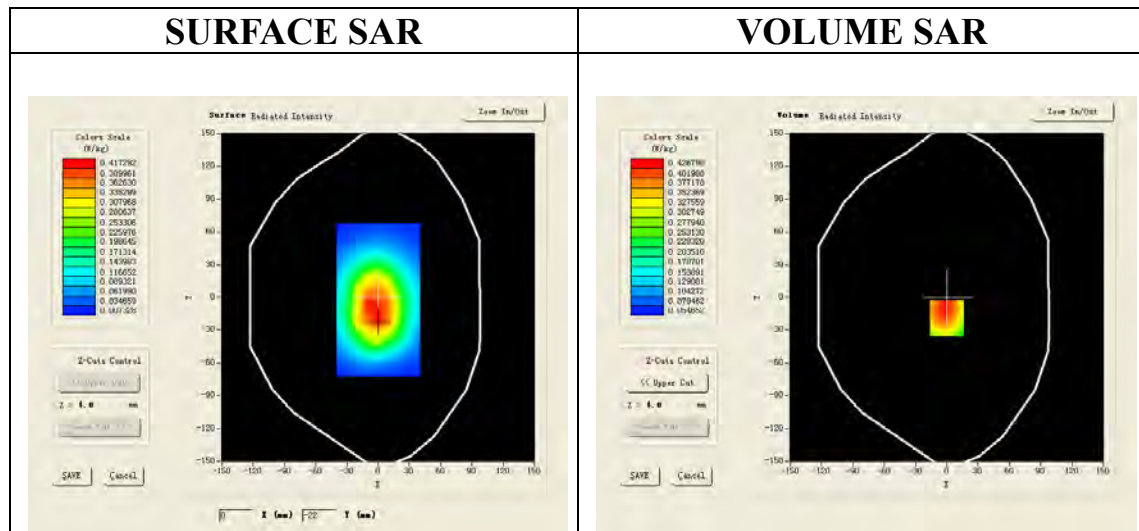

Maximum location: X=0.00, Y=-19.00

SAR 10g (W/Kg)	0.276271
SAR 1g (W/Kg)	0.410556

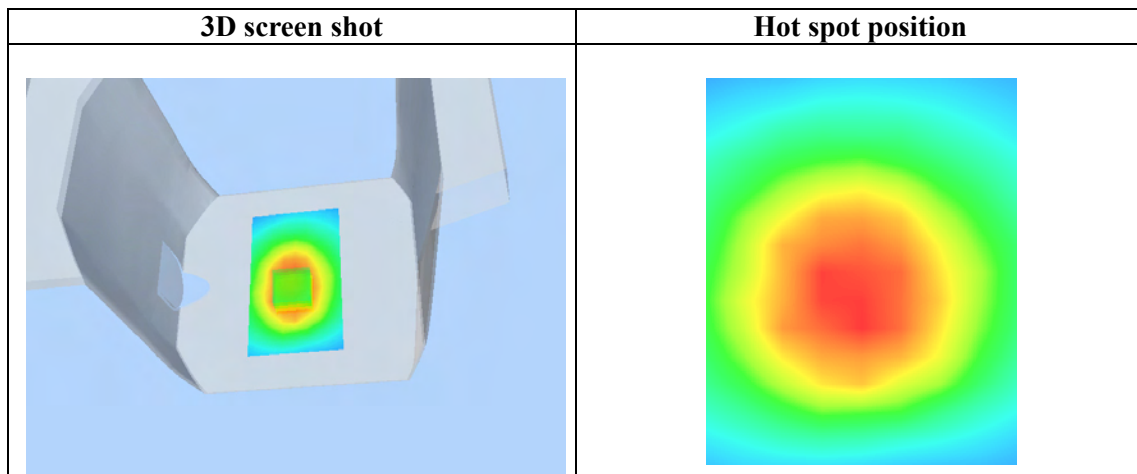
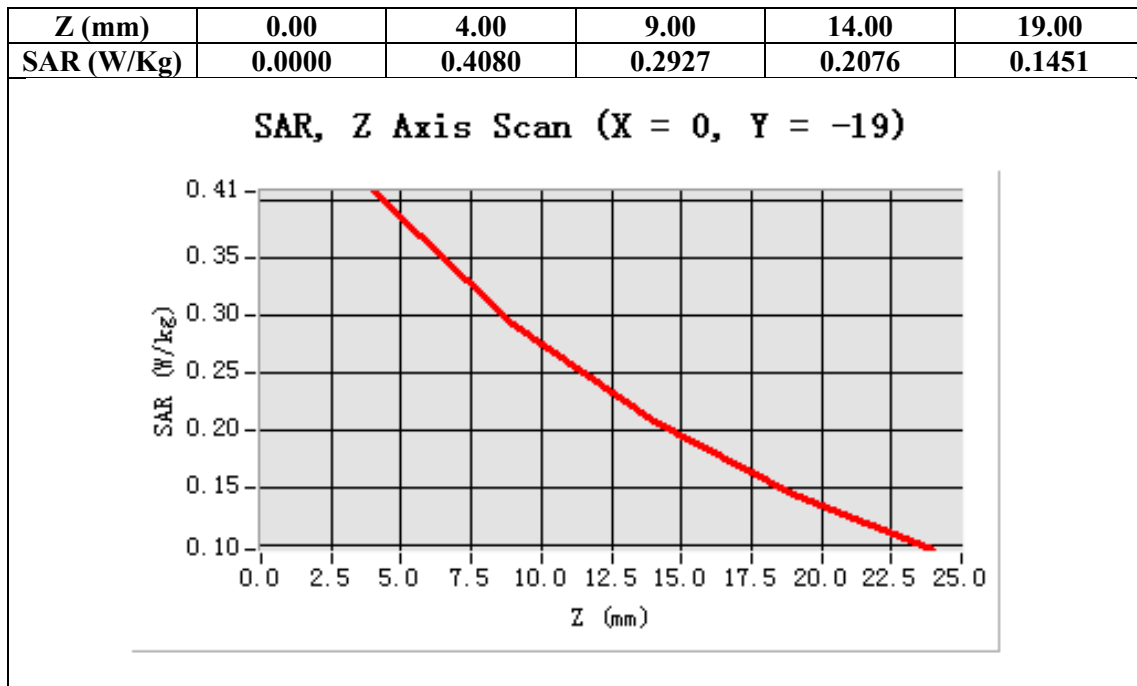

Test Laboratory: AGC Lab

Date: Dec.06, 2013

WCDMA Band V Mid-Touch-Left (RMC)

DUT: Mobile Phone; Type: Profile

Communication System: UMTS; Communication System Band: BAND V UTRA/FDD ; Duty Cycle:1: 1; Conv.F=5.30
Frequency: 835 MHz; Medium parameters used: $f = 835$ MHz; $\sigma=0.86$ mho/m; $\epsilon_r =40.55$; $\rho= 1000$ kg/m³ ;
Phantom section: Left Section
Ambient temperature (°C): 21, Liquid temperature (°C): 21

SATIMO Configuration:

Probe: EP165; Calibrated: 01/31/2013

- Sensor-Surface: 4mm (Mechanical Surface Detection)
- Phantom: Flat Phantom; Type: Elliptical Phantom
- Measurement SW: OpenSAR V4_02_01

Configuration/ WCDMA Band V Mid-Touch-Left/Area Scan (6x8x1): Measurement grid: dx=8mm, dy=8mm
Configuration/ WCDMA Band V Mid-Touch-Left/Zoom Scan (5x5x7)/Cube 0: Measurement grid: dx=8mm, dy=8mm, dz=5mm

Area Scan	sam_direct_droit2_surf8mm.txt
ZoomScan	5x5x7,dx=8mm dy=8mm dz=5mm,Very fast
Phantom	Left head
Device Position	Cheek
Band	WCDMA Band V
Channels	Middle
Signal	TDMA (Crest factor: 1.0)

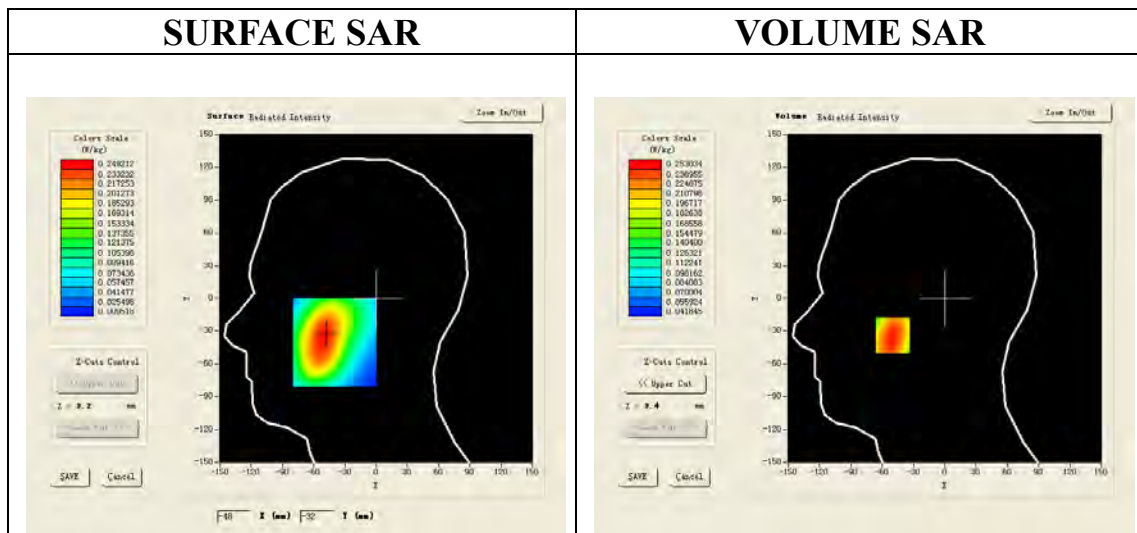

Maximum location: X=-50.00, Y=-34.00

SAR 10g (W/Kg)	0.168225
SAR 1g (W/Kg)	0.242674

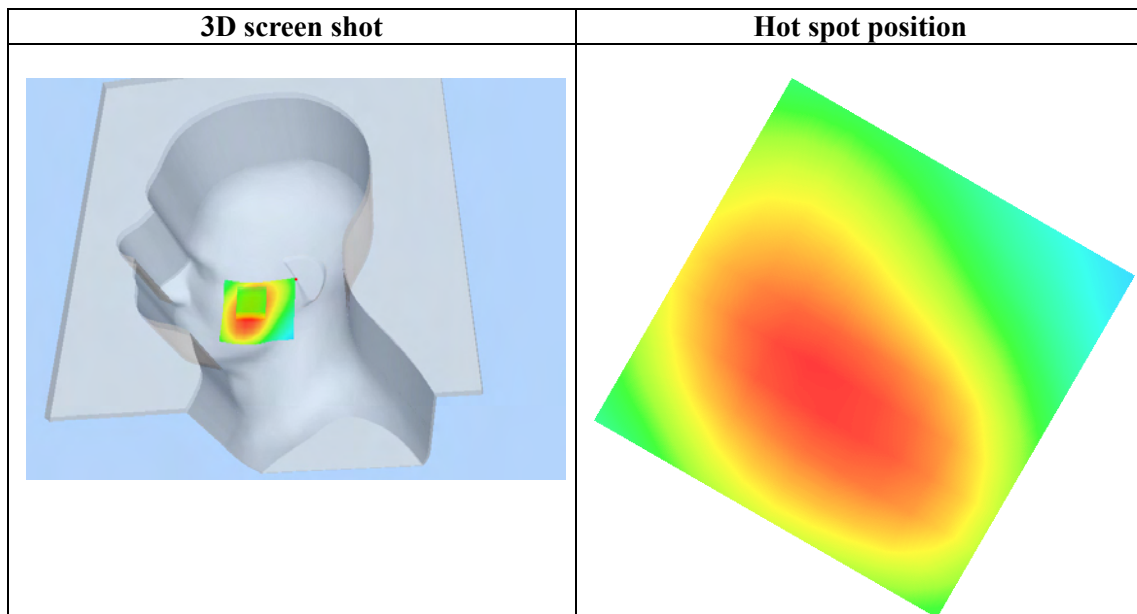
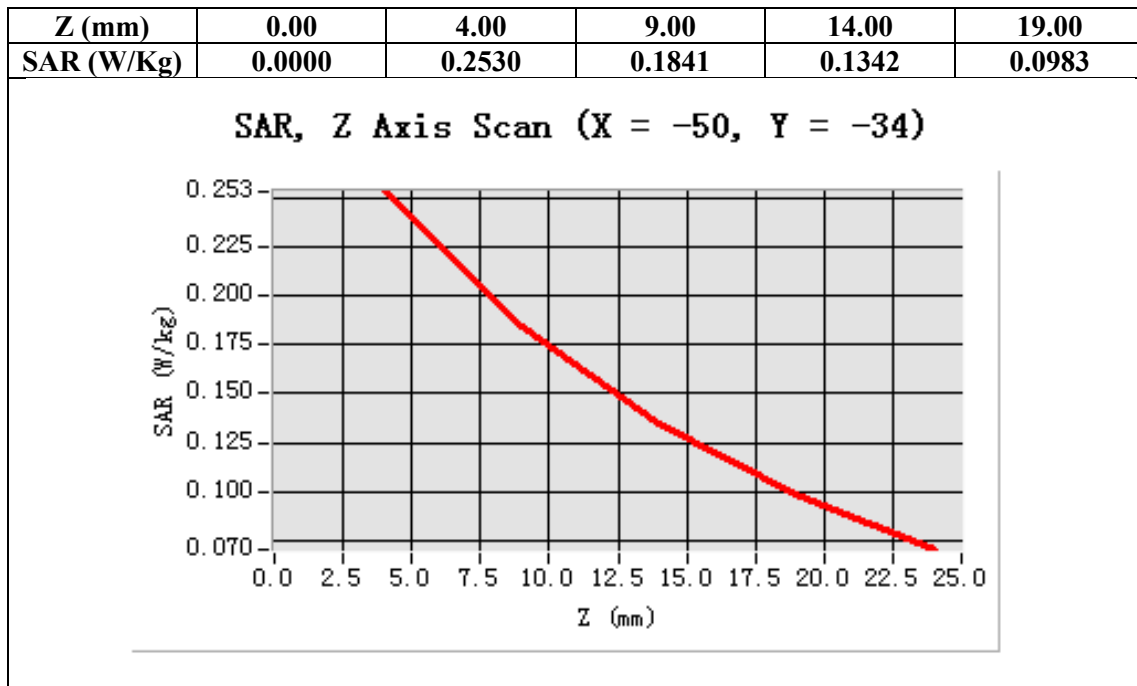

Test Laboratory: AGC Lab

Date: Dec.06, 2013

WCDMA Band V Mid-Tilt-Left (RMC)

DUT: Mobile Phone; Type: Profile

Communication System: UMTS; Communication System Band: BAND V UTRA/FDD ; Duty Cycle:1: 1; Conv.F=5.30
Frequency: 835 MHz; Medium parameters used: $f = 835$ MHz; $\sigma=0.86$ mho/m; $\epsilon_r =40.55$; $\rho= 1000$ kg/m³ ;
Phantom section: Left Section
Ambient temperature (°C): 21, Liquid temperature (°C): 21

SATIMO Configuration:

Probe: EP165; Calibrated: 01/31/2013

- Sensor-Surface: 4mm (Mechanical Surface Detection)
- Phantom: Flat Phantom; Type: Elliptical Phantom
- Measurement SW: OpenSAR V4_02_01

Configuration/ WCDMA Band V Mid-Tilt-Left/Area Scan (6x8x1): Measurement grid: dx=8mm, dy=8mm
Configuration/ WCDMA Band V Mid-Tilt-Left/Zoom Scan (5x5x7)/Cube 0: Measurement grid: dx=8mm, dy=8mm, dz=5mm;

Area Scan	sam_direct_droit2_surf8mm.txt
ZoomScan	5x5x7,dx=8mm dy=8mm dz=5mm,Very fast
Phantom	Left head
Device Position	Tilt
Band	WCDMA Band V
Channels	Middle
Signal	TDMA (Crest factor: 1.0)

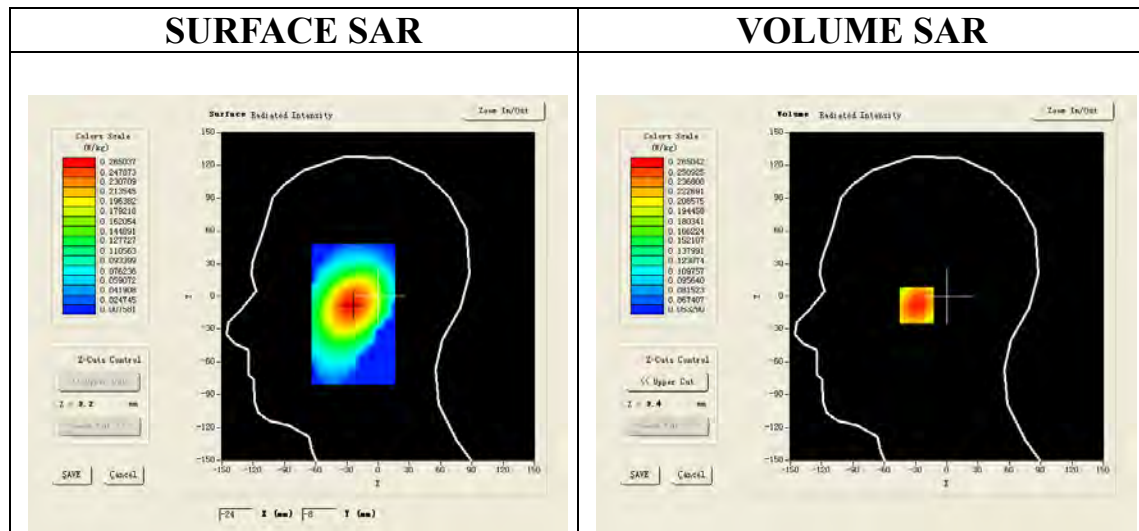

Maximum location: X=-26.00, Y=-8.00

SAR 10g (W/Kg)	0.182113
SAR 1g (W/Kg)	0.254225

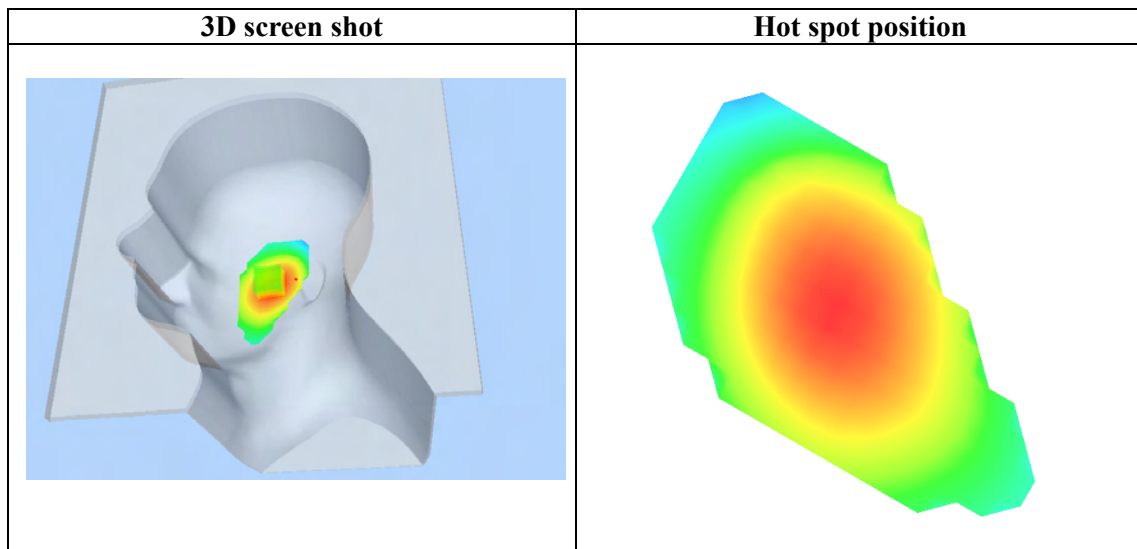
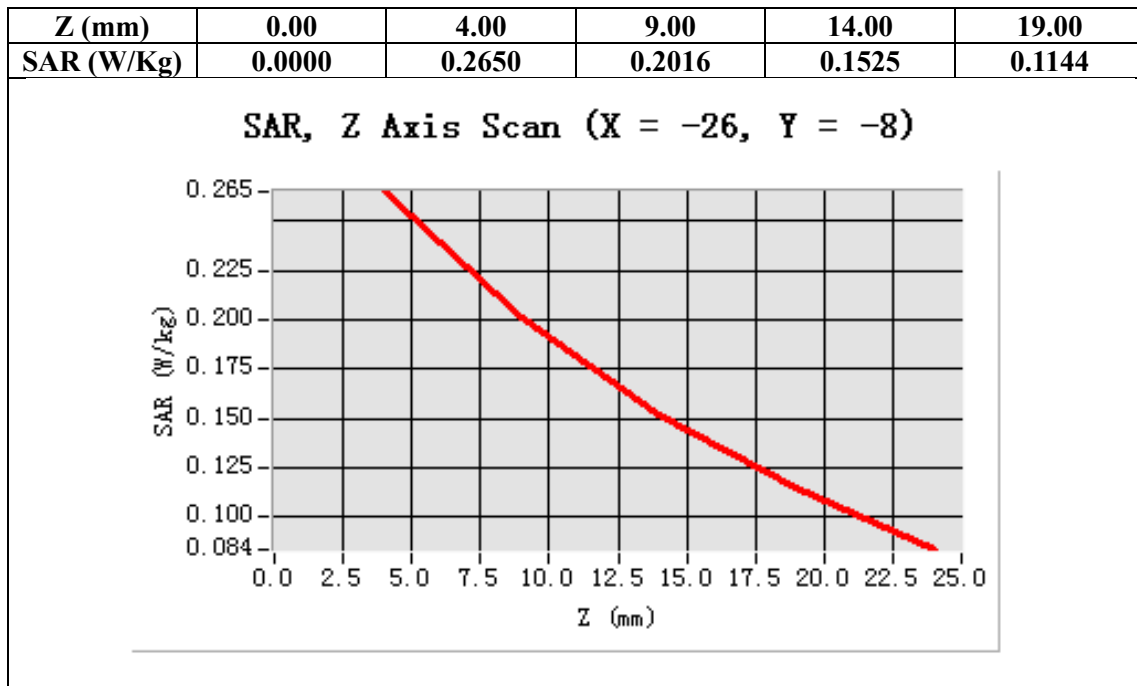

Test Laboratory: AGC Lab

Date: Dec.06, 2013

WCDMA Band V Mid-Touch-Right (RMC)

DUT: Mobile Phone; Type: Profile

Communication System: UMTS; Communication System Band: BAND V UTRA/FDD ; Duty Cycle:1: 1; Conv.F=5.30
Frequency: 835 MHz; Medium parameters used: $f = 835$ MHz; $\sigma=0.86$ mho/m; $\epsilon_r =40.55$; $\rho= 1000$ kg/m³ ;
Phantom section: Right Section
Ambient temperature (°C): 21, Liquid temperature (°C): 21

SATIMO Configuration:

Probe: EP165; Calibrated: 01/31/2013

- Sensor-Surface: 4mm (Mechanical Surface Detection)
- Phantom: Flat Phantom; Type: Elliptical Phantom
- Measurement SW: OpenSAR V4_02_01

Configuration/ WCDMA Band V Mid-Touch-Right/Area Scan: Measurement grid: dx=8mm, dy=8mm

Configuration/ WCDMA Band V Mid-Touch-Right/Zoom Scan: Measurement grid: dx=8mm, dy=8mm, dz=5mm;

Area Scan	sam_direct_droit2_surf8mm.txt
ZoomScan	5x5x7,dx=8mm dy=8mm dz=5mm,Very fast
Phantom	Right head
Device Position	Cheek
Band	WCDMA Band V
Channels	Middle
Signal	TDMA (Crest factor: 1.0)

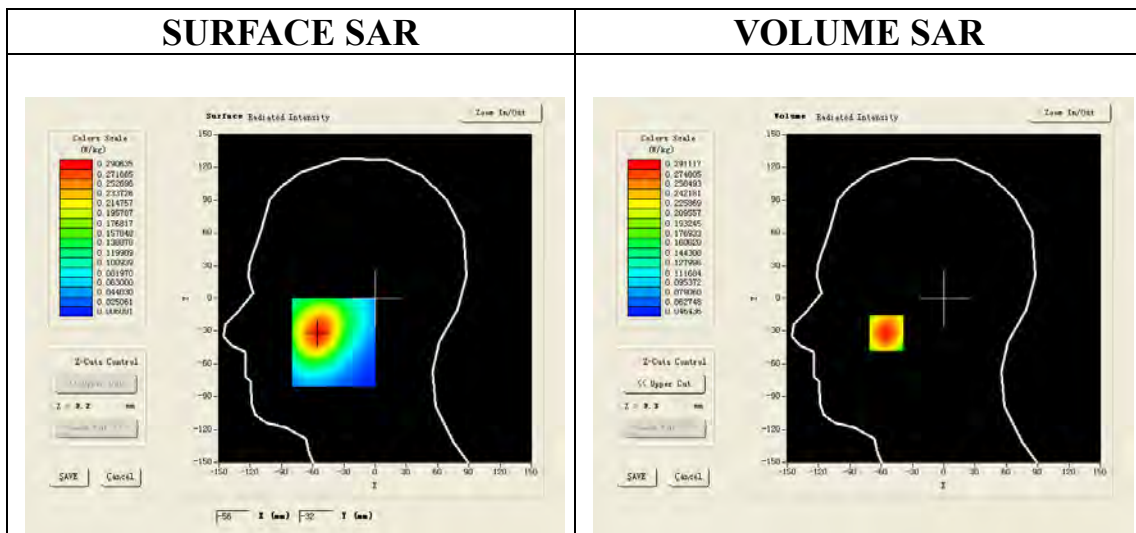

Maximum location: X=-55.00, Y=-32.00

SAR 10g (W/Kg)	0.192560
SAR 1g (W/Kg)	0.277584

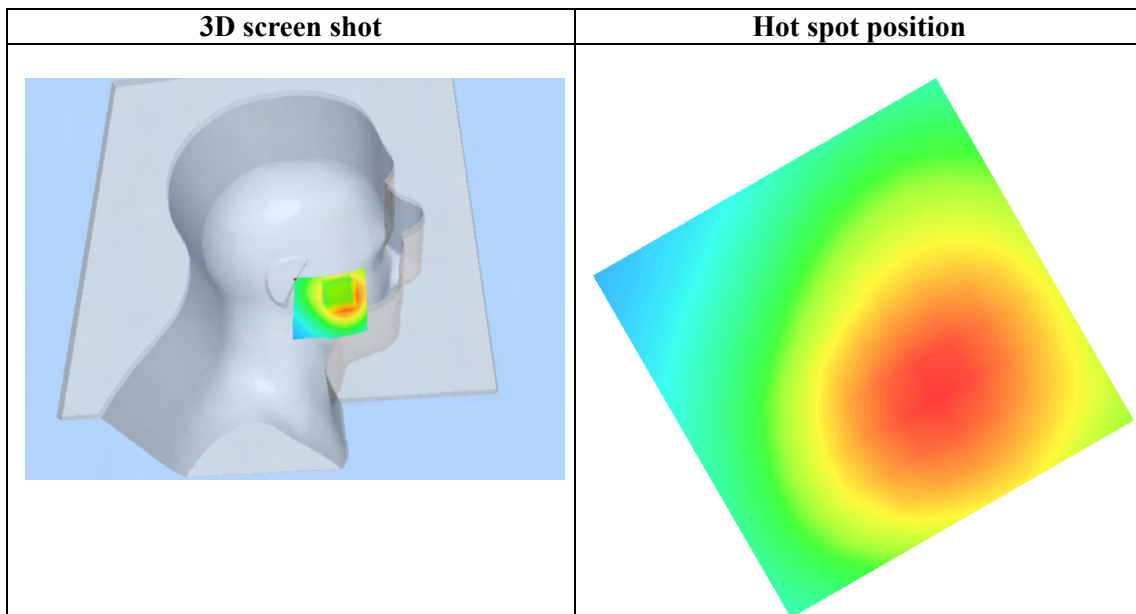
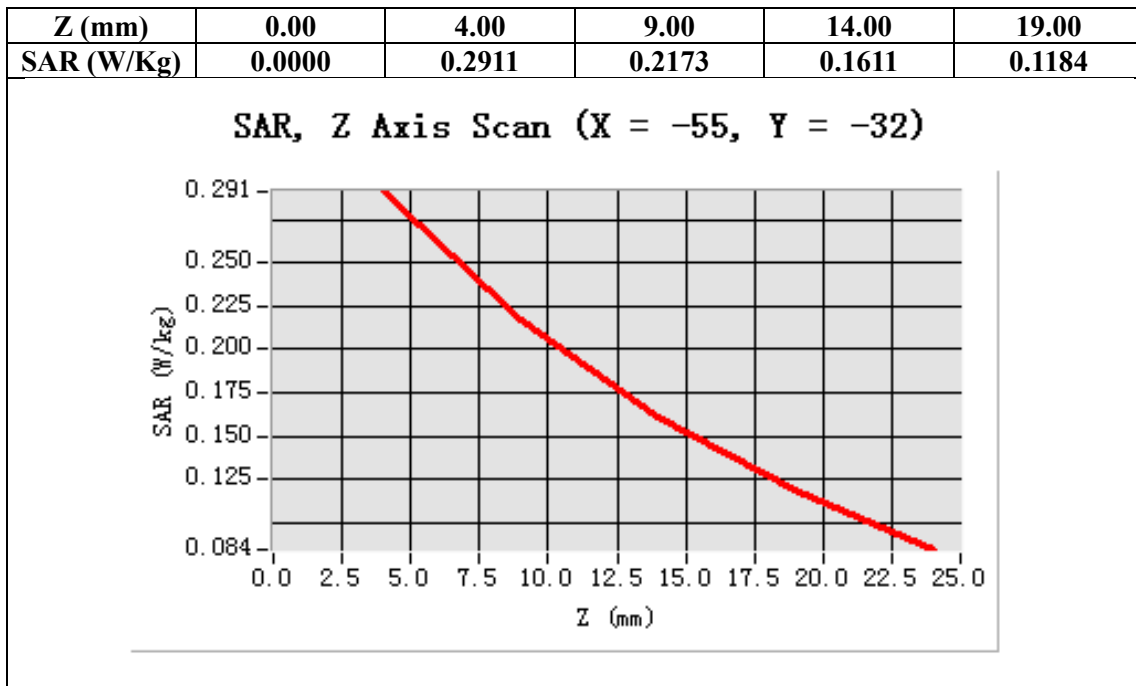

Test Laboratory: AGC Lab

Date: Dec.06, 2013

WCDMA Band V Mid-Tilt-Right (RMC)

DUT: Mobile Phone; Type: Profile

Communication System: UMTS; Communication System Band: BAND V UTRA/FDD ; Duty Cycle:1: 1; Conv.F=5.30
Frequency: 835 MHz; Medium parameters used: $f = 835$ MHz; $\sigma=0.86$ mho/m; $\epsilon_r =40.55$; $\rho= 1000$ kg/m³ ;
Phantom section: Right Section
Ambient temperature (°C): 21, Liquid temperature (°C): 21

SATIMO Configuration:

Probe: EP165; Calibrated: 01/31/2013

- Sensor-Surface: 4mm (Mechanical Surface Detection)
- Phantom: Flat Phantom; Type: Elliptical Phantom
- Measurement SW: OpenSAR V4_02_01

Configuration/ WCDMA Band V Mid-Tilt-Right/Area Scan: Measurement grid: dx=8mm, dy=8mm

Configuration/ WCDMA Band V Mid-Tilt-Right/Zoom Scan: Measurement grid: dx=8mm, dy=8mm, dz=5mm;

Area Scan	sam_direct_droit2_surf8mm.txt
Zoom Scan	5x5x7,dx=8mm dy=8mm dz=5mm,Very fast
Phantom	Right head
Device Position	Tilt
Band	WCDMA Band V
Channels	Middle
Signal	TDMA (Crest factor: 1.0)

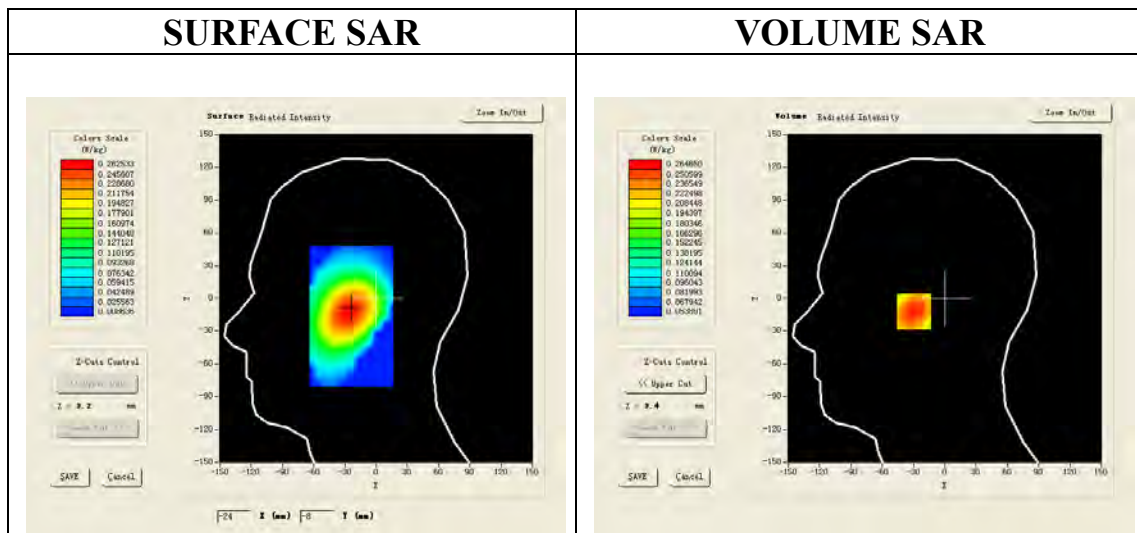

Maximum location: X=-26.00, Y=-12.00

SAR 10g (W/Kg)	0.181998
SAR 1g (W/Kg)	0.254098

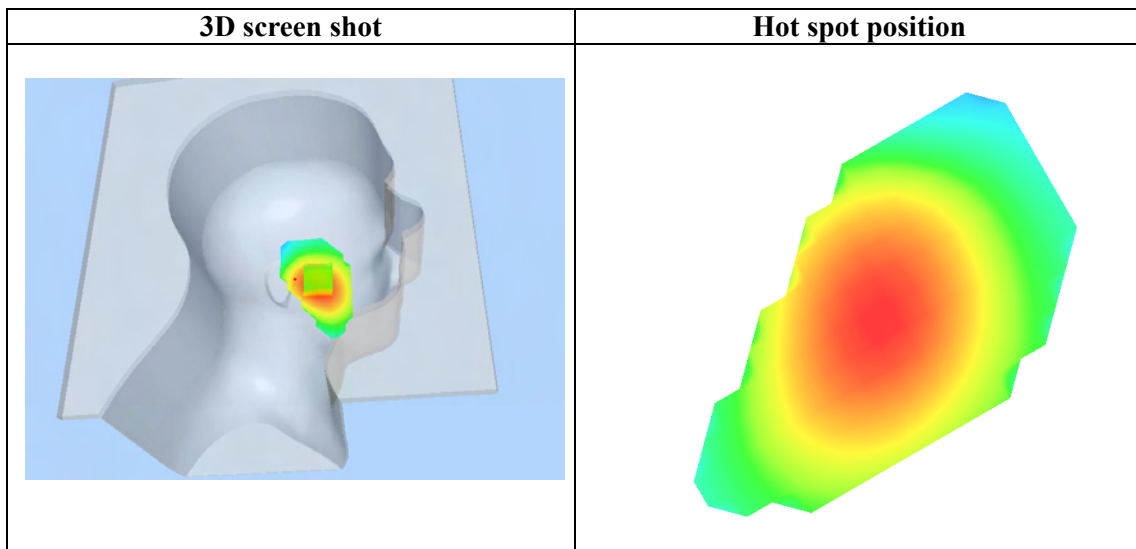
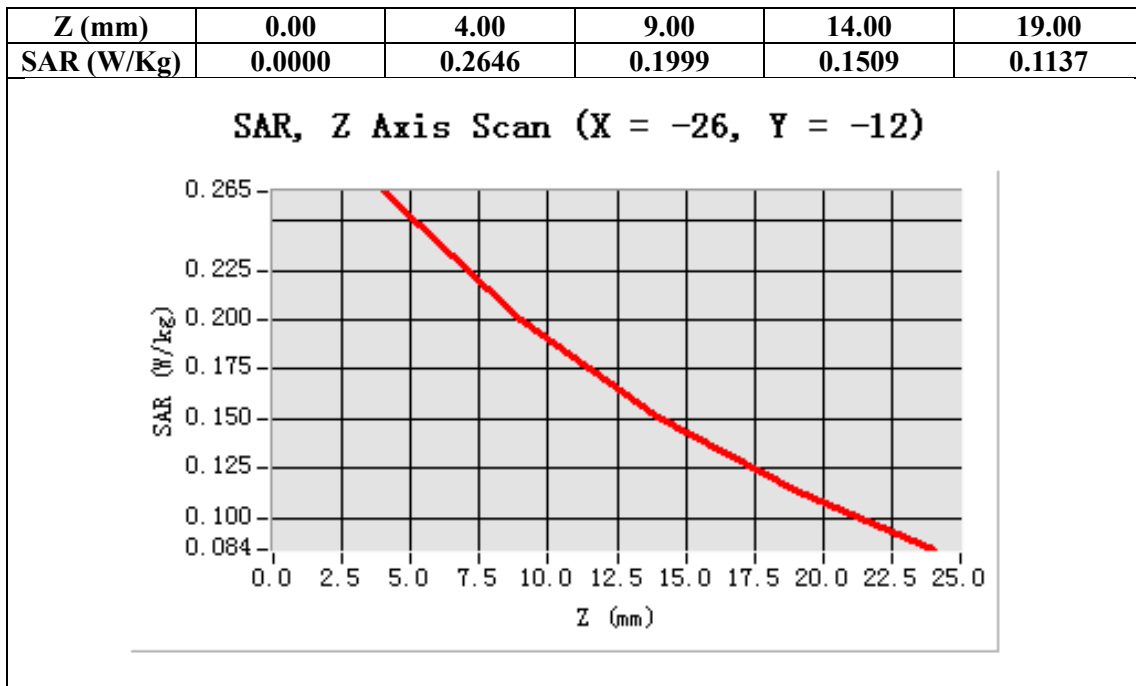

Test Laboratory: AGC Lab

Date: Dec.06, 2013

WCDMA Band V Low-Body-Towards Grounds (RMC)

DUT: Mobile Phone; Type: Profile

Communication System: UMTS; Communication System Band: BAND V UTRA/FDD; Duty Cycle:1: 1; Conv.F=5.46
Frequency: 826.4 MHz; Medium parameters used: $f = 835$ MHz; $\sigma = 0.94$ mho/m; $\epsilon_r = 53.88$; $\rho = 1000$ kg/m³ ;
Phantom section: Flat Section
Ambient temperature (°C):21, Liquid temperature (°C):21

SATIMO Configuration:

Probe: EP165; Calibrated: 01/31/2013

- Sensor-Surface: 4mm (Mechanical Surface Detection)
- Phantom: Flat Phantom; Type: Elliptical Phantom
- Measurement SW: OpenSAR V4_02_01

Configuration/ WCDMA Band V Low-Body-Back/Area Scan (6x8x1): Measurement grid: dx=8mm, dy=8mm
Configuration/ WCDMA Band V Low-Body-Back/Zoom Scan (5x5x7)/Cube 0: Measurement grid:
dx=8mm,dy=8mm, dz=5mm;

Area Scan	surf_sam_plan.txt
ZoomScan	5x5x7,dx=8mm dy=8mm dz=5mm,Very fast
Phantom	Validation plane
Device Position	Body Back
Band	WCDMA Band V
Channels	Low
Signal	TDMA (Crest factor: 1.0)

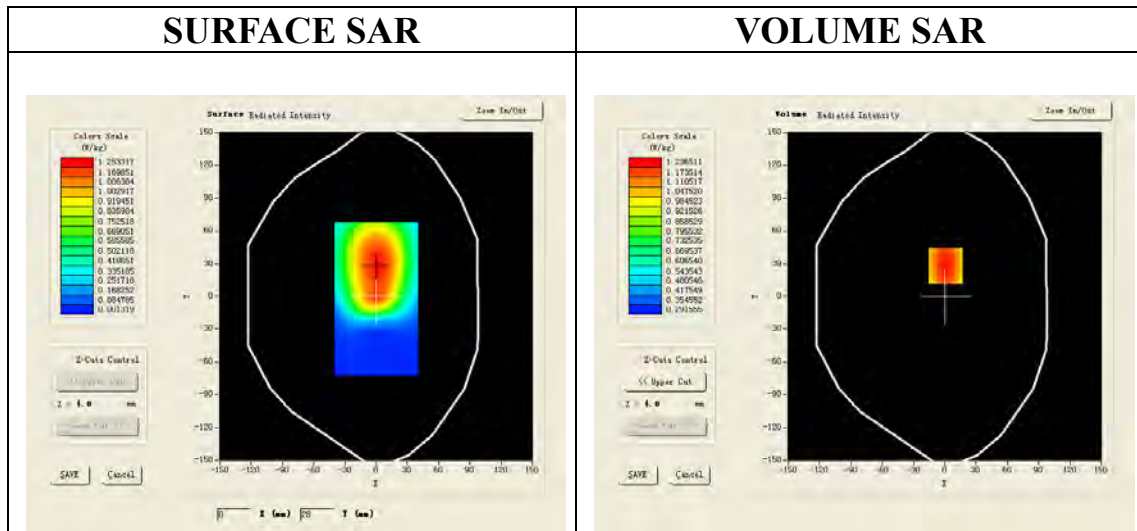

Maximum location: X=1.00, Y=28.00

SAR 10g (W/Kg)	0.858416
SAR 1g (W/Kg)	1.190638

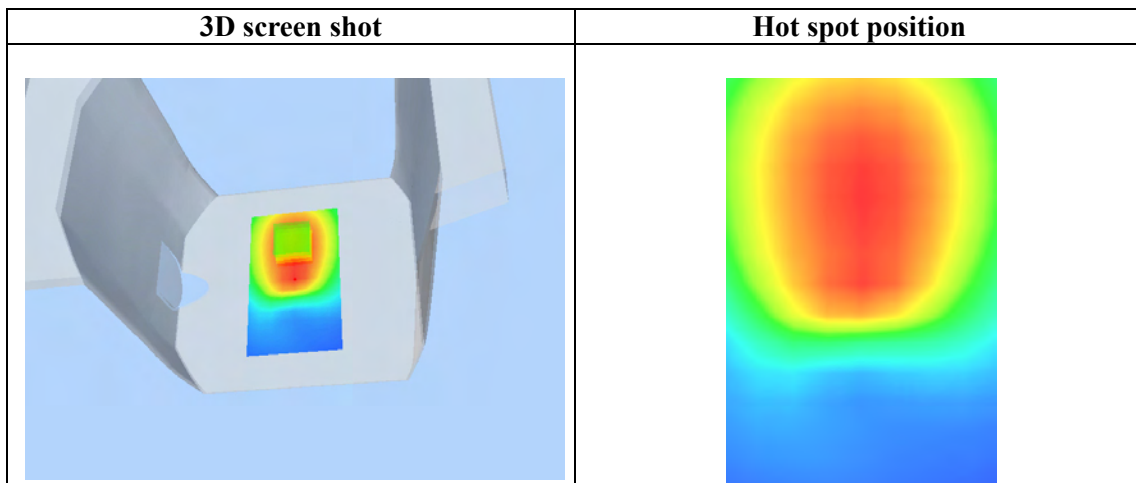
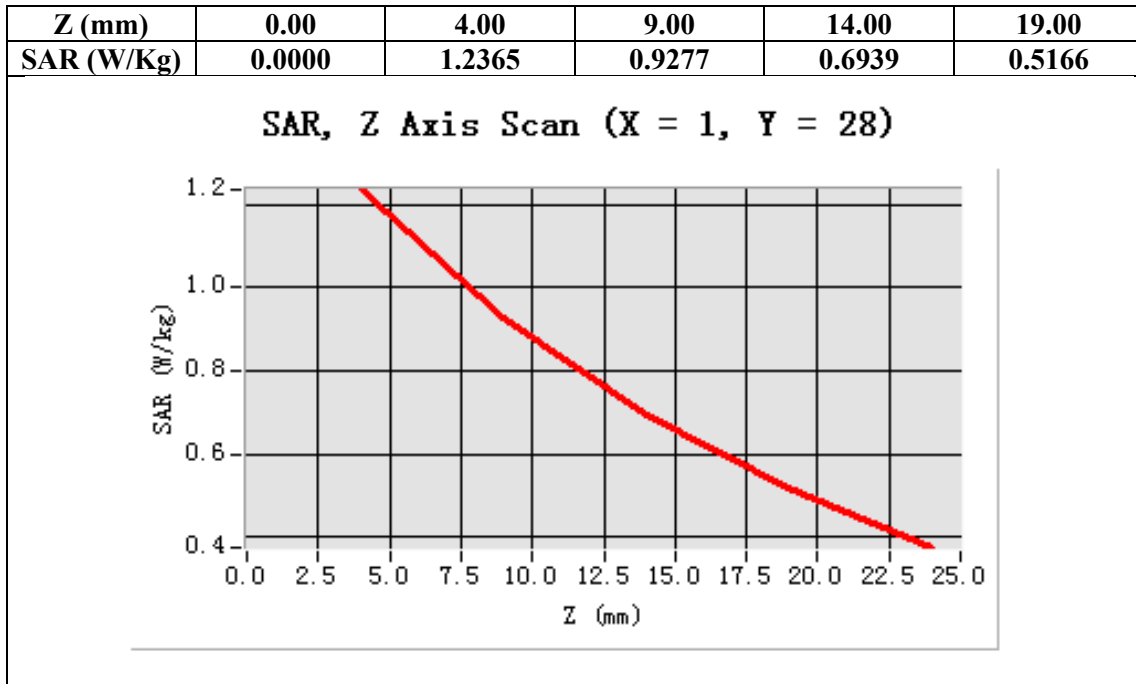

Test Laboratory: AGC Lab

Date: Dec.06, 2013

WCDMA Band V Mid-Body-Towards Grounds (RMC)

DUT: Mobile Phone; Type: Profile

Communication System: UMTS; Communication System Band: BAND V UTRA/FDD; Duty Cycle:1: 1; Conv.F=5.46
Frequency: 835 MHz; Medium parameters used: $f = 835$ MHz; $\sigma=0.94$ mho/m; $\epsilon_r = 53.88$; $\rho = 1000$ kg/m³ ;
Phantom section: Flat Section
Ambient temperature (°C):21, Liquid temperature (°C):21

SATIMO Configuration:

Probe: EP165; Calibrated: 01/31/2013

- Sensor-Surface: 4mm (Mechanical Surface Detection)
- Phantom: Flat Phantom; Type: Elliptical Phantom
- Measurement SW: OpenSAR V4_02_01

Configuration/ WCDMA Band V Mid-Body-Back/Area Scan (6x8x1): Measurement grid: dx=8mm, dy=8mm

Configuration/ WCDMA Band V Mid-Body-Back/Zoom Scan (5x5x7)/Cube 0: Measurement grid:
dx=8mm,dy=8mm, dz=5mm;

Area Scan	surf_sam_plan.txt
ZoomScan	5x5x7,dx=8mm dy=8mm dz=5mm,Very fast
Phantom	Validation plane
Device Position	Body Back
Band	WCDMA Band V
Channels	Middle
Signal	TDMA (Crest factor: 1.0)

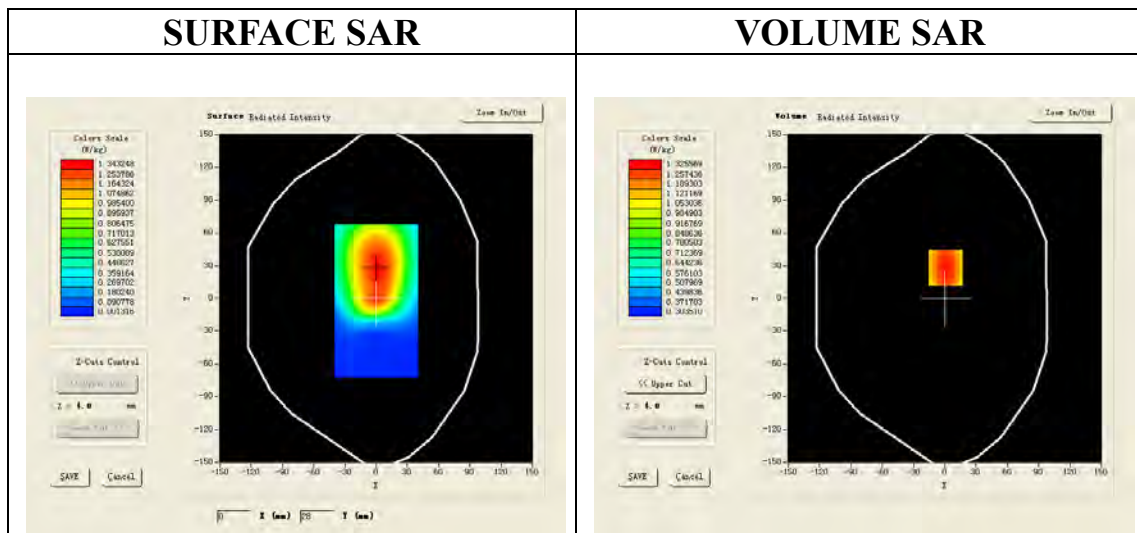

Maximum location: X=1.00, Y=28.00

SAR 10g (W/Kg)	0.913170
SAR 1g (W/Kg)	1.275909

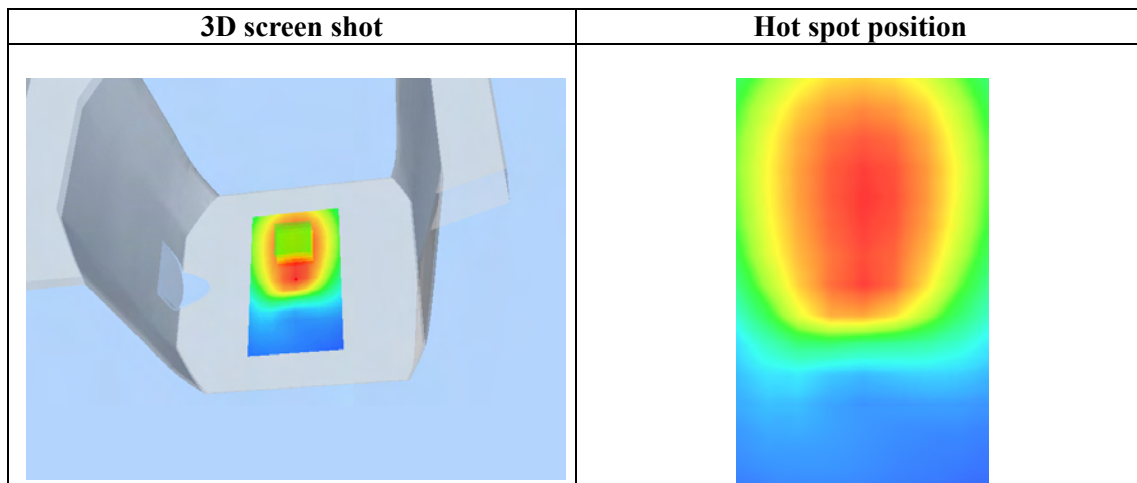
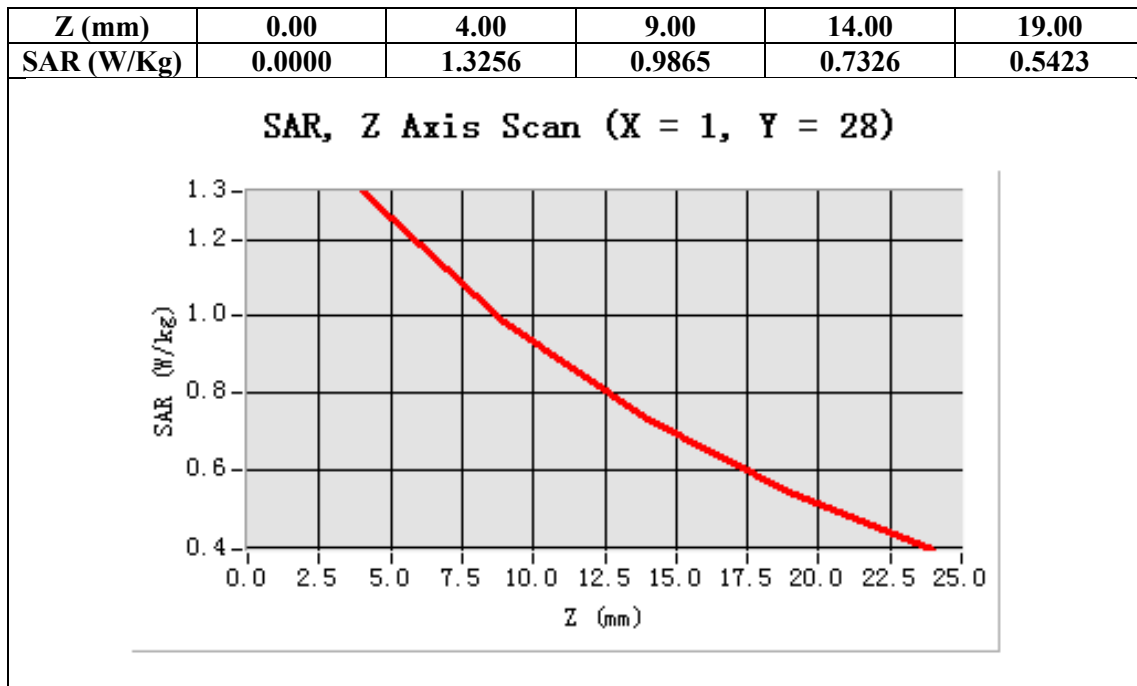

Test Laboratory: AGC Lab

Date: Dec.06, 2013

WCDMA Band V High-Body-Towards Grounds (RMC)

DUT: Mobile Phone; Type: Profile

Communication System: UMTS; Communication System Band: BAND V UTRA/FDD; Duty Cycle:1: 1; Conv.F=5.46
Frequency: 846.6 MHz; Medium parameters used: $f = 835$ MHz; $\sigma=0.94$ mho/m; $\epsilon_r = 53.88$; $\rho = 1000$ kg/m³ ;
Phantom section: Flat Section
Ambient temperature (°C):21, Liquid temperature (°C):21

SATIMO Configuration:

Probe: EP165; Calibrated: 01/31/2013

- Sensor-Surface: 4mm (Mechanical Surface Detection)
- Phantom: Flat Phantom; Type: Elliptical Phantom
- Measurement SW: OpenSAR V4_02_01

Configuration/ WCDMA Band V High-Body-Back/Area Scan (6x8x1): Measurement grid: dx=8mm, dy=8mm

Configuration/ WCDMA Band V High-Body-Back/Zoom Scan (5x5x7)/Cube 0: Measurement grid:
dx=8mm,dy=8mm, dz=5mm;

Area Scan	surf_sam_plan.txt
ZoomScan	5x5x7,dx=8mm dy=8mm dz=5mm,Very fast
Phantom	Validation plane
Device Position	Body Back
Band	WCDMA Band V
Channels	High
Signal	TDMA (Crest factor: 1.0)

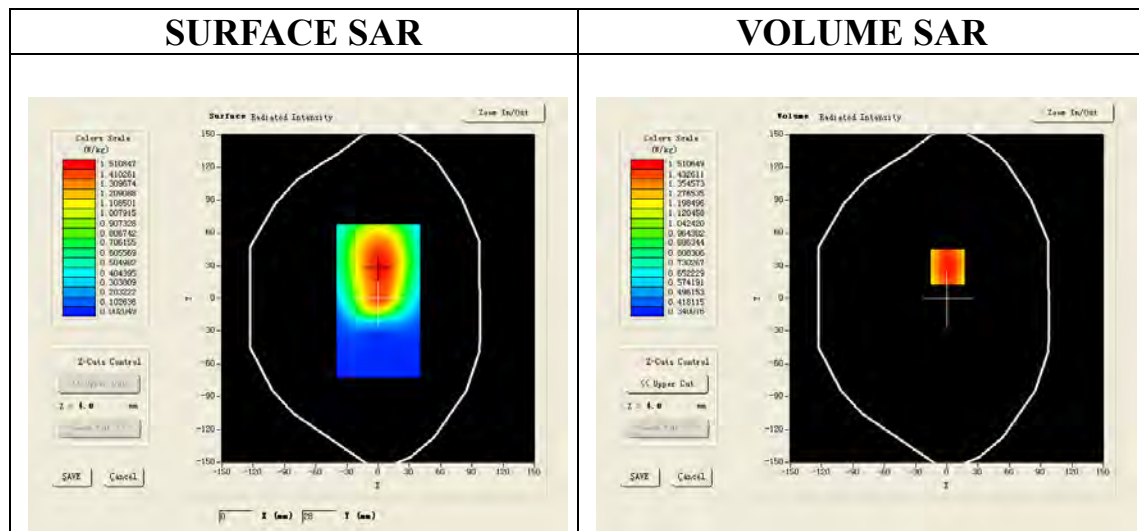

Maximum location: X=1.00, Y=29.00

SAR 10g (W/Kg)	0.982319
SAR 1g (W/Kg)	1.243203

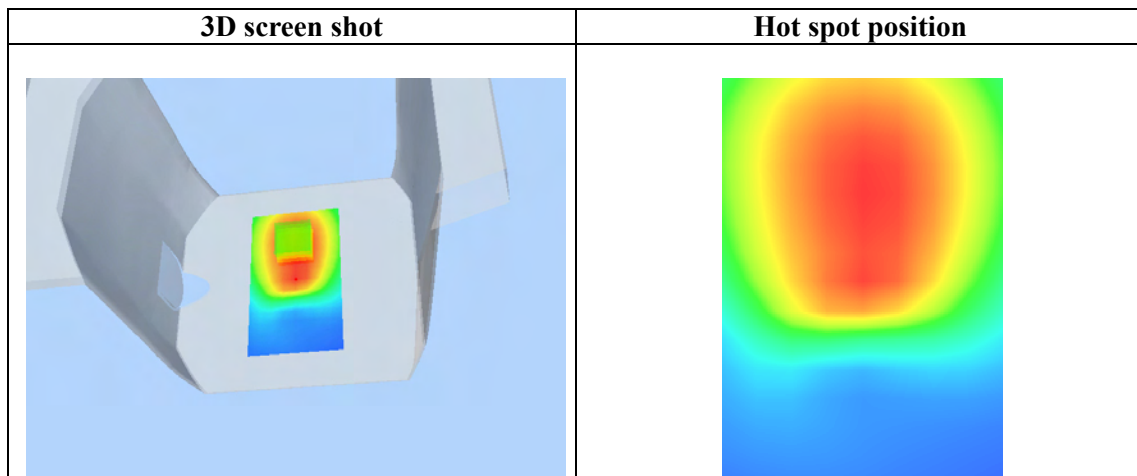
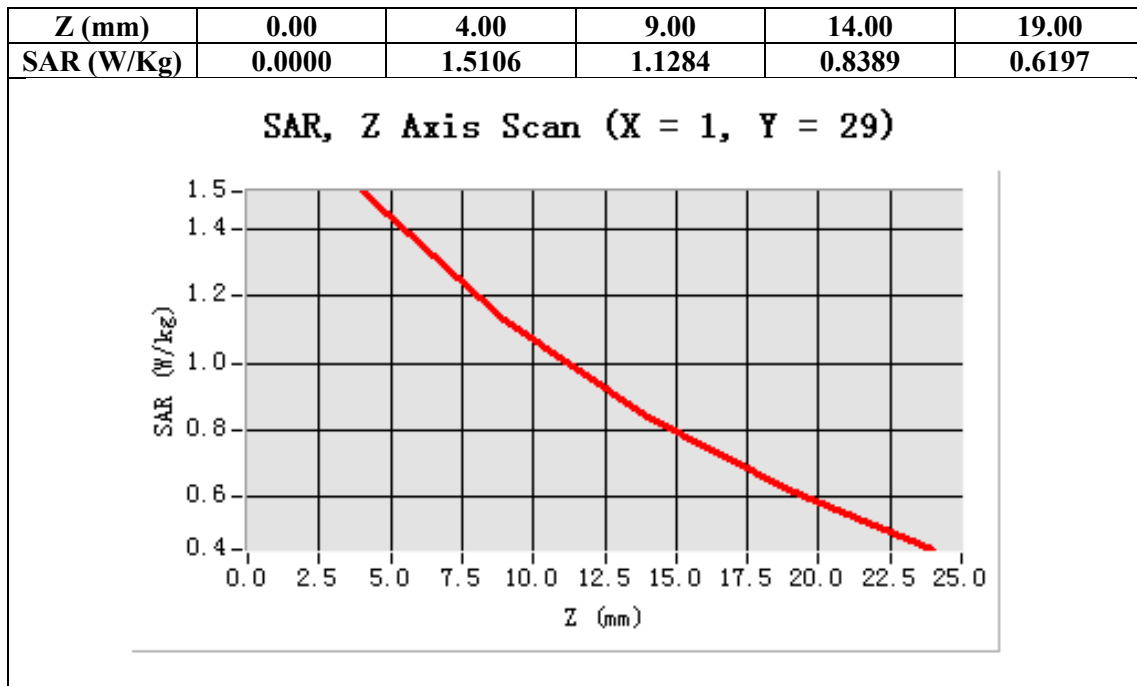

Test Laboratory: AGC Lab

Date: Dec.06, 2013

WCDMA Band V Mid- Body - Towards Phantom (RMC)

DUT: Mobile Phone; Type: Profile

Communication System: UMTS; Communication System Band: BAND V UTRA/FDD ; Duty Cycle:1: 1; Conv.F=5.46
Frequency: 835 MHz; Medium parameters used: f = 835 MHz; $\sigma=0.94$ mho/m; $\epsilon_r=53.88$; $\rho=1000$ kg/m³ ;
Phantom section: Flat Section
Ambient temperature (°C):21, Liquid temperature (°C):21

SATIMO Configuration:

Probe: EP165; Calibrated: 01/31/2013

- Sensor-Surface: 4mm (Mechanical Surface Detection)
- Phantom: Flat Phantom; Type: Elliptical Phantom
- Measurement SW: OpenSAR V4_02_01

Configuration/ WCDMA Band V Mid-Body-Front /Area Scan (6x8x1): Measurement grid: dx=8mm, dy=8mm
Configuration/ WCDMA Band V Mid-Body-Front /Zoom Scan (5x5x7)/Cube 0: Measurement grid: dx=8mm, dy=8mm, dz=5mm;

Area Scan	surf_sam_plan.txt
ZoomScan	5x5x7,dx=8mm dy=8mm dz=5mm,Very fast
Phantom	Validation plane
Device Position	Body Front
Band	WCDMA Band V
Channels	Middle
Signal	TDMA (Crest factor: 1.0)

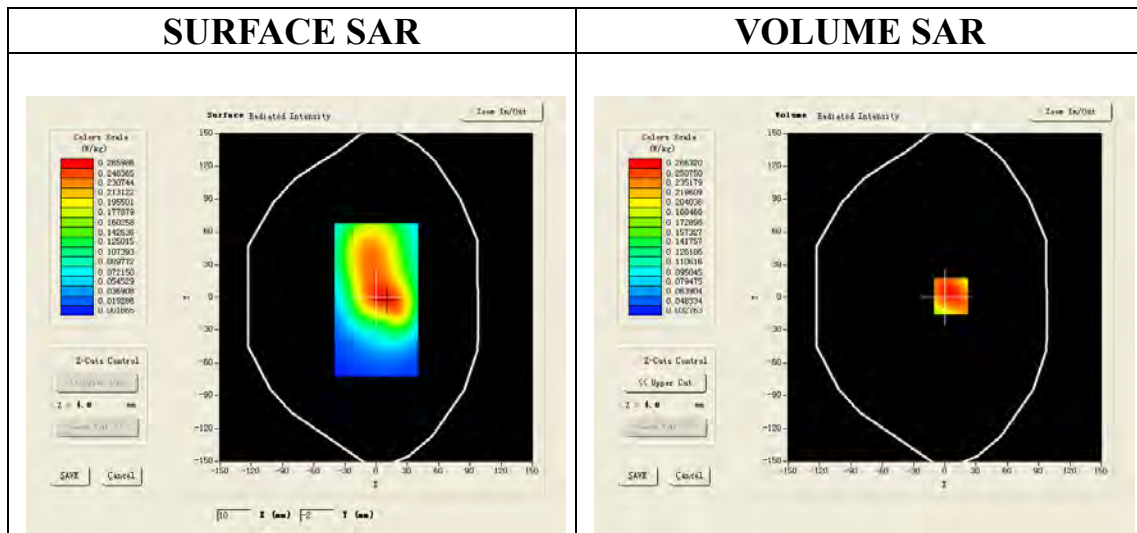

Maximum location: X=6.00, Y=1.00

SAR 10g (W/Kg)	0.167243
SAR 1g (W/Kg)	0.255951

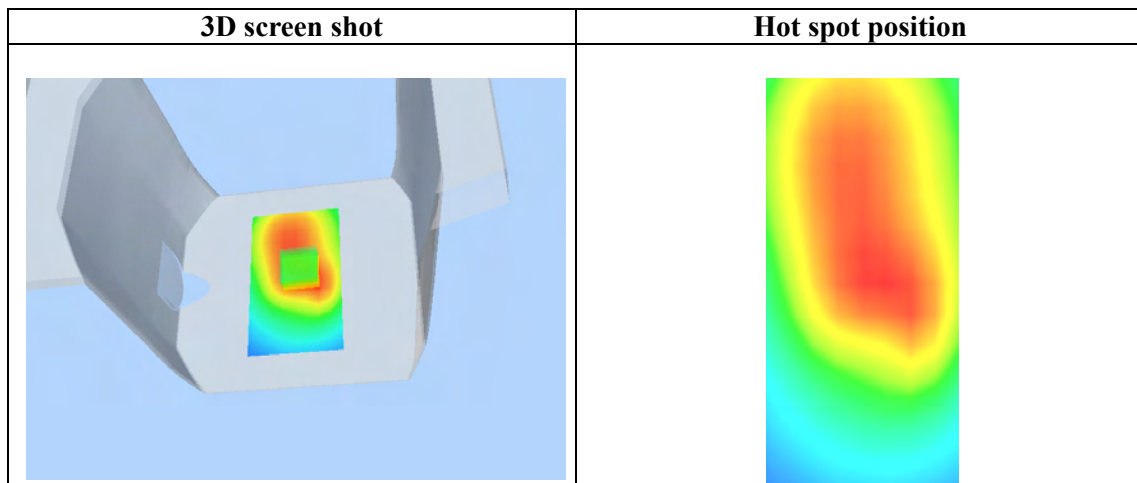
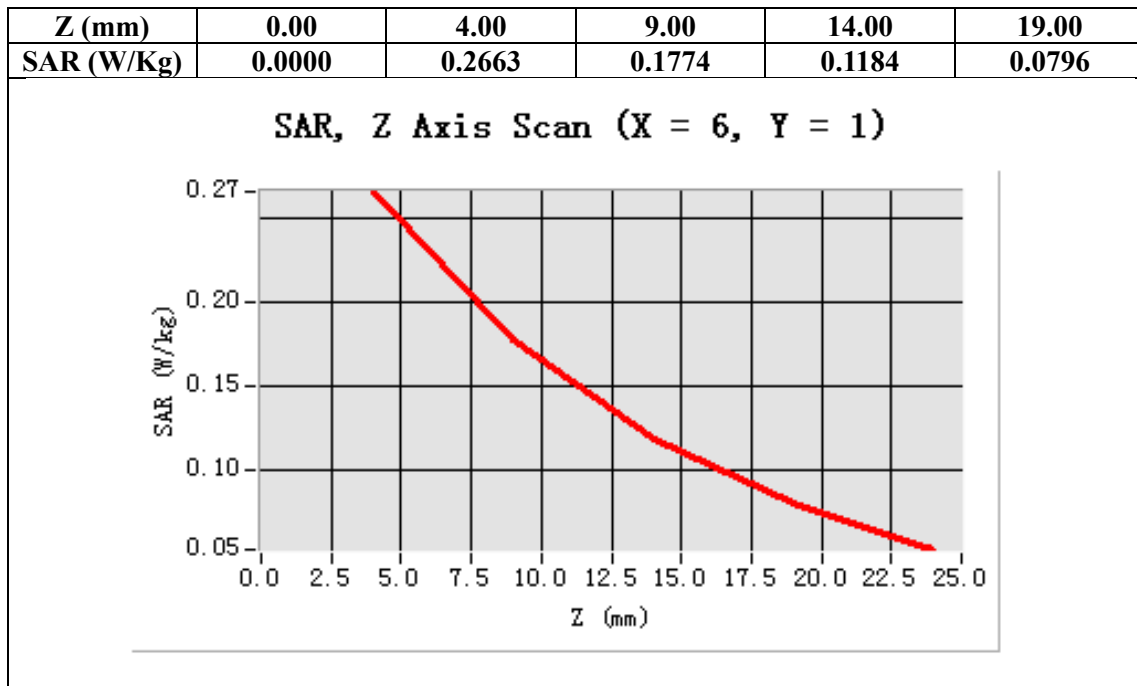

Test Laboratory: AGC Lab

Date: Dec.06, 2013

WCDMA Band V Low- Body - Towards Grounds (HSPA)-with earphone

DUT: Mobile Phone; Type: Profile

Communication System: UMTS; Communication System Band: BAND V UTRA/FDD ; Duty Cycle:1: 1; Conv.F=5.46
Frequency: 826.4 MHz; Medium parameters used: f = 835 MHz; $\sigma=0.94$ mho/m; $\epsilon_r=53.88$; $\rho=1000\text{kg/m}^3$;
Phantom section: Flat Section
Ambient temperature ($^{\circ}\text{C}$):21, Liquid temperature ($^{\circ}\text{C}$):21

SATIMO Configuration:

Probe: EP165; Calibrated: 01/31/2013

- Sensor-Surface: 4mm (Mechanical Surface Detection)
- Phantom: Flat Phantom; Type: Elliptical Phantom
- Measurement SW: OpenSAR V4_02_01

Configuration/ WCDMA Band V Low-Body- Back /Area Scan (6x8x1): Measurement grid: dx=8mm, dy=8mm
Configuration/ WCDMA Band V Low-Body- Back /Zoom Scan (5x5x7)/Cube 0: Measurement grid: dx=8mm, dy=8mm, dz=5mm;

Area Scan	surf_sam_plan.txt
ZoomScan	5x5x7,dx=8mm dy=8mm dz=5mm,Very fast
Phantom	Validation plane
Device Position	Body Back
Band	WCDMA Band V
Channels	Low
Signal	TDMA (Crest factor: 1.0)

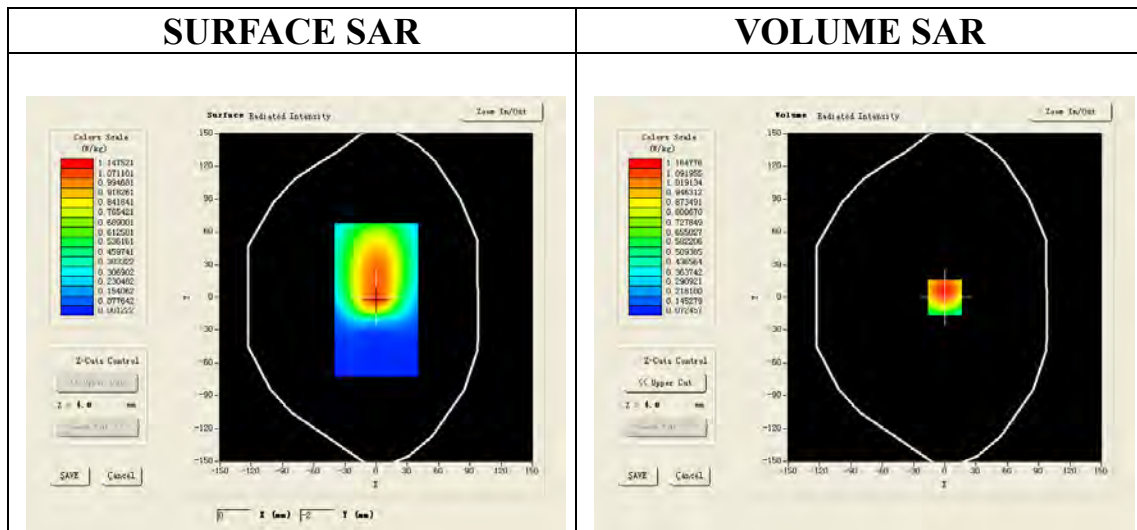

Maximum location: X=0.00, Y=0.00

SAR 10g (W/Kg)	0.701360
SAR 1g (W/Kg)	1.112995

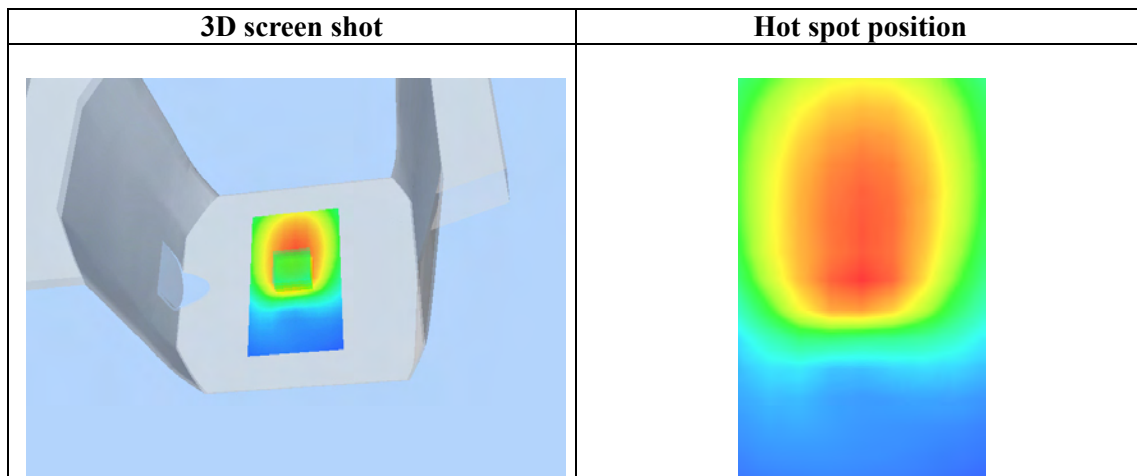
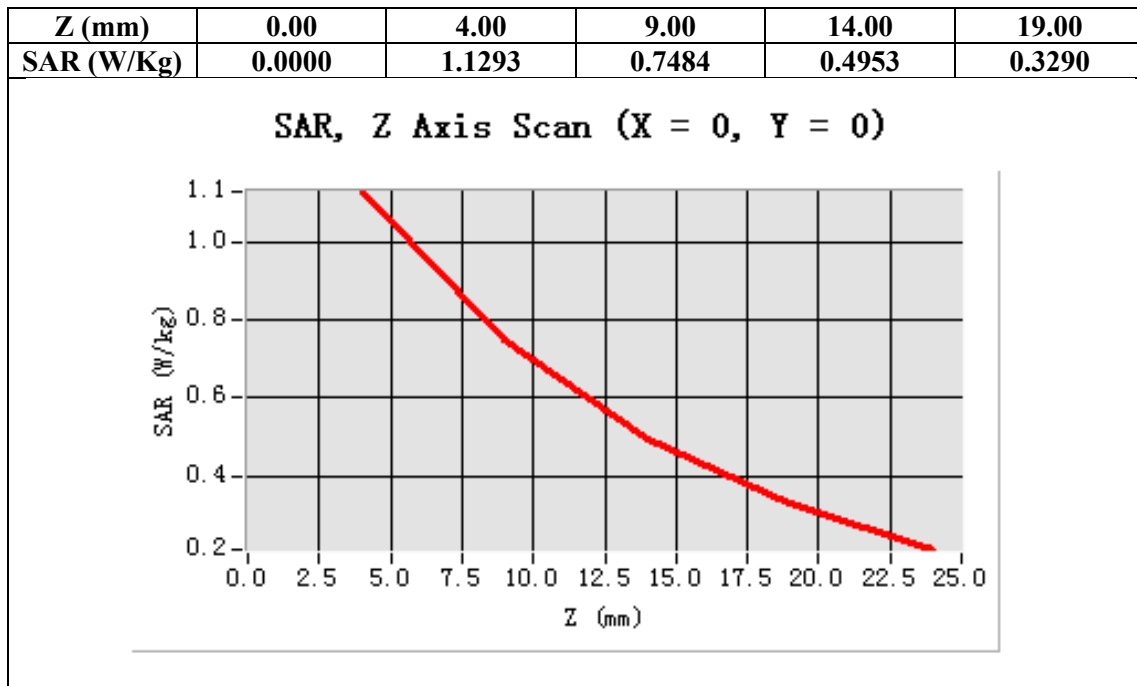

Test Laboratory: AGC Lab

Date: Dec.06, 2013

WCDMA Band V Mid- Body - Towards Grounds (HSPA)-with earphone

DUT: Mobile Phone; Type: Profile

Communication System: UMTS; Communication System Band: BAND V UTRA/FDD ; Duty Cycle:1: 1; Conv.F=5.46
Frequency: 835 MHz; Medium parameters used: $f = 835$ MHz; $\sigma=0.94$ mho/m; $\epsilon_r = 53.88$; $\rho = 1000$ kg/m³ ;
Phantom section: Flat Section
Ambient temperature (°C):21, Liquid temperature (°C):21

SATIMO Configuration:

Probe: EP165; Calibrated: 01/31/2013

- Sensor-Surface: 4mm (Mechanical Surface Detection)
- Phantom: Flat Phantom; Type: Elliptical Phantom
- Measurement SW: OpenSAR V4_02_01

Configuration/ WCDMA Band V Mid-Body- Back /Area Scan (6x8x1): Measurement grid: dx=8mm, dy=8mm
Configuration/ WCDMA Band V Mid-Body- Back /Zoom Scan (5x5x7)/Cube 0: Measurement grid: dx=8mm, dy=8mm, dz=5mm;

Area Scan	surf_sam_plan.txt
ZoomScan	5x5x7,dx=8mm dy=8mm dz=5mm,Very fast
Phantom	Validation plane
Device Position	Body Back
Band	WCDMA Band V
Channels	Middle
Signal	TDMA (Crest factor: 1.0)

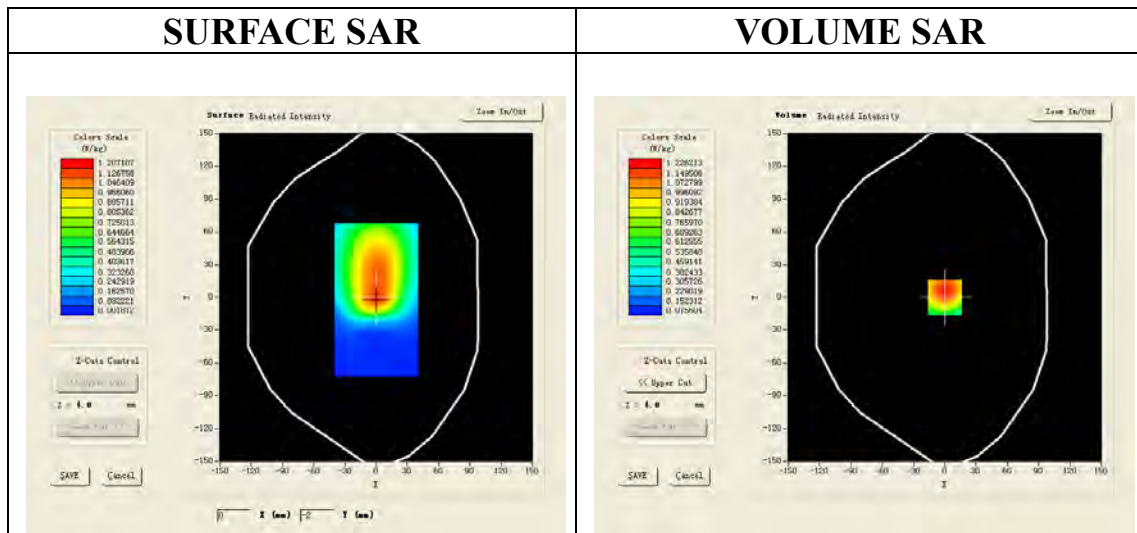

Maximum location: X=0.00, Y=0.00

SAR 10g (W/Kg)	0.734884
SAR 1g (W/Kg)	1.171752

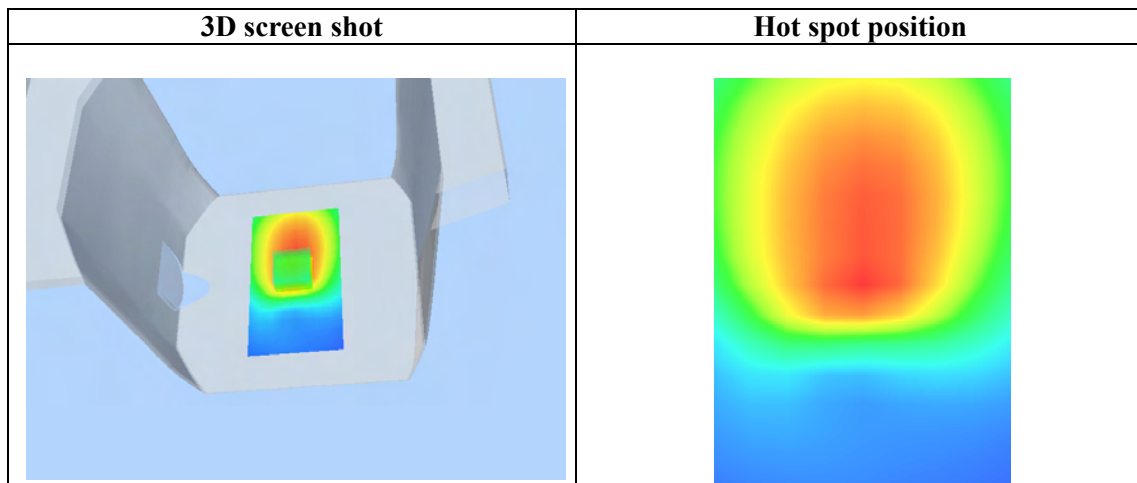
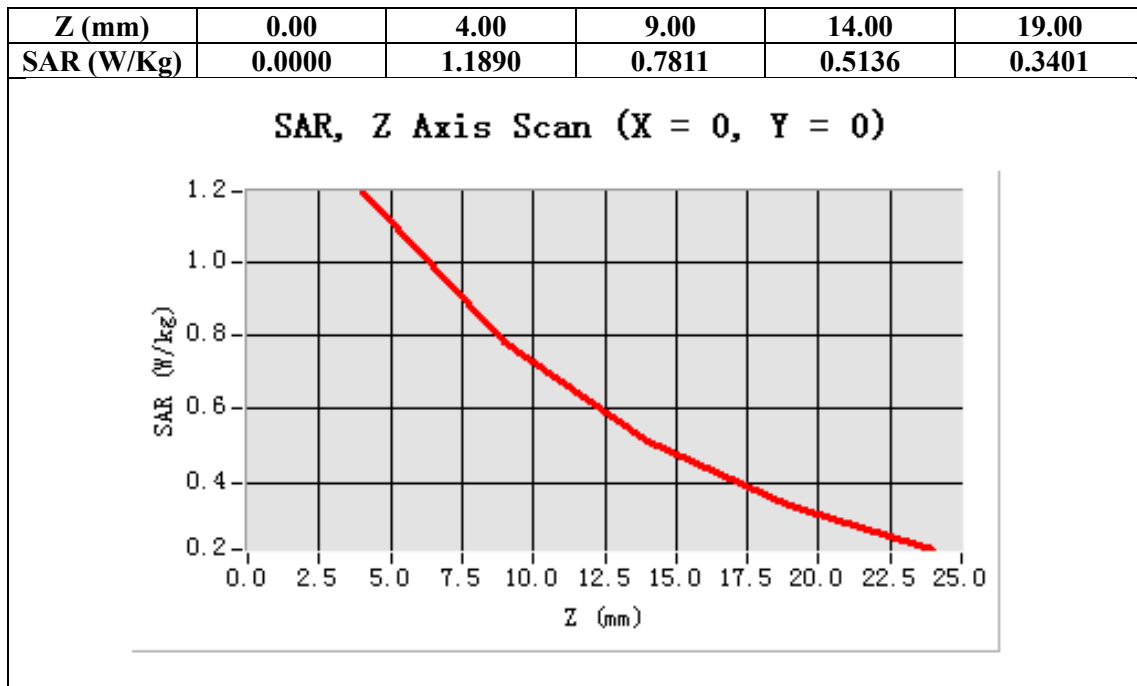

Test Laboratory: AGC Lab

Date: Dec.06, 2013

WCDMA Band V High- Body - Towards Grounds (HSPA)-with earphone

DUT: Mobile Phone; Type: Profile

Communication System: UMTS; Communication System Band: BAND V UTRA/FDD ; Duty Cycle:1: 1; Conv.F=5.46
Frequency: 846.6 MHz; Medium parameters used: $f = 835$ MHz; $\sigma=0.94$ mho/m; $\epsilon_r = 53.88$; $\rho = 1000$ kg/m³ ;
Phantom section: Flat Section
Ambient temperature (°C):21, Liquid temperature (°C):21

SATIMO Configuration:

Probe: EP165; Calibrated: 01/31/2013

- Sensor-Surface: 4mm (Mechanical Surface Detection)
- Phantom: Flat Phantom; Type: Elliptical Phantom
- Measurement SW: OpenSAR V4_02_01

Configuration/ WCDMA Band V High-Body- Back /Area Scan (6x8x1): Measurement grid: dx=8mm, dy=8mm
Configuration/ WCDMA Band V High-Body- Back /Zoom Scan (5x5x7)/Cube 0: Measurement grid: dx=8mm, dy=8mm, dz=5mm;

Area Scan	surf_sam_plan.txt
ZoomScan	5x5x7,dx=8mm dy=8mm dz=5mm,Very fast
Phantom	Validation plane
Device Position	Body Back
Band	WCDMA Band V
Channels	High
Signal	TDMA (Crest factor: 1.0)

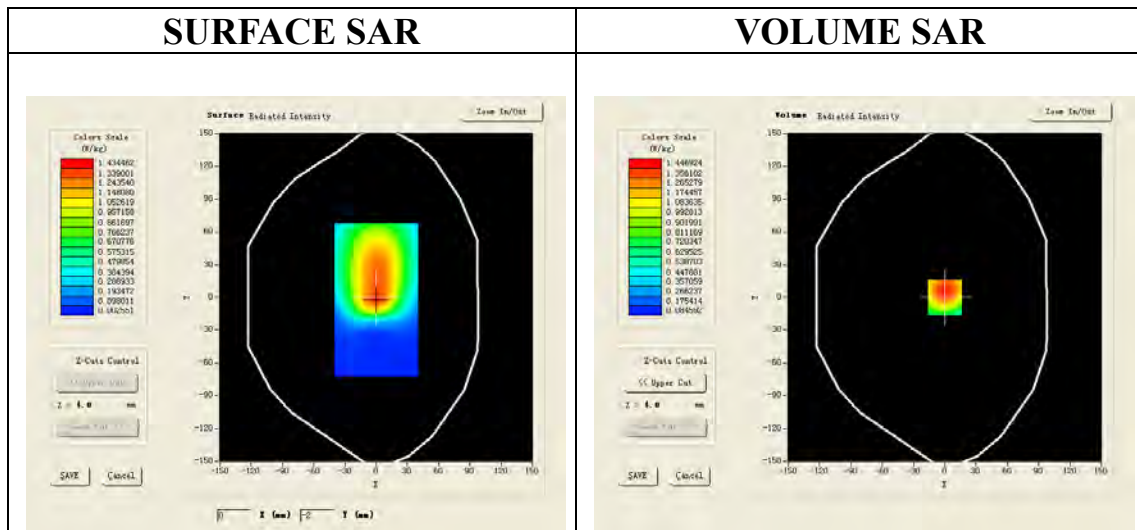

Maximum location: X=0.00, Y=0.00

SAR 10g (W/Kg)	0.859902
SAR 1g (W/Kg)	1.382061

