

FCC RF Test Report

(BLE)

Report No.: JYTSZ-R12-2400668
Applicant: Swagtek
Address of Applicant: 10205 NW 19th Street, STE 101, Miami, FL33172.USA

Equipment Under Test (EUT)

Product Name: Smart Phone
Model No.: G1L, UG1L, Gameboy
Trade Mark: LOGIC, UNONU, iSWAG

FCC ID: O55653224

Applicable Standards: FCC CFR Title 47 Part 15C (§15.247)

Date of Sample Receipt: 05 Aug., 2024
Date of Test: 06 Aug., to 03 Sep., 2024
Date of Report Issued: 06 Sep., 2024

Test Result: PASS

Project by: _____

Date: 06 Sep., 2024

Reviewed by: _____

Date: 06 Sep., 2024

Approved by: _____

Date: 06 Sep., 2024

Manager

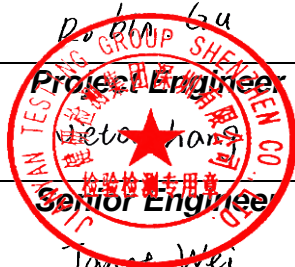

This equipment has been shown to be capable of compliance with the applicable technical standards as indicated in the measurement report and was tested in accordance with the measurement procedures specified in above the application standard version. Test results reported herein relate only to the item(s) tested.

This document cannot be reproduced except in full, without prior written approval of the Company. Any unauthorized alteration, forgery or falsification of the content or appearance of this document is unlawful and offenders may be prosecuted to the fullest extent of the law. Unless otherwise stated the results shown in this test report refer only to the sample(s) tested and such sample(s) are retained for 90 days only.

1 Version

Version No.	Date	Description
00	06 Sep., 2024	Original

2 Contents

	Page
Cover Page	1
1 Version	2
2 Contents	3
3 General Information	4
3.1 Client Information	4
3.2 General Description of E.U.T.	4
3.3 Test Mode and Test Environment	5
3.4 Description of Test Auxiliary Equipment	5
3.5 Measurement Uncertainty	5
3.6 Additions to, Deviations, or Exclusions from the Method	5
3.7 Laboratory Facility	6
3.8 Laboratory Location	6
3.9 Test Instruments List	7
4 Measurement Setup and Procedure	9
4.1 Test Channel	9
4.2 Test Setup	9
4.3 Test Procedure	11
5 Test Results	12
5.1 Summary	12
5.1.1 Clause and Data Summary	12
5.1.2 Test Limit	13
5.2 Antenna requirement	14
5.3 AC Power Line Conducted Emission	15
5.4 Emissions in Restricted Frequency Bands	17
5.5 Emissions in Non-restricted Frequency Bands	33

3 General Information

3.1 Client Information

Applicant:	Swagtek
Address:	10205 NW 19th Street,STE 101,Miami, FL33172.USA
Manufacturer/Factory:	Swagtek
Address:	10205 NW 19th Street,STE 101,Miami, FL33172.USA

3.2 General Description of E.U.T.

Product Name:	Smart Phone
Model No.:	G1L, UG1L, Gameboy
Operation Frequency:	2402 MHz - 2480 MHz
Channel Numbers:	40
Channel Separation:	2MHz
Modulation Technology:	GFSK
Data Speed:	1 Mbps (LE 1M PHY), 2 Mbps (LE 2M PHY), 125 kbps (LE Coded PHY, S=8), 500 kbps (LE Coded PHY, S=2)
Antenna Type:	Internal Antenna
Antenna Gain:	1.15 dBi (declare by applicant)
Antenna transmit mode:	SISO (1TX, 1RX)
Power Supply:	Rechargeable Li-ion Battery DC3.85V, 4900mAh
AC Adapter:	Model: 490 Input: AC100-240V, 50/60Hz, 0.3A Output: DC 5.0V, 2.0A
Test Sample Condition:	The test samples were provided in good working order with no visible defects.
Remark:	G1L, UG1L, Gameboy were identical inside, the electrical circuit design, layout, components used and internal wiring, with only difference being model name.

3.3 Test Mode and Test Environment

Test Mode:	
Transmitting mode	Keep the EUT in continuous transmitting with modulation
Remark:	
<ol style="list-style-type: none"> For AC power line conducted emission and radiated spurious emission (below 1GHz), pre-scan all data speed, found 1 Mbps (LE 1M PHY) was worse case mode. The report only reflects the test data of worst mode. Channel Low, Mid and High for each type band with rated data rate were chosen for full testing. The field strength of spurious radiation emission was measured as EUT stand-up position (H mode) and lie down position (E1, E2 mode) for these modes. Just the worst case position (H mode) shown in report. 	
Operating Environment:	
Temperature:	15°C ~ 35°C
Humidity:	20 % ~ 75 % RH
Atmospheric Pressure:	1008 mbar
Voltage:	Nominal: 3.85 Vdc, Extreme: Low 3.50 Vdc, High 4.40 Vdc
Test Engineer:	Logan Li (Conducted measurement) Alan Chen (Radiated measurement)

3.4 Description of Test Auxiliary Equipment

The EUT has been tested as an independent unit.

3.5 Measurement Uncertainty

Parameter	Expanded Uncertainty (Confidence of 95%(U = 2Uc(y)))
Conducted Emission for LISN (9kHz ~ 150kHz)	3.57 dB
Conducted Emission for LISN (150kHz ~ 30MHz)	3.14 dB
Radiated Emission (30MHz ~ 200MHz) (10m SAC)	4.3 dB
Radiated Emission (200MHz ~ 1000MHz) (10m SAC)	4.3 dB
Radiated Emission (30MHz ~ 1GHz) (3m FAR)	3.43 dB
Radiated Emission (1GHz ~ 6GHz) (3m FAR)	4.95 dB
Radiated Emission (6GHz ~ 18GHz) (3m FAR)	5.23 dB
Radiated Emission (18GHz ~ 40GHz) (3m FAR)	5.32 dB

Note: All the measurement uncertainty value were shown with a coverage k=2 to indicate 95% level of confidence. The measurement data show herein meets or exceeds the CISPR measurement uncertainty values specified in CISPR 16-4-2 and can be compared directly to specified limit to determine compliance.

3.6 Additions to, Deviations, or Exclusions from the Method

No

3.7 Laboratory Facility

The test facility is recognized, certified, or accredited by the following organizations:

- **FCC - Designation No.: CN1211**

JianYan Testing Group Shenzhen Co., Ltd. has been accredited as a testing laboratory by FCC(Federal Communications Commission). The test firm Registration No. is 727551.

- **ISED – CAB identifier.: CN0021**

The 3m Semi-anechoic chamber and 10m Semi-anechoic chamber of JianYan Testing Group Shenzhen Co., Ltd. has been Registered by Certification and Engineering Bureau of Industry Canada for radio equipment testing with Registration No.: 10106A-1.

- **CNAS - Registration No.: CNAS L15527**

JianYan Testing Group Shenzhen Co., Ltd. is accredited to ISO/IEC 17025:2017 General Requirements for the Competence of Testing and Calibration laboratories for the competence of testing. The Registration No. is CNAS L15527.

- **A2LA - Registration No.: 4346.01**

This laboratory is accredited in accordance with the recognized International Standard ISO/IEC 17025:2017 General requirements for the competence of testing and calibration laboratories. The test scope can be found as below link: <https://portal.a2la.org/scopepdf/4346-01.pdf>

3.8 Laboratory Location

JianYan Testing Group Shenzhen Co., Ltd.

Address: No.101, Building 8, Innovation Wisdom Port, No.155 Hongtian Road, Huangpu Community, Xinqiao Street, Bao'an District, Shenzhen, Guangdong, People's Republic of China.

Tel: +86-755-23118282, Fax: +86-755-23116366

Email: info-JYTee@lets.com, Website: <http://jyt.lets.com>

3.9 Test Instruments List

Radiated Emission(3m FAR):					
Test Equipment	Manufacturer	Model No.	Manage No.	Cal. Date (mm-dd-yy)	Cal. Due date (mm-dd-yy)
3m FAR	YUNYI	9m*6m*6m	WXJ097	06-15-2023	06-14-2028
BiConiLog Antenna	Schwarzbeck	VULB9163	WXJ097-2	06-26-2024	06-25-2025
Biconical Antenna	Schwarzbeck	VUBA9117	WXJ002-1	07-01-2024	06-30-2027
Horn Antenna	Schwarzbeck	BBHA9120D	WXJ097-3	06-16-2024	06-15-2025
Horn Antenna	Schwarzbeck	BBHA9120D	WXJ002-3	12-28-2023	12-27-2024
Horn Antenna	Schwarzbeck	BBHA9170	WXJ002-5	12-28-2023	12-27-2024
Horn Antenna	Schwarzbeck	BBHA9170	WXJ002-6	12-28-2023	12-27-2024
Pre-amplifier (30MHz ~ 1GHz)	YUNYI	PAM-310N	WXJ097-5	04-24-2024	04-23-2025
Pre-amplifier (1GHz ~ 18GHz)	YUNYI	PAM-118N	WXJ097-6	04-24-2024	04-23-2025
Pre-amplifier (18GHz ~ 40GHz)	RF System	TRLA-180400G45B	WXJ002-7	12-27-2023	12-26-2024
EMI Test Receiver	Rohde & Schwarz	ESCI3	WXJ003	12-27-2023	12-26-2024
Spectrum Analyzer	Rohde & Schwarz	FSP 30	WXJ004	12-27-2023	12-26-2024
Spectrum Analyzer	KEYSIGHT	N9010B	WXJ081-1	06-11-2024	06-10-2025
Coaxial Cable (30MHz ~ 1GHz)	JYTSZ	JYT3M-1G-NN-13M	WXG097-1	07-30-2024	07-29-2025
Coaxial Cable (1GHz ~ 18GHz)	JYTSZ	JYT3M-18G-NN-8M	WXG097-2	07-30-2024	07-29-2025
Coaxial Cable (18GHz ~ 40GHz)	JYTSZ	JYT3M-40G-SS-8M	WXG097-3	07-30-2024	07-29-2025
High Band Reject Filter Group	Tonscend	JS0806-F	WXJ089	N/A	
Low Band Reject Filter Group	Tonscend	JS0806-F	WXJ097-4	N/A	
Test Software	Tonscend	TS+	Version: 5.0.0		

Radiated Emission(10m SAC):					
Test Equipment	Manufacturer	Model No.	Manage No.	Cal. Date (mm-dd-yy)	Cal. Due date (mm-dd-yy)
10m SAC	ETS	RFSD-100-F/A	WXJ090	04-28-2021	04-27-2026
BiConiLog Antenna	SCHWARZBECK	VULB 9168	WXJ090-1	01-05-2024	01-04-2025
BiConiLog Antenna	SCHWARZBECK	VULB 9168	WXJ090-2	12-28-2023	12-27-2024
EMI Test Receiver	R&S	ESR 3	WXJ090-3	12-27-2023	12-26-2024
EMI Test Receiver	R&S	ESR 3	WXJ090-4	12-27-2023	12-26-2024
Low Pre-amplifier	Bost	LNA 0920N	WXJ090-6	12-27-2023	12-26-2024
Low Pre-amplifier	Bost	LNA 0920N	WXJ090-7	12-27-2023	12-26-2024
Cable	Bost	JYT10M-1G-NN-10M	WXG002-7	01-17-2024	01-16-2025
Cable	Bost	JYT10M-1G-NN-10M	WXG002-8	01-17-2024	01-16-2025
Test Software	R&S	EMC32	Version: 10.50.40		

Conducted Emission:					
Test Equipment	Manufacturer	Model No.	Manage No.	Cal. Date (mm-dd-yy)	Cal. Due date (mm-dd-yy)
EMI Test Receiver	Rohde & Schwarz	ESR3	WXJ003-2	06-11-2024	06-10-2025
LISN	Schwarzbeck	NSLK 8127	QCJ001-13	12-27-2023	12-26-2024
LISN	Rohde & Schwarz	ESH3-Z5	WXJ005-1	12-27-2023	12-26-2024
LISN Coaxial Cable (9kHz ~ 30MHz)	JYTSZ	JYTCE-1G-NN-2M	WXG003-1	01-17-2024	01-16-2025
Test Software	AUDIX	E3	Version: 6.110919b		

Conducted Method:					
Test Equipment	Manufacturer	Model No.	Manage No.	Cal. Date (mm-dd-yy)	Cal. Due date (mm-dd-yy)
Spectrum Analyzer	Keysight	N9010B	WXJ004-3	11-01-2023	10-31-2024
Temperature Humidity Chamber	ZHONG ZHI	CZ-A-80D	WXJ032-3	01-09-2023	01-08-2025
Power Detector Box	MWRFTEST	MW100-PSB	WXJ007-4	09-25-2023	09-24-2024
RF Control Unit	MWRFTEST	MW100-RFCB	WXG006		N/A
RF Switch	TOP PRECISION	RSU0301	WXG003		N/A
DC Power Supply	Keysight	E3642A	WXJ025-2		N/A
Test Software	MWRFTEST	MTS 8310		Version: 2.0.0.0	

4 Measurement Setup and Procedure

4.1 Test Channel

According to ANSI C63.10-2013 chapter 5.6.1 Table 4 requirement, select lowest channel, middle channel, and highest channel in the frequency range in which device operates for testing. The detailed frequency points are as follows:

Lowest channel		Middle channel		Highest channel	
Channel No.	Frequency (MHz)	Channel No.	Frequency (MHz)	Channel No.	Frequency (MHz)
0	2402	20	2442	39	2480

4.2 Test Setup

1) Conducted emission measurement:

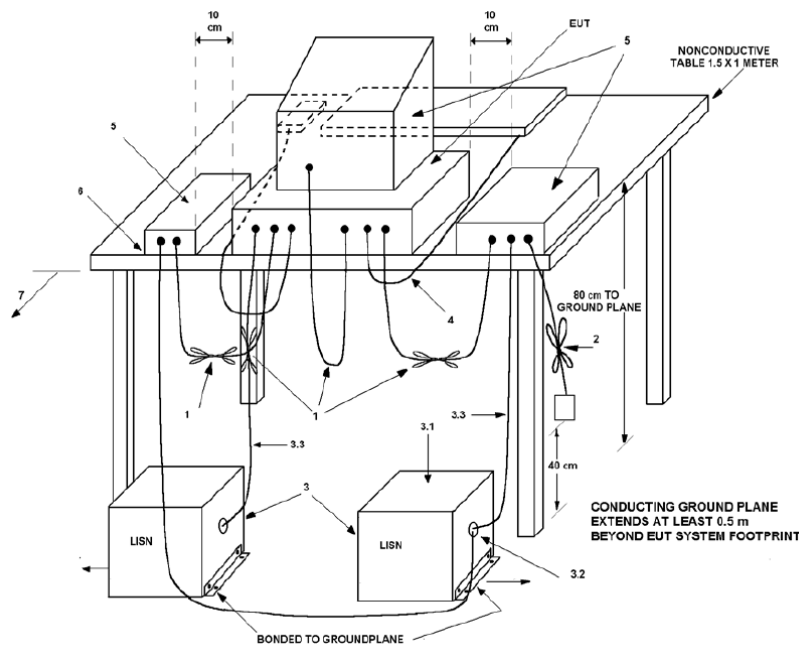

Note: The detailed descriptions please refer to Figure 8 of ANSI C63.4:2014.

2) Radiated emission measurement:

Below 1GHz (10m SAC)

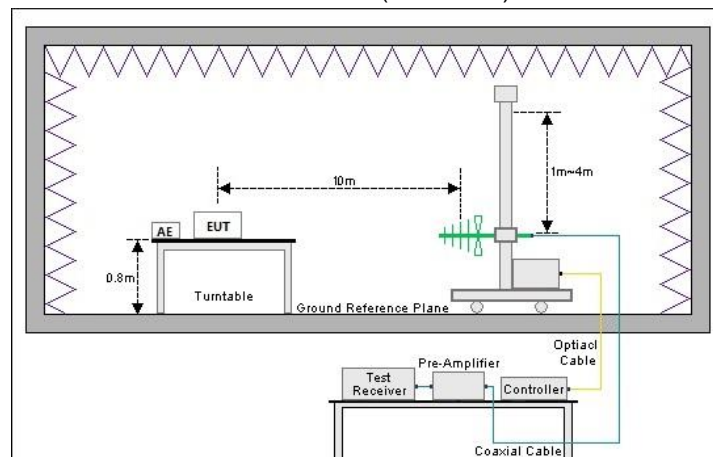

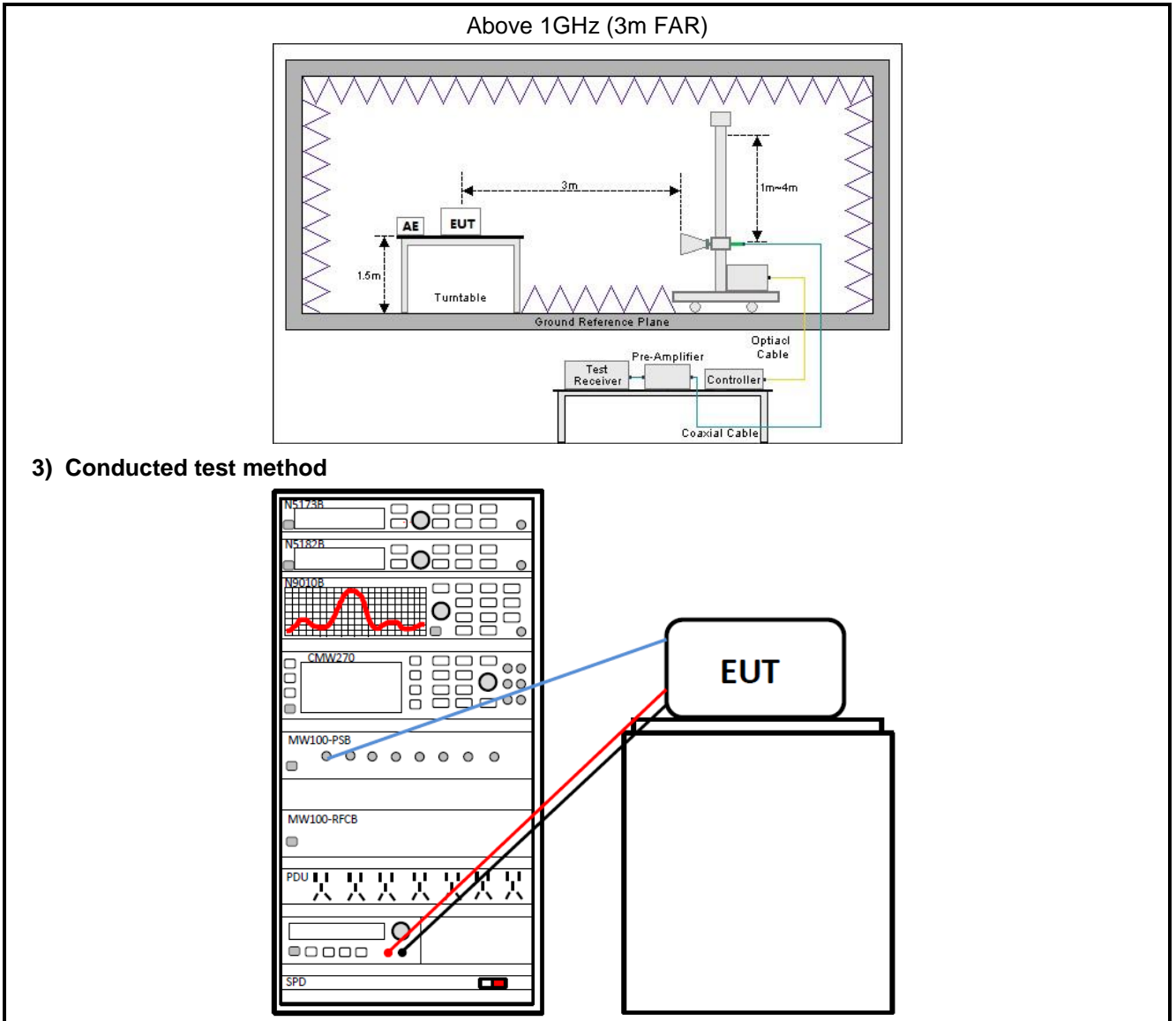

4.3 Test Procedure

Test method	Test step
Conducted emission	<ol style="list-style-type: none"> The E.U.T and simulators are connected to the main power through a line impedance stabilization network (L.I.S.N.). This provides a 50ohm/50uH coupling impedance for the measuring equipment. The peripheral devices are also connected to the main power through a LISN that provides a 50ohm/50uH coupling impedance with 50ohm termination. (Please refer to the block diagram of the test setup and photographs). Both sides of A.C. line are checked for maximum conducted interference. In order to find the maximum emission, the relative positions of equipment and all of the interface cables must be changed according to ANSI C63.10 on conducted measurement.
Radiated emission	<p>For below 1GHz:</p> <ol style="list-style-type: none"> The EUT was placed on the tabletop of a rotating table 0.8 m the ground at a 10 m semi anechoic chamber. The measurement distance from the EUT to the receiving antenna is 10 m. EUT works in each mode of operation that needs to be tested , and having the EUT continuously working, respectively on 3 axis (X, Y & Z) and considered typical configuration to obtain worst position. The highest signal levels relative to the limit shall be determined by rotating the EUT from 0° to 360° and with varying the measurement antenna height between 1 m and 4 m in vertical and horizontal polarizations. Open the test software to control the test antenna and test turntable. Perform the test, save the test results, and export the test data. <p>For above 1GHz:</p> <ol style="list-style-type: none"> The EUT was placed on the tabletop of a rotating table 1.5 m the ground at a 3 m fully anechoic room. The measurement distance from the EUT to the receiving antenna is 3 m. EUT works in each mode of operation that needs to be tested , and having the EUT continuously working, respectively on 3 axis (X, Y & Z) and considered typical configuration to obtain worst position. The highest signal levels relative to the limit shall be determined by rotating the EUT from 0° to 360° and with varying the measurement antenna height between 1 m and 4 m in vertical and horizontal polarizations. Open the test software to control the test antenna and test turntable. Perform the test, save the test results, and export the test data.
Conducted test method	<ol style="list-style-type: none"> The BLE antenna port of EUT was connected to the test port of the test system through an RF cable. The EUT is keeping in continuous transmission mode and tested in all modulation modes. Open the test software, prepare a test plan, and control the system through the software. After the test is completed, the test report is exported through the test software.

5 Test Results

5.1 Summary

5.1.1 Clause and Data Summary

Test items	Standard clause	Test data	Result
Antenna Requirement	15.203 15.247 (b)(4)	See Section 5.2	Pass
AC Power Line Conducted Emission	15.207	See Section 5.3	Pass
Conducted Output Power	15.247 (b)(3)	Appendix A – BLE-1M PHY Appendix A – BLE-2M PHY Appendix A – BLE-Coded PHY,S=2 Appendix A – BLE-Coded PHY,S=8	Pass
6dB Emission Bandwidth 99% Occupied Bandwidth	15.247 (a)(2)	Appendix A – BLE-1M PHY Appendix A – BLE-2M PHY Appendix A – BLE-Coded PHY,S=2 Appendix A – BLE-Coded PHY,S=8	Pass
Power Spectral Density	15.247 (e)	Appendix A – BLE-1M PHY Appendix A – BLE-2M PHY Appendix A – BLE-Coded PHY,S=2 Appendix A – BLE-Coded PHY,S=8	Pass
Band-edge Emission Conduction Spurious Emission	15.247 (d)	Appendix A – BLE-1M PHY Appendix A – BLE-2M PHY Appendix A – BLE-Coded PHY,S=2 Appendix A – BLE-Coded PHY,S=8	Pass
Emissions in Restricted Frequency Bands	15.205 15.247 (d)	See Section 5.4	Pass
Emissions in Non-restricted Frequency Bands	15.209 15.247(d)	See Section 5.5	Pass
<p>Remark:</p> <ol style="list-style-type: none"> 1. Pass: The EUT complies with the essential requirements in the standard. 2. N/A: Not Applicable. 3. The cable insertion loss used by “RF Output Power” and other conduction measurement items is 0.5dB (provided by the customer). 			
Test Method:	ANSI C63.10-2013 KDB 558074 D01 15.247 Meas Guidance v05r02		

5.1.2 Test Limit

Test items	Limit																														
AC Power Line Conducted Emission	<table border="1"> <thead> <tr> <th rowspan="2">Frequency (MHz)</th> <th colspan="2">Limit (dBμV)</th> </tr> <tr> <th>Quasi-Peak</th> <th>Average</th> </tr> </thead> <tbody> <tr> <td>0.15 – 0.5</td> <td>66 to 56 <small>Note 1</small></td> <td>56 to 46 <small>Note 1</small></td> </tr> <tr> <td>0.5 – 5</td> <td>56</td> <td>46</td> </tr> <tr> <td>5 – 30</td> <td>60</td> <td>50</td> </tr> </tbody> </table> <p>Note 1: The limit level in dBμV decreases linearly with the logarithm of frequency. Note 2: The more stringent limit applies at transition frequencies.</p>	Frequency (MHz)	Limit (dB μ V)		Quasi-Peak	Average	0.15 – 0.5	66 to 56 <small>Note 1</small>	56 to 46 <small>Note 1</small>	0.5 – 5	56	46	5 – 30	60	50																
Frequency (MHz)	Limit (dB μ V)																														
	Quasi-Peak	Average																													
0.15 – 0.5	66 to 56 <small>Note 1</small>	56 to 46 <small>Note 1</small>																													
0.5 – 5	56	46																													
5 – 30	60	50																													
Conducted Output Power	For systems using digital modulation in the 902-928 MHz, 2400-2483.5 MHz, and 5725-5850 MHz bands: 1 Watt.																														
6dB Emission Bandwidth	The minimum 6 dB bandwidth shall be at least 500 kHz.																														
99% Occupied Bandwidth	N/A																														
Power Spectral Density	For digitally modulated systems, the power spectral density conducted from the intentional radiator to the antenna shall not be greater than 8 dBm in any 3 kHz band during any time interval of continuous transmission.																														
Band-edge Emission Conduction Spurious Emission	In any 100 kHz bandwidth outside the frequency band in which the spread spectrum or digitally modulated intentional radiator is operating, the radio frequency power that is produced by the intentional radiator shall be at least 20 dB below that in the 100 kHz bandwidth within the band that contains the highest level of the desired power, based on either an RF conducted or a radiated measurement, provided the transmitter demonstrates compliance with the peak conducted power limits. If the transmitter complies with the conducted power limits based on the use of RMS averaging over a time interval, as permitted under paragraph (b)(3) of this section, the attenuation required under this paragraph shall be 30 dB instead of 20 dB. Attenuation below the general limits specified in §15.209(a) is not required. In addition, radiated emissions which fall in the restricted bands, as defined in §15.205(a), must also comply with the radiated emission limits specified in §15.209(a) (see §15.205(c)).																														
Emissions in Restricted Frequency Bands Emissions in Non-restricted Frequency Bands	<table border="1"> <thead> <tr> <th rowspan="2">Frequency (MHz)</th> <th colspan="2">Limit (dBμV/m)</th> <th rowspan="2">Detector</th> </tr> <tr> <th>@ 3m</th> <th>@ 10m</th> </tr> </thead> <tbody> <tr> <td>30 – 88</td> <td>40.0</td> <td>30.0</td> <td>Quasi-peak</td> </tr> <tr> <td>88 – 216</td> <td>43.5</td> <td>33.5</td> <td>Quasi-peak</td> </tr> <tr> <td>216 – 960</td> <td>46.0</td> <td>36.0</td> <td>Quasi-peak</td> </tr> <tr> <td>960 – 1000</td> <td>54.0</td> <td>44.0</td> <td>Quasi-peak</td> </tr> </tbody> </table> <p>Note: The more stringent limit applies at transition frequencies.</p> <table border="1"> <thead> <tr> <th rowspan="2">Frequency</th> <th colspan="2">Limit (dBμV/m) @ 3m</th> </tr> <tr> <th>Average</th> <th>Peake</th> </tr> </thead> <tbody> <tr> <td>Above 1 GHz</td> <td>54.0</td> <td>74.0</td> </tr> </tbody> </table> <p>Note: The measurement bandwidth shall be 1 MHz or greater.</p>	Frequency (MHz)	Limit (dB μ V/m)		Detector	@ 3m	@ 10m	30 – 88	40.0	30.0	Quasi-peak	88 – 216	43.5	33.5	Quasi-peak	216 – 960	46.0	36.0	Quasi-peak	960 – 1000	54.0	44.0	Quasi-peak	Frequency	Limit (dB μ V/m) @ 3m		Average	Peake	Above 1 GHz	54.0	74.0
Frequency (MHz)	Limit (dB μ V/m)		Detector																												
	@ 3m	@ 10m																													
30 – 88	40.0	30.0	Quasi-peak																												
88 – 216	43.5	33.5	Quasi-peak																												
216 – 960	46.0	36.0	Quasi-peak																												
960 – 1000	54.0	44.0	Quasi-peak																												
Frequency	Limit (dB μ V/m) @ 3m																														
	Average	Peake																													
Above 1 GHz	54.0	74.0																													

5.2 Antenna requirement

Standard requirement:	FCC Part 15 C Section 15.203 /247(b)(4)
<p>15.203 requirement: An intentional radiator shall be designed to ensure that no antenna other than that furnished by the responsible party shall be used with the device. The use of a permanently attached antenna or of an antenna that uses a unique coupling to the intentional radiator, the manufacturer may design the unit so that a broken antenna can be replaced by the user, but the use of a standard antenna jack or electrical connector is prohibited.</p> <p>15.247(b) (4) requirement: (4) The conducted output power limit specified in paragraph (b) of this section is based on the use of antennas with directional gains that do not exceed 6 dBi. Except as shown in paragraph (c) of this section, if transmitting antennas of directional gain greater than 6 dBi are used, the conducted output power from the intentional radiator shall be reduced below the stated values in paragraphs (b)(1), (b)(2), and (b)(3) of this section, as appropriate, by the amount in dB that the directional gain of the antenna exceeds 6 dBi.</p>	
E.U.T Antenna:	
<p>The BLE antenna is an Internal antenna which cannot replace by end-user, the best case gain of the antenna is 1.15 dBi. See product internal photos for details.</p>	

5.3 AC Power Line Conducted Emission

Product name:	Smart Phone	Product model:	G1L
Test by:	Kiran.Zeng	Test mode:	BLE Tx (LE 1M PHY)
Test frequency:	150 kHz ~ 30 MHz	Phase:	Line
Test voltage:	AC 120 V/60 Hz		

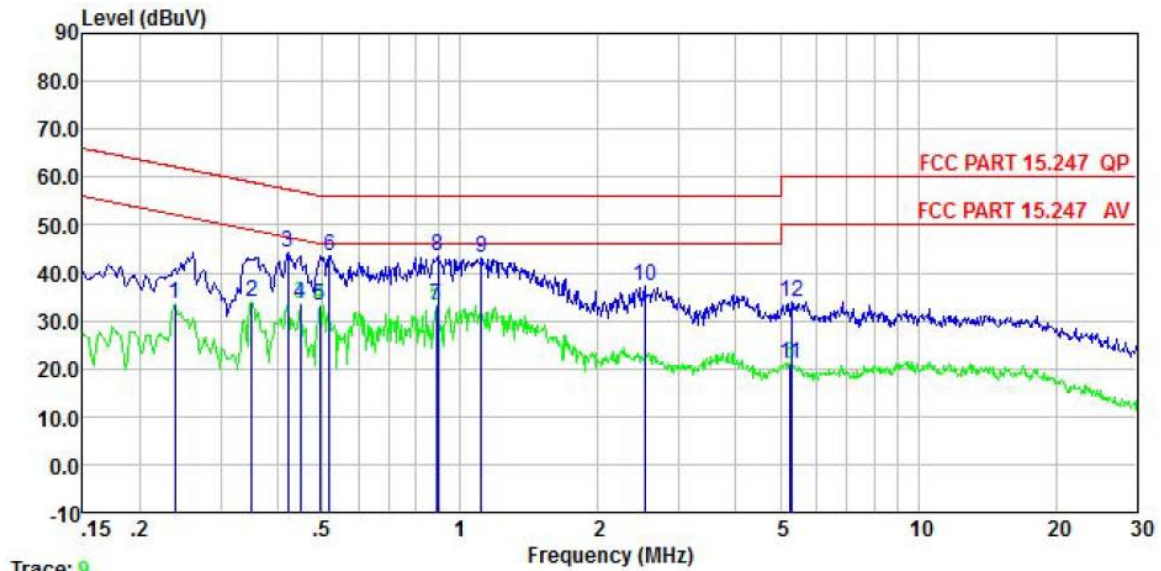

Trace: 9

	Read Freq	Read Level	LISN Factor	Aux Factor	Aux2 Factor	Cable Loss	Level	Limit Line	Over Limit	Remark
	MHz	dBuV	dB	dB	dB	dB	dBuV	dBuV	dB	
1	0.238	23.49	0.20	0.00	9.88	0.02	33.59	52.17	-18.58	Average
2	0.350	23.74	0.20	0.00	9.88	0.02	33.84	48.96	-15.12	Average
3	0.421	34.31	0.20	0.00	9.88	0.04	44.43	57.42	-12.99	QP
4	0.447	23.43	0.20	0.00	9.88	0.03	33.54	46.93	-13.39	Average
5	0.494	23.16	0.20	0.00	9.88	0.03	33.27	46.10	-12.83	Average
6	0.518	33.45	0.20	0.00	9.88	0.03	43.56	56.00	-12.44	QP
7	0.885	23.20	0.20	0.00	9.88	0.04	33.32	46.00	-12.68	Average
8	0.894	33.40	0.20	0.00	9.88	0.04	43.52	56.00	-12.48	QP
9	1.111	32.90	0.20	0.00	9.88	0.07	43.05	56.00	-12.95	QP
10	2.527	27.02	0.20	0.00	9.88	0.13	37.23	56.00	-18.77	QP
11	5.249	10.87	0.20	0.00	9.89	0.09	21.05	50.00	-28.95	Average
12	5.277	23.77	0.20	0.00	9.89	0.09	33.95	60.00	-26.05	QP

Remark:

1. Level = Read level + LISN Factor + Cable Loss.

Product name:	Smart Phone	Product model:	G1L
Test by:	Kiran.Zeng	Test mode:	BLE Tx (LE 1M PHY)
Test frequency:	150 kHz ~ 30 MHz	Phase:	Neutral
Test voltage:	AC 120 V/60 Hz		

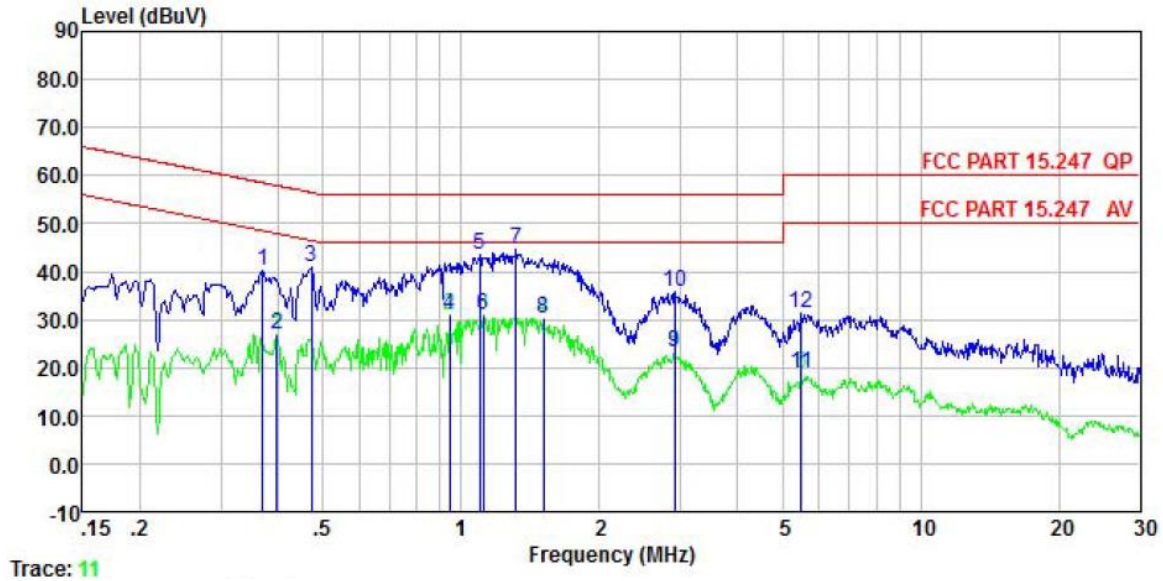

	Read	LISN	Aux	Aux2	Cable	Limit	Over		
Freq	Level	Factor	Factor	Factor	Loss	Level	Line	Limit	Remark
MHz	dBuV	dB	dB	dB	dB	dBuV	dBuV	dB	
1	0.369	30.02	0.20	0.00	9.88	0.03	40.13	58.52	-18.39 QP
2	0.398	16.86	0.20	0.00	9.88	0.04	26.98	47.90	-20.92 Average
3	0.471	30.90	0.20	0.00	9.88	0.03	41.01	56.49	-15.48 QP
4	0.943	20.89	0.20	0.00	9.88	0.04	31.01	46.00	-14.99 Average
5	1.100	33.42	0.21	0.00	9.88	0.07	43.58	56.00	-12.42 QP
6	1.117	20.64	0.22	0.00	9.88	0.07	30.81	46.00	-15.19 Average
7	1.317	34.46	0.24	0.00	9.88	0.11	44.69	56.00	-11.31 QP
8	1.511	20.02	0.26	0.00	9.88	0.15	30.31	46.00	-15.69 Average
9	2.915	12.89	0.30	0.00	9.89	0.08	23.16	46.00	-22.84 Average
10	2.915	25.30	0.30	0.00	9.89	0.08	35.57	56.00	-20.43 QP
11	5.505	8.47	0.30	0.00	9.90	0.09	18.76	50.00	-31.24 Average
12	5.505	20.91	0.30	0.00	9.90	0.09	31.20	60.00	-28.80 QP

Remark:

1. Level = Read level + LISN Factor + Cable Loss.

5.4 Emissions in Restricted Frequency Bands

Product Name:	Smart Phone	Product Model:	G1L
Test By:	Alan.Chen	Test mode:	BLE Tx (LE 1M PHY)
Test Channel:	Lowest channel	Polarization:	Vertical
Test Voltage:	AC 120/60Hz		

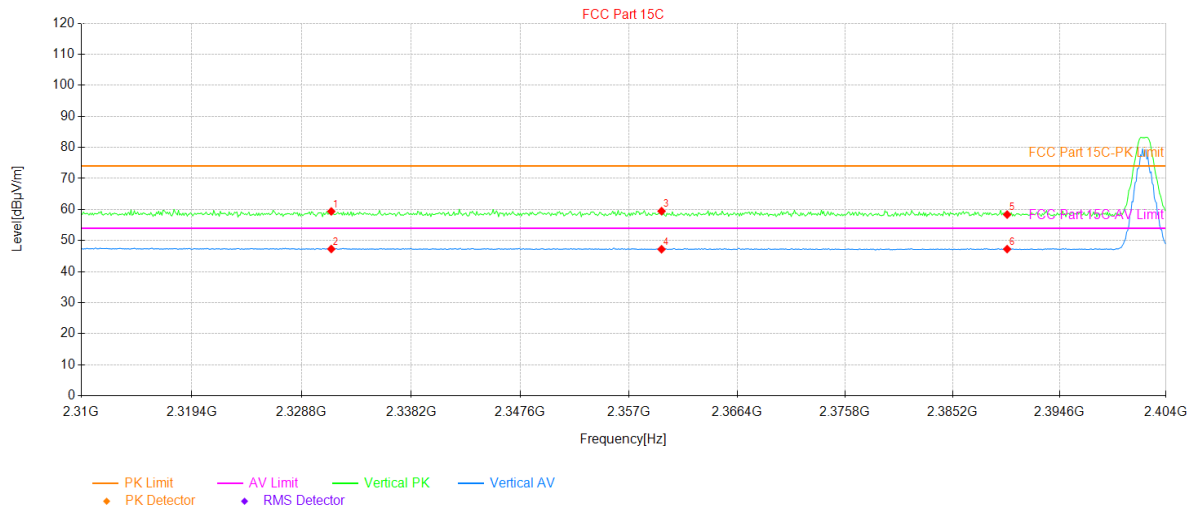

Suspected Data List										
NO.	Freq. [MHz]	Reading [dBµV]	Factor [dB/m]	Level [dBµV/m]	Limit [dBµV/m]	Margin [dB]	Angle [°]	Detector	Verdict	Polarity
1	2331.34	23.26	36.14	59.40	74.00	14.60	267	PK	PASS	Vertical
2	2331.34	11.15	36.14	47.29	54.00	6.71	96	AV	PASS	Vertical
3	2359.82	23.16	36.32	59.48	74.00	14.52	132	PK	PASS	Vertical
4	2359.82	10.90	36.32	47.22	54.00	6.78	112	AV	PASS	Vertical
5	2390.00	21.91	36.47	58.38	74.00	15.62	168	PK	PASS	Vertical
6	2390.00	10.79	36.47	47.26	54.00	6.74	223	AV	PASS	Vertical

Remark:

1. Level = Reading + Factor(Antenna Factor + Cable Loss – Pre-amplifier Factor).

Product Name:	Smart Phone	Product Model:	G1L
Test By:	Alan.Chen	Test mode:	BLE Tx (LE 1M PHY)
Test Channel:	Lowest channel	Polarization:	Horizontal
Test Voltage:	AC 120/60Hz		

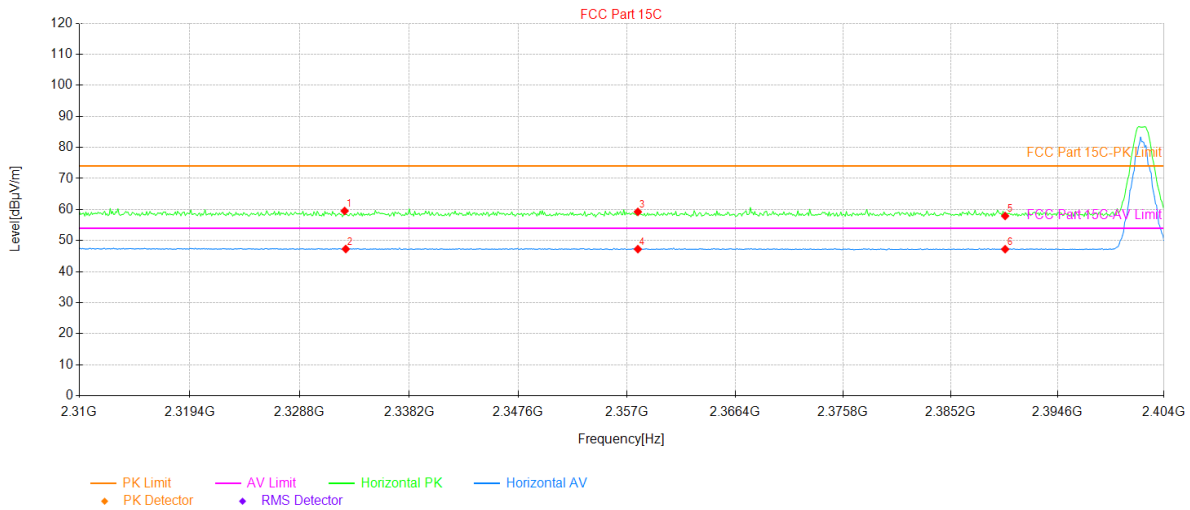

Suspected Data List										
NO.	Freq. [MHz]	Reading [dBµV]	Factor [dB/m]	Level [dBµV/m]	Limit [dBµV/m]	Margin [dB]	Angle [°]	Detector	Verdict	Polarity
1	2332.65	23.40	36.15	59.55	74.00	14.45	289	PK	PASS	Horizontal
2	2332.75	11.14	36.15	47.29	54.00	6.71	256	AV	PASS	Horizontal
3	2357.94	22.94	36.31	59.25	74.00	14.75	203	PK	PASS	Horizontal
4	2357.94	10.94	36.31	47.25	54.00	6.75	356	AV	PASS	Horizontal
5	2390.00	21.46	36.47	57.93	74.00	16.07	64	PK	PASS	Horizontal
6	2390.00	10.75	36.47	47.22	54.00	6.78	342	AV	PASS	Horizontal

Remark:

1. Level = Reading + Factor(Antenna Factor + Cable Loss – Pre-amplifier Factor).

Product Name:	Smart Phone	Product Model:	G1L
Test By:	Alan.Chen	Test mode:	BLE Tx (LE 1M PHY)
Test Channel:	Highest channel	Polarization:	Vertical
Test Voltage:	AC 120/60Hz		

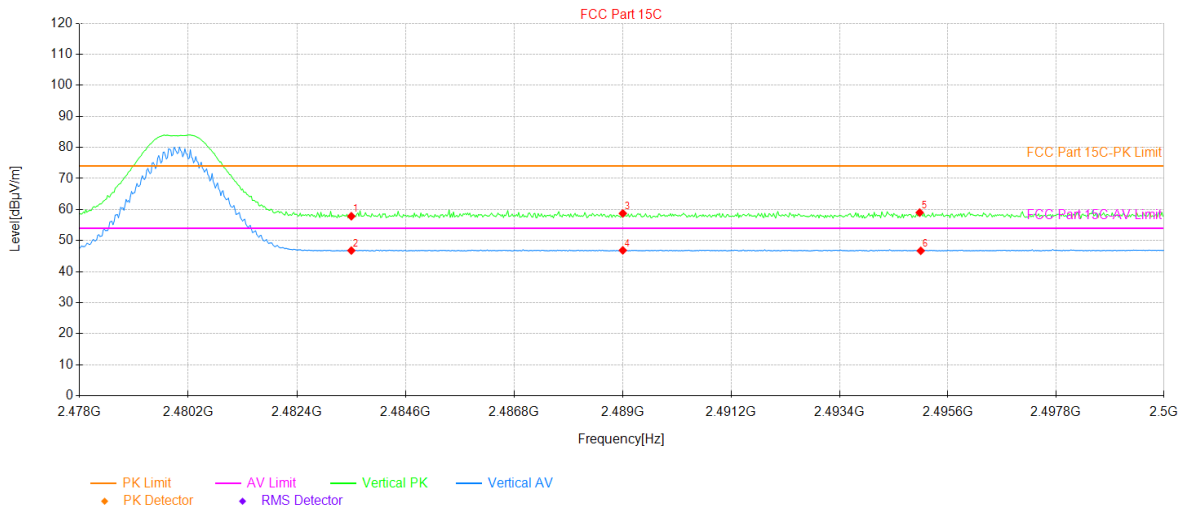

Suspected Data List										
NO.	Freq. [MHz]	Reading [dBµV]	Factor [dB/m]	Level [dBµV/m]	Limit [dBµV/m]	Margin [dB]	Angle [°]	Detector	Verdict	Polarity
1	2483.50	21.73	36.11	57.84	74.00	16.16	34	PK	PASS	Vertical
2	2483.50	10.68	36.11	46.79	54.00	7.21	317	AV	PASS	Vertical
3	2489.00	22.63	36.13	58.76	74.00	15.24	146	PK	PASS	Vertical
4	2489.00	10.73	36.13	46.86	54.00	7.14	130	AV	PASS	Vertical
5	2495.03	22.85	36.16	59.01	74.00	14.99	63	PK	PASS	Vertical
6	2495.05	10.56	36.16	46.72	54.00	7.28	52	AV	PASS	Vertical

Remark:

1. Level = Reading + Factor(Antenna Factor + Cable Loss – Pre-amplifier Factor).

Product Name:	Smart Phone	Product Model:	G1L
Test By:	Alan.Chen	Test mode:	BLE Tx (LE 1M PHY)
Test Channel:	Highest channel	Polarization:	Horizontal
Test Voltage:	AC 120/60Hz		

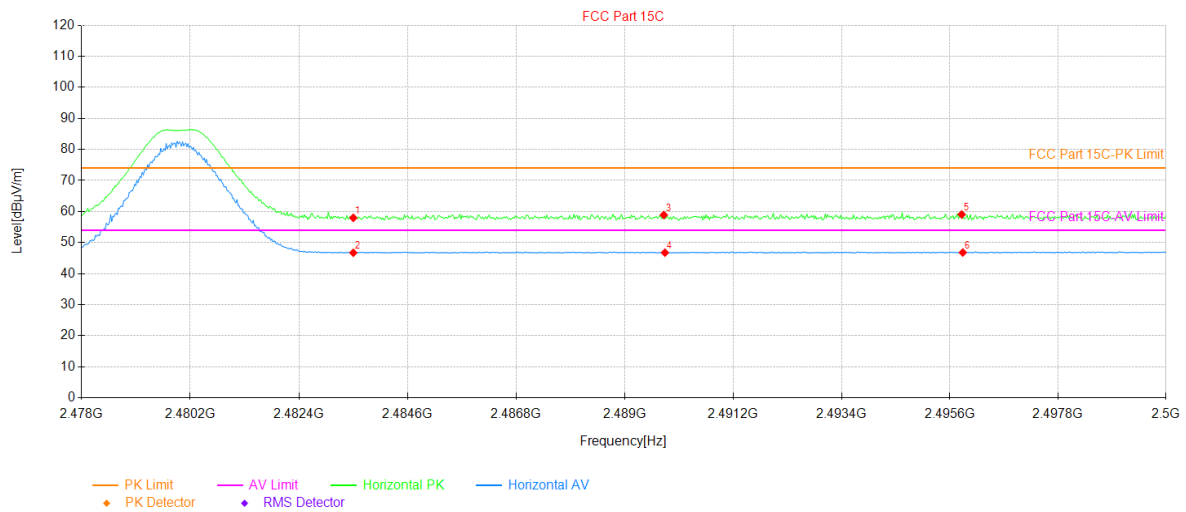

Suspected Data List										
NO.	Freq. [MHz]	Reading [dBµV]	Factor [dB/m]	Level [dBµV/m]	Limit [dBµV/m]	Margin [dB]	Angle [°]	Detector	Verdict	Polarity
1	2483.50	21.86	36.11	57.97	74.00	16.03	220	PK	PASS	Horizontal
2	2483.50	10.61	36.11	46.72	54.00	7.28	306	AV	PASS	Horizontal
3	2489.79	22.75	36.13	58.88	74.00	15.12	242	PK	PASS	Horizontal
4	2489.81	10.63	36.13	46.76	54.00	7.24	212	AV	PASS	Horizontal
5	2495.84	22.90	36.16	59.06	74.00	14.94	25	PK	PASS	Horizontal
6	2495.86	10.64	36.16	46.80	54.00	7.20	341	AV	PASS	Horizontal

Remark:

1. Level = Reading + Factor(Antenna Factor + Cable Loss – Pre-amplifier Factor).

Product Name:	Smart Phone	Product Model:	G1L
Test By:	Alan.Chen	Test mode:	BLE Tx (LE 2M PHY)
Test Channel:	Lowest channel	Polarization:	Vertical
Test Voltage:	AC 120/60Hz		

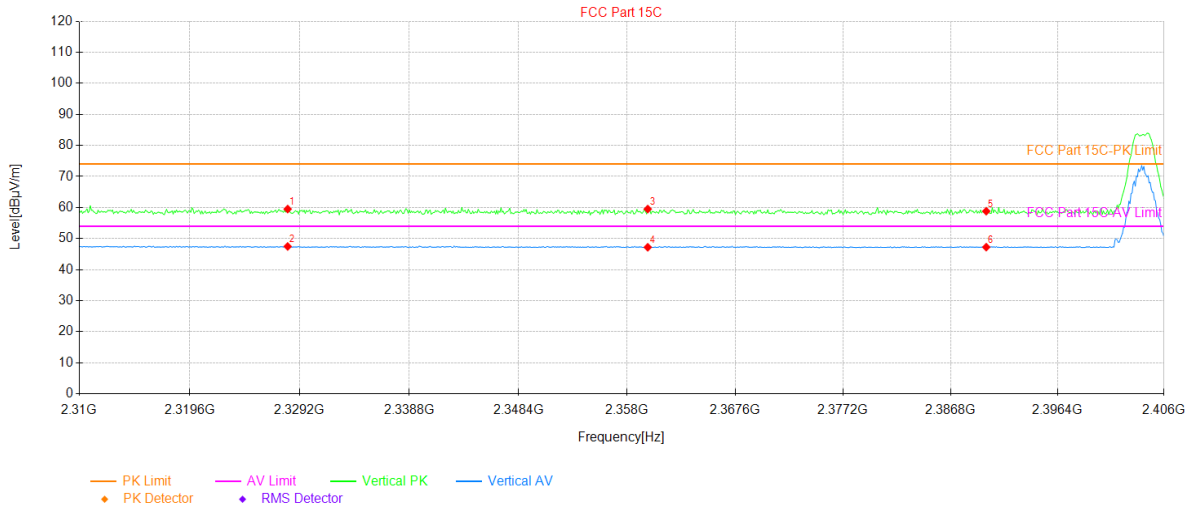

Suspected Data List										
NO.	Freq. [MHz]	Reading [dBµV]	Factor [dB/m]	Level [dBµV/m]	Limit [dBµV/m]	Margin [dB]	Angle [°]	Detector	Verdict	Polarity
1	2328.14	23.39	36.12	59.51	74.00	14.49	337	PK	PASS	Vertical
2	2328.14	11.35	36.12	47.47	54.00	6.53	20	AV	PASS	Vertical
3	2359.82	23.19	36.32	59.51	74.00	14.49	208	PK	PASS	Vertical
4	2359.82	10.89	36.32	47.21	54.00	6.79	253	AV	PASS	Vertical
5	2390.00	22.35	36.47	58.82	74.00	15.18	293	PK	PASS	Vertical
6	2390.00	10.78	36.47	47.25	54.00	6.75	269	AV	PASS	Vertical

Remark:

1. Level = Reading + Factor(Antenna Factor + Cable Loss – Pre-amplifier Factor).

Product Name:	Smart Phone	Product Model:	G1L
Test By:	Alan.Chen	Test mode:	BLE Tx (LE 2M PHY)
Test Channel:	Lowest channel	Polarization:	Horizontal
Test Voltage:	AC 120/60Hz		

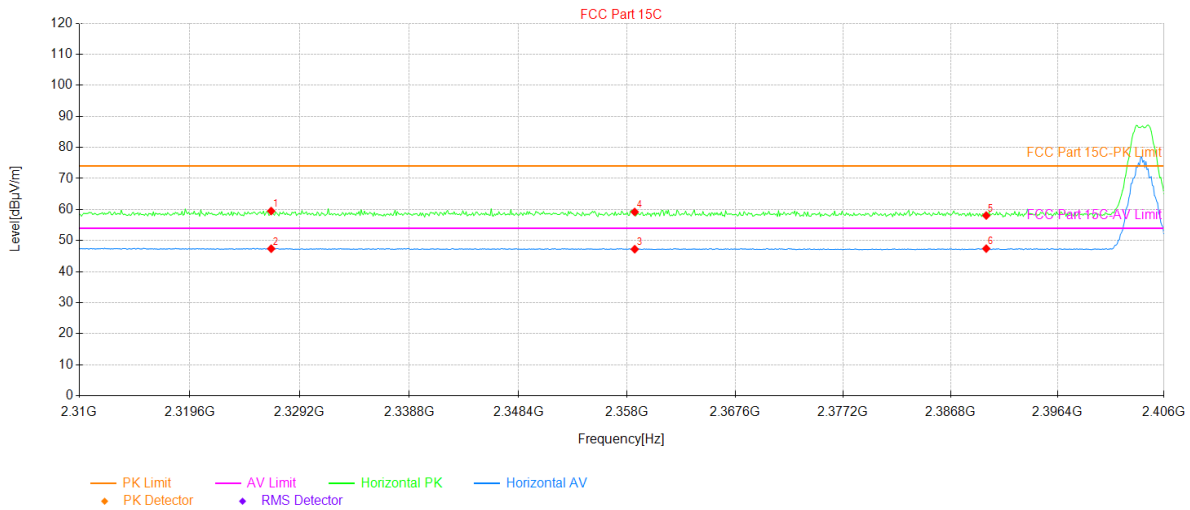

Suspected Data List

NO.	Freq. [MHz]	Reading [dBµV]	Factor [dB/m]	Level [dBµV/m]	Limit [dBµV/m]	Margin [dB]	Angle [°]	Detector	Verdict	Polarity
1	2326.70	23.40	36.12	59.52	74.00	14.48	26	PK	PASS	Horizontal
2	2326.70	11.28	36.12	47.40	54.00	6.60	309	AV	PASS	Horizontal
3	2358.67	10.91	36.32	47.23	54.00	6.77	324	AV	PASS	Horizontal
4	2358.67	22.90	36.32	59.22	74.00	14.78	305	PK	PASS	Horizontal
5	2390.00	21.60	36.47	58.07	74.00	15.93	94	PK	PASS	Horizontal
6	2390.00	10.95	36.47	47.42	54.00	6.58	309	AV	PASS	Horizontal

Remark:

1. Level = Reading + Factor(Antenna Factor + Cable Loss – Pre-amplifier Factor).

Product Name:	Smart Phone	Product Model:	G1L
Test By:	Alan.Chen	Test mode:	BLE Tx (LE 2M PHY)
Test Channel:	Highest channel	Polarization:	Vertical
Test Voltage:	AC 120/60Hz		

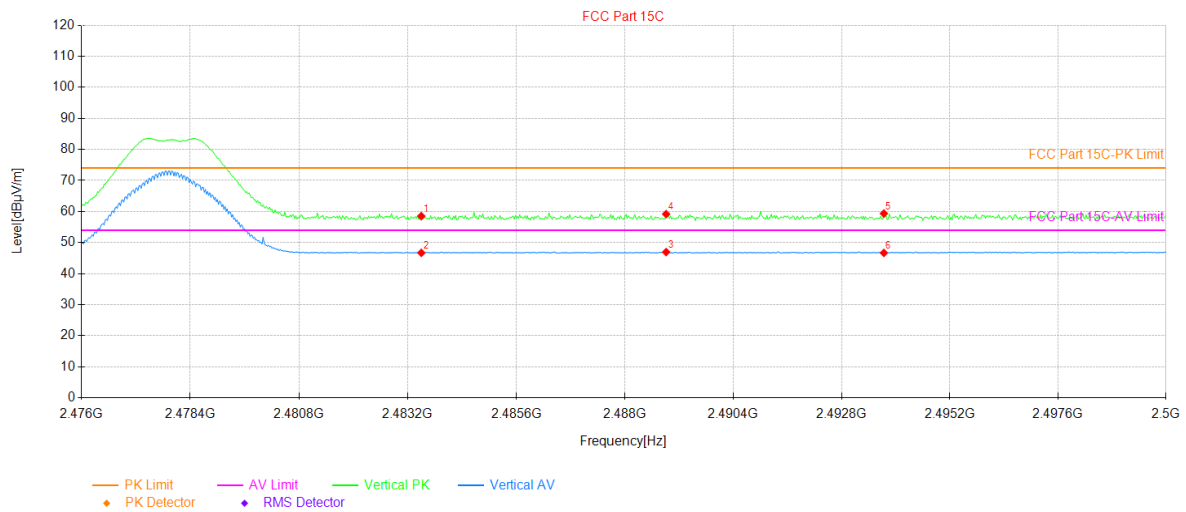

Suspected Data List										
NO.	Freq. [MHz]	Reading [dBµV]	Factor [dB/m]	Level [dBµV/m]	Limit [dBµV/m]	Margin [dB]	Angle [°]	Detector	Verdict	Polarity
1	2483.50	22.42	36.11	58.53	74.00	15.47	125	PK	PASS	Vertical
2	2483.50	10.59	36.11	46.70	54.00	7.30	31	AV	PASS	Vertical
3	2488.91	10.82	36.13	46.95	54.00	7.05	360	AV	PASS	Vertical
4	2488.91	23.04	36.13	59.17	74.00	14.83	296	PK	PASS	Vertical
5	2493.74	23.22	36.15	59.37	74.00	14.63	114	PK	PASS	Vertical
6	2493.74	10.52	36.15	46.67	54.00	7.33	197	AV	PASS	Vertical

Remark:

1. Level = Reading + Factor(Antenna Factor + Cable Loss – Preamplifier Factor).

Product Name:	Smart Phone	Product Model:	G1L
Test By:	Alan.Chen	Test mode:	BLE Tx (LE 2M PHY)
Test Channel:	Highest channel	Polarization:	Horizontal
Test Voltage:	AC 120/60Hz		

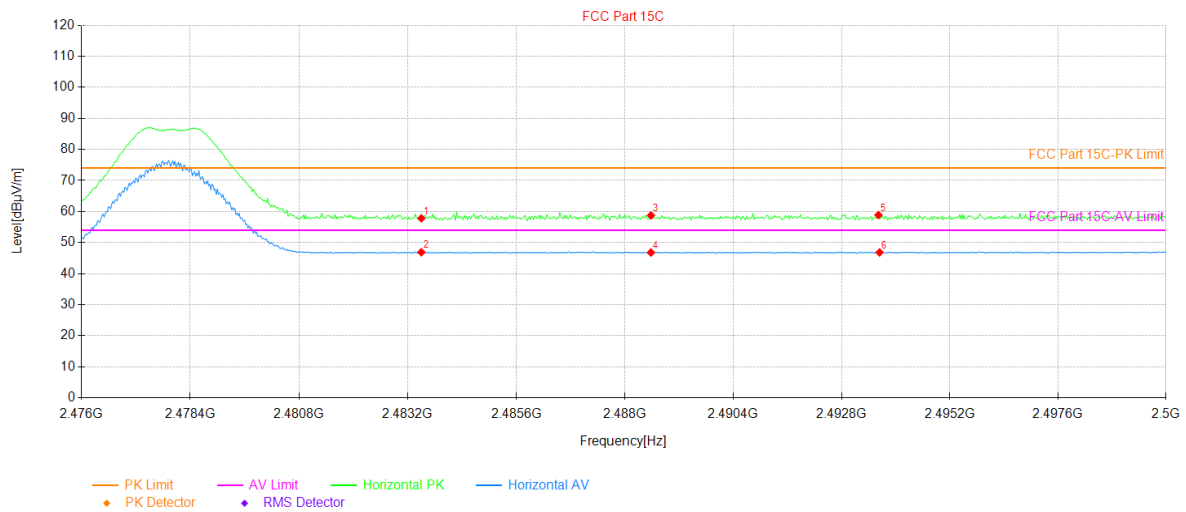

Suspected Data List										
NO.	Freq. [MHz]	Reading [dBµV]	Factor [dB/m]	Level [dBµV/m]	Limit [dBµV/m]	Margin [dB]	Angle [°]	Detector	Verdict	Polarity
1	2483.50	21.71	36.11	57.82	74.00	16.18	146	PK	PASS	Horizontal
2	2483.50	10.79	36.11	46.90	54.00	7.10	285	AV	PASS	Horizontal
3	2488.58	22.62	36.13	58.75	74.00	15.25	10	PK	PASS	Horizontal
4	2488.58	10.68	36.13	46.81	54.00	7.19	128	AV	PASS	Horizontal
5	2493.62	22.71	36.15	58.86	74.00	15.14	210	PK	PASS	Horizontal
6	2493.64	10.69	36.15	46.84	54.00	7.16	131	AV	PASS	Horizontal

Remark:

1. Level = Reading + Factor(Antenna Factor + Cable Loss – Preamplifier Factor).

Product Name:	Smart Phone	Product Model:	G1L
Test By:	Alan.Chen	Test mode:	BLE Tx (LE Coded PHY, S=2)
Test Channel:	Lowest channel	Polarization:	Vertical
Test Voltage:	AC 120/60Hz		

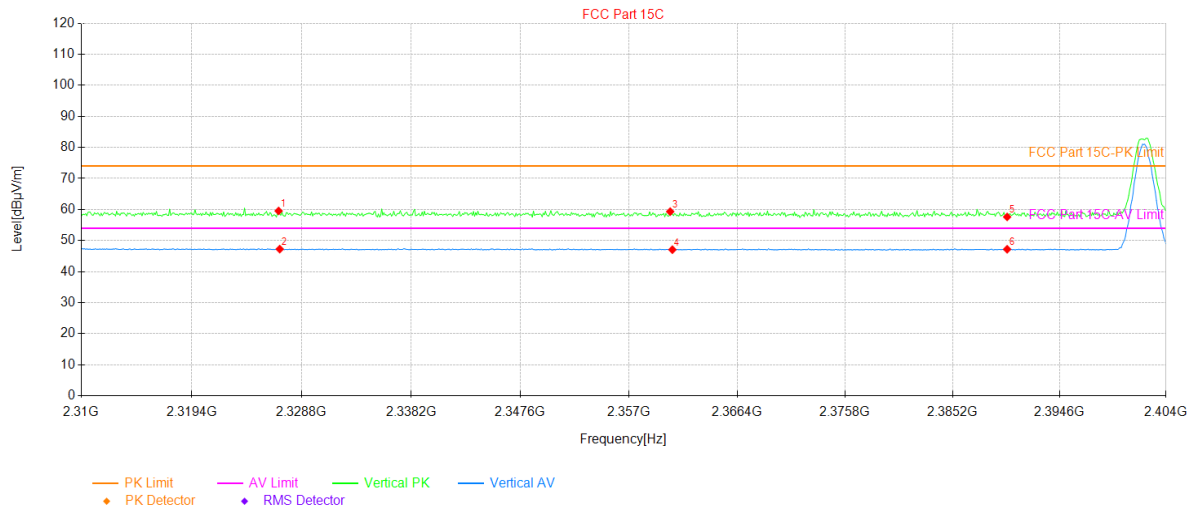

Suspected Data List										
NO.	Freq. [MHz]	Reading [dBµV]	Factor [dB/m]	Level [dBµV/m]	Limit [dBµV/m]	Margin [dB]	Angle [°]	Detector	Verdict	Polarity
1	2326.83	23.42	36.12	59.54	74.00	14.46	213	PK	PASS	Vertical
2	2326.92	11.14	36.12	47.26	54.00	6.74	356	AV	PASS	Vertical
3	2360.57	23.01	36.32	59.33	74.00	14.67	111	PK	PASS	Vertical
4	2360.76	10.75	36.32	47.07	54.00	6.93	129	AV	PASS	Vertical
5	2390.00	21.15	36.47	57.62	74.00	16.38	296	PK	PASS	Vertical
6	2390.00	10.74	36.47	47.21	54.00	6.79	224	AV	PASS	Vertical

Remark:

1. Level = Reading + Factor(Antenna Factor + Cable Loss – Preamplifier Factor).

Product Name:	Smart Phone	Product Model:	G1L
Test By:	Alan.Chen	Test mode:	BLE Tx (LE Coded PHY, S=2)
Test Channel:	Lowest channel	Polarization:	Horizontal
Test Voltage:	AC 120/60Hz		

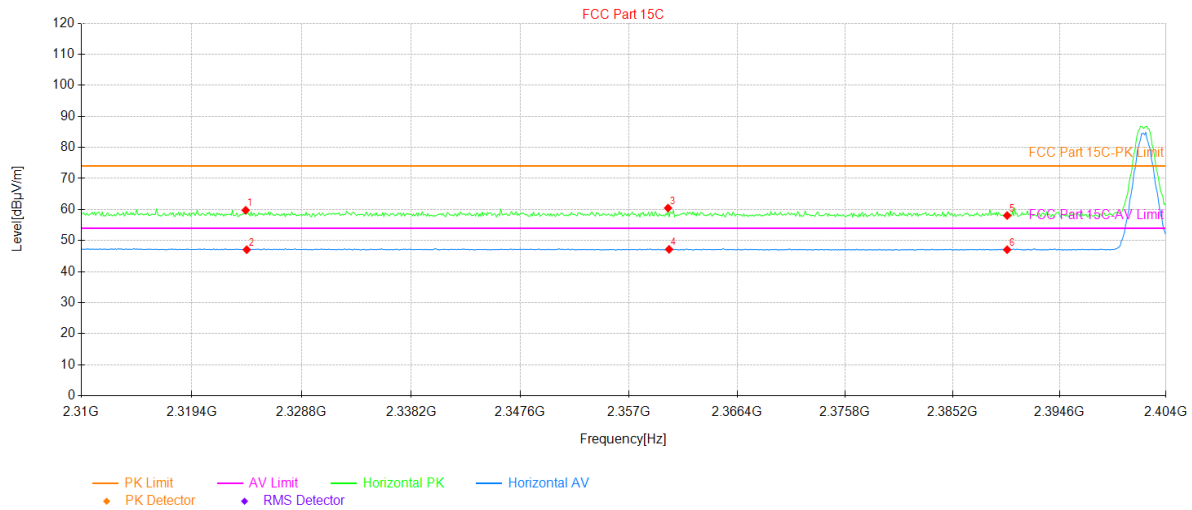

Suspected Data List										
NO.	Freq. [MHz]	Reading [dBµV]	Factor [dB/m]	Level [dBµV/m]	Limit [dBµV/m]	Margin [dB]	Angle [°]	Detector	Verdict	Polarity
1	2324.01	23.65	36.12	59.77	74.00	14.23	288	PK	PASS	Horizontal
2	2324.10	10.95	36.12	47.07	54.00	6.93	91	AV	PASS	Horizontal
3	2360.38	24.16	36.32	60.48	74.00	13.52	38	PK	PASS	Horizontal
4	2360.48	10.85	36.32	47.17	54.00	6.83	12	AV	PASS	Horizontal
5	2390.00	21.61	36.47	58.08	74.00	15.92	337	PK	PASS	Horizontal
6	2390.00	10.60	36.47	47.07	54.00	6.93	175	AV	PASS	Horizontal

Remark:

1. Level = Reading + Factor(Antenna Factor + Cable Loss – Pre-amplifier Factor).

Product Name:	Smart Phone	Product Model:	G1L
Test By:	Alan.Chen	Test mode:	BLE Tx (LE Coded PHY, S=2)
Test Channel:	Highest channel	Polarization:	Vertical
Test Voltage:	AC 120/60Hz		

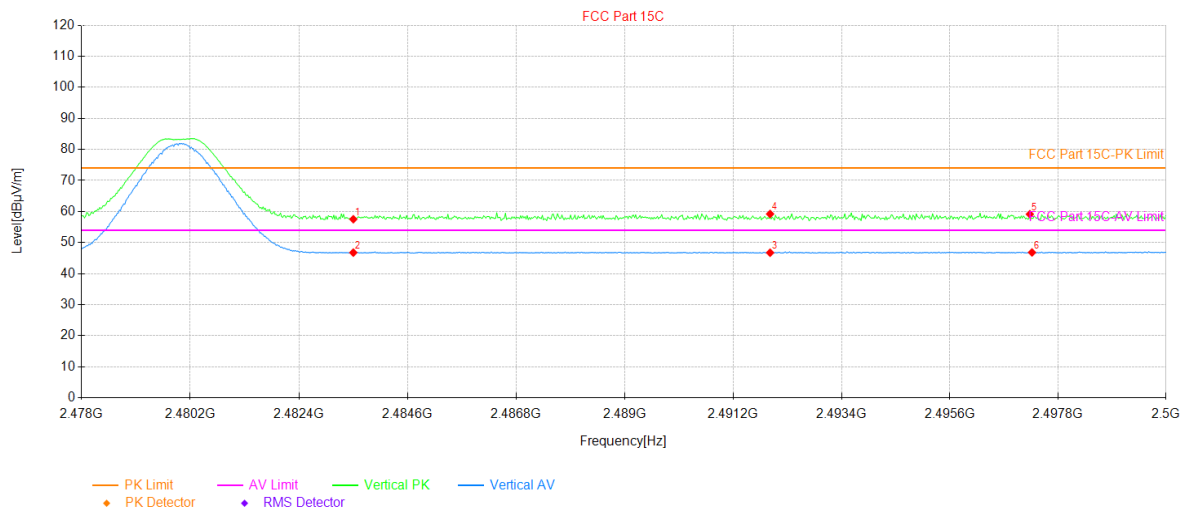

Suspected Data List										
NO.	Freq. [MHz]	Reading [dBµV]	Factor [dB/m]	Level [dBµV/m]	Limit [dBµV/m]	Margin [dB]	Angle [°]	Detector	Verdict	Polarity
1	2483.50	21.42	36.11	57.53	74.00	16.47	324	PK	PASS	Vertical
2	2483.50	10.66	36.11	46.77	54.00	7.23	305	AV	PASS	Vertical
3	2491.95	10.60	36.14	46.74	54.00	7.26	260	AV	PASS	Vertical
4	2491.95	23.08	36.14	59.22	74.00	14.78	95	PK	PASS	Vertical
5	2497.23	22.97	36.17	59.14	74.00	14.86	357	PK	PASS	Vertical
6	2497.27	10.66	36.17	46.83	54.00	7.17	234	AV	PASS	Vertical

Remark:

1. Level = Reading + Factor(Antenna Factor + Cable Loss – Pre-amplifier Factor).

Product Name:	Smart Phone	Product Model:	G1L
Test By:	Alan.Chen	Test mode:	BLE Tx (LE Coded PHY, S=2)
Test Channel:	Highest channel	Polarization:	Horizontal
Test Voltage:	AC 120/60Hz		

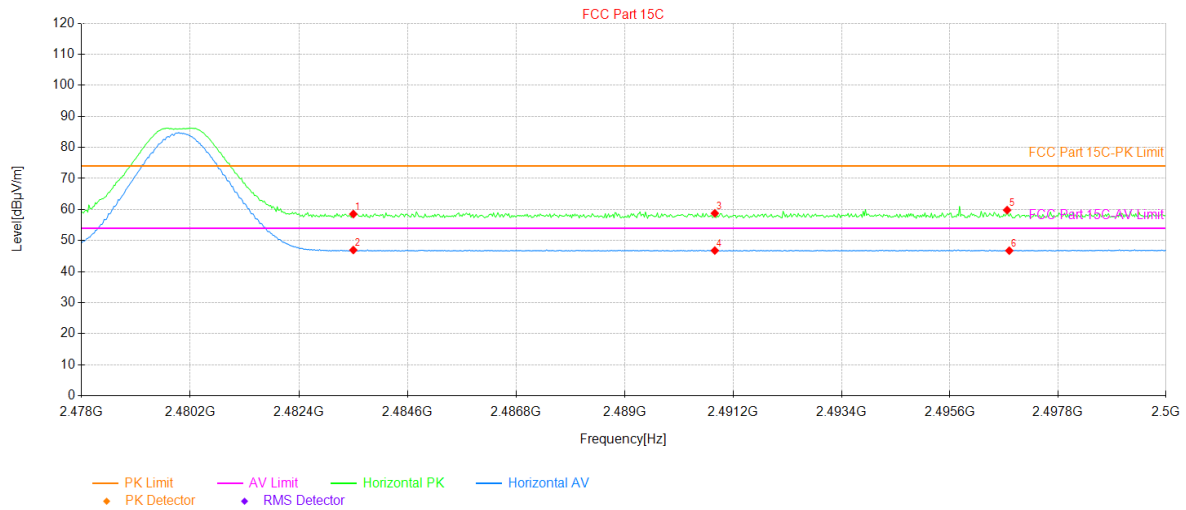

Suspected Data List

NO.	Freq. [MHz]	Reading [dBµV]	Factor [dB/m]	Level [dBµV/m]	Limit [dBµV/m]	Margin [dB]	Angle [°]	Detector	Verdict	Polarity
1	2483.50	22.44	36.11	58.55	74.00	15.45	108	PK	PASS	Horizontal
2	2483.50	10.85	36.11	46.96	54.00	7.04	334	AV	PASS	Horizontal
3	2490.83	22.66	36.14	58.80	74.00	15.20	240	PK	PASS	Horizontal
4	2490.83	10.65	36.14	46.79	54.00	7.21	292	AV	PASS	Horizontal
5	2496.77	23.66	36.16	59.82	74.00	14.18	198	PK	PASS	Horizontal
6	2496.81	10.60	36.16	46.76	54.00	7.24	8	AV	PASS	Horizontal

Remark:

1. Level = Reading + Factor(Antenna Factor + Cable Loss – Preamplifier Factor).

Product Name:	Smart Phone	Product Model:	G1L
Test By:	Alan.Chen	Test mode:	BLE Tx (LE Coded PHY, S=8)
Test Channel:	Lowest channel	Polarization:	Vertical
Test Voltage:	AC 120/60Hz		

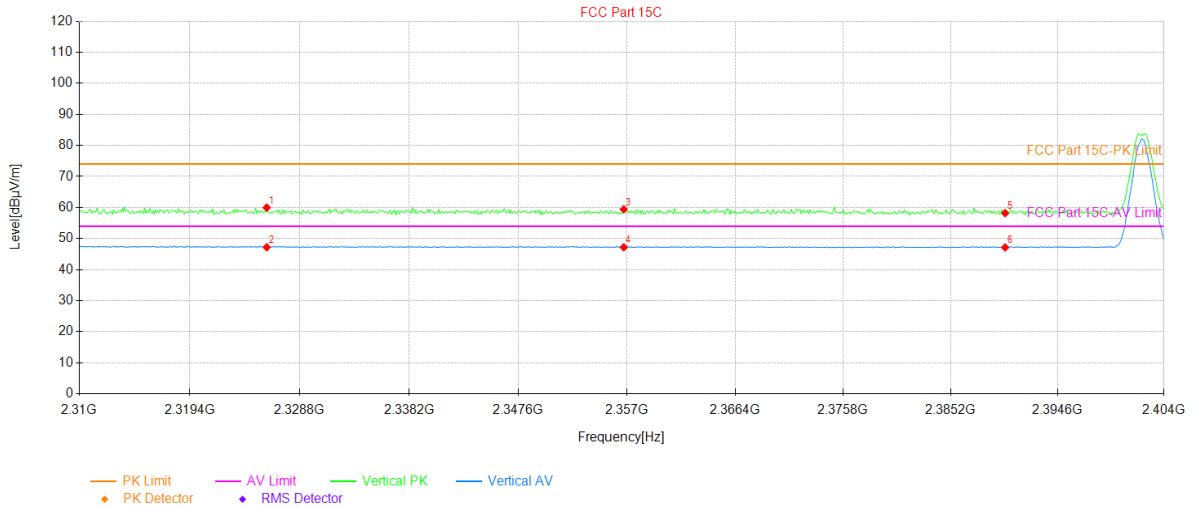

Suspected Data List										
NO.	Freq. [MHz]	Reading [dBµV]	Factor [dB/m]	Level [dBµV/m]	Limit [dBµV/m]	Margin [dB]	Angle [°]	Detector	Verdict	Polarity
1	2325.98	23.85	36.12	59.97	74.00	14.03	358	PK	PASS	Vertical
2	2325.98	11.09	36.12	47.21	54.00	6.79	256	AV	PASS	Vertical
3	2356.72	23.13	36.30	59.43	74.00	14.57	270	PK	PASS	Vertical
4	2356.72	10.90	36.30	47.20	54.00	6.80	145	AV	PASS	Vertical
5	2390.00	21.72	36.47	58.19	74.00	15.81	11	PK	PASS	Vertical
6	2390.00	10.69	36.47	47.16	54.00	6.84	170	AV	PASS	Vertical

Remark:

1. Level = Reading + Factor(Antenna Factor + Cable Loss – Pre-amplifier Factor).

Product Name:	Smart Phone	Product Model:	G1L
Test By:	Alan.Chen	Test mode:	BLE Tx (LE Coded PHY, S=8)
Test Channel:	Lowest channel	Polarization:	Horizontal
Test Voltage:	AC 120/60Hz		

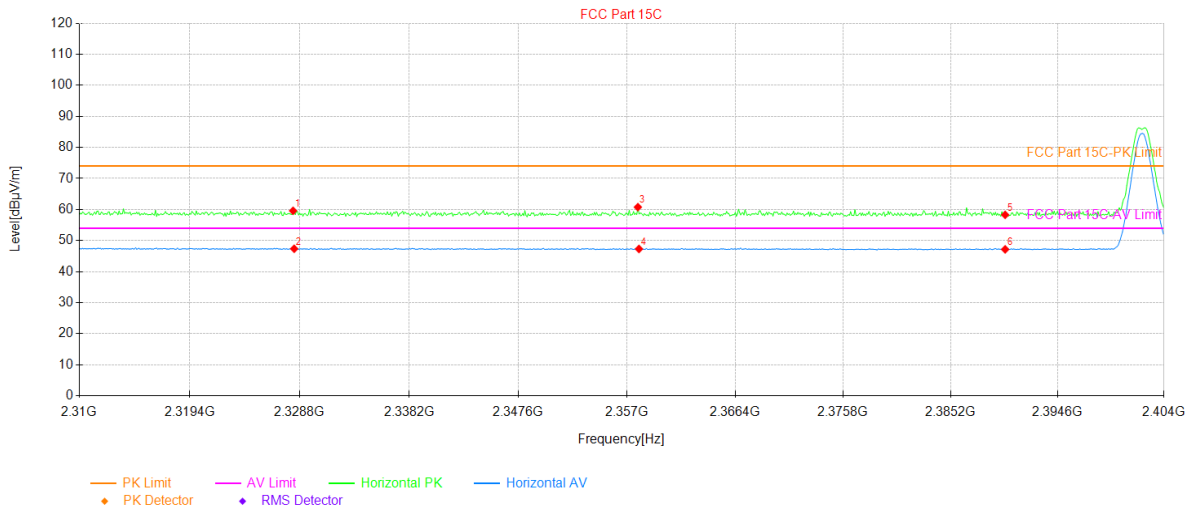

Suspected Data List										
NO.	Freq. [MHz]	Reading [dBµV]	Factor [dB/m]	Level [dBµV/m]	Limit [dBµV/m]	Margin [dB]	Angle [°]	Detector	Verdict	Polarity
1	2328.24	23.47	36.12	59.59	74.00	14.41	59	PK	PASS	Horizontal
2	2328.33	11.25	36.12	47.37	54.00	6.63	283	AV	PASS	Horizontal
3	2357.94	24.47	36.31	60.78	74.00	13.22	230	PK	PASS	Horizontal
4	2358.03	11.00	36.31	47.31	54.00	6.69	347	AV	PASS	Horizontal
5	2390.00	21.82	36.47	58.29	74.00	15.71	339	PK	PASS	Horizontal
6	2390.00	10.71	36.47	47.18	54.00	6.82	144	AV	PASS	Horizontal

Remark:

1. Level = Reading + Factor(Antenna Factor + Cable Loss – Pre-amplifier Factor).

Product Name:	Smart Phone	Product Model:	G1L
Test By:	Alan.Chen	Test mode:	BLE Tx (LE Coded PHY, S=8)
Test Channel:	Highest channel	Polarization:	Vertical
Test Voltage:	AC 120/60Hz		

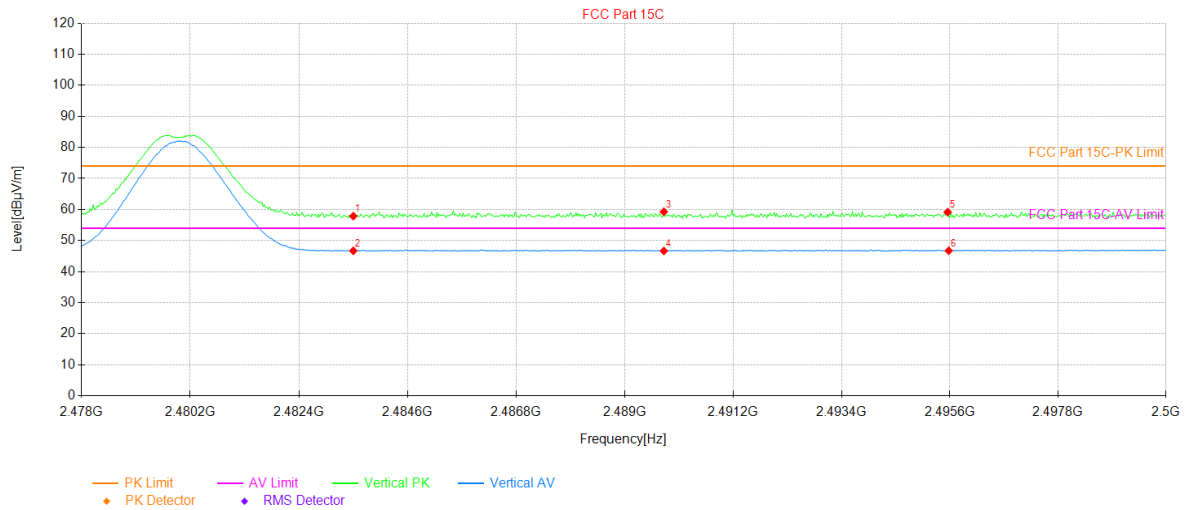

Suspected Data List										
NO.	Freq. [MHz]	Reading [dBµV]	Factor [dB/m]	Level [dBµV/m]	Limit [dBµV/m]	Margin [dB]	Angle [°]	Detector	Verdict	Polarity
1	2483.50	21.76	36.11	57.87	74.00	16.13	153	PK	PASS	Vertical
2	2483.50	10.60	36.11	46.71	54.00	7.29	209	AV	PASS	Vertical
3	2489.79	23.16	36.13	59.29	74.00	14.71	183	PK	PASS	Vertical
4	2489.79	10.54	36.13	46.67	54.00	7.33	329	AV	PASS	Vertical
5	2495.56	23.02	36.16	59.18	74.00	14.82	355	PK	PASS	Vertical
6	2495.58	10.58	36.16	46.74	54.00	7.26	134	AV	PASS	Vertical

Remark:

1. Level = Reading + Factor(Antenna Factor + Cable Loss – Pre-amplifier Factor).

Product Name:	Smart Phone	Product Model:	G1L
Test By:	Alan.Chen	Test mode:	BLE Tx (LE Coded PHY, S=8)
Test Channel:	Highest channel	Polarization:	Horizontal
Test Voltage:	AC 120/60Hz		

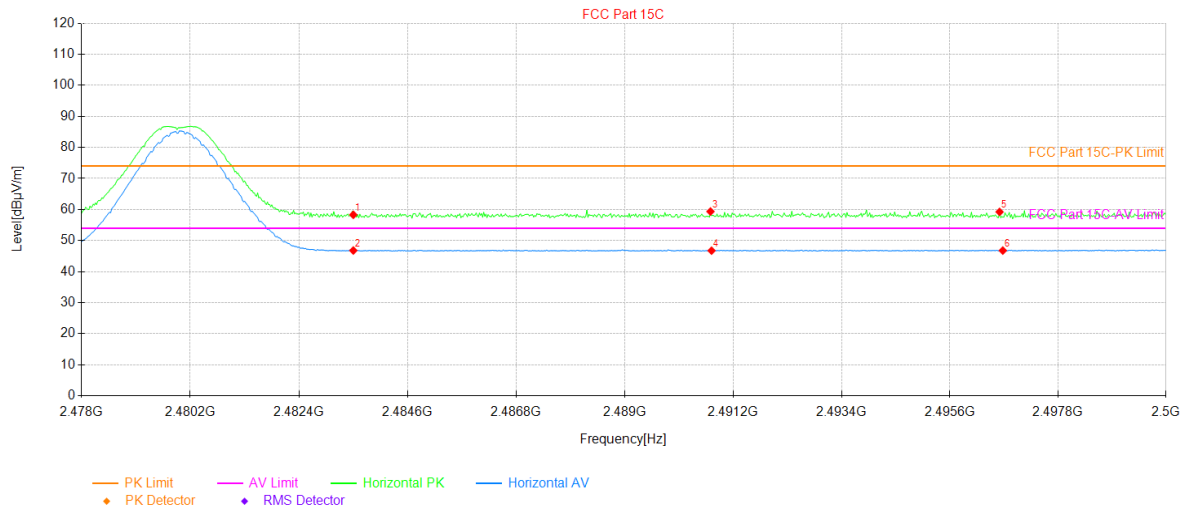

Suspected Data List

NO.	Freq. [MHz]	Reading [dBµV]	Factor [dB/m]	Level [dBµV/m]	Limit [dBµV/m]	Margin [dB]	Angle [°]	Detector	Verdict	Polarity
1	2483.50	22.20	36.11	58.31	74.00	15.69	300	PK	PASS	Horizontal
2	2483.50	10.70	36.11	46.81	54.00	7.19	192	AV	PASS	Horizontal
3	2490.74	23.22	36.14	59.36	74.00	14.64	181	PK	PASS	Horizontal
4	2490.76	10.62	36.14	46.76	54.00	7.24	341	AV	PASS	Horizontal
5	2496.61	23.08	36.16	59.24	74.00	14.76	358	PK	PASS	Horizontal
6	2496.68	10.63	36.16	46.79	54.00	7.21	349	AV	PASS	Horizontal

Remark:

1. Level = Reading + Factor(Antenna Factor + Cable Loss – Preamplifier Factor).

5.5 Emissions in Non-restricted Frequency Bands

Below 1GHz:

Product Name:	Smart Phone	Product Model:	G1L
Test By:	Kiran.Zeng	Test mode:	BLE Tx (LE 1M PHY)
Test Frequency:	30 MHz ~ 1 GHz	Polarization:	Vertical & Horizontal
Test Voltage:	AC 120/60Hz		

Full Spectrum

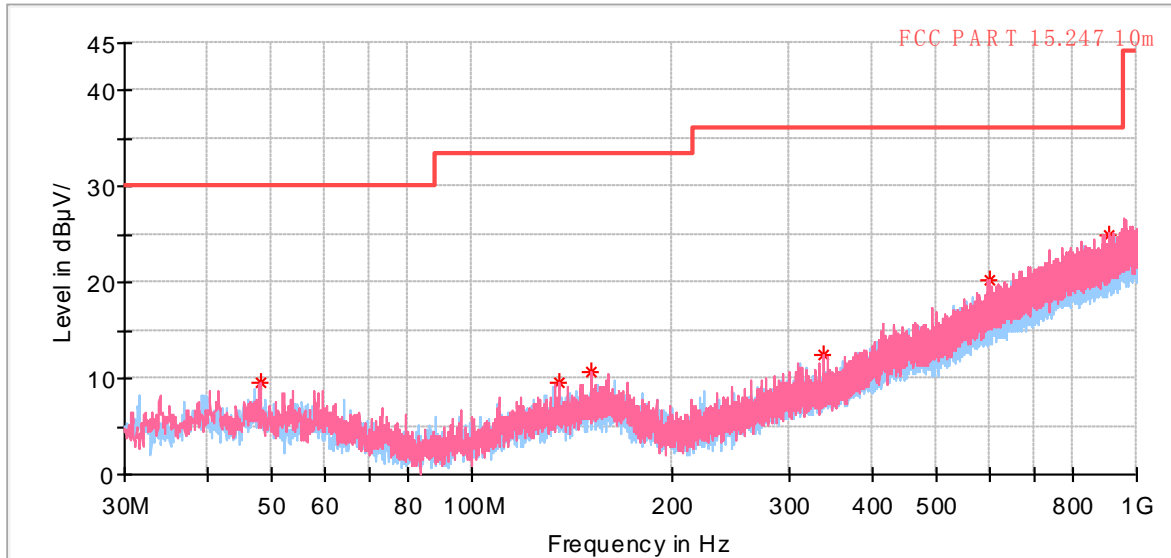

Critical_Freqs

Frequency (MHz)	MaxPeak (dB µ V/m)	Limit (dB µ V/m)	Margin (dB)	Height (cm)	Pol	Azimuth (deg)	Corr. (dB/m)
47.945000	9.57	30.00	20.43	100.0	V	40.0	-16.5
134.808500	9.48	33.50	24.02	100.0	V	244.0	-16.4
151.250000	10.80	33.50	22.70	100.0	V	152.0	-15.2
338.799500	12.44	36.00	23.56	100.0	V	0.0	-14.4
601.136000	20.22	36.00	15.78	100.0	V	22.0	-6.5
908.626000	24.86	36.00	11.14	100.0	V	46.0	-1.1

Remark:

1. Level = Reading + Factor(Antenna Factor + Cable Loss – Pre-amplifier Factor).

Above 1GHz:

BLE Tx (LE 1M PHY)						
Test channel: Lowest channel						
Detector: Peak Value						
Frequency (MHz)	Read Level (dBμV)	Factor (dB)	Level (dBμV/m)	Limit (dBμV/m)	Margin (dB)	Polarization
4804.00	49.24	-8.00	41.24	74.00	32.76	Vertical
4804.00	49.68	-8.00	41.68	74.00	32.32	Horizontal
Detector: Average Value						
Frequency (MHz)	Read Level (dBμV)	Factor (dB)	Level (dBμV/m)	Limit (dBμV/m)	Margin (dB)	Polarization
4804.00	39.56	-8.00	31.56	54.00	22.44	Vertical
4804.00	39.68	-8.00	31.68	54.00	22.32	Horizontal
Test channel: Middle channel						
Detector: Peak Value						
Frequency (MHz)	Read Level (dBμV)	Factor (dB)	Level (dBμV/m)	Limit (dBμV/m)	Margin (dB)	Polarization
4884.00	49.49	-7.45	42.04	74.00	31.96	Vertical
4884.00	49.85	-7.45	42.40	74.00	31.60	Horizontal
Detector: Average Value						
Frequency (MHz)	Read Level (dBμV)	Factor (dB)	Level (dBμV/m)	Limit (dBμV/m)	Margin (dB)	Polarization
4884.00	39.86	-7.45	32.41	54.00	21.59	Vertical
4884.00	39.44	-7.45	31.99	54.00	22.01	Horizontal
Test channel: Highest channel						
Detector: Peak Value						
Frequency (MHz)	Read Level (dBμV)	Factor (dB)	Level (dBμV/m)	Limit (dBμV/m)	Margin (dB)	Polarization
4960.00	48.93	-7.08	41.85	74.00	32.15	Vertical
4960.00	49.66	-7.08	42.58	74.00	31.42	Horizontal
Detector: Average Value						
Frequency (MHz)	Read Level (dBμV)	Factor (dB)	Level (dBμV/m)	Limit (dBμV/m)	Margin (dB)	Polarization
4960.00	39.74	-7.08	32.66	54.00	21.34	Vertical
4960.00	39.85	-7.08	32.77	54.00	21.23	Horizontal
Remark:						
1. Level = Reading + Factor.						
2. Test Frequency up to 25GHz, and the emission levels of other frequencies are lower than the limit 20dB, not show in test report.						

BLE Tx (LE 2M PHY)						
Test channel: Lowest channel						
Detector: Peak Value						
Frequency (MHz)	Read Level (dBμV)	Factor (dB)	Level (dBμV/m)	Limit (dBμV/m)	Margin (dB)	Polarization
4804.00	49.71	-8.00	41.71	74.00	32.29	Vertical
4804.00	49.95	-8.00	41.95	74.00	32.05	Horizontal
Detector: Average Value						
Frequency (MHz)	Read Level (dBμV)	Factor (dB)	Level (dBμV/m)	Limit (dBμV/m)	Margin (dB)	Polarization
4804.00	39.39	-8.00	31.39	54.00	22.61	Vertical
4804.00	39.3	-8.00	31.30	54.00	22.70	Horizontal
Test channel: Middle channel						
Detector: Peak Value						
Frequency (MHz)	Read Level (dBμV)	Factor (dB)	Level (dBμV/m)	Limit (dBμV/m)	Margin (dB)	Polarization
4884.00	49.15	-7.45	41.70	74.00	32.30	Vertical
4884.00	50.16	-7.45	42.71	74.00	31.29	Horizontal
Detector: Average Value						
Frequency (MHz)	Read Level (dBμV)	Factor (dB)	Level (dBμV/m)	Limit (dBμV/m)	Margin (dB)	Polarization
4884.00	39.22	-7.45	31.77	54.00	22.23	Vertical
4884.00	39.33	-7.45	31.88	54.00	22.12	Horizontal
Test channel: Highest channel						
Detector: Peak Value						
Frequency (MHz)	Read Level (dBμV)	Factor (dB)	Level (dBμV/m)	Limit (dBμV/m)	Margin (dB)	Polarization
4960.00	48.97	-7.08	41.89	74.00	32.11	Vertical
4960.00	49.79	-7.08	42.71	74.00	31.29	Horizontal
Detector: Average Value						
Frequency (MHz)	Read Level (dBμV)	Factor (dB)	Level (dBμV/m)	Limit (dBμV/m)	Margin (dB)	Polarization
4960.00	39.71	-7.08	32.63	54.00	21.37	Vertical
4960.00	39.66	-7.08	32.58	54.00	21.42	Horizontal
Remark:						
1. Level = Reading + Factor.						
2. Test Frequency up to 25GHz, and the emission levels of other frequencies are lower than the limit 20dB, not show in test report.						

BEL Tx (LE Coded PHY, S=2)						
Test channel: Lowest channel						
Detector: Peak Value						
Frequency (MHz)	Read Level (dBμV)	Factor (dB)	Level (dBμV/m)	Limit (dBμV/m)	Margin (dB)	Polarization
4804.00	49.06	-8.00	41.06	74.00	32.94	Vertical
4804.00	49.33	-8.00	41.33	74.00	32.67	Horizontal
Detector: Average Value						
Frequency (MHz)	Read Level (dBμV)	Factor (dB)	Level (dBμV/m)	Limit (dBμV/m)	Margin (dB)	Polarization
4804.00	39.22	-8.00	31.22	54.00	22.78	Vertical
4804.00	39.35	-8.00	31.35	54.00	22.65	Horizontal
Test channel: Middle channel						
Detector: Peak Value						
Frequency (MHz)	Read Level (dBμV)	Factor (dB)	Level (dBμV/m)	Limit (dBμV/m)	Margin (dB)	Polarization
4884.00	49.06	-7.45	41.61	74.00	32.39	Vertical
4884.00	49.25	-7.45	41.80	74.00	32.20	Horizontal
Detector: Average Value						
Frequency (MHz)	Read Level (dBμV)	Factor (dB)	Level (dBμV/m)	Limit (dBμV/m)	Margin (dB)	Polarization
4884.00	39.85	-7.45	32.40	54.00	21.60	Vertical
4884.00	39.76	-7.45	32.31	54.00	21.69	Horizontal
Test channel: Highest channel						
Detector: Peak Value						
Frequency (MHz)	Read Level (dBμV)	Factor (dB)	Level (dBμV/m)	Limit (dBμV/m)	Margin (dB)	Polarization
4960.00	49.67	-7.08	42.59	74.00	31.41	Vertical
4960.00	50.13	-7.08	43.05	74.00	30.95	Horizontal
Detector: Average Value						
Frequency (MHz)	Read Level (dBμV)	Factor (dB)	Level (dBμV/m)	Limit (dBμV/m)	Margin (dB)	Polarization
4960.00	39.47	-7.08	32.39	54.00	21.61	Vertical
4960.00	40.17	-7.08	33.09	54.00	20.91	Horizontal
Remark:						
1. Level = Reading + Factor.						
2. Test Frequency up to 25GHz, and the emission levels of other frequencies are lower than the limit 20dB, not show in test report.						

BEL Tx (LE Coded PHY, S=8)						
Test channel: Lowest channel						
Detector: Peak Value						
Frequency (MHz)	Read Level (dBμV)	Factor (dB)	Level (dBμV/m)	Limit (dBμV/m)	Margin (dB)	Polarization
4804.00	49.63	-8.00	41.63	74.00	32.37	Vertical
4804.00	49.36	-8.00	41.36	74.00	32.64	Horizontal
Detector: Average Value						
Frequency (MHz)	Read Level (dBμV)	Factor (dB)	Level (dBμV/m)	Limit (dBμV/m)	Margin (dB)	Polarization
4804.00	39.96	-8.00	31.96	54.00	22.04	Vertical
4804.00	39.56	-8.00	31.56	54.00	22.44	Horizontal
Test channel: Middle channel						
Detector: Peak Value						
Frequency (MHz)	Read Level (dBμV)	Factor (dB)	Level (dBμV/m)	Limit (dBμV/m)	Margin (dB)	Polarization
4884.00	49.13	-7.45	41.68	74.00	32.32	Vertical
4884.00	49.39	-7.45	41.94	74.00	32.06	Horizontal
Detector: Average Value						
Frequency (MHz)	Read Level (dBμV)	Factor (dB)	Level (dBμV/m)	Limit (dBμV/m)	Margin (dB)	Polarization
4884.00	39.47	-7.45	32.02	54.00	21.98	Vertical
4884.00	39.42	-7.45	31.97	54.00	22.03	Horizontal
Test channel: Highest channel						
Detector: Peak Value						
Frequency (MHz)	Read Level (dBμV)	Factor (dB)	Level (dBμV/m)	Limit (dBμV/m)	Margin (dB)	Polarization
4960.00	48.86	-7.08	41.78	74.00	32.22	Vertical
4960.00	50.01	-7.08	42.93	74.00	31.07	Horizontal
Detector: Average Value						
Frequency (MHz)	Read Level (dBμV)	Factor (dB)	Level (dBμV/m)	Limit (dBμV/m)	Margin (dB)	Polarization
4960.00	39.63	-7.08	32.55	54.00	21.45	Vertical
4960.00	39.69	-7.08	32.61	54.00	21.39	Horizontal
Remark:						
1. Level = Reading + Factor.						
2. Test Frequency up to 25GHz, and the emission levels of other frequencies are lower than the limit 20dB, not show in test report.						

-----End of report-----