

FCC REPORT

(Bluetooth)

Applicant: SWAGTKG

Address of Applicant: 10205 NW 19th St. Suite 101, Miami, FL, 33172

Equipment Under Test (EUT)

Product Name: 6.0 inch 4G Smart Phone

Model No.: L60, RAPTOR, N60

Trade mark: LOGIC, iSWAG, UNONU

FCC ID: O55604619

Applicable standards: FCC CFR Title 47 Part 15 Subpart C Section 15.247

Date of sample receipt: 04 Dec., 2019

Date of Test: 05 Dec., to 11 Dec., 2019

Date of report issued: 02 Jan., 2020

Test Result: PASS *

* In the configuration tested, the EUT complied with the standards specified above.

Authorized Signature:



Bruce Zhang
Laboratory Manager

This report details the results of the testing carried out on one sample. The results contained in this test report do not relate to other samples of the same product and does not permit the use of the CCIS product certification mark. The manufacturer should ensure that all products in series production are in conformity with the product sample detailed in this report.

This report may only be reproduced and distributed in full. If the product in this report is used in any configuration other than that detailed in the report, the manufacturer must ensure the new system complies with all relevant standards.

This document cannot be reproduced except in full, without prior written approval of the Company. Any unauthorized alteration, forgery or falsification of the content or appearance of this document is unlawful and offenders may be prosecuted to the fullest extent of the law. Unless otherwise stated the results shown in this test report refer only to the sample(s) tested and such sample(s) are retained for 90 days only.

2 Version

Version No.	Date	Description
00	12 Dec., 2019	Original
01	02 Jan., 2020	Update Page 4, 33~44

Tested by:

Mike.ou

Date:

02 Jan., 2020

Test Engineer

Reviewed by:

Winner Zhang

Date:

02 Jan., 2020

Project Engineer

3 Contents

	Page
1 COVER PAGE	1
2 VERSION	2
3 CONTENTS	3
4 TEST SUMMARY	4
5 GENERAL INFORMATION	5
5.1 CLIENT INFORMATION.....	5
5.2 GENERAL DESCRIPTION OF E.U.T.	5
5.3 TEST ENVIRONMENT AND TEST MODE	6
5.4 DESCRIPTION OF SUPPORT UNITS	6
5.5 MEASUREMENT UNCERTAINTY.....	6
5.6 ADDITIONS TO, DEVIATIONS, OR EXCLUSIONS FROM THE METHOD	6
5.7 LABORATORY FACILITY.....	6
5.8 LABORATORY LOCATION.....	6
5.9 TEST INSTRUMENTS LIST	7
6 TEST RESULTS AND MEASUREMENT DATA	8
6.1 ANTENNA REQUIREMENT.....	8
6.2 CONDUCTED EMISSIONS	9
6.3 CONDUCTED OUTPUT POWER	12
6.4 20dB OCCUPY BANDWIDTH.....	15
6.5 CARRIER FREQUENCIES SEPARATION	18
6.6 HOPPING CHANNEL NUMBER.....	22
6.7 DWELL TIME	24
6.8 PSEUDORANDOM FREQUENCY HOPPING SEQUENCE	27
6.9 BAND EDGE.....	28
6.9.1 Conducted Emission Method.....	28
6.9.2 Radiated Emission Method.....	32
6.10 SPURIOUS EMISSION.....	45
6.10.1 Conducted Emission Method.....	45
6.10.2 Radiated Emission Method.....	48
7 TEST SETUP PHOTO	53
8 EUT CONSTRUCTIONAL DETAILS	54

4 Test Summary

Test Items	Section in CFR 47	Result
Antenna Requirement	15.203 & 15.247 (b)	Pass
AC Power Line Conducted Emission	15.207	Pass
Conducted Peak Output Power	15.247 (b)(1)	Pass
20dB Occupied Bandwidth	15.247 (a)(1)	Pass
Carrier Frequencies Separation	15.247 (a)(1)	Pass
Hopping Channel Number	15.247 (a)(1)	Pass
Dwell Time	15.247 (a)(1)	Pass
Spurious Emission	15.205 & 15.209	Pass
Band Edge	15.247(d)	Pass
<p>Remark:</p> <ol style="list-style-type: none"> 1. Pass: The EUT complies with the essential requirements in the standard. 2. N/A: Not Applicable. 3. The cable insertion loss used by "RF Output Power" and other conduction measurement items is 0.5dB (provided by the customer). 		
Test Method:	ANSI C63.10-2013 KDB 558074 D01 15.247 Meas Guidance v05r02	

5 General Information

5.1 Client Information

Applicant:	SWAGTKG
Address:	10205 NW 19th St. Suite 101, Miami, FL, 33172
Manufacturer/ Factory:	SWAGTKG
Address:	10205 NW 19th St. Suite 101, Miami, FL, 33172

5.2 General Description of E.U.T.

Product Name:	6.0 inch 4G Smart Phone
Model No.:	L60, RAPTOR, N60
Operation Frequency:	2402MHz~2480MHz
Transfer rate:	1/2/3 Mbits/s
Number of channel:	79
Modulation type:	GFSK, $\pi/4$ -DQPSK, 8DPSK
Modulation technology:	FHSS
Antenna Type:	Internal Antenna
Antenna gain:	1.05dBi
Power supply:	Rechargeable Li-ion Battery DC3.8V-3000mAh
AC adapter:	Model: TPA-98B050100UU01 Input: AC100-240V, 50/60Hz, 0.15A Output: DC 5.0V, 1A
Test Sample Condition:	The test samples were provided in good working order with no visible defects.
Remark:	Model No.: L60, RAPTOR, N60, were identical inside, the electrical circuit design, layout, components used and internal wiring. The difference between them is as follows: L60 model corresponds to the trademark LOGIC. RAPTOR model correspond to the trademark iSWAG. N60 model corresponds to the trademark UNONU.

Operation Frequency each of channel for GFSK, $\pi/4$ -DQPSK, 8DPSK							
Channel	Frequency	Channel	Frequency	Channel	Frequency	Channel	Frequency
0	2402MHz	20	2422MHz	40	2442MHz	60	2462MHz
1	2403MHz	21	2423MHz	41	2443MHz	61	2463MHz
2	2404MHz	22	2424MHz	42	2444MHz	62	2464MHz
3	2405MHz	23	2425MHz	43	2445MHz	63	2465MHz
4	2406MHz	24	2426MHz	44	2446MHz	64	2466MHz
5	2407MHz	25	2427MHz	45	2447MHz	65	2467MHz
...
15	2417MHz	35	2437MHz	55	2457MHz	75	2477MHz
16	2418MHz	36	2438MHz	56	2458MHz	76	2478MHz
17	2419MHz	37	2439MHz	57	2459MHz	77	2479MHz
18	2420MHz	38	2440MHz	58	2460MHz	78	2480MHz
19	2421MHz	39	2441MHz	59	2461MHz		

Remark: Channel 0, 39 & 78 selected for GFSK, $\pi/4$ -DQPSK and 8DPSK.

5.3 Test environment and test mode

Operating Environment:	
Temperature:	24.0 °C
Humidity:	54 % RH
Atmospheric Pressure:	1010 mbar
Test Modes:	
Non-hopping mode:	Keep the EUT in continuous transmitting mode with worst case data rate.
Hopping mode:	Keep the EUT in hopping mode.
Remark	GFSK (1 Mbps) is the worst case mode.
<p>The sample was placed 0.8m (below 1GHz)/1.5m (above 1GHz) above the ground plane of 3m chamber*. Measurements in both horizontal and vertical polarities were performed. During the test, each emission was maximized by: having the EUT continuously working, investigated all operating modes, rotated about all 3 axis (X, Y & Z) and considered typical configuration to obtain worst position, manipulating interconnecting cables, rotating the turntable, varying antenna height from 1m to 4m in both horizontal and vertical polarizations. The emissions worst-case are shown in Test Results of the following pages.</p>	

5.4 Description of Support Units

The EUT has been tested as an independent unit.

5.5 Measurement Uncertainty

Parameters	Expanded Uncertainty
Conducted Emission (9kHz ~ 30MHz)	±1.60 dB (k=2)
Radiated Emission (9kHz ~ 30MHz)	±3.12 dB (k=2)
Radiated Emission (30MHz ~ 1000MHz)	±4.32 dB (k=2)
Radiated Emission (1GHz ~ 18GHz)	±5.38 dB (k=2)
Radiated Emission (18GHz ~ 40GHz)	±3.36 dB (k=2)

5.6 Additions to, deviations, or exclusions from the method

No

5.7 Laboratory Facility

The test facility is recognized, certified, or accredited by the following organizations:

● **FCC - Designation No.: CN1211**

Shenzhen Zhongjian Nanfang Testing Co., Ltd. has been accredited as a testing laboratory by FCC(Federal Communications Commission). The test firm Registration No. is 727551.

● **ISED – CAB identifier.: CN0021**

The 3m Semi-anechoic chamber of Shenzhen Zhongjian Nanfang Testing Co., Ltd. has been Registered by Certification and Engineering Bureau of Industry Canada for radio equipment testing with Registration No.: 10106A-1.

● **CNAS - Registration No.: CNAS L6048**

Shenzhen Zhongjian Nanfang Testing Co., Ltd. is accredited to ISO/IEC 17025:2005 General Requirements for the Competence of Testing and Calibration laboratories for the competence of testing. The Registration No. is CNAS L6048.

● **A2LA - Registration No.: 4346.01**

This laboratory is accredited in accordance with the recognized International Standard ISO/IEC 17025:2005 General requirements for the competence of testing and calibration laboratories. The test scope can be found as below link: <https://portal.a2la.org/scopepdf/4346-01.pdf>

5.8 Laboratory Location

Shenzhen Zhongjian Nanfang Testing Co., Ltd.
 Address: No. B-C, 1/F., Building 2, Laodong No.2 Industrial Park, Xixiang Road,
 Bao'an District, Shenzhen, Guangdong, China
 Tel: +86-755-23118282, Fax: +86-755-23116366
 Email: info@ccis-cb.com, Website: http://www.ccis-cb.com

5.9 Test Instruments list

Radiated Emission:					
Test Equipment	Manufacturer	Model No.	Serial No.	Cal. Date (mm-dd-yy)	Cal. Due date (mm-dd-yy)
3m SAC	SAEMC	9m*6m*6m	966	07-22-2017	07-21-2020
Loop Antenna	SCHWARZBECK	FMZB1519B	00044	03-18-2019	03-17-2020
BiConiLog Antenna	SCHWARZBECK	VULB9163	497	03-18-2019	03-17-2020
Horn Antenna	SCHWARZBECK	BBHA9120D	916	03-18-2019	03-17-2020
Horn Antenna	SCHWARZBECK	BBHA9120D	1805	06-22-2017	06-21-2020
Horn Antenna	SCHWARZBECK	BBHA 9170	BBHA9170582	11-21-2019	11-20-2020
EMI Test Software	AUDIX	E3	Version: 6.110919b		
Pre-amplifier	HP	8447D	2944A09358	03-18-2019	03-17-2020
Pre-amplifier	CD	PAP-1G18	11804	03-18-2019	03-17-2020
Spectrum analyzer	Rohde & Schwarz	FSP30	101454	03-18-2019	03-17-2020
Spectrum analyzer	Rohde & Schwarz	FSP40	100363	11-21-2019	11-20-2020
EMI Test Receiver	Rohde & Schwarz	ESRP7	101070	03-18-2019	03-17-2020
Cable	ZDECL	Z108-NJ-NJ-81	1608458	03-18-2019	03-17-2020
Cable	MICRO-COAX	MFR64639	K10742-5	03-18-2019	03-17-2020
Cable	SUHNER	SUCOFLEX100	58193/4PE	03-18-2019	03-17-2020
RF Switch Unit	MWRFTTEST	MW200	N/A	N/A	N/A
Test Software	MWRFTTEST	MTS8200	Version: 2.0.0.0		

Conducted Emission:					
Test Equipment	Manufacturer	Model No.	Serial No.	Cal. Date (mm-dd-yy)	Cal. Due date (mm-dd-yy)
EMI Test Receiver	Rohde & Schwarz	ESCI	101189	03-18-2019	03-17-2020
Pulse Limiter	SCHWARZBECK	OSRAM 2306	9731	03-18-2019	03-17-2020
LISN	CHASE	MN2050D	1447	03-18-2019	03-17-2020
LISN	Rohde & Schwarz	ESH3-Z5	8438621/010	07-21-2018	07-20-2021
Cable	HP	10503A	N/A	03-18-2019	03-17-2020
EMI Test Software	AUDIX	E3	Version: 6.110919b		

6 Test results and measurement data

6.1 Antenna Requirement

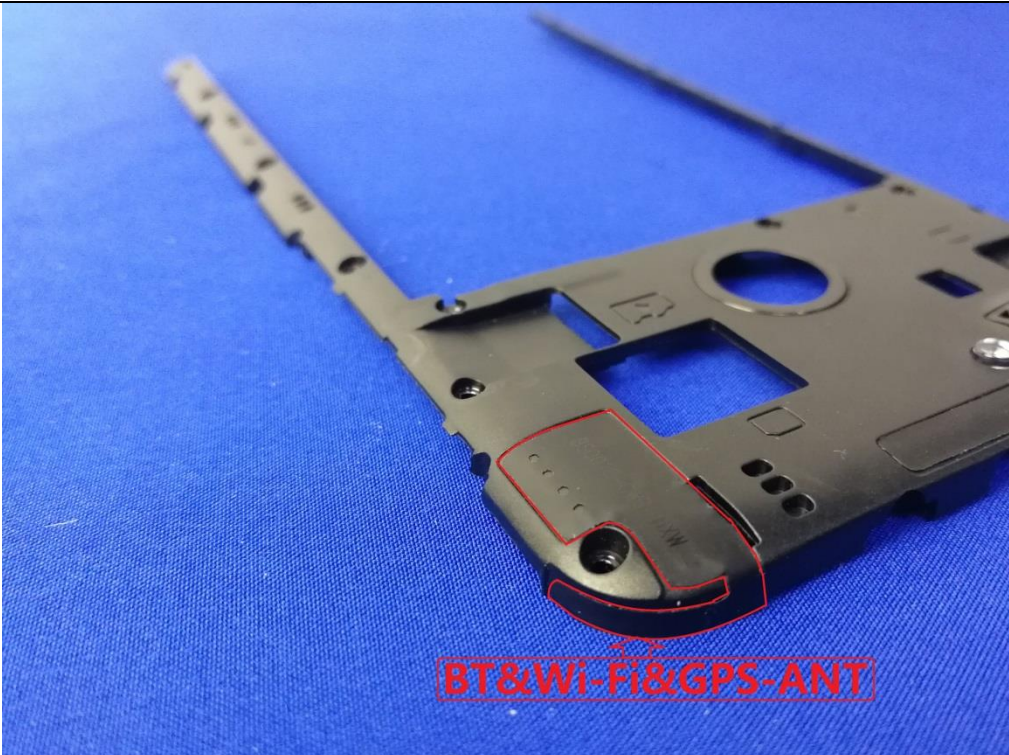
Standard requirement:	FCC Part 15 C Section 15.203 & 247(b)
<p>15.203 requirement: An intentional radiator shall be designed to ensure that no antenna other than that furnished by the responsible party shall be used with the device. The use of a permanently attached antenna or of an antenna that uses a unique coupling to the intentional radiator, the manufacturer may design the unit so that a broken antenna can be replaced by the user, but the use of a standard antenna jack or electrical connector is prohibited.</p> <p>15.247(b) (4) requirement: (4) The conducted output power limit specified in paragraph (b) of this section is based on the use of antennas with directional gains that do not exceed 6 dBi. Except as shown in paragraph (c) of this section, if transmitting antennas of directional gain greater than 6 dBi are used, the conducted output power from the intentional radiator shall be reduced below the stated values in paragraphs (b)(1), (b)(2), and (b)(3) of this section, as appropriate, by the amount in dB that the directional gain of the antenna exceeds 6 dBi.</p>	
E.U.T Antenna:	
<p>The Bluetooth antenna is an Internal antenna which permanently attached, and the best case gain of the antenna is 1.05 dBi.</p>	
	

6.2 Conducted Emissions

Test Requirement:	FCC Part 15 C Section 15.207		
Test Frequency Range:	150 kHz to 30 MHz		
Class / Severity:	Class B		
Receiver setup:	RBW=9 kHz, VBW=30 kHz, Sweep time=auto		
Limit:	Frequency range (MHz)	Limit (dBuV)	
		Quasi-peak	Average
	0.15-0.5	66 to 56*	56 to 46*
	0.5-5	56	46
	5-30	60	50
* Decreases with the logarithm of the frequency.			
Test setup:	<p>Remark E.U.T: Equipment Under Test LISN: Line Impedance Stabilization Network Test table height=0.8m</p>		
Test procedure:	<ol style="list-style-type: none"> 1. The E.U.T and simulators are connected to the main power through a line impedance stabilization network (L.I.S.N.). This provides a 50ohm/50uH coupling impedance for the measuring equipment. 2. The peripheral devices are also connected to the main power through a LISN that provides a 50ohm/50uH coupling impedance with 50ohm termination. (Please refer to the block diagram of the test setup and photographs). 3. Both sides of A.C. line are checked for maximum conducted interference. In order to find the maximum emission, the relative positions of equipment and all of the interface cables must be changed according to ANSI C63.10-2013 on conducted measurement. 		
Test Instruments:	Refer to section 5.9 for details		
Test mode:	Hopping mode		
Test results:	Pass		

Measurement Data:

Product name:	6.0 inch 4G Smart Phone	Product model:	L60
Test by:	Mike	Test mode:	BT Tx mode
Test frequency:	150 kHz ~ 30 MHz	Phase:	Line
Test voltage:	AC 120 V/60 Hz	Environment:	Temp: 22.5°C Humi: 55%

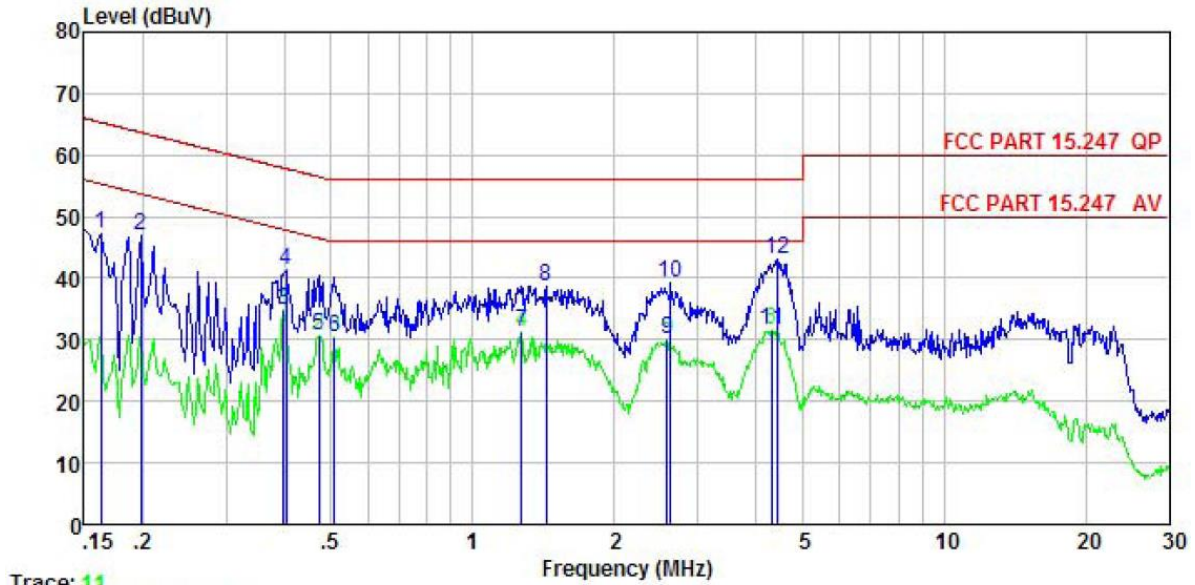

	Freq	Read Level	LISN Factor	Aux Factor	Cable Loss	Level	Limit Line	Over Limit	Remark
	MHz	dBuV	dB	dB	dB	dBuV	dBuV	dB	
1	0.162	36.86	-0.44	-0.08	10.77	47.11	65.34	-18.23	QP
2	0.198	36.64	-0.41	-0.16	10.76	46.83	63.71	-16.88	QP
3	0.398	24.16	-0.37	0.40	10.72	34.91	47.90	-12.99	Average
4	0.402	30.44	-0.37	0.42	10.72	41.21	57.81	-16.60	QP
5	0.471	20.48	-0.38	-0.15	10.75	30.70	46.49	-15.79	Average
6	0.510	20.38	-0.39	-0.35	10.76	30.40	46.00	-15.60	Average
7	1.269	20.54	-0.39	0.19	10.90	31.24	46.00	-14.76	Average
8	1.433	28.18	-0.40	0.06	10.92	38.76	56.00	-17.24	QP
9	2.581	19.99	-0.43	-0.25	10.93	30.24	46.00	-15.76	Average
10	2.636	29.04	-0.43	-0.25	10.93	39.29	56.00	-16.71	QP
11	4.315	21.10	-0.47	0.00	10.88	31.51	46.00	-14.49	Average
12	4.430	32.61	-0.47	0.01	10.87	43.02	56.00	-12.98	QP

Notes:

1. An initial pre-scan was performed on the line and neutral lines with peak detector.
2. Quasi-Peak and Average measurement were performed at the frequencies with maximized peak emission.
3. Final Level = Receiver Read level + LISN Factor + Cable Loss.

Product name:	6.0 inch 4G Smart Phone	Product model:	L60
Test by:	Mike	Test mode:	BT Tx mode
Test frequency:	150 kHz ~ 30 MHz	Phase:	Neutral
Test voltage:	AC 120 V/60 Hz	Environment:	Temp: 22.5°C Humi: 55%

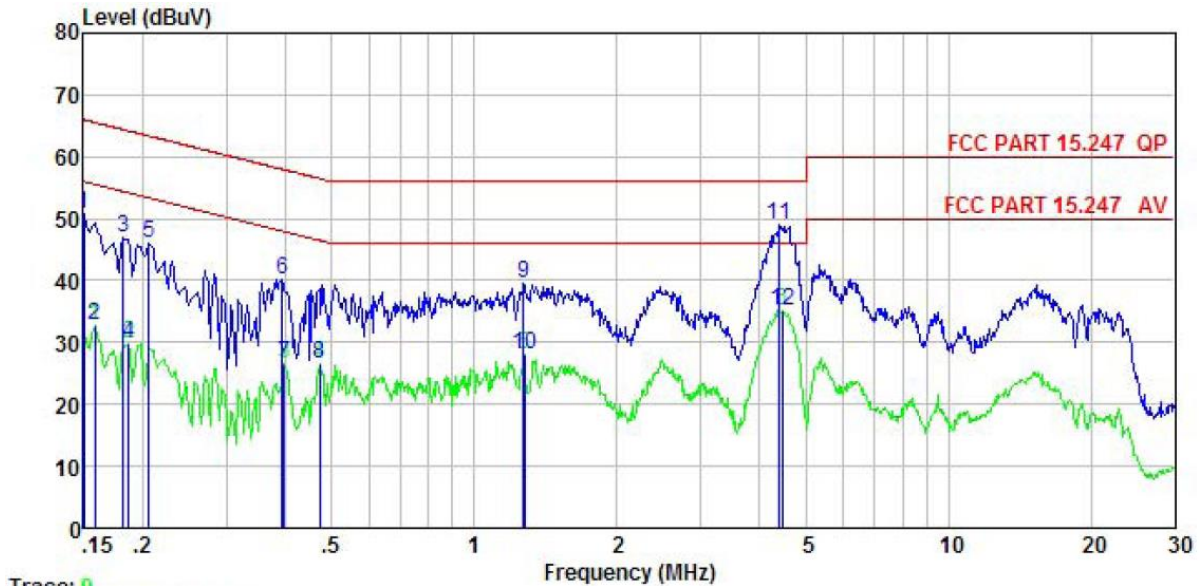

Trace: 9

	Freq	Read Level	LISN Factor	Aux Factor	Cable Loss	Level	Limit Line	Over Limit	Remark
	MHz	dBuV	dB	dB	dB	dBuV	dBuV	dB	
1	0.150	40.58	-0.68	0.01	10.78	50.69	66.00	-15.31	QP
2	0.158	22.65	-0.68	0.01	10.77	32.75	55.56	-22.81	Average
3	0.182	36.71	-0.69	0.00	10.77	46.79	64.42	-17.63	QP
4	0.186	19.71	-0.69	0.00	10.76	29.78	54.20	-24.42	Average
5	0.206	35.84	-0.69	0.00	10.76	45.91	63.36	-17.45	QP
6	0.393	30.08	-0.64	-0.06	10.72	40.10	57.99	-17.89	QP
7	0.398	16.54	-0.64	-0.06	10.72	26.56	47.90	-21.34	Average
8	0.471	16.36	-0.65	0.01	10.75	26.47	46.49	-20.02	Average
9	1.269	29.23	-0.64	0.11	10.90	39.60	56.00	-16.40	QP
10	1.276	17.63	-0.64	0.11	10.90	28.00	46.00	-18.00	Average
11	4.407	38.21	-0.71	0.58	10.87	48.95	56.00	-7.05	QP
12	4.454	24.42	-0.71	0.59	10.87	35.17	46.00	-10.83	Average

Notes:

1. An initial pre-scan was performed on the line and neutral lines with peak detector.
2. Quasi-Peak and Average measurement were performed at the frequencies with maximized peak emission.
3. Final Level = Receiver Read level + LISN Factor + Cable Loss.

6.3 Conducted Output Power

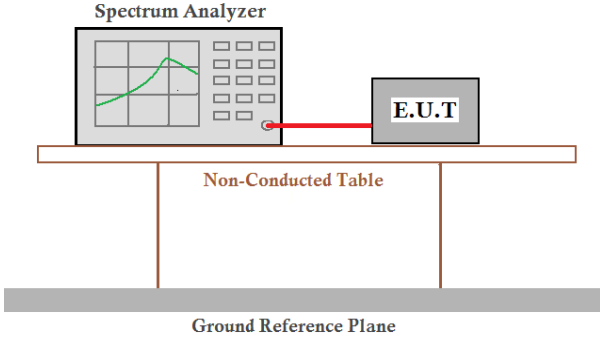
Test Requirement:	FCC Part 15 C Section 15.247 (b)(1)
Receiver setup:	RBW=1MHz, VBW=3MHz, Detector=Peak (If 20dB BW ≤1 MHz) RBW=3MHz, VBW=10MHz, Detector=Peak (If 20dB BW > 1 MHz and < 3MHz)
Limit:	For frequency hopping systems operating in the 2400-2483.5 MHz band employing at least 75 non-overlapping hopping channels: 1 watt. For all other frequency hopping systems in the 2400-2483.5 MHz band: 0.125 watts.
Test setup:	 <p>The diagram illustrates the test setup. A Spectrum Analyzer is connected via a red cable to an E.U.T. (Equipment Under Test). Both are placed on a Non-Conducted Table. This table is supported by a Ground Reference Plane.</p>
Test Instruments:	Refer to section 5.9 for details
Test mode:	Non-hopping mode
Test results:	Pass

Measurement Data:

Test channel	Peak Output Power (dBm)	Limit (dBm)	Result
GFSK mode			
Lowest channel	5.89	30.00	Pass
Middle channel	3.61	30.00	Pass
Highest channel	1.55	30.00	Pass
π/4-DQPSK mode			
Lowest channel	5.73	21.00	Pass
Middle channel	4.02	21.00	Pass
Highest channel	2.00	21.00	Pass
8DPSK mode			
Lowest channel	5.70	21.00	Pass
Middle channel	4.05	21.00	Pass
Highest channel	2.09	21.00	Pass

Test plot as follows:

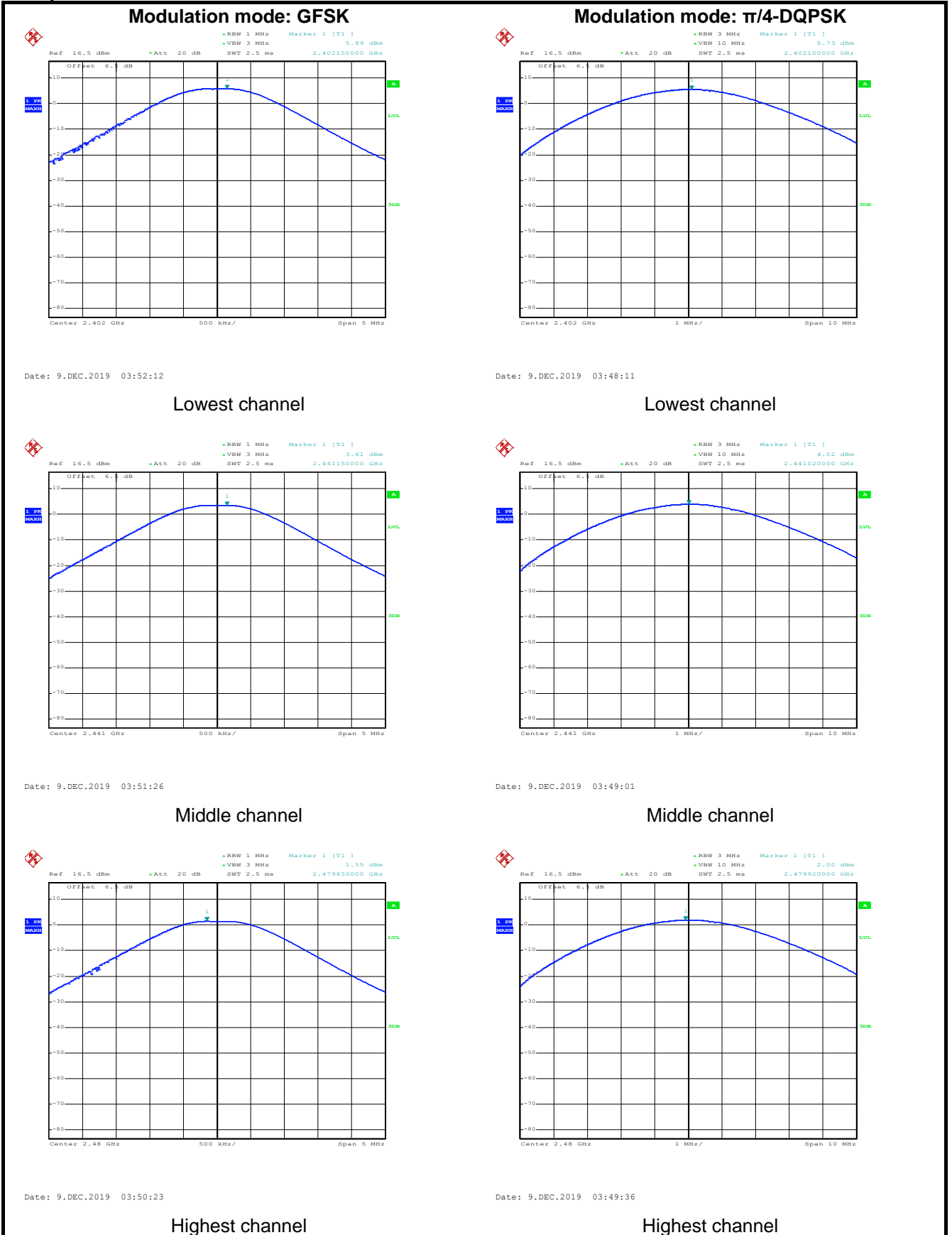

Modulation mode: 8DPSK

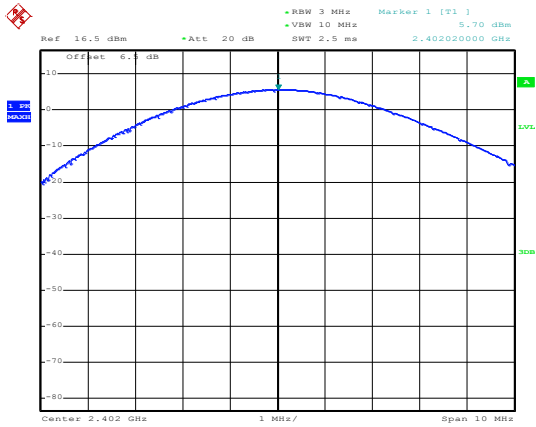

Date: 9.DEC.2019 03:47:27

Lowest channel

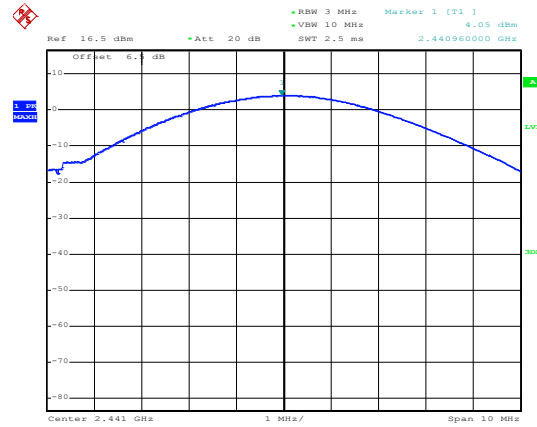

Date: 9.DEC.2019 03:46:51

Middle channel

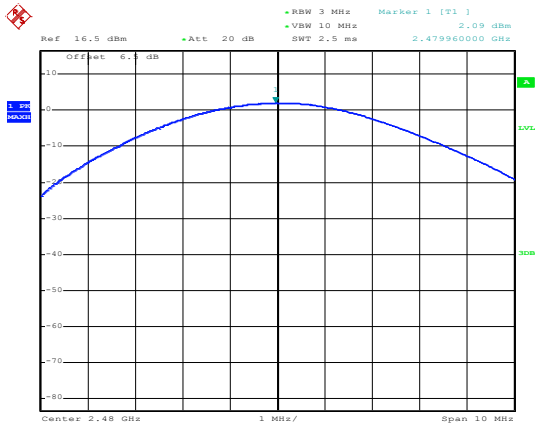

Date: 9.DEC.2019 03:46:13

Highest channel

6.4 20dB Occupy Bandwidth

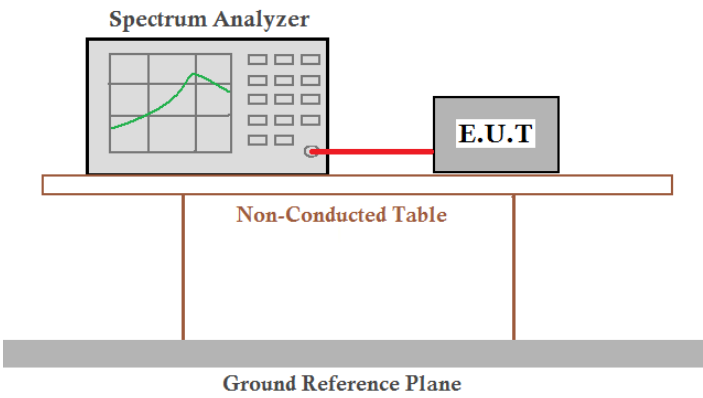
Test Requirement:	FCC Part 15 C Section 15.247 (a)(1)
Receiver setup:	RBW=30 kHz, VBW=100 kHz, detector=Peak
Limit:	N/A
Test setup:	
Test Instruments:	Refer to section 5.9 for details
Test mode:	Non-hopping mode
Test results:	Pass

Measurement Data:

Test channel	20dB Occupy Bandwidth (kHz)		
	GFSK	$\pi/4$ -DQPSK	8DPSK
Lowest	676	1122	1176
Middle	676	1122	1170
Highest	676	1122	1176

Test plot as follows:

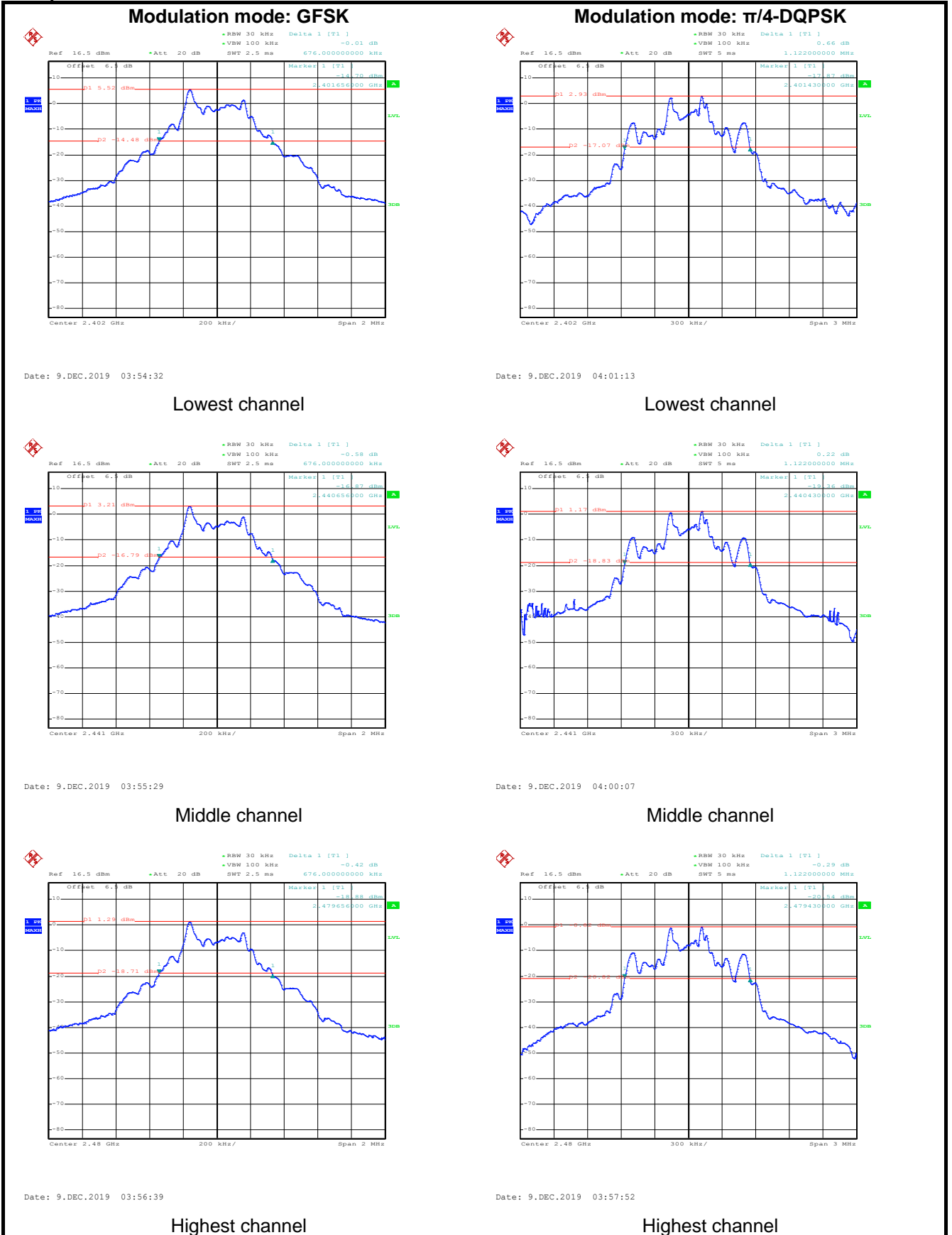

Modulation mode: 8DPSK

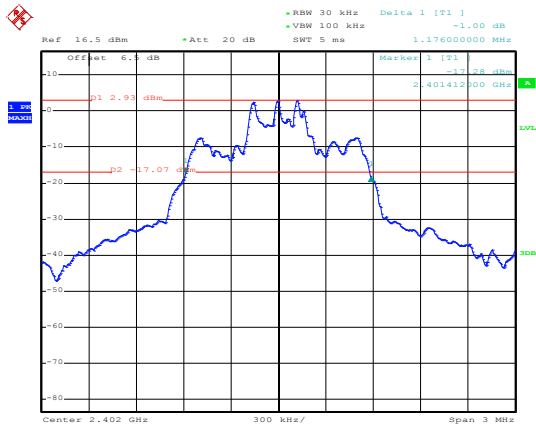

Date: 9.DEC.2019 04:09:29

Lowest channel

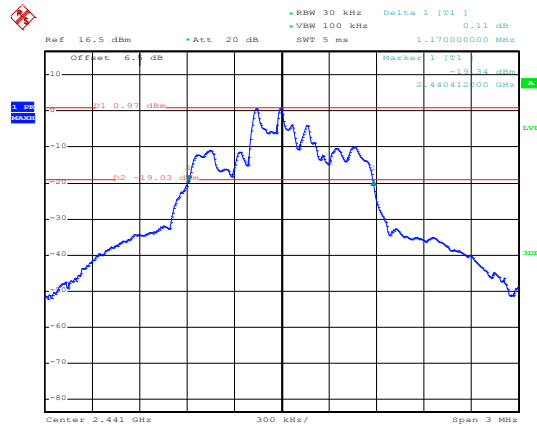

Date: 9.DEC.2019 04:10:50

Middle channel

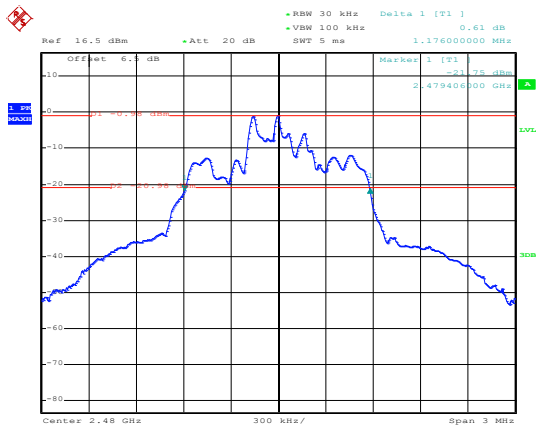

Date: 9.DEC.2019 04:12:17

Highest channel

6.5 Carrier Frequencies Separation

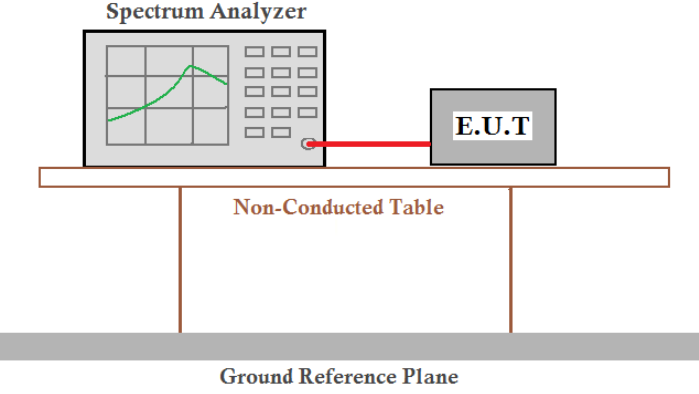
Test Requirement:	FCC Part 15 C Section 15.247 (a)(1)
Receiver setup:	RBW=100 kHz, VBW=300 kHz, detector=Peak
Limit:	a) 0.025MHz or the 20dB bandwidth (whichever is greater) b) 0.025MHz or two-thirds of the 20dB bandwidth (whichever is greater)
Test setup:	 <p>The diagram illustrates the test setup. A Spectrum Analyzer is connected to an E.U.T. (Equipment Under Test) via a red cable. Both are placed on a Non-Conducted Table, which is supported by two legs. Below the table is a Ground Reference Plane.</p>
Test Instruments:	Refer to section 5.9 for details
Test mode:	Hopping mode
Test results:	Pass

Measurement Data:

Test channel	Carrier Frequencies Separation (kHz)	Limit (kHz)	Result
GFSK			
Lowest	1004	676.00	Pass
Middle	1000	676.00	Pass
Highest	1000	676.00	Pass
$\pi/4$ -DQPSK mode			
Lowest	1004	748.00	Pass
Middle	1004	748.00	Pass
Highest	1000	748.00	Pass
8DPSK mode			
Lowest	1004	784.00	Pass
Middle	1000	784.00	Pass
Highest	1000	784.00	Pass

Note: According to section 6.4

Mode	20dB bandwidth (kHz) (worse case)	Limit (kHz) (Carrier Frequencies Separation)
GFSK	676	676.00
$\pi/4$ -DQPSK	1122	748.00
8DPSK	1176	784.00

Test plot as follows:

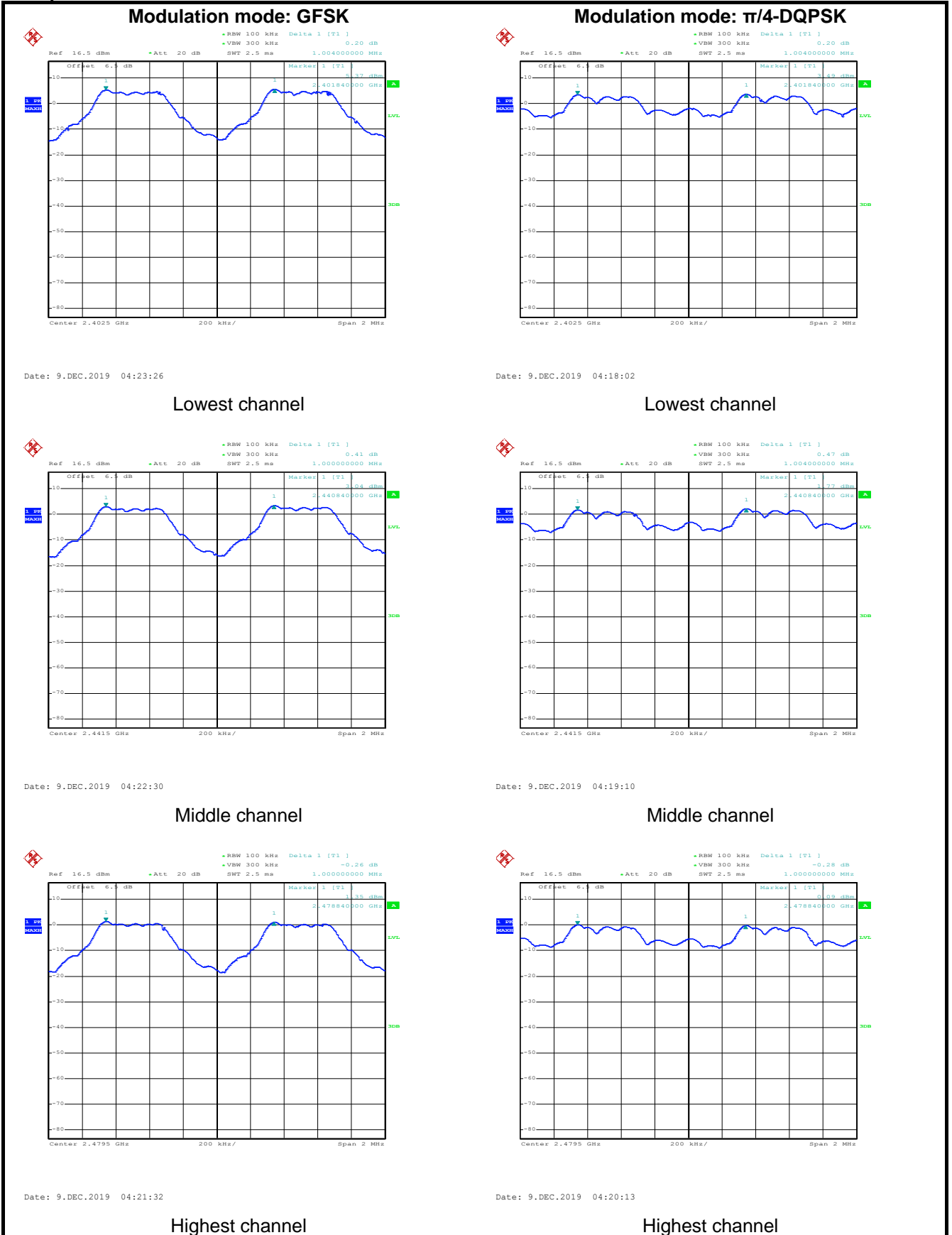

Modulation mode: 8DPSK

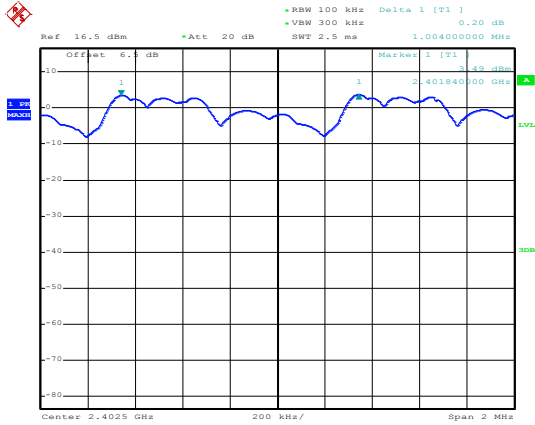

Date: 9.DEC.2019 04:16:28

Lowest channel

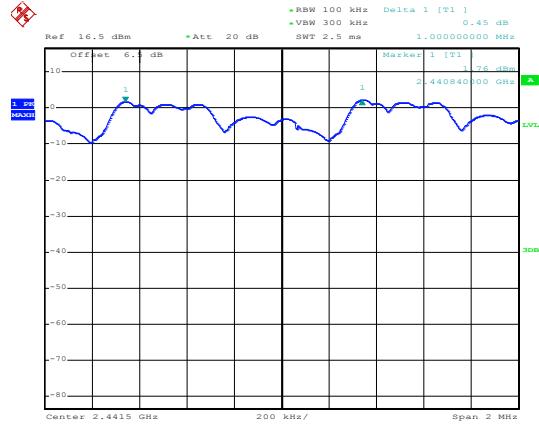

Date: 9.DEC.2019 04:15:08

Middle channel

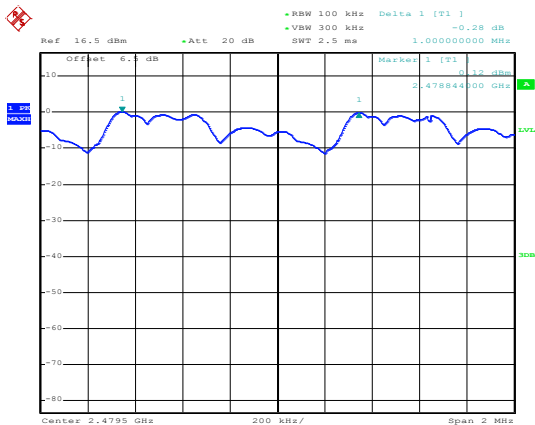

Date: 9.DEC.2019 04:14:10

Highest channel

6.6 Hopping Channel Number

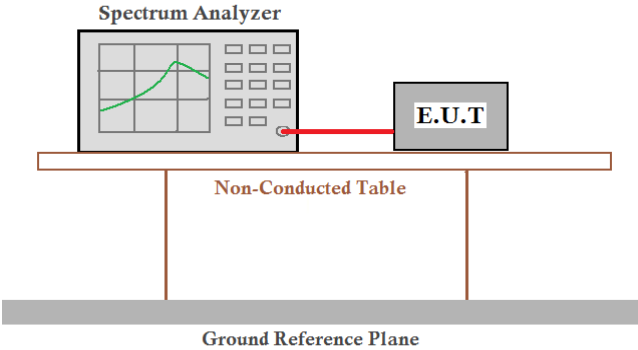
Test Requirement:	FCC Part 15 C Section 15.247 (a)(1)
Receiver setup:	RBW=100 kHz, VBW=300 kHz, Frequency range=2400MHz-2483.5MHz, Detector=Peak
Limit:	15 channels
Test setup:	 <p>The diagram illustrates the test setup. A Spectrum Analyzer is connected to an E.U.T. (Equipment Under Test) via a red cable. Both are placed on a Non-Conducted Table, which is supported by a Ground Reference Plane.</p>
Test Instruments:	Refer to section 5.9 for details
Test mode:	Hopping mode
Test results:	Pass

Measurement Data:

Mode	Hopping channel numbers	Limit	Result
GFSK, $\pi/4$ -DQPSK, 8DPSK	79	15	Pass

Test plot as follows:

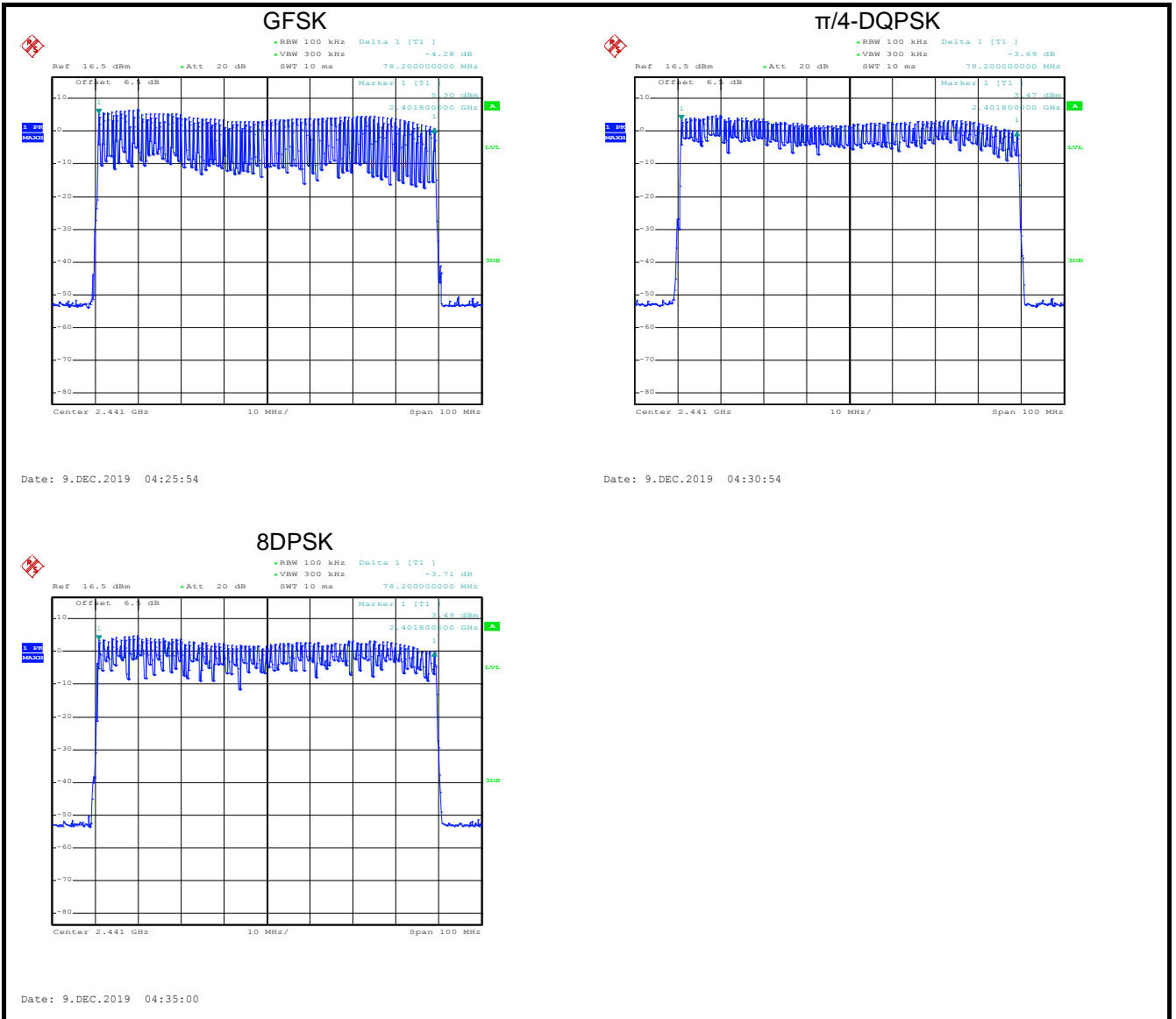

6.7 Dwell Time

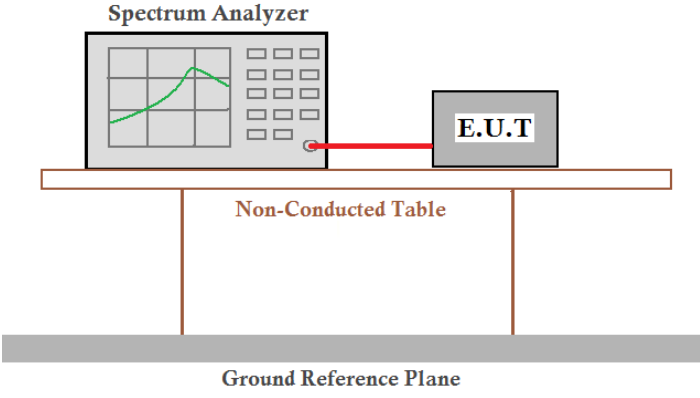
Test Requirement:	FCC Part 15 C Section 15.247 (a)(1)
Receiver setup:	RBW=1 MHz, VBW=1 MHz, Span=0 Hz, Detector=Peak
Limit:	0.4 Second
Test setup:	
Test Instruments:	Refer to section 5.9 for details
Test mode:	Hopping mode
Test results:	Pass

Measurement Data (Worse case):

Mode	Packet	Dwell time (second)	Limit (second)	Result
GFSK	DH1	0.13248	0.4	Pass
	DH3	0.26976		
	DH5	0.31403		
π/4-DQPSK	2-DH1	0.13056	0.4	Pass
	2-DH3	0.26784		
	2-DH5	0.31317		
8DPSK	3-DH1	0.12992	0.4	Pass
	3-DH3	0.26784		
	3-DH5	0.31232		

Note:

The test period = 0.4 Second/Channel x 79 Channel = 31.6 s

Calculation Formula: Dwell time = Ton time per hop * Hopping numbers * Period

For example:

DH1 time slot=0.416*(1600/ (2*79)) * 31.6=132.48ms

DH3 time slot=1.686*(1600/ (4*79)) * 31.6=269.76ms

DH5 time slot=2.952*(1600/ (6*79)) * 31.6=314.03ms

Test plot as follows:

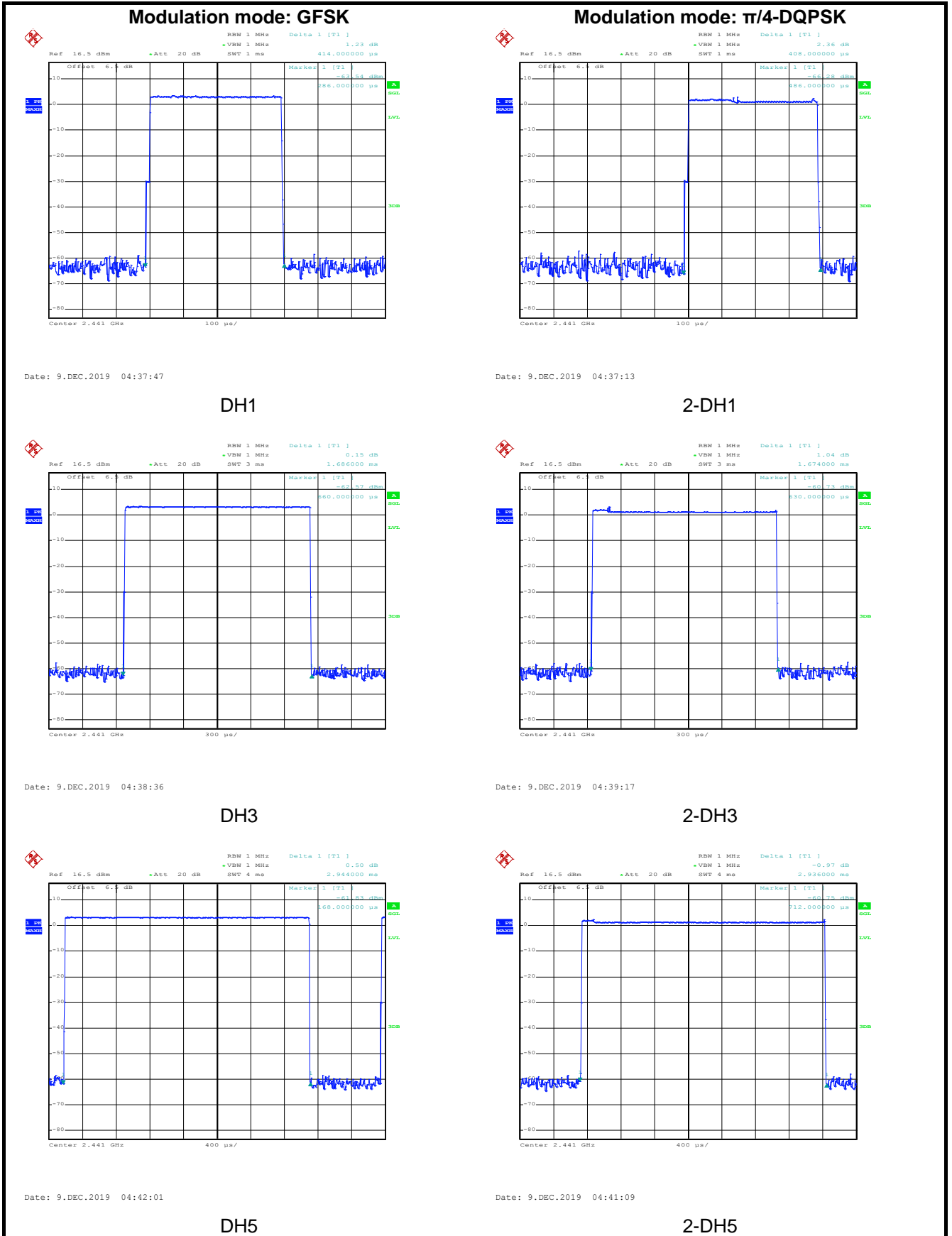

Modulation mode: 8DPSK

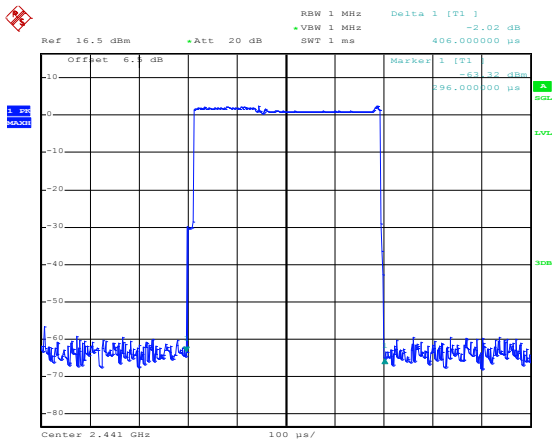

Date: 9.DEC.2019 04:36:31

3-DH1

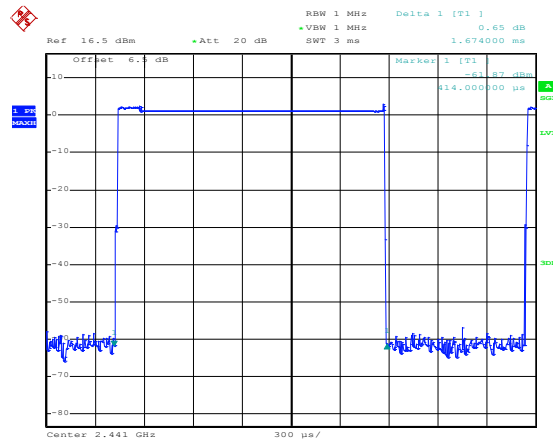

Date: 9.DEC.2019 04:39:47

3-DH3

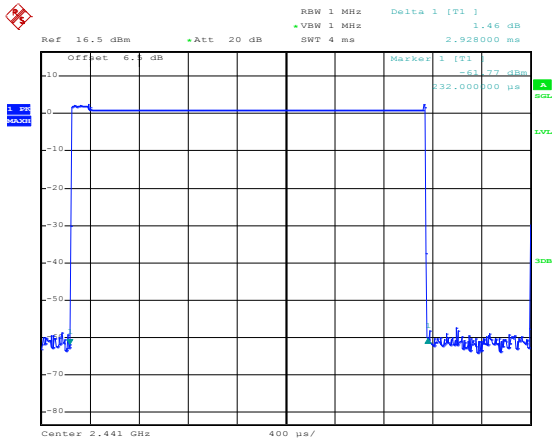

Date: 9.DEC.2019 04:40:32

3-DH5

6.8 Pseudorandom Frequency Hopping Sequence

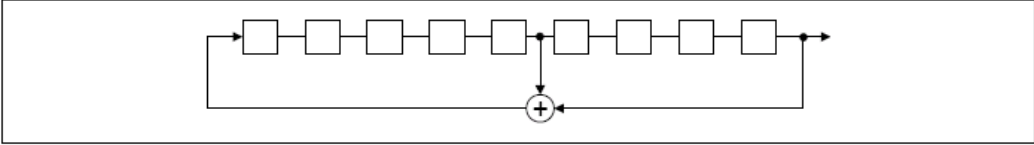
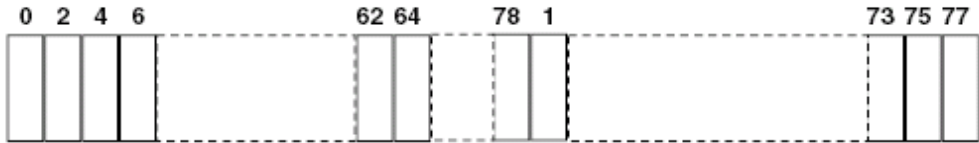
Test Requirement:	FCC Part 15 C Section 15.247 (a)(1) requirement:
<p>Frequency hopping systems shall have hopping channel carrier frequencies separated by a minimum of 25 kHz or the 20 dB bandwidth of the hopping channel, whichever is greater.</p> <p>Alternatively. Frequency hopping systems operating in the 2400-2483.5 MHz band may have hopping channel carrier frequencies that are separated by 25 kHz or two-thirds of the 20 dB bandwidth of the hopping channel, whichever is greater, provided the systems operate with an output power no greater than 125 mW. The system shall hop to channel frequencies that are selected at the system hopping rate from a Pseudorandom ordered list of hopping frequencies. Each frequency must be used equally on the average by each transmitter. The system receivers shall have input bandwidths that match the hopping channel bandwidths of their corresponding transmitters and shall shift frequencies in synchronization with the transmitted signals.</p>	
EUT Pseudorandom Frequency Hopping Sequence	
<p>The pseudorandom sequence may be generated in a nine-stage shift register whose 5th and 9th stage outputs are added in a modulo-two addition stage. And the result is fed back to the input of the first stage. The sequence begins with the first ONE of 9 consecutive ONES; i.e. the shift register is initialized with nine ones.</p> <ul style="list-style-type: none"> • Number of shift register stages: 9 • Length of pseudo-random sequence: $2^9 - 1 = 511$ bits • Longest sequence of zeros: 8 (non-inverted signal) 	
	
<p><i>Linear Feedback Shift Register for Generation of the PRBS sequence</i></p>	
<p>An example of Pseudorandom Frequency Hopping Sequence as follow:</p>	
	
<p>Each frequency used equally on the average by each transmitter.</p> <p>The system receivers have input bandwidths that match the hopping channel bandwidths of their corresponding transmitters and shift frequencies in synchronization with the transmitted signals.</p>	

6.9 Band Edge

6.9.1 Conducted Emission Method

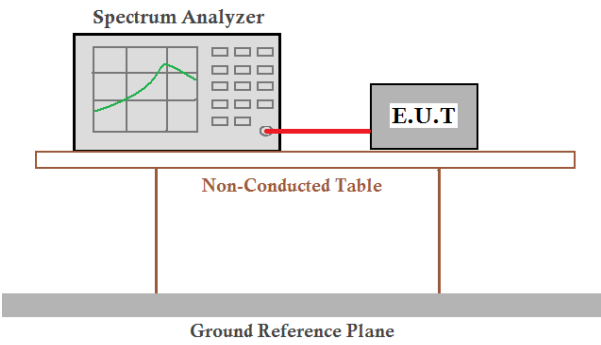
Test Requirement:	FCC Part 15 C Section 15.247 (d)
Receiver setup:	RBW=100 kHz, VBW=300 kHz, Detector=Peak
Limit:	In any 100 kHz bandwidth outside the frequency band in which the spread spectrum intentional radiator is operating, the radio frequency power that is produced by the intentional radiator shall be at least 20 dB below that in the 100 kHz bandwidth within the band that contains the highest level of the desired power, based on either an RF conducted or a radiated measurement.
Test setup:	 <p>The diagram illustrates the test setup. A Spectrum Analyzer is connected to an E.U.T. (Equipment Under Test) via a red cable. Both are placed on a Non-Conducted Table, which is supported by two legs. Below the table is a Ground Reference Plane.</p>
Test Instruments:	Refer to section 5.9 for details
Test mode:	Non-hopping mode and hopping mode
Test results:	Pass

Test plot as follows:

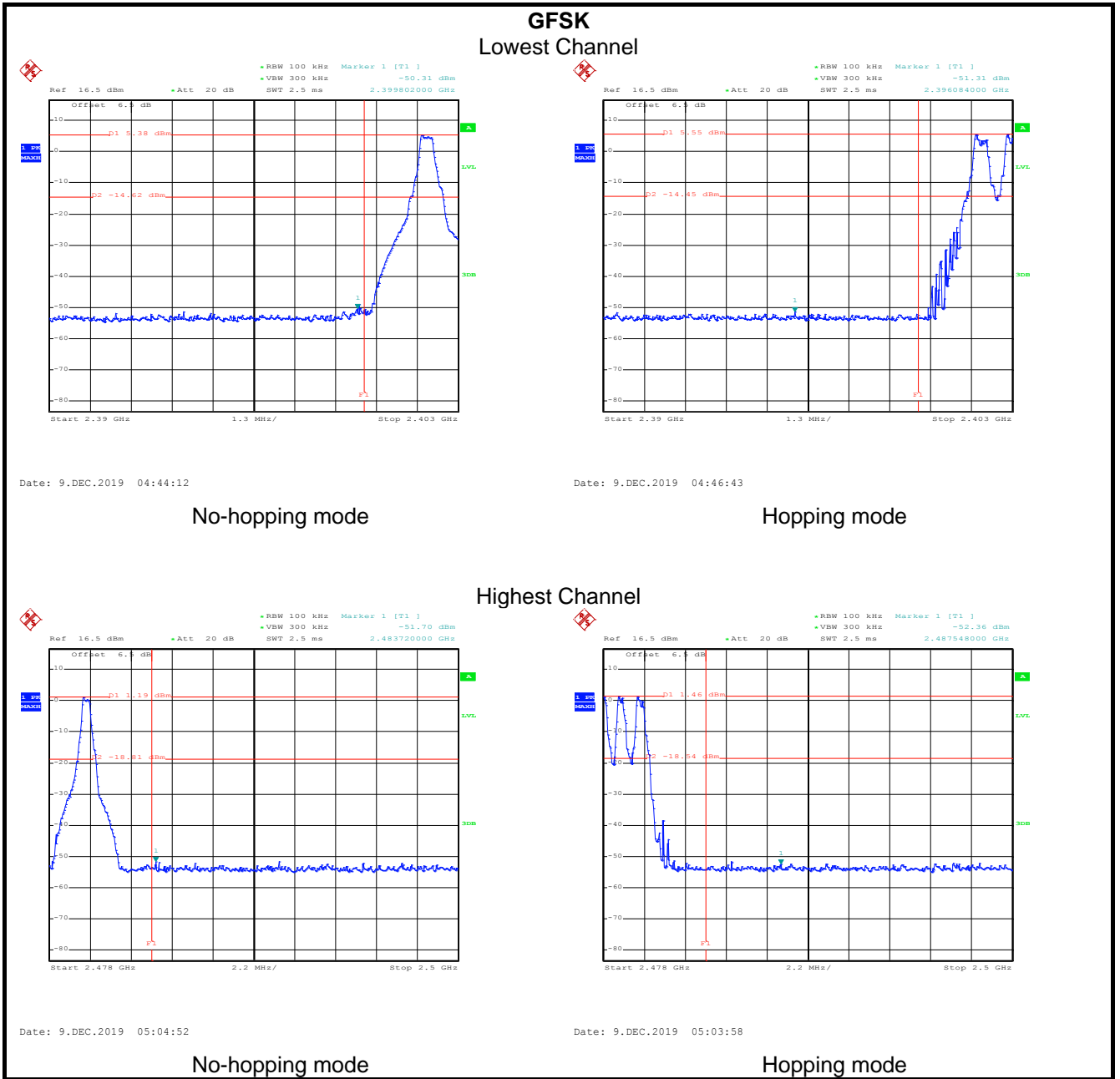

$\pi/4$ -DQPSK Lowest Channel

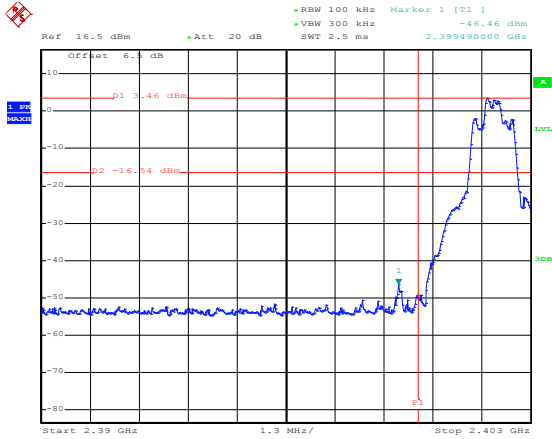

Date: 9.DEC.2019 04:50:02

No-hopping mode

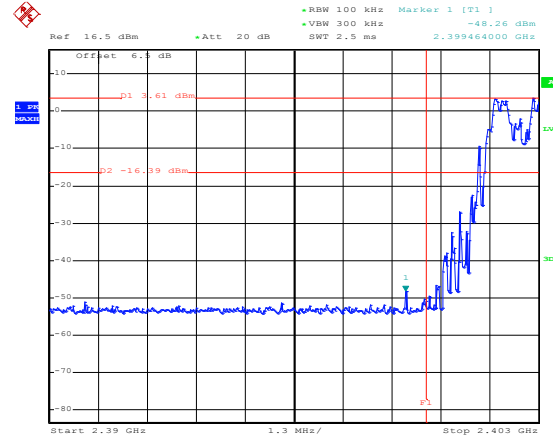

Date: 9.DEC.2019 04:49:05

Hopping mode

Highest Channel

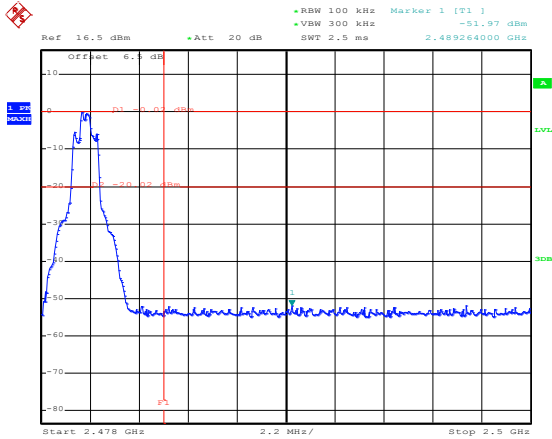

Date: 9.DEC.2019 05:01:06

No-hopping mode

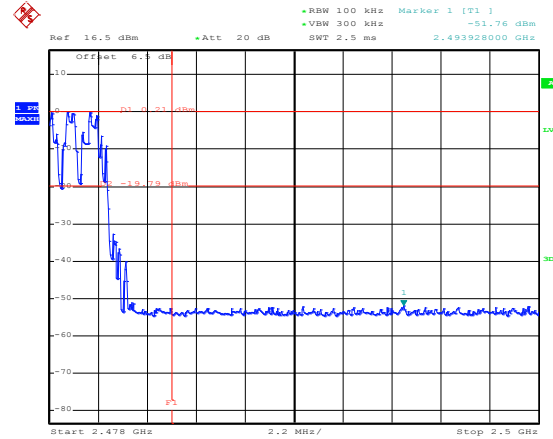

Date: 9.DEC.2019 05:02:34

Hopping mode

8DPSK Lowest Channel

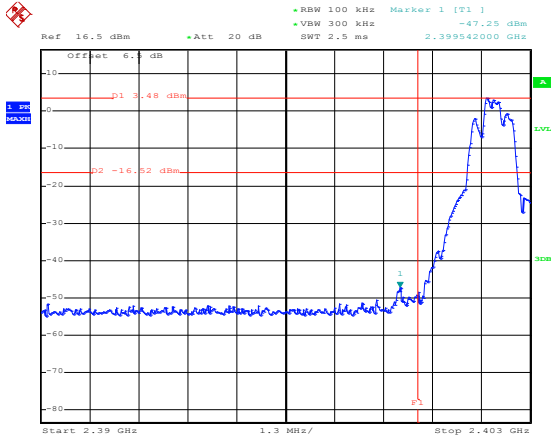

Date: 9.DEC.2019 04:51:04

No-hopping mode

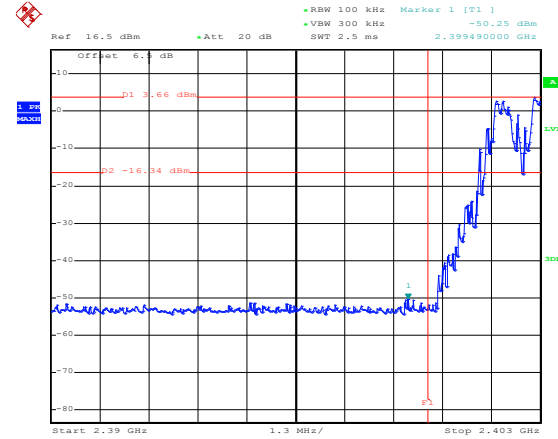

Date: 9.DEC.2019 04:53:28

Hopping mode

Highest Channel

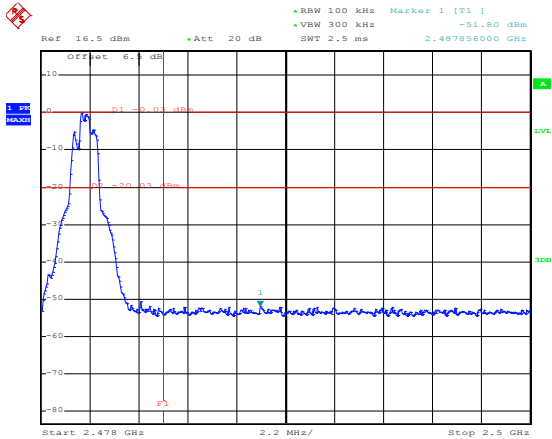

Date: 9.DEC.2019 04:59:54

No-hopping mode

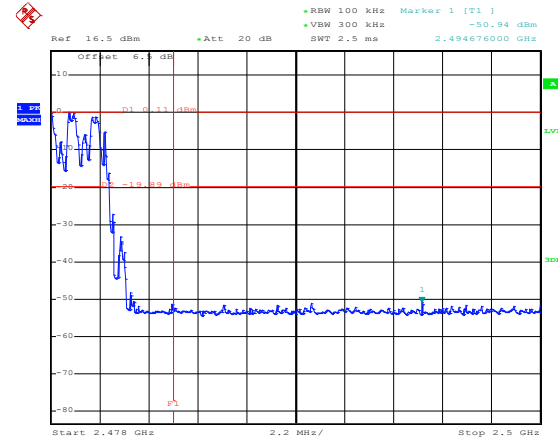

Date: 9.DEC.2019 04:57:07

Hopping mode

6.9.2 Radiated Emission Method

Test Requirement:	FCC Part 15 C Section 15.209 and 15.205				
Test Frequency Range:	2.3GHz to 2.5GHz				
Test Distance:	3m				
Receiver setup:	Frequency	Detector	RBW	VBW	Remark
	Above 1GHz	Peak	1MHz	3MHz	Peak Value
RMS		1MHz	3MHz	Average Value	
Limit:	Frequency	Limit (dBuV/m @3m)		Remark	
	Above 1GHz	54.00		Average Value	
74.00		Peak Value			
Test setup:					
Test Procedure:	<ol style="list-style-type: none"> 1. The EUT was placed on the top of a rotating table 1.5meters above the ground at a 3 meter camber. The table was rotated 360 degrees to determine the position of the highest radiation. 2. The EUT was set 3 meters away from the interference-receiving antenna, which was mounted on the top of a variable-height antenna tower. 3. The antenna height is varied from one meter to four meters above the ground to determine the maximum value of the field strength. Both horizontal and vertical polarizations of the antenna are set to make the measurement. 4. For each suspected emission, the EUT was arranged to its worst case and then the antenna was tuned to heights from 1 meter to 4 meters and the rota table was turned from 0 degrees to 360 degrees to find the maximum reading. 5. The test-receiver system was set to Peak Detect Function and Specified Bandwidth with Maximum Hold Mode. 6. If the emission level of the EUT in peak mode was 10dB lower than the limit specified, then testing could be stopped and the peak values of the EUT would be reported. Otherwise the emissions that did not have 10dB margin would be re-tested one by one using peak, quasi-peak or average method as specified and then reported in a data sheet. 				
Test Instruments:	Refer to section 5.9 for details				
Test mode:	Non-hopping mode				
Test results:	Passed				

GFSK Mode:

Product Name:	6.0 inch 4G Smart Phone	Product Model:	L60
Test By:	Mike	Test mode:	DH1 Tx mode
Test Channel:	Lowest channel	Polarization:	Vertical
Test Voltage:	AC 120/60Hz	Environment:	Temp: 24°C Humi: 57%

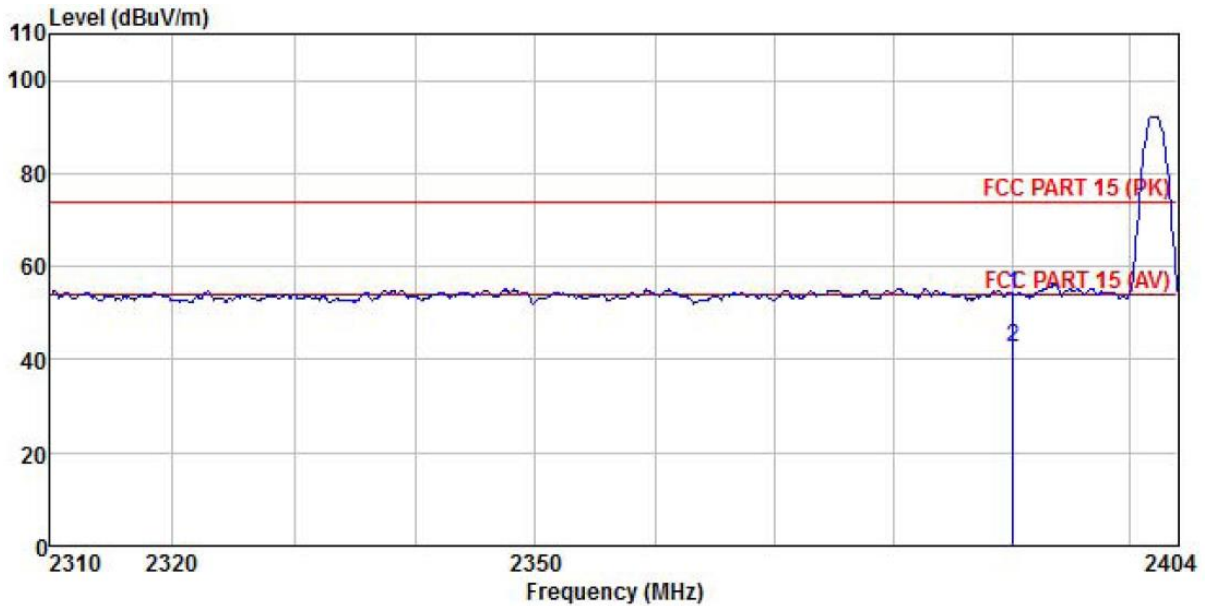

	Freq	ReadAntenna	Cable Preamp	Level	Limit	Over	Remark	
	MHz	Level	Factor	Loss	Factor	Level	Line	
		dBuV	dB/m	dB	dB	dBuV/m	dBuV/m	
1	2390.000	20.69	27.07	4.69	0.00	54.13	74.00	-19.87 Peak
2	2390.000	9.02	27.07	4.69	0.00	42.46	54.00	-11.54 Average

Remark:

1. Final Level = Receiver Read level + Antenna Factor + Cable Loss – Pre-amplifier Factor.
2. The emission levels of other frequencies are very lower than the limit and not show in test report.

Product Name:	6.0 inch 4G Smart Phone	Product Model:	L60
Test By:	Mike	Test mode:	DH1 Tx mode
Test Channel:	Lowest channel	Polarization:	Horizontal
Test Voltage:	AC 120/60Hz	Environment:	Temp: 24°C Humi: 57%

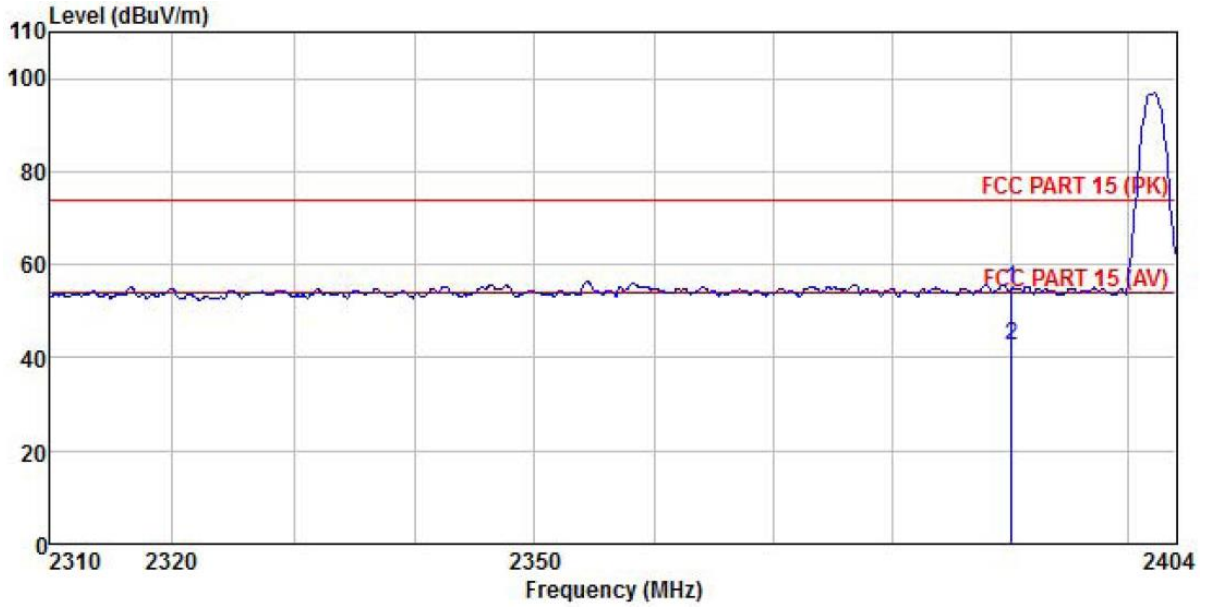

	Read	Antenna	Cable	Preamp	Limit	Over	
Freq	Level	Factor	Loss	Factor	Line	Limit	Remark
-----	-----	-----	-----	-----	-----	-----	-----
MHz	dBuV	dB/m	dB	dB	dBuV/m	dBuV/m	dB
1	2390.000	21.41	27.08	4.69	0.00	54.86	74.00 -19.14 Peak
2	2390.000	9.07	27.08	4.69	0.00	42.52	54.00 -11.48 Average

Remark:

1. Final Level = Receiver Read level + Antenna Factor + Cable Loss – Preamplifier Factor.
2. The emission levels of other frequencies are very lower than the limit and not show in test report.

Product Name:	6.0 inch 4G Smart Phone	Product Model:	L60
Test By:	Mike	Test mode:	DH1 Tx mode
Test Channel:	Highest channel	Polarization:	Vertical
Test Voltage:	AC 120/60Hz	Environment:	Temp: 24°C Humi: 57%

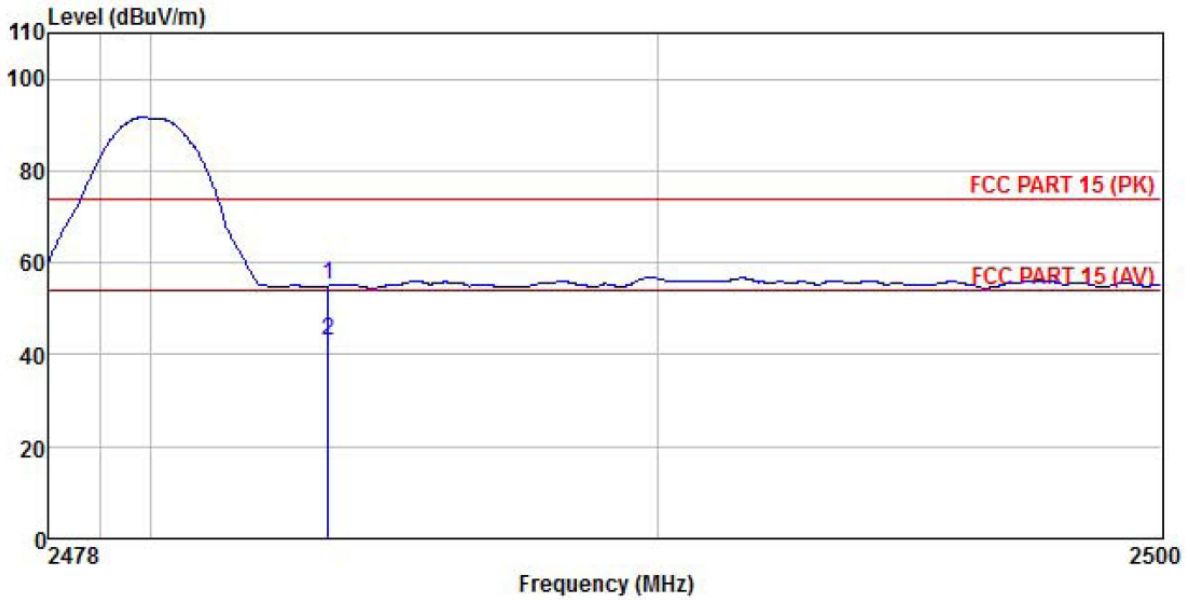

	Freq	Read Level	Antenna Factor	Cable Loss	Preamp Factor	Level	Limit Line	Over Limit	Remark
	MHz	dBuV	dB/m	dB	dB	dBuV/m	dBuV/m	dB	
1	2483.500	21.13	27.36	4.81	0.00	55.00	74.00	-19.00	Peak
2	2483.500	9.20	27.36	4.81	0.00	43.07	54.00	-10.93	Average

Remark:

1. Final Level = Receiver Read level + Antenna Factor + Cable Loss – Pre-amplifier Factor.
2. The emission levels of other frequencies are very lower than the limit and not show in test report.

Product Name:	6.0 inch 4G Smart Phone	Product Model:	L60
Test By:	Mike	Test mode:	DH1 Tx mode
Test Channel:	Highest channel	Polarization:	Horizontal
Test Voltage:	AC 120/60Hz	Environment:	Temp: 24°C Humi: 57%

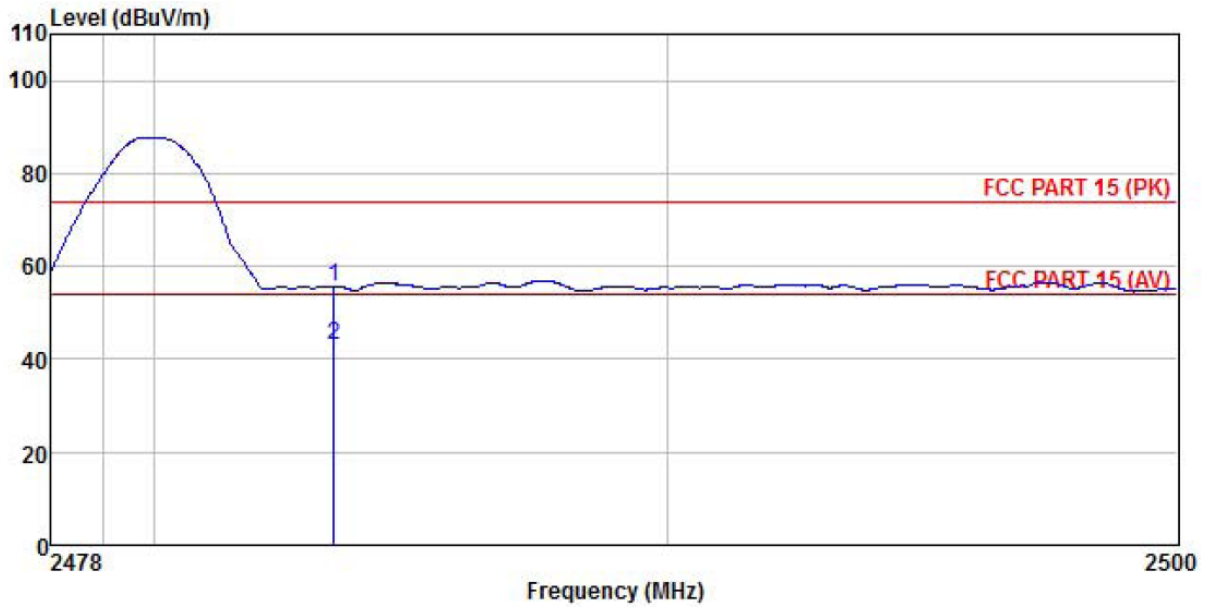

	Read	Antenna	Cable	Preamp	Limit	Over	
Freq	Level	Factor	Loss	Factor	Line	Limit	Remark
MHz	dBuV	dB/m	dB	dB	dBuV/m	dBuV/m	dB
1	2483.500	21.81	27.35	4.81	0.00	55.67	74.00 -18.33 Peak
2	2483.500	9.16	27.35	4.81	0.00	43.02	54.00 -10.98 Average

Remark:

1. Final Level = Receiver Read level + Antenna Factor + Cable Loss – Pre-amplifier Factor.
2. The emission levels of other frequencies are very lower than the limit and not show in test report.

π/4-DQPSK mode

Product Name:	6.0 inch 4G Smart Phone	Product Model:	L60
Test By:	Mike	Test mode:	2DH1 Tx mode
Test Channel:	Lowest channel	Polarization:	Vertical
Test Voltage:	AC 120/60Hz	Environment:	Temp: 24°C Humi: 57%

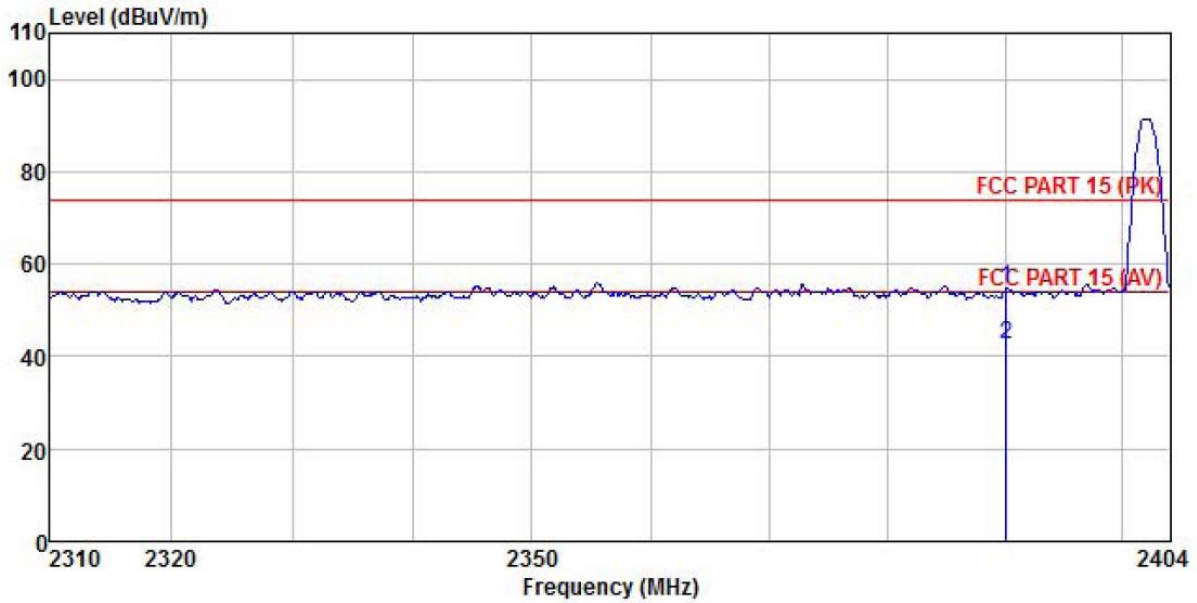

	Read	Antenna	Cable	Preamp	Level	Limit	Over	
	Freq	Level	Factor	Loss	Factor	Line	Limit	Remark
	MHz	dBuV	dB/m	dB	dB	dBuV/m	dBuV/m	dB
1	2390.000	21.35	27.07	4.69	0.00	54.79	74.00	-19.21 Peak
2	2390.000	9.04	27.07	4.69	0.00	42.48	54.00	-11.52 Average

Remark:

1. Final Level = Receiver Read level + Antenna Factor + Cable Loss – Pre-amplifier Factor.
2. The emission levels of other frequencies are very lower than the limit and not show in test report.

Product Name:	6.0 inch 4G Smart Phone	Product Model:	L60
Test By:	Mike	Test mode:	2DH1 Tx mode
Test Channel:	Lowest channel	Polarization:	Horizontal
Test Voltage:	AC 120/60Hz	Environment:	Temp: 24°C Humi: 57%

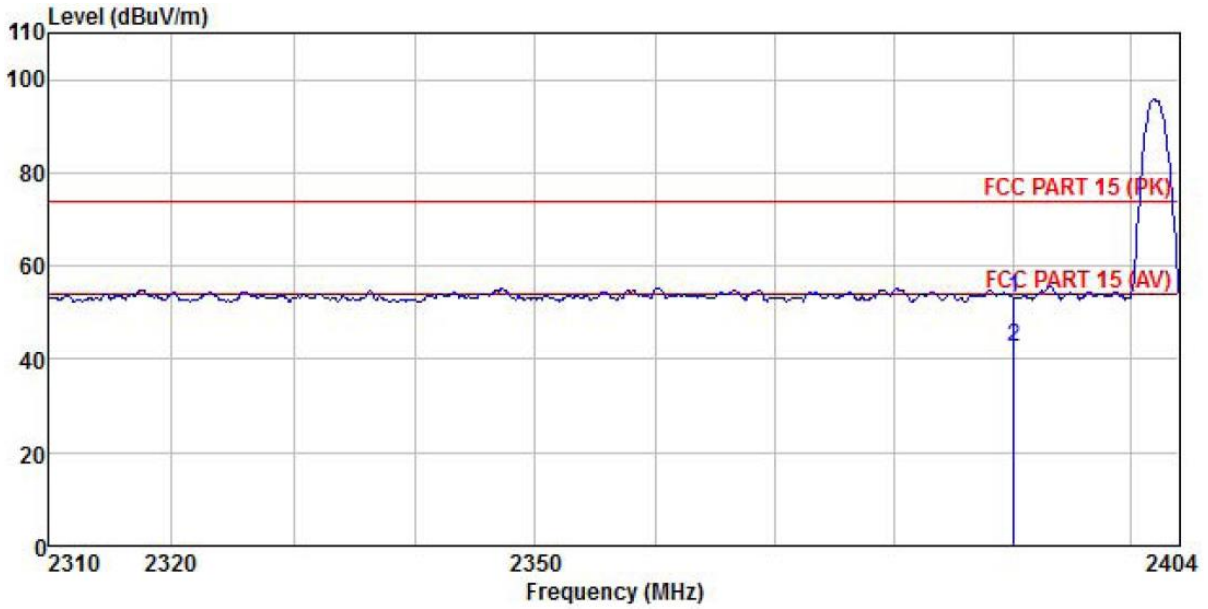

	Freq	Read Level	Antenna Factor	Cable Loss	Preamp Factor	Level	Limit Line	Over Limit	Remark
	MHz	dBuV	dB/m	dB	dB	dBuV/m	dBuV/m	dB	
1	2390.000	19.72	27.08	4.69	0.00	53.17	74.00	-20.83	Peak
2	2390.000	8.97	27.08	4.69	0.00	42.42	54.00	-11.58	Average

Remark:

1. Final Level = Receiver Read level + Antenna Factor + Cable Loss – Pre-amplifier Factor.
2. The emission levels of other frequencies are very lower than the limit and not show in test report.

Product Name:	6.0 inch 4G Smart Phone	Product Model:	L60
Test By:	Mike	Test mode:	2DH1 Tx mode
Test Channel:	Highest channel	Polarization:	Vertical
Test Voltage:	AC 120/60Hz	Environment:	Temp: 24°C Humi: 57%

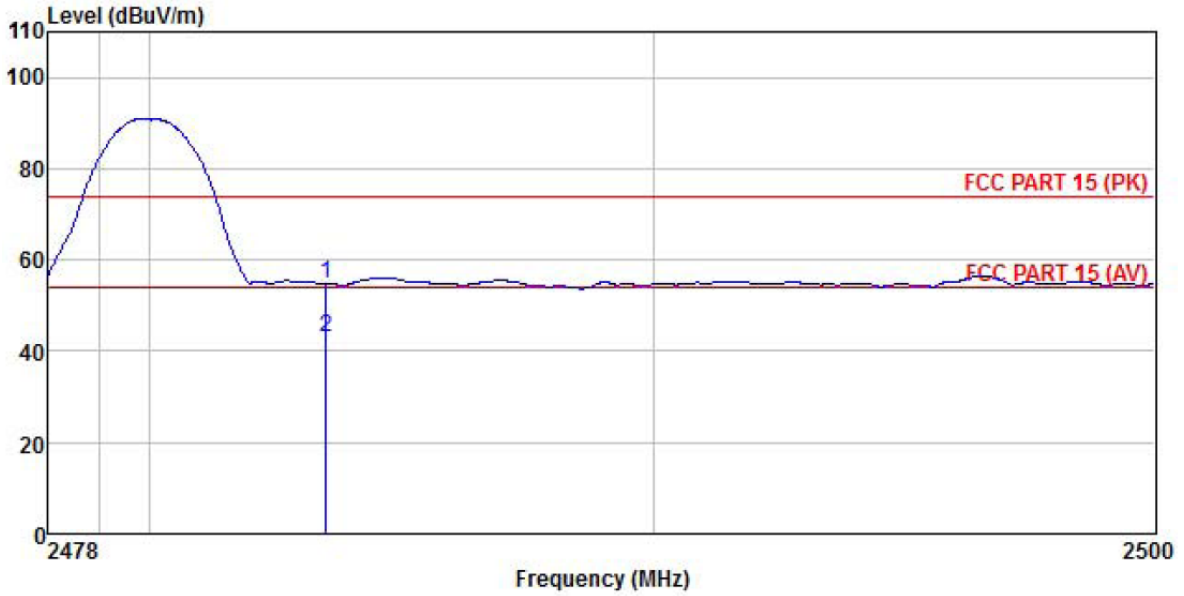

	Freq	Read Level	Antenna Factor	Cable Loss	Preamp Factor	Level	Limit Line	Over Limit	Remark
	MHz	dBuV	dB/m	dB	dB	dBuV/m	dBuV/m	dB	
1	2483.500	21.00	27.36	4.81	0.00	54.87	74.00	-19.13	Peak
2	2483.500	9.09	27.36	4.81	0.00	42.96	54.00	-11.04	Average

Remark:

1. Final Level = Receiver Read level + Antenna Factor + Cable Loss – Pre-amplifier Factor.
2. The emission levels of other frequencies are very lower than the limit and not show in test report.

Product Name:	6.0 inch 4G Smart Phone	Product Model:	L60
Test By:	Mike	Test mode:	2DH1 Tx mode
Test Channel:	Highest channel	Polarization:	Horizontal
Test Voltage:	AC 120/60Hz	Environment:	Temp: 24°C Huni: 57%

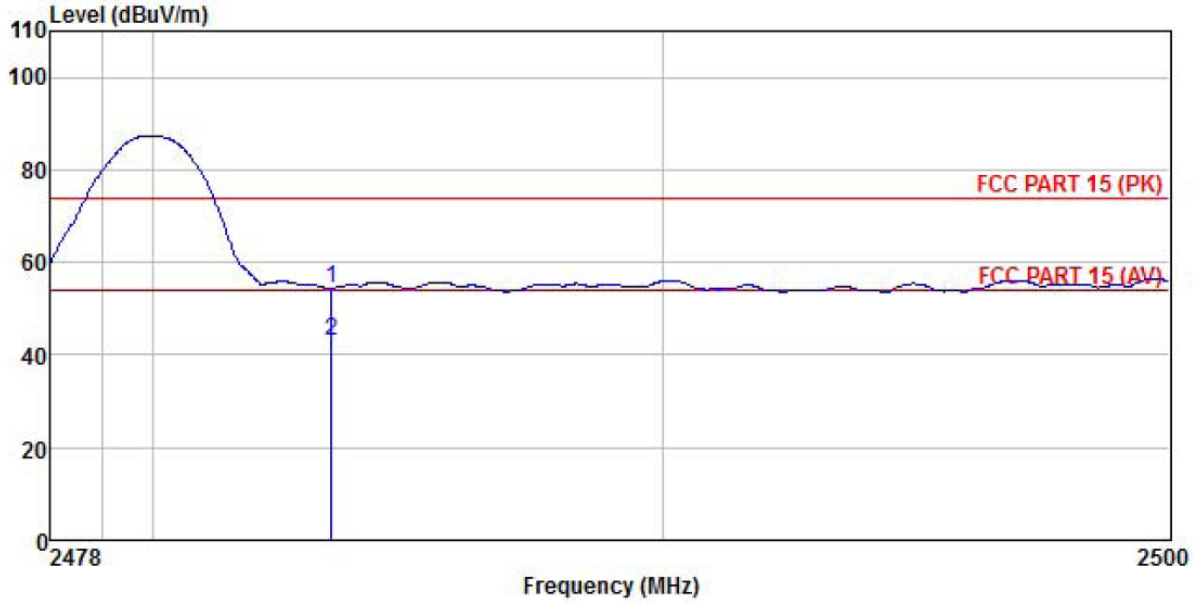

	Read	Antenna	Cable	Preamp	Limit	Over	
Freq	Level	Factor	Loss	Factor	Level	Line	Limit
-----	-----	-----	-----	-----	-----	-----	-----
MHz	dBuV	dB/m	dB	dB	dBuV/m	dBuV/m	dB
1	2483.500	20.47	27.35	4.81	0.00	54.33	74.00 -19.67 Peak
2	2483.500	9.05	27.35	4.81	0.00	42.91	54.00 -11.09 Average

Remark:

1. Final Level = Receiver Read level + Antenna Factor + Cable Loss – Preamplifier Factor.
2. The emission levels of other frequencies are very lower than the limit and not show in test report.

8DPSK mode

Product Name:	6.0 inch 4G Smart Phone	Product Model:	L60
Test By:	Mike	Test mode:	3DH1 Tx mode
Test Channel:	Lowest channel	Polarization:	Vertical
Test Voltage:	AC 120/60Hz	Environment:	Temp: 24°C Humi: 57%

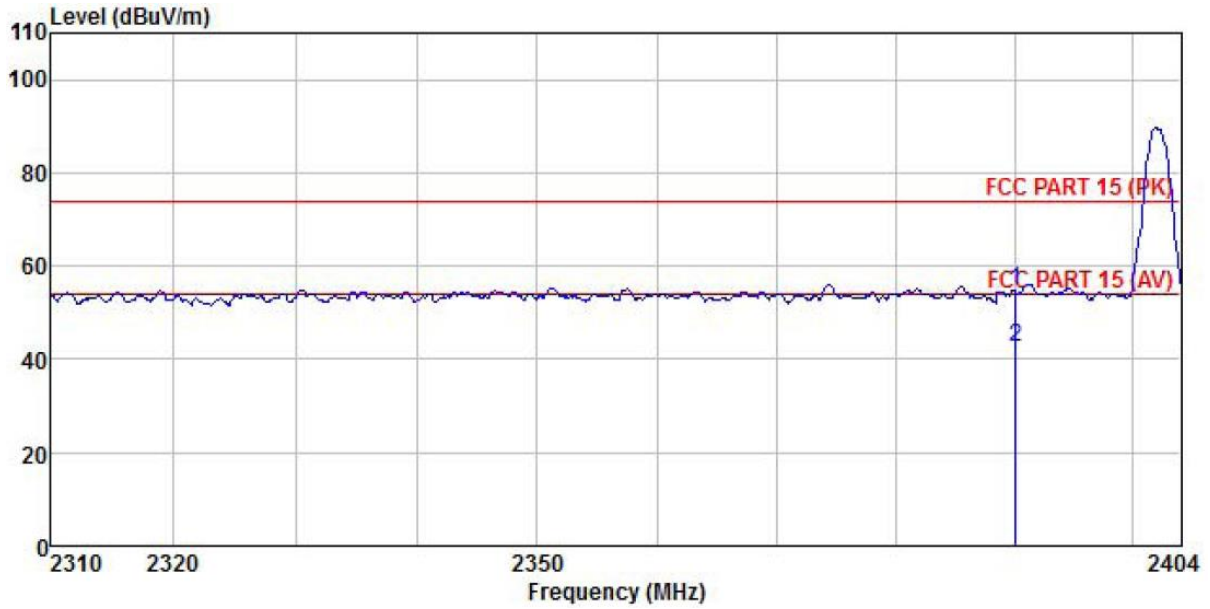

	Read Freq	Antenna Level	Antenna Factor	Cable Loss	Preamp Factor	Level	Limit Line	Over Limit	Remark
	MHz	dBuV	dB/m	dB	dB	dBuV/m	dBuV/m	dB	
1	2390.000	21.28	27.07	4.69	0.00	54.72	74.00	-19.28	Peak
2	2390.000	9.07	27.07	4.69	0.00	42.51	54.00	-11.49	Average

Remark:

1. Final Level = Receiver Read level + Antenna Factor + Cable Loss – Pre-amplifier Factor.
2. The emission levels of other frequencies are very lower than the limit and not show in test report.

Product Name:	6.0 inch 4G Smart Phone	Product Model:	L60
Test By:	Mike	Test mode:	3DH1 Tx mode
Test Channel:	Lowest channel	Polarization:	Horizontal
Test Voltage:	AC 120/60Hz	Environment:	Temp: 24°C Humi: 57%

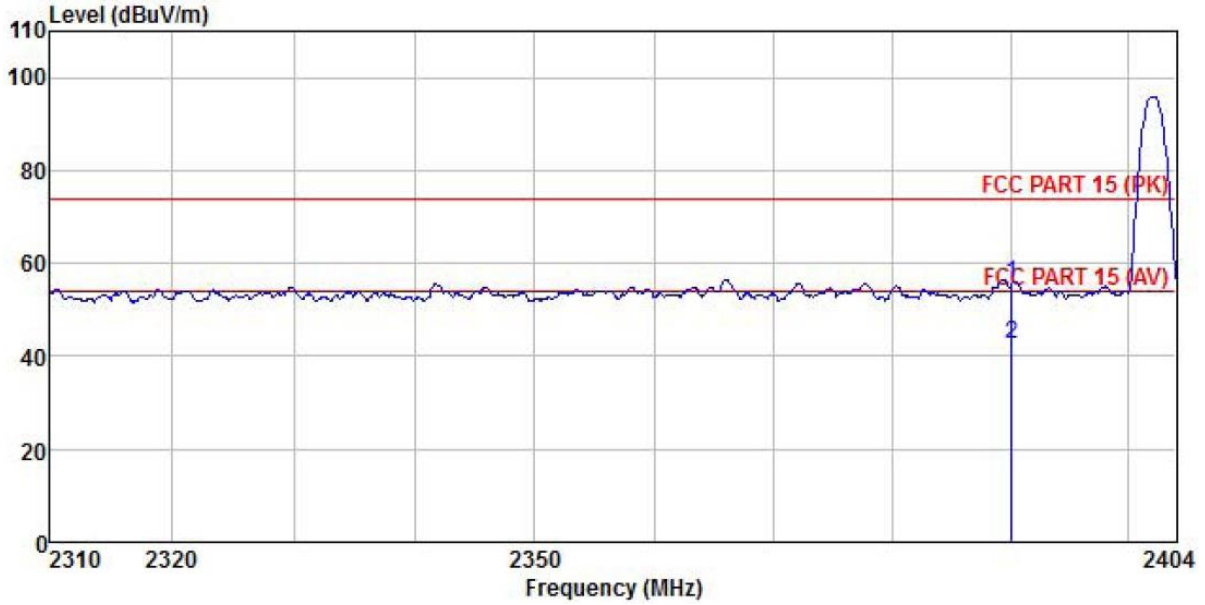

	Read	Antenna	Cable	Preamp	Limit	Over		
Freq	Level	Factor	Loss	Factor	Level	Line	Limit	
-----	-----	-----	-----	-----	-----	-----	-----	
MHz	dBuV	dB/m	dB	dB	dBuV/m	dBuV/m	dB	
1	2390.000	22.10	27.08	4.69	0.00	55.55	74.00	-18.45 Peak
2	2390.000	9.09	27.08	4.69	0.00	42.54	54.00	-11.46 Average

Remark:

1. Final Level = Receiver Read level + Antenna Factor + Cable Loss – Preamplifier Factor.
2. The emission levels of other frequencies are very lower than the limit and not show in test report.

Product Name:	6.0 inch 4G Smart Phone	Product Model:	L60
Test By:	Mike	Test mode:	3DH1 Tx mode
Test Channel:	Highest channel	Polarization:	Vertical
Test Voltage:	AC 120/60Hz	Environment:	Temp: 24°C Humi: 57%

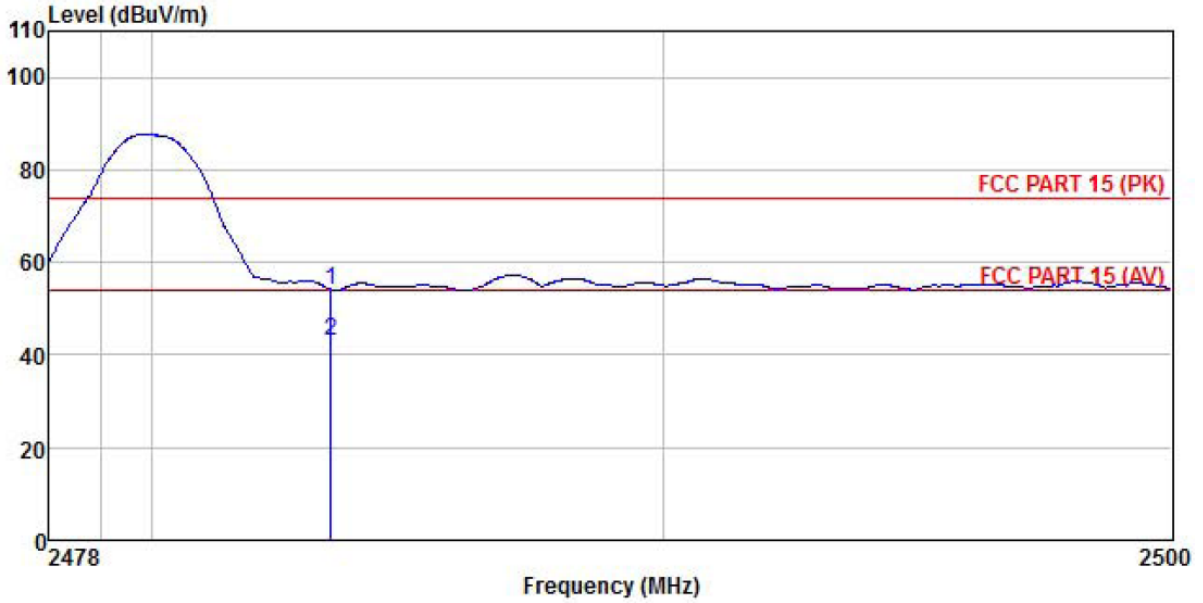

	Read	Antenna	Cable	Preamp	Limit	Over	
Freq	Level	Factor	Loss	Factor	Level	Line	Limit Remark
MHz	dBuV	dB/m	dB	dB	dBuV/m	dBuV/m	dB
1	2483.500	20.28	27.36	4.81	0.00	54.15	74.00 -19.85 Peak
2	2483.500	9.02	27.36	4.81	0.00	42.89	54.00 -11.11 Average

Remark:

1. Final Level = Receiver Read level + Antenna Factor + Cable Loss – Pre-amplifier Factor.
2. The emission levels of other frequencies are very lower than the limit and not show in test report.

Product Name:	6.0 inch 4G Smart Phone	Product Model:	L60
Test By:	Mike	Test mode:	3DH1 Tx mode
Test Channel:	Highest channel	Polarization:	Horizontal
Test Voltage:	AC 120/60Hz	Environment:	Temp: 24°C Humi: 57%

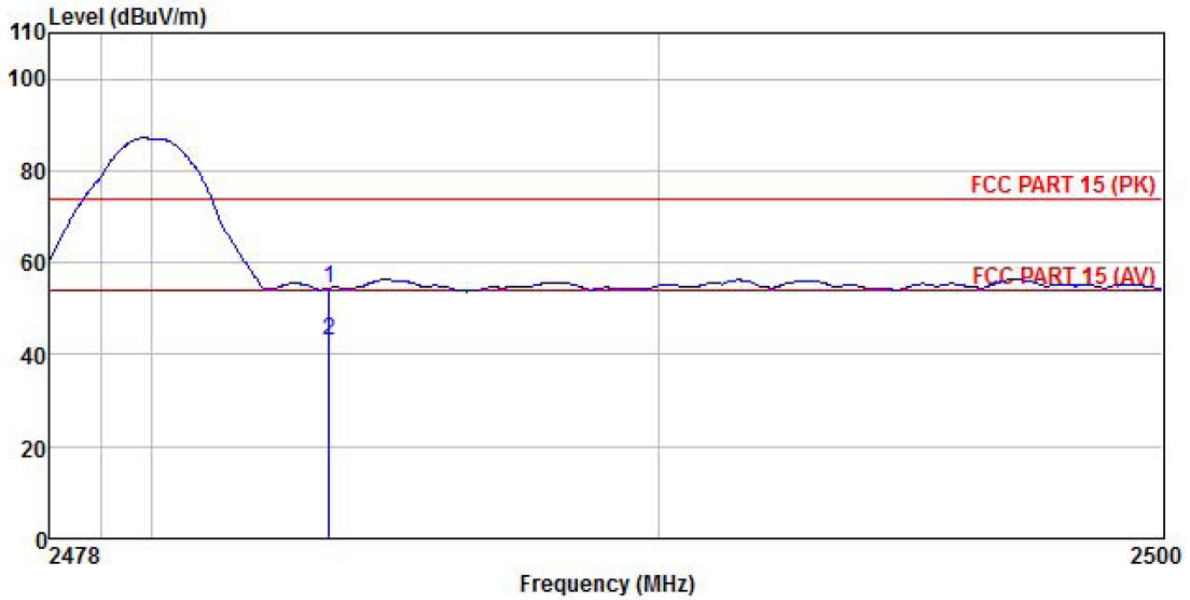

	Read	Antenna	Cable	Preamp	Limit	Over	
Freq	Level	Factor	Loss	Factor	Line	Limit	Remark
-----	-----	-----	-----	-----	-----	-----	-----
MHz	dBuV	dB/m	dB	dB	dBuV/m	dBuV/m	dB
1	2483.500	20.72	27.35	4.81	0.00	54.58	74.00 -19.42 Peak
2	2483.500	9.04	27.35	4.81	0.00	42.90	54.00 -11.10 Average

Remark:

1. Final Level = Receiver Read level + Antenna Factor + Cable Loss – Pre-amplifier Factor.
2. The emission levels of other frequencies are very lower than the limit and not show in test report.

6.10 Spurious Emission

6.10.1 Conducted Emission Method

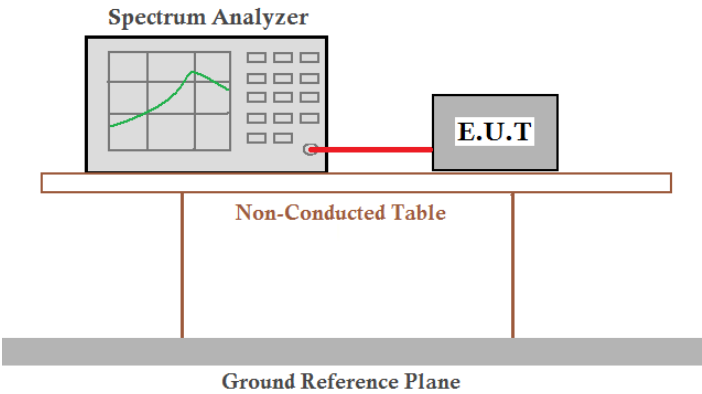
Test Requirement:	FCC Part 15 C Section 15.247 (d)
Limit:	In any 100 kHz bandwidth outside the frequency band in which the spread spectrum intentional radiator is operating, the radio frequency power that is produced by the intentional radiator shall be at least 20 dB below that in the 100 kHz bandwidth within the band that contains the highest level of the desired power, based on either an RF conducted or a radiated measurement.
Test setup:	 <p>The diagram illustrates the test setup. A Spectrum Analyzer is connected to an E.U.T. (Equipment Under Test) via a red probe. Both the Spectrum Analyzer and the E.U.T. are placed on a Non-Conducted Table. The table is supported by two vertical legs and sits on a Ground Reference Plane.</p>
Test Instruments:	Refer to section 5.9 for details
Test mode:	Non-hopping mode
Test results:	Pass

Test plot as follows:

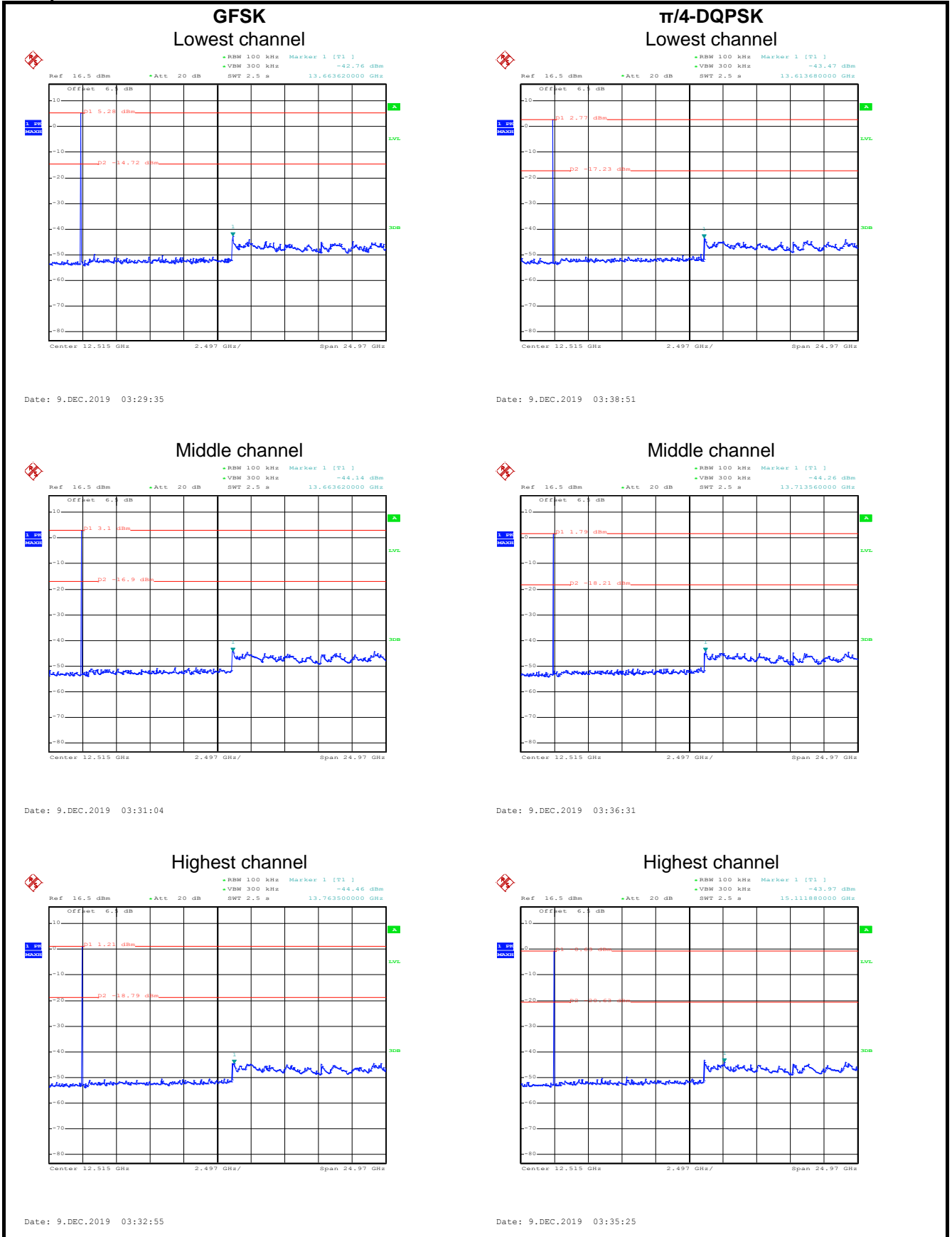

8DPSK

Lowest channel

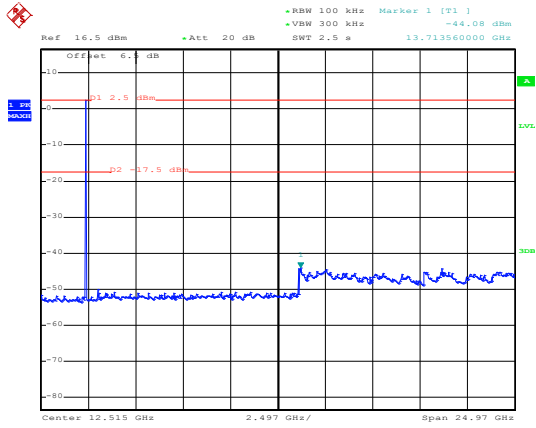

Date: 9.DEC.2019 03:41:17

Middle channel

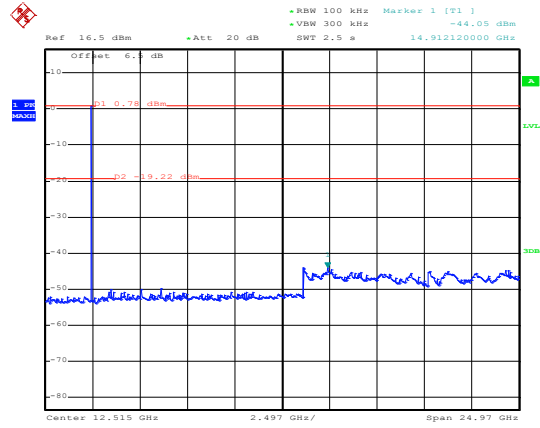

Date: 9.DEC.2019 03:42:53

Highest channel

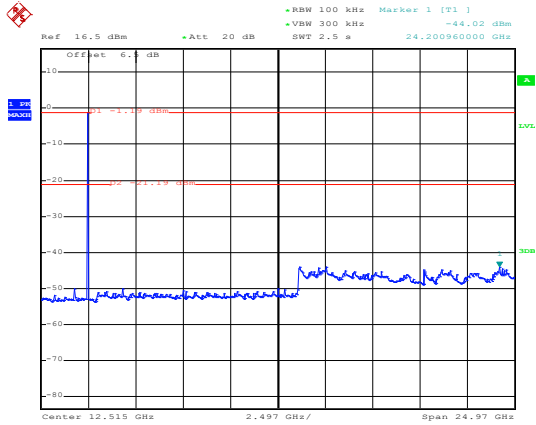

Date: 9.DEC.2019 03:45:03

6.10.2 Radiated Emission Method

Test Requirement:	FCC Part 15 C Section 15.209				
Test Frequency Range:	9 kHz to 25 GHz				
Test Distance:	3m				
Receiver setup:	Frequency	Detector	RBW	VBW	Remark
	30MHz-1GHz	Quasi-peak	120kHz	300kHz	Quasi-peak Value
	Above 1GHz	Peak	1MHz	3MHz	Peak Value
RMS		1MHz	3MHz	Average Value	
Limit:	Frequency	Limit (dBuV/m @3m)		Remark	
	30MHz-88MHz	40.0		Quasi-peak Value	
	88MHz-216MHz	43.5		Quasi-peak Value	
	216MHz-960MHz	46.0		Quasi-peak Value	
	960MHz-1GHz	54.0		Quasi-peak Value	
	Above 1GHz	54.0		Average Value	
74.0		Peak Value			
Test setup:	Below 1GHz				
Test setup:	Above 1GHz				
Test Procedure:	<ol style="list-style-type: none"> The EUT was placed on the top of a rotating table 0.8m(below 1GHz) /1.5m(above 1GHz) above the ground at a 3 meter chamber. The table was rotated 360 degrees to determine the position of the highest radiation. The EUT was set 3 meters away from the interference-receiving 				

	<p>antenna, which was mounted on the top of a variable-height antenna tower.</p> <ol style="list-style-type: none"> 3. The antenna height is varied from one meter to four meters above the ground to determine the maximum value of the field strength. Both horizontal and vertical polarizations of the antenna are set to make the measurement. 4. For each suspected emission, the EUT was arranged to its worst case and then the antenna was tuned to heights from 1 meter to 4 meters and the rota table was turned from 0 degrees to 360 degrees to find the maximum reading. 5. The test-receiver system was set to Peak Detect Function and Specified Bandwidth with Maximum Hold Mode. 6. If the emission level of the EUT in peak mode was 10dB lower than the limit specified, then testing could be stopped and the peak values of the EUT would be reported. Otherwise the emissions that did not have 10dB margin would be re-tested one by one using peak, quasi-peak or average method as specified and then reported in a data sheet.
Test Instruments:	Refer to section 5.9 for details
Test mode:	Non-hopping mode
Test results:	Pass
Remark:	<ol style="list-style-type: none"> 1. Pre-scan all kind of the place mode (X-axis, Y-axis, Z-axis), and found the Y-axis is the worst case. 2. 9 kHz to 30 MHz is noise floor, so only shows the data of above 30MHz in this report.

Measurement Data (worst case):

Below 1GHz:

Product Name:	6.0 inch 4G Smart Phone	Product Model:	L60
Test By:	Mike	Test mode:	BT Tx mode
Test Frequency:	30 MHz ~ 1 GHz	Polarization:	Vertical
Test Voltage:	AC 120/60Hz	Environment:	Temp: 24°C Humi: 57%

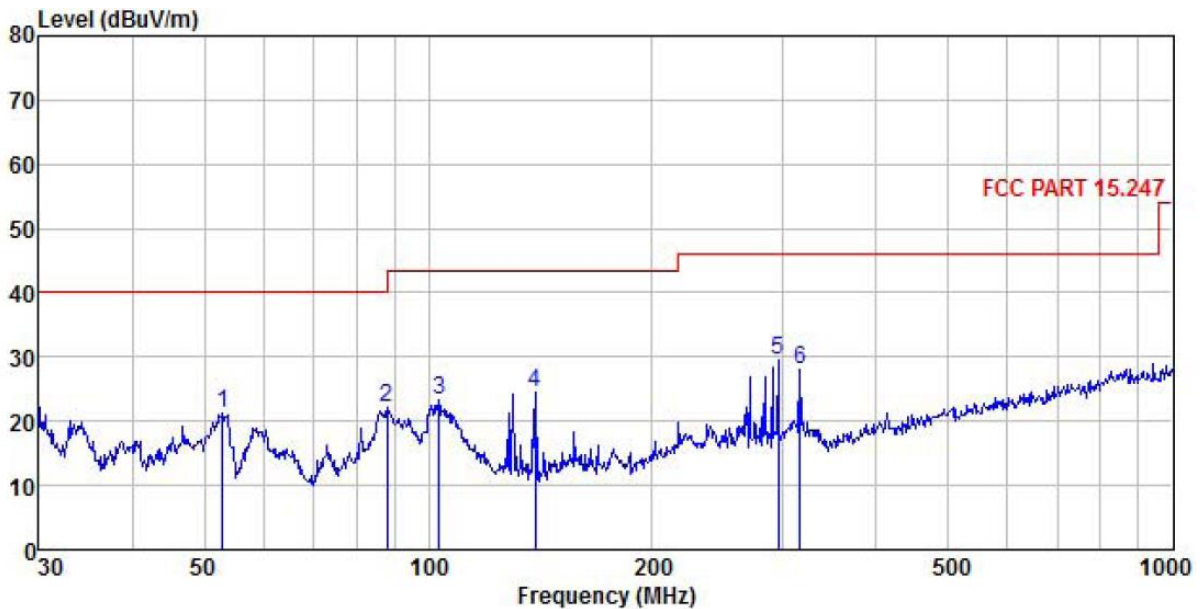

	Read Freq	Antenna Level	Antenna Factor	Cable Loss	Preamp Factor	Level	Limit Line	Over Limit	Remark
	MHz	dBm	dB/m	dB	dB	dBm/m	dBm/m	dB	
1	52.945	38.07	11.80	1.32	29.81	21.38	40.00	-18.62	QP
2	88.033	40.23	9.44	1.96	29.58	22.05	43.50	-21.45	QP
3	103.442	38.56	12.20	1.97	29.50	23.23	43.50	-20.27	QP
4	139.361	41.81	9.54	2.39	29.28	24.46	43.50	-19.04	QP
5	295.147	41.44	13.52	2.93	28.46	29.43	46.00	-16.57	QP
6	315.481	39.58	13.92	2.99	28.49	28.00	46.00	-18.00	QP

Remark:

1. Final Level = Receiver Read level + Antenna Factor + Cable Loss – Preamplifier Factor.
2. The emission levels of other frequencies are very lower than the limit and not show in test report.

Product Name:	6.0 inch 4G Smart Phone	Product Model:	L60
Test By:	Mike	Test mode:	BT Tx mode
Test Frequency:	30 MHz ~ 1 GHz	Polarization:	Horizontal
Test Voltage:	AC 120/60Hz	Environment:	Temp: 24°C Humi: 57%

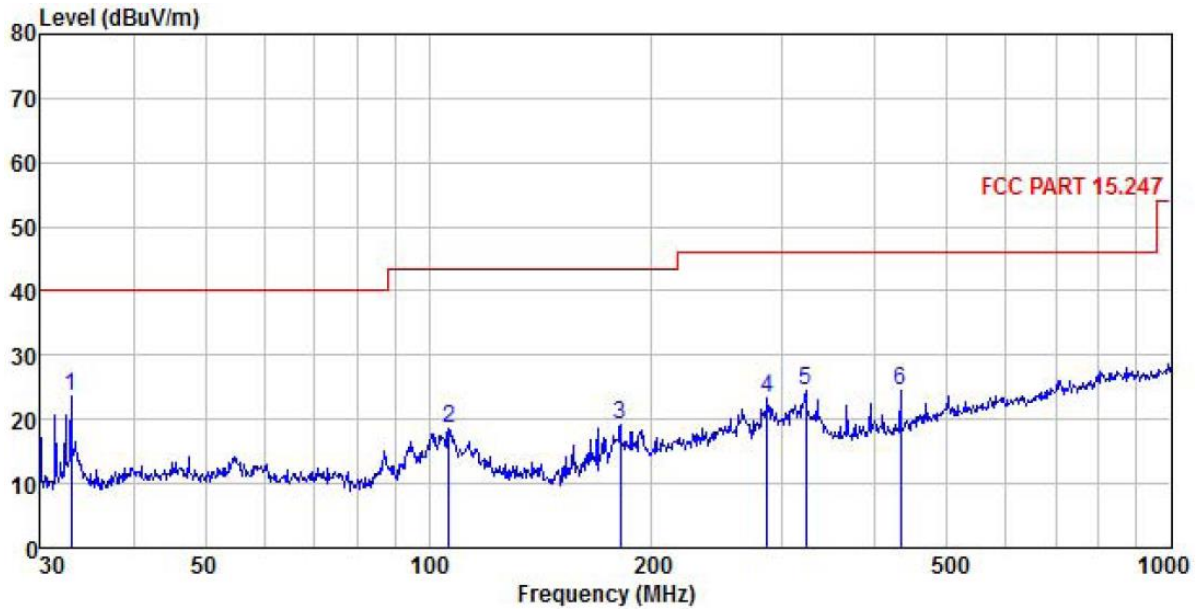

	Read	Antenna	Cable	Preamp	Level	Limit	Over	
Freq	Level	Factor	Loss	Factor	Level	Line	Limit	Remark
MHz	dBm	dB/m	dB	dB	dBm/m	dBm/m	dB	
1	32.979	41.64	10.97	0.91	29.96	23.56	40.00	-16.44 QP
2	106.385	34.01	11.98	2.01	29.48	18.52	43.50	-24.98 QP
3	181.283	35.33	10.01	2.74	28.96	19.12	43.50	-24.38 QP
4	285.978	35.62	13.37	2.90	28.47	23.42	46.00	-22.58 QP
5	322.189	36.05	14.06	3.01	28.50	24.62	46.00	-21.38 QP
6	432.546	34.12	16.07	3.16	28.84	24.51	46.00	-21.49 QP

Remark:

1. Final Level = Receiver Read level + Antenna Factor + Cable Loss – Pre-amplifier Factor.
2. The emission levels of other frequencies are very lower than the limit and not show in test report.

Above 1GHz:

Test channel: Lowest channel								
Detector: Peak Value								
Frequency (MHz)	Read Level (dBuV)	Antenna Factor (dB/m)	Cable Loss (dB)	Preamp Factor (dB)	Level (dBuV/m)	Limit Line (dBuV/m)	Over Limit (dB)	Polarization
4804	48.66	30.85	6.80	41.81	44.50	74.00	-29.50	Vertical
4804	47.98	30.85	6.80	41.81	43.82	74.00	-30.18	Horizontal
Detector: Average Value								
Frequency (MHz)	Read Level (dBuV)	Antenna Factor (dB/m)	Cable Loss (dB)	Preamp Factor (dB)	Level (dBuV/m)	Limit Line (dBuV/m)	Over Limit (dB)	Polarization
4804.00	37.80	30.85	6.80	41.81	33.64	54.00	-20.36	Vertical
4804.00	36.75	30.85	6.80	41.81	32.59	54.00	-21.41	Horizontal
Test channel: Middle channel								
Detector: Peak Value								
Frequency (MHz)	Read Level (dBuV)	Antenna Factor (dB/m)	Cable Loss (dB)	Preamp Factor (dB)	Level (dBuV/m)	Limit Line (dBuV/m)	Over Limit (dB)	Polarization
4882.00	48.57	31.20	6.86	41.84	44.79	74.00	-29.21	Vertical
4882.00	48.06	31.20	6.86	41.84	44.28	74.00	-29.72	Horizontal
Detector: Average Value								
Frequency (MHz)	Read Level (dBuV)	Antenna Factor (dB/m)	Cable Loss (dB)	Preamp Factor (dB)	Level (dBuV/m)	Limit Line (dBuV/m)	Over Limit (dB)	Polarization
4882.00	38.64	31.20	6.86	41.84	34.86	54.00	-19.14	Vertical
4882.00	38.03	31.20	6.86	41.84	34.25	54.00	-19.75	Horizontal
Test channel: Highest channel								
Detector: Peak Value								
Frequency (MHz)	Read Level (dBuV)	Antenna Factor (dB/m)	Cable Loss (dB)	Preamp Factor (dB)	Level (dBuV/m)	Limit Line (dBuV/m)	Over Limit (dB)	Polarization
4960.00	48.67	31.63	6.91	41.87	45.34	74.00	-28.66	Vertical
4960.00	48.25	31.63	6.91	41.87	44.92	74.00	-29.08	Horizontal
Detector: Average Value								
Frequency (MHz)	Read Level (dBuV)	Antenna Factor (dB/m)	Cable Loss (dB)	Preamp Factor (dB)	Level (dBuV/m)	Limit Line (dBuV/m)	Over Limit (dB)	Polarization
4960.00	38.24	31.63	6.91	41.87	34.91	54.00	-19.09	Vertical
4960.00	37.85	31.63	6.91	41.87	34.52	54.00	-19.48	Horizontal
Remark: 1. Final Level = Receiver Read level + Antenna Factor + Cable Loss – Pre-amplifier Factor. 2. The emission levels of other frequencies are very lower than the limit and not show in test report.								

7 Test Setup Photo

Radiated Spurious Emission
Below 1GHz

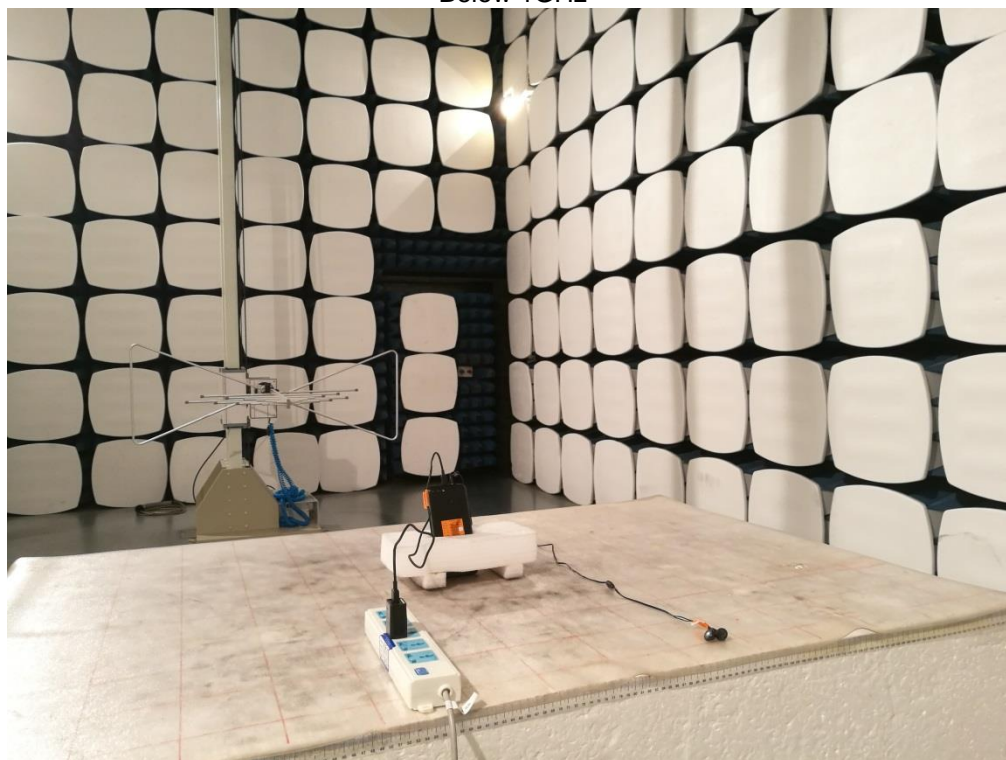

Above 1GHz

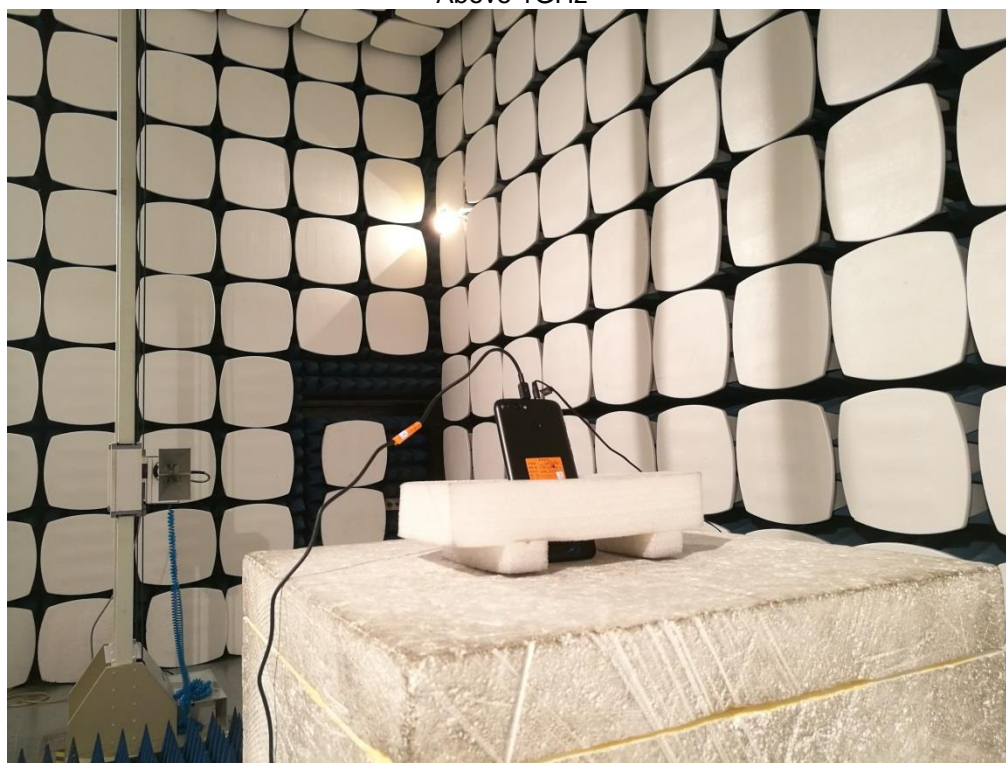

Conducted Emission

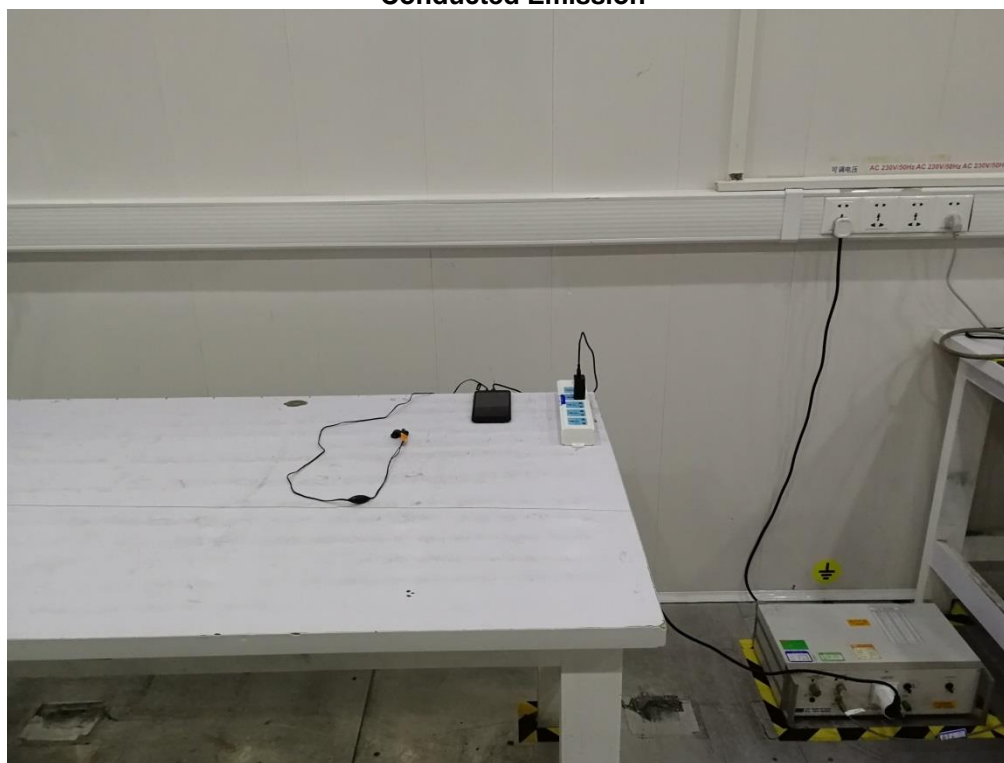

8 EUT Constructional Details

Reference to the test report No.: CCISE191202201

-----End of report-----