

# **FCC REPORT**

## **(GSM & WCDMA)**

**Applicant:** SWAGTEK

**Address of Applicant:** 10205 NW 19th Street, STE 101, Miami, FL33172, USA

**Equipment Under Test (EUT)**

Product Name: 5 inch LTE Phone

Model No.: Logic L5U, iSWAG Legacy lite, UNONU UL5002

Trade mark: LOGIC

**FCC ID:** O55501417

**Applicable standards:** FCC CFR Title 47 Part 2  
FCC CFR Title 47 Part 22 Subpart H  
FCC CFR Title 47 Part 24 Subpart E

**Date of sample receipt:** 11 Apr., 2017

**Date of Test:** 11 Apr., to 05 May, 2017

**Date of report issued:** 05 May, 2017

**Test Result:** PASS\*

\* In the configuration tested, the EUT complied with the standards specified above.

Authorized Signature:



Bruce Zhang  
Laboratory Manager

This report details the results of the testing carried out on one sample. The results contained in this test report do not relate to other samples of the same product and does not permit the use of the CCIS product certification mark. The manufacturer should ensure that all products in series production are in conformity with the product sample detailed in this report.

This report may only be reproduced and distributed in full. If the product in this report is used in any configuration other than that detailed in the report, the manufacturer must ensure the new system complies with all relevant standards.

This document cannot be reproduced except in full, without prior written approval of the Company. Any unauthorized alteration, forgery or falsification of the content or appearance of this document is unlawful and offenders may be prosecuted to the fullest extent of the law. Unless otherwise stated the results shown in this test report refer only to the sample(s) tested and such sample(s) are retained for 90 days only.

## 2. Version

Version No.	Date	Description
00	05 May, 2017	Original

**Tested by:**

  
\_\_\_\_\_  
**Test Engineer**

**Date:**

05 May, 2017

**Reviewed by:**

  
\_\_\_\_\_  
**Project Engineer**

**Date:**

05 May, 2017

## 3. Contents

	Page
<b>1. COVER PAGE</b> .....	<b>1</b>
<b>2. VERSION</b> .....	<b>2</b>
<b>3. CONTENTS</b> .....	<b>3</b>
<b>4. TEST SUMMARY</b> .....	<b>4</b>
<b>5. GENERAL INFORMATION</b> .....	<b>5</b>
5.1 CLIENT INFORMATION.....	5
5.2 GENERAL DESCRIPTION OF E.U.T.....	5
5.3 TEST MODES.....	8
5.4 MEASUREMENT UNCERTAINTY.....	8
5.5 RELATED SUBMITTAL(S) / GRANT (S).....	8
5.6 TEST METHODOLOGY.....	8
5.7 LABORATORY FACILITY.....	8
5.8 LABORATORY LOCATION.....	8
5.9 TEST INSTRUMENTS LIST.....	9
<b>6. SYSTEM TEST CONFIGURATION</b> .....	<b>10</b>
6.1 EUT CONFIGURATION.....	10
6.2 EUT EXERCISE.....	10
6.3 CONFIGURATION OF TESTED SYSTEM.....	10
6.4 DESCRIPTION OF TEST MODES.....	10
6.5 CONDUCTED OUTPUT POWER.....	11
6.6 OCCUPY BANDWIDTH.....	14
6.7 PEAK-TO-AVERAGE POWER RATIO.....	28
6.8 MODULATION CHARACTERISTIC.....	32
6.9 OUT OF BAND EMISSION AT ANTENNA TERMINALS.....	32
6.10 ERP, EIRP MEASUREMENT.....	42
6.11 FIELD STRENGTH OF SPURIOUS RADIATION MEASUREMENT.....	45
6.12 FREQUENCY STABILITY V.S. TEMPERATURE MEASUREMENT.....	50
6.13 FREQUENCY STABILITY V.S. VOLTAGE MEASUREMENT.....	54
<b>7 TEST SETUP PHOTO</b> .....	<b>56</b>
<b>8 EUT CONSTRUCTIONAL DETAILS</b> .....	<b>57</b>

## 4. Test Summary

Test Item	Section in CFR 47	Result
RF Exposure (SAR)	Part 1.1307 Part 2.1093	Pass (Please refer to SAR Report)
RF Output Power	Part 2.1046 Part 22.913 (a)(2) Part 24.232 (c)	Pass
Peak-to-Average Power Ratio	Part 24.232 (d)	Pass
Modulation Characteristics	Part 2.1047	Pass
99% & -26 dB Occupied Bandwidth	Part 2.1049 Part 22.917(b) Part 24.238(b)	Pass
Spurious Emissions at Antenna Terminal	Part 2.1051 Part 22.917 (a) Part 24.238 (a)	Pass
Field Strength of Spurious Radiation	Part 2.1053 Part 22.917 (a) Part 24.238 (a)	Pass
Out of band emission, Band Edge	Part 22.917 (a) Part 24.238 (a)	Pass
Frequency stability vs. temperature	Part 22.355 Part 24.235 Part 2.1055(a)(1)(b)	Pass
Frequency stability vs. voltage	Part 22.355 Part 24.235 Part 2.1055(d)(2)	Pass

*Pass: The EUT complies with the essential requirements in the standard.*

## 5. General Information

### 5.1 Client Information

Applicant:	SWAGTEK
Address of Applicant:	10205 NW 19th Street, STE 101, Miami, FL33172, USA
Manufacturer/ Factory:	SWAGTEK
Address of Manufacturer/ Factory:	10205 NW 19th Street, STE 101, Miami, FL33172, USA

### 5.2 General Description of E.U.T.

Product Name:	5 inch LTE Phone
Model No.:	Logic L5U, iSWAG Legacy lite, UNONU UL5002
Operation Frequency range:	GSM 850: 824.20MHz-848.80MHz PCS1900: 1850.20MHz-1909.80MHz WCDMA Band V: 826.4MHz-846.6MHz WCDMA Band II: 1852.4 MHz -1907.6 MHz
Modulation type:	GSM/GPRS:GMSK, UMTS:QPSK, EGPRS: 8PSK
Antenna type:	Internal Antenna
Antenna gain:	GSM 850: -3.07 dBi PCS 1900: -1.68 dBi WCDMA Band V: -3.07 dBi WCDMA Band II: 1.68 dBi
Power supply:	Rechargeable Li-Polymer Battery DC3.8V-2300mAh
AC adapter:	Input: AC100-240V 50/60Hz 0.2A Output: DC 5.0V, 1A
Remark:	Model No.: Logic L5U, iSWAG Legacy lite, UNONU UL5002 were identical inside, the electrical circuit design, layout, components used and internal wiring, with only difference being model name for different areas.

**Operation Frequency List:**

GSM 850		PCS1900	
Channel:	Frequency (MHz)	Channel:	Frequency (MHz)
128	824.20	512	1850.20
129	824.40	513	1850.40
....	....	....	....
189	836.40	660	1879.80
190	836.60	661	1880.00
191	836.80	662	1880.20
...	...	...	...
250	848.60	809	1909.60
251	848.80	810	1909.80
WCDMA Band V		WCDMA Band II	
Channel:	Frequency (MHz)	Channel:	Frequency (MHz)
4132	826.40	9262	1852.40
4133	826.60	9263	1852.60
....	....	....	....
4182	836.40	9399	1879.80
4183	836.60	9400	1880.00
4184	836.80	9401	1880.20
...	...	...	...
4232	846.40	9537	1907.40
4233	846.60	9538	1907.60

Regards to the operating frequency range over 10 MHz, the Lowest frequency, the middle frequency, and the highest frequency of channel were selected to perform the test, and the selected channel see below:

GSM850			PCS1900		
Channel		Frequency(MHz)	Channel		Frequency(MHz)
Lowest channel	128	824.20	Lowest channel	512	1850.20
Middle channel	190	836.60	Middle channel	661	1880.00
Highest channel	251	848.80	Highest channel	810	1909.80
WCDMA Band V			WCDMA Band II		
Channel		Frequency(MHz)	Channel		Frequency(MHz)
Lowest channel	4132	826.40	Lowest channel	9262	1852.40
Middle channel	4183	836.60	Middle channel	9400	1880.00
Highest channel	4233	846.60	Highest channel	9538	1907.60

## 5.3 Test modes

Voice mode	Keep the EUT in voice mode on GSM 850 and PCS 1900 respectively.
Data mode (GPRS)	Keep the EUT in GPRS mode on GSM 850 and PCS 1900 respectively.
Data mode (EGPRS)	Keep the EUT in EGPRS mode on GSM 850 and PCS 1900 respectively.
Voice mode (AMR 12.2 kbps)	Keep the EUT in voice mode on WCDMA Band II and V respectively.
Data mode (RMC 12.2kbps)	Keep the EUT in RMC on WCDMA Band II and V respectively.
Data mode (HSDPA Subtest 1~4)	Keep the EUT in HSDPA mode on WCDMA Band II and V respectively.
Data mode (HSUPA Subtest 1~5)	Keep the EUT in HSUPA mode on WCDMA Band II and V respectively.
Remark:	Just the worst case mode shown in report.

## 5.4 Measurement Uncertainty

Items	Expanded Uncertainty (Confidence of 95%)
Conducted Emission (9kHz ~ 30MHz)	2.14 dB (k=2)
Radiated Emission (9kHz ~ 30MHz)	4.24 dB (k=2)
Radiated Emission (30MHz ~ 1000MHz)	4.35 dB (k=2)
Radiated Emission (1GHz ~ 18GHz)	4.44 dB (k=2)
Radiated Emission (18GHz ~ 26.5GHz)	4.56 dB (k=2)

## 5.5 Related Submittal(s) / Grant (s)

This submittal(s) (test report) is filing to comply with Section Part 22 subpart H and Part 24 subpart E of the FCC CFR 47 Rules.

## 5.6 Test Methodology

Both conducted and radiated testing were performed according to the procedures document on TIA/EIA 603 and FCC CFR 47.1046, 2.1047, 2.1049, 2.1051, 2.1053, 2.1055 and 2.1057

## 5.7 Laboratory Facility

The test facility is recognized, certified, or accredited by the following organizations:

- **FCC - Registration No.: 817957**

Shenzhen Zhongjian Nanfang Testing Co., Ltd. EMC Laboratory has been registered and fully described in a report filed with the (FCC) Federal Communications Commission. The acceptance letter from the FCC is maintained in out files. Registration 817957, February 27, 2012.

- **IC - Registration No.: 10106A-1**

The 3m Semi-anechoic chamber of Shenzhen Zhongjian Nanfang Testing Co., Ltd. has been Registered by Certification and Engineering Bureau of Industry Canada for radio equipment testing with Registration No.: 10106A-1.

- **CNAS - Registration No.: CNAS L6048**

Shenzhen Zhongjian Nanfang Testing Co., Ltd. is accredited to ISO/IEC 17025:2005 General Requirements for the Competence of Testing and Calibration laboratories for the competence of testing. The Registration No. is CNAS L6048.

## 5.8 Laboratory Location

Shenzhen Zhongjian Nanfang Testing Co., Ltd.  
 Address: No. B-C, 1/F., Building 2, Laodong No.2 Industrial Park, Xixiang Road,  
 Bao'an District, Shenzhen, Guangdong, China  
 Tel: +86-755-23118282  
 Fax: +86-755-23116366



## 5.9 Test Instruments list

Test Equipment	Manufacturer	Model No.	Inventory No.	Cal. Date (mm-dd-yy)	Cal. Due date (mm-dd-yy)
3m Semi- Anechoic Chamber	SAEMC	9(L)*6(W)* 6(H)	CCIS0001	08-23-2014	08-22-2017
BiConiLog Antenna	SCHWARZBECK MESS-ELEKTRONIK	VULB9163	CCIS0005	02-25-2017	02-24-2018
Double -ridged waveguide horn	SCHWARZBECK MESS-ELEKTRONIK	BBHA9120D	CCIS0006	02-25-2017	02-24-2018
EMI Test Software	AUDIX	E3	N/A	N/A	N/A
Amplifier (10kHz-1.3GHz)	HP	8447D	CCIS0003	02-25-2017	02-24-2018
Amplifier (1GHz-18GHz)	Compliance Direction Systems Inc.	PAP-1G18	CCIS0011	02-25-2017	02-24-2018
Pre-amplifier (18-26GHz)	Rohde & Schwarz	AFS33-18002 650-30-8P-44	GTS218	02-25-2017	02-24-2018
Horn Antenna	ETS-LINDGREN	3160	GTS217	02-25-2017	02-24-2018
Printer	HP	HP LaserJet P1007	N/A	N/A	N/A
Positioning Controller	UC	UC3000	CCIS0015	N/A	N/A
Spectrum analyzer 9k-30GHz	Rohde & Schwarz	FSP 30	CCIS0023	02-25-2017	02-24-2018
EMI Test Receiver	Rohde & Schwarz	ESPI	CCIS0022	02-25-2017	02-24-2018
EMI Test Receiver	Rohde & Schwarz	ESRP7	CCIS0167	02-25-2017	02-24-2018
Loop antenna	Laplace instrument	RF300	EMC0701	02-25-2017	02-24-2018
Universal radio communication tester	Rhode & Schwarz	CMU200	CCIS0069	02-25-2017	02-24-2018
Signal Analyzer	Rohde & Schwarz	FSIQ3	CCIS0088	02-25-2017	02-24-2018
DC Power Supply	Shenzhen XinNuoEr Technologies Co., Ltd.	WYK-10020K	CCIS0201	10-31-2016	10-30-2017
Temperature Humidity Chamber	Fo Shan Heng Pu Electronics Co., Ltd.	HPGDS-500	CCIS0240	11-18-2016	11-27-2017
Coaxial Cable	N/A	N/A	CCIS0018	02-25-2017	02-24-2018
Coaxial Cable	N/A	N/A	CCIS0020	02-25-2017	02-24-2018

## 6. System test configuration

### 6.1 EUT Configuration

The EUT configuration for testing is installed on RF field strength measurement to meet the commission's requirement and operating in a manner which intends to maximize its emission characteristics in a continuous normal application.

### 6.2 EUT Exercise

The EUT (Transmitter) was operated in the engineering mode to fix the Tx frequency which was for the purpose of the measurements.

### 6.3 Configuration of Tested System

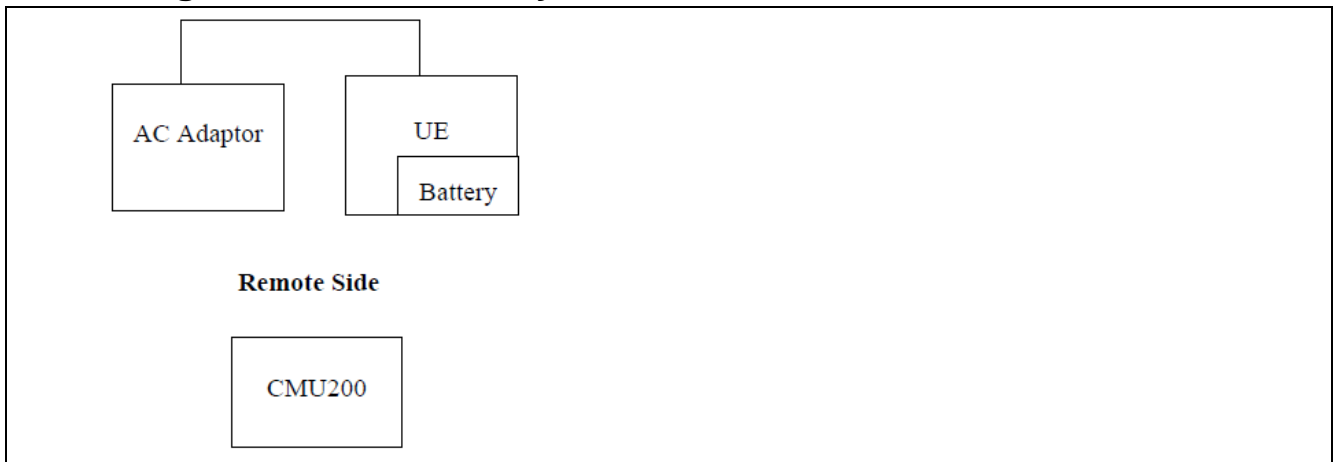

### 6.4 Description of Test Modes

The EUT has been tested under operating condition. EUT staying in continuous transmitting mode. Channel Low, Mid and High for each type band with rated data rate were chosen for full testing. The field strength of spurious radiation emission was measured as EUT stand-up position (H mode) and lie down position (E1, E2 mode) for three modes (GSM850, PCS1900, WCDMA Band V and WCDMA Band II) with power adaptor, earphone and Data cable. The worst-case H mode for GSM850, PCS1900, WCDMA Band V and WCDMA Band II.

## 6.5 Conducted Output Power

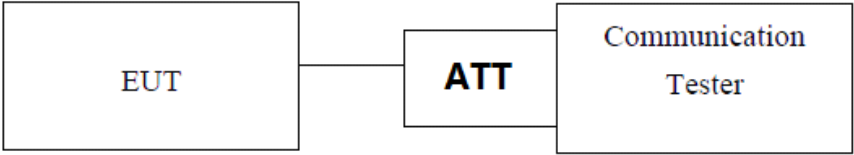
Test Requirement:	FCC part 22.913(a)(2), FCC part 24.232(c)
Test Method:	FCC part 2.1046
Limit:	GSM 850: 7W PCS 1900: 2W WCDMA Band V: 7W WCDMA Band II: 2W
Test setup:	 <p style="text-align: center;"><i>Note: Measurement setup for testing on Antenna connector</i></p>
Test Procedure:	The transmitter output was connected to a calibrated attenuator, the other end of which was connected to the simulated station. Transmitter output power was read off in dBm.
Test Instruments:	Refer to section 5.8 for details
Test mode:	Refer to section 5.3 for details
Test results:	Passed

**Measurement Data:**

EUT Mode	Burst Average power (dBm)			Limit(dBm)
	128	190	251	
	824.20MHz	836.60MHz	848.80MHz	
GSM 850	32.23	32.15	32.10	38.45
GPRS 850 (1 Uplink slot)	32.21	32.15	32.07	
GPRS 850 (2 Uplink slot)	31.23	31.23	31.18	
GPRS 850 (3 Uplink slot)	29.46	29.46	29.46	
GPRS 850 (4 Uplink slot)	28.25	28.27	28.27	
EGPRS 850 (1 Uplink slot)	27.47	27.33	27.24	
EGPRS 850 (2 Uplink slot)	26.59	26.46	26.33	
EGPRS 850 (3 Uplink slot)	25.07	24.89	24.74	
EGPRS 850 (4 Uplink slot)	24.11	23.92	23.86	
EUT Mode	Burst Average power (dBm)			
	512	661	810	
	1850.20MHz	1880.00MHz	1909.80MHz	
PCS 1900	28.61	28.60	28.57	33.00
GPRS 1900 (1 Uplink slot)	28.60	28.58	28.55	
GPRS 1900 (2 Uplink slot)	27.75	27.83	27.85	
GPRS 1900 (3 Uplink slot)	26.24	26.08	26.17	
GPRS 1900 (4 Uplink slot)	25.03	25.19	25.37	
EGPRS 1900 (1 Uplink slot)	25.58	25.86	25.98	
EGPRS 1900 (2 Uplink slot)	24.15	24.58	24.68	
EGPRS 1900 (3 Uplink slot)	22.20	22.29	22.47	
EGPRS 1900 (4 Uplink slot)	20.91	21.21	21.36	

EUT Mode		Burst Average power (dBm)			Limit(dBm)
		4132	4183	4233	
		826.40MHz	836.60MHz	846.60MHz	
UMTS 850 HSDPA	Subtest 1	21.16	21.24	21.04	38.45
	Subtest 2	20.78	20.82	20.72	
	Subtest 3	19.19	19.31	19.19	
	Subtest 4	19.32	19.34	19.16	
UMTS 850 HSUPA	Subtest 1	21.07	21.11	21.03	
	Subtest 2	21.12	21.18	21.06	
	Subtest 3	19.37	19.22	19.14	
	Subtest 4	21.17	21.17	21.07	
	Subtest 5	20.28	20.37	20.21	
UMTS 850 RMC	12.2kbps	22.21	22.29	22.10	
UMTS 850 AMR	12.2kbps	22.19	22.07	21.89	
EUT Mode		Burst Average power (dBm)			
		9262	9400	9538	
		1852.40MHz	1880.00MHz	1907.60MHz	
UMTS 1900 HSDPA	Subtest 1	20.73	20.80	20.86	33.00
	Subtest 2	20.37	20.45	20.57	
	Subtest 3	18.85	19.05	19.18	
	Subtest 4	18.95	19.03	19.11	
UMTS 1900 HSUPA	Subtest 1	20.63	20.65	20.83	
	Subtest 2	20.73	20.78	20.92	
	Subtest 3	18.97	18.99	18.97	
	Subtest 4	20.75	20.74	20.88	
	Subtest 5	19.84	19.89	20.03	
UMTS 1900 RMC	12.2kbps	21.81	21.86	21.84	
UMTS 1900 AMR	12.2kbps	21.70	21.74	21.83	

## 6.6 Occupy Bandwidth

Test Requirement:	FCC part 22.917(b), FCC part 24.238(b)
Test Method:	FCC part 2.1049
Test setup:	<p style="text-align: center;"><i>Note: Measurement setup for testing on Antenna connector</i></p>
Test Procedure:	<ol style="list-style-type: none"> <li>1. The EUT's output RF connector was connected with a short cable to the spectrum analyzer</li> <li>2. RBW was set to about 1% of emission BW, VBW= 3 times RBW.</li> <li>3. -26dBc display line was placed on the screen (or 99% bandwidth), the occupied bandwidth is the delta frequency between the two points where the display line intersects the signal trace.</li> </ol>
Test Instruments:	Refer to section 5.8 for details
Test mode:	Refer to section 5.3 for details
Test results:	Passed

**Measurement Data:**

EUT Mode	Channel	Frequency (MHz)	99% Occupy bandwidth (kHz)	-26dB bandwidth (kHz)
GSM 850	128	824.2	242	316
	190	836.6	248	308
	251	848.8	246	322
EGPRS850	128	824.2	262	330
	190	836.6	262	324
	251	848.8	264	338
PCS 1900	512	1850.2	246	318
	661	1880.0	248	322
	810	1909.8	246	318
EGPRS1900	512	1850.2	248	308
	661	1880.0	248	310
	810	1909.8	242	312
WCDMA BAND V 12.2k RMC	4132	826.4	4240	4880
	4183	836.6	4220	4880
	4233	846.6	4200	4820
WCDMA BAND II 12.2k RMC	9262	1852.4	4220	4860
	9400	1880.0	4240	4940
	9538	1907.6	4260	4900

Note: GSM & GPRS use the same modulation technical (GMSK), and with the same channels, so the 99% OBW and the -26dB of GPRS not performed.

Test plot as follows:

### 99% Occupy bandwidth GSM850

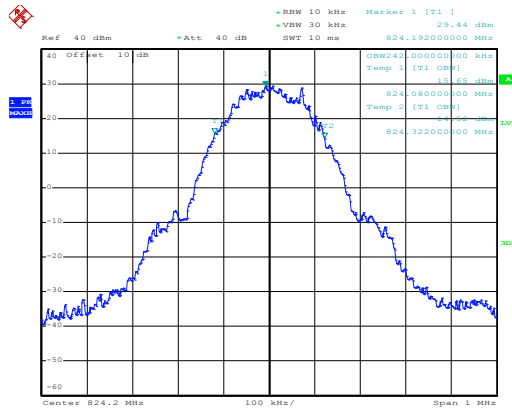

Date: 11.APR.2017 18:37:32

### Lowest channel

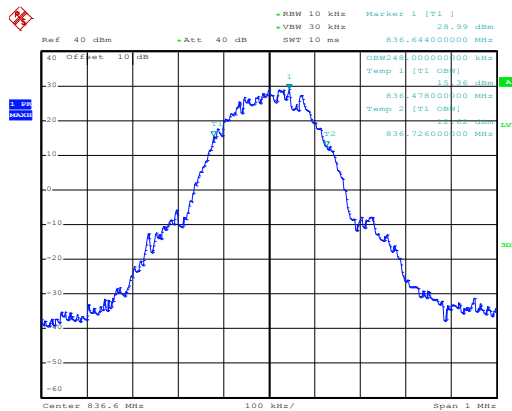

Date: 11.APR.2017 18:38:02

### Middle channel

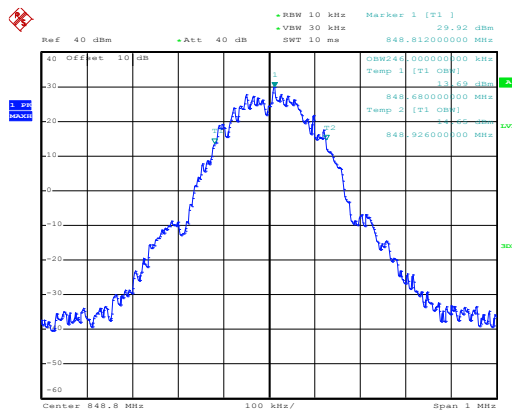

Date: 11.APR.2017 18:38:13

### Highest channel



## 26dB Emission Bandwidth

### GSM850

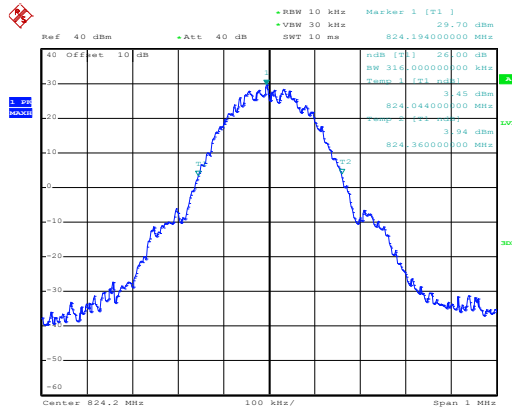

Date: 11.APR.2017 18:37:42

### Lowest channel

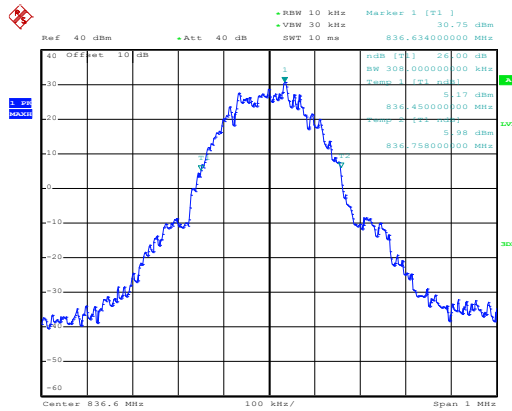

Date: 11.APR.2017 18:37:54

### Middle channel

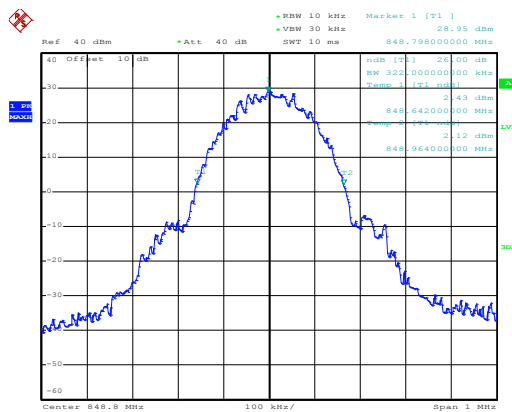

Date: 11.APR.2017 18:38:24

### Highest channel

## 99% Occupancy bandwidth EGPRS850

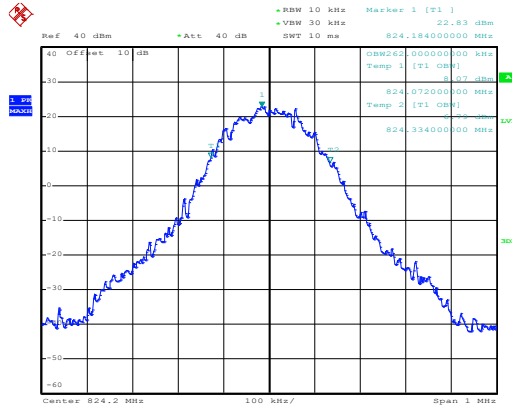

Date: 11.APR.2017 18:41:22

## Lowest channel

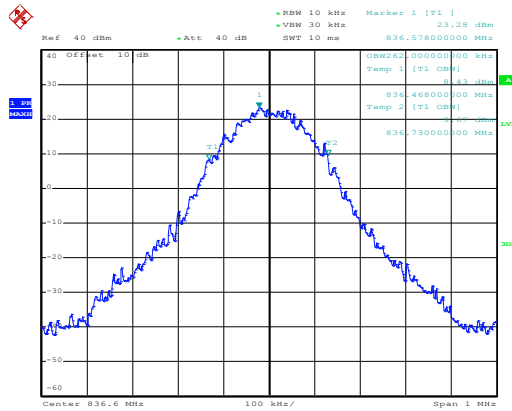

Date: 11.APR.2017 18:41:49

## Middle channel

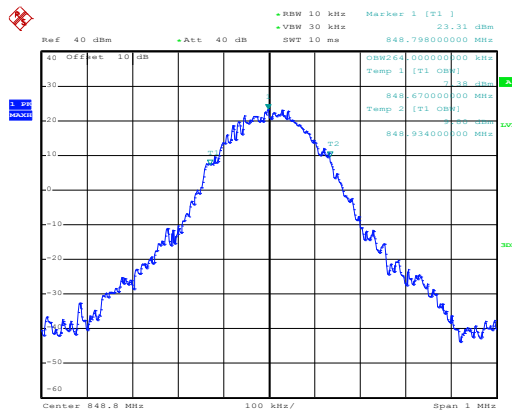

Date: 11.APR.2017 18:42:01

## Highest channel

## 26dB Emission Bandwidth EGPRS850

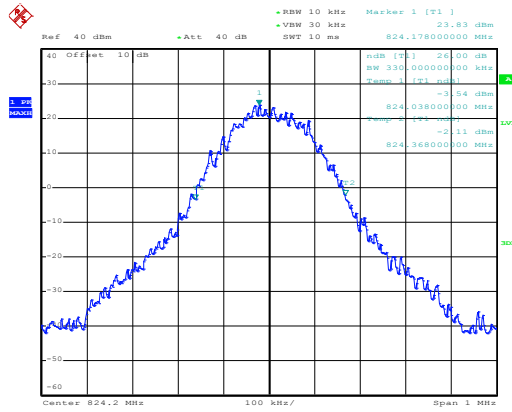

Date: 11.APR.2017 18:41:30

### Lowest channel

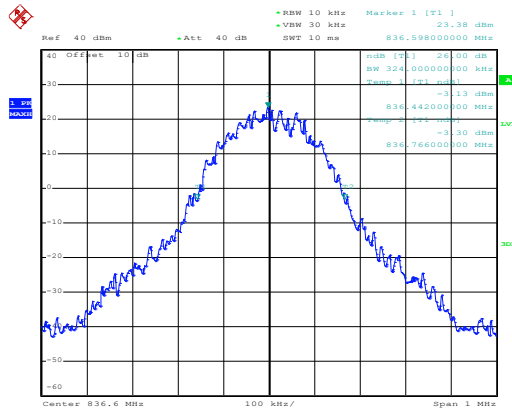

Date: 11.APR.2017 18:41:40

### Middle channel

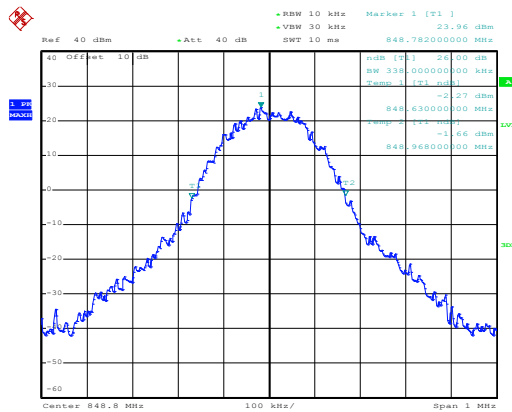

Date: 11.APR.2017 18:42:11

### Highest channel

## 99% Occupy bandwidth

### PCS 1900

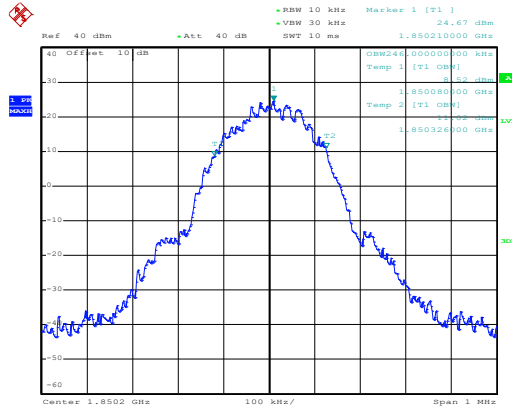

Date: 11.APR.2017 20:03:48

### Lowest channel

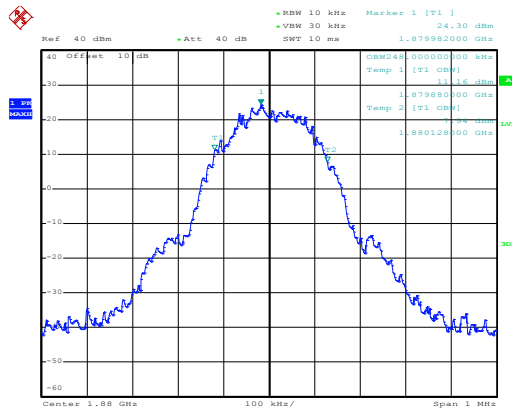

Date: 11.APR.2017 20:04:00

### Middle channel

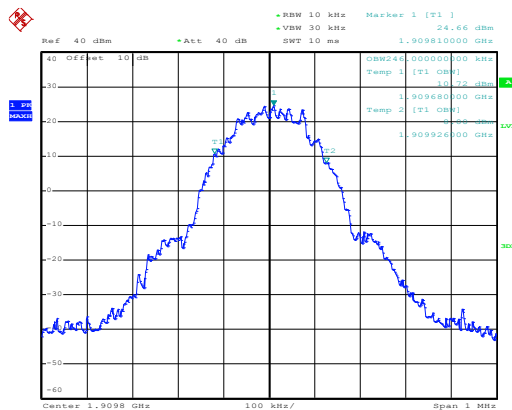

Date: 11.APR.2017 20:04:34

### Highest channel

## 26dB Emission Bandwidth

### PCS 1900

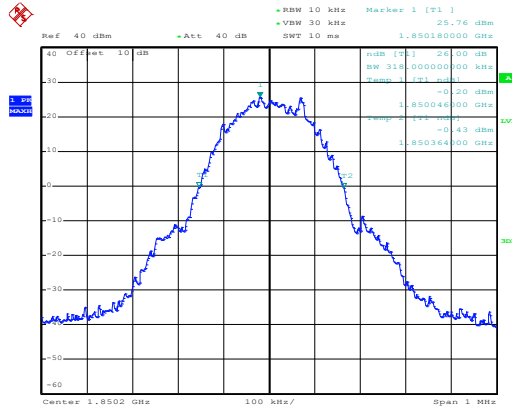

Date: 11.APR.2017 20:03:40

### Lowest channel

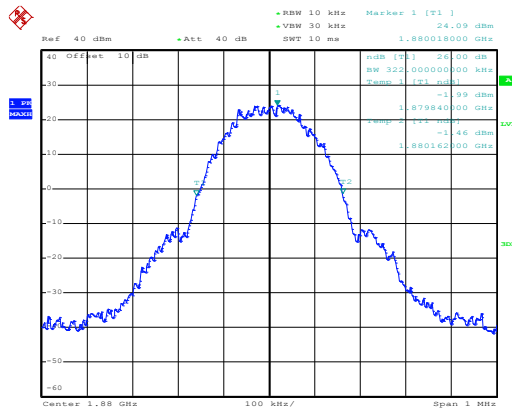

Date: 11.APR.2017 20:04:12

### Middle channel

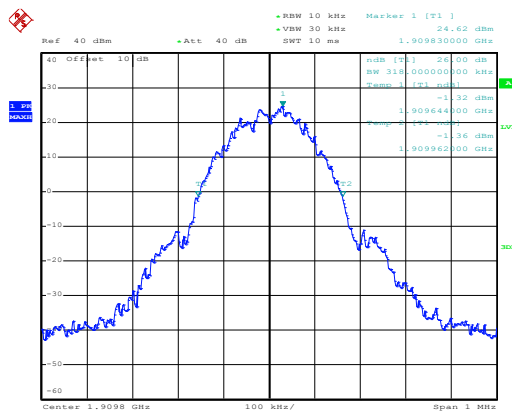

Date: 11.APR.2017 20:04:25

### Highest channel

## 99% Occupy bandwidth EGPRS 1900

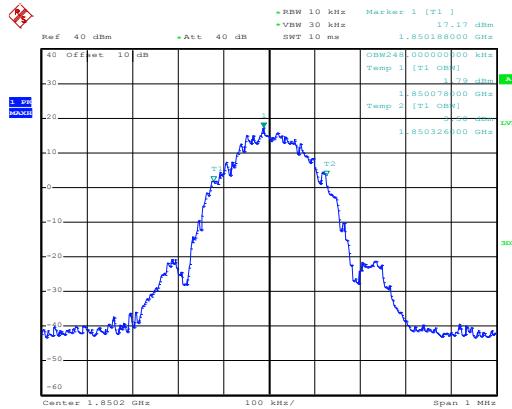

Date: 11.APR.2017 18:48:31

## Lowest channel

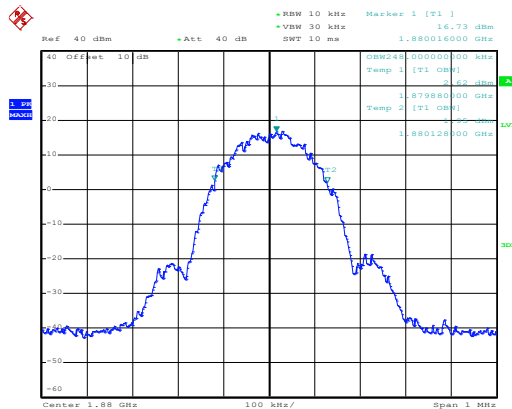

Date: 11.APR.2017 18:48:13

## Middle channel

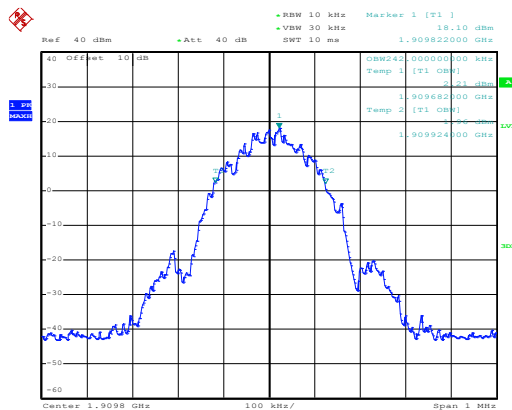

Date: 11.APR.2017 18:47:29

## Highest channel

## 26dB Emission Bandwidth EGPRS 1900

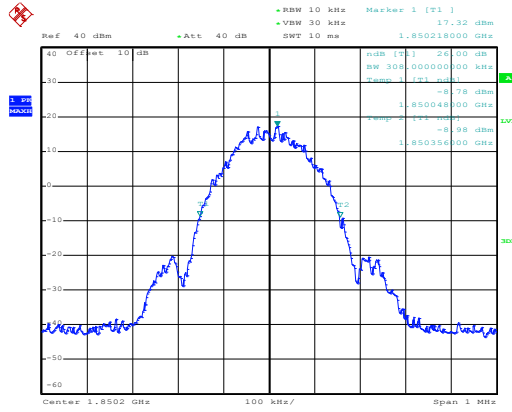

Date: 11.APR.2017 18:48:42

### Lowest channel

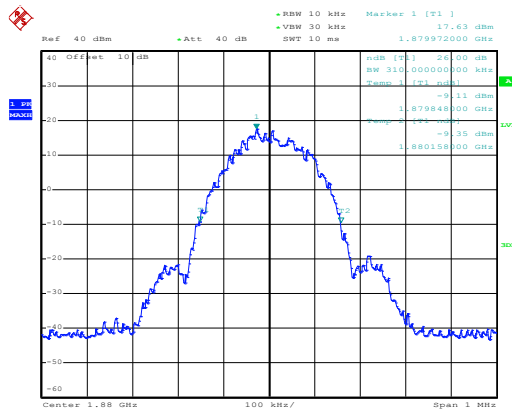

Date: 11.APR.2017 18:47:52

### Middle channel

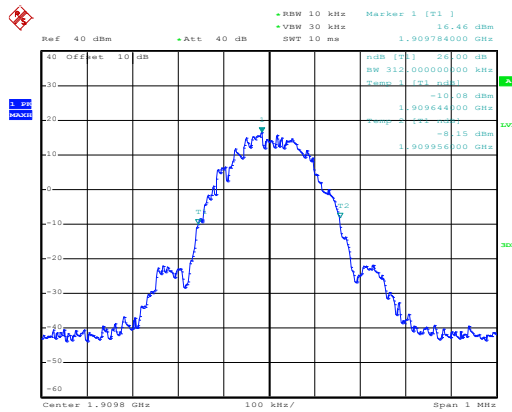

Date: 11.APR.2017 18:47:35

### Highest channel

## 99% Occupy bandwidth UMTS 850 12.2k RMC

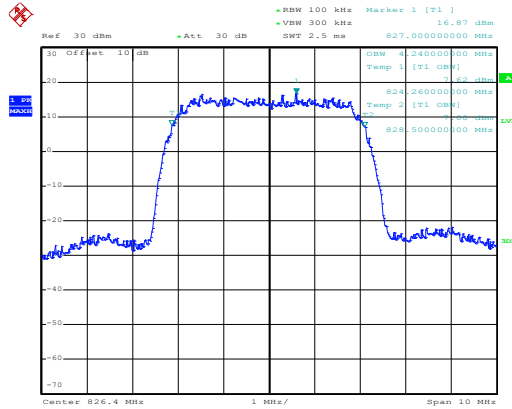

Date: 11.APR.2017 19:02:12

## Lowest channel

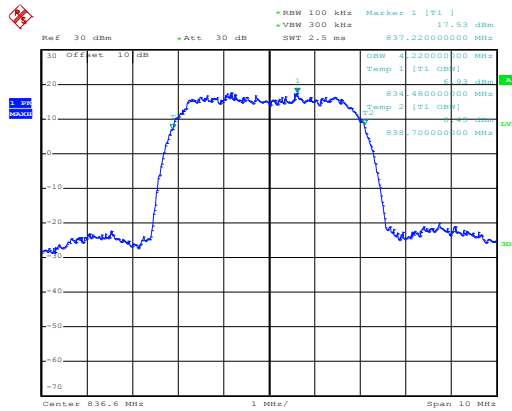

Date: 11.APR.2017 19:02:02

## Middle channel

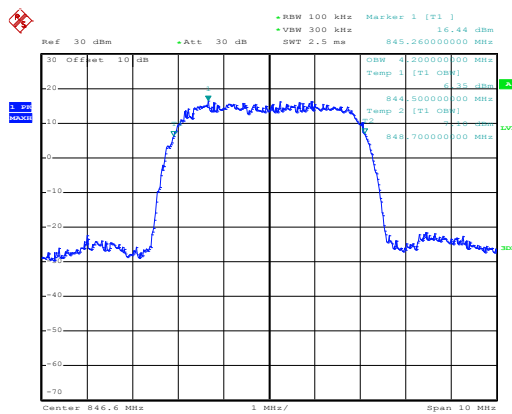

Date: 11.APR.2017 19:02:25

## Highest channel



## 26dB Emission Bandwidth UMTS 850 12.2k RMC

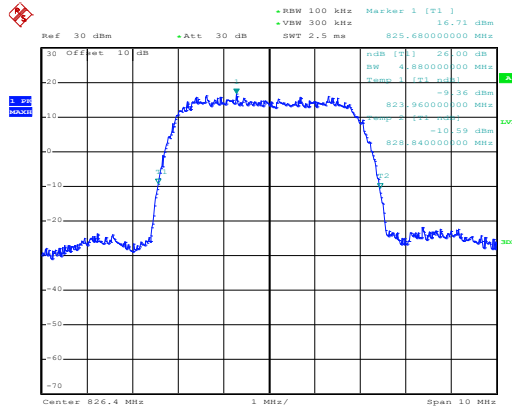

Date: 11.APR.2017 19:02:56

### Lowest channel

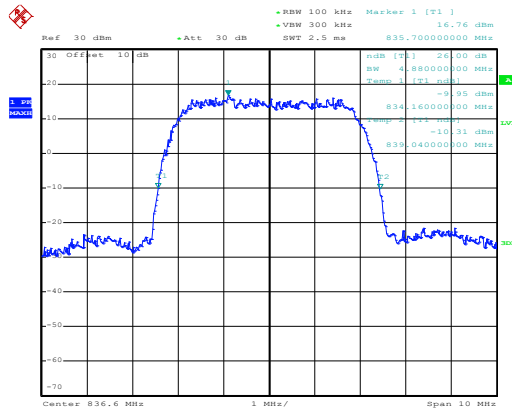

Date: 11.APR.2017 19:02:44

### Middle channel

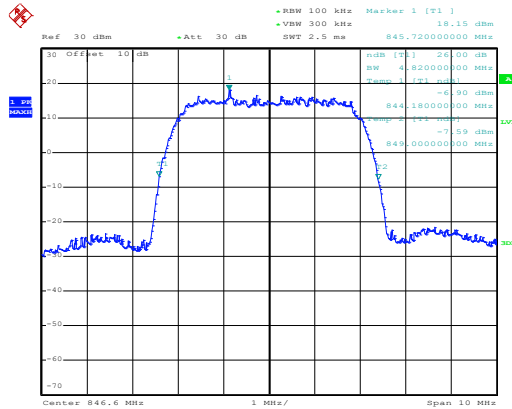

Date: 11.APR.2017 19:02:33

### Highest channel

## 99% Occupy bandwidth UMTS 1900 12.2k RMC

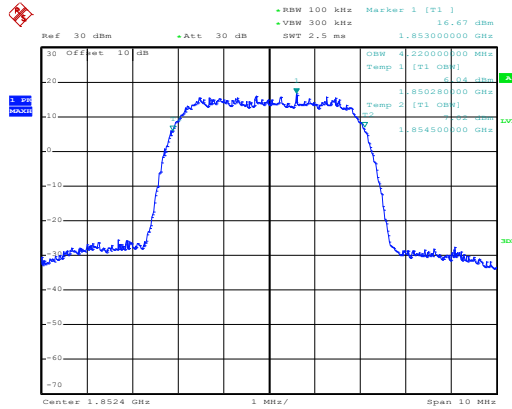

Date: 11.APR.2017 19:10:37

### Lowest channel

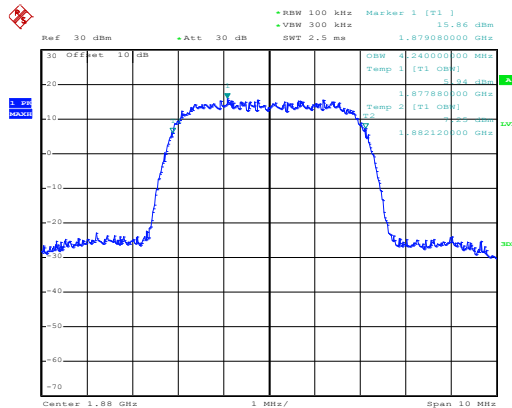

Date: 11.APR.2017 19:11:09

### Middle channel

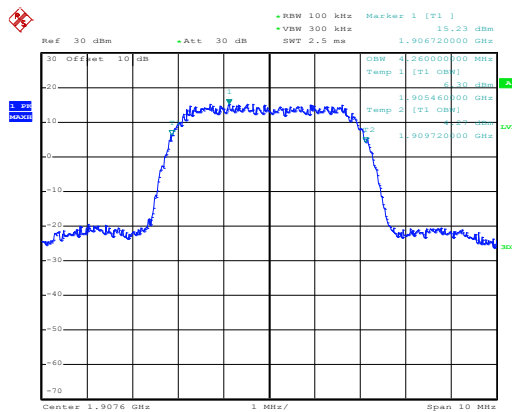

Date: 11.APR.2017 19:11:29

### Highest channel

## 26dB Emission Bandwidth UMTS 1900 12.2k RMC

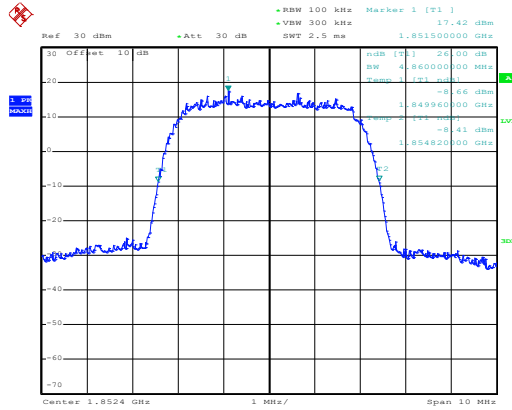

### Lowest channel

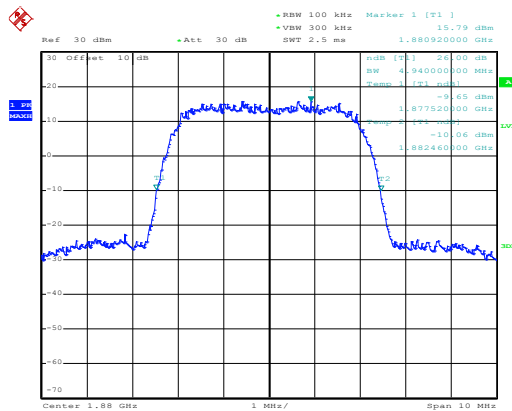

### Middle channel

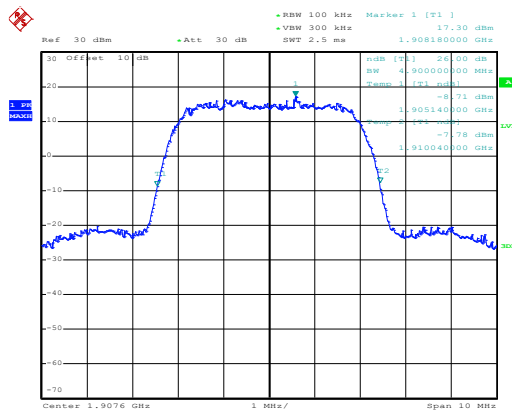

### Highest channel

## 6.7 Peak-to-Average Power Ratio

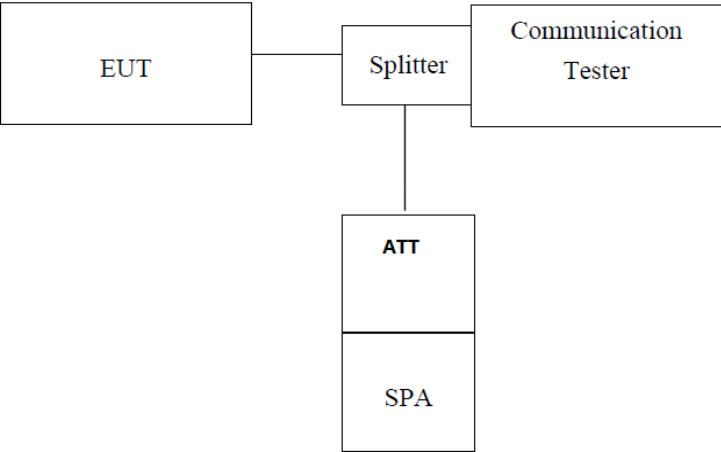
Test Requirement:	FCC part 24.232(d)
Limit:	The peak-to-average ratio (PAR) of the transmission may not exceed 13 dB.
Test setup:	 <p style="text-align: center;"><i>Note: Measurement setup for testing on Antenna connector</i></p>
Test Procedure:	<ol style="list-style-type: none"> <li>1 The RF output of the transceiver was connected to a spectrum analyzer through appropriate attenuation.</li> <li>2 Set the CCDF option in spectrum analyzer, <math>RBW \geq OBW</math>,</li> <li>3 Set the EUT working in highest power level, measured and recorded the 0.1% as PAPR level.</li> <li>4 Repeat step 1~3 at other frequency and modulations.</li> </ol>
Test Instruments:	Refer to section 5.8 for details
Test mode:	Refer to section 5.3 for details
Test results:	Passed

### Measurement Data (worst case):

Modulation	Test channel	PAPR
GSM 850	190	0.12
EGPRS 850	190	0.07
PCS 1900	661	0.09
EGPRS 1900	661	0.10
UMTS 850 RMC	4183	3.00
UMTS 1900 RMC	9400	2.48

Test plots as below:

Middle channel

Modulation: GSM 850

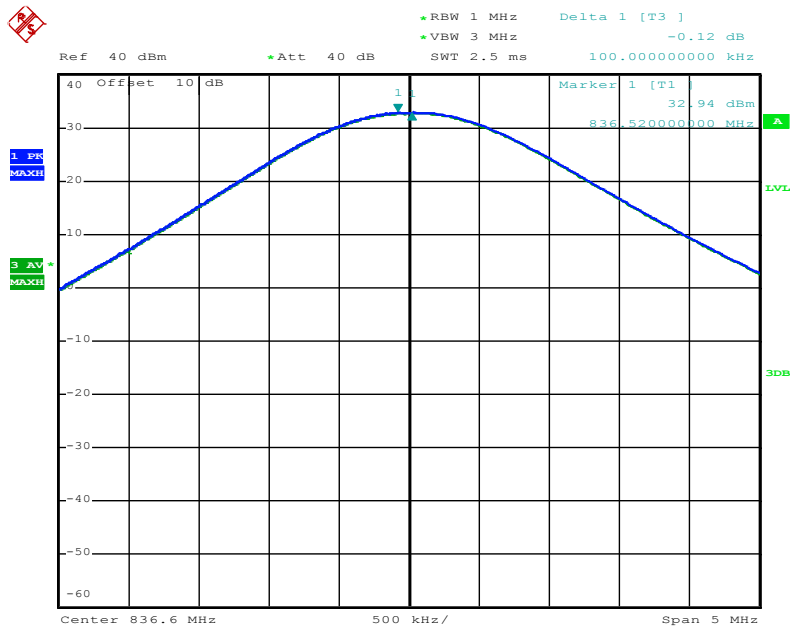

Date: 11.APR.2017 18:39:30

Middle channel

Modulation: EGPRS 850

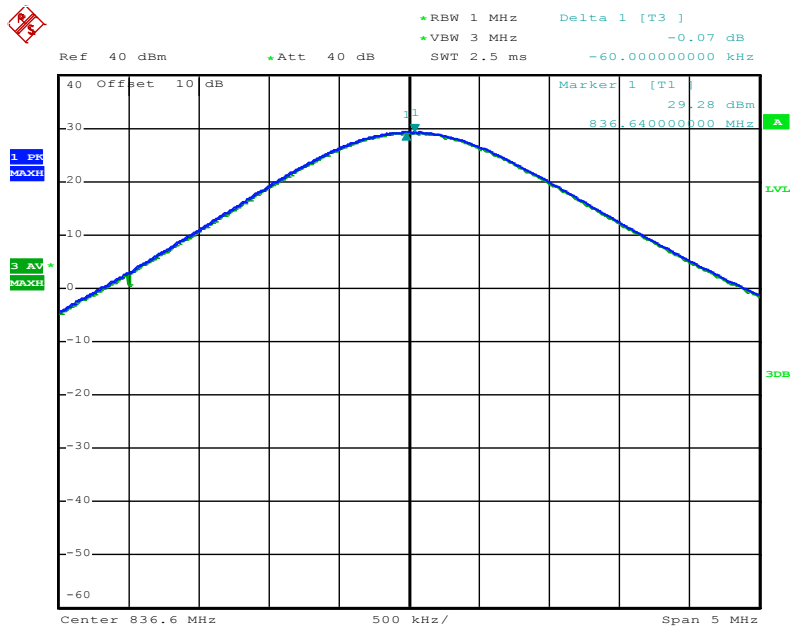

Date: 11.APR.2017 18:40:50

Middle channel

Modulation: PCS 1900

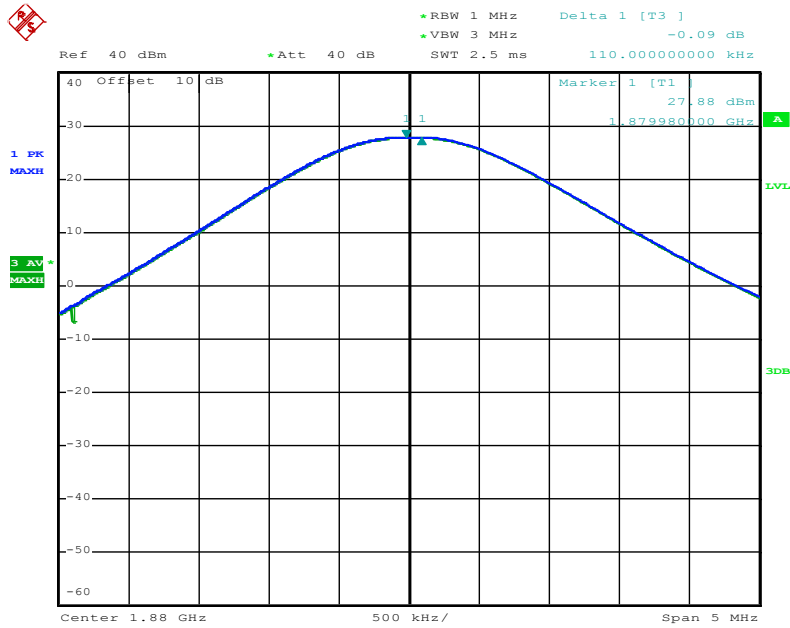

Date: 11.APR.2017 18:56:00

Middle channel

Modulation: EGPRS 1900

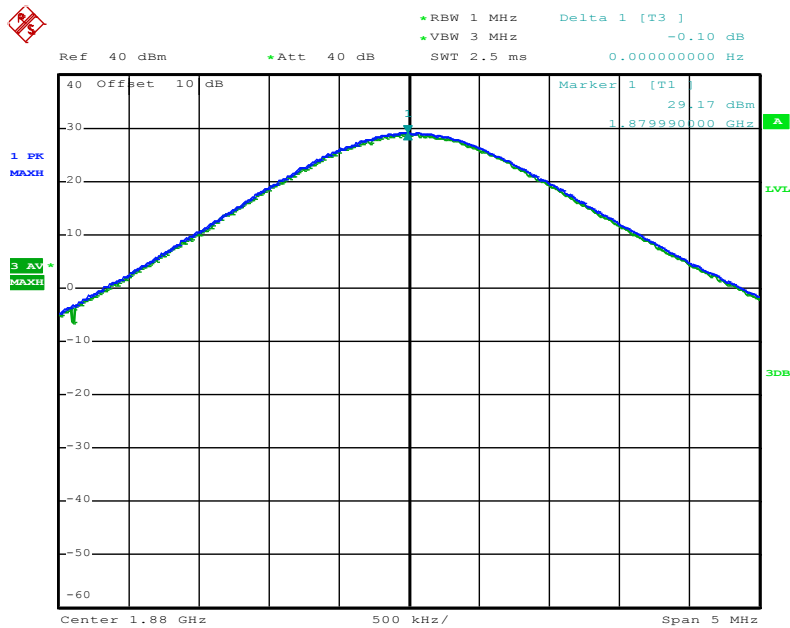

Date: 11.APR.2017 18:58:10

Middle channel

Modulation: WCDMA Band V RMC

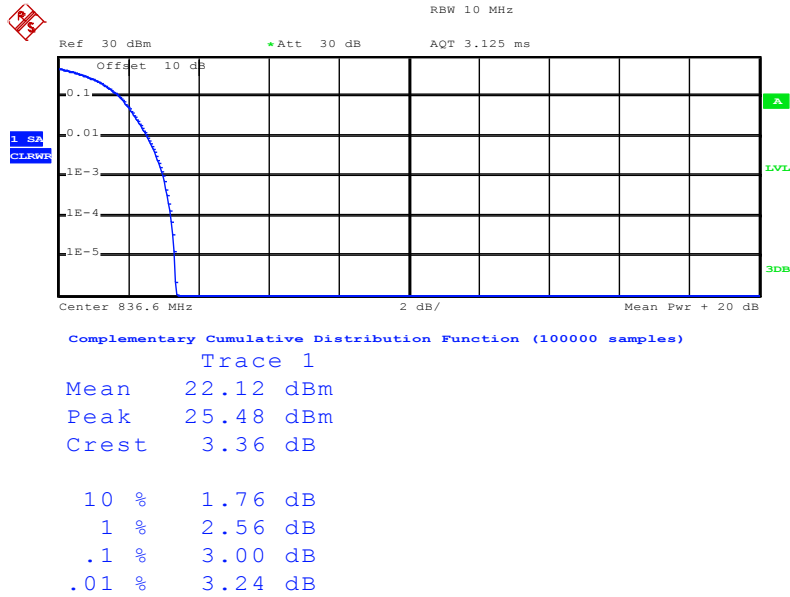

Date: 11.APR.2017 19:01:22

Middle channel

Modulation: WCDMA BAND II RMC

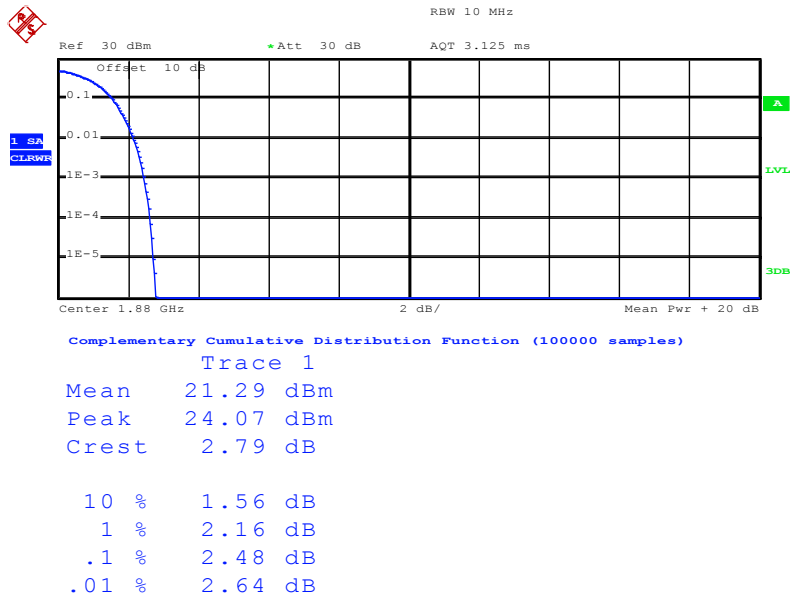

Date: 11.APR.2017 19:12:15

## 6.8 Modulation Characteristic

According to FCC § 2.1047(d), Part 22H & 24E there is no specific requirement for digital modulation, therefore modulation characteristic is not presented.

## 6.9 Out of band emission at antenna terminals

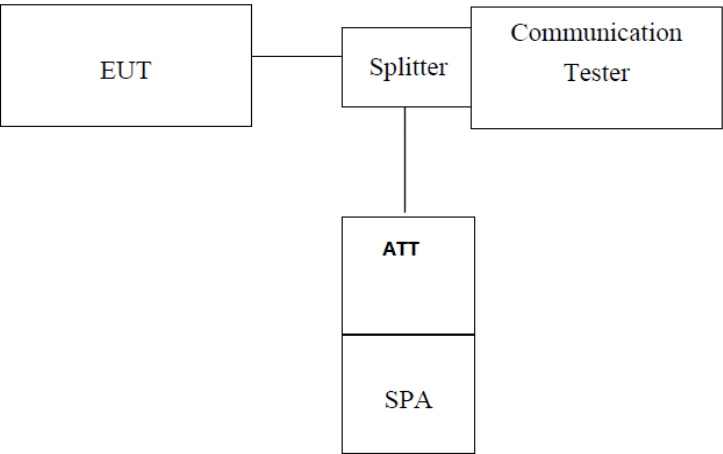
Test Requirement:	FCC part 22.917(a), FCC part 24.238(a)
Test Method:	FCC part 2.1051
Limit:	-13dBm
Test setup:	 <p><i>Note: Measurement setup for testing on Antenna connector</i></p>
Test Procedure:	<ol style="list-style-type: none"> <li>5 The RF output of the transceiver was connected to a spectrum analyzer through appropriate attenuation.</li> <li>6 The resolution bandwidth of the spectrum analyzer was set at 100 kHz when below 1GHz, 1MHz when above 1 GHz; sufficient scans were taken to show the out of band Emissions if any up to 10th harmonic.</li> <li>7 For the out of band: Set the RBW=100 kHz, VBW=300 kHz when below 1 GHz, RBW =1 MHz, VBW=3 MHz when above 1 GHz, Start=30MHz, Stop= 10th harmonic.</li> <li>8 Band Edge Requirements: In the 1 MHz bands immediately outside and adjacent to the frequency block, a resolution bandwidth of at least 1 percent of the emission bandwidth of the fundamental emission of the transmitter may be employed to measure the out of band Emissions.</li> </ol>
Test Instruments:	Refer to section 5.8 for details
Test mode:	Refer to section 5.3 for details
Test results:	Passed



Test plots as follows:

Spurious emission:

### GSM 850

#### Lowest Channel

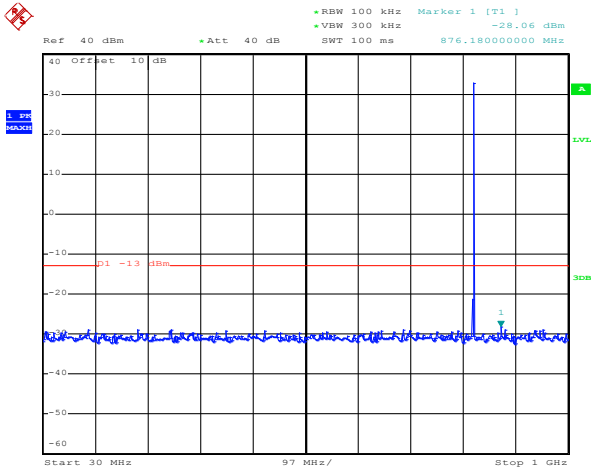

Date: 11.APR.2017 18:36:07

30MHz~1GHz

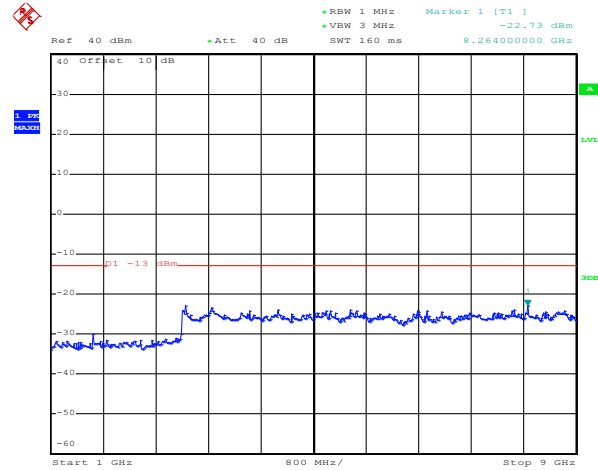

Date: 11.APR.2017 18:36:29

1GHz~9GHz

#### Middle channel

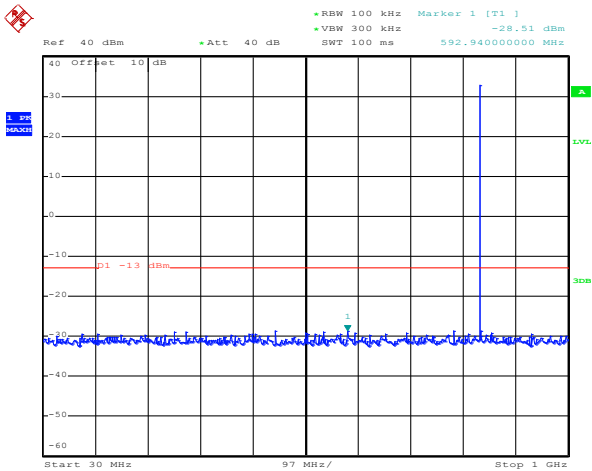

Date: 11.APR.2017 18:35:50

30MHz~1GHz

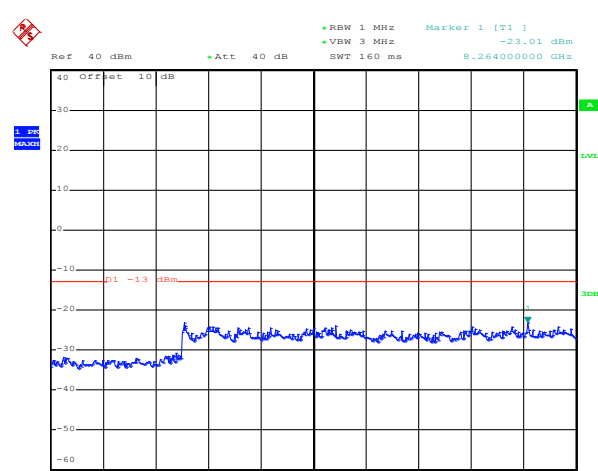

Date: 11.APR.2017 18:36:35

1GHz~9GHz

## Highest Channel

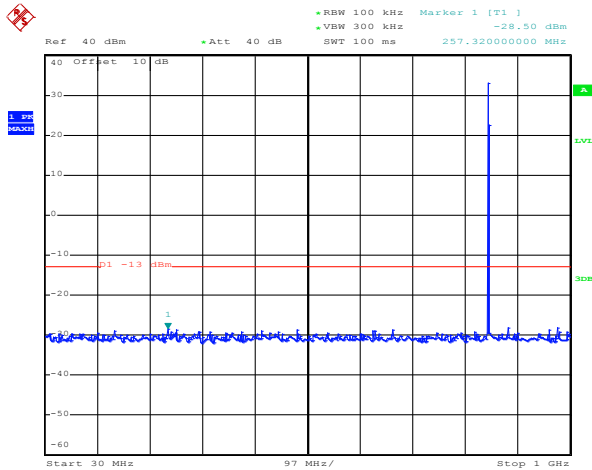

Date: 11.APR.2017 18:35:37

30MHz~1GHz

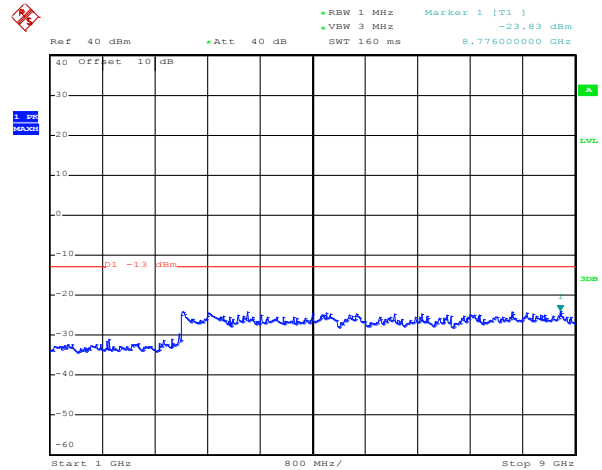

Date: 11.APR.2017 18:36:40

1GHz~9GHz

## PCS 1900

### Lowest Channel

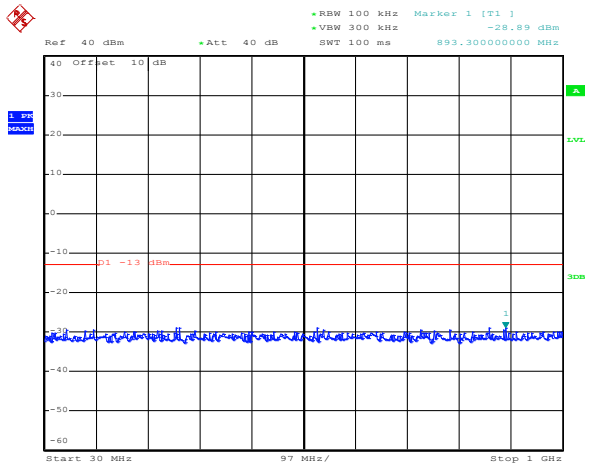

Date: 11.APR.2017 18:53:20

30MHz~1GHz

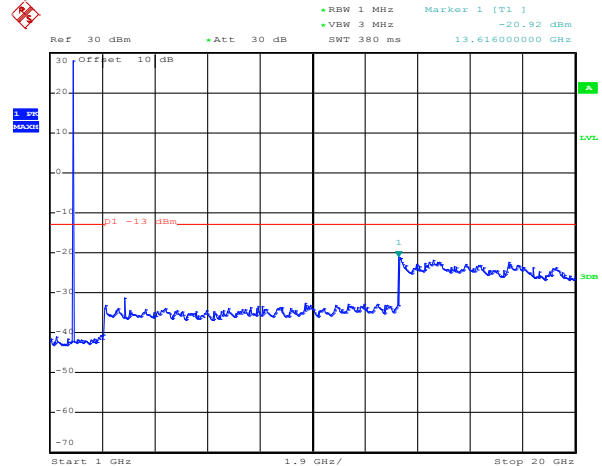

Date: 11.APR.2017 18:55:02

1GHz~20GHz

## Middle Channel

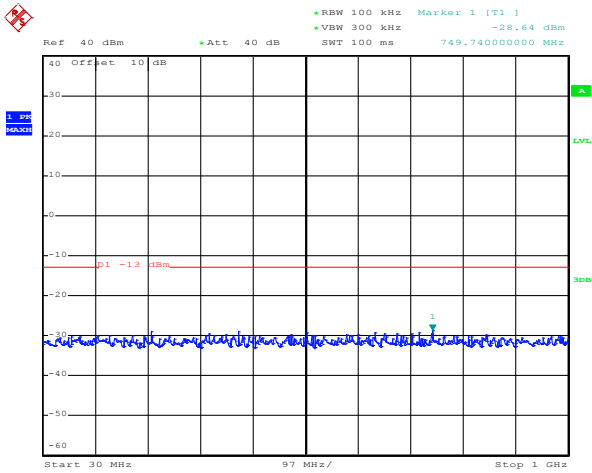

Date: 11.APR.2017 18:53:14

30MHz~1GHz

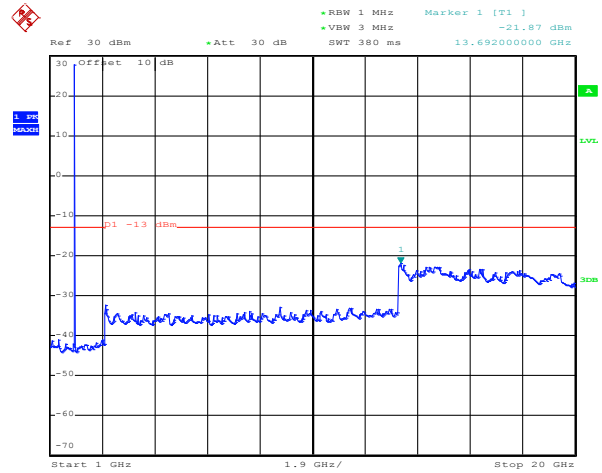

Date: 11.APR.2017 18:54:12

1GHz~20GHz

## Highest Channel

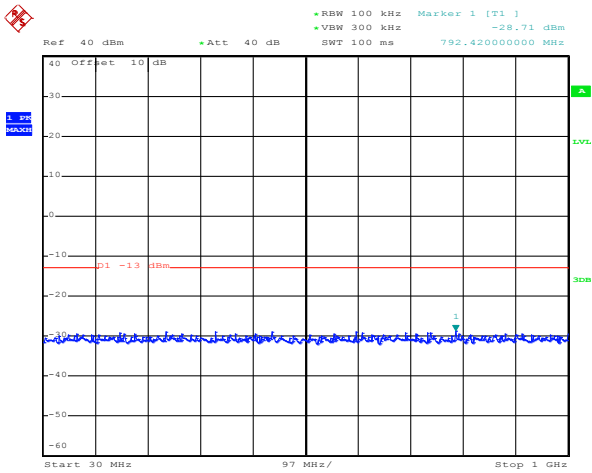

Date: 11.APR.2017 18:53:08

30MHz~1GHz

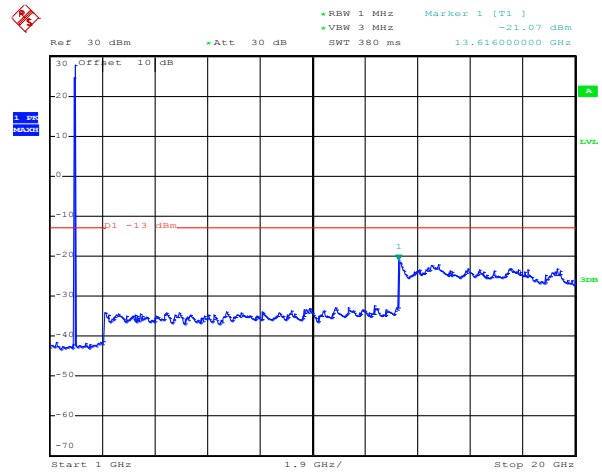

Date: 11.APR.2017 18:53:58

1GHz~20GHz

## WCDMA Band V 12.2k RMC

### Lowest Channel

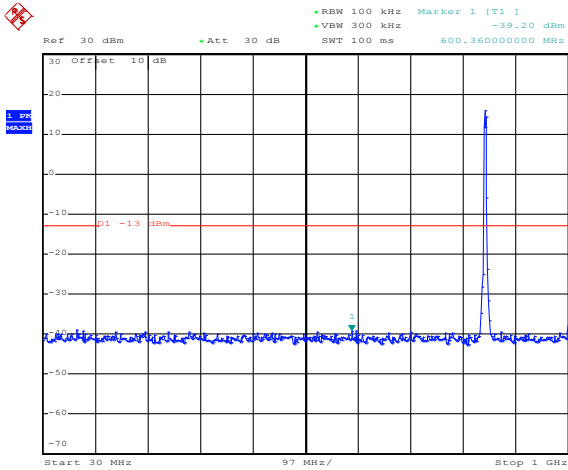

Date: 11.APR.2017 19:04:30

30MHz~1GHz

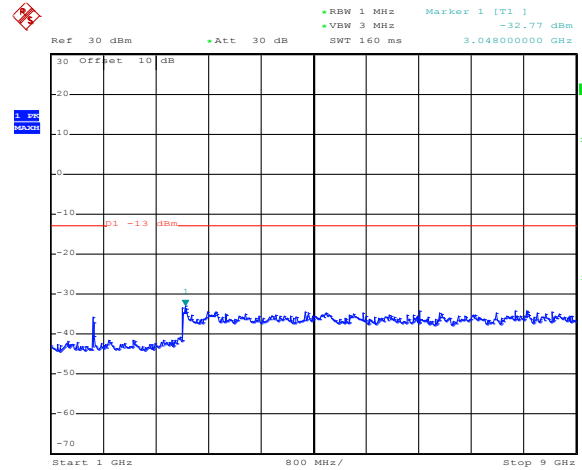

Date: 11.APR.2017 19:05:30

1GHz~9GHz

### Middle Channel

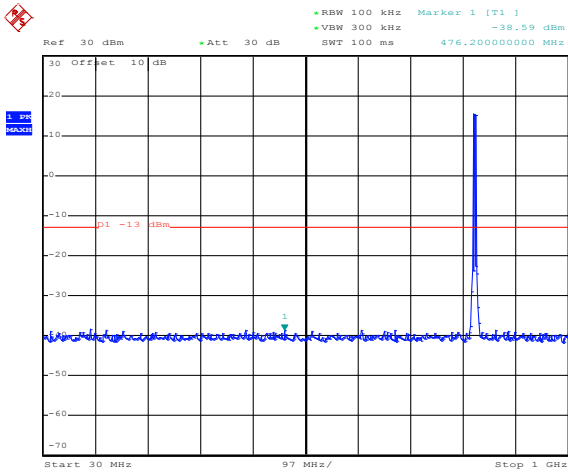

Date: 11.APR.2017 19:03:32

30MHz~1GHz

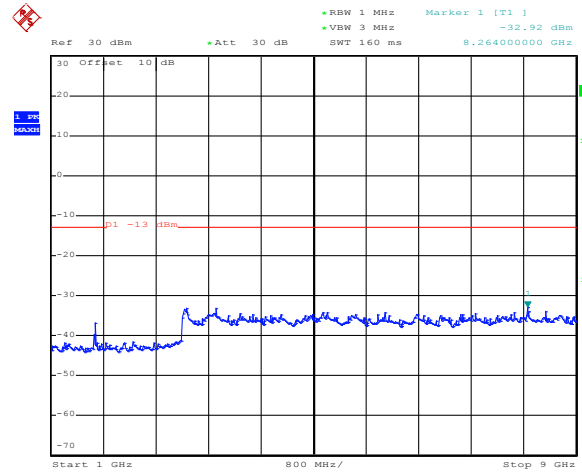

Date: 11.APR.2017 19:05:19

1GHz~9GHz

## Highest Channel

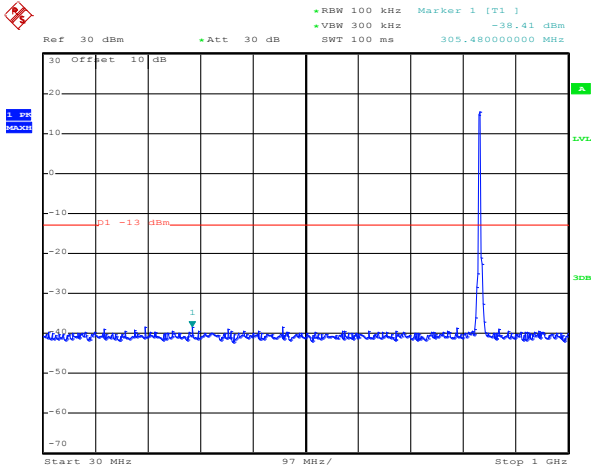

Date: 11.APR.2017 19:04:17

30MHz~1GHz

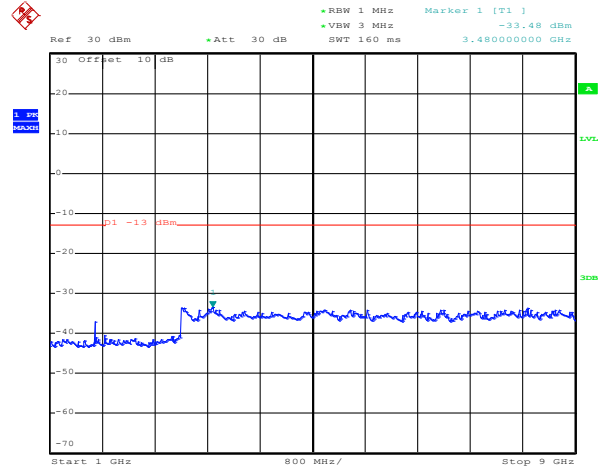

Date: 11.APR.2017 19:05:05

1GHz~9GHz

## WCDMA Band II 12.2k RMC

### Lowest Channel

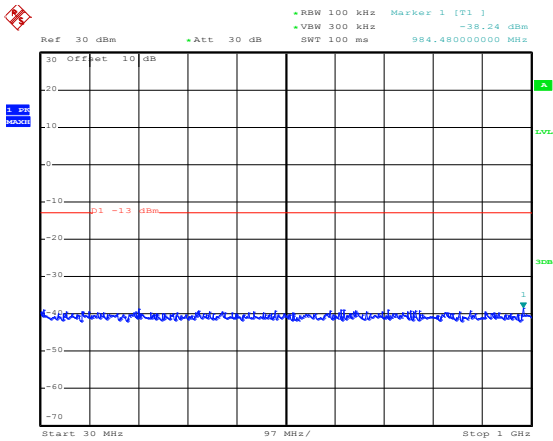

Date: 11.APR.2017 19:06:51

30MHz~1GHz

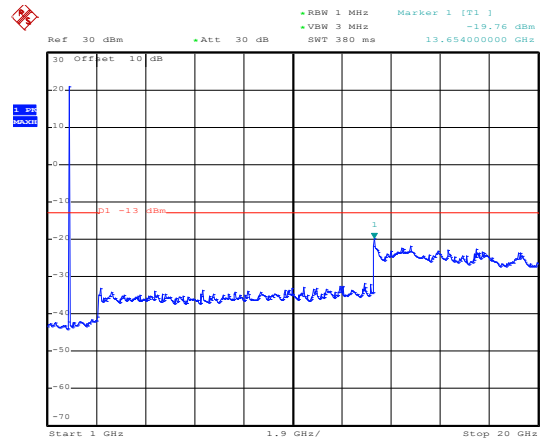

Date: 5.MAY.2017 19:00:04

1GHz~20GHz

## Middle Channel

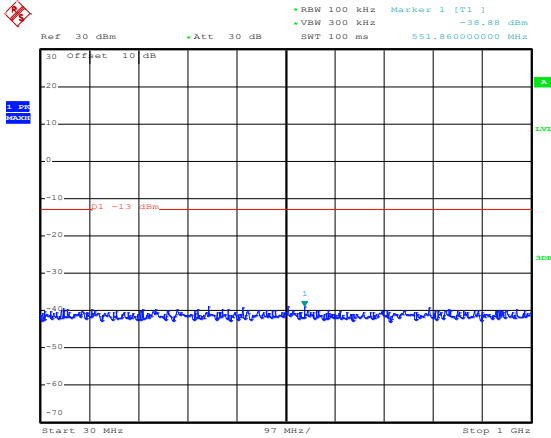

Date: 11.APR.2017 19:06:57

30MHz~1GHz

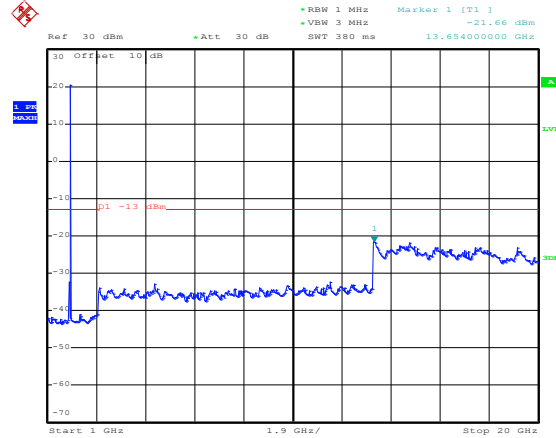

Date: 5.MAY.2017 18:59:47

1GHz~20GHz

## Highest Channel

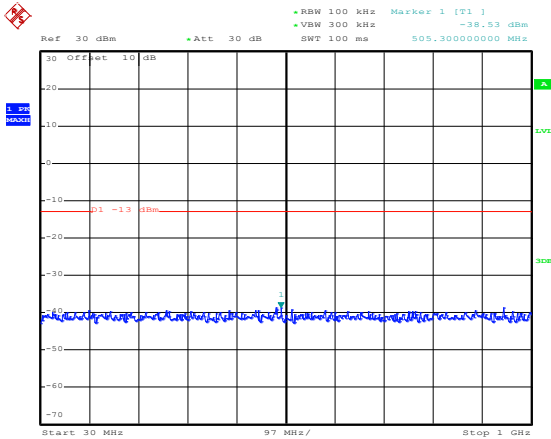

Date: 11.APR.2017 19:07:06

30MHz~1GHz

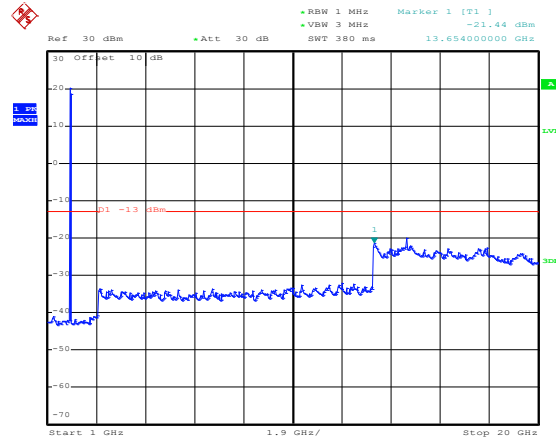

Date: 5.MAY.2017 18:59:28

1GHz~20GHz

**Band edge emission:**

**GSM850**

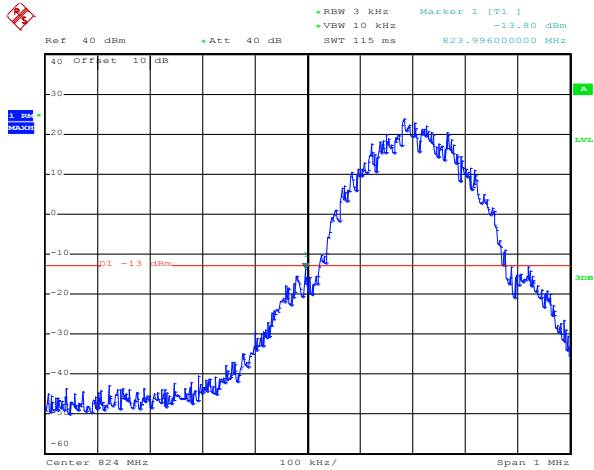

Date: 11.APR.2017 18:33:19

Lowest channel

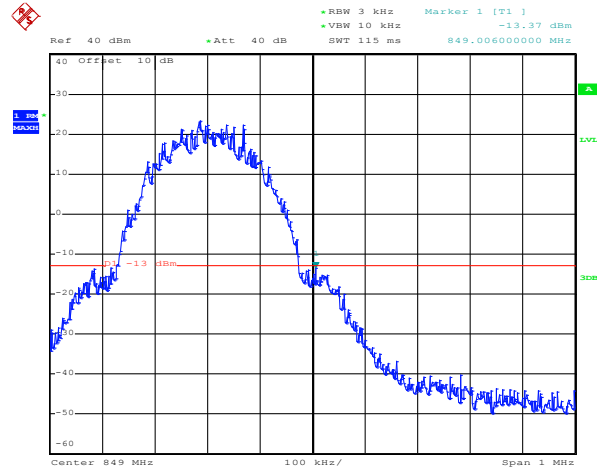

Date: 11.APR.2017 18:34:52

Highest channel

**PCS1900**

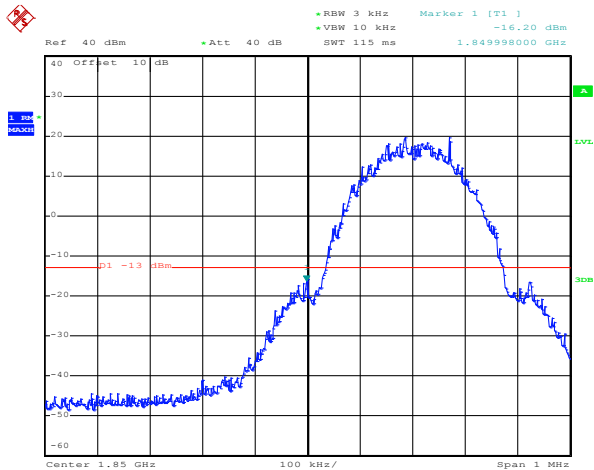

Date: 11.APR.2017 18:52:16

Lowest channel

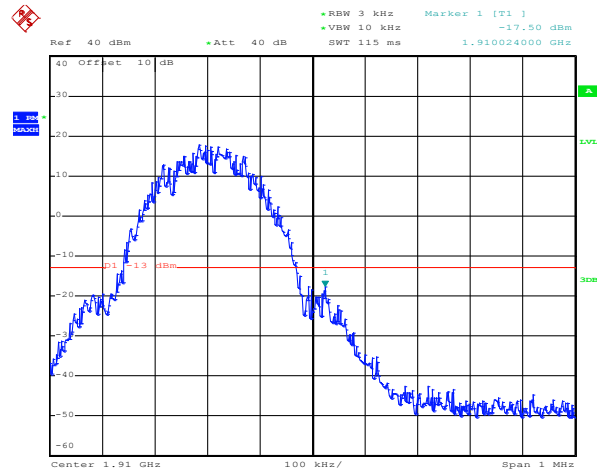

Date: 11.APR.2017 18:52:38

Highest channel

## EGPRS850

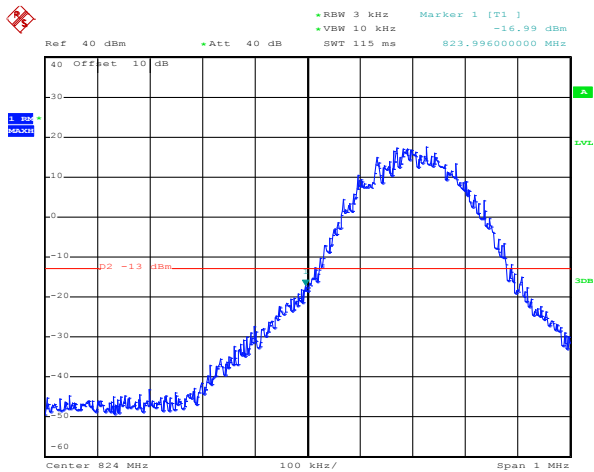

Date: 11.APR.2017 18:43:31

Lowest channel

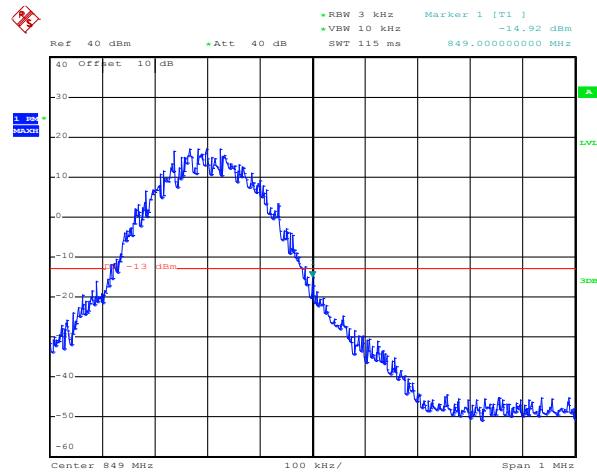

Date: 11.APR.2017 18:43:00

Highest channel

## EGPRS1900

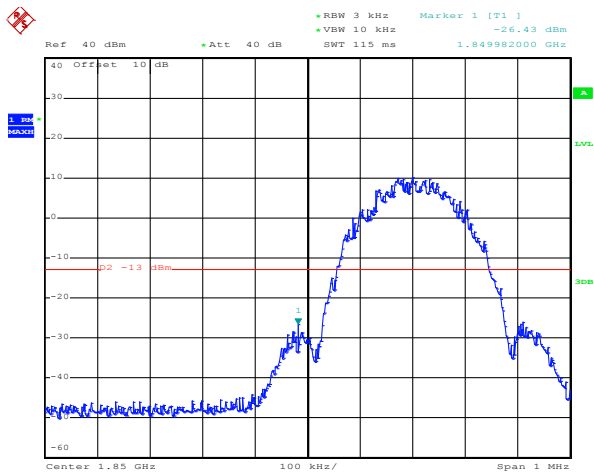

Date: 11.APR.2017 18:46:18

Lowest channel

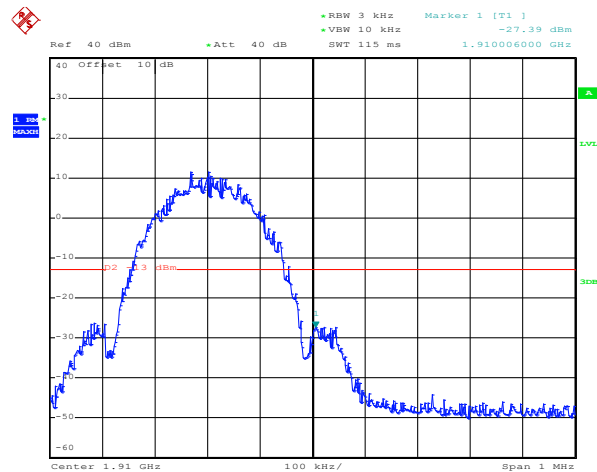

Date: 11.APR.2017 18:46:59

Highest channel



## WCDMA BAND V RMC 12.2kbps

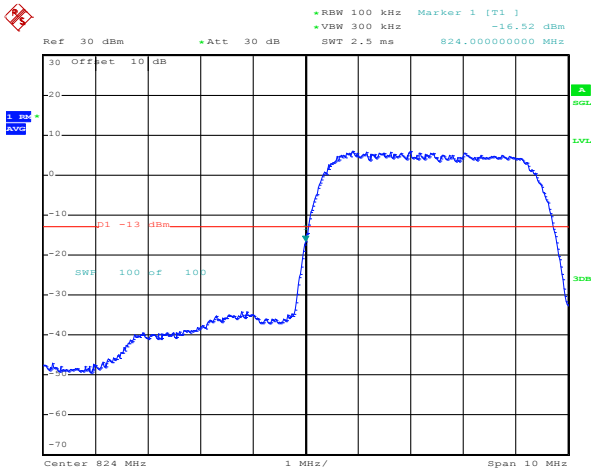

Date: 11.APR.2017 19:00:28

Lowest channel

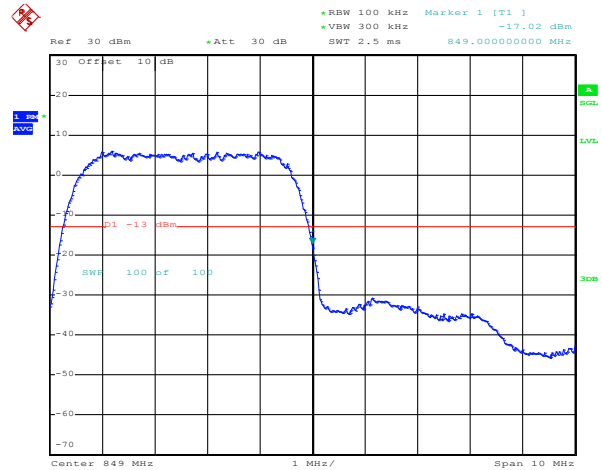

Date: 11.APR.2017 19:00:08

Highest channel

## WCDMA Band II RMC 12.2kbps

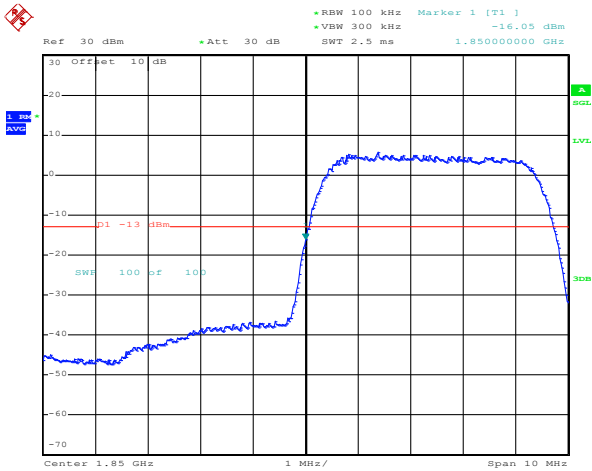

Date: 11.APR.2017 19:08:54

Lowest channel

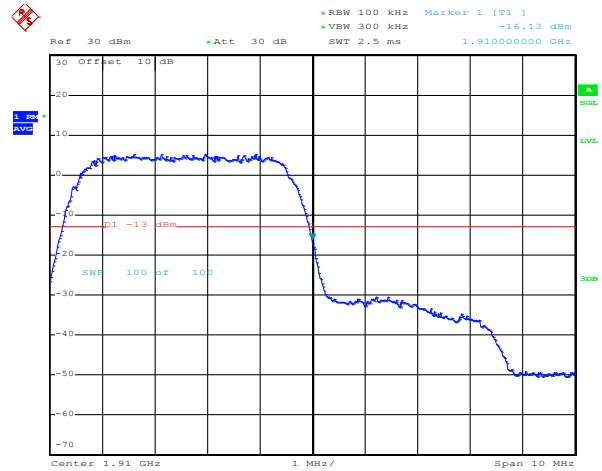

Date: 11.APR.2017 19:08:33

Highest channel

## 6.10 ERP, EIRP Measurement

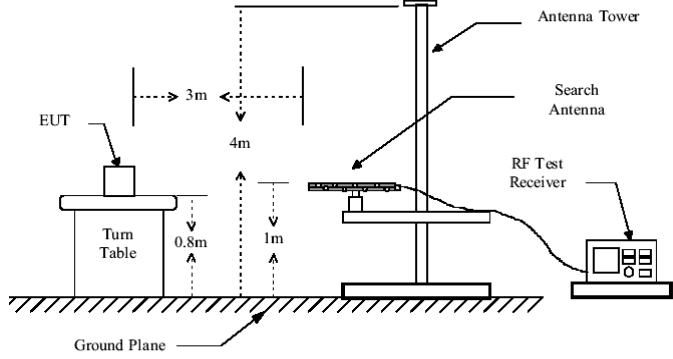
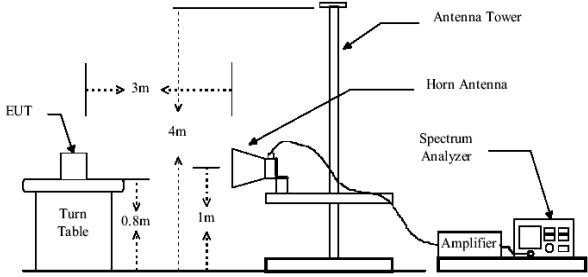
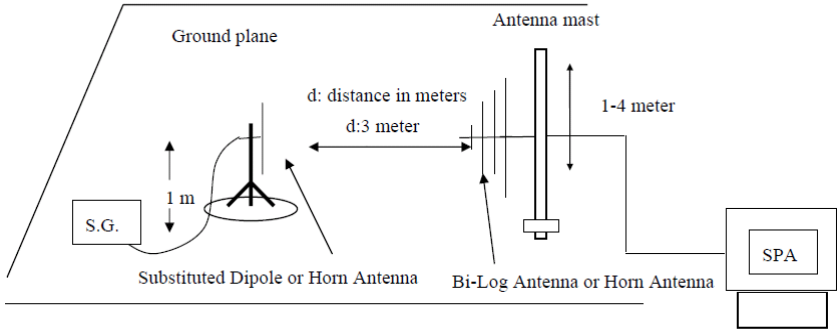
Test Requirement:	FCC part 22.913(a)(2), FCC part 24.232(c)
Test Method:	FCC part 2.1046
Limit:	GSM850 7W: ERP PCS1900 2W: EIRP WCDMA Band V: 7W ERP WCDMA Band II: 2W EIRP
Test setup:	<p>Below 1GHz</p>  <p>Above 1GHz</p>  <p>Substituted method:</p> 

<p>Test Procedure:</p>	<ol style="list-style-type: none"> <li>1. The EUT was placed on an non-conductive turntable using a non-conductive support. The radiated emission at the fundamental frequency was measured at 3 m with a test antenna and EMI spectrum analyzer.</li> <li>2. During the measurement, the EUT was communication with the station. The highest emission was recorded with the rotation of the turntable and the lowering of the test antenna from 4m to 1m. The reading was recorded and the field strength (E in dBuV/m) was calculated.</li> <li>3. ERP in frequency band 824.2 –848.80.8MHz were measured using a substitution method. The EUT was replaced by dipole antenna connected, the S.G. output was recorded and ERP was calculated as follows:  <math display="block">\text{ERP} = \text{S.G. output (dBm)} + \text{Antenna Gain (dBd)} - \text{Cable Loss (dB)}</math> </li> <li>4. EIRP in frequency band 1850.2 –1909.8MHz were measured using a substitution method. The EUT was replaced by or horn antenna connected, the S.G. output was recorded and EIRP was calculated as follows:  <math display="block">\text{EIRP} = \text{S.G. output (dBm)} + \text{Antenna Gain (dBi)} - \text{Cable Loss (dB)}</math> </li> <li>5. The worse case was relating to the conducted output power.</li> </ol>
<p>Test Instruments:</p>	<p>Refer to section 5.8 for details</p>
<p>Test mode:</p>	<p>Refer to section 5.3 for details</p>
<p>Test results:</p>	<p>Passed (All three channels were tested, and just the worst case data were shown in the report.)</p>

**Measurement Data (worst case):**

EUT mode	Channel	EUT Pol.	Antenna Pol.	ERP(dBm)	Limit (dBm)	Result
GSM850	190	H	V	31.44	38.45	Pass
			H	19.81		
EGPRS 850	128	H	V	27.21		
			H	17.88		
UMTS 850 12.2k RMC	4132	H	V	23.53		
			H	13.00		

EUT mode	Channel	EUT Pol.	Antenna Pol.	EIRP(dBm)	Limit (dBm)	Result
PCS1900	512	H	V	24.91	33	Pass
			H	17.96		
EGPRS 1900	810	H	V	23.26		
			H	15.10		
UMTS 1900 12.2k RMC	9262	H	V	20.21		
			H	13.63		

## 6.11 Field strength of spurious radiation measurement

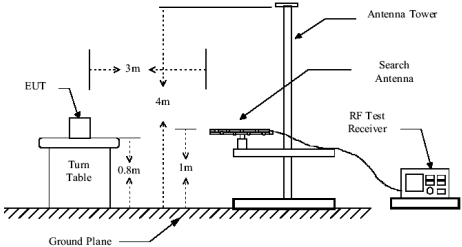
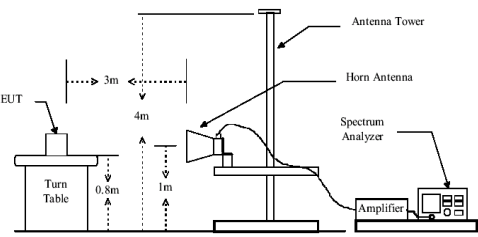
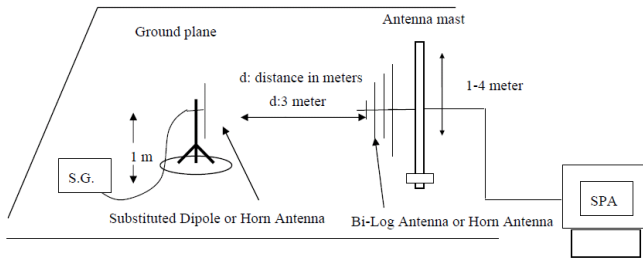
Test Requirement:	FCC part 22.917(a), FCC part 24.238(a)
Test Method:	FCC part 2.1053
Limit:	-13dBm
Test setup:	<p>Below 1GHz:</p>  <p>Above 1GHz:</p>  <p>Substituted method:</p> 
Test Procedure:	<ol style="list-style-type: none"> <li>1. The EUT was placed on an non-conductive turntable using a non-conductive support. The radiated emission at the fundamental frequency was measured at 3 m with a test antenna and EMI spectrum analyzer.</li> <li>2. During the tests, the antenna height and the EUT azimuth were varied in order to identify the maximum level of emissions from the EUT. This maximization process was repeated with the EUT positioned in each of its three orthogonal orientations.</li> <li>3. The frequency range up to tenth harmonic was investigated for each of three fundamental frequency (low, middle and high channels). Once spurious emission was identified, the power of the emission was determined using the substitution method.</li> <li>4. The spurious emissions attenuation was calculated as the difference between radiated power at the fundamental frequency and the spurious emissions frequency.  <math display="block">ERP / EIRP = S.G. \text{ output (dBm) } + \text{Antenna Gain(dB/dBi)} - \text{Cable Loss (dB)}</math> </li> </ol>
Test Instruments:	Refer to section 5.8 for details
Test mode:	Refer to section 5.3 for details.
Test results:	Passed

**Measurement Data (worst case):**

Test mode:	GSM850		Test channel:	Lowest
Frequency (MHz)	Spurious Emission		Limit (dBm)	Result
	Polarization	Level (dBm)		
1648.40	Vertical	-32.99	-13.00	Pass
2472.60	V	-36.03		
3296.80	V	-34.97		
4121.00	V	-49.27		
1648.40	Horizontal	-29.75	-13.00	Pass
2472.60	H	-35.74		
3296.80	H	-42.05		
4121.00	H	-49.13		
Test mode:	GSM850		Test channel:	Middle
Frequency (MHz)	Spurious Emission		Limit (dBm)	Result
	Polarization	Level (dBm)		
1673.20	Vertical	-29.18	-13.00	Pass
2509.80	V	-33.62		
3346.40	V	-34.45		
4183.00	V	-46.17		
1673.20	Horizontal	-26.46	-13.00	Pass
2509.80	H	-34.12		
3346.40	H	-36.86		
4183.00	H	-45.64		
Test mode:	GSM850		Test channel:	Highest
Frequency (MHz)	Spurious Emission		Limit (dBm)	Result
	Polarization	Level (dBm)		
1697.60	Vertical	-24.11	-13.00	Pass
2546.40	V	-31.39		
3395.20	V	-35.19		
4244.00	V	-40.03		
1697.60	Horizontal	-24.10	-13.00	Pass
2546.40	H	-31.32		
3395.20	H	-34.89		
4244.00	H	-41.70		

**Remark:**

1. The emission levels of below 1 GHz are very lower than the limit and not show in test report.

Test mode:	PCS1900		Test channel:	Lowest
Frequency (MHz)	Spurious Emission		Limit (dBm)	Result
	Polarization	Level (dBm)		
3700.40	Vertical	-42.63	-13.00	Pass
5550.60	V	-46.81		
3700.40	Horizontal	-44.54	-13.00	Pass
5550.60	H	-46.04		
Test mode:	PCS1900		Test channel:	Middle
Frequency (MHz)	Spurious Emission		Limit (dBm)	Result
	Polarization	Level (dBm)		
3760.00	Vertical	-41.40	-13.00	Pass
5640.00	V	-46.73		
3760.00	Horizontal	-46.09	-13.00	Pass
5640.00	H	-46.42		
Test mode:	PCS1900		Test channel:	Highest
Frequency (MHz)	Spurious Emission		Limit (dBm)	Result
	Polarization	Level (dBm)		
3819.60	Vertical	-40.41	-13.00	Pass
5729.40	V	-46.22		
3819.60	Horizontal	-45.72	-13.00	Pass
5729.40	H	-46.99		

**Remark:**

1. The emission levels of below 1 GHz are very lower than the limit and not show in test report.

Test mode:		WCDMA BAND V 12.2k RMC		Test channel:	Lowest
Frequency (MHz)	Spurious Emission		Limit (dBm)	Result	
	Polarization	Level (dBm)			
1652.80	Vertical	-47.85	-13.00	Pass	
2479.20	V	-56.85			
3305.60	V	-49.69			
1652.80	Horizontal	-51.66	-13.00	Pass	
2479.20	H	-57.10			
3305.60	H	-51.18			
Test mode:		WCDMA BAND V 12.2k RMC		Test channel:	Middle
Frequency (MHz)	Spurious Emission		Limit (dBm)	Result	
	Polarization	Level (dBm)			
1673.20	Vertical	-46.12	-13.00	Pass	
2509.80	V	-55.46			
3346.40	V	-48.72			
1673.20	Horizontal	-52.22	-13.00	Pass	
2509.80	H	-56.38			
3346.40	H	-52.08			
Test mode:		WCDMA BAND V 12.2k RMC		Test channel:	Highest
Frequency (MHz)	Spurious Emission		Limit (dBm)	Result	
	Polarization	Level (dBm)			
1693.20	Vertical	-46.68	-13.00	Pass	
2539.80	V	-52.06			
3386.40	V	-48.48			
1693.20	Horizontal	-52.63	-13.00	Pass	
2539.80	H	-53.75			
3386.40	H	-52.04			

**Remark:**

1. The emission levels of below 1 GHz are very lower than the limit and not show in test report.



Test mode:	WCDMA Band II 12.2k RMC		Test channel:	Lowest
Frequency (MHz)	Spurious Emission		Limit (dBm)	Result
	Polarization	Level (dBm)		
3704.80	Vertical	-42.95	-13.00	Pass
5557.20	V	-45.97		
3704.80	Horizontal	-47.45		
5557.20	H	-46.44		
Test mode:	WCDMA Band II 12.2k RMC		Test channel:	Middle
Frequency (MHz)	Spurious Emission		Limit (dBm)	Result
	Polarization	Level (dBm)		
3760.00	Vertical	-34.32	-13.00	Pass
5640.00	V	-45.94		
3760.00	Horizontal	-46.04		
5640.00	H	-46.22		
Test mode:	WCDMA Band II 12.2k RMC		Test channel:	Highest
Frequency (MHz)	Spurious Emission		Limit (dBm)	Result
	Polarization	Level (dBm)		
3815.20	Vertical	-35.14	-13.00	Pass
5722.80	V	-46.10		
3815.20	Horizontal	-38.44		
5722.80	H	-46.01		

**Remark:**

1. The emission levels of below 1 GHz are very lower than the limit and not show in test report.

## 6.12 Frequency stability V.S. Temperature measurement

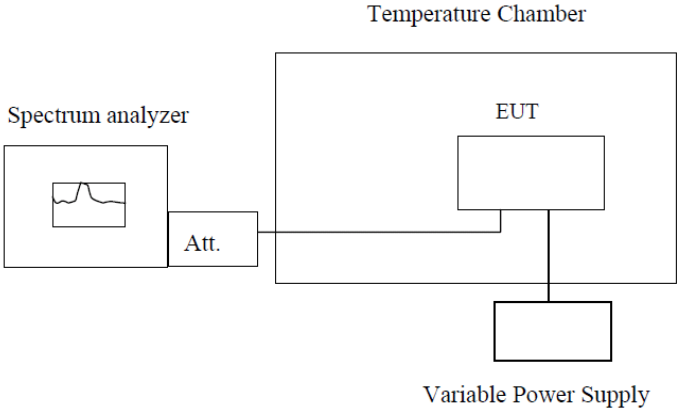
Test Requirement:	FCC Part 22.355, FCC Part 24.235, FCC Part 2.1055(a)(1)(b)
Test Method:	FCC Part 2.1055(a)(1)(b)
Limit:	±2.5 ppm
Test setup:	 <p style="text-align: center;"><b>Note :</b> Measurement setup for testing on Antenna connector</p>
Test procedure:	<ol style="list-style-type: none"> <li>1. The equipment under test was connected to an external DC power supply and input rated voltage.</li> <li>2. RF output was connected to a frequency counter or spectrum analyzer via feed through attenuators.</li> <li>3. The EUT was placed inside the temperature chamber.</li> <li>4. Set the spectrum analyzer RBW low enough to obtain the desired frequency resolution and measure EUT 25°C operating frequency as reference frequency.</li> <li>5. Turn EUT off and set the chamber temperature to -30°C. After the temperature stabilized for approximately 30 minutes recorded the frequency.</li> <li>6. Repeat step measure with 10°C increased per stage until the highest temperature of +50°C reached</li> </ol>
Test Instruments:	Refer to section 5.8 for details
Test mode:	Refer to section 5.3 for details
Test results:	Passed
Remark:	All three channels of all modulations have been tested, but only the worst channel and the worst modulation show in this test item.

**Measurement Data (the worst channel):**

Reference Frequency: GSM850 Middle channel=190 channel=836.6MHz					
Power supplied (Vdc)	Temperature (°C)	Frequency error		Limit (ppm)	Result
		Hz	ppm		
3.80	-30	199	0.237868	±2.5	Pass
	-20	180	0.215157		
	-10	165	0.197227		
	0	171	0.204399		
	10	131	0.156586		
	20	135	0.161367		
	30	124	0.148219		
	40	188	0.224719		
	50	144	0.172125		
Reference Frequency: PCS1900 Middle channel=661 channel=1880MHz					
Power supplied (Vdc)	Temperature (°C)	Frequency error		Limit (ppm)	Result
		Hz	ppm		
3.80	-30	188	0.100000	±2.5	Pass
	-20	171	0.090957		
	-10	160	0.085106		
	0	166	0.088298		
	10	132	0.070213		
	20	135	0.071809		
	30	144	0.076596		
	40	148	0.078723		
	50	107	0.056915		

Reference Frequency: EGPRS850 Middle channel=190 channel=836.6MHz					
Power supplied (Vdc)	Temperature (°C)	Frequency error		Limit (ppm)	Result
		Hz	ppm		
3.80	-30	199	0.237868	±2.5	Pass
	-20	181	0.216352		
	-10	171	0.204399		
	0	145	0.173321		
	10	165	0.197227		
	20	132	0.157781		
	30	133	0.158977		
	40	104	0.124313		
	50	127	0.151805		
Reference Frequency: EGPRS 1900 Middle channel=661 channel=1880MHz					
Power supplied (Vdc)	Temperature (°C)	Frequency error		Limit (ppm)	Result
		Hz	ppm		
3.80	-30	196	0.104255	±2.5	Pass
	-20	123	0.065426		
	-10	132	0.070213		
	0	136	0.072340		
	10	165	0.087766		
	20	145	0.077128		
	30	171	0.090957		
	40	180	0.095745		
	50	100	0.053191		

Reference Frequency: WCDMA BAND V 12.2k RMC Middle channel=4183 channel=836.6MHz					
Power supplied (Vdc)	Temperature (°C)	Frequency error		Limit (ppm)	Result
		Hz	ppm		
3.80	-30	188	0.224719	±2.5	Pass
	-20	175	0.209180		
	-10	176	0.210375		
	0	123	0.147024		
	10	132	0.157781		
	20	165	0.197227		
	30	160	0.191250		
	40	144	0.172125		
	50	148	0.176907		
Reference Frequency: WCDMA BAND II 12.2k RMC Middle channel=9400 channel=1880MHz					
Power supplied (Vdc)	Temperature (°C)	Frequency error		Limit (ppm)	Result
		Hz	ppm		
3.80	-30	180	0.095745	±2.5	Pass
	-20	171	0.090957		
	-10	151	0.080319		
	0	160	0.085106		
	10	132	0.070213		
	20	144	0.076596		
	30	105	0.055851		
	40	118	0.062766		
	50	109	0.057979		

## 6.13 Frequency stability V.S. Voltage measurement

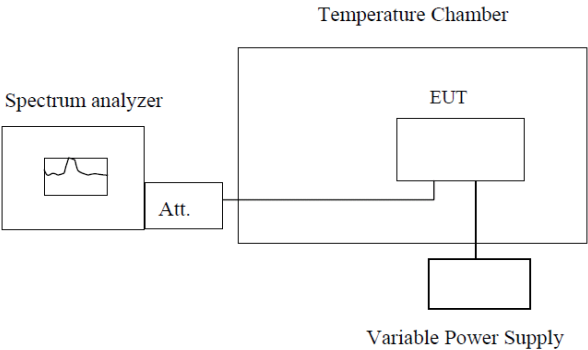
Test Requirement:	FCC Part 22.355, FCC Part 24.235, FCC Part 2.1055(d)(2)
Test Method:	FCC Part 2.1055(d)(1)(2)
Limit:	±2.5ppm
Test setup:	 <p style="text-align: center;">Temperature Chamber</p> <p style="text-align: center;">Spectrum analyzer</p> <p style="text-align: center;">Att.</p> <p style="text-align: center;">EUT</p> <p style="text-align: center;">Variable Power Supply</p> <p><b>Note :</b> Measurement setup for testing on Antenna connector</p>
Test procedure:	<ol style="list-style-type: none"> <li>1. Set chamber temperature to 25°C. Use a variable DC power source to power the EUT and set the voltage to rated voltage.</li> <li>2. Set the spectrum analyzer RBW low enough to obtain the desired frequency resolution and recorded the frequency.</li> <li>3. Reduce the input voltage to specify extreme voltage variation (+/- 15%) and endpoint, record the maximum frequency change.</li> </ol>
Test Instruments:	Refer to section 5.8 for details
Test mode:	Refer to section 5.3 for details, and all channels have been tested, only shows the worst channel data in this report.
Test results:	Passed

**Measurement Data (the worst channel):**

Reference Frequency: GSM850 Middle channel=190 channel=836.6MHz					
Temperature (°C)	Power supplied (Vdc)	Frequency error		Limit (ppm)	Result
		Hz	ppm		
25	4.37	96	0.114750	±2.5	Pass
	3.80	85	0.101602		
	3.23	74	0.088453		
Reference Frequency: PCS1900 Middle channel=661 channel=1880MHz					
Temperature (°C)	Power supplied (Vdc)	Frequency error		Limit (ppm)	Result
		Hz	ppm		
25	4.37	85	0.045213	±2.5	Pass
	3.80	45	0.023936		
	3.23	39	0.020745		
Reference Frequency: EGPRS 850 Middle channel= 190 channel=836.6MHz					
Temperature (°C)	Power supplied (Vdc)	Frequency error		Limit (ppm)	Result
		Hz	ppm		
25	4.37	74	0.088453	±2.5	Pass
	3.80	48	0.057375		
	3.23	45	0.053789		
Reference Frequency: EGPRS 1900 Middle channel= 661 channel=1880MHz					
Temperature (°C)	Power supplied (Vdc)	Frequency error		Limit (ppm)	Result
		Hz	ppm		
25	4.37	66	0.035106	±2.5	Pass
	3.80	38	0.020213		
	3.23	59	0.031383		
Reference Frequency: UMTS 850 12.2k RMC Middle channel=4183 channel=836.6MHz					
Temperature (°C)	Power supplied (Vdc)	Frequency error		Limit (ppm)	Result
		Hz	ppm		
25	4.37	74	0.088453	±2.5	Pass
	3.80	79	0.094430		
	3.23	88	0.105188		
Reference Frequency: UMTS 1900 12.2k RMC Middle channel=9400 channel=1880MHz					
Temperature (°C)	Power supplied (Vdc)	Frequency error		Limit (ppm)	Result
		Hz	ppm		
25	4.37	74	0.039362	±2.5	Pass
	3.80	87	0.046277		
	3.23	55	0.029255		