

SAR EVALUATION REPORT

For

SWAGTEK

8800NW 23rd Street, Miami, FL33172, USA

FCC ID: O55463141

Report Type: Original Report	Product Type: Mobile Phone
Test Engineer: Wilson Chen	<i>Wilson Chen</i>
Report Number: RSZ140603006-20	
Report Date: 2014-06-25	
Reviewed By: SAR Engineer	<i>Bell Hu</i>
Prepared By: Bay Area Compliance Laboratories Corp. (Shenzhen) 6/F, the 3rd Phase of WanLi Industrial Building, ShiHua Road, FuTian Free Trade Zone Shenzhen, Guangdong, China Tel: +86-755-33320018 Fax: +86-755-33320008 www.baclcorp.com.cn	

Attestation of Test Results		
EUT Information	Company Name	SWAGTEK
	EUT Description	Mobile Phone
	FCC ID	O55463141
	Model Number	X3, 47
	Test Date	2014-06-21 to 2014-06-22
Frequency	Max. SAR Level(s) Reported	Limit(W/Kg)
GSM 850	0.186 W/kg 1g Head SAR 0.140 W/kg 1g Body SAR	1.6
PCS 1900	0.223 W/kg 1g Head SAR 0.295 W/kg 1g Body SAR	
WCDMA850	0.168 W/kg 1g Head SAR 0.185 W/kg 1g Body SAR	
WCDMA1900	0.339 W/kg 1g Head SAR 0.575 W/kg 1g Body SAR	
Simultaneous	0.710 W/kg 1g Head SAR 0.761 W/kg 1g Body SAR	
Applicable Standards	ANSI / IEEE C95.1 : 2005 IEEE Standard for Safety Levels with Respect to Human Exposure to Radio Frequency Electromagnetic Fields,3 kHz to 300 GHz.	
	ANSI / IEEE C95.3 : 2002 IEEE Recommended Practice for Measurements and Computations of Radio Frequency Electromagnetic Fields With Respect to Human Exposure to Such Fields,100 kHz—300 GHz.	
	IEEE1528:2003 IEEE Recommended Practice for Determining the Peak Spatial-Average Specific Absorption Rate (SAR) in the Human Head from Wireless Communications Devices: Measurement Techniques	
	KDB procedures KDB 447498 D01 Mobile and Portable Devices RF Exposure Procedures and Equipment Authorization Policies. KDB 648474 D04 SAR Evaluation Considerations for Wireless Handsets KDB 865664 D01 SAR Measurement Requirements for 100 MHz to 6 GHz KDB 941225 D01 SAR Measurement Procedures for 3G Devices-CDMA 2000/EV-Do WCDMA/HSDPA/HSUPA KDB 941225 D06 SAR Evaluation Procedures for Portable Devices with Wireless Router Capabilities.	
<p>Note: This wireless device has been shown to be capable of compliance for localized specific absorption rate (SAR) for General Population/Uncontrolled Exposure limits specified in ANSI/IEEE Standards and has been tested in accordance with the measurement procedures specified in IEEE 1528-2003 and RF exposure KDB procedures.</p> <p>The results and statements contained in this report pertain only to the device(s) evaluated.</p>		

TABLE OF CONTENTS

DOCUMENT REVISION HISTORY	5
EUT DESCRIPTION	6
TECHNICAL SPECIFICATION	6
REFERENCE, STANDARDS, AND GUIDELINES	7
SAR LIMITS	8
FACILITIES.....	9
DESCRIPTION OF TEST SYSTEM	10
EQUIPMENT LIST AND CALIBRATION	17
EQUIPMENTS LIST & CALIBRATION INFORMATION	17
SAR MEASUREMENT SYSTEM VERIFICATION	18
LIQUID VERIFICATION	18
SYSTEM ACCURACY VERIFICATION	21
SAR SYSTEM VALIDATION DATA	22
EUT TEST STRATEGY AND METHODOLOGY	30
TEST POSITIONS FOR DEVICE OPERATING NEXT TO A PERSON’S EAR.....	30
CHEEK/TOUCH POSITION	31
EAR/TILT POSITION	31
TEST POSITIONS FOR BODY-WORN AND OTHER CONFIGURATIONS	32
SAR EVALUATION PROCEDURE.....	33
CONDUCTED OUTPUT POWER MEASUREMENT	34
PROVISION APPLICABLE	34
TEST PROCEDURE	34
MAXIMUM OUTPUT POWER AMONG PRODUCTION UNITS	34
TEST RESULTS:	35
SAR MEASUREMENT RESULTS	41
SAR TEST DATA.....	41
SAR SIMULTANEOUS TRANSMISSION DESCRIPTION	48
EUT SCAN RESULTS	53
APPENDIX A MEASUREMENT UNCERTAINTY	97
APPENDIX B – PROBE CALIBRATION CERTIFICATES.....	98
APPENDIX C DIPOLE CALIBRATION CERTIFICATES.....	108
APPENDIX D EUT TEST POSITION PHOTOS	128
LIQUID DEPTH □ 15CM.....	128
BODY-WORN FRONT SETUP PHOTO (10MM)	128
BODY-WORN BACK SETUP PHOTO (10MM)	129
BODY-WORN LEFT SETUP PHOTO (10MM)	129
BODY-WORN RIGHT SETUP PHOTO (10MM)	130
BODY-WORN BOTTOM SETUP PHOTO (10MM)	130
LEFT HEAD TOUCH SETUP PHOTO	131
LEFT HEAD TILT SETUP PHOTO	131
RIGHT HEAD TOUCH SETUP PHOTO	132
RIGHT HEAD TILT SETUP PHOTO	132
APPENDIX E EUT PHOTOS.....	133
EUT – FRONT VIEW.....	133
EUT – BACK VIEW	133

EUT –RIGHT SIDE VIEW 134
EUT – LEFT SIDE VIEW 134
EUT – TOP VIEW 135
EUT – BOTTOM VIEW..... 135
APPENDIX F – DECLARATION LETTERS..... 136
APPENDIX G INFORMATIVE REFERENCES 137

DOCUMENT REVISION HISTORY

Revision Number	Report Number	Description of Revision	Date of Revision
0	RSZ140603006-20	Original Report	2014-06-25

EUT DESCRIPTION

This report has been prepared on behalf of SWAGTEK and their product, FCC ID: O55463141 , Model: X3, 47 or the EUT (Equipment under Test) as referred to in the rest of this report. The EUT is a mobile phone.

**Note: This series products model: X3 and 47, we select model: X3 to test, there is no electrical change has been made to the equipment, please refer to the product similarity letter.*

Technical Specification

Product Type	Portable
Exposure Category:	Population / Uncontrolled
Antenna Type(s):	Internal Antenna
Body-Worn Accessories:	Headset
Face-Head Accessories:	None
Multi-slot Class:	Class12
Operation Mode :	GSM Voice, GPRS Data, WCDMA, WiFi and Bluetooth
Frequency Band:	GSM 850 : 824-849 MHz(TX) ; 869-894 MHz(RX) PCS 1900: 1850-1910 MHz(TX) ; 1930-1990 MHz(RX) WCDMA850: 824-849 MHz(TX) ; 869-894 MHz(RX) WCDMA1900: 1850-1910 MHz(TX) ; 1930-1990 MHz(RX) WiFi: 2412MHz-2462MHz Bluetooth : 2402MHz-2480MHz
Conducted RF Power:	GSM 850 : 31.75 dBm PCS 1900: 28.33 dBm WCDMA 850: 22.67 dBm WCDMA 1900: 22.17 dBm WiFi: 9.48 dBm Bluetooth: 9.00dBm
Dimensions (L*W*H):	137.8 mm (L) × 67.7 mm (W) × 7.8 mm (H)
Power Source:	3.7 V _{DC} Rechargeable Battery
Normal Operation:	Head and Body-worn

REFERENCE, STANDARDS, AND GUIDELINES

FCC:

The Report and Order requires routine SAR evaluation prior to equipment authorization of portable transmitter devices, including portable telephones. For consumer products, the applicable limit is 1.6 mW/g as recommended by the ANSI/IEEE standard C95.1-1992 [6] for an uncontrolled environment (Paragraph 65). According to the Supplement C of OET Bulletin 65 "Evaluating Compliance with FCC Guide-lines for Human Exposure to Radio frequency Electromagnetic Fields", released on Jun 29, 2001 by the FCC, the device should be evaluated at maximum output power (radiated from the antenna) under "worst-case" conditions for normal or intended use, incorporating normal antenna operating positions, device peak performance frequencies and positions for maximum RF energy coupling.

This report describes the methodology and results of experiments performed on wireless data terminal. The objective was to determine if there is RF radiation and if radiation is found, what is the extent of radiation with respect to safety limits. SAR (Specific Absorption Rate) is the measure of RF exposure determined by the amount of RF energy absorbed by human body (or its parts) – to determine how the RF energy couples to the body or head which is a primary health concern for body worn devices. The limit below which the exposure to RF is considered safe by regulatory bodies in North America is 1.6 mW/g average over 1 gram of tissue mass.

CE:

The order requires routine SAR evaluation prior to equipment authorization of portable transmitter devices, including portable telephones. For consumer products, the applicable limit is 2 mW/g as recommended by EN62209-1 for an uncontrolled environment. According to the Standard, the device should be evaluated at maximum output power (radiated from the antenna) under "worst-case" conditions for normal or intended use, incorporating normal antenna operating positions, device peak performance frequencies and positions for maximum RF energy coupling.

This report describes the methodology and results of experiments performed on wireless data terminal. The objective was to determine if there is RF radiation and if radiation is found, what is the extent of radiation with respect to safety limits. SAR (Specific Absorption Rate) is the measure of RF exposure determined by the amount of RF energy absorbed by human body (or its parts) – to determine how the RF energy couples to the body or head which is a primary health concern for body worn devices. The limit below which the exposure to RF is considered safe by regulatory bodies in Europe is 2 mW/g average over 10 gram of tissue mass.

The test configurations were laid out on a specially designed test fixture to ensure the reproducibility of measurements. Each configuration was scanned for SAR. Analysis of each scan was carried out to characterize the above effects in the device.

SAR Limits

FCC Limit (1g Tissue)

EXPOSURE LIMITS	SAR (W/kg)	
	(General Population / Uncontrolled Exposure Environment)	(Occupational / Controlled Exposure Environment)
Spatial Average (averaged over the whole body)	0.08	0.4
Spatial Peak (averaged over any 1 g of tissue)	1.60	8.0
Spatial Peak (hands/wrists/feet/ankles averaged over 10 g)	4.0	20.0

CE Limit (10g Tissue)

EXPOSURE LIMITS	SAR (W/kg)	
	(General Population / Uncontrolled Exposure Environment)	(Occupational / Controlled Exposure Environment)
Spatial Average (averaged over the whole body)	0.08	0.4
Spatial Peak (averaged over any 10 g of tissue)	2.0	10
Spatial Peak (hands/wrists/feet/ankles averaged over 10 g)	4.0	20.0

Population/Uncontrolled Environments are defined as locations where there is the exposure of individual who have no knowledge or control of their exposure.

Occupational/Controlled Environments are defined as locations where there is exposure that may be incurred by people who are aware of the potential for exposure (i.e. as a result of employment or occupation).

General Population/Uncontrolled environments Spatial Peak limit 1.6W/kg (FCC) & 2 W/kg (CE) applied to the EUT.

FACILITIES

The test site used by Bay Area Compliance Laboratories Corp. (Shenzhen) to collect data is located at 6/F, the 3rd Phase of WanLi Industrial Building, Shi Hua Road, Fu Tian Free Trade Zone, Shenzhen, Guangdong, P.R. of China

DESCRIPTION OF TEST SYSTEM

These measurements were performed with ALSAS 10 Universal Integrated SAR Measurement system from APREL Laboratories.

ALSAS-10U System Description

ALSAS-10-U is fully compliant with the technical and scientific requirements of IEEE 1528, IEC 62209, CENELEC, ARIB, ACA, and the Federal Communications Commission. The system comprises of a six axes articulated robot which utilizes a dedicated controller.

ALSAS-10U uses the latest methodologies. And FDTD modeling to provide a platform which is repeatable with minimum uncertainty.

Applications

Predefined measurement procedures compliant with the guidelines of CENELEC, IEEE, IEC, FCC, etc are utilized during the assessment for the device. Automatic detection for all SAR maxima are embedded within the core architecture for the system, ensuring that peak locations used for centering the zoom scan are within a 1mm resolution and a 0.05mm repeatable position. System operation range currently available up-to 6 GHz in simulated tissue.

Area Scans

Area scans are defined prior to the measurement process being executed with a user defined variable spacing between each measurement point (integral) allowing low uncertainty measurements to be conducted. Scans defined for FCC applications utilize a 10mm² step integral, with 1mm interpolation used to locate the peak SAR area used for zoom scan assessments.

Where the system identifies multiple SAR peaks (which are within 25% of peak value) the system will provide the user with the option of assessing each peak location individually for zoom scan averaging.

Zoom Scan (Cube Scan Averaging)

The averaging zoom scan volume utilized in the ALSAS-10U software is in the shape of a cube and the side dimension of a 1 g or 10 g mass is dependent on the density of the liquid representing the simulated tissue. A density of 1000 kg/m³ is used to represent the head and body tissue density and not the phantom liquid density, in order to be consistent with the definition of the liquid dielectric properties, i.e. the side length of the 1 g cube is 10mm, with the side length of the 10 g cube 21,5mm.

When the cube intersects with the surface of the phantom, it is oriented so that 3 vertices touch the surface of the shell or the center of a face is tangent to the surface. The face of the cube closest to the surface is modified in order to conform to the tangent surface.

The zoom scan integer steps can be user defined so as to reduce uncertainty, but normal practice for typical test applications (including FCC) utilize a physical step of 5x5x8 (8mmx8mmx5mm) providing a volume of 32mm³ in the X & Y axis, and 35mm in the Z axis.



ALSAS-10U Interpolation and Extrapolation Uncertainty

The overall uncertainty for the methodology and algorithms the used during the SAR calculation was evaluated using the data from IEEE 1528 based on the example f3 algorithm:

$$f_3(x, y, z) = A \frac{a^2}{\frac{a^2}{4} + x'^2 + y'^2} \cdot \left(e^{-\frac{2z}{a}} + \frac{a^2}{2(a + 2z)^2} \right)$$

Isotropic E-Field Probe

The isotropic E-Field probe has been fully calibrated and assessed for isotropicity, and boundary effect within a controlled environment. Depending on the frequency for which the probe is calibrated the method utilized for calibration will change.

The E-Field probe utilizes a triangular sensor arrangement as detailed in the diagram below:

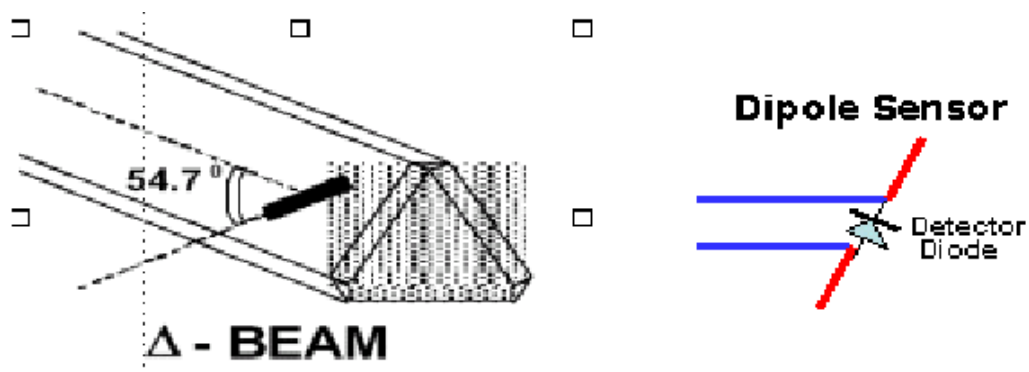

SAR is assessed with a calibrated probe which moves at a default height of 5mm from the center of the diode, which is mounted to the sensor, to the phantom surface (in the Z Axis). The 5mm offset height has been selected so as to minimize any resultant boundary effect due to the probe being in close proximity to the phantom surface.

The following algorithm is an example of the function used by the system for linearization of the output from the probe when measuring complex modulation schemes.

$$V_i = U_i + U_i^2 \cdot \frac{cf}{dcp_i}$$

Isotropic E-Field Probe Specification

Calibration Method	Frequency Dependent Below 1 GHz Calibration in air performed in a TEM Cell Above 1 GHz Calibration in air performed in waveguide
Sensitivity	0.70 $\mu\text{V}/(\text{V}/\text{m})^2$ to 0.85 $\mu\text{V}/(\text{V}/\text{m})^2$
Dynamic Range	0.0005 W/kg to 100 W/kg
Isotropic Response	Better than 0.1 dB
Diode Compression Point (DCP)	Calibration for Specific Frequency
Probe Tip Diameter	< 2.9 mm
Sensor Offset	1.56 (+/- 0.02 mm)
Probe Length	289 mm
Video Bandwidth	@ 500 Hz: 1 dB @ 1.02 kHz: 3 dB
Boundary Effect	Less than 2.1% for distance greater than 0.58 mm
Spatial Resolution	The spatial resolution uncertainty is less than 1.5% for 4.9mm diameter probe. The spatial resolution uncertainty is less than 1.0% for 2.5mm diameter probe

Boundary Detection Unit and Probe Mounting Device

ALSAS-10U incorporates a boundary detection unit with a sensitivity of 0.05mm for detecting all types of surfaces. The robust design allows for detection during probe tilt (probe normalize) exercises, and utilizes a second stage emergency stop. The signal electronics are fed directly into the robot controller for high accuracy surface detection in lateral and axial detection modes (X, Y, & Z).

The probe is mounted directly onto the Boundary Detection unit for accurate tooling and displacement calculations controlled by the robot kinematics. The probe is connect to an isolated probe interconnect where the output stage of the probe is fed directly into the amplifier stage of the Daq-Paq.

Daq-Paq (Analog to Digital Electronics)

ALSAS-10U incorporates a fully calibrated Daq-Paq (analog to digital conversion system) which has a 4 channel input stage, sent via a 2 stage auto-set amplifier module. The input signal is amplified accordingly so as to offer a dynamic range from 5 μV to 800mV. Integration of the fields measured is carried out at board level utilizing a Co-Processor which then sends the measured fields down into the main computational module in digitized form via an RS232 communications port. Probe linearity and duty cycle compensation is carried out within the main Daq-Paq module.

ADC	12 Bit
Amplifier Range	20 mV to 200 mV and 150 mV to 800 mV
Field Integration	Local Co-Processor utilizing proprietary integration algorithms
Number of Input Channels	4 in total 3 dedicated and 1 spare
Communication	Packet data via RS232

Axis Articulated Robot

ALSAS-10U utilizes a six axis articulated robot, which is controlled using a Pentium based real-time movement controller. The movement kinematics engine utilizes proprietary (Thermo CRS) interpolation and extrapolation algorithms, which allow full freedom of movement for each of the six joints within the working envelope. Utilization of joint 6 allows for full probe rotation with a tolerance better than 0.05mm around the central axis.



Robot/Controller Manufacturer	Thermo CRS
Number of Axis	Six independently controlled axis
Positioning Repeatability	0.05 mm
Controller Type	Single phase Pentium based C500C
Robot Reach	710 mm
Communication	RS232 and LAN compatible

ALSAS Universal Workstation

ALSAS Universal workstation allows for repeatability and fast adaptability. It allows users to do calibration, testing and measurements using different types of phantoms with one set up, which significantly speeds up the measurement process.

Universal Device Positioner

The universal device positioner allows complete freedom of movement of the EUT. Developed to hold a EUT in a free-space scenario any additional loading attributable to the material used in the construction of the positioner has been eliminated. Repeatability has been enhanced through the linear scales which form the design used to indicate positioning for any given test scenario in all major axes. A 15° tilt indicator is included for the of aid cheek to tilt movements for head SAR analysis. Overall uncertainty for measurements have been reduced due to the design of the Universal device positioner, which allows positioning of a device in as near to a free-space scenario as possible, and by providing the means for complete repeatability.



Phantom Types

The ALSAS-10U allows the integration of multiple phantom types. SAM Phantoms fully compliant with IEEE 1528, Universal Phantom, and Universal Flat.

APREL SAM Phantoms

The SAM phantoms developed using the IEEE SAM CAD file. They are fully compliant with the requirements for both IEEE 1528 and FCC Supplement C. Both the left and right SAM phantoms are interchangeable, transparent and include the IEEE 1528 grid with visible NF and MB lines.

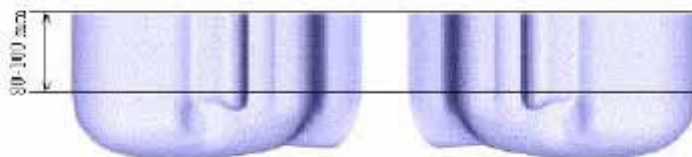

APREL Laboratories Universal Phantom

The Universal Phantom is used on the ALSAS-10U as a system validation phantom. The Universal Phantom has been fully validated both experimentally from 800MHz to 6GHz and numerically using XFDTD numerical software.

The shell thickness is 2mm overall, with a 4mm spacer located at the NF/MB intersection providing an overall thickness of 6mm in line with the requirements of IEEE-1528.

The design allows for fast and accurate measurements, of handsets, by allowing the conservative SAR to be evaluated at on frequency for both left and right head experiments in one measurement.



Tissue Dielectric Parameters for Head and Body Phantoms

The head tissue dielectric parameters recommended by the IEEE SCC-34/SC-2 in P1528 have been incorporated in the following table. These head parameters are derived from planar layer models simulating the highest expected SAR for the dielectric properties and tissue thickness variations in a human head. Other head and body tissue parameters that have not been specified in P1528 are derived from the tissue dielectric parameters computed from the 4-Cole-Cole equations described in Reference [12] and extrapolated according to the head parameters specified in P1528.

Ingredients (% by weight)	Frequency (MHz)									
	450		835		915		1900		2450	
Tissue Type	Head	Body	Head	Body	Head	Body	Head	Body	Head	Body
Water	38.56	51.16	41.45	52.4	41.05	56.0	54.9	40.4	62.7	73.2
Salt (Nacl)	3.95	1.49	1.45	1.4	1.35	0.76	0.18	0.5	0.5	0.04
Sugar	56.32	46.78	56.0	45.0	56.5	41.76	0.0	58.0	0.0	0.0
HEC	0.98	0.52	1.0	1.0	1.0	1.21	0.0	1.0	0.0	0.0
Bactericide	0.19	0.05	0.1	0.1	0.1	0.27	0.0	0.1	0.0	0.0
Triton x-100	0.0	0.0	0.0	0.0	0.0	0.0	0.0	0.0	36.8	0.0
DGBE	0.0	0.0	0.0	0.0	0.0	0.0	44.92	0.0	0.0	26.7
Dielectric Constant	43.42	58.0	42.54	56.1	42.0	56.8	39.9	54.0	39.8	52.5
Conductivity (s/m)	0.85	0.83	0.91	0.95	1.0	1.07	1.42	1.45	1.88	1.78

Recommended Tissue Dielectric Parameters for Head and Body

Frequency (MHz)	Head Tissue		Body Tissue	
	ϵ_r	σ (S/m)	ϵ_r	σ (S/m)
150	52.3	0.76	61.9	0.80
300	45.3	0.87	58.2	0.92
450	43.5	0.87	56.7	0.94
835	41.5	0.90	55.2	0.97
900	41.5	0.97	55.0	1.05
915	41.5	0.98	55.0	1.06
1450	40.5	1.20	54.0	1.30
1610	40.3	1.29	53.8	1.40
1800-2000	40.0	1.40	53.3	1.52
2450	39.2	1.80	52.7	1.95
3000	38.5	2.40	52.0	2.73
5800	35.3	5.27	48.2	6.00

EQUIPMENT LIST AND CALIBRATION

Equipments List & Calibration Information

Equipment	Model	Calibration Date	S/N
CRS F3 robot	ALS-F3	N/A	RAF0805352
CRS F3 Software	ALS-F3-SW	N/A	N/A
CRS C500C controller	ALS-C500	N/A	RCF0805379
Probe mounting device & Boundary Detection Sensor System	ALS-PMDPS-3	N/A	120-00270
Universal Work Station	ALS-UWS	N/A	100-00157
Data Acquisition Package	ALS-DAQ-PAQ-3	2013-10-08	110-00212
Miniature E-Field Probe	ALS-E-020	2013-10-08	500-00283
Dipole, 835MHz	ALS-D-835-S-2	2011-08-25	180-00558
Dipole, 1900MHz	ALS-D-1900-S-2	2011-08-25	210-00710
Dipole Spacer	ALS-DS-U	N/A	250-00907
Device holder/Positioner	ALS-H-E-SET-2	N/A	170-00510
Left ear SAM phantom	ALS-P-SAM-L	N/A	130-00311
Right ear SAM phantom	ALS-P-SAM-R	N/A	140-00359
UniPhantom	ALS-P-UP-1	N/A	150-00413
Simulated Tissue 835 MHz Head	ALS-TS-835-H	Each Time	270-01002
Simulated Tissue 835 MHz Body	ALS-TS-835-B	Each Time	270-02101
Simulated Tissue 1900 MHz Head	ALS-TS-1900-H	Each Time	295-01103
Simulated Tissue 1900 MHz Body	ALS-TS-1900-B	Each Time	295-02102
Power Amplifier	5S1G4	N/A	71377
Synthesized Sweeper	HP 8341B	2014-05-08	2624A00116
UNIVERSAL RADIO COMMUNICATION TESTER	CMU200	2013-11-23	106891
EMI Test Receiver	ESCI	2013-11-12	101120

SAR MEASUREMENT SYSTEM VERIFICATION

Liquid Verification

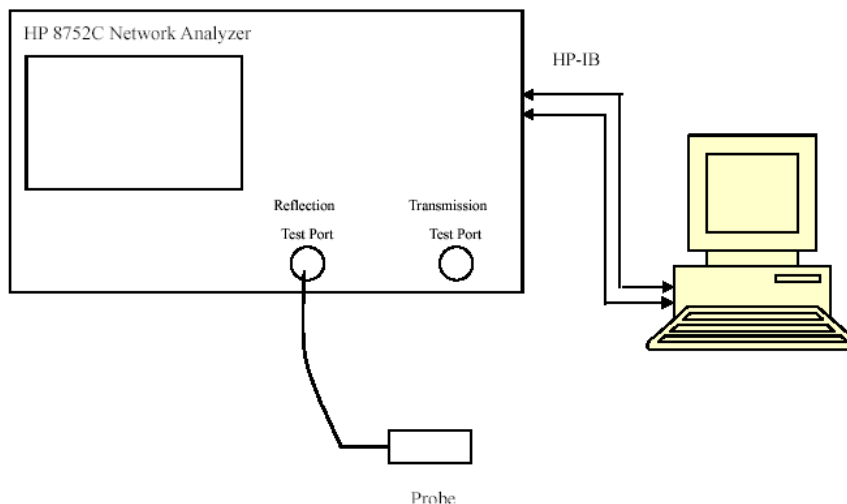

Liquid Verification Setup Block Diagram

Liquid Verification Results

Frequency	Liquid Type	Liquid Parameter		Target Value		Delta (%)		Tolerance (%)
		ϵ_r	σ (S/m)	ϵ_r	σ (S/m)	$\Delta\epsilon_r$	$\Delta\sigma$ (S/m)	
824.2	Head	41.04	0.90	41.50	0.90	-2.518	-2.062	± 5
	Body	53.81	0.95	55.20	0.97	-1.012	1.111	± 5
826.4	Head	41.08	0.91	41.50	0.90	-2.572	-2.062	± 5
	Body	53.78	0.95	55.20	0.97	-1.133	2.222	± 5
836.6	Head	41.03	0.92	41.50	0.90	-2.446	-1.031	± 5
	Body	53.85	0.96	55.20	0.97	-1.084	1.111	± 5
846.6	Head	41.05	0.91	41.50	0.90	-2.572	0.000	± 5
	Body	53.78	0.97	55.20	0.97	-1.108	1.111	± 5
848.8	Head	41.04	0.91	41.50	0.90	-2.409	1.031	± 5
	Body	53.87	0.98	55.20	0.97	-0.650	-1.429	± 5
1850.2	Head	39.74	1.38	40.00	1.40	-2.326	-1.974	± 5
	Body	52.06	1.49	53.30	1.52	-0.950	-2.143	± 5
1852.4	Head	39.62	1.37	40.00	1.40	-2.758	-1.974	± 5
	Body	51.83	1.49	53.30	1.52	-0.825	-0.714	± 5
1880.0	Head	39.67	1.39	40.00	1.40	-2.720	0.000	± 5
	Body	51.85	1.52	53.30	1.52	-1.075	1.429	± 5
1907.6	Head	39.57	1.42	40.00	1.40	-2.871	1.316	± 5
	Body	51.77	1.54	53.30	1.52	-1.050	1.429	± 5
1909.8	Head	39.58	1.42	40.00	1.40	-2.908	0.658	± 5
	Body	51.75	1.53	53.30	1.52	-2.518	-2.062	± 5

*Liquid Verification was performed on 2014-06-21.

Please refer to the following tables.

835 MHz Head				835 MHz Body		
Frequency (MHz)	e'	e''		Frequency (MHz)	e'	e''
824.0	41.0439	19.6906		824.0	53.8121	20.6974
824.5	41.0865	19.6770		824.5	53.8375	20.6162
825.0	41.0236	19.6882		825.0	53.7758	20.6915
825.5	41.0238	19.7215		825.5	53.8462	20.6311
826.0	40.9960	19.7712		826.0	53.7834	20.6952
826.5	41.0840	19.7506		826.5	53.8109	20.6884
827.0	41.0534	19.7036		827.0	53.8554	20.6147
827.5	41.0112	19.6754		827.5	53.8688	20.6933
828.0	41.0806	19.7684		828.0	53.8279	20.6621
828.5	41.0721	19.7322		828.5	53.8410	20.6250
829.0	41.0802	19.6840		829.0	53.7740	20.6330
829.5	41.0350	19.7697		829.5	53.8252	20.6900
830.0	41.0556	19.7228		830.0	53.7672	20.7017
830.5	41.0582	19.7248		830.5	53.7728	20.7059
831.0	41.0595	19.7366		831.0	53.7952	20.7062
831.5	40.9976	19.6848		831.5	53.8589	20.6654
832.0	41.0218	19.7471		832.0	53.8651	20.6900
832.5	41.0143	19.6643		832.5	53.8400	20.6207
833.0	41.0184	19.7073		833.0	53.7755	20.6913
833.5	41.0579	19.7481		833.5	53.8549	20.6636
834.0	41.0532	19.6712		834.0	53.8110	20.6908
834.5	41.0618	19.6864		834.5	53.8149	20.6529
835.0	41.0708	19.7346		835.0	53.8701	20.6150
835.5	40.9991	19.7150		835.5	53.7992	20.7003
836.0	41.0733	19.7379		836.0	53.7821	20.6706
836.5	41.0311	19.7077		836.5	53.8477	20.6466
837.0	41.0315	19.6751		837.0	53.8388	20.6797
837.5	41.0439	19.6661		837.5	53.8282	20.6591
838.0	41.0926	19.6724		838.0	53.8198	20.6951
838.5	41.0297	19.7341		838.5	53.8369	20.6636
839.0	41.0530	19.6637		839.0	53.8115	20.6303
839.5	41.0340	19.6635		839.5	53.8731	20.7030
840.0	41.0286	19.4387		840.0	53.8291	20.6952
840.5	41.0944	19.4718		840.5	53.7957	20.6706
841.0	41.0753	19.4689		841.0	53.8159	20.6342
841.5	41.0558	19.3766		841.5	53.8349	20.6993
842.0	41.0268	19.4210		842.0	53.8616	20.6200
842.5	41.0579	19.4713		842.5	53.7819	20.6683
843.0	41.0700	19.4670		843.0	53.8495	20.6634
843.5	41.0632	19.3766		843.5	53.7646	20.6709
844.0	41.0321	19.3738		844.0	53.8201	20.6621
844.5	41.0644	19.3944		844.5	53.8635	20.6979
845.0	41.1043	19.4326		845.0	53.8447	20.6256
845.5	41.0838	19.3768		845.5	53.7929	20.6302
846.0	41.0534	19.4482		846.0	53.7776	20.6631
846.5	41.0476	19.4261		846.5	53.7790	20.7101
847.0	41.0646	19.4007		847.0	53.7820	20.6974
847.5	41.0800	19.4654		847.5	53.8190	20.6784
848.0	41.1049	19.4166		848.0	53.8697	20.6966
848.5	41.0189	19.3800		848.5	53.8099	20.6750
849.0	41.0429	19.3754		849.0	53.8725	20.7037

1900 MHz Head				1900 MHz Body		
Frequency (MHz)	e'	e''		Frequency (MHz)	e'	e''
1850.0	39.7368	13.4107		1850.0	52.0578	14.5325
1851.2	39.6761	13.2954		1851.2	51.9392	14.4199
1852.4	39.6166	13.2827		1852.4	51.8314	14.4764
1853.6	39.6588	13.3924		1853.6	51.7944	14.5007
1854.8	39.6524	13.3819		1854.8	51.8118	14.5104
1856.0	39.6413	13.3934		1856.0	51.9839	14.4650
1857.2	39.7080	13.3130		1857.2	51.7975	14.5058
1858.4	39.7268	13.2950		1858.4	51.9521	14.4184
1859.6	39.5871	13.3930		1859.6	51.7721	14.4890
1860.8	39.7112	13.2396		1860.8	51.7944	14.5514
1862.0	39.6971	13.3814		1862.0	51.9880	14.5370
1863.2	39.6731	13.4007		1863.2	52.0384	14.5096
1864.4	39.5501	13.3274		1864.4	51.8922	14.4240
1865.6	39.5802	13.2502		1865.6	51.9861	14.4866
1866.8	39.6600	13.4317		1866.8	52.0518	14.4503
1868.0	39.6634	13.3906		1868.0	51.8051	14.4121
1869.2	39.7308	13.3483		1869.2	51.7348	14.4369
1870.4	39.5640	13.2846		1870.4	51.7338	14.5060
1871.6	39.5963	13.3252		1871.6	51.9515	14.5284
1872.8	39.6339	13.3738		1872.8	52.0586	14.4818
1874.0	39.7015	13.3775		1874.0	52.0708	14.4252
1875.2	39.7074	13.4252		1875.2	51.9036	14.4532
1876.4	39.5730	13.3742		1876.4	51.9862	14.5063
1877.6	39.5940	13.3150		1877.6	52.0127	14.4503
1878.8	39.5890	13.3872		1878.8	52.0296	14.4400
1880.0	39.6720	13.3334		1880.0	51.8499	14.5336
1881.2	39.7266	13.3196		1881.2	51.7692	14.5053
1882.4	39.7216	13.2761		1882.4	51.9537	14.5001
1883.6	39.6746	13.2606		1883.6	51.8537	14.4258
1884.8	39.7204	13.2547		1884.8	51.9577	14.5104
1886.0	39.5742	13.2400		1886.0	51.9611	14.4523
1887.2	39.5688	13.3921		1887.2	51.8895	14.5184
1888.4	39.7059	13.4183		1888.4	51.8618	14.5494
1889.6	39.6609	13.4056		1889.6	51.9878	14.4172
1890.8	39.7423	13.4095		1890.8	51.8247	14.4323
1892.0	39.5495	13.4202		1892.0	51.7863	14.5795
1893.2	39.6492	13.2994		1893.2	51.8202	14.5767
1894.4	39.5983	13.2683		1894.4	51.9269	14.5036
1895.6	39.7115	13.4243		1895.6	51.9287	14.5273
1896.8	39.7225	13.3036		1896.8	51.9152	14.4277
1898.0	39.5650	13.2712		1898.0	52.0364	14.5335
1899.2	39.6810	13.3430		1899.2	52.0629	14.4721
1900.4	39.6636	13.3978		1900.4	51.7888	14.5093
1901.6	39.7159	13.3185		1901.6	51.9928	14.4492
1902.8	39.6762	13.3518		1902.8	51.9989	14.5729
1904.0	39.5715	13.2577		1904.0	51.8609	14.4229
1905.2	39.5702	13.3513		1905.2	51.9885	14.4167
1906.4	39.7311	13.2918		1906.4	52.0132	14.5639
1907.6	39.5736	13.3608		1907.6	51.7681	14.4826
1908.8	39.7312	13.2645		1908.8	52.0277	14.4913
1910.0	39.5792	13.4135		1910.0	51.7500	14.5391

System Accuracy Verification

Prior to the assessment, the system validation kit was used to test whether the system was operating within its specifications of $\pm 10\%$. The validation results are tabulated below. And also the corresponding SAR plot is attached as well in the SAR plots files.

System Verification Setup Block Diagram

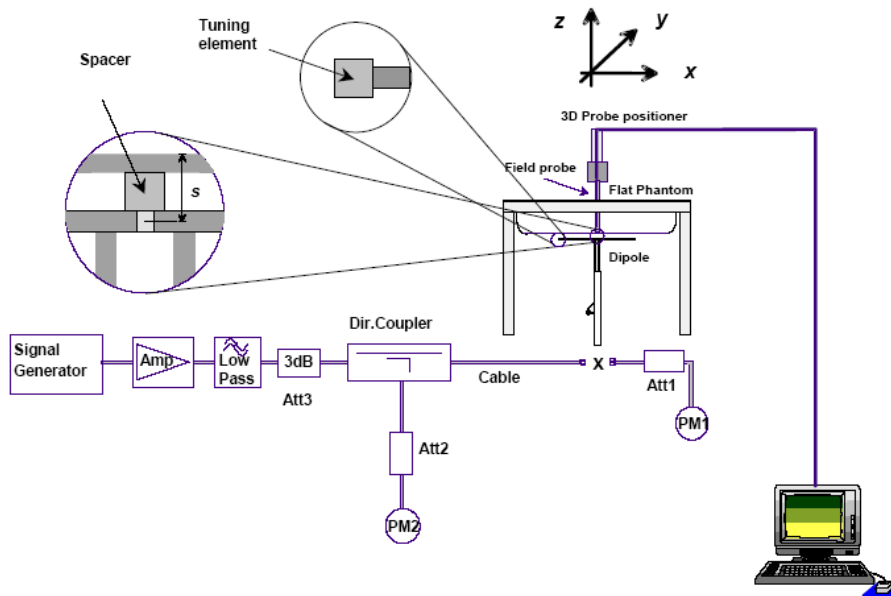

Probe and dipole antenna List and Detail

Manufacturer	Description	Model	Serial Number	Calibration Date	Calibration Due Date
APREL	Probe	ALS-E-020	500-00283	2013-10-08	2014-10-07
APREL	Dipole antenna(850MHz)	ALS-D-835-S-2	180-00558	2011-08-25	2014-08-24
APREL	Dipole antenna(1900MHz)	ALS-D-1900-S-2	210-00710	2011-08-25	2014-08-24

System Accuracy Check Results

Date	Frequency Band	Liquid Type	Measured SAR (W/Kg)		Target Value (W/Kg)	Delta (%)	Tolerance (%)
2014-06-21	835	Head	1g	9.749	9.590	1.658	± 10
		Body	1g	9.852	9.684	1.735	± 10
	1900	Head	1g	39.982	39.648	0.842	± 10
		Body	1g	40.317	39.769	1.378	± 10

*All SAR values are normalized to 1 Watt forward power.

SAR SYSTEM VALIDATION DATA**Test Laboratory: Bay Area Compliance Lab Corp. (Shenzhen)****System Performance Check 835 MHz Head Liquid****Dipole 835 MHz; Type: ALS-D-835-S-2; S/N: 180-00558**

Product Data

Device Name : Dipole 835 MHz
Serial No. : 180-00558
Type : Dipole
Model : ALS-D-835-S-2
Frequency Band : 835
Max. Transmit Pwr : 1 W
Drift Time : 3 min(s)
Power Drift-Start : 9.819 W/kg
Power Drift-Finish : 9.892 W/kg
Power Drift (%) : 0.819

Phantom Data

Name : APREL-Uni
Type : Uni-Phantom
Size (mm) : 280 x 280 x 200
Serial No. : System Default
Location : Center
Description : Default
Phantom Data

Tissue Data

Type : Head
Serial No. : 270-01002
Frequency : 835.0 MHz
Last Calib. Date : 21-Jun-2014
Temperature : 20.00 °C
Ambient Temp. : 21.00 °C
Humidity : 56.00 RH%
Epsilon : 41.07 F/m
Sigma : 0.92 S/m
Density : 1000.00 kg/cu. m

Probe Data

Name : E-Field
Model : E-020
Type : E-Field Triangle
Serial No. : 500-00283
Last Calib. Date : 08-Oct-2013
Frequency Band : 835
Duty Cycle Factor : 1
Conversion Factor : 5.9
Probe Sensitivity : 1.20 1.20 1.20 $\mu\text{V}/(\text{V}/\text{m})^2$
Compression Point : 95.00 mV
Offset : 1.56 mm

Measurement Data

Crest Factor : 1
Scan Type : Complete
Tissue Temp. : 21.00 °C
Ambient Temp. : 21.00 °C
Area Scan : 7x9x1 : Measurement x=10mm, y=10mm, z=4mm
Zoom Scan : 7x7x7 : Measurement x=5mm, y=5mm, z=5mm

1 gram SAR value : 9.749 W/kg
10 gram SAR value : 6.328 W/kg
Area Scan Peak SAR : 10.875 W/kg
Zoom Scan Peak SAR : 16.297 W/kg

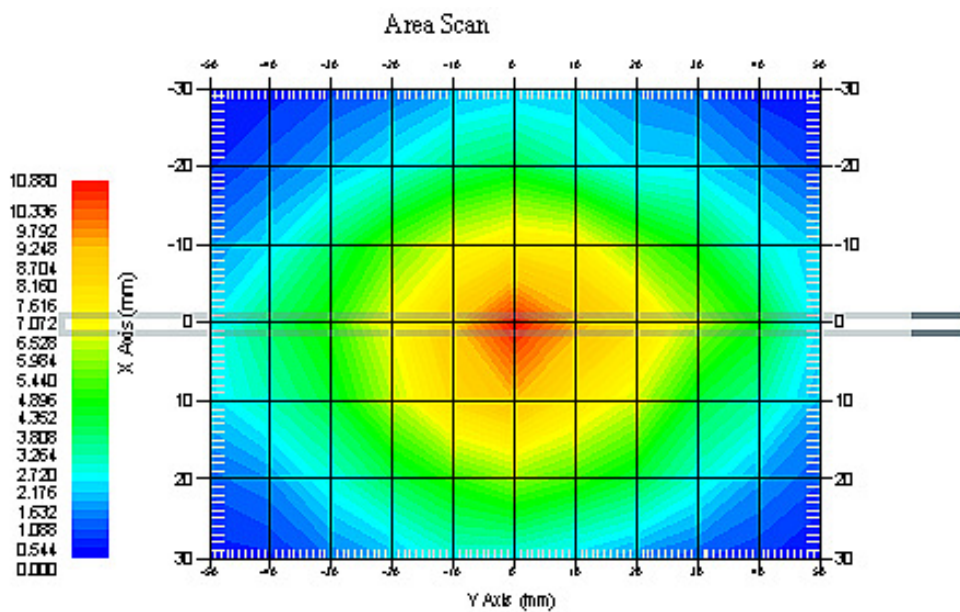

835 MHz System Validation with Head Tissue

Test Laboratory: Bay Area Compliance Lab Corp. (Shenzhen)**System Performance Check 835 MHz Body Liquid****Dipole 835 MHz; Type: ALS-D-835-S-2; S/N: 180-00558**

Product Data

Device Name : Dipole 835 MHz
Serial No. : 180-00558
Type : Dipole
Model : ALS-D-835-S-2
Frequency Band : 835
Max. Transmit Pwr : 1 W
Drift Time : 3 min(s)
Power Drift-Start : 10.528 W/kg
Power Drift-Finish : 10.402 W/kg
Power Drift (%) : -1.097

Phantom Data

Name : APREL-Uni
Type : Uni-Phantom
Size (mm) : 280 x 280 x 200
Serial No. : System Default
Location : Center
Description : Default
Phantom Data

Tissue Data

Type : Body
Serial No. : 270-02101
Frequency : 835.0 MHz
Last Calib. Date : 21-Jun-2014
Temperature : 20.00 °C
Ambient Temp. : 21.00 °C
Humidity : 56.00 RH%
Epsilon : 53.87 F/m
Sigma : 0.96 S/m
Density : 1000.00 kg/cu. m

Probe Data

Name : E-Field
Model : E-020
Type : E-Field Triangle
Serial No. : 500-00283
Last Calib. Date : 08-Oct-2013
Frequency Band : 835
Duty Cycle Factor : 1
Conversion Factor : 5.9
Probe Sensitivity : 1.20 1.20 1.20 $\mu\text{V}/(\text{V}/\text{m})^2$
Compression Point : 95.00 mV
Offset : 1.56 mm

Measurement Data

Crest Factor : 1
Scan Type : Complete
Tissue Temp. : 21.00 °C
Ambient Temp. : 21.00 °C
Area Scan : 7x9x1 : Measurement x=10mm, y=10mm, z=4mm
Zoom Scan : 7x7x7 : Measurement x=5mm, y=5mm, z=5mm

1 gram SAR value : 9.852 W/kg
10 gram SAR value : 6.477 W/kg
Area Scan Peak SAR : 11.471 W/kg
Zoom Scan Peak SAR : 15.968 W/kg

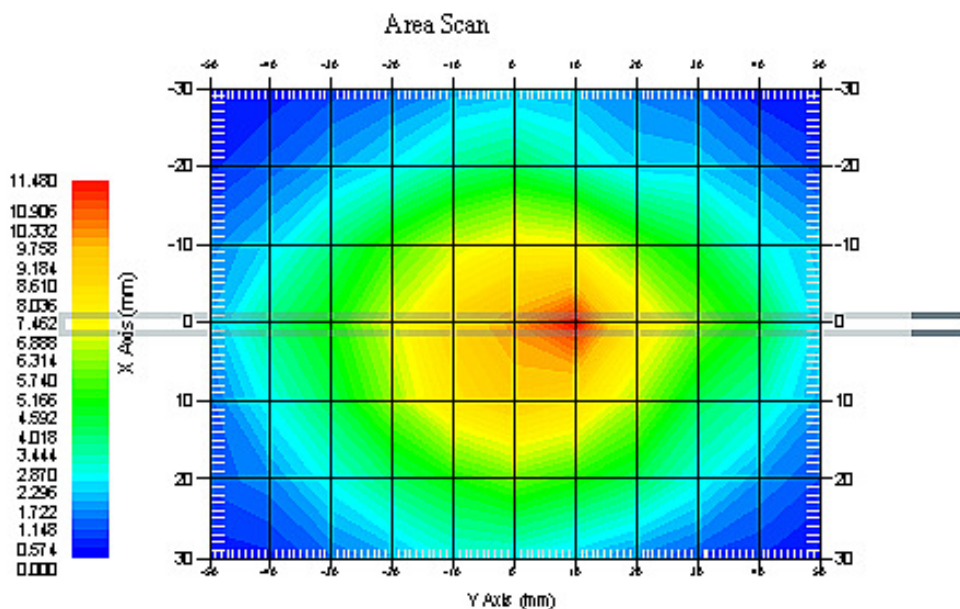

835 MHz System Validation with Body Tissue

Test Laboratory: Bay Area Compliance Lab Corp. (Shenzhen)**System Performance Check 1900 MHz Head Liquid****Dipole 1900 MHz; Type: ALS-D-1900-S-2; S/N: 210-00710**

Product Data

Device Name : Dipole 1900MHz
Serial No. : 210-00710
Type : Dipole
Model : ALS-D-1900-S-2
Frequency Band : 1900
Max. Transmit Pwr : 1 W
Drift Time : 3 min(s)
Power Drift-Start : 39.958 W/kg
Power Drift-Finish : 39.503 W/kg
Power Drift (%) : -1.139

Phantom Data

Name : APREL-Uni
Type : Uni-Phantom
Size (mm) : 280 x 280 x 200
Serial No. : System Default
Location : Center
Description : Default

Tissue Data

Type : Head
Serial No. : 295-01103
Frequency : 1900.00 MHz
Last Calib. Date : 21-Jun-2014
Temperature : 20.00 °C
Ambient Temp. : 21.00 °C
Humidity : 56.00 RH%
Epsilon : 39.66 F/m
Sigma : 1.42 S/m
Density : 1000.00 kg/cu. M

Probe Data

Name : E-Field
Model : E-020
Type : E-Field Triangle
Serial No. : 500-00283
Last Calib. Date : 08-Oct-2013
Frequency Band : 1900
Duty Cycle Factor : 1
Conversion Factor : 4.8
Probe Sensitivity : 1.20 1.20 1.20 $\mu\text{V}/(\text{V}/\text{m})^2$
Compression Point : 95.00 mV
Offset : 1.56 mm

Measurement Data

Crest Factor : 1
Scan Type : Complete
Tissue Temp. : 20.00 °C
Ambient Temp. : 20.00 °C
Area Scan : 7x9x1 : Measurement x=10mm, y=10mm, z=4mm
Zoom Scan : 7x7x7 : Measurement x=5mm, y=5mm, z=5mm

1 gram SAR value : 39.982 W/kg
10 gram SAR value : 22.031 W/kg
Area Scan Peak SAR : 52.117 W/kg
Zoom Scan Peak SAR : 79.978 W/kg

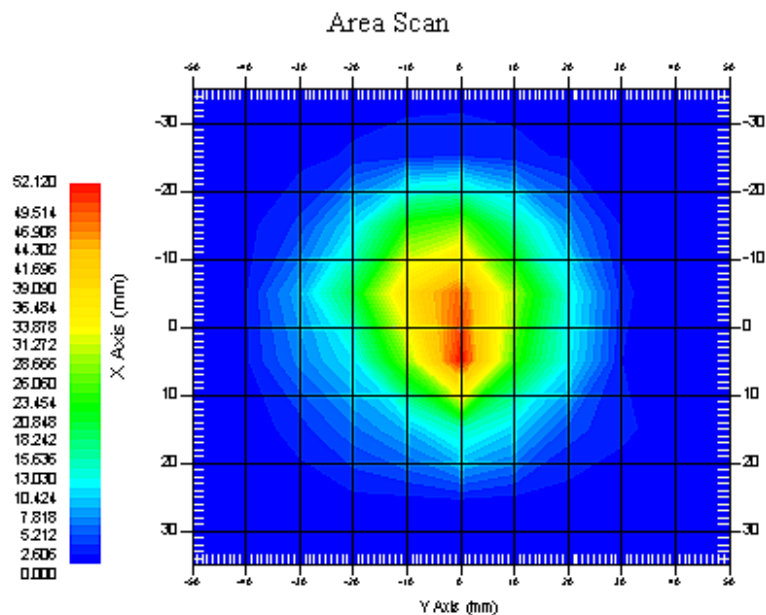

1900 MHz System Validation with Head Tissue

Test Laboratory: Bay Area Compliance Lab Corp. (Shenzhen)**System Performance Check 1900 MHz Body Liquid****Dipole 1900 MHz; Type: ALS-D-1900-S-2; S/N: 210-00710**

Product Data

Device Name : Dipole 1900MHz
Serial No. : 210-00710
Type : Dipole
Model : ALS-D-1900-S-2
Frequency Band : 1900
Max. Transmit Pwr : 1 W
Drift Time : 3 min(s)
Power Drift-Start : 40.002 W/kg
Power Drift-Finish : 40.936 W/kg
Power Drift (%) : 2.294

Phantom Data

Name : APREL-Uni
Type : Uni-Phantom
Size (mm) : 280 x 280 x 200
Serial No. : System Default
Location : Center
Description : Default

Tissue Data

Type : Body
Serial No. : 295-02102
Frequency : 1900.00 MHz
Last Calib. Date : 21-Jun-2014
Temperature : 20.00 °C
Ambient Temp. : 21.00 °C
Humidity : 56.00 RH%
Epsilon : 51.79 F/m
Sigma : 1.53 S/m
Density : 1000.00 kg/cu. m

Probe Data

Name : E-Field
Model : E-020
Type : E-Field Triangle
Serial No. : 500-00283
Last Calib. Date : 08-Oct-2013
Frequency Band : 1900
Duty Cycle Factor : 1
Conversion Factor : 4.5
Probe Sensitivity : 1.20 1.20 1.20 $\mu\text{V}/(\text{V}/\text{m})^2$
Compression Point : 95.00 mV
Offset : 1.56 mm

Measurement Data

Crest Factor : 1
Scan Type : Complete
Tissue Temp. : 20.00 °C
Ambient Temp. : 21.00 °C
Area Scan : 7x9x1 : Measurement x=10mm, y=10mm, z=4mm
Zoom Scan : 7x7x7 : Measurement x=5mm, y=5mm, z=5mm

1 gram SAR value : 40.317 W/kg
 10 gram SAR value : 21.825 W/kg
 Area Scan Peak SAR : 43.157 W/kg
 Zoom Scan Peak SAR : 79.492 W/kg

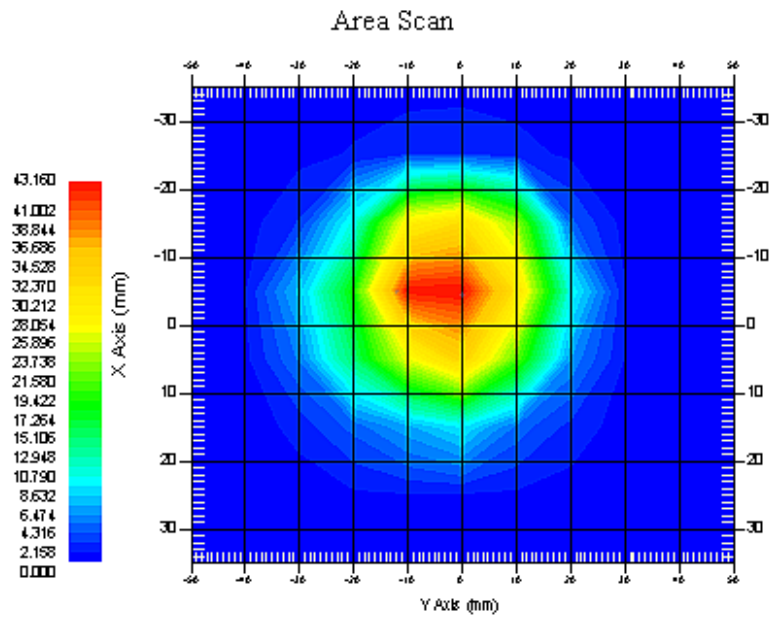

1900 MHz System Validation with Body Tissue

EUT TEST STRATEGY AND METHODOLOGY

Test Positions for Device Operating Next to a Person’s Ear

This category includes most wireless handsets with fixed, retractable or internal antennas located toward the top half of the device, with or without a foldout, sliding or similar keypad cover. The handset should have its earpiece located within the upper ¼ of the device, either along the centerline or off-centered, as perceived by its users. This type of handset should be positioned in a normal operating position with the “test device reference point” located along the “vertical centerline” on the front of the device aligned to the “ear reference point”. The “test device reference point” should be located at the same level as the center of the earpiece region. The “vertical centerline” should bisect the front surface of the handset at its top and bottom edges. A “ear reference point” is located on the outer surface of the head phantom on each ear spacer. It is located 1.5 cm above the center of the ear canal entrance in the “phantom reference plane” defined by the three lines joining the center of each “ear reference point” (left and right) and the tip of the mouth.

A handset should be initially positioned with the earpiece region pressed against the ear spacer of a head phantom. For the SCC-34/SC-2 head phantom, the device should be positioned parallel to the “N-F” line defined along the base of the ear spacer that contains the “ear reference point”. For interim head phantoms, the device should be positioned parallel to the cheek for maximum RF energy coupling. The “test device reference point” is aligned to the “ear reference point” on the head phantom and the “vertical centerline” is aligned to the “phantom reference plane”. This is called the “initial ear position”. While maintaining these three alignments, the body of the handset is gradually adjusted to each of the following positions for evaluating SAR:

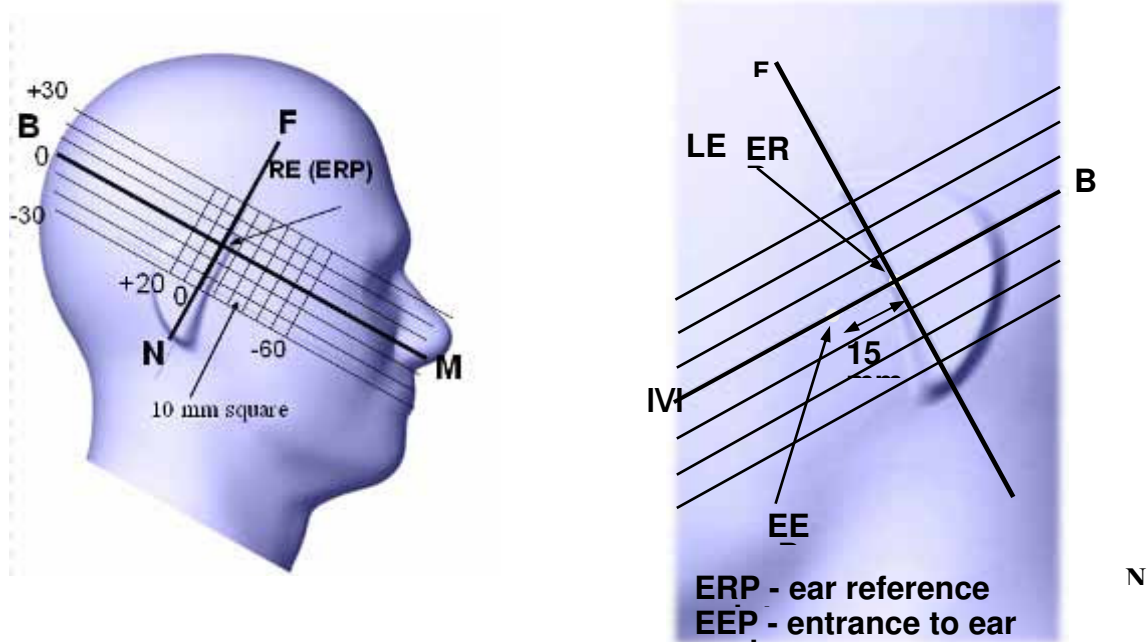

Cheek/Touch Position

The device is brought toward the mouth of the head phantom by pivoting against the “ear reference point” or along the “N-F” line for the SCC-34/SC-2 head phantom.

This test position is established:

- When any point on the display, keypad or mouthpiece portions of the handset is in contact with the phantom.
- (or) When any portion of a foldout, sliding or similar keypad cover opened to its intended self-adjusting normal use position is in contact with the cheek or mouth of the phantom.

For existing head phantoms – when the handset loses contact with the phantom at the pivoting point, rotation should continue until the device touches the cheek of the phantom or breaks its last contact from the ear spacer.

Cheek /Touch Position

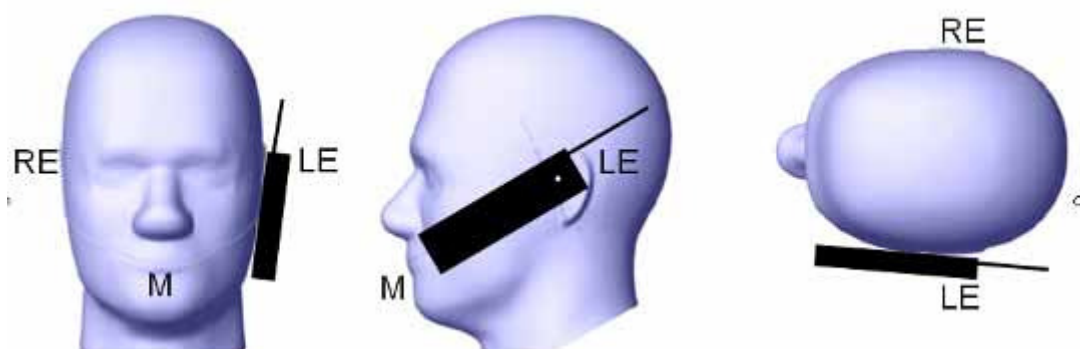

Ear/Tilt Position

With the handset aligned in the “Cheek/Touch Position”:

1) If the earpiece of the handset is not in full contact with the phantom’s ear spacer (in the “Cheek/Touch position”) and the peak SAR location for the “Cheek/Touch” position is located at the ear spacer region or corresponds to the earpiece region of the handset, the device should be returned to the “initial ear position” by rotating it away from the mouth until the earpiece is in full contact with the ear spacer.

2) (otherwise) The handset should be moved (translated) away from the cheek perpendicular to the line passes through both “ear reference points” (note: one of these ear reference points may not physically exist on a split head model) for approximate 2-3 cm. While it is in this position, the device handset is tilted away from the mouth with respect to the “test device reference point” until the inside angle between the vertical centerline on the front surface of the phone and the horizontal line passing through the ear reference point is by 15 80°. After the tilt, it is then moved (translated) back toward the head perpendicular to the line passes through both “ear reference points” until the device touches the phantom or the ear spacer. If the antenna touches the head first, the positioning process should be repeated with a tilt angle less than 15° so that the device and its antenna would touch the phantom simultaneously. This test position may require a device holder or positioner to achieve the translation and tilting with acceptable positioning repeatability.

If a device is also designed to transmit with its keypad cover closed for operating in the head position, such positions should also be considered in the SAR evaluation. The device should be tested on the left and right side of the head phantom in the “Cheek/Touch” and “Ear/Tilt” positions. When applicable, each configuration should be tested with the antenna in its fully extended and fully retracted positions. These test configurations should be tested at the high, middle and low frequency channels of each operating mode; for example, AMPS, CDMA, and TDMA. If the SAR measured at the middle channel for each test configuration (left, right, Cheek/Touch, Tile/Ear, extended and retracted) is at least 2.0 dB lower than the SAR limit, testing at the high and low channels is optional for such test configuration(s). If the transmission band of the test device is less than 10 MHz, testing at the high and low frequency channels is optional.

Ear /Tilt 15° Position

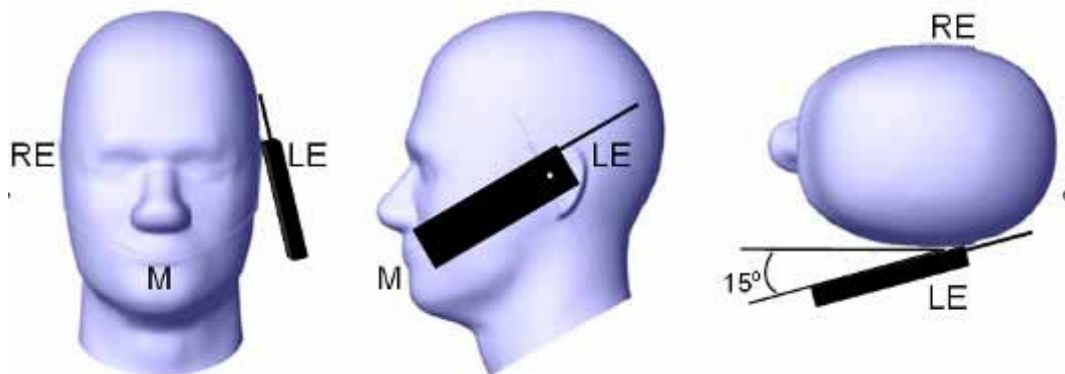

Test positions for body-worn and other configurations

Body-worn operating configurations should be tested with the belt-clips and holsters attached to the device and positioned against a flat phantom in normal use configurations. Devices with a headset output should be tested with a headset connected to the device. When multiple accessories that do not contain metallic components are supplied with the device, the device may be tested with only the accessory that dictates the closest spacing to the body. When multiple accessories that contain metallic components are supplied with the device, the device must be tested with each accessory that contains a unique metallic component. If multiple accessories share an identical metallic component (e.g., the same metallic belt-clip used with different holsters with no other metallic components), only the accessory that dictates the closest spacing to the body must be tested.

Body-worn accessories may not always be supplied or available as options for some devices that are intended to be authorized for body-worn use. A separation distance of 1.5 cm between the back of the device and a flat phantom is recommended for testing body-worn SAR compliance under such circumstances. Other separation distances may be used, but they should not exceed 2.5 cm. In these cases, the device may use body-worn accessories that provide a separation distance greater than that tested for the device provided however that the accessory contains no metallic components.

SAR Evaluation Procedure

The evaluation was performed with the following procedure:

Step 1: Measurement of the SAR value at a fixed location above the ear point or central position was used as a reference value for assessing the power drop. The SAR at this point is measured at the start of the test and then again at the end of the testing.

Step 2: The SAR distribution at the exposed side of the head was measured at a distance of 4 mm from the inner surface of the shell. The area covered the entire dimension of the head or EUT and the horizontal grid spacing was 10 mm x 10 mm. Based on these data, the area of the maximum absorption was determined by spline interpolation. The first Area Scan covers the entire dimension of the EUT to ensure that the hotspot was correctly identified.

Step 3: Around this point, a volume of 35 mm x 35 mm x 35 mm was assessed by measuring 7x 7 x 7 points. On the basis of this data set, the spatial peak SAR value was evaluated under the following procedure:

- 1) The data at the surface were extrapolated, since the center of the dipoles is 1.2 mm away from the tip of the probe and the distance between the surface and the lowest measuring point is 1.3 mm. The extrapolation was based on a least square algorithm. A polynomial of the fourth order was calculated through the points in z-axes. This polynomial was then used to evaluate the points between the surface and the probe tip.
- 2) The maximum interpolated value was searched with a straightforward algorithm. Around this maximum the SAR values averaged over the spatial volumes (1 g or 10 g) were computed by the 3D-Spline interpolation algorithm. The 3D-Spline is composed of three one dimensional splines with the "Not a knot"-condition (in x, y and z-directions). The volume was integrated with the trapezoidal-algorithm. One thousand points (10 x 10 x 10) were interpolated to calculate the averages.

All neighboring volumes were evaluated until no neighboring volume with a higher average value was found.

Step 4: Re-measurement of the SAR value at the same location as in Step 1. If the value changed by more than 5%, the evaluation was repeated.

CONDUCTED OUTPUT POWER MEASUREMENT

Provision Applicable

The measured peak output power should be greater and within 5% than EMI measurement.

Test Procedure

The RF output of the transmitter was connected to the input of the EMI Test Receiver through sufficient attenuation.

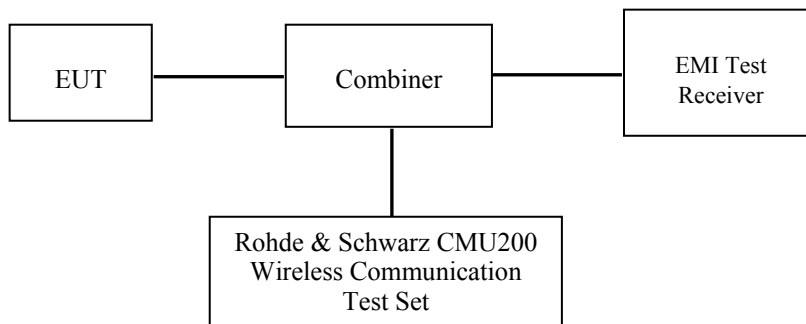

GSM&3G

Maximum Output Power among production units

Max Target Power for Production Unit (dBm)			
Mode/Band	Channel		
	Low	Middle	High
GSM 850	32.00	32.00	32.00
GPRS 1 slot	31.50	31.50	31.50
GPRS 2 slot	28.30	28.30	28.30
GPRS 3 slot	27.00	27.00	27.00
GPRS 4 slot	25.00	25.00	25.00
PCS 1900	28.50	28.50	28.50
GPRS 1 slot	28.50	28.50	28.50
GPRS 2 slot	26.00	26.00	26.00
GPRS 3 slot	25.00	25.00	25.00
GPRS 4 slot	23.00	23.00	23.00
WCDMA850	23.00	23.00	22.50
WCDMA1900	22.30	22.30	22.30
WiFi	9.50	9.50	9.50
Bluetooth	9.00	9.00	9.00

Test Results:

GSM:

Band	Frequency (MHz)	Conducted Output Power	
		Meas. Power (dBm)	Meas. Power (W)
GSM 850	824.2	31.50	1.413
	836.6	31.66	1.466
	848.8	31.75	1.496
PCS 1900	1850.2	28.33	0.681
	1880.0	28.26	0.670
	1909.8	28.31	0.678

GPRS :

Band	Channel No.	Frequency (MHz)	RF Output Power (dBm)			
			1 slot	2 slot	3 slots	4 slots
GSM 850	128	824.2	31.16	27.86	26.71	24.55
	190	836.6	31.46	28.20	26.79	24.69
	251	848.8	31.48	28.22	26.97	24.88
PCS 1900	512	1850.2	28.36	25.99	24.97	22.97
	661	1880.0	28.30	25.94	24.93	22.96
	810	1909.8	28.27	25.88	24.89	22.89

For SAR, the time based average power is relevant, the difference in between depends on the duty cycle of the TDMA signal.

Number of Time slot	1	2	3	4
Duty Cycle	1:8	1:4	1:2.66	1:2
Time based Ave. power compared to slotted Ave. power	-9 dB	-6 dB	-4.25 dB	-3 dB
Crest Factor	8	4	2.66	2

The time based average power for GPRS

Band	Channel No.	Frequency (MHz)	Time based average Power (dBm)			
			1 slot	2 slot	3 slots	4 slots
GSM 850	128	824.2	22.16	21.86	22.46	21.55
	190	836.6	22.46	22.20	22.54	21.69
	251	848.8	22.48	22.22	22.72	21.88
PCS 1900	512	1850.2	19.36	19.99	20.72	19.97
	661	1880.0	19.30	19.94	20.68	19.96
	810	1909.8	19.27	19.88	20.64	19.89

Note:

1. Rohde & Schwarz Radio Communication Tester (CMU200) was used for the measurement of GSM peak and average output power for active timeslots.
2. For GSM voice, 1 timeslot has been activated with power level 5 (850 MHz band) and 0 (1900 MHz band).
3. For GPRS, 1, 2, 3 and 4 timeslots has been activated separately with power level 3(850 MHz band) and 3(1900 MHz band).

WCDMA-Release 99:

The following tests were conducted according to the test requirements outlines in section 5.2 of the 3GPP TS34.121-1 specification. The EUT has a nominal maximum output power of 24dBm (+1.7/-3.7).

WCDMA General Settings	Loopback Mode	Test Mode 1
	Rel99 RMC	12.2kbps RMC
	Power Control Algorithm	Algorithm2
	β_c / β_d	8/15

Results (12.2kbps RMC)

Band	Frequency (MHz)	Channel NO.	Conducted Output Power	
			(dBm)	(Watt)
WCDMA 850	826.4	4132	22.67	0.185
	836.6	4183	22.54	0.179
	846.6	4233	22.15	0.164
WCDMA 1900	1852.4	9262	21.92	0.156
	1880.0	9400	22.13	0.163
	1907.6	9538	22.17	0.165

WCDMA HSDPA

The following tests were conducted according to the test requirements outlines in section 5.2 of the 3GPP TS34.121-1 specification.

	Mode	HSDPA	HSDPA	HSDPA	HSDPA
	Subset	1	2	3	4
WCDMA General Settings	Loopback Mode	Test Mode 1			
	Rel99 RMC	12.2kbps RMC			
	HSDPA FRC	H-Set1			
	Power Control Algorithm	Algorithm2			
	α_c	2/15	12/15	15/15	15/15
	α_d	15/15	15/15	8/15	4/15
	α_d (SF)	64			
	α_c/α_d	2/15	12/15	15/8	15/4
	α_{hs}	4/15	24/15	30/15	30/15
MPR(dB)	0	0	0.5	0.5	
HSDPA Specific Settings	D_{ACK}	8			
	D_{NAK}	8			
	D_{CQI}	8			
	Ack-Nack repetition factor	3			
	CQI Feedback	4ms			
	CQI Repetition Factor	2			
	$A_{hs} = \alpha_{hs}/\alpha_c$	30/15			

Results (HSDPA)

Band	Frequency (MHz)	Channel NO.	Conducted Output Power (dBm)			
			Subset 1	Subset 2	Subset 3	Subset 4
WCDMA 850	826.4	4132	22.31	22.32	22.43	22.39
	836.6	4183	22.21	22.24	22.23	22.14
	846.6	4233	21.79	21.77	21.84	21.82
WCDMA 1900	1852.4	9262	21.51	21.58	21.64	21.55
	1880.0	9400	21.68	21.56	21.6	21.57
	1907.6	9538	21.70	21.68	21.62	21.71

WCDMA HSUPA

The following tests were conducted according to the test requirements outlines in section 5.2 of the 3GPP TS34.121-1 specification.

	Mode	HSUPA	HSUPA	HSUPA	HSUPA	HSUPA
	Subset	1	2	3	4	5
WCDMA General Settings	Loopback Mode	Test Mode 1				
	Rel99 RMC	12.2kbps RMC				
	HSDPA FRC	H-Set1				
	HSUPA Test	HSUPA Loopback				
	Power Control Algorithm	Algorithm2				
	α_c	11/15	6/15	15/15	2/15	15/15
	α_d	15/15	15/15	9/15	15/15	0
	α_{ec}	209/225	12/15	30/15	2/15	5/15
	α_c/α_d	11/15	6/15	15/9	2/15	-
	α_{hs}	22/15	12/15	30/15	4/15	5/15
	CM(dB)	1.0	3.0	2.0	3.0	1.0
MPR(dB)	0	2	1	2	0	
HSDPA Specific Settings	DACK	8				
	DNAK	8				
	DCQI	8				
	Ack-Nack repetition factor	3				
	CQI Feedback	4ms				
	CQI Repetition Factor	2				
	$A_{hs} = \alpha_{hs}/\alpha_c$	30/15				
HSUPA Specific Settings	DE-DPCCH	6	8	8	5	7
	DHARQ	0	0	0	0	0
	AG Index	20	12	15	17	21
	ETFCI	75	67	92	71	81
	Associated Max UL Data Rate kbps	242.1	174.9	482.8	205.8	308.9
	Reference E_FCIs	E-TFCI 11 E E-TFCI PO 4 E-TFCI 67 E-TFCI PO 18 E-TFCI 71 E-TFCI PO23 E-TFCI 75 E-TFCI PO26 E-TFCI 81 E-TFCI PO 27		E-TFCI 11 E-TFCI PO4 E-TFCI 92 E-TFCI PO 18		E-TFCI 11 E E-TFCI PO 4 E-TFCI 67 E-TFCI PO 18 E-TFCI 71 E-TFCI PO23 E-TFCI 75 E-TFCI PO26 E-TFCI 81 E-TFCI PO 27

Results (HSUPA)

Band	Frequency (MHz)	Channel NO.	Conducted Output Power (dBm)				
			Subset 1	Subset 2	Subset 3	Subset 4	Subset 5
WCDMA 850	826.4	4132	22.30	22.34	22.41	22.37	22.42
	836.6	4183	22.12	22.23	22.30	22.23	22.16
	846.6	4233	21.72	21.79	21.80	21.73	21.65
WCDMA 1900	1852.4	9262	21.60	21.57	21.63	21.61	21.56
	1880.0	9400	21.61	21.63	21.77	21.65	21.70
	1907.6	9538	21.66	21.88	21.74	21.76	21.70

Note:

1. The default test configuration is to measure SAR with an established radio link between the EUT and a communication test set using a 12.2 kbps RMC (reference measurement Channel) Configured in Test Loop Model 1.
2. KDB 941225 D01-Body SAR is not required for HSDPA when the maximum average output of each RF channel with HSDPA active is less than ¼ dB higher than measured without HSDPA using 12.2kbps RMC or the maximum SAR for 12.2kbps RMC is < 75% of SAR limit.
3. KDB 941225 D01-Body SAR is not required for HSUPA when the maximum average output of each RF channel with HSUPA active is less than ¼ dB higher than measured without HSUPA using 12.2kbps RMC and the maximum SAR for 12.2kbps RMC is < 75% of SAR limit.

Bluetooth

Mode	Channel frequency (MHz)	Conducted Output Power	
		(dBm)	(mw)
BDR (GFSK)	2402	-2.75	0.531
	2441	-1.99	0.632
	2480	-2.06	0.622
EDR ($\pi/4$ -DQPSK)	2402	-3.23	0.475
	2441	-2.46	0.568
	2480	-2.57	0.553
EDR (8DPSK)	2402	-3.28	0.470
	2441	-2.74	0.532
	2480	-2.28	0.592
BLE	2402	8.28	6.730
	2440	9.00	7.943
	2480	8.47	7.031

WiFi

Band	Frequency (MHz)	Conducted Output Power	
		(dBm)	(mw)
802.11b	2412	9.48	8.872
	2437	9.08	8.091
	2462	8.93	7.816
802.11g	2412	9.18	8.279
	2437	8.99	7.925
	2462	8.90	7.762

Note:

1. The output power was tested under data rate 1Mbps for 802.11b, 6Mbps for 802.11g.

SAR MEASUREMENT RESULTS

This page summarizes the results of the performed dosimetric evaluation.

SAR Test Data

Environmental Conditions

Temperature:	21-24 °C
Relative Humidity:	50-53 %
ATM Pressure:	1001-1002 mbar

Testing was performed by Wilson Chen from 2014-06-21 to 2014-06-22.

GSM 850:

EUT Position	Frequency (MHz)		Test Mode	Power Drift (%)	Max. Meas. Power (dBm)	Max. Rated Power (dBm)	FCC 1g SAR (W/Kg)		
	Channel	MHz					Scaled Factor	Meas. SAR	Scaled SAR
Left Head Cheek	128(Low)	824.2	GSM	1.259	31.50	32.00	1.122	0.163	0.183
	190(Middle)	836.6	GSM	0.813	31.66	32.00	1.081	0.172	0.186
	251(High)	848.8	GSM	-2.148	31.75	32.00	1.059	0.162	0.172
Left Head Tilt	128(Low)	824.2	GSM	/	/	/	/	/	/
	190(Middle)	836.6	GSM	-1.129	31.66	32.00	1.081	0.098	0.106
	251(High)	848.8	GSM	/	/	/	/	/	/
Right Head Cheek	128(Low)	824.2	GSM	/	/	/	/	/	/
	190(Middle)	836.6	GSM	-0.372	31.66	32.00	1.081	0.155	0.168
	251(High)	848.8	GSM	/	/	/	/	/	/
Right Head Tilt	128(Low)	824.2	GSM	/	/	/	/	/	/
	190(Middle)	836.6	GSM	1.027	31.66	32.00	1.081	0.101	0.109
	251(High)	848.8	GSM	/	/	/	/	/	/
Body-Front-Headset (10mm)	128(Low)	824.2	GSM	/	/	/	/	/	/
	190(Middle)	836.6	GSM	1.759	31.66	32.00	1.081	0.078	0.084
	251(High)	848.8	GSM	/	/	/	/	/	/
Body-Back-Headset (10mm)	128(Low)	824.2	GSM	/	/	/	/	/	/
	190(Middle)	836.6	GSM	-1.902	31.66	32.00	1.081	0.113	0.122
	251(High)	848.8	GSM	/	/	/	/	/	/

Note:

1. When the 1-g SAR is ≤ 0.8 W/Kg, testing for other channels are optional.
2. The EUT transmit and receive through the same GSM antenna while testing SAR.
3. When SAR or MPE is not measured at the maximum power level allowed for production units, the results must be scaled to the maximum tune-up tolerance limit according to the power applied to the individual channels tested to determine compliance.

PCS Band:

EUT Position	Frequency (MHz)		Test Mode	Power Drift (%)	Max. Meas. Power (dBm)	Max. Rated Power (dBm)	FCC 1g SAR (W/Kg)		
	Channel	MHz					Scaled Factor	Meas. SAR	Scaled SAR
Left Head Cheek	512(Low)	1850.2	GSM	/	/	/	/	/	/
	661(Middle)	1880.0	GSM	-0.997	28.26	28.50	1.057	0.201	0.212
	810(HIGH)	1909.8	GSM	/	/	/	/	/	/
Left Head Tilt	512(LOW)	1850.2	GSM	/	/	/	/	/	/
	661(MIDDLE)	1880.0	GSM	1.091	28.26	28.50	1.057	0.094	0.099
	810(HIGH)	1909.8	GSM	/	/	/	/	/	/
Right Head Cheek	512(LOW)	1850.2	GSM	-3.647	28.33	28.50	1.040	0.194	0.202
	661(MIDDLE)	1880.0	GSM	-0.769	28.26	28.50	1.057	0.211	0.223
	810(HIGH)	1909.8	GSM	1.426	28.31	28.50	1.045	0.189	0.198
Right Head Tilt	512(LOW)	1850.2	GSM	/	/	/	/	/	/
	661(MIDDLE)	1880.0	GSM	-2.867	28.26	28.50	1.057	0.088	0.093
	810(HIGH)	1909.8	GSM	/	/	/	/	/	/
Body-Front-Headset (10mm)	512(LOW)	1850.2	GSM	/	/	/	/	/	/
	661(MIDDLE)	1880.0	GSM	-2.807	28.26	28.50	1.057	0.251	0.265
	810(HIGH)	1909.8	GSM	/	/	/	/	/	/
Body-Back-Headset (10mm)	512(LOW)	1850.2	GSM	/	/	/	/	/	/
	661(MIDDLE)	1880.0	GSM	1.328	28.26	28.50	1.057	0.276	0.292
	810(HIGH)	1909.8	GSM	/	/	/	/	/	/

Note:

1. When the 1-g SAR is $\leq 0.8\text{W/Kg}$, testing for other channels are optional.
2. The EUT transmit and receive through the same GSM antenna while testing SAR.
3. When SAR or MPE is not measured at the maximum power level allowed for production units, the results must be scaled to the maximum tune-up tolerance limit according to the power applied to the individual channels tested to determine compliance.

WCDMA 850

EUT Position	Frequency (MHz)		Test Mode	Power Drift (%)	Max. Meas. Power (dBm)	Max. Rated Power (dBm)	FCC 1g SAR (W/Kg)		
	Channel	MHz					Scaled Factor	Meas. SAR	Scaled SAR
Left Head Cheek	4132	826.4	WCDMA 850	1.485	22.67	23.00	1.079	0.146	0.158
	4183	836.6	WCDMA 850	/	/	/	/	/	/
	4233	846.6	WCDMA 850	/	/	/	/	/	/
Left Head Tilt	4132	826.4	WCDMA 850	2.907	22.67	23.00	1.079	0.086	0.093
	4183	836.6	WCDMA 850	/	/	/	/	/	/
	4233	846.6	WCDMA 850	/	/	/	/	/	/
Right Head Cheek	4132	826.4	WCDMA 850	1.065	22.67	23.00	1.079	0.156	0.168
	4183	836.6	WCDMA 850	/	/	/	/	/	/
	4233	846.6	WCDMA 850	/	/	/	/	/	/
Right Head Tilt	4132	826.4	WCDMA 850	-0.437	22.67	23.00	1.079	0.090	0.097
	4183	836.6	WCDMA 850	/	/	/	/	/	/
	4233	846.6	WCDMA 850	/	/	/	/	/	/

WCDMA1900

EUT Position	Frequency (MHz)		Test Mode	Power Drift (%)	Max. Meas. Power (dBm)	Max. Rated Power (dBm)	FCC 1g SAR (W/Kg)		
	Channel	MHz					Scaled Factor	Meas. SAR	Scaled SAR
Left Head Cheek	9262	1852.4	WCDMA1900	/	/	/	/	/	/
	9400	1880.0	WCDMA1900	/	/	/	/	/	/
	9538	1907.6	WCDMA1900	1.848	22.17	22.30	1.030	0.329	0.339
Left Head Tilt	9262	1852.4	WCDMA1900	/	/	/	/	/	/
	9400	1880.0	WCDMA1900	/	/	/	/	/	/
	9538	1907.6	WCDMA1900	-0.681	22.17	22.30	1.030	0.157	0.162
Right Head Cheek	9262	1852.4	WCDMA1900	/	/	/	/	/	/
	9400	1880.0	WCDMA1900	/	/	/	/	/	/
	9538	1907.6	WCDMA1900	1.392	22.17	22.30	1.030	0.316	0.325
Right Head Tilt	9262	1852.4	WCDMA1900	/	/	/	/	/	/
	9400	1880.0	WCDMA1900	/	/	/	/	/	/
	9538	1907.6	WCDMA1900	1.114	22.17	22.30	1.030	0.149	0.153

Note:

1. When the 1-g SAR is $\leq 0.8W/Kg$, testing for other channels are optional.
2. The default test configuration is to measure SAR with an established radio link between the EUT and a communication test set using a 12.2 kbps RMC (reference measurement Channel) Configured in Test Loop Model.
3. KDB 941225 D01-Body SAR is not required for HSDPA when the maximum average output of each RF channel with HSDPA active is less than ¼ dB higher than measured without HSDPA using 12.2kbps RMC or the maximum SAR for 12.2kbps RMC is < 75% of SAR limit.

4. KDB 941225 D01-Body SAR is not required for HSUPA when the maximum average output of each RF channel with HSUPA active is less than ¼ dB higher than measured without HSUPA using 12.2kbps RMC and the maximum SAR for 12.2kbps RMC is < 75% of SAR limit.
5. When SAR or MPE is not measured at the maximum power level allowed for production units, the results must be scaled to the maximum tune-up tolerance limit according to the power applied to the individual channels tested to determine compliance.

Mobile Hot-Spot Test Result

The DUT is capable of functioning as a WiFi to Cellular Mobile hotspot. Additional SAR testing was performed according to KDB 941225 D06. Testing was performed with a separation of 1cm between the DUT and the flat phantom. The DUT was positioned for SAR tests with the front and back surfaces facing the phantom, and also with the edges facing the phantom in which the transmitting antenna is <2.5 cm from the edge. Each transmit band was utilized for SAR testing. The tested mode has been selected within each band that exhibits the highest time average output power.

Hot spot-GPRS (Frequency Band: 835)

EUT Position	Frequency (MHz)		Test Mode	Power Drift (%)	Max. Meas. Power (dBm)	Max. Rated Power (dBm)	FCC 1g SAR (W/Kg)		
	Channel	MHz					Scaled Factor	Meas. SAR	Scaled SAR
Body-Front (10mm)	128(Low)	824.2	GPRS	/	/	/	/	/	/
	190(Middle)	836.6	GPRS	/	/	/	/	/	/
	251(High)	848.8	GPRS	1.529	26.97	27.00	1.007	0.091	0.092
Body-Back (10mm)	128(Low)	824.2	GPRS	/	/	/	/	/	/
	190(Middle)	836.6	GPRS	/	/	/	/	/	/
	251(High)	848.8	GPRS	1.847	26.97	27.00	1.007	0.139	0.140
Body-Left (10mm)	128(Low)	824.2	GPRS	/	/	/	/	/	/
	190(Middle)	836.6	GPRS	/	/	/	/	/	/
	251(High)	848.8	GPRS	-2.053	26.97	27.00	1.007	0.029	0.029
Body-Right (10mm)	128(Low)	824.2	GPRS	/	/	/	/	/	/
	190(Middle)	836.6	GPRS	/	/	/	/	/	/
	251(High)	848.8	GPRS	-2.854	26.97	27.00	1.007	0.062	0.062
Body-Bottom (10mm)	128(Low)	824.2	GPRS	/	/	/	/	/	/
	190(Middle)	836.6	GPRS	/	/	/	/	/	/
	251(High)	848.8	GPRS	0.758	26.97	27.00	1.007	0.022	0.022

Note:

1. When the 1-g SAR is ≤ 0.8W/Kg, testing for other channels are optional.
2. The EUT is a Capability Class B mobile phone which can be attached to both GPRS and GSM services.
3. The Multi-slot Classes of EUT is Class 12 which has maximum 4 Downlink slots and 4 Uplink slots, the maximum active slots is 5, when perform the multiple slots scan, 2DL+3UL is the worst case.
4. The EUT transmit and receive through the same GSM antenna while testing SAR.
5. When SAR or MPE is not measured at the maximum power level allowed for production units, the results must be scaled to the maximum tune-up tolerance limit according to the power applied to the individual channels tested to determine compliance.

Hot spot-GPRS (Frequency Band: 1900)

EUT Position	Frequency (MHz)		Test Mode	Power Drift (%)	Max. Meas. Power (dBm)	Max. Rated Power (dBm)	FCC 1g SAR (W/Kg)		
	Channel	MHz					Scaled Factor	Meas. SAR	Scaled SAR
Body-Front (10mm)	512(Low)	1850.2	GPRS	3.685	24.97	25.00	1.007	0.275	0.277
	661(Middle)	1880.0	GPRS	/	/	/	/	/	/
	810(High)	1909.8	GPRS	/	/	/	/	/	/
Body-Back (10mm)	512(Low)	1850.2	GPRS	-1.627	24.97	25.00	1.007	0.293	0.295
	661(Middle)	1880.0	GPRS	/	/	/	/	/	/
	810(High)	1909.8	GPRS	/	/	/	/	/	/
Body-Left (10mm)	512(Low)	1850.2	GPRS	-0.624	24.97	25.00	1.007	0.090	0.091
	661(Middle)	1880.0	GPRS	/	/	/	/	/	/
	810(High)	1909.8	GPRS	/	/	/	/	/	/
Body-Right (10mm)	512(Low)	1850.2	GPRS	1.725	24.97	25.00	1.007	0.115	0.116
	661(Middle)	1880.0	GPRS	/	/	/	/	/	/
	810(High)	1909.8	GPRS	/	/	/	/	/	/
Body-Bottom (10mm)	512(Low)	1850.2	GPRS	-0.842	24.97	25.00	1.007	0.048	0.048
	661(Middle)	1880.0	GPRS	/	/	/	/	/	/
	810(High)	1909.8	GPRS	/	/	/	/	/	/

Note:

1. When the 1-g SAR is $\leq 0.8\text{W/Kg}$, testing for other channels are optional.
2. The EUT is a Capability Class B mobile phone which can be attached to both GPRS and GSM services.
3. The Multi-slot Classes of EUT is Class12 which has maximum 4 Downlink slots and 4 Uplink slots, the maximum active slots is 5, when perform the multiple slots scan, 2DL+3UL is the worst case.
4. The EUT transmit and receive through the same GSM antenna while testing SAR.
5. When SAR or MPE is not measured at the maximum power level allowed for production units, the results must be scaled to the maximum tune-up tolerance limit according to the power applied to the individual channels tested to determine compliance.

Hot Spot-WCDMA850

EUT Position	Frequency (MHz)		Test Mode	Power Drift (%)	Max. Meas. Power (dBm)	Max. Rated Power (dBm)	FCC 1g SAR (W/Kg)		
	Channel	MHz					Scaled Factor	Meas. SAR	Scaled SAR
Body-Front (10mm)	4132	826.4	WCDMA850	-2.984	22.67	23.00	1.079	0.106	0.114
	4183	836.6	WCDMA850	/	/	/	/	/	/
	4233	846.6	WCDMA850	/	/	/	/	/	/
Body-Back (10mm)	4132	826.4	WCDMA850	-0.798	22.67	23.00	1.079	0.171	0.185
	4183	836.6	WCDMA850	/	/	/	/	/	/
	4233	846.6	WCDMA850	/	/	/	/	/	/
Body-Left (10mm)	4132	826.4	WCDMA850	-1.467	22.67	23.00	1.079	0.012	0.013
	4183	836.6	WCDMA850	/	/	/	/	/	/
	4233	846.6	WCDMA850	/	/	/	/	/	/
Body-Right (10mm)	4132	826.4	WCDMA850	1.328	22.67	23.00	1.079	0.079	0.085
	4183	836.6	WCDMA850	/	/	/	/	/	/
	4233	846.6	WCDMA850	/	/	/	/	/	/
Body-Bottom (10mm)	4132	826.4	WCDMA850	0.797	22.67	23.00	1.079	0.013	0.014
	4183	836.6	WCDMA850	/	/	/	/	/	/
	4233	846.6	WCDMA850	/	/	/	/	/	/

Note:

1. When the 1-g SAR is $\leq 0.8\text{W/Kg}$, testing for other channels are optional.
2. The default test configuration is to measure SAR with an established radio link between the EUT and a communication test set using a 12.2 kbps RMC (reference measurement Channel) Configured in Test Loop Model.
3. KDB 941225 D01-Body SAR is not required for HSDPA when the maximum average output of each RF channel with HSDPA active is less than $\frac{1}{4}$ dB higher than measured without HSDPA using 12.2kbps RMC or the maximum SAR for 12.2kbps RMC is $< 75\%$ of SAR limit.
4. KDB 941225 D01-Body SAR is not required for HSUPA when the maximum average output of each RF channel with HSUPA active is less than $\frac{1}{4}$ dB higher than measured without HSUPA using 12.2kbps RMC and the maximum SAR for 12.2kbps RMC is $< 75\%$ of SAR limit.

Hot Spot-WCDMA1900

EUT Position	Frequency (MHz)		Test Mode	Power Drift (%)	Max. Meas. Power (dBm)	Max. Rated Power (dBm)	FCC 1g SAR (W/Kg)		
	Channel	MHz					Scaled Factor	Meas. SAR	Scaled SAR
Body-Front (10mm)	9262	1852.4	WCDMA1900	/	/	/	/	/	/
	9400	1880.0	WCDMA1900	/	/	/	/	/	/
	9538	1907.6	WCDMA1900	1.612	22.17	22.30	1.030	0.531	0.547
Body-Back (10mm)	9262	1852.4	WCDMA1900	/	/	/	/	/	/
	9400	1880.0	WCDMA1900	/	/	/	/	/	/
	9538	1907.6	WCDMA1900	1.825	22.17	22.30	1.030	0.558	0.575
Body-Left (10mm)	9262	1852.4	WCDMA1900	/	/	/	/	/	/
	9400	1880.0	WCDMA1900	/	/	/	/	/	/
	9538	1907.6	WCDMA1900	-1.899	22.17	22.30	1.030	0.062	0.064
Body-Right (10mm)	9262	1852.4	WCDMA1900	/	/	/	/	/	/
	9400	1880.0	WCDMA1900	/	/	/	/	/	/
	9538	1907.6	WCDMA1900	1.986	22.17	22.30	1.030	0.392	0.404
Body-Bottom (10mm)	9262	1852.4	WCDMA1900	/	/	/	/	/	/
	9400	1880.0	WCDMA1900	/	/	/	/	/	/
	9538	1907.6	WCDMA1900	-3.998	22.17	22.30	1.030	0.075	0.077

Note:

1. When the 1-g SAR is ≤ 0.8 W/Kg, testing for other channels are optional.
2. The default test configuration is to measure SAR with an established radio link between the EUT and a communication test set using a 12.2 kbps RMC (reference measurement Channel) Configured in Test Loop Model.
3. KDB 941225 D01-Body SAR is not required for HSDPA when the maximum average output of each RF channel with HSDPA active is less than $\frac{1}{4}$ dB higher than measured without HSDPA using 12.2kbps RMC or the maximum SAR for 12.2kbps RMC is $< 75\%$ of SAR limit.
4. KDB 941225 D01-Body SAR is not required for HSUPA when the maximum average output of each RF channel with HSUPA active is less than $\frac{1}{4}$ dB higher than measured without HSUPA using 12.2kbps RMC and the maximum SAR for 12.2kbps RMC is $< 75\%$ of SAR limit.

SAR SIMULTANEOUS TRANSMISSION DESCRIPTION

KDB 447498D01 General RF Exposure Guidance v05r02

Stand-alone and simultaneous SAR evaluation for a cell phone with multiple transmitters is base on the antennas distance of each radio.

BT, WiFi, GSM and 3G Antenna Location:



Antenna Information:

Description of Simultaneous Transmit Capabilities			Antennas Distance (mm)
Transmitter Combination	Simultaneous?	Hotspot?	
GSM + GPRS	×	×	0
GSM + WCDMA	×	×	0
GSM + Bluetooth	√	×	72
GSM + WiFi	√	√	72
GPRS + WCDMA	×	×	0
GPRS + Bluetooth	√	×	0
GPRS + WiFi	√	√	72
WCDMA + Bluetooth	√	×	72
WCDMA + WiFi	√	√	72

Standalone SAR test exclusion considerations

Head Position:

Mode	Frequency (MHz)	P _{avg} (dBm)	P _{avg} (mW)	Distance (mm)	Calculated value	Threshold (1-g)	SAR Test Exclusion
GSM850	850	22.75	188.36	0	34.73	3.0	No
PCS1900	1900	19.33	85.70	0	23.63	3.0	No
WCDMSA850	850	22.67	184.93	0	34.10	3.0	No
WCDMSA1900	1900	22.17	164.82	0	45.44	3.0	No
WiFi	2450	9.48	8.87	0	2.78	3.0	Yes
Bluetooth	2450	9.00	7.94	0	2.49	3.0	Yes

Body Position:

Mode	Frequency (MHz)	P _{avg} (dBm)	P _{avg} (mW)	Distance (mm)	Calculated value	Threshold (1-g)	SAR Test Exclusion
GPRS850	850	22.72	187.07	10.00	17.25	3.0	No
GPRS1900	1900	20.72	118.03	10.00	16.27	3.0	No
WCDMSA850	850	22.67	184.93	10.00	17.05	3.0	No
WCDMSA1900	1900	22.17	164.82	10.00	22.72	3.0	No
WiFi	2450	9.48	8.87	10.00	1.39	3.0	Yes
Bluetooth	2450	9.00	7.94	10.00	1.24	3.0	Yes

The 1-g and 10-g SAR test exclusion thresholds for 100 MHz to 6 GHz at *test separation distances* ≤ 50 mm are determined by:

$[(\text{max. power of channel, including tune-up tolerance, mW}) / (\text{min. test separation distance, mm})] \cdot$

$[\sqrt{f(\text{GHz})}] \leq 3.0$ for 1-g SAR and ≤ 7.5 for 10-g extremity SAR, where

1. f(GHz) is the RF channel transmit frequency in GHz.
2. Power and distance are rounded to the nearest mW and mm before calculation.
3. The result is rounded to one decimal place for comparison.
4. When the minimum test separation distance is < 5 mm, a distance of 5 mm is applied to determine SAR test Exclusion.

Simultaneous SAR test exclusion considerations:

GSM with BT:

Mode	Position	Reported SAR (W/kg)		ΣSAR
		GSM	BT	< 1.6W/kg
GSM850	Left Head Cheek	0.186	0.332	0.518
	Left Head Tile	0.106	0.332	0.438
	Right Head Cheek	0.168	0.332	0.500
	Right Head Tilt	0.109	0.332	0.441
	Body-Headset-Front	0.084	0.166	0.250
	Body-Headset-Back	0.122	0.166	0.288
PCS1900	Left Head Cheek	0.212	0.332	0.544
	Left Head Tile	0.099	0.332	0.431
	Right Head Cheek	0.223	0.332	0.555
	Right Head Tilt	0.093	0.332	0.425
	Body-Headset-Front	0.265	0.166	0.431
	Body-Headset-Back	0.292	0.166	0.458

WCDMA with BT:

Mode	Position	Reported SAR (W/kg)		ΣSAR
		WCDMA	BT	< 1.6W/kg
WCDMA 850	Left Head Cheek	0.158	0.332	0.490
	Left Head Tile	0.093	0.332	0.425
	Right Head Cheek	0.168	0.332	0.500
	Right Head Tilt	0.097	0.332	0.429
	Body-Headset-Front	0.114	0.166	0.280
	Body-Headset-Back	0.185	0.166	0.351
WCDMA 1900	Left Head Cheek	0.339	0.332	0.671
	Left Head Tile	0.162	0.332	0.494
	Right Head Cheek	0.325	0.332	0.657
	Right Head Tilt	0.153	0.332	0.485
	Body-Headset-Front	0.547	0.166	0.713
	Body-Headset-Back	0.575	0.166	0.741

GSM with WiFi:

Mode	Position	Reported SAR (W/kg)		ΣSAR
		GSM	WiFi	< 1.6W/kg
GSM850	Left Head Cheek	0.186	0.371	0.557
	Left Head Tile	0.106	0.371	0.477
	Right Head Cheek	0.168	0.371	0.539
	Right Head Tilt	0.109	0.371	0.480
	Body-Headset-Front	0.084	0.186	0.270
	Body-Headset-Back	0.122	0.186	0.308
PCS1900	Left Head Cheek	0.212	0.371	0.583
	Left Head Tile	0.099	0.371	0.470
	Right Head Cheek	0.223	0.371	0.594
	Right Head Tilt	0.093	0.371	0.464
	Body-Headset-Front	0.265	0.186	0.451
	Body-Headset-Back	0.292	0.186	0.478

WCDMA with WiFi:

Mode	Position	Reported SAR (W/kg)		ΣSAR
		WCDMA	WiFi	< 1.6W/kg
WCDMA 850	Left Head Cheek	0.158	0.371	0.529
	Left Head Tile	0.093	0.371	0.464
	Right Head Cheek	0.168	0.371	0.539
	Right Head Tilt	0.097	0.371	0.468
	Body-Headset-Front	0.114	0.186	0.300
	Body-Headset-Back	0.185	0.186	0.371
WCDMA 1900	Left Head Cheek	0.339	0.371	0.710
	Left Head Tile	0.162	0.371	0.533
	Right Head Cheek	0.325	0.371	0.696
	Right Head Tilt	0.153	0.371	0.524
	Body-Headset-Front	0.547	0.186	0.733
	Body-Headset-Back	0.575	0.186	0.761

Mode	Frequency (GHz)	Distance (mm)	P _{avg} (dBm)	P _{avg} (mW)	Estimated 1-g (W/kg)
BT Head	2.45	0	9.00	7.94	0.332
BT Body	2.45	10	9.00	7.94	0.166
Wifi Head	2.45	0	9.48	8.87	0.371
Wifi Body	2.45	10	9.48	8.87	0.186

Note :

When standalone SAR test exclusion applies to an antenna that transmits simultaneously with other antennas, the standalone SAR must be estimated according to following to determine simultaneous transmission SAR test exclusion:

$[(\text{max. power of channel, including tune-up tolerance, mW})/(\text{min. test separation distance, mm})] \cdot [\sqrt{f(\text{GHz})}/x]$
W/kg for test separation distances ≤ 50 mm;

where $x = 7.5$ for 1-g SAR.

When the minimum test separation distance is < 5 mm, a distance of 5 mm is applied to determine SAR test Exclusion

Conclusion:

$\Sigma \text{SAR} < 1.6$ W/kg therefore simultaneous transmission SAR with Volume Scans is **not** required.

Hotspot:

Evaluations for Simultaneous SAR, Mobile Hot Spot Positions						
Test Position	Body-Front (1.0cm)	Body-Back (1.0cm)	Body-Left (1.0cm)	Body-Right (1.0cm)	Body-Bottom (1.0cm)	Body-Top (1.0cm)
Mode	Stand Alone 1-g SAR (W/Kg)					
GPRS 850	0.092	0.140	0.029	0.062	0.022	
GPRS 1900	0.277	0.295	0.091	0.116	0.048	
WCDMA850	0.114	0.185	0.013	0.085	0.014	
WCDMA 1900	0.547	0.575	0.064	0.404	0.077	
WiFi	0.186	0.186	0.186	/	/	0.186
	Σ 1-g SAR(W/Kg)					
GPRS850 + WiFi	0.278	0.326	0.215			
GPRS1900 + WiFi	0.463	0.481	0.277			
WCDMA850 + WiFi	0.300	0.371	0.199			
WCDMA 1900 + WiFi	0.733	0.761	0.250			

Note:

If the sum of the 1g SAR measured for the simultaneously transmitting antennas is less than the SAR limit, SAR measurement for simultaneous transmission is not required.

EUT SCAN RESULTS

Test Laboratory: Bay Area Compliance Lab Corp. (Shenzhen)

Left Head Cheek (824.2 MHz Low Channel)

Measurement Data

Test mode : GSM
 Crest Factor : 8
 Scan Type : Complete
 Area Scan : 11x8x1: Measurement x=10mm, y=10mm, z=4mm
 Zoom Scan : 7x7x7: Measurement x=5mm, y=5mm, z=5mm
 Power Drift-Start : 0.015 W/kg
 Power Drift-Finish : 0.015 W/kg
 Power Drift (%) : 1.259

Tissue Data

Type : Head
 Frequency : 824.2 MHz
 Epsilon : 41.04 F/m
 Sigma : 0.90 S/m
 Density : 1000.00 kg/cu. m

Probe Data

Serial No. : 500-00283
 Frequency Band : 835
 Duty Cycle Factor : 8
 Conversion Factor : 5.9
 Probe Sensitivity : 1.20 1.20 1.20 $\mu\text{V}/(\text{V}/\text{m})^2$
 Compression Point : 95.00 mV
 Offset : 1.56 mm

1 gram SAR value : 0.163 W/kg
 10 gram SAR value : 0.103 W/kg
 Area Scan Peak SAR : 0.175 W/kg
 Zoom Scan Peak SAR : 0.329 W/kg

Plot 1#

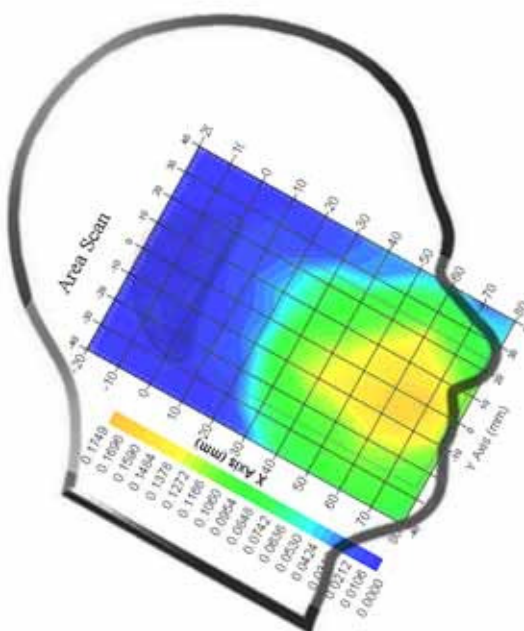

Test Laboratory: Bay Area Compliance Lab Corp. (Shenzhen)

Left Head Cheek (836.6 MHz Middle Channel)

Measurement Data

Test mode : GSM
 Crest Factor : 8
 Scan Type : Complete
 Area Scan : 11x8x1: Measurement x=10mm, y=10mm, z=4mm
 Zoom Scan : 7x7x7: Measurement x=5mm, y=5mm, z=5mm
 Power Drift-Start : 0.009 W/kg
 Power Drift-Finish : 0.009 W/kg
 Power Drift (%) : 0.813

Tissue Data

Type : Head
 Frequency : 836.6 MHz
 Epsilon : 41.03 F/m
 Sigma : 0.92 S/m
 Density : 1000.00 kg/cu. m

Probe Data

Serial No. : 500-00283
 Frequency Band : 835
 Duty Cycle Factor : 8
 Conversion Factor : 5.9
 Probe Sensitivity : 1.20 1.20 1.20 $\mu\text{V}/(\text{V}/\text{m})^2$
 Compression Point : 95.00 mV
 Offset : 1.56 mm

1 gram SAR value : 0.172 W/kg
 10 gram SAR value : 0.113 W/kg
 Area Scan Peak SAR : 0.188 W/kg
 Zoom Scan Peak SAR : 0.359 W/kg

Plot 2#

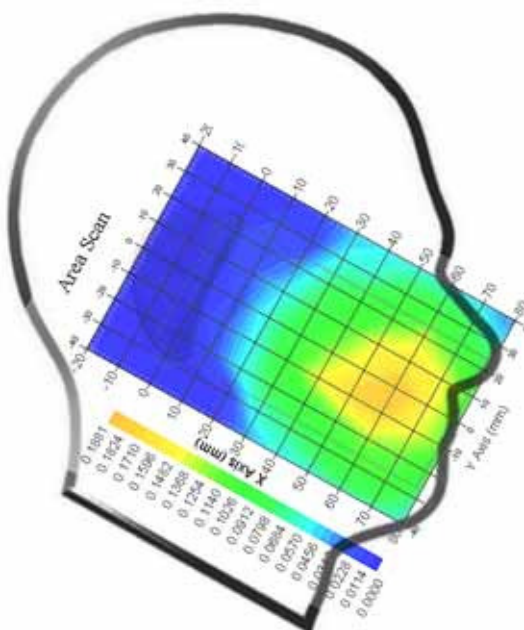

Test Laboratory: Bay Area Compliance Lab Corp. (Shenzhen)

Left Head Cheek (848.8 MHz High Channel)

Measurement Data

Test mode : GSM
 Crest Factor : 8
 Scan Type : Complete
 Area Scan : 11x8x1: Measurement x=10mm, y=10mm, z=4mm
 Zoom Scan : 7x7x7: Measurement x=5mm, y=5mm, z=5mm
 Power Drift-Start : 0.016 W/kg
 Power Drift-Finish : 0.016 W/kg
 Power Drift (%) : -2.148

Tissue Data

Type : Head
 Frequency : 848.8 MHz
 Epsilon : 41.04 F/m
 Sigma : 0.91 S/m
 Density : 1000.00 kg/cu. m

Probe Data

Serial No. : 500-00283
 Frequency Band : 835
 Duty Cycle Factor : 8
 Conversion Factor : 5.9
 Probe Sensitivity : 1.20 1.20 1.20 $\mu\text{V}/(\text{V}/\text{m})^2$
 Compression Point : 95.00 mV
 Offset : 1.56 mm

1 gram SAR value : 0.162 W/kg
 10 gram SAR value : 0.095 W/kg
 Area Scan Peak SAR : 0.174 W/kg
 Zoom Scan Peak SAR : 0.298 W/kg

Plot 3#

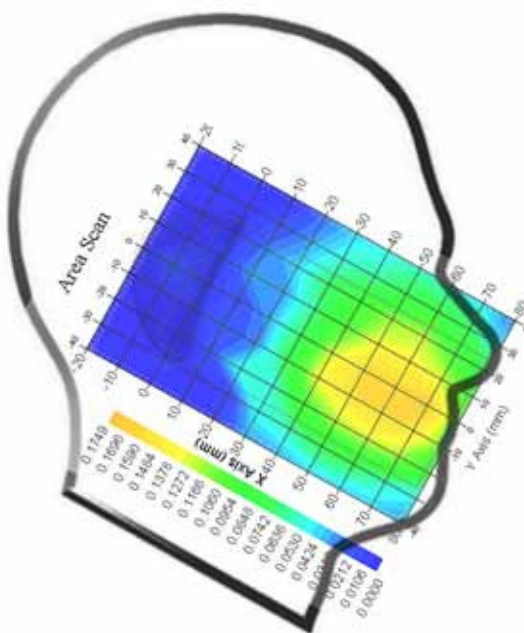

Test Laboratory: Bay Area Compliance Lab Corp. (Shenzhen)

Left Head Tilt (836.6 MHz Middle Channel)

Measurement Data

Test mode : GSM
 Crest Factor : 8
 Scan Type : Complete
 Area Scan : 11x8x1: Measurement x=10mm, y=10mm, z=4mm
 Zoom Scan : 7x7x7: Measurement x=5mm, y=5mm, z=5mm
 Power Drift-Start : 0.008 W/kg
 Power Drift-Finish : 0.008 W/kg
 Power Drift (%) : -1.129

Tissue Data

Type : Head
 Frequency : 836.6 MHz
 Epsilon : 41.03 F/m
 Sigma : 0.92 S/m
 Density : 1000.00 kg/cu. m

Probe Data

Serial No. : 500-00283
 Frequency Band : 835
 Duty Cycle Factor : 8
 Conversion Factor : 5.9
 Probe Sensitivity : 1.20 1.20 1.20 $\mu\text{V}/(\text{V}/\text{m})^2$
 Compression Point : 95.00 mV
 Offset : 1.56 mm

1 gram SAR value : 0.098 W/kg
 10 gram SAR value : 0.070 W/kg
 Area Scan Peak SAR : 0.110 W/kg
 Zoom Scan Peak SAR : 0.195 W/kg

Plot 4#

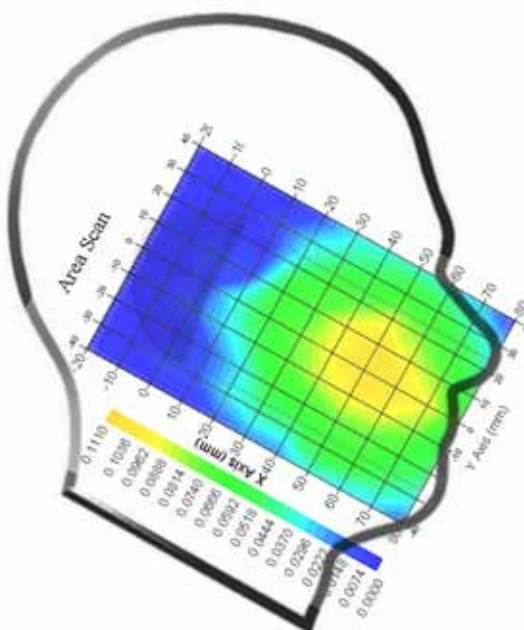

Test Laboratory: Bay Area Compliance Lab Corp. (Shenzhen)

Right Head Cheek (836.6 MHz Middle Channel)

Measurement Data

Test mode : GSM
 Crest Factor : 8
 Scan Type : Complete
 Area Scan : 11x8x1: Measurement x=10mm, y=10mm, z=4mm
 Zoom Scan : 7x7x7: Measurement x=5mm, y=5mm, z=5mm
 Power Drift-Start : 0.023 W/kg
 Power Drift-Finish : 0.023 W/kg
 Power Drift (%) : -0.372

Tissue Data

Type : Head
 Frequency : 836.6 MHz
 Epsilon : 41.03 F/m
 Sigma : 0.92 S/m
 Density : 1000.00 kg/cu. m

Probe Data

Serial No. : 500-00283
 Frequency Band : 835
 Duty Cycle Factor : 8
 Conversion Factor : 5.9
 Probe Sensitivity : 1.20 1.20 1.20 $\mu\text{V}/(\text{V}/\text{m})^2$
 Compression Point : 95.00 mV
 Offset : 1.56 mm

1 gram SAR value : 0.155 W/kg
 10 gram SAR value : 0.102 W/kg
 Area Scan Peak SAR : 0.191 W/kg
 Zoom Scan Peak SAR : 0.370 W/kg

Plot 5#

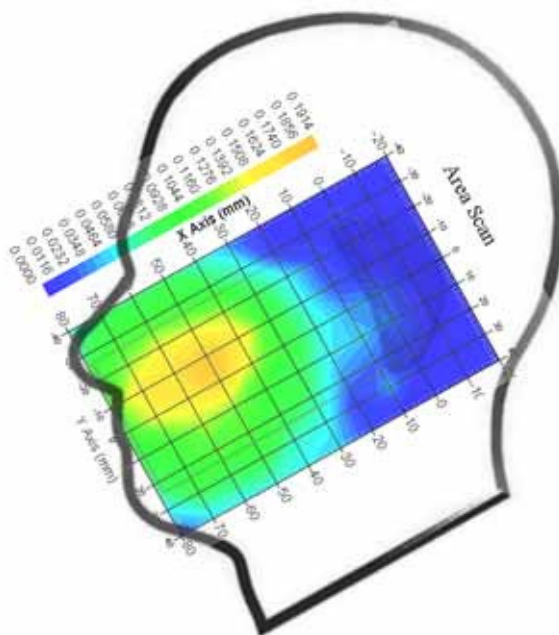

Test Laboratory: Bay Area Compliance Lab Corp. (Shenzhen)

Right Head Tilt (836.6 MHz Middle Channel)

Measurement Data

Test mode : GSM
 Crest Factor : 8
 Scan Type : Complete
 Area Scan : 11x8x1: Measurement x=10mm, y=10mm, z=4mm
 Zoom Scan : 7x7x7: Measurement x=5mm, y=5mm, z=5mm
 Power Drift-Start : 0.005 W/kg
 Power Drift-Finish : 0.005 W/kg
 Power Drift (%) : 1.027

Tissue Data

Type : Head
 Frequency : 836.6 MHz
 Epsilon : 41.03 F/m
 Sigma : 0.92 S/m
 Density : 1000.00 kg/cu. m

Probe Data

Serial No. : 500-00283
 Frequency Band : 835
 Duty Cycle Factor : 8
 Conversion Factor : 5.9
 Probe Sensitivity : 1.20 1.20 1.20 $\mu\text{V}/(\text{V}/\text{m})^2$
 Compression Point : 95.00 mV
 Offset : 1.56 mm

1 gram SAR value : 0.101 W/kg
 10 gram SAR value : 0.073 W/kg
 Area Scan Peak SAR : 0.115 W/kg
 Zoom Scan Peak SAR : 0.162 W/kg

Plot 6#

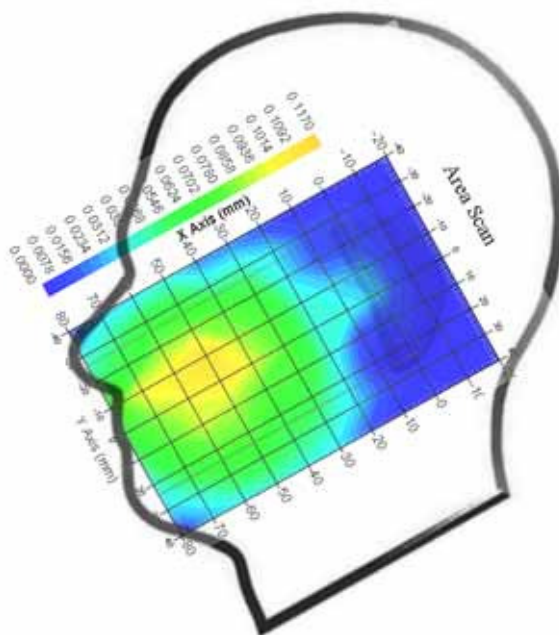

Test Laboratory: Bay Area Compliance Lab Corp. (Shenzhen)

Body-worn Front-Headset (836.6 MHz Middle Channel)

Measurement Data

Test mode : GSM
 Crest Factor : 8
 Scan Type : Complete
 Area Scan : 8x11x1 : Measurement x=10mm, y=10mm, z=4mm
 Zoom Scan : 7x7x7 : Measurement x=5mm, y=5mm, z=5mm
 Power Drift-Start : 0.052 W/kg
 Power Drift-Finish : 0.053 W/kg
 Power Drift (%) : 1.759

Tissue Data

Type : Body
 Frequency : 836.6 MHz
 Epsilon : 53.85 F/m
 Sigma : 0.96 S/m
 Density : 1000.00 kg/cu. m

Probe Data

Serial No. : 500-00283
 Frequency Band : 835
 Duty Cycle Factor : 8
 Conversion Factor : 5.9
 Probe Sensitivity : 1.20 1.20 1.20 $\mu\text{V}/(\text{V}/\text{m})^2$
 Compression Point : 95.00 mV
 Offset : 1.56 mm

1 gram SAR value : 0.078 W/kg
 10 gram SAR value : 0.046 W/kg
 Area Scan Peak SAR : 0.080 W/kg
 Zoom Scan Peak SAR : 0.127 W/kg

Plot 7#

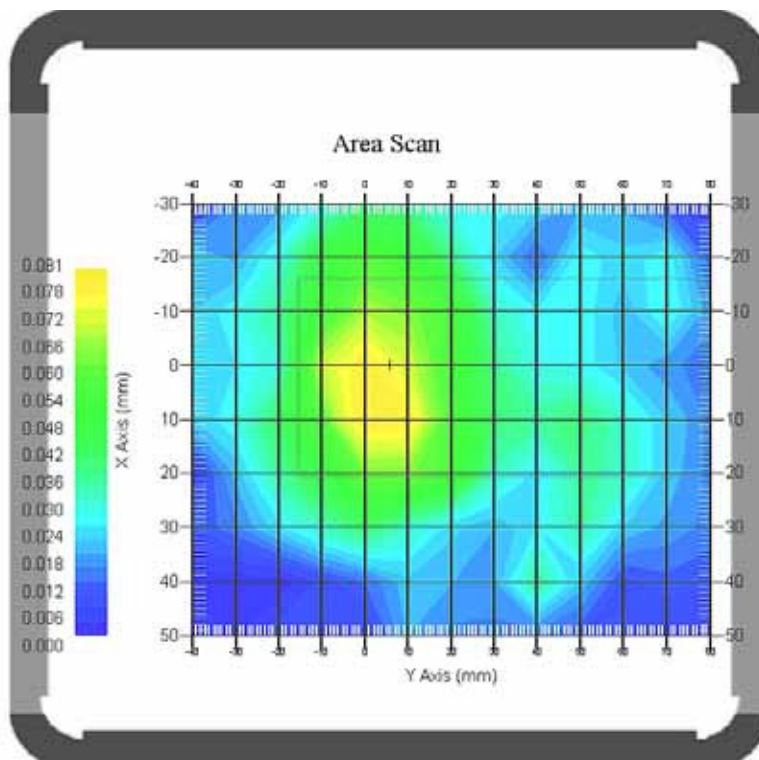

Test Laboratory: Bay Area Compliance Lab Corp. (Shenzhen)

Body-worn Back-Headset (836.6 MHz Middle Channel)

Measurement Data

Test mode : GSM
 Crest Factor : 8
 Scan Type : Complete
 Area Scan : 8x11x1 : Measurement x=10mm, y=10mm, z=4mm
 Zoom Scan : 7x7x7 : Measurement x=5mm, y=5mm, z=5mm
 Power Drift-Start : 0.105 W/kg
 Power Drift-Finish : 0.103 W/kg
 Power Drift (%) : -1.902

Tissue Data

Type : Body
 Frequency : 836.6 MHz
 Epsilon : 53.85 F/m
 Sigma : 0.96 S/m
 Density : 1000.00 kg/cu. m

Probe Data

Serial No. : 500-00283
 Frequency Band : 835
 Duty Cycle Factor : 8
 Conversion Factor : 5.9
 Probe Sensitivity : 1.20 1.20 1.20 $\mu\text{V}/(\text{V}/\text{m})^2$
 Compression Point : 95.00 mV
 Offset : 1.56 mm

1 gram SAR value : 0.113 W/kg
 10 gram SAR value : 0.072 W/kg
 Area Scan Peak SAR : 0.121 W/kg
 Zoom Scan Peak SAR : 0.250 W/kg

Plot 8#

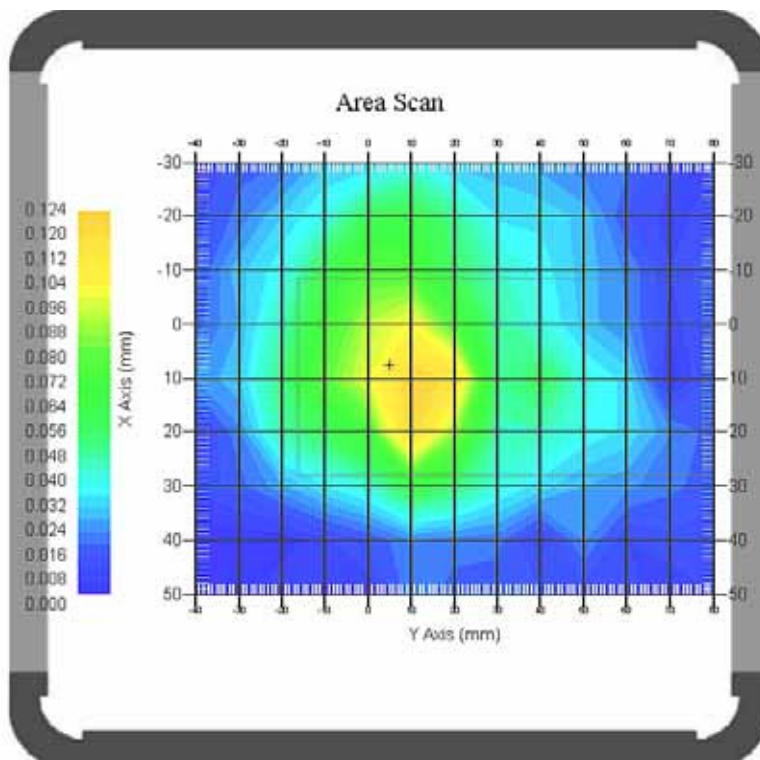

Test Laboratory: Bay Area Compliance Lab Corp. (Shenzhen)

Left Head Cheek(1880 MHz Middle Channel)

Measurement Data

Test mode : GSM
 Crest Factor : 8
 Scan Type : Complete
 Area Scan : 11x8x1 : Measurement x=10mm, y=10mm, z=4mm
 Zoom Scan : 7x7x7 : Measurement x=5mm, y=5mm, z=5mm
 Power Drift-Start : 0.023 W/kg
 Power Drift-Finish : 0.023 W/kg
 Power Drift (%) : -0.997

Tissue Data

Type : Head
 Frequency : 1880 MHz
 Epsilon : 39.67 F/m
 Sigma : 1.39 S/m
 Density : 1000.00 kg/cu. M

Probe Data

Serial No. : 500-00283
 Frequency Band : 1900
 Duty Cycle Factor : 8
 Conversion Factor : 4.8
 Probe Sensitivity : 1.20 1.20 1.20 $\mu\text{V}/(\text{V/m})^2$
 Compression Point : 95.00 mV
 Offset : 1.56 mm

1 gram SAR value : 0.201 W/kg
 10 gram SAR value : 0.126 W/kg
 Area Scan Peak SAR : 0.220 W/kg
 Zoom Scan Peak SAR : 0.362 W/kg

Plot 9#

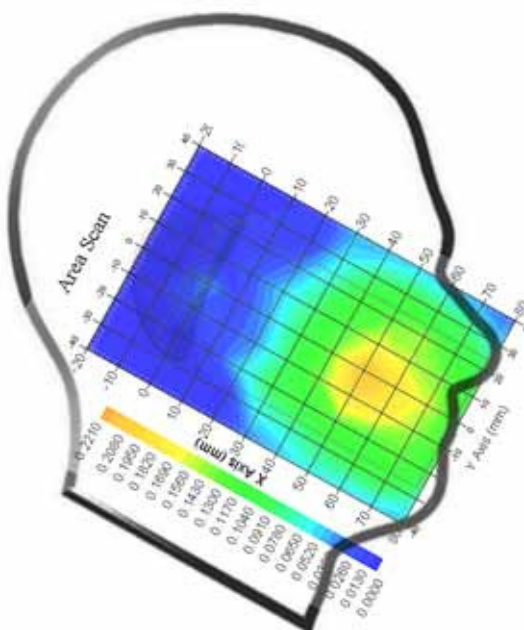

Test Laboratory: Bay Area Compliance Lab Corp. (Shenzhen)

Left Head Tilt(1880 MHz Middle Channel)

Measurement Data

Test mode : GSM
 Crest Factor : 8
 Scan Type : Complete
 Area Scan : 11x8x1 : Measurement x=10mm, y=10mm, z=4mm
 Zoom Scan : 7x7x7 : Measurement x=5mm, y=5mm, z=5mm
 Power Drift-Start : 0.019 W/kg
 Power Drift-Finish : 0.019 W/kg
 Power Drift (%) : 1.091

Tissue Data

Type : Head
 Frequency : 1880 MHz
 Epsilon : 39.67 F/m
 Sigma : 1.39 S/m
 Density : 1000.00 kg/cu. M

Probe Data

Serial No. : 500-00283
 Frequency Band : 1900
 Duty Cycle Factor : 8
 Conversion Factor : 4.8
 Probe Sensitivity : 1.20 1.20 1.20 $\mu\text{V}/(\text{V/m})^2$
 Compression Point : 95.00 mV
 Offset : 1.56 mm

1 gram SAR value : 0.094 W/kg
 10 gram SAR value : 0.059 W/kg
 Area Scan Peak SAR : 0.103 W/kg
 Zoom Scan Peak SAR : 0.172 W/kg

Plot 10#

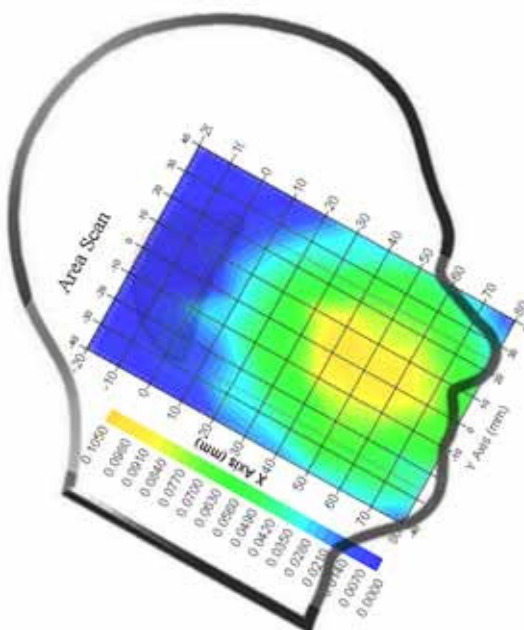

Test Laboratory: Bay Area Compliance Lab Corp. (Shenzhen)

Right Head Cheek (1850.2 MHz Low Channel)

Measurement Data

Test mode : GSM
 Crest Factor : 8
 Scan Type : Complete
 Area Scan : 11x8x1 : Measurement x=10mm, y=10mm, z=4mm
 Zoom Scan : 7x7x7 : Measurement x=5mm, y=5mm, z=5mm
 Power Drift-Start : 0.005 W/kg
 Power Drift-Finish : 0.005 W/kg
 Power Drift (%) : -3.647

Tissue Data

Type : Head
 Frequency : 1850.2 MHz
 Epsilon : 39.74 F/m
 Sigma : 1.38 S/m
 Density : 1000.00 kg/cu. m

Probe Data

Serial No. : 500-00283
 Frequency Band : 1900
 Duty Cycle Factor : 8
 Conversion Factor : 4.8
 Probe Sensitivity : 1.20 1.20 1.20 $\mu\text{V}/(\text{V/m})^2$
 Compression Point : 95.00 mV
 Offset : 1.56 mm

1 gram SAR value : 0.194 W/kg
 10 gram SAR value : 0.118 W/kg
 Area Scan Peak SAR : 0.210 W/kg
 Zoom Scan Peak SAR : 0.379 W/kg

Plot 13#

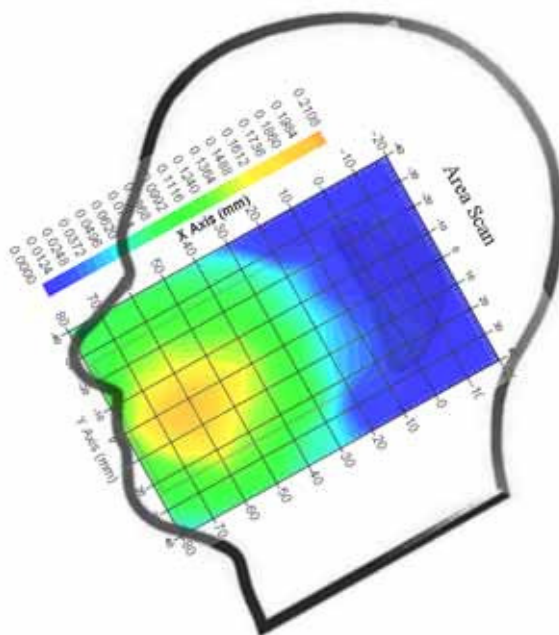

Test Laboratory: Bay Area Compliance Lab Corp. (Shenzhen)

Right Head Cheek (1880 MHz Middle Channel)

Measurement Data

Test mode : GSM
 Crest Factor : 8
 Scan Type : Complete
 Area Scan : 11x8x1 : Measurement x=10mm, y=10mm, z=4mm
 Zoom Scan : 7x7x7 : Measurement x=5mm, y=5mm, z=5mm
 Power Drift-Start : 0.011 W/kg
 Power Drift-Finish : 0.011 W/kg
 Power Drift (%) : -0.769

Tissue Data

Type : Head
 Frequency : 1880 MHz
 Epsilon : 39.67 F/m
 Sigma : 1.39 S/m
 Density : 1000.00 kg/cu. M

Probe Data

Serial No. : 500-00283
 Frequency Band : 1900
 Duty Cycle Factor : 8
 Conversion Factor : 4.8
 Probe Sensitivity : 1.20 1.20 1.20 $\mu\text{V}/(\text{V}/\text{m})^2$
 Compression Point : 95.00 mV
 Offset : 1.56 mm

1 gram SAR value : 0.211 W/kg
 10 gram SAR value : 0.130 W/kg
 Area Scan Peak SAR : 0.242 W/kg
 Zoom Scan Peak SAR : 0.403 W/kg

Plot 12#

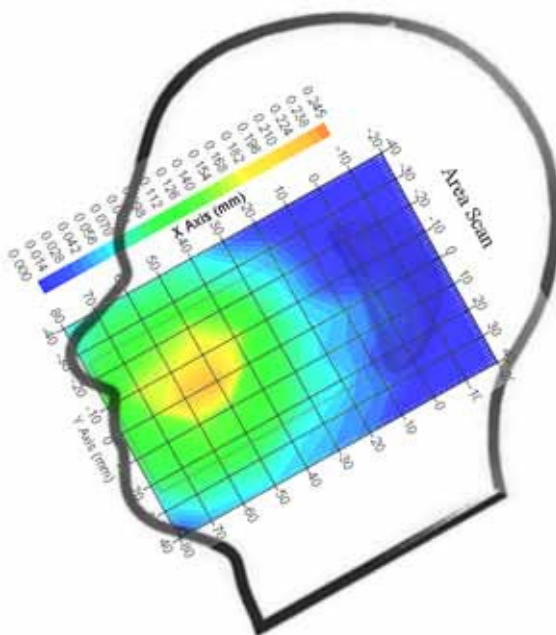

Test Laboratory: Bay Area Compliance Lab Corp. (Shenzhen)

Right Head Cheek (1909.8 MHz High Channel)

Measurement Data

Test mode : GSM
 Crest Factor : 8
 Scan Type : Complete
 Area Scan : 11x8x1 : Measurement x=10mm, y=10mm, z=4mm
 Zoom Scan : 7x7x7 : Measurement x=5mm, y=5mm, z=5mm
 Power Drift-Start : 0.013 W/kg
 Power Drift-Finish : 0.013 W/kg
 Power Drift (%) : 1.426

Tissue Data

Type : Head
 Frequency : 1909.8 MHz
 Epsilon : 39.58 F/m
 Sigma : 1.42 S/m
 Density : 1000.00 kg/cu. m

Probe Data

Serial No. : 500-00283
 Frequency Band : 1900
 Duty Cycle Factor : 8
 Conversion Factor : 4.8
 Probe Sensitivity : 1.20 1.20 1.20 $\mu\text{V}/(\text{V}/\text{m})^2$
 Compression Point : 95.00 mV
 Offset : 1.56 mm

1 gram SAR value : 0.189 W/kg
 10 gram SAR value : 0.109 W/kg
 Area Scan Peak SAR : 0.201W/kg
 Zoom Scan Peak SAR : 0.324 W/kg

Plot 13#

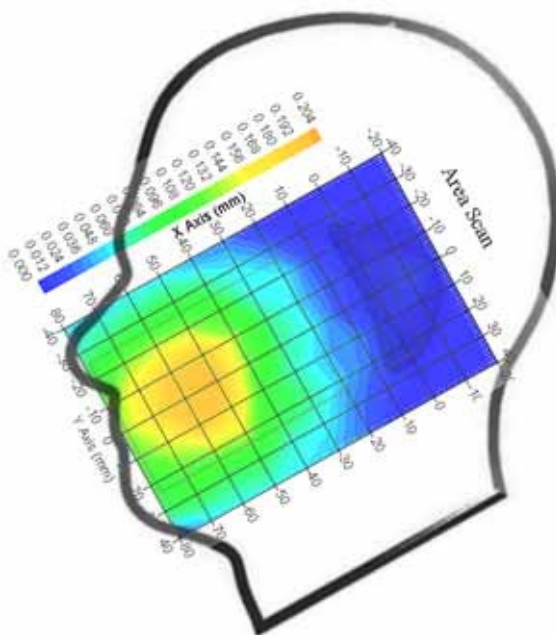

Test Laboratory: Bay Area Compliance Lab Corp. (Shenzhen)

Right Head Tilt (1880 MHz Middle Channel)

Measurement Data

Test mode : GSM
 Crest Factor : 8
 Scan Type : Complete
 Area Scan : 11x8x1 : Measurement x=10mm, y=10mm, z=4mm
 Zoom Scan : 7x7x7 : Measurement x=5mm, y=5mm, z=5mm
 Power Drift-Start : 0.002 W/kg
 Power Drift-Finish : 0.002 W/kg
 Power Drift (%) : -2.867

Tissue Data

Type : Head
 Frequency : 1880 MHz
 Epsilon : 39.67 F/m
 Sigma : 1.39 S/m
 Density : 1000.00 kg/cu. m

Probe Data

Serial No. : 500-00283
 Frequency Band : 1900
 Duty Cycle Factor : 8
 Conversion Factor : 4.8
 Probe Sensitivity : 1.20 1.20 1.20 $\mu\text{V}/(\text{V}/\text{m})^2$
 Compression Point : 95.00 mV
 Offset : 1.56 mm

1 gram SAR value : 0.088 W/kg
 10 gram SAR value : 0.057 W/kg
 Area Scan Peak SAR : 0.098 W/kg
 Zoom Scan Peak SAR : 0.132 W/kg

Plot 14#

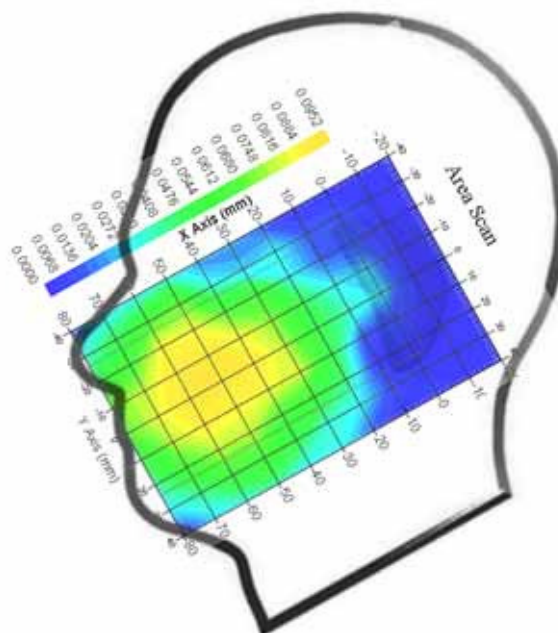

Test Laboratory: Bay Area Compliance Lab Corp. (Shenzhen)

Body-worn Front-Headset (1880 MHz Middle Channel)

Measurement Data

Test mode : GSM
 Crest Factor : 8
 Scan Type : Complete
 Area Scan : 8x11x1 : Measurement x=10mm, y=10mm, z=4mm
 Zoom Scan : 7x7x7 : Measurement x=5mm, y=5mm, z=5mm
 Power Drift-Start : 0.215 W/kg
 Power Drift-Finish : 0.209 W/kg
 Power Drift (%) : -2.807

Tissue Data

Type : Body
 Frequency : 1880 MHz
 Epsilon : 51.85 F/m
 Sigma : 1.52 S/m
 Density : 1000.00 kg/cu. m

Probe Data

Serial No. : 500-00283
 Frequency Band : 1900
 Duty Cycle Factor : 8
 Conversion Factor : 4.5
 Probe Sensitivity : 1.20 1.20 1.20 $\mu\text{V}/(\text{V}/\text{m})^2$
 Compression Point : 95.00 mV
 Offset : 1.56 mm

1 gram SAR value : 0.251 W/kg
 10 gram SAR value : 0.149 W/kg
 Area Scan Peak SAR : 0.284 W/kg
 Zoom Scan Peak SAR : 0.452 W/kg

Plot 15#

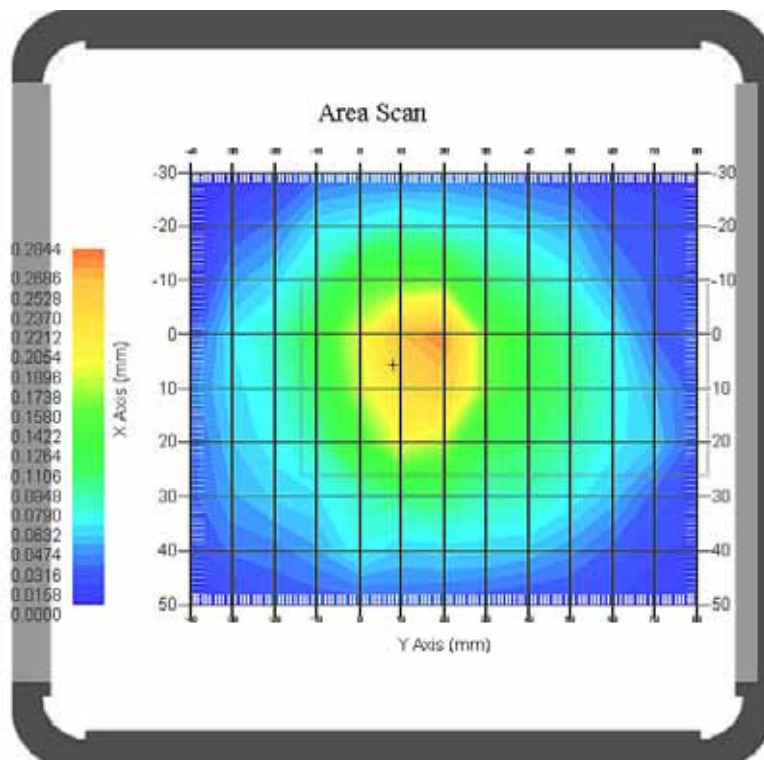

Test Laboratory: Bay Area Compliance Lab Corp. (Shenzhen)

Body-worn Back- Headset (1880 MHz Middle Channel)

Measurement Data

Test mode : GSM
 Crest Factor : 8
 Scan Type : Complete
 Area Scan : 8x11x1 : Measurement x=10mm, y=10mm, z=4mm
 Zoom Scan : 7x7x7 : Measurement x=5mm, y=5mm, z=5mm
 Power Drift-Start : 0.239 W/kg
 Power Drift-Finish : 0.242 W/kg
 Power Drift (%) : 1.328

Tissue Data

Type : Body
 Frequency : 1880 MHz
 Epsilon : 51.85 F/m
 Sigma : 1.52 S/m
 Density : 1000.00 kg/cu. m

Probe Data

Serial No. : 500-00283
 Frequency Band : 1900
 Duty Cycle Factor : 8
 Conversion Factor : 4.5
 Probe Sensitivity : 1.20 1.20 1.20 $\mu\text{V}/(\text{V}/\text{m})^2$
 Compression Point : 95.00 mV
 Offset : 1.56 mm

1 gram SAR value : 0.276 W/kg
 10 gram SAR value : 0.162 W/kg
 Area Scan Peak SAR : 0.297 W/kg
 Zoom Scan Peak SAR : 0.495 W/kg

Plot 16#

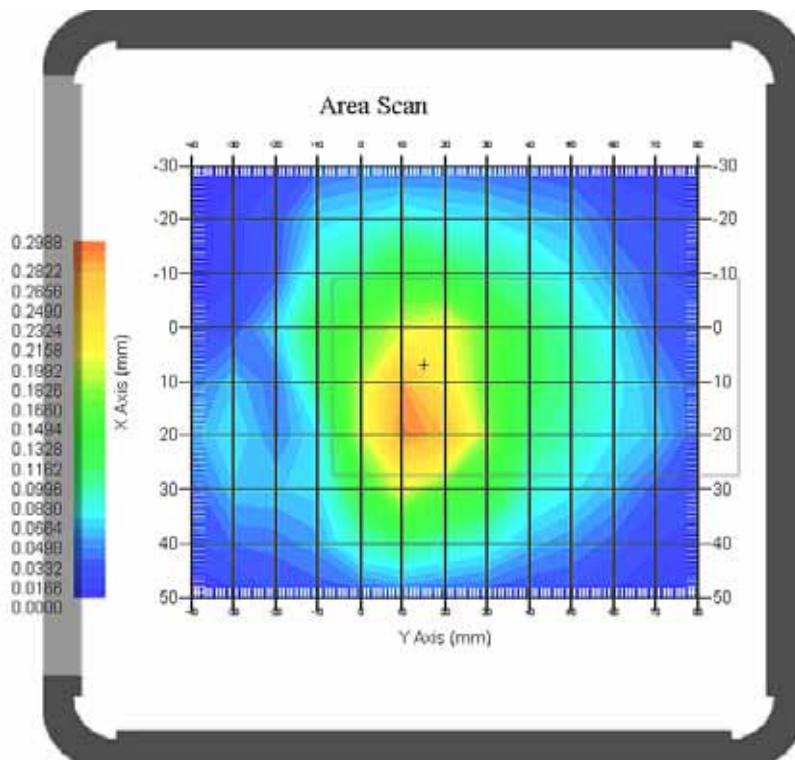

Test Laboratory: Bay Area Compliance Lab Corp. (Shenzhen)

WCDMA850; Left Head Cheek (826.4 MHz Low Channel)

Measurement Data

Test mode : WCDMA850
 Crest Factor : 1
 Scan Type : Complete
 Area Scan : 11x8x1: Measurement x=10mm, y=10mm, z=4mm
 Zoom Scan : 7x7x7: Measurement x=5mm, y=5mm, z=5mm
 Power Drift-Start : 0.002 W/kg
 Power Drift-Finish : 0.002 W/kg
 Power Drift (%) : 1.485

Tissue Data

Type : Head
 Frequency : 826.4 MHz
 Epsilon : 41.08 F/m
 Sigma : 0.91 S/m
 Density : 1000.00 kg/cu. m

Probe Data

Serial No. : 500-00283
 Frequency Band : 835
 Duty Cycle Factor : 1
 Conversion Factor : 5.9
 Probe Sensitivity : 1.20 1.20 1.20 $\mu\text{V}/(\text{V}/\text{m})^2$
 Compression Point : 95.00 mV
 Offset : 1.56 mm

1 gram SAR value : 0.146 W/kg
 10 gram SAR value : 0.086 W/kg
 Area Scan Peak SAR : 0.162 W/kg
 Zoom Scan Peak SAR : 0.318 W/kg

Plot 17#

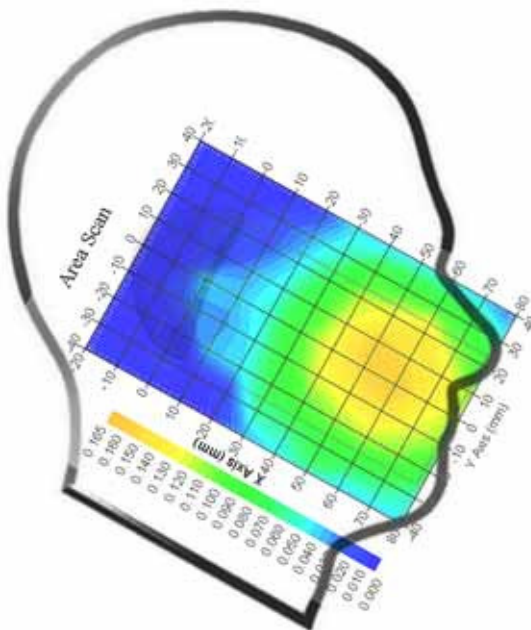

Test Laboratory: Bay Area Compliance Lab Corp. (Shenzhen)

WCDMA850; Left Head Tilt (826.4 MHz Low Channel)

Measurement Data

Test mode : WCDMA850
 Crest Factor : 1
 Scan Type : Complete
 Area Scan : 11x8x1: Measurement x=10mm, y=10mm, z=4mm
 Zoom Scan : 7x7x7: Measurement x=5mm, y=5mm, z=5mm
 Power Drift-Start : 0.002 W/kg
 Power Drift-Finish : 0.002 W/kg
 Power Drift (%) : 2.907

Tissue Data

Type : Head
 Frequency : 826.4 MHz
 Epsilon : 41.08 F/m
 Sigma : 0.91 S/m
 Density : 1000.00 kg/cu. m

Probe Data

Serial No. : 500-00283
 Frequency Band : 835
 Duty Cycle Factor : 1
 Conversion Factor : 5.9
 Probe Sensitivity : 1.20 1.20 1.20 $\mu\text{V}/(\text{V/m})^2$
 Compression Point : 95.00 mV
 Offset : 1.56 mm

1 gram SAR value : 0.086 W/kg
 10 gram SAR value : 0.055 W/kg
 Area Scan Peak SAR : 0.094 W/kg
 Zoom Scan Peak SAR : 0.139 W/kg

Plot 18#

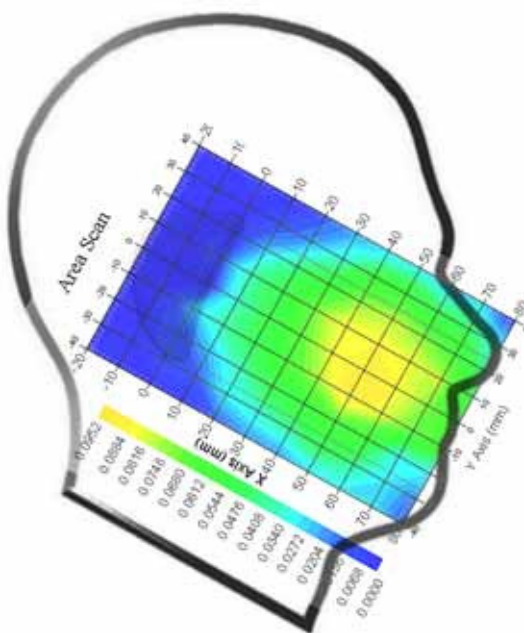

Test Laboratory: Bay Area Compliance Lab Corp. (Shenzhen)

WCDMA850; Right Head Cheek (826.4 MHz Low Channel)

Measurement Data

Test mode : WCDMA850
 Crest Factor : 1
 Scan Type : Complete
 Area Scan : 11x8x1: Measurement x=10mm, y=10mm, z=4mm
 Zoom Scan : 7x7x7: Measurement x=5mm, y=5mm, z=5mm
 Power Drift-Start : 0.012 W/kg
 Power Drift-Finish : 0.012 W/kg
 Power Drift (%) : 1.065

Tissue Data

Type : Head
 Frequency : 826.4 MHz
 Epsilon : 41.08 F/m
 Sigma : 0.91 S/m
 Density : 1000.00 kg/cu. m

Probe Data

Serial No. : 500-00283
 Frequency Band : 835
 Duty Cycle Factor : 1
 Conversion Factor : 5.9
 Probe Sensitivity : 1.20 1.20 1.20 $\mu\text{V}/(\text{V}/\text{m})^2$
 Compression Point : 95.00 mV
 Offset : 1.56 mm

1 gram SAR value : 0.156 W/kg
 10 gram SAR value : 0.102 W/kg
 Area Scan Peak SAR : 0.181 W/kg
 Zoom Scan Peak SAR : 0.345 W/kg

Plot 19#

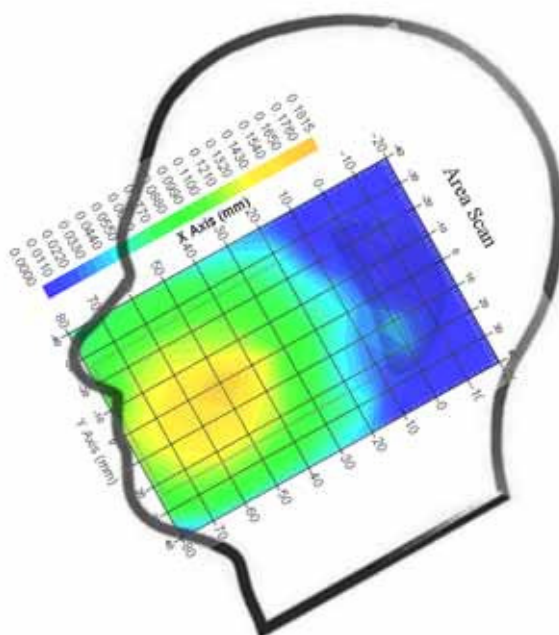

Test Laboratory: Bay Area Compliance Lab Corp. (Shenzhen)

WCDMA850; Right Head Tilt (826.4 MHz Low Channel)

Measurement Data

Test mode : WCDMA850
 Crest Factor : 1
 Scan Type : Complete
 Area Scan : 11x8x1: Measurement x=10mm, y=10mm, z=4mm
 Zoom Scan : 7x7x7: Measurement x=5mm, y=5mm, z=5mm
 Power Drift-Start : 0.002 W/kg
 Power Drift-Finish : 0.002 W/kg
 Power Drift (%) : -0.437

Tissue Data

Type : Head
 Frequency : 826.4 MHz
 Epsilon : 41.08 F/m
 Sigma : 0.91 S/m
 Density : 1000.00 kg/cu. m

Probe Data

Serial No. : 500-00283
 Frequency Band : 835
 Duty Cycle Factor : 1
 Conversion Factor : 5.9
 Probe Sensitivity : 1.20 1.20 1.20 $\mu\text{V}/(\text{V/m})^2$
 Compression Point : 95.00 mV
 Offset : 1.56 mm

1 gram SAR value : 0.090 W/kg
 10 gram SAR value : 0.058 W/kg
 Area Scan Peak SAR : 0.096 W/kg
 Zoom Scan Peak SAR : 0.157 W/kg

Plot 20#

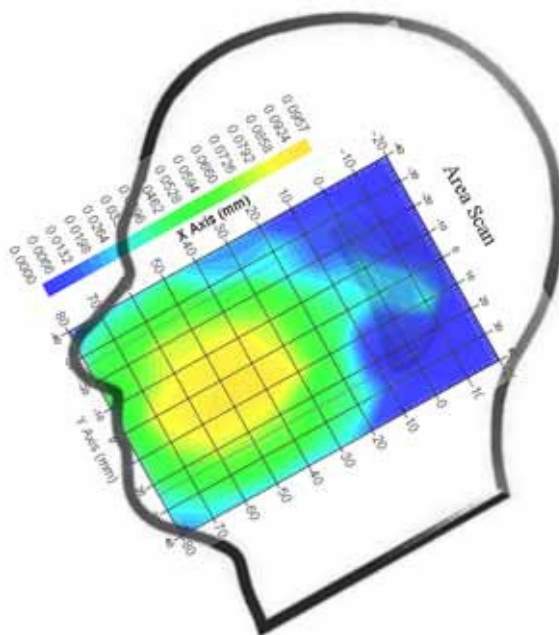

Test Laboratory: Bay Area Compliance Lab Corp. (Shenzhen)

WCDMA1900; Left Head Cheek (1907.6 MHz High Channel)

Measurement Data

Test mode : WCDMA1900
 Crest Factor : 1
 Scan Type : Complete
 Area Scan : 11x9x1: Measurement x=10mm, y=10mm, z=4mm
 Zoom Scan : 7x7x7: Measurement x=5mm, y=5mm, z=5mm
 Power Drift-Start : 0.005 W/kg
 Power Drift-Finish : 0.005 W/kg
 Power Drift (%) : 1.848

Tissue Data

Type : Head
 Frequency : 1907.6 MHz
 Epsilon : 39.57 F/m
 Sigma : 1.42 S/m
 Density : 1000.00 kg/cu. m

Probe Data

Serial No. : 500-00283
 Frequency Band : 1900
 Duty Cycle Factor : 1
 Conversion Factor : 4.8
 Probe Sensitivity : 1.20 1.20 1.20 $\mu\text{V}/(\text{V}/\text{m})^2$
 Compression Point : 95.00 mV
 Offset : 1.56 mm

1 gram SAR value : 0.329 W/kg
 10 gram SAR value : 0.198 W/kg
 Area Scan Peak SAR : 0.352 W/kg
 Zoom Scan Peak SAR : 0.529 W/kg

Plot 21#

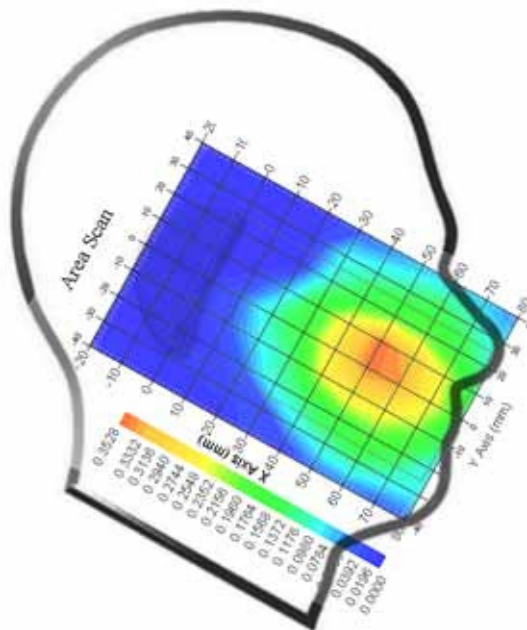

Test Laboratory: Bay Area Compliance Lab Corp. (Shenzhen)

WCDMA1900; Left Head Tilt (1907.6MHz High Channel)

Measurement Data

Test mode : WCDMA1900
 Crest Factor : 1
 Scan Type : Complete
 Area Scan : 11x9x1: Measurement x=10mm, y=10mm, z=4mm
 Zoom Scan : 7x7x7: Measurement x=5mm, y=5mm, z=5mm
 Power Drift-Start : 0.002 W/kg
 Power Drift-Finish : 0.002 W/kg
 Power Drift (%) : -0.681

Tissue Data

Type : Head
 Frequency : 1907.6 MHz
 Epsilon : 39.57 F/m
 Sigma : 1.42 S/m
 Density : 1000.00 kg/cu. m

Probe Data

Serial No. : 500-00283
 Frequency Band : 1900
 Duty Cycle Factor : 1
 Conversion Factor : 4.8
 Probe Sensitivity : 1.20 1.20 1.20 $\mu\text{V}/(\text{V}/\text{m})^2$
 Compression Point : 95.00 mV
 Offset : 1.56 mm

1 gram SAR value : 0.157 W/kg
 10 gram SAR value : 0.100 W/kg
 Area Scan Peak SAR : 0.178 W/kg
 Zoom Scan Peak SAR : 0.295 W/kg

Plot 22#

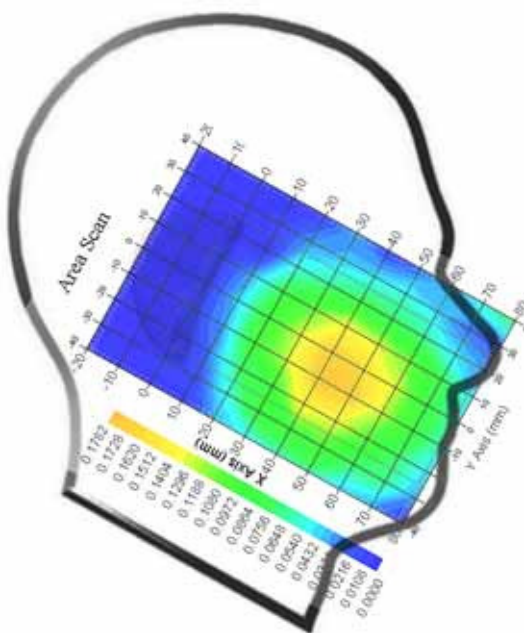

Test Laboratory: Bay Area Compliance Lab Corp. (Shenzhen)

WCDMA1900; Right Head Cheek (1907.6 MHz High Channel)

Measurement Data

Test mode : WCDMA1900
 Crest Factor : 1
 Scan Type : Complete
 Area Scan : 11x9x1: Measurement x=10mm, y=10mm, z=4mm
 Zoom Scan : 7x7x7: Measurement x=5mm, y=5mm, z=5mm
 Power Drift-Start : 0.012 W/kg
 Power Drift-Finish : 0.012 W/kg
 Power Drift (%) : 1.392

Tissue Data

Type : Head
 Frequency : 1907.6 MHz
 Epsilon : 39.57 F/m
 Sigma : 1.42 S/m
 Density : 1000.00 kg/cu. m

Probe Data

Serial No. : 500-00283
 Frequency Band : 1900
 Duty Cycle Factor : 1
 Conversion Factor : 4.8
 Probe Sensitivity : 1.20 1.20 1.20 $\mu\text{V}/(\text{V}/\text{m})^2$
 Compression Point : 95.00 mV
 Offset : 1.56 mm

1 gram SAR value : 0.316 W/kg
 10 gram SAR value : 0.187 W/kg
 Area Scan Peak SAR : 0.335 W/kg
 Zoom Scan Peak SAR : 0.491 W/kg

Plot 25#

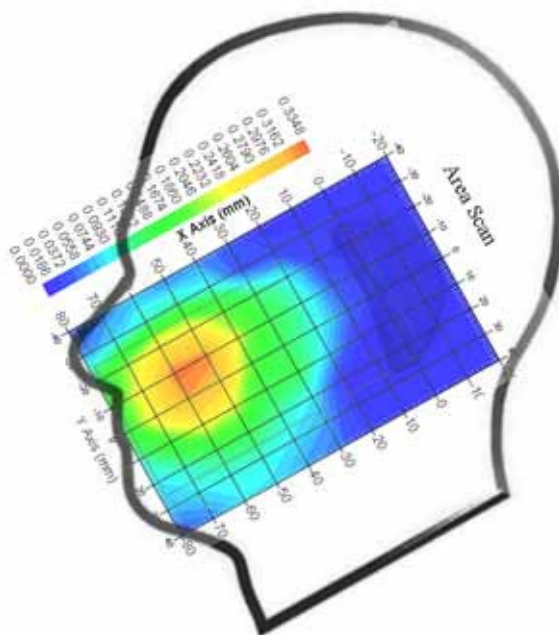

Test Laboratory: Bay Area Compliance Lab Corp. (Shenzhen)

WCDMA1900; Right Head Tilt (1907.6 MHz High Channel)

Measurement Data

Test mode : WCDMA1900
 Crest Factor : 1
 Scan Type : Complete
 Area Scan : 11x9x1: Measurement x=10mm, y=10mm, z=4mm
 Zoom Scan : 7x7x7: Measurement x=5mm, y=5mm, z=5mm
 Power Drift-Start : 0.006 W/kg
 Power Drift-Finish : 0.006 W/kg
 Power Drift (%) : 1.114

Tissue Data

Type : Head
 Frequency : 1907.6 MHz
 Epsilon : 39.57 F/m
 Sigma : 1.42 S/m
 Density : 1000.00 kg/cu. m

Probe Data

Serial No. : 500-00283
 Frequency Band : 1900
 Duty Cycle Factor : 1
 Conversion Factor : 4.8
 Probe Sensitivity : 1.20 1.20 1.20 $\mu\text{V}/(\text{V}/\text{m})^2$
 Compression Point : 95.00 mV
 Offset : 1.56 mm

1 gram SAR value : 0.149 W/kg
 10 gram SAR value : 0.097 W/kg
 Area Scan Peak SAR : 0.168 W/kg
 Zoom Scan Peak SAR : 0.302 W/kg

Plot 24#

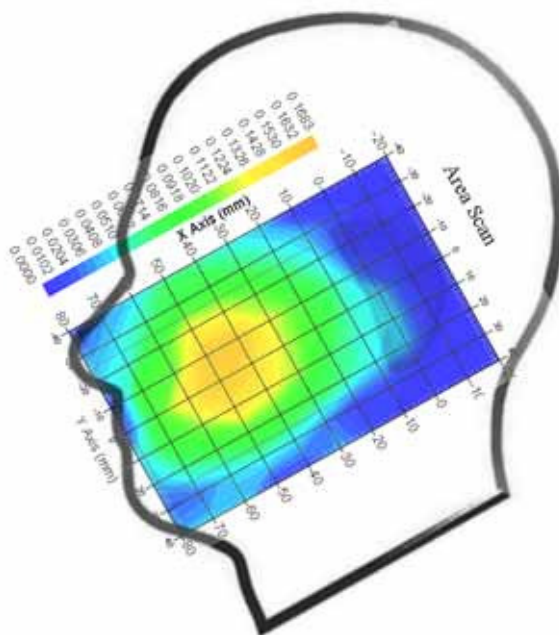

Test Laboratory: Bay Area Compliance Lab Corp. (Shenzhen)

Body-worn-Front (848.8 MHz High Channel)

Measurement Data

Test mode : GPRS
 Crest Factor : 2.67
 Scan Type : Complete
 Area Scan : 8x11x1 : Measurement x=10mm, y=10mm, z=4mm
 Zoom Scan : 7x7x7 : Measurement x=5mm, y=5mm, z=5mm
 Power Drift-Start : 0.072 W/kg
 Power Drift-Finish : 0.073 W/kg
 Power Drift (%) : 1.529

Tissue Data

Type : Body
 Frequency : 848.8 MHz
 Epsilon : 53.87 F/m
 Sigma : 0.98 S/m
 Density : 1000.00 kg/cu. m

Probe Data

Serial No. : 500-00283
 Frequency Band : 835
 Duty Cycle Factor : 2.67
 Conversion Factor : 5.9
 Probe Sensitivity : 1.20 1.20 1.20 $\mu\text{V}/(\text{V}/\text{m})^2$
 Compression Point : 95.00 mV
 Offset : 1.56 mm

1 gram SAR value : 0.091 W/kg
 10 gram SAR value : 0.057 W/kg
 Area Scan Peak SAR : 0.101 W/kg
 Zoom Scan Peak SAR : 0.225 W/kg

Plot 25#

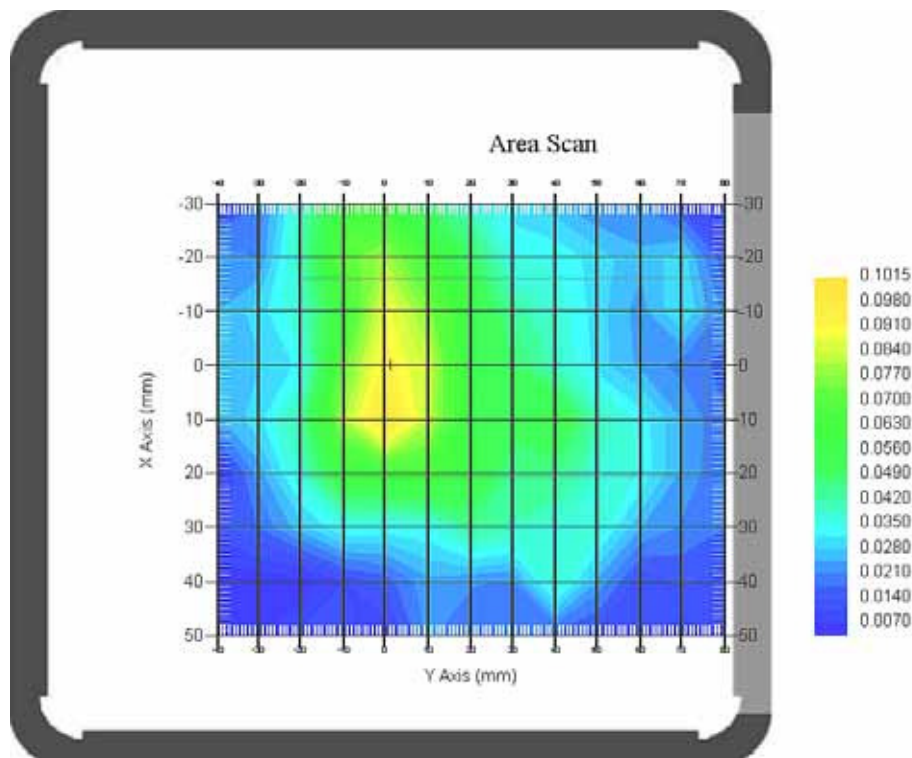

Test Laboratory: Bay Area Compliance Lab Corp. (Shenzhen)

Body-worn-Back (848.8 MHz High Channel)

Measurement Data

Test mode : GPRS
 Crest Factor : 2.67
 Scan Type : Complete
 Area Scan : 8x11x1 : Measurement x=10mm, y=10mm, z=4mm
 Zoom Scan : 7x7x7 : Measurement x=5mm, y=5mm, z=5mm
 Power Drift-Start : 0.112 W/kg
 Power Drift-Finish : 0.114 W/kg
 Power Drift (%) : 1.847

Tissue Data

Type : Body
 Frequency : 848.8 MHz
 Epsilon : 53.87 F/m
 Sigma : 0.98 S/m
 Density : 1000.00 kg/cu. m

Probe Data

Serial No. : 500-00283
 Frequency Band : 835
 Duty Cycle Factor : 2.67
 Conversion Factor : 5.9
 Probe Sensitivity : 1.20 1.20 1.20 $\mu\text{V}/(\text{V/m})^2$
 Compression Point : 95.00 mV
 Offset : 1.56 mm

1 gram SAR value : 0.139 W/kg
 10 gram SAR value : 0.085 W/kg
 Area Scan Peak SAR : 0.162 W/kg
 Zoom Scan Peak SAR : 0.327 W/kg

Plot 26#

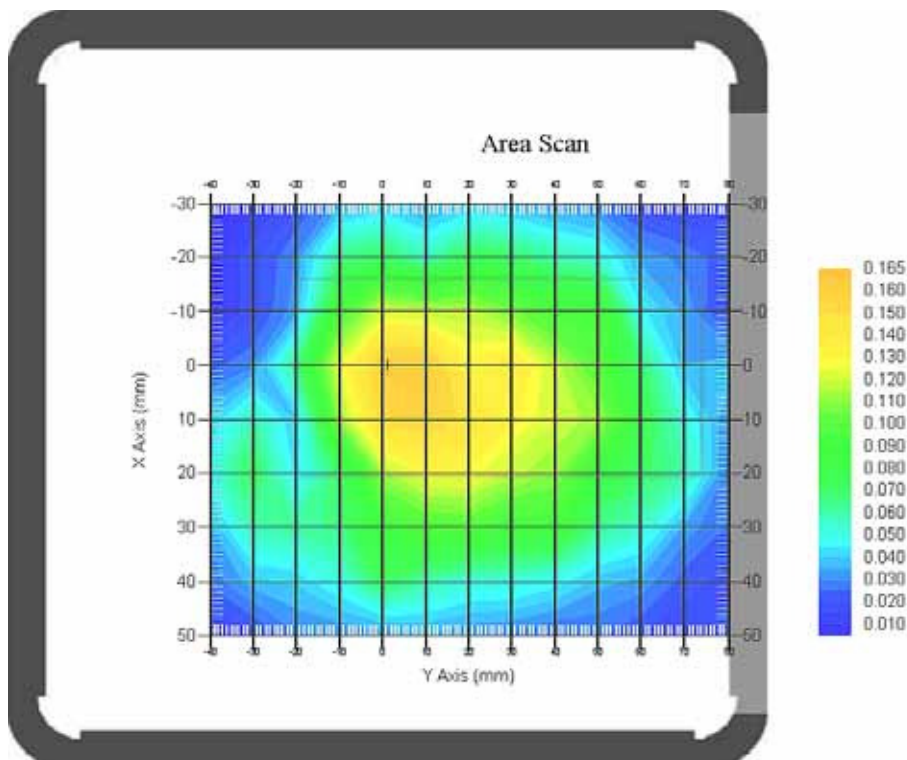

Test Laboratory: Bay Area Compliance Lab Corp. (Shenzhen)

Body-worn-Left (848.8 MHz High Channel)

Measurement Data

Test mode : GPRS
 Crest Factor : 2.67
 Scan Type : Complete
 Area Scan : 8x11x1 : Measurement x=10mm, y=10mm, z=4mm
 Zoom Scan : 7x7x7 : Measurement x=5mm, y=5mm, z=5mm
 Power Drift-Start : 0.021 W/kg
 Power Drift-Finish : 0.021 W/kg
 Power Drift (%) : -2.053

Tissue Data

Type : Body
 Frequency : 848.8 MHz
 Epsilon : 53.87 F/m
 Sigma : 0.98 S/m
 Density : 1000.00 kg/cu. m

Probe Data

Serial No. : 500-00283
 Frequency Band : 835
 Duty Cycle Factor : 2.67
 Conversion Factor : 5.9
 Probe Sensitivity : 1.20 1.20 1.20 $\mu\text{V}/(\text{V}/\text{m})^2$
 Compression Point : 95.00 mV
 Offset : 1.56 mm

1 gram SAR value : 0.029 W/kg
 10 gram SAR value : 0.015 W/kg
 Area Scan Peak SAR : 0.036 W/kg
 Zoom Scan Peak SAR : 0.057 W/kg

Plot 27#

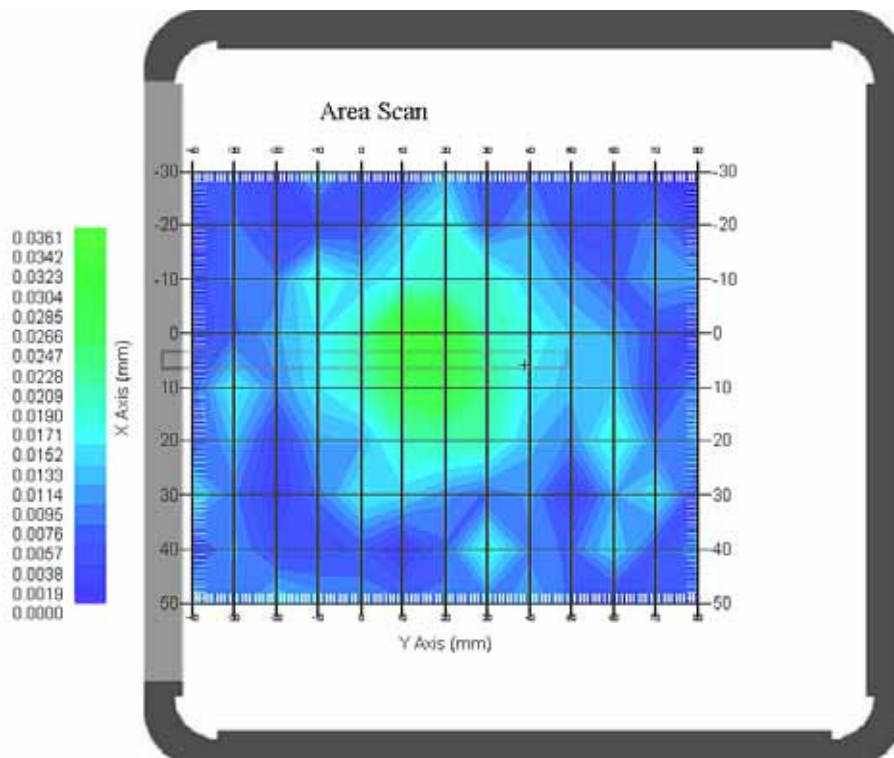

Test Laboratory: Bay Area Compliance Lab Corp. (Shenzhen)

Body-worn-Right (848.8 MHz High Channel)

Measurement Data

Test mode : GPRS
 Crest Factor : 2.67
 Scan Type : Complete
 Area Scan : 8x11x1 : Measurement x=10mm, y=10mm, z=4mm
 Zoom Scan : 7x7x7 : Measurement x=5mm, y=5mm, z=5mm
 Power Drift-Start : 0.036 W/kg
 Power Drift-Finish : 0.035 W/kg
 Power Drift (%) : -2.854

Tissue Data

Type : Body
 Frequency : 848.8 MHz
 Epsilon : 53.87 F/m
 Sigma : 0.98 S/m
 Density : 1000.00 kg/cu. m

Probe Data

Serial No. : 500-00283
 Frequency Band : 835
 Duty Cycle Factor : 2.67
 Conversion Factor : 5.9
 Probe Sensitivity : 1.20 1.20 1.20 $\mu\text{V}/(\text{V}/\text{m})^2$
 Compression Point : 95.00 mV
 Offset : 1.56 mm

1 gram SAR value : 0.062 W/kg
 10 gram SAR value : 0.038 W/kg
 Area Scan Peak SAR : 0.066 W/kg
 Zoom Scan Peak SAR : 0.107 W/kg

Plot 28#

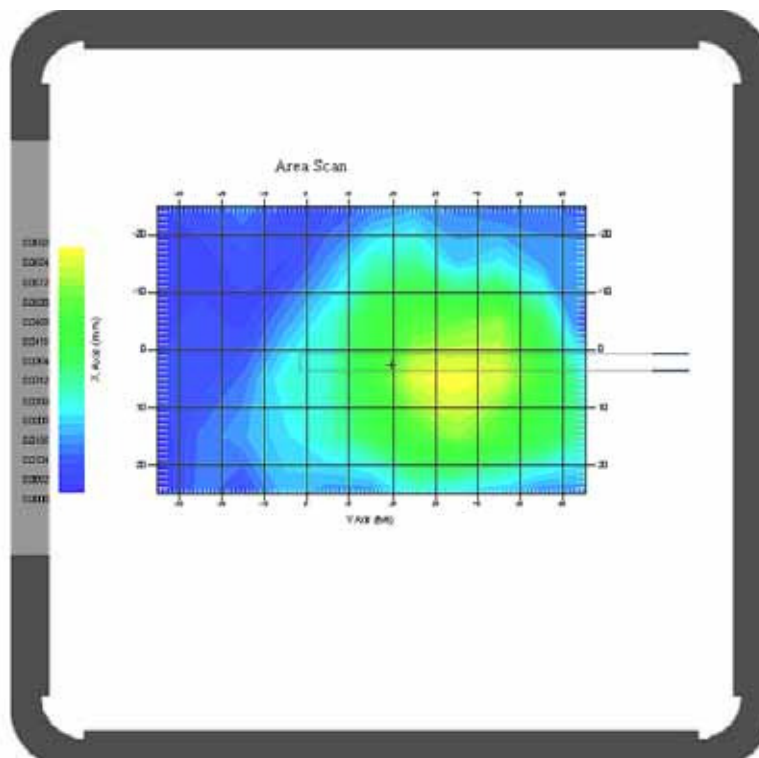

Test Laboratory: Bay Area Compliance Lab Corp. (Shenzhen)

Body-worn-Right (848.8 MHz High Channel)

Measurement Data

Test mode : GPRS
 Crest Factor : 2.67
 Scan Type : Complete
 Area Scan : 8x11x1 : Measurement x=10mm, y=10mm, z=4mm
 Zoom Scan : 7x7x7 : Measurement x=5mm, y=5mm, z=5mm
 Power Drift-Start : 0.012 W/kg
 Power Drift-Finish : 0.012W/kg
 Power Drift (%) : 0.758

Tissue Data

Type : Body
 Frequency : 848.8 MHz
 Epsilon : 53.87 F/m
 Sigma : 0.98 S/m
 Density : 1000.00 kg/cu. m

Probe Data

Serial No. : 500-00283
 Frequency Band : 835
 Duty Cycle Factor : 2.67
 Conversion Factor : 5.9
 Probe Sensitivity : 1.20 1.20 1.20 $\mu\text{V}/(\text{V}/\text{m})^2$
 Compression Point : 95.00 mV
 Offset : 1.56 mm

1 gram SAR value : 0.022 W/kg
 10 gram SAR value : 0.009 W/kg
 Area Scan Peak SAR : 0.027 W/kg
 Zoom Scan Peak SAR : 0.051 W/kg

Plot 29#

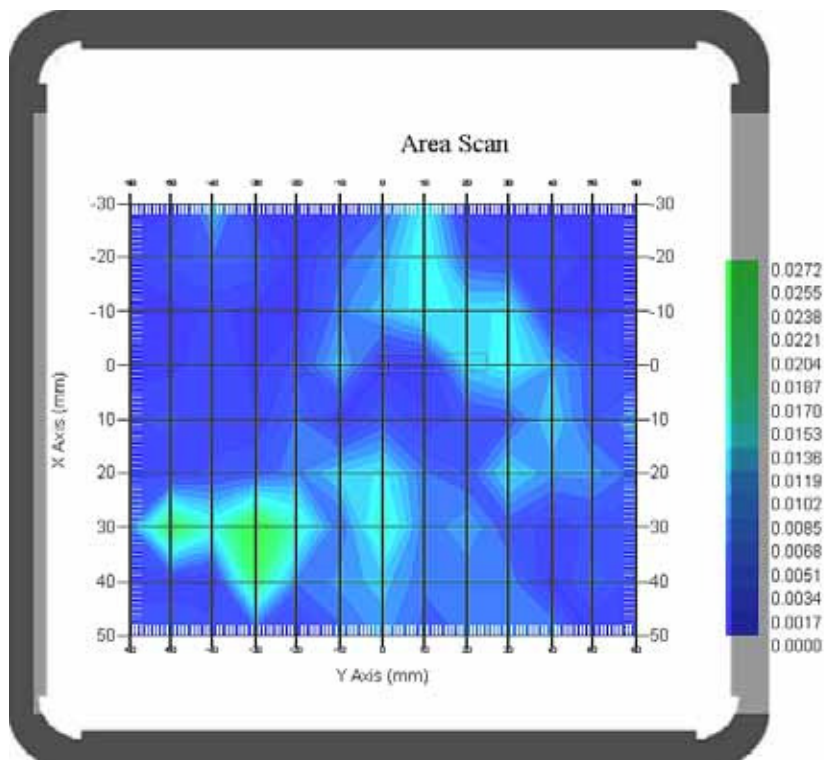

Test Laboratory: Bay Area Compliance Lab Corp. (Shenzhen)

Body-worn-Front (1850.2 MHz Low Channel)

Measurement Data

Test mode : GPRS
 Crest Factor : 2.67
 Scan Type : Complete
 Area Scan : 8x11x1 : Measurement x=10mm, y=10mm, z=4mm
 Zoom Scan : 7x7x7 : Measurement x=5mm, y=5mm, z=5mm
 Power Drift-Start : 0.195 W/kg
 Power Drift-Finish : 0.202 W/kg
 Power Drift (%) : 3.685

Tissue Data

Type : Body
 Frequency : 1850.2 MHz
 Epsilon : 52.06 F/m
 Sigma : 1.49 S/m
 Density : 1000.00 kg/cu. m

Probe Data

Serial No. : 500-00283
 Frequency Band : 1900
 Duty Cycle Factor : 2.67
 Conversion Factor : 4.5
 Probe Sensitivity : 1.20 1.20 1.20 $\mu\text{V}/(\text{V}/\text{m})^2$
 Compression Point : 95.00 mV
 Offset : 1.56 mm

1 gram SAR value : 0.275 W/kg
 10 gram SAR value : 0.153 W/kg
 Area Scan Peak SAR : 0.320 W/kg
 Zoom Scan Peak SAR : 0.571 W/kg

Plot 30#

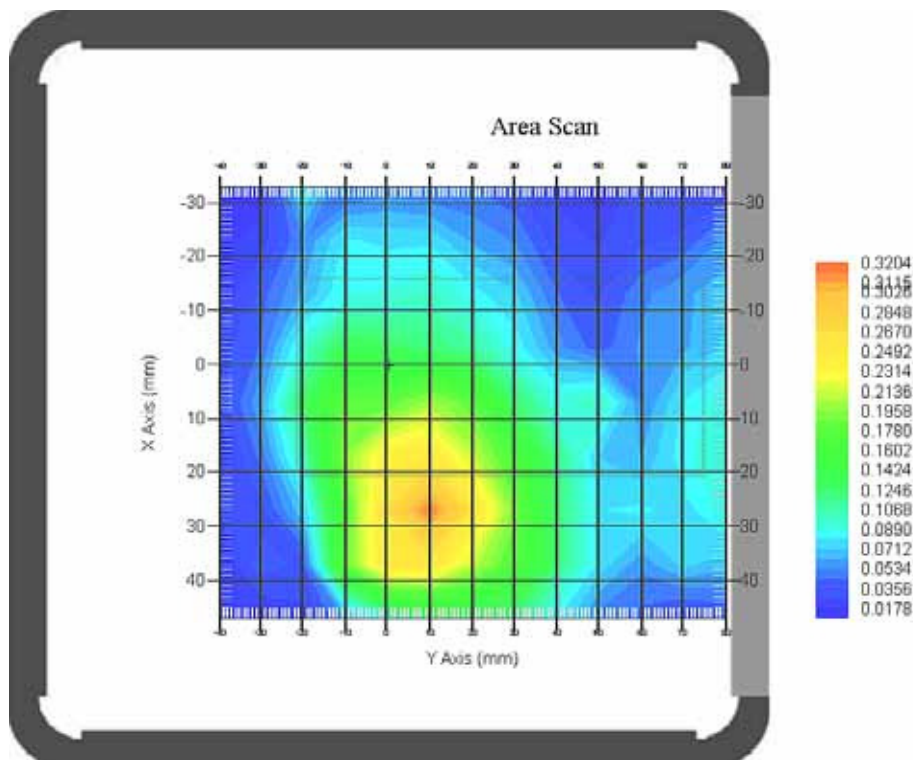

Test Laboratory: Bay Area Compliance Lab Corp. (Shenzhen)

Body-worn-Back (1850.2 MHz Low Channel)

Measurement Data

Test mode : GPRS
 Crest Factor : 2.67
 Scan Type : Complete
 Area Scan : 8x11x1 : Measurement x=10mm, y=10mm, z=4mm
 Zoom Scan : 7x7x7 : Measurement x=5mm, y=5mm, z=5mm
 Power Drift-Start : 0.252 W/kg
 Power Drift-Finish : 0.248 W/kg
 Power Drift (%) : -1.627

Tissue Data

Type : Body
 Frequency : 1850.2 MHz
 Epsilon : 52.06 F/m
 Sigma : 1.49 S/m
 Density : 1000.00 kg/cu. m

Probe Data

Serial No. : 500-00283
 Frequency Band : 1900
 Duty Cycle Factor : 2.67
 Conversion Factor : 4.5
 Probe Sensitivity : 1.20 1.20 1.20 $\mu\text{V}/(\text{V}/\text{m})^2$
 Compression Point : 95.00 mV
 Offset : 1.56 mm

1 gram SAR value : 0.293 W/kg
 10 gram SAR value : 0.154 W/kg
 Area Scan Peak SAR : 0.367 W/kg
 Zoom Scan Peak SAR : 0.509 W/kg

Plot 31#

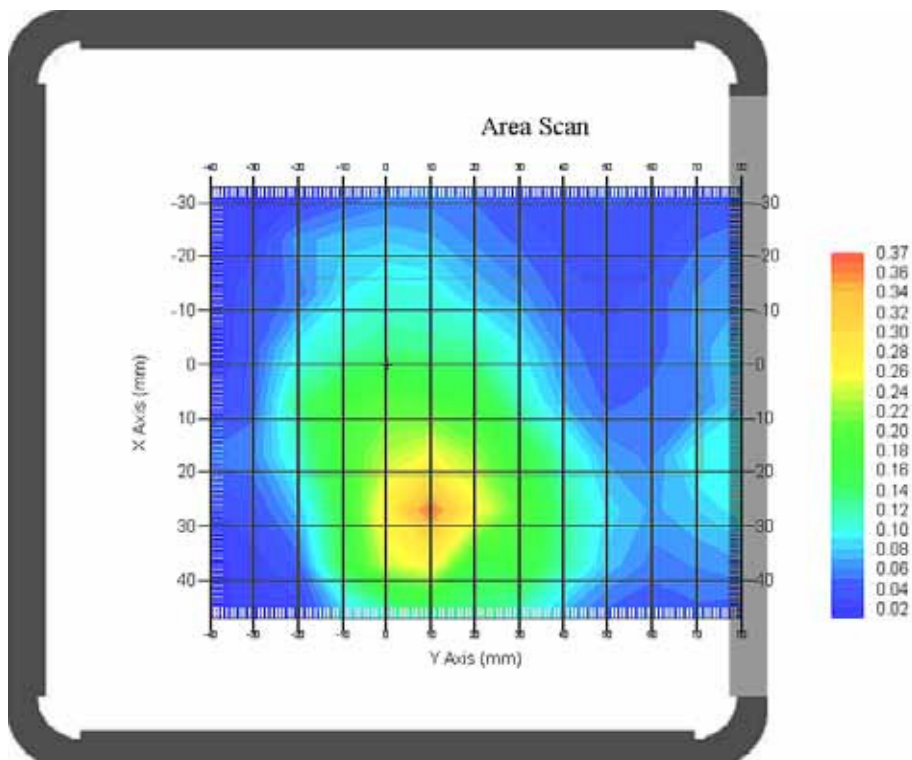

Test Laboratory: Bay Area Compliance Lab Corp. (Shenzhen)

Body-worn-Left (1850.2 MHz Low Channel)

Measurement Data

Test mode : GPRS
 Crest Factor : 2.67
 Scan Type : Complete
 Area Scan : 8x11x1 : Measurement x=10mm, y=10mm, z=4mm
 Zoom Scan : 7x7x7 : Measurement x=5mm, y=5mm, z=5mm
 Power Drift-Start : 0.052 W/kg
 Power Drift-Finish : 0.052 W/kg
 Power Drift (%) : -0.624

Tissue Data

Type : Body
 Frequency : 1850.2 MHz
 Epsilon : 52.06 F/m
 Sigma : 1.49 S/m
 Density : 1000.00 kg/cu. m

Probe Data

Serial No. : 500-00283
 Frequency Band : 1900
 Duty Cycle Factor : 2.67
 Conversion Factor : 4.5
 Probe Sensitivity : 1.20 1.20 1.20 $\mu\text{V}/(\text{V}/\text{m})^2$
 Compression Point : 95.00 mV
 Offset : 1.56 mm

1 gram SAR value : 0.090 W/kg
 10 gram SAR value : 0.043 W/kg
 Area Scan Peak SAR : 0.101 W/kg
 Zoom Scan Peak SAR : 0.172 W/kg

Plot 32#

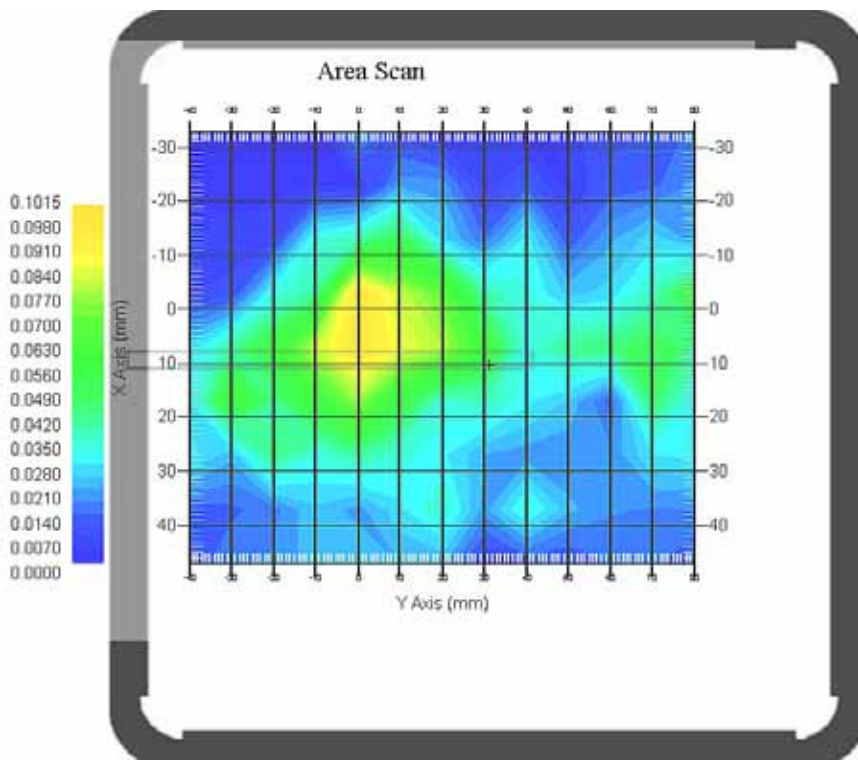

Test Laboratory: Bay Area Compliance Lab Corp. (Shenzhen)

Body-worn-Right (1850.2 MHz Low Channel)

Measurement Data

Test mode : GPRS
 Crest Factor : 2.67
 Scan Type : Complete
 Area Scan : 8x11x1 : Measurement x=10mm, y=10mm, z=4mm
 Zoom Scan : 7x7x7 : Measurement x=5mm, y=5mm, z=5mm
 Power Drift-Start : 0.023 W/kg
 Power Drift-Finish : 0.023 W/kg
 Power Drift (%) : 1.765

Tissue Data

Type : Body
 Frequency : 1850.2 MHz
 Epsilon : 52.06 F/m
 Sigma : 1.49 S/m
 Density : 1000.00 kg/cu. m

Probe Data

Serial No. : 500-00283
 Frequency Band : 1900
 Duty Cycle Factor : 2.67
 Conversion Factor : 4.5
 Probe Sensitivity : 1.20 1.20 1.20 $\mu\text{V}/(\text{V}/\text{m})^2$
 Compression Point : 95.00 mV
 Offset : 1.56 mm

1 gram SAR value : 0.115 W/kg
 10 gram SAR value : 0.052 W/kg
 Area Scan Peak SAR : 0.124 W/kg
 Zoom Scan Peak SAR : 0.198 W/kg

Plot 33#

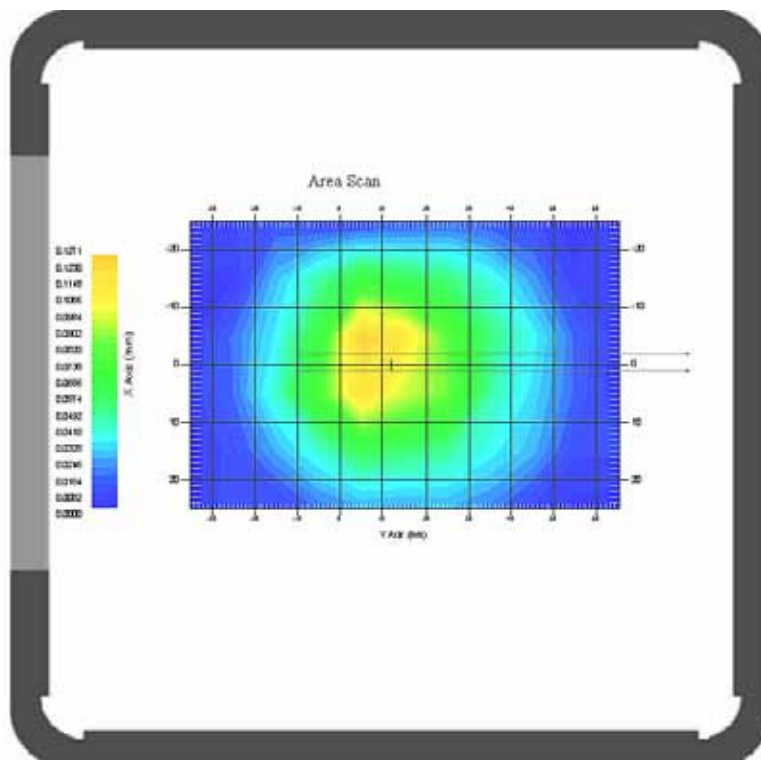

Test Laboratory: Bay Area Compliance Lab Corp. (Shenzhen)

Body-worn-Bottom (1850.2 MHz Low Channel)

Measurement Data

Test mode : GPRS
 Crest Factor : 2.67
 Scan Type : Complete
 Area Scan : 8x11x1 : Measurement x=10mm, y=10mm, z=4mm
 Zoom Scan : 7x7x7 : Measurement x=5mm, y=5mm, z=5mm
 Power Drift-Start : 0.015 W/kg
 Power Drift-Finish : 0.015 W/kg
 Power Drift (%) : -0.842

Tissue Data

Type : Body
 Frequency : 1850.2 MHz
 Epsilon : 52.06 F/m
 Sigma : 1.49 S/m
 Density : 1000.00 kg/cu. m

Probe Data

Serial No. : 500-00283
 Frequency Band : 1900
 Duty Cycle Factor : 2.67
 Conversion Factor : 4.5
 Probe Sensitivity : 1.20 1.20 1.20 $\mu\text{V}/(\text{V}/\text{m})^2$
 Compression Point : 95.00 mV
 Offset : 1.56 mm

1 gram SAR value : 0.048 W/kg
 10 gram SAR value : 0.025 W/kg
 Area Scan Peak SAR : 0.055 W/kg
 Zoom Scan Peak SAR : 0.129 W/kg

Plot 34#

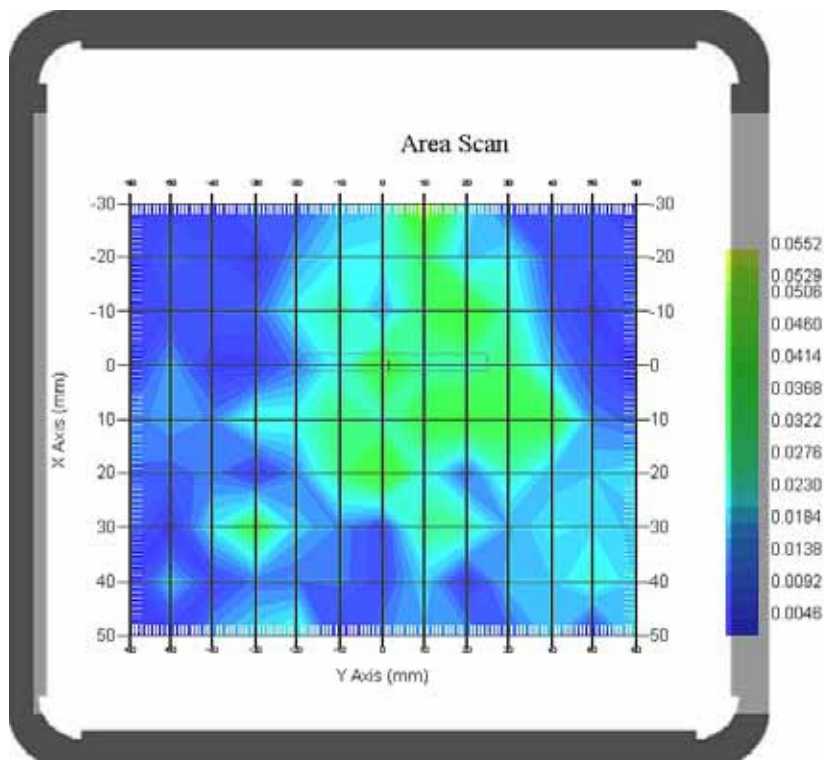

Test Laboratory: Bay Area Compliance Lab Corp. (Shenzhen)

WCDMA850; Body-Worn-Front (826.4 MHz Low Channel)

Measurement Data

Test mode : WCDMA850
 Crest Factor : 1
 Scan Type : Complete
 Area Scan : 11x8x1: Measurement x=10mm, y=10mm, z=4mm
 Zoom Scan : 7x7x7: Measurement x=5mm, y=5mm, z=5mm
 Power Drift-Start : 0.102 W/kg
 Power Drift-Finish : 0.099 W/kg
 Power Drift (%) : -2.984

Tissue Data

Type : Body
 Frequency : 826.4 MHz
 Epsilon : 53.78 F/m
 Sigma : 0.95 S/m
 Density : 1000.00 kg/cu. m

Probe Data

Serial No. : 500-00283
 Frequency Band : 835
 Duty Cycle Factor : 1
 Conversion Factor : 5.9
 Probe Sensitivity : 1.20 1.20 1.20 $\mu\text{V}/(\text{V}/\text{m})^2$
 Compression Point : 95.00 mV
 Offset : 1.56 mm

1 gram SAR value : 0.106 W/kg
 10 gram SAR value : 0.057 W/kg
 Area Scan Peak SAR : 0.121 W/kg
 Zoom Scan Peak SAR : 0.180 W/kg

Plot 35#

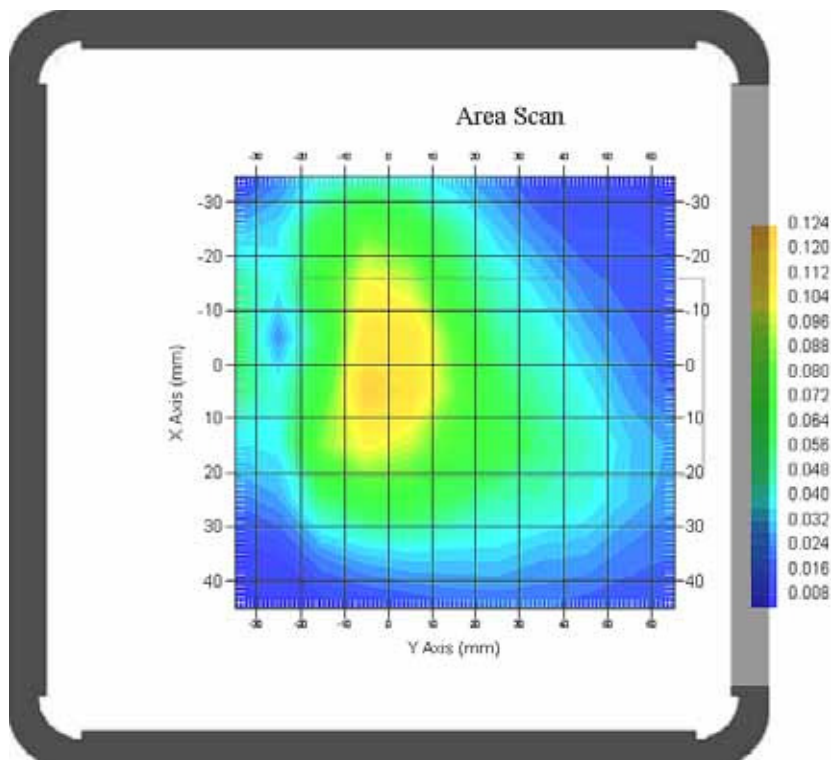

Test Laboratory: Bay Area Compliance Lab Corp. (Shenzhen)

WCDMA850; Body-Worn-Back (826.4 MHz Low Channel)

Measurement Data

Test mode : WCDMA850
 Crest Factor : 1
 Scan Type : Complete
 Area Scan : 11x8x1: Measurement x=10mm, y=10mm, z=4mm
 Zoom Scan : 7x7x7: Measurement x=5mm, y=5mm, z=5mm
 Power Drift-Start : 0.126 W/kg
 Power Drift-Finish : 0.125 W/kg
 Power Drift (%) : -0.798

Tissue Data

Type : Body
 Frequency : 826.4 MHz
 Epsilon : 53.78 F/m
 Sigma : 0.95 S/m
 Density : 1000.00 kg/cu. m

Probe Data

Serial No. : 500-00283
 Frequency Band : 835
 Duty Cycle Factor : 1
 Conversion Factor : 5.9
 Probe Sensitivity : 1.20 1.20 1.20 $\mu\text{V}/(\text{V/m})^2$
 Compression Point : 95.00 mV
 Offset : 1.56 mm

1 gram SAR value : 0.171 W/kg
 10 gram SAR value : 0.097 W/kg
 Area Scan Peak SAR : 0.175 W/kg
 Zoom Scan Peak SAR : 0.319 W/kg

Plot 36#

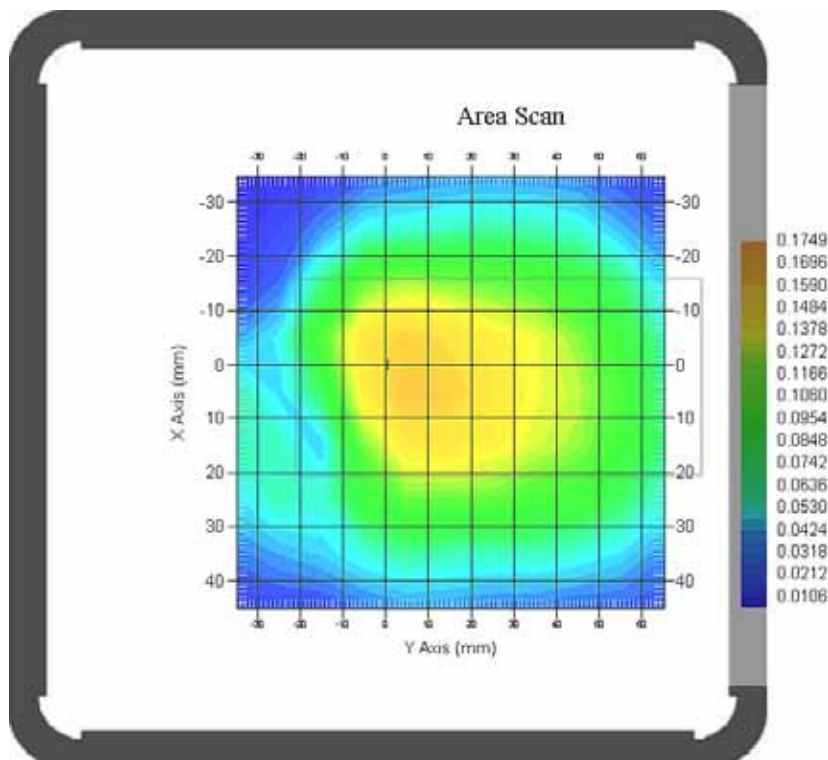

Test Laboratory: Bay Area Compliance Lab Corp. (Shenzhen)

WCDMA850; Body-Worn-Left (826.4 MHz Low Channel)

Measurement Data

Test mode : WCDMA850
 Crest Factor : 1
 Scan Type : Complete
 Area Scan : 11x8x1: Measurement x=10mm, y=10mm, z=4mm
 Zoom Scan : 7x7x7: Measurement x=5mm, y=5mm, z=5mm
 Power Drift-Start : 0.002 W/kg
 Power Drift-Finish : 0.002 W/kg
 Power Drift (%) : -1.467

Tissue Data

Type : Body
 Frequency : 826.4 MHz
 Epsilon : 53.78 F/m
 Sigma : 0.95 S/m
 Density : 1000.00 kg/cu. m

Probe Data

Serial No. : 500-00283
 Frequency Band : 835
 Duty Cycle Factor : 1
 Conversion Factor : 5.9
 Probe Sensitivity : 1.20 1.20 1.20 $\mu\text{V}/(\text{V}/\text{m})^2$
 Compression Point : 95.00 mV
 Offset : 1.56 mm

1 gram SAR value : 0.012 W/kg
 10 gram SAR value : 0.006 W/kg
 Area Scan Peak SAR : 0.014 W/kg
 Zoom Scan Peak SAR : 0.029 W/kg

Plot 37#

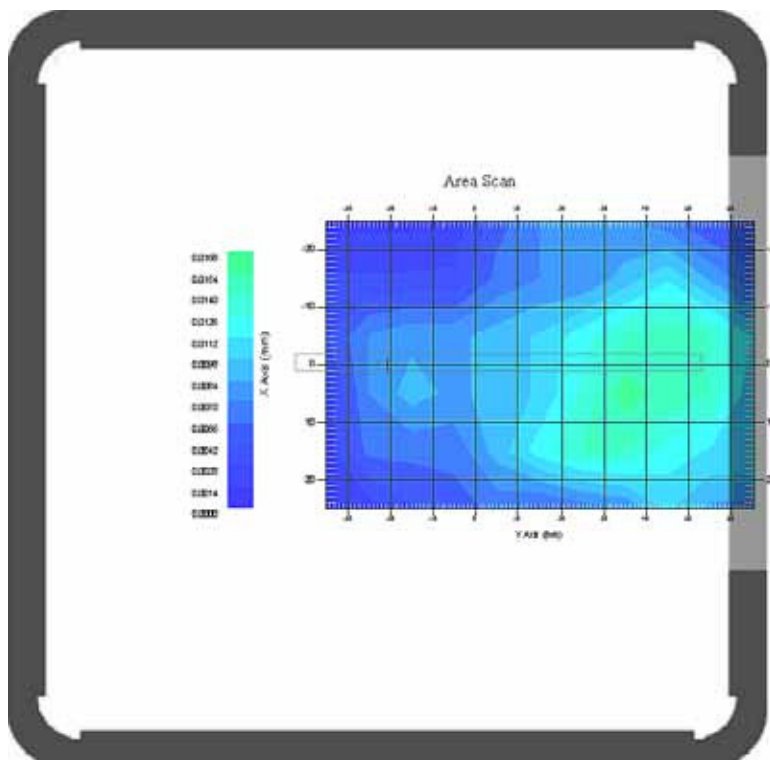

Test Laboratory: Bay Area Compliance Lab Corp. (Shenzhen)

WCDMA850; Body-Worn-Right (826.4 MHz Low Channel)

Measurement Data

Test mode : WCDMA850
 Crest Factor : 1
 Scan Type : Complete
 Area Scan : 11x8x1: Measurement x=10mm, y=10mm, z=4mm
 Zoom Scan : 7x7x7: Measurement x=5mm, y=5mm, z=5mm
 Power Drift-Start : 0.075 W/kg
 Power Drift-Finish : 0.076 W/kg
 Power Drift (%) : 1.328

Tissue Data

Type : Body
 Frequency : 826.4 MHz
 Epsilon : 53.78 F/m
 Sigma : 0.95 S/m
 Density : 1000.00 kg/cu. m

Probe Data

Serial No. : 500-00283
 Frequency Band : 835
 Duty Cycle Factor : 1
 Conversion Factor : 5.9
 Probe Sensitivity : 1.20 1.20 1.20 $\mu\text{V}/(\text{V/m})^2$
 Compression Point : 95.00 mV
 Offset : 1.56 mm

1 gram SAR value : 0.079 W/kg
 10 gram SAR value : 0.041 W/kg
 Area Scan Peak SAR : 0.088 W/kg
 Zoom Scan Peak SAR : 0.136 W/kg

Plot 38#

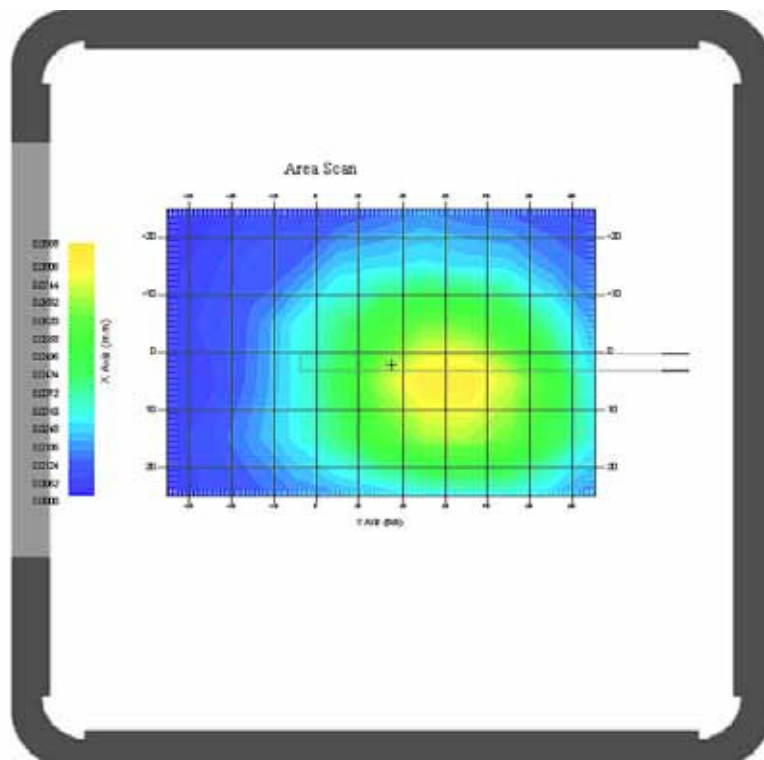

Test Laboratory: Bay Area Compliance Lab Corp. (Shenzhen)

WCDMA850; Body-Worn-Bottom (826.4 MHz Low Channel)

Measurement Data

Test mode : WCDMA850
 Crest Factor : 1
 Scan Type : Complete
 Area Scan : 11x8x1: Measurement x=10mm, y=10mm, z=4mm
 Zoom Scan : 7x7x7: Measurement x=5mm, y=5mm, z=5mm
 Power Drift-Start : 0.008 W/kg
 Power Drift-Finish : 0.008 W/kg
 Power Drift (%) : 0.797

Tissue Data

Type : Body
 Frequency : 826.4 MHz
 Epsilon : 53.78 F/m
 Sigma : 0.95 S/m
 Density : 1000.00 kg/cu. m

Probe Data

Serial No. : 500-00283
 Frequency Band : 835
 Duty Cycle Factor : 1
 Conversion Factor : 5.9
 Probe Sensitivity : 1.20 1.20 1.20 $\mu\text{V}/(\text{V}/\text{m})^2$
 Compression Point : 95.00 mV
 Offset : 1.56 mm

1 gram SAR value : 0.013 W/kg
 10 gram SAR value : 0.005 W/kg
 Area Scan Peak SAR : 0.015 W/kg
 Zoom Scan Peak SAR : 0.037 W/kg

Plot 39#

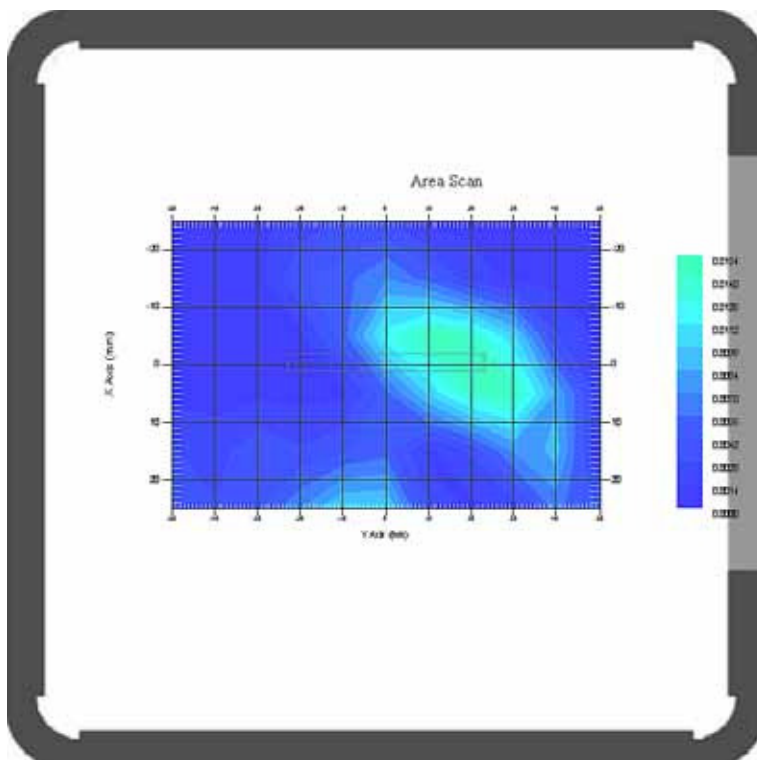

Test Laboratory: Bay Area Compliance Lab Corp. (Shenzhen)

WCDMA1900; Body-Worn-Front (1907.6 MHz High Channel)

Measurement Data

Test mode : WCDMA1900
 Crest Factor : 1
 Scan Type : Complete
 Area Scan : 11x9x1: Measurement x=10mm, y=10mm, z=4mm
 Zoom Scan : 7x7x7: Measurement x=5mm, y=5mm, z=5mm
 Power Drift-Start : 0.428 W/kg
 Power Drift-Finish : 0.435 W/kg
 Power Drift (%) : 1.612

Tissue Data

Type : Head
 Frequency : 1907.6 MHz
 Epsilon : 51.77 F/m
 Sigma : 1.54 S/m
 Density : 1000.00 kg/cu. m

Probe Data

Serial No. : 500-00283
 Frequency Band : 1900
 Duty Cycle Factor : 1
 Conversion Factor : 4.8
 Probe Sensitivity : 1.20 1.20 1.20 $\mu\text{V}/(\text{V}/\text{m})^2$
 Compression Point : 95.00 mV
 Offset : 1.56 mm

1 gram SAR value : 0.531 W/kg
 10 gram SAR value : 0.298 W/kg
 Area Scan Peak SAR : 0.562 W/kg
 Zoom Scan Peak SAR : 0.859 W/kg

Plot 40#

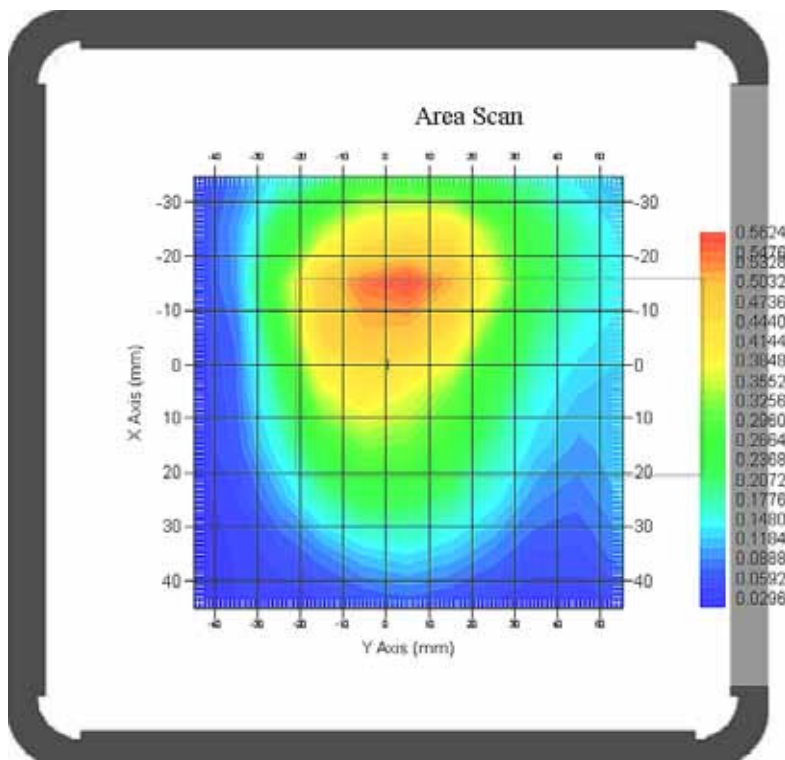

Test Laboratory: Bay Area Compliance Lab Corp. (Shenzhen)

WCDMA1900; Body-Worn-Back (1907.6 MHz High Channel)

Measurement Data

Test mode : WCDMA1900
 Crest Factor : 1
 Scan Type : Complete
 Area Scan : 11x9x1: Measurement x=10mm, y=10mm, z=4mm
 Zoom Scan : 7x7x7: Measurement x=5mm, y=5mm, z=5mm
 Power Drift-Start : 0.502 W/kg
 Power Drift-Finish : 0.511 W/kg
 Power Drift (%) : 1.825

Tissue Data

Type : Head
 Frequency : 1907.6 MHz
 Epsilon : 51.77 F/m
 Sigma : 1.54 S/m
 Density : 1000.00 kg/cu. m

Probe Data

Serial No. : 500-00283
 Frequency Band : 1900
 Duty Cycle Factor : 1
 Conversion Factor : 4.8
 Probe Sensitivity : 1.20 1.20 1.20 $\mu\text{V}/(\text{V}/\text{m})^2$
 Compression Point : 95.00 mV
 Offset : 1.56 mm

1 gram SAR value : 0.558 W/kg
 10 gram SAR value : 0.329 W/kg
 Area Scan Peak SAR : 0.619 W/kg
 Zoom Scan Peak SAR : 0.914 W/kg

Plot 41#

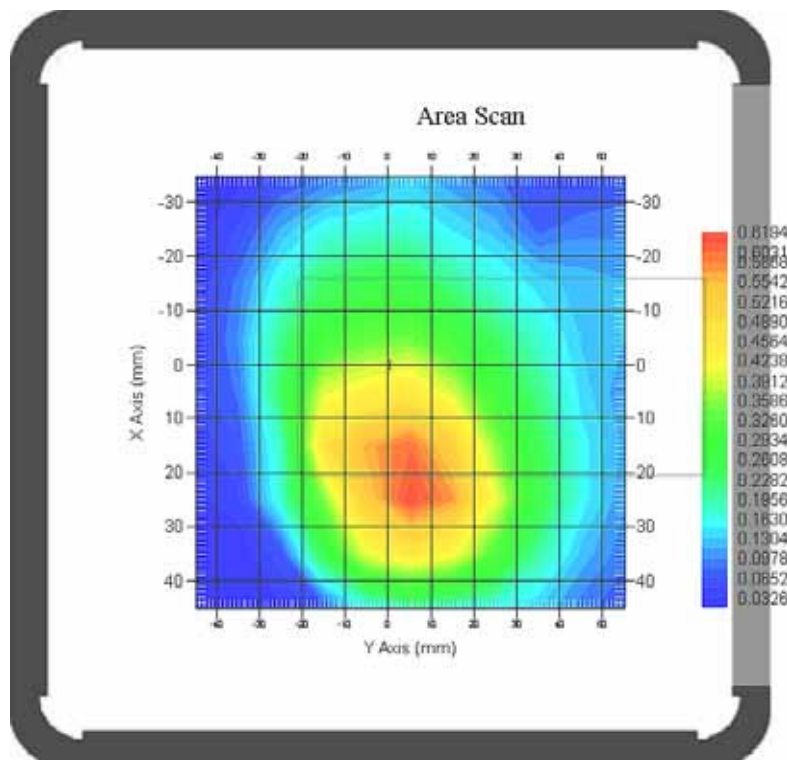

Test Laboratory: Bay Area Compliance Lab Corp. (Shenzhen)

WCDMA1900; Body-Worn-Left (1907.6 MHz High Channel)

Measurement Data

Test mode : WCDMA1900
 Crest Factor : 1
 Scan Type : Complete
 Area Scan : 11x9x1: Measurement x=10mm, y=10mm, z=4mm
 Zoom Scan : 7x7x7: Measurement x=5mm, y=5mm, z=5mm
 Power Drift-Start : 0.052 W/kg
 Power Drift-Finish : 0.051 W/kg
 Power Drift (%) : -1.899

Tissue Data

Type : Head
 Frequency : 1907.6 MHz
 Epsilon : 51.77 F/m
 Sigma : 1.54 S/m
 Density : 1000.00 kg/cu. m

Probe Data

Serial No. : 500-00283
 Frequency Band : 1900
 Duty Cycle Factor : 1
 Conversion Factor : 4.8
 Probe Sensitivity : 1.20 1.20 1.20 $\mu\text{V}/(\text{V}/\text{m})^2$
 Compression Point : 95.00 mV
 Offset : 1.56 mm

1 gram SAR value : 0.062 W/kg
 10 gram SAR value : 0.030 W/kg
 Area Scan Peak SAR : 0.071 W/kg
 Zoom Scan Peak SAR : 0.128 W/kg

Plot 42#

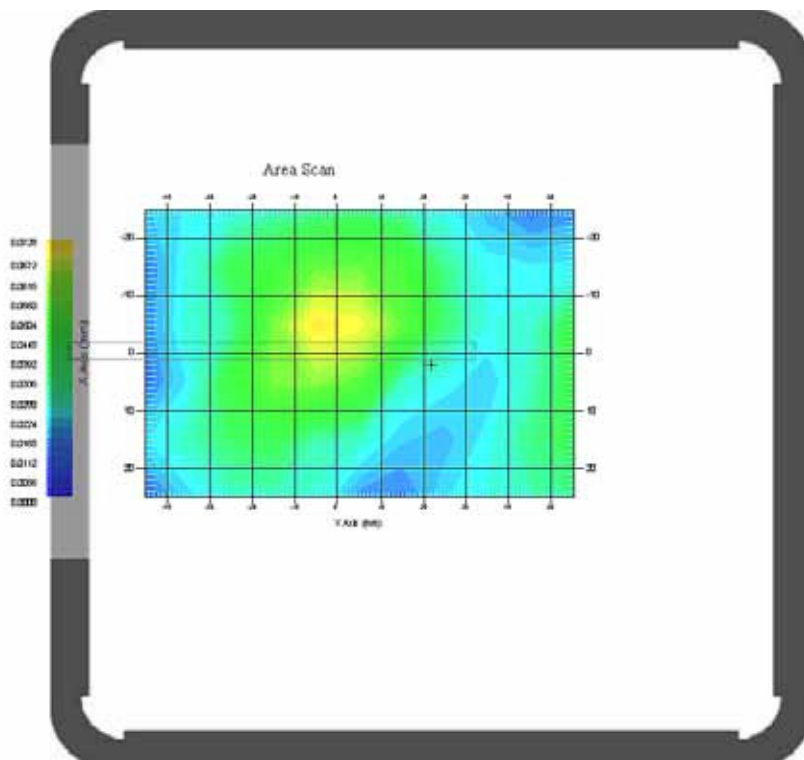

Test Laboratory: Bay Area Compliance Lab Corp. (Shenzhen)

WCDMA1900; Body-Worn-Right (1907.6 MHz High Channel)

Measurement Data

Test mode : WCDMA1900
 Crest Factor : 1
 Scan Type : Complete
 Area Scan : 11x9x1: Measurement x=10mm, y=10mm, z=4mm
 Zoom Scan : 7x7x7: Measurement x=5mm, y=5mm, z=5mm
 Power Drift-Start : 0.256 W/kg
 Power Drift-Finish : 0.261 W/kg
 Power Drift (%) : 1.986

Tissue Data

Type : Head
 Frequency : 1907.6 MHz
 Epsilon : 51.77 F/m
 Sigma : 1.54 S/m
 Density : 1000.00 kg/cu. m

Probe Data

Serial No. : 500-00283
 Frequency Band : 1900
 Duty Cycle Factor : 1
 Conversion Factor : 4.8
 Probe Sensitivity : 1.20 1.20 1.20 $\mu\text{V}/(\text{V/m})^2$
 Compression Point : 95.00 mV
 Offset : 1.56 mm

1 gram SAR value : 0.392 W/kg
 10 gram SAR value : 0.204 W/kg
 Area Scan Peak SAR : 0.433 W/kg
 Zoom Scan Peak SAR : 0.698 W/kg

Plot 43#

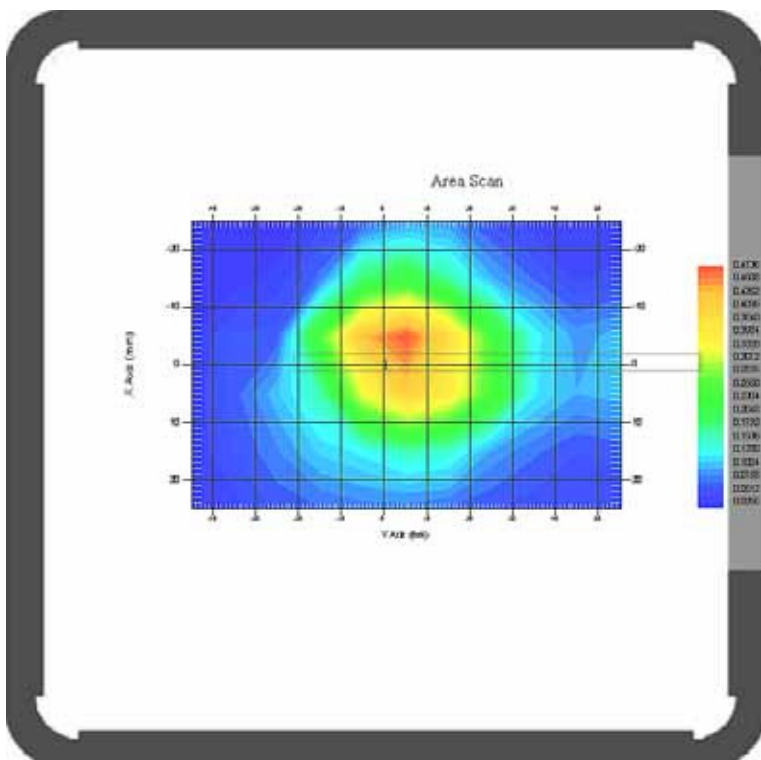

Test Laboratory: Bay Area Compliance Lab Corp. (Shenzhen)

WCDMA1900; Body-Worn-Bottom (1907.6 MHz High Channel)

Measurement Data

Test mode : WCDMA1900
 Crest Factor : 1
 Scan Type : Complete
 Area Scan : 11x9x1: Measurement x=10mm, y=10mm, z=4mm
 Zoom Scan : 7x7x7: Measurement x=5mm, y=5mm, z=5mm
 Power Drift-Start : 0.025 W/kg
 Power Drift-Finish : 0.024 W/kg
 Power Drift (%) : -3.998

Tissue Data

Type : Head
 Frequency : 1907.6 MHz
 Epsilon : 51.77 F/m
 Sigma : 1.54 S/m
 Density : 1000.00 kg/cu. m

Probe Data

Serial No. : 500-00283
 Frequency Band : 1900
 Duty Cycle Factor : 1
 Conversion Factor : 4.8
 Probe Sensitivity : 1.20 1.20 1.20 $\mu\text{V}/(\text{V}/\text{m})^2$
 Compression Point : 95.00 mV
 Offset : 1.56 mm

1 gram SAR value : 0.075 W/kg
 10 gram SAR value : 0.038 W/kg
 Area Scan Peak SAR : 0.087 W/kg
 Zoom Scan Peak SAR : 0.163 W/kg

Plot 44#

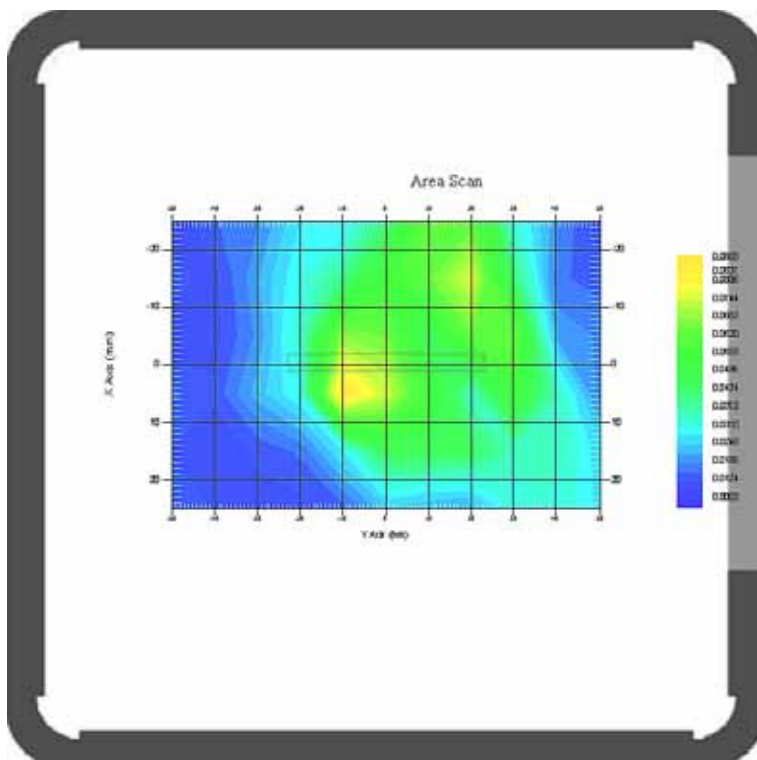

APPENDIX A MEASUREMENT UNCERTAINTY

The uncertainty budget has been determined for the measurement system and is given in the following Table.

Measurement Uncertainty for 300MHz to 3GHz

Source of Uncertainty	Tolerance Value	Probability Distribution	Divisor	c_i^1 (1-g)	c_i^1 (10-g)	Standard Uncertainty (1-g) %	Standard Uncertainty (10-g) %
Measurement System							
Probe Calibration	3.5	normal	1	1	1	3.5	3.5
Axial Isotropy	3.7	rectangular	$\sqrt{3}$	$(1-cp)^{1/2}$	$(\frac{1-cp}{2})^{1/2}$	1.5	1.5
Hemispherical Isotropy	10.9	rectangular	$\sqrt{3}$	\sqrt{cp}	\sqrt{cp}	4.4	4.4
Boundary Effect	1.0	rectangular	$\sqrt{3}$	1	1	0.6	0.6
Linearity	4.7	rectangular	$\sqrt{3}$	1	1	2.7	2.7
Detection Limit	1.0	rectangular	$\sqrt{3}$	1	1	0.6	0.6
Readout Electronics	1.0	normal	1	1	1	1.0	1.0
Response Time	0.8	rectangular	$\sqrt{3}$	1	1	0.5	0.5
Integration Time	1.7	rectangular	$\sqrt{3}$	1	1	1.0	1.0
RF Ambient Condition -Noise	0.006	rectangular	$\sqrt{3}$	1	1	0.003	0.003
RF Ambient Condition - Reflections	3.0	rectangular	$\sqrt{3}$	1	1	1.7	1.7
Probe Positioner Mech. Restrictions	0.4	rectangular	$\sqrt{3}$	1	1	0.2	0.2
Restriction							
Probe Positioning with respect to Phantom Shell	2.9	rectangular	$\sqrt{3}$	1	1	1.7	1.7
Extrapolation and Integration	3.7	rectangular	$\sqrt{3}$	1	1	2.1	2.1
Test Sample Positioning	0.023	normal	1	1	1	0.023	0.023
Device Holder Uncertainty	6.215	normal	1	1	1	6.215	6.215
Drift of Output Power	4.627	rectangular	$\sqrt{3}$	1	1	2.67	2.67
Phantom and Setup							
Phantom Uncertainty(shape & thickness tolerance)	3.4	rectangular	$\sqrt{3}$	1	1	2.0	2.0
Liquid Conductivity(target)	5.0	rectangular	$\sqrt{3}$	0.7	0.5	2.0	1.4
Liquid Conductivity(meas.)	1.938	normal	1	0.7	0.5	1.36	0.97
Liquid Permittivity(target)	5.0	rectangular	$\sqrt{3}$	0.6	0.5	1.7	1.4
Liquid Permittivity(meas.)	3.093	normal	1	0.6	0.5	1.86	1.55
Combined Uncertainty		RSS				10.78	10.55
Expanded uncertainty (coverage factor=2)		Normal(k=2)				21.56	21.10

APPENDIX B – PROBE CALIBRATION CERTIFICATES

NCL CALIBRATION LABORATORIES

Calibration File No.: PC-1537

Task No: BACL-5745

CERTIFICATE OF CALIBRATION

It is certified that the equipment identified below has been calibrated in the NCL CALIBRATION LABORATORIES by qualified personnel following recognized procedures and using transfer standards traceable to NRC/NIST.

Equipment: Miniature Isotropic RF Probe

Record of Calibration

Head and Body

Manufacturer: APREL Laboratories

Model No.: E-020

Serial No.: 500-00283

Calibration Procedure: D01-032-E020-V2, D22-012-Tissue, D28-002-Dipole
Project No: BACL-5745

Calibrated: 8th October 2013

Released on: 8th October 2013

This Calibration Certificate is Incomplete Unless Accompanied with the Calibration Results Summary

Released By: _____



Art Brennan, Quality Manager

NCL CALIBRATION LABORATORIES

Suite 102, 303 Terry Fox Dr.
OTTAWA, ONTARIO
CANADA K2K 3J1

Division of APREL Lab.
TEL: (813) 435-8300
FAX: (813) 435-8308

NCL Calibration Laboratories

Division of APREL Inc.

Introduction

This Calibration Report reproduces the results of the calibration performed in line with the references listed below. Calibration is performed using accepted methodologies as per the references listed below. Probes are calibrated for air, and tissue and the values reported are the results from the physical quantification of the probe through meteorological practices.

Calibration Method

Probes are calibrated using the following methods.

<1000MHz

TEM Cell for sensitivity in air

Standard phantom using temperature transfer method for sensitivity in tissue

>1000MHz

Waveguide* method to determine sensitivity in air and tissue

*Waveguide is numerically (simulation) assessed to determine the field distribution and power

The boundary effect for the probe is assessed using a standard flat phantom where the probe output is compared against a numerically simulated series of data points

References

- IEEE Standard 1528
IEEE Recommended Practice for Determining the Peak Spatial-Average Specific Absorption Rate (SAR) in the Human Head from Wireless Communications Devices: Measurement Techniques
- EN 62209-1
Human Exposure to RF Fields from hand-held and body-mounted wireless communication devices - Human models, instrumentation, and procedures-Part 1: Procedure to measure the Specific Absorption Rate (SAR) for hand-held mobile wireless devices
- IEC 62209-2
Human exposure to RF fields from hand-held and body-mounted wireless devices - Human models, instrumentation, and procedures - Part 2: specific absorption rate (SAR) for wireless communication devices (30 MHz - 6 GHz)
- TP-D01-032-E020-V2 E-Field probe calibration procedure
- D22-012-Tissue dielectric tissue calibration procedure
- D28-002-Dipole procedure for validation of SAR system using a dipole
- IEEE 1309 Standard for Calibration of Electromagnetic Field Sensors and Probes, Excluding Antennas, from 9kHz to 40GHz

Page 2 of 10

This page has been reviewed for content and attested to on Page 2 of this document.

NCL Calibration Laboratories

Division of APREL Inc.

Conditions

Probe 500-00283 was a recalibration.

Ambient Temperature of the Laboratory: 22 °C +/- 1.5°C
Temperature of the Tissue: 21 °C +/- 1.5°C
Relative Humidity: < 60%

Primary Measurement Standards

Instrument	Serial Number	Cal due date
Tektronix USB Power Meter	11C940	May 14, 2015
Signal Generator HP 83640B	3844A00689	Feb 12, 2015

Secondary Measurement Standards

Network Analyzer Anritsu 37347C	002106	Feb. 20, 2015
---------------------------------	--------	---------------

Attestation

The below named signatories have conducted the calibration and review of the data which is presented in this calibration report.

We the undersigned attest that to the best of our knowledge the calibration of this subject has been accurately conducted and that all information contained within the results pages have been reviewed for accuracy.



Art Brennan, Quality Manager



Dan Brooks, Test Engineer

NCL Calibration Laboratories

Division of APREL Inc.

Probe Summary

Probe Type:	E-Field Probe E020
Serial Number:	500-00283
Frequency:	As presented on page 5
Sensor Offset:	1.56
Sensor Length:	2.5
Tip Enclosure:	Composite*
Tip Diameter:	< 2.9 mm
Tip Length:	55 mm
Total Length:	289 mm

*Resistive to recommended tissue recipes per IEEE-1528

Sensitivity in Air

Channel X:	$1.2 \mu\text{V}/(\text{V}/\text{m})^2$
Channel Y:	$1.2 \mu\text{V}/(\text{V}/\text{m})^2$
Channel Z:	$1.2 \mu\text{V}/(\text{V}/\text{m})^2$
Diode Compression Point:	95 mV

Page 4 of 10

This page has been reviewed for content and attested to on Page 2 of this document.

NCL Calibration Laboratories

Division of APREL Inc.

Calibration for Tissue (Head H, Body B)

Frequency	Tissue Type	Measured Epsilon	Measured Sigma	Standard Uncertainty (%)	Calibration Frequency Range (MHz)	Conversion Factor
450 H	Head	44.29	0.86	3.5	±50	5.7
450 B	Body	56.6	0.94	3.5	±50	5.8
750 H	Head	42.7	0.85	3.5	±50	5.6
750 B	Body	56.6	0.94	3.5	±50	5.5
835 H	Head	42.35	0.938	3.5	±50	5.9
835 B	Body	56.65	1.018	3.5	±50	5.9
900 H	Head	X	X	X	X	X
900 B	Body	X	X	X	X	X
1450 H	Head	X	X	X	X	X
1450 B	Body	X	X	X	X	X
1500 H	Head	X	X	X	X	X
1500 B	Body	X	X	X	X	X
1640 H	Head	X	X	X	X	X
1640 B	Body	X	X	X	X	X
1750 H	Head	38.51	1.36	3.5	±75	5.4
1750 B	Body	51.79	1.53	3.5	±75	5.3
1800 H	Head	38.26	1.41	3.5	±75	5.0
1800 B	Body	51.61	1.58	3.5	±75	5.0
1900 H	Head	38.03	1.36	3.5	±75	4.8
1900 B	Body	53.13	1.58	3.5	±75	4.5
2000 H	Head	X	X	X	X	X
2000 B	Body	X	X	X	X	X
2100 H	Head	X	X	X	X	X
2100 B	Body	X	X	X	X	X
2300 H	Head	X	X	X	X	X
2300 B	Body	X	X	X	X	X
2450 H	Head	37.64	1.88	3.5	±75	4.9
2450 B	Body	50.7	2.03	3.5	±75	4.3
2600 H	Head	X	X	X	X	X
2600 B	Body	X	X	X	X	X
3000 H	Head	X	X	X	X	X
3000 B	Body	X	X	X	X	X
3600 H	Head	X	X	X	X	X
3600 B	Body	X	X	X	X	X
5250 H	Head	34.65	4.8	3.5	±100	2.7
5250 B	Body	47.6	5.3	3.5	±100	2.6
5600 H	Head	33.2	5.15	3.5	±100	2.5
5600 B	Body	45.21	5.57	3.5	±100	2.2
5800 H	Head	32.72	5.38	3.5	±100	3.2
5800 B	Body	44.28	6.04	3.5	±100	2.5

NCL Calibration Laboratories

Division of APREL Inc.

Boundary Effect:

Uncertainty resulting from the boundary effect is less than 2.1% for the distance between the tip of the probe and the tissue boundary, when less than 0.58mm.

Spatial Resolution:

The spatial resolution uncertainty is less than 1.5% for 4.9mm diameter probe.
The spatial resolution uncertainty is less than 1.0% for 2.5mm diameter probe.

DAQ-PAQ Contribution

To minimize the uncertainty calculation all tissue sensitivity values were calculated using a load impedance of 5 MΩ.

Page 6 of 10

This page has been reviewed for content and attested to on Page 2 of this document.

NCL Calibration Laboratories

Division of APREL Inc.

Receiving Pattern Air

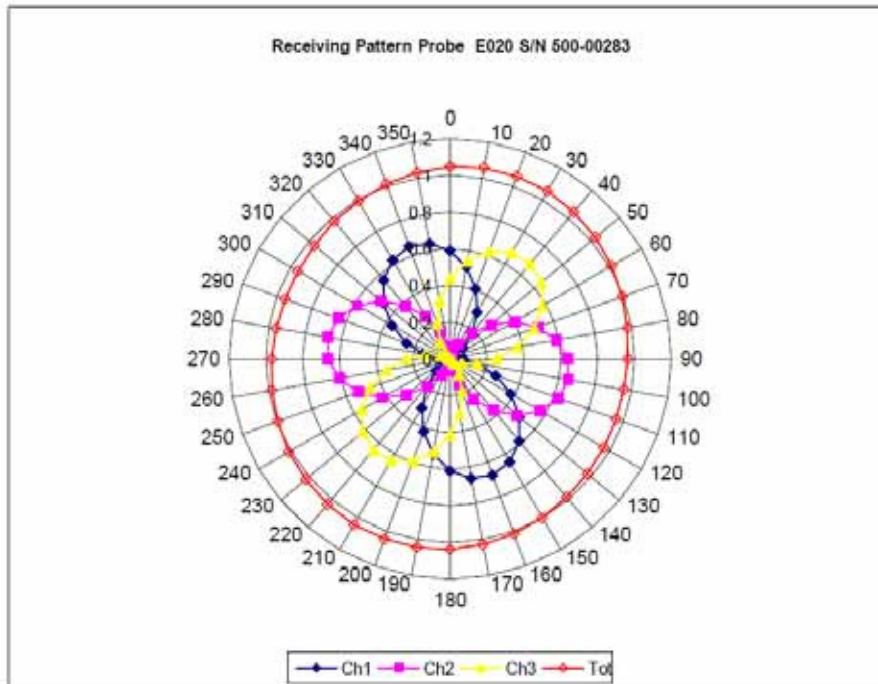

Page 7 of 10

This page has been reviewed for content and attested to on Page 2 of this document.

NCL Calibration Laboratories

Division of APREL Inc.

Isotropy Error Air

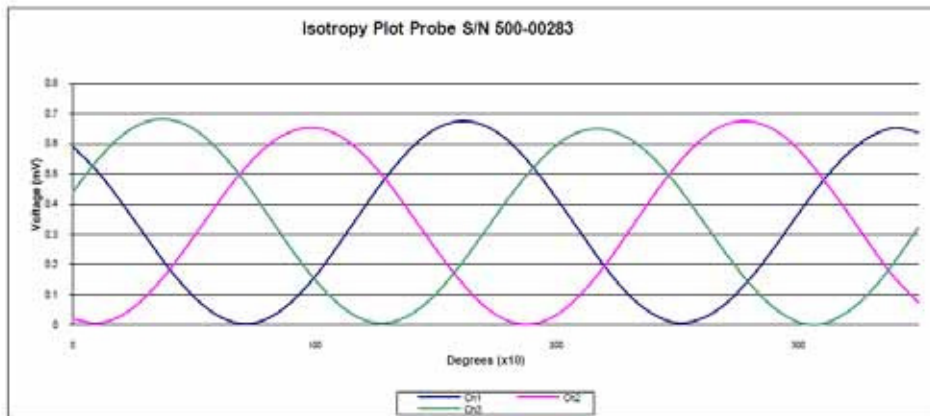
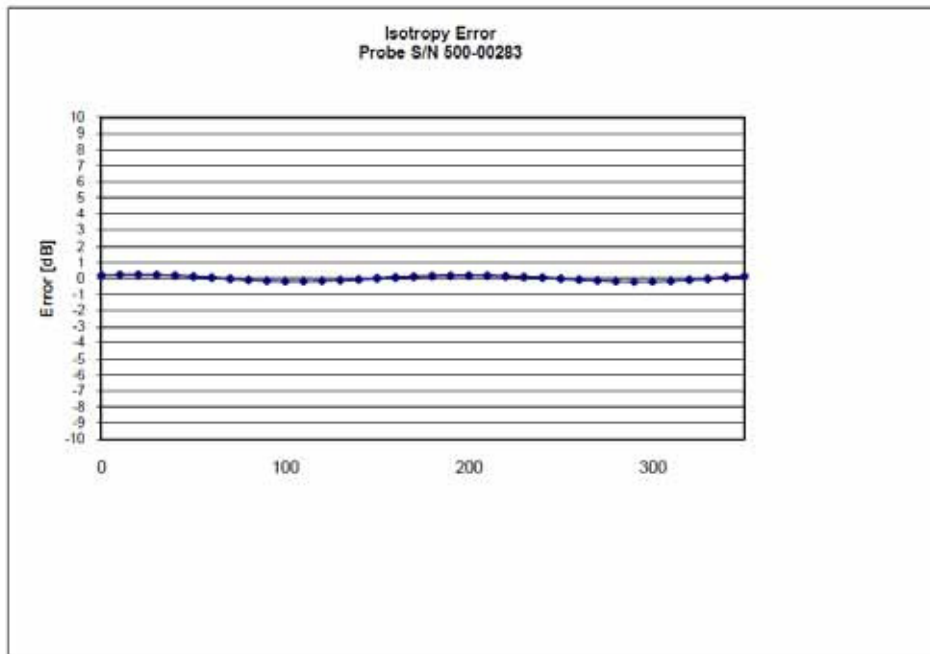

Isotropicity Tissue: 0.10 dB

Page 8 of 10
This page has been reviewed for content and attested to on Page 2 of this document.

NCL Calibration Laboratories

Division of APREL Inc.

Dynamic Range

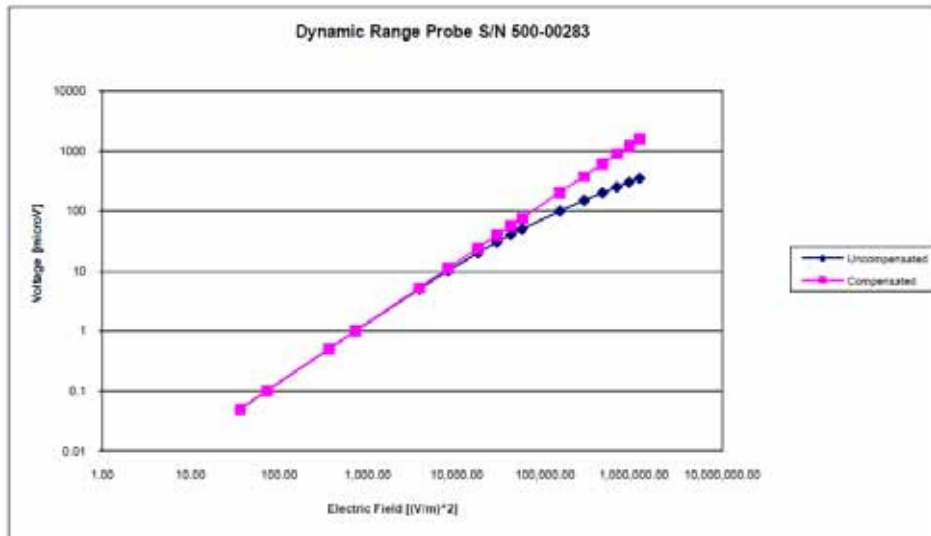

NCL Calibration Laboratories

Division of APREL Inc.

Video Bandwidth

Probe Frequency Characteristics

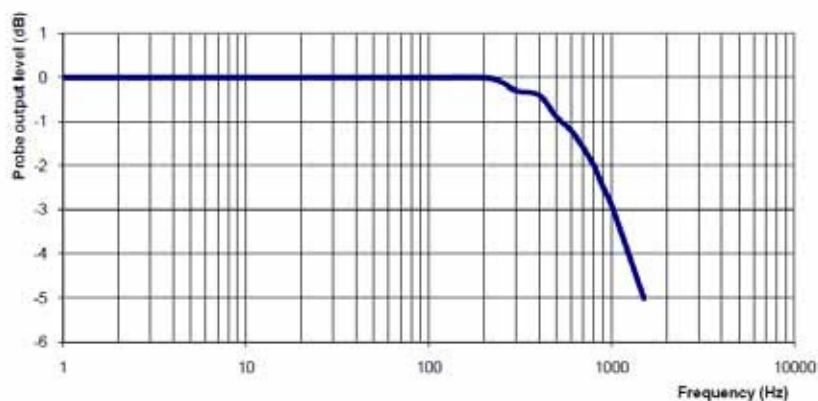

Video Bandwidth at 500 Hz 1 dB
Video Bandwidth at 1.02 KHz: 3 dB

Test Equipment

The test equipment used during Probe Calibration, manufacturer, model number and, current calibration status are listed and located on the main APREL server R:\NCL\Calibration Equipment\Instrument List May 2013.

Page 10 of 10
This page has been reviewed for content and attested to on Page 2 of this document.

APPENDIX C DIPOLE CALIBRATION CERTIFICATES

NCL CALIBRATION LABORATORIES

Calibration File No: DC-1327
Project Number: BAC-dipole-cal-5618

CERTIFICATE OF CALIBRATION

It is certified that the equipment identified below has been calibrated in the
NCL CALIBRATION LABORATORIES by qualified personnel following recognized
procedures and using transfer standards traceable to NRC/NIST.

Validation Dipole(Head and Body)

Manufacturer: APREL Laboratories
Part number: ALS-D-835-S-2
Frequency: 835 MHz
Serial No: 180-00558

Customer: Bay Area Compliance Laboratory

Calibrated: 25th August 2011
Released on: 25th August 2011

This Calibration Certificate is Incomplete Unless Accompanied with the Calibration Results Summary

Released By: _____

NCL CALIBRATION LABORATORIES

Suite 102, 303 Terry Fox Dr.
Kanata, ONTARIO
CANADA K2K 3J1

Division of APREL Lab.
TEL: (613) 435-8300
FAX: (613)435-8306

NCL Calibration Laboratories

Division of APREL Laboratories.

Conditions

Dipole 180-00558 was received in good condition and a re-calibration.

Ambient Temperature of the Laboratory: 22 °C +/- 0.5°C

Temperature of the Tissue: 21 °C +/- 0.5°C

We the undersigned attest that to the best of our knowledge the calibration of this device has been accurately conducted and that all information contained within this report has been reviewed for accuracy.

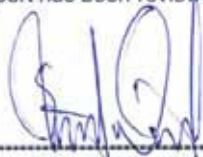

Stuart Nicol



C. Teodorian

Primary Measurement Standards Instrument	Serial Number	Cal due date
Power meter Anritsu MA2408A	245025437	Nov. 4, 2011
Power Sensor Anritsu MA2481D	103555	Nov 4, 2011
Attenuator HP 8495A (70dB) 1	944A10711	Aug. 8, 2012
Network Analyzer Agilent E5071C	1334746J	Feb. 8, 2012
Secondary Measurement Standards		
Signal Generator Agilent E4438C	-506 MY55182336	June 7, 2012

This page has been reviewed for content and attested to by signature within this document.

NCL Calibration Laboratories

Division of APREL Laboratories.

Calibration Results Summary

The following results relate the Calibrated Dipole and should be used as a quick reference for the user.

Mechanical Dimensions

Length: 162.2 mm
Height: 89.4 mm

Electrical Specification

Tissue	Frequency	SWR:	Return Loss	Impedance
Head	835 MHz	1.0417 U	-35.395dB	49.020 Ω
Body	835 MHz	1.1177 U	-25.424dB	55.435 Ω

System Validation Results

Tissue	Frequency	1 Gram	10 Gram	Peak
Head	835 MHz	9.590	6.003	15.013
Body	835 MHz	9.684	6.263	14.23

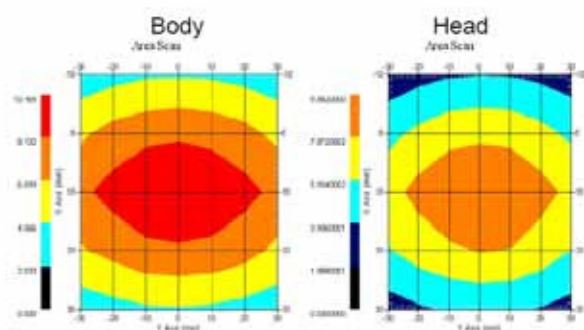

This page has been reviewed for content and attested to by signature within this document.

NCL Calibration Laboratories

Division of APREL Laboratories

Introduction

This Calibration Report has been produced in line with the SSI Dipole Calibration Procedure SSI-TP-018-ALSAS. The results contained within this report are for Validation Dipole 180-00558. The calibration routine consisted of a three-step process. Step 1 was a mechanical verification of the dipole to ensure that it meets the mechanical specifications. Step 2 was an Electrical Calibration for the Validation Dipole, where the SWR, Impedance, and the Return loss were assessed. Step 3 involved a System Validation using the ALSAS-10U, along with APREL E-020 130 MHz to 26 GHz E-Field Probe Serial Number 212.

References

SSI-TP-018-ALSAS Dipole Calibration Procedure
 SSI-TP-016 Tissue Calibration Procedure
 IEEE 1528 "Recommended Practice for Determining the Peak Spatial-Average Specific Absorption Rate (SAR) in the Human Body Due to Wireless Communications Devices: Experimental Techniques"

Conditions

Dipole 180-00558 was new taken from stock.

Ambient Temperature of the Laboratory: 22 °C +/- 0.5°C
Temperature of the Tissue: 20 °C +/- 0.5°C

Dipole Calibration uncertainty

The calibration uncertainty for the dipole is made up of various parameters presented below.

Mechanical	1%
Positioning Error	1.22%
Electrical	1.7%
Tissue	2.2%
Dipole Validation	2.2%
TOTAL	8.32% (16.64% K=2)

This page has been reviewed for content and attested to by signature within this document.

NCL Calibration Laboratories

Division of APREL Laboratories.

Dipole Calibration Results

Mechanical Verification

APREL Length	APREL Height	Measured Length	Measured Height
161.0 mm	89.8 mm	162.2 mm	89.4 mm

Tissue Type	Return Loss:	SWR:	Impedance:
Head	-35.395 dB	1.0417 U	49.020Ω
Body	-25.454 dB	1.1177 U	55.435Ω

Tissue Validation

	Dielectric constant, ϵ_r	Conductivity, σ [S/m]
Head Tissue 835MHz	41.78	0.92
Body Tissue 835MHz	56.37	0.95

This page has been reviewed for content and attested to by signature within this document.

NCL Calibration Laboratories

Division of APREL Laboratories.

The Following Graphs are the results as displayed on the Vector Network Analyzer.

S11 Parameter Return Loss

Head Tissue

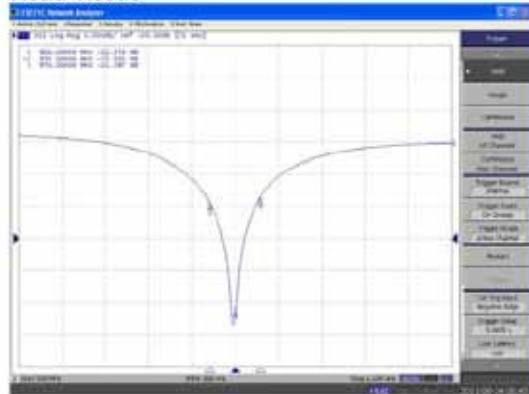

Body Tissue

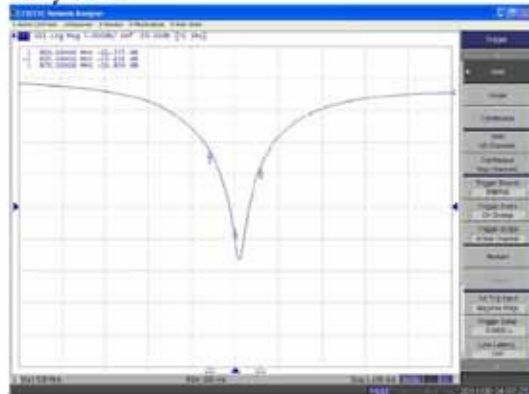

This page has been reviewed for content and attested to by signature within this document.

6

NCL Calibration Laboratories

Division of APREL Laboratories.

**SWR
Head**

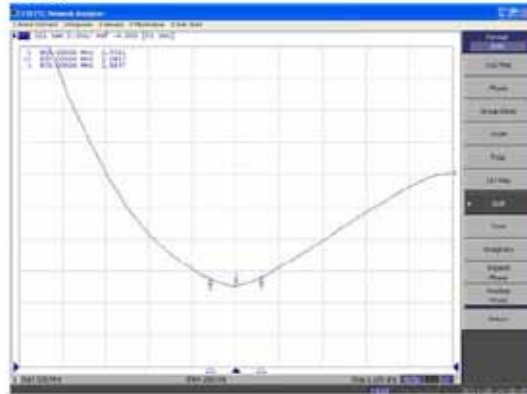

Body

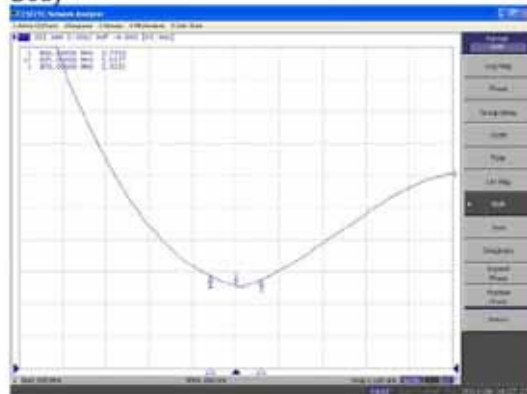

This page has been reviewed for content and attested to by signature within this document.

7

NCL Calibration Laboratories

Division of APREL Laboratories.

Smith Chart Dipole Impedance



This page has been reviewed for content and attested to by signature within this document.

NCL Calibration Laboratories

Division of APREL Laboratories.

Test Equipment

The test equipment used during Probe Calibration, manufacturer, model number and, current calibration status are listed and located on the main APREL server R:\NCL\Calibration Equipment\Instrument List 2011.

This page has been reviewed for content and attested to by signature within this document.

9

835MHz Dipole Calibration By BACL at 2013-12-20

Mechanical Verification

APREL Length	APREL Height	Measured Length	Measured Height
161.0 mm	89.8 mm	161.1 mm	89.7 mm

Tissue Type	Measured Return Loss	Measured Impedance
Head	-33.135 dB	51.898 Ω
Body	-25.362 dB	50.604 Ω

Test Graphs :

Head Tissue

Return Loss :

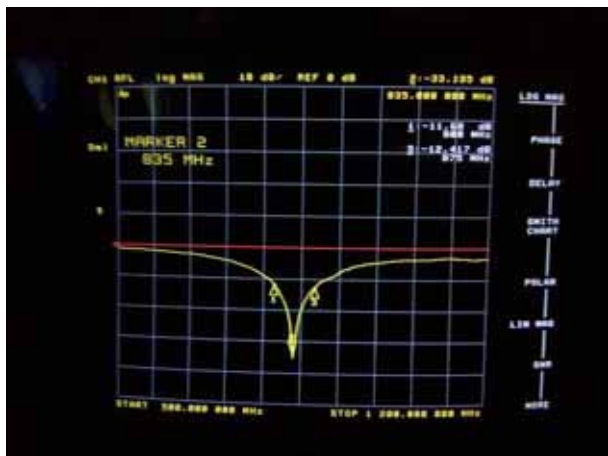

Impedance :



Body Tissue

Return Loss :

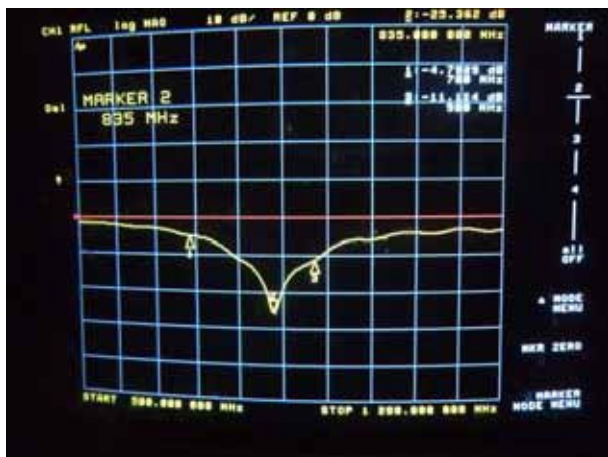

Impedance :

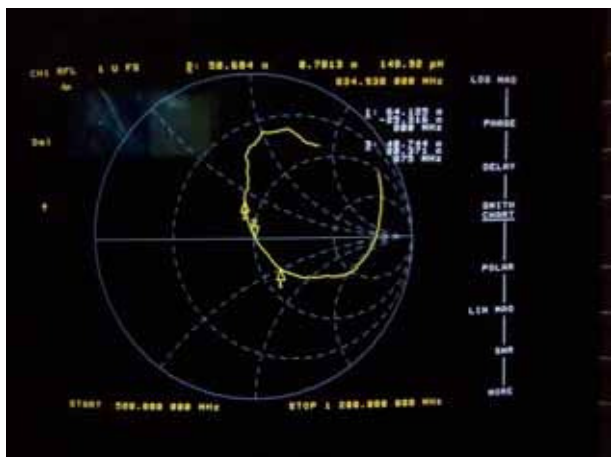

NCL CALIBRATION LABORATORIES

Calibration File No: DC-1331
Project Number: BAC-dipole -cal-5615

CERTIFICATE OF CALIBRATION

It is certified that the equipment identified below has been calibrated in the **NCL CALIBRATION LABORATORIES** by qualified personnel following recognized procedures and using transfer standards traceable to NRC/NIST.

Validation Dipole (Head & Body)

Manufacturer: APREL Laboratories
Part number: ALS-D-1900-S-2
Frequency: 1900 MHz
Serial No: 210-00710

Customer: Bay Area Compliance Laboratory

Calibrated: 25th August, 2011
Released on: 25th August, 2011

This Calibration Certificate is Incomplete Unless Accompanied with the Calibration Results Summary

Released By: _____



NCL CALIBRATION LABORATORIES

Suite 102, 303 Terry Fox Dr.
Kamata, ONTARIO
CANADA K2K 3J1

Division of APREL Lab.
TEL: (613) 435-8300
FAX: (613)435-8306

NCL Calibration Laboratories

Division of APREL Laboratories.

Conditions

Dipole 210-00710 was received in good condition and was a re-calibration.

Ambient Temperature of the Laboratory: 22 °C +/- 0.5°C

Temperature of the Tissue: 21 °C +/- 0.5°C

We the undersigned attest that to the best of our knowledge the calibration of this device has been accurately conducted and that all information contained within this report has been reviewed for accuracy.



Stuart Nicol



C. Teodorian

Primary Measurement Standards

Instrument	Serial Number	Cal due date
Power meter Anritsu MA2408A	245025437	Nov.4, 2011
Power Sensor Anritsu MA2481D	103555	Nov 4, 2011
Attenuator HP 8495A (70dB) 1	944A10711	Aug.8, 2012
Network Analyzer Agilent E5071C	1334746J	Feb. 8, 2012

Secondary Measurement Standards

Signal Generator Agilent E4438C	-506 MY55182336	June 7, 2012
---------------------------------	-----------------	--------------

This page has been reviewed for content and attested to by signature within this document.

NCL Calibration Laboratories

Division of APREL Laboratories.

Calibration Results Summary

The following results relate the Calibrated Dipole and should be used as a quick reference for the user.

Mechanical Dimensions

Length: 67.1 mm
Height: 38.9 mm

Electrical Specification

Tissue	Frequency	SWR:	Return Loss	Impedance
Head	1900MHz	1.0417 U	-35.395dB	49.020 Ω
Body	1900MHz	1.1177 U	-25.424dB	55.435 Ω

System Validation Results

Tissue	Frequency	1 Gram	10 Gram	Peak
Head	1900 MHz	39.648	20.311	73.365
Body	1900 MHz	39.769	20.176	75.866

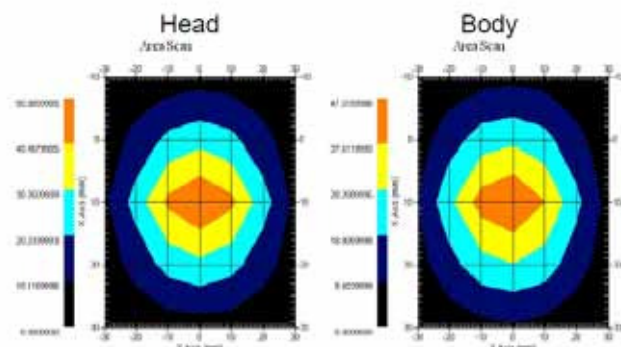

This page has been reviewed for content and attested to by signature within this document.

NCL Calibration Laboratories

Division of APREL Laboratories.

Introduction

This Calibration Report has been produced in line with the SSI Dipole Calibration Procedure SSI-TP-018-ALSAS. The results contained within this report are for Validation Dipole 210-00710. The calibration routine consisted of a three-step process. Step 1 was a mechanical verification of the dipole to ensure that it meets the mechanical specifications. Step 2 was an Electrical Calibration for the Validation Dipole, where the SWR, Impedance, and the Return loss were assessed. Step 3 involved a System Validation using the ALSAS-10U, along with APREL E-020 130 MHz to 26 GHz E-Field Probe Serial Number 212.

References

SSI-TP-018-ALSAS Dipole Calibration Procedure
 SSI-TP-016 Tissue Calibration Procedure
 IEEE 1528 "Recommended Practice for Determining the Peak Spatial-Average Specific Absorption Rate (SAR) in the Human Body Due to Wireless Communications Devices: Experimental Techniques"

Conditions

Dipole 210-00710 was new taken from stock.

Ambient Temperature of the Laboratory: 22 °C +/- 0.5°C
Temperature of the Tissue: 20 °C +/- 0.5°C

Dipole Calibration uncertainty

The calibration uncertainty for the dipole is made up of various parameters presented below.

Mechanical	1%
Positioning Error	1.22%
Electrical	1.7%
Tissue	2.2%
Dipole Validation	2.2%
TOTAL	8.32% (16.64% K=2)

This page has been reviewed for content and attested to by signature within this document.

NCL Calibration Laboratories

Division of APREL Laboratories.

Dipole Calibration Results

Mechanical Verification

APREL Length	APREL Height	Measured Length	Measured Height
68.0 mm	39.5 mm	67.1mm	38.9 mm

Electrical Validation

Tissue Type	Return Loss:	SWR:	Impedance:
Head	-29.360 dB	1.0732 U	47.869 Ω
Body	-22.799 dB	1.1566 U	48.022 Ω

Tissue Validation

	Dielectric constant, ϵ_r	Conductivity, σ [S/m]
Head Tissue 1900MHz	38.4	1.43
Body Tissue 1900MHz	51.87	1.59

This page has been reviewed for content and attested to by signature within this document.

NCL Calibration Laboratories

Division of APREL Laboratories.

The Following Graphs are the results as displayed on the Vector Network Analyzer.

S11 Parameter Return Loss

Head

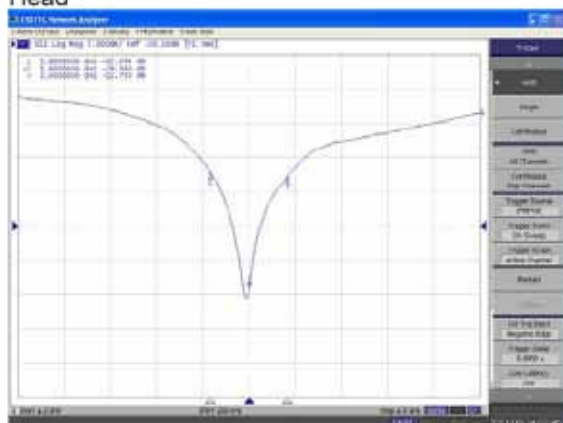

Body

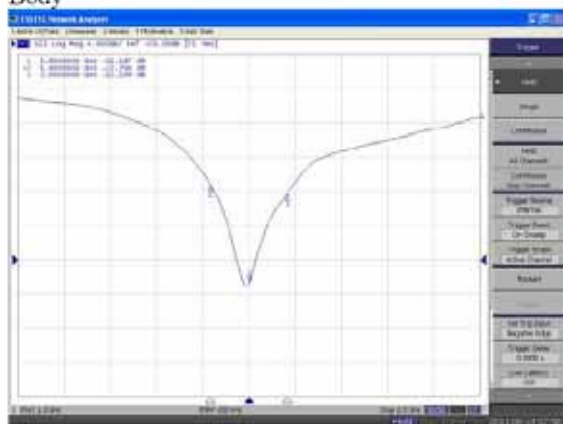

This page has been reviewed for content and attested to by signature within this document.

NCL Calibration Laboratories

Division of APREL Laboratories.

SWR

Head

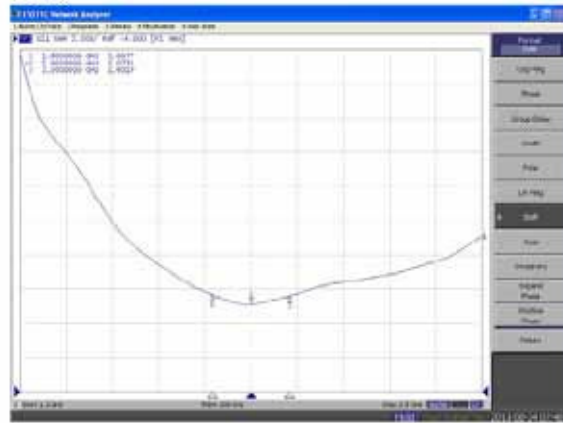

Body

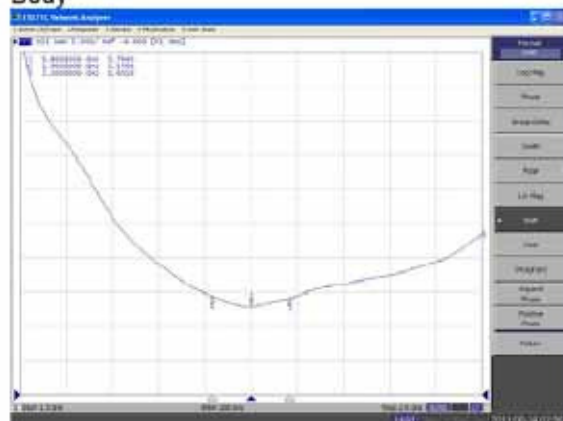

This page has been reviewed for content and attested to by signature within this document.

7

NCL Calibration Laboratories

Division of APREL Laboratories.

Smith Chart Dipole Impedance

Head

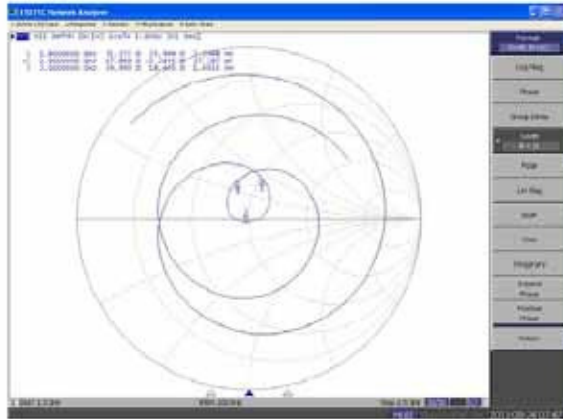

Body

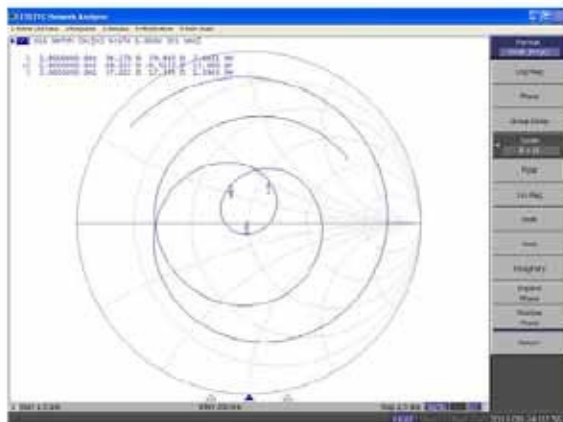

This page has been reviewed for content and attested to by signature within this document.

NCL Calibration Laboratories

Division of APREL Laboratories.

Test Equipment

The test equipment used during Probe Calibration, manufacturer, model number and, current calibration status are listed and located on the main APREL server R:\NCL\Calibration Equipment\Instrument List 2011

This page has been reviewed for content and attested to by signature within this document.

9

1900MHz Dipole Calibration By BACL at 2013-12-20

Mechanical Verification

APREL Length	APREL Height	Measured Length	Measured Height
68.0 mm	39.4 mm	68.3 mm	39.2 mm

Tissue Type	Measured Return Loss	Measured Impedance
Head	-28.083 dB	47.477 Ω
Body	-22.022 dB	48.076 Ω

Test Graphs :

Head Tissue

Return Loss :

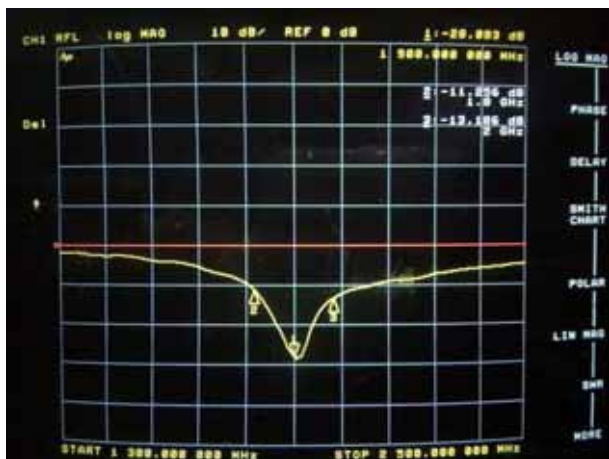

Impedance :



Body Tissue

Return Loss :

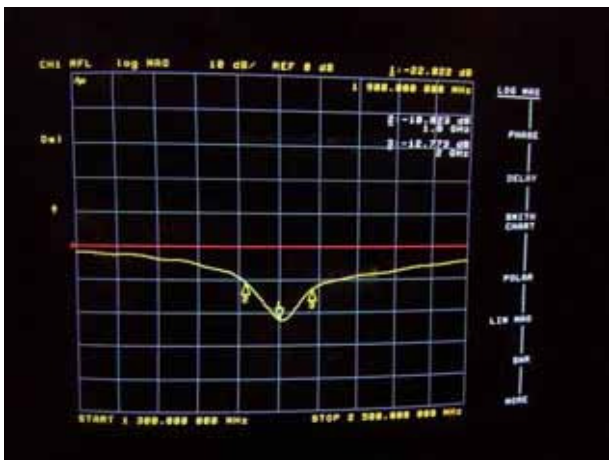

Impedance :



APPENDIX D EUT TEST POSITION PHOTOS

Liquid depth $\geq 15\text{cm}$



Body-worn Front Setup Photo (10mm)

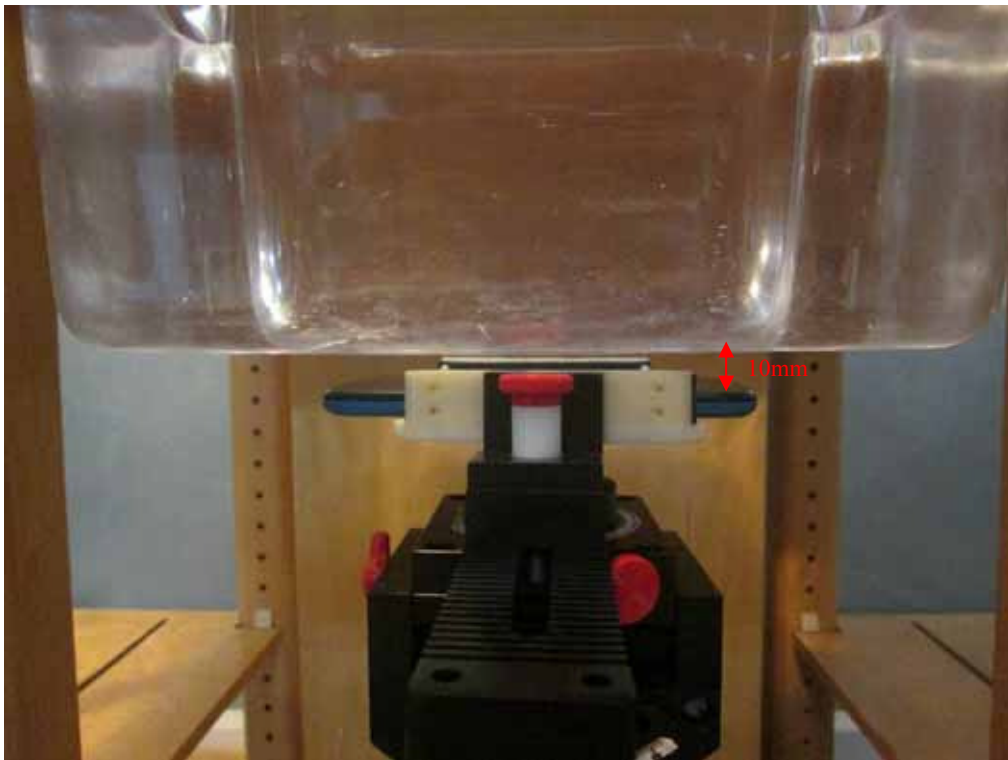

Body-worn Back Setup Photo (10mm)

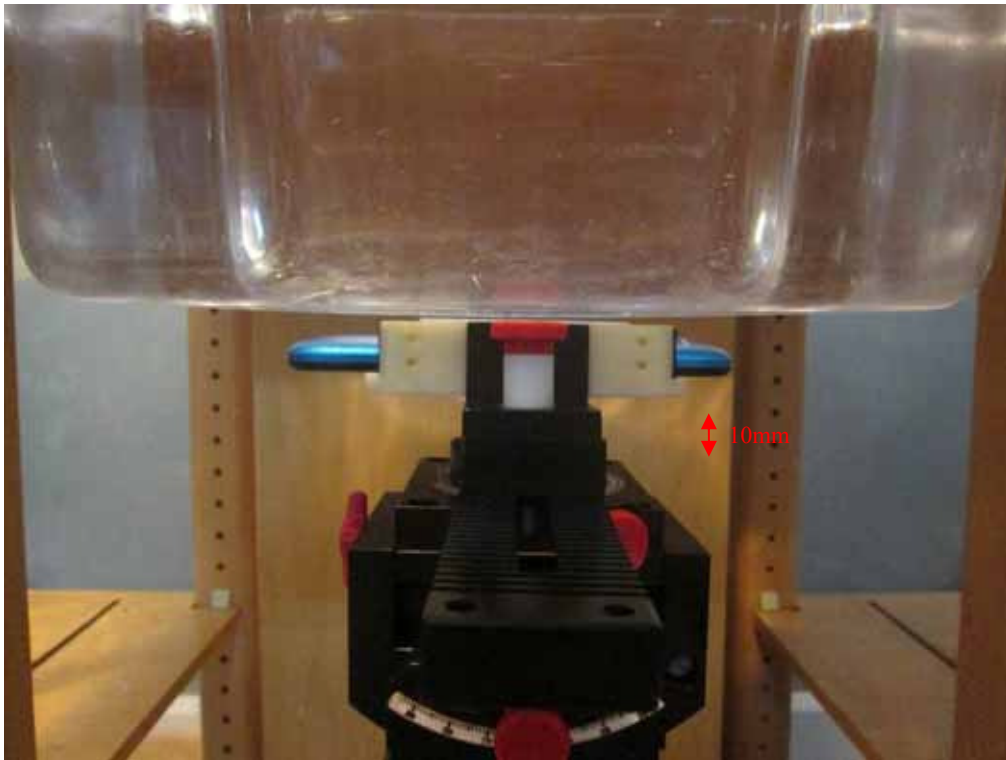

Body-worn Left Setup Photo (10mm)

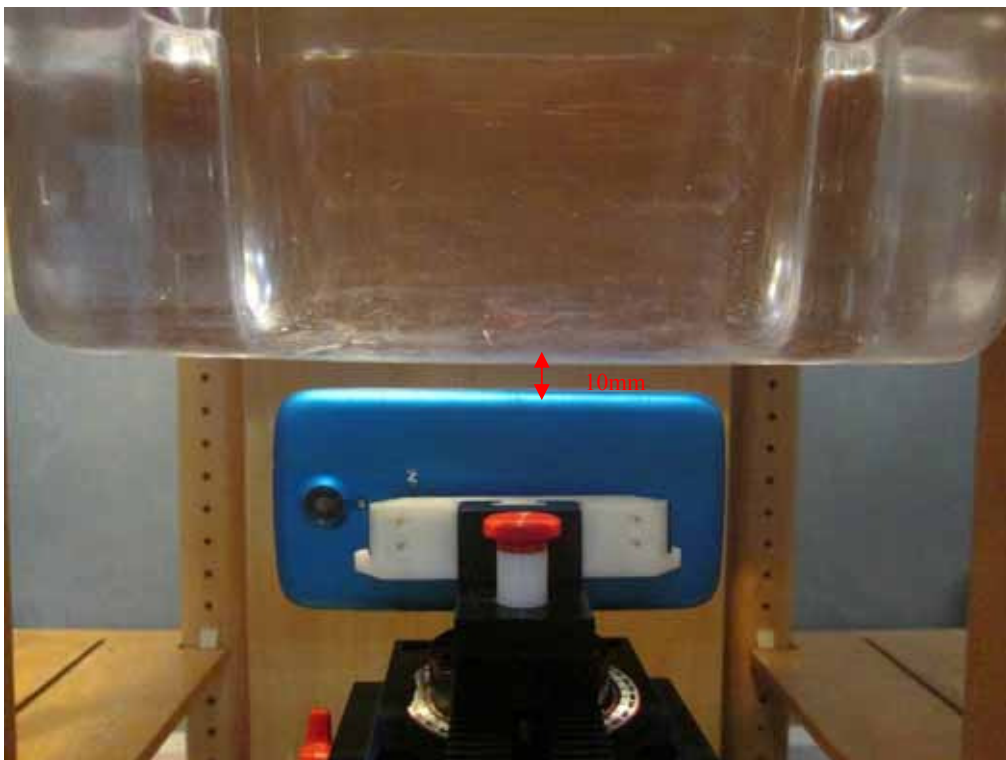

Body-worn Right Setup Photo (10mm)



Body-worn Bottom Setup Photo (10mm)



Left Head Touch Setup Photo

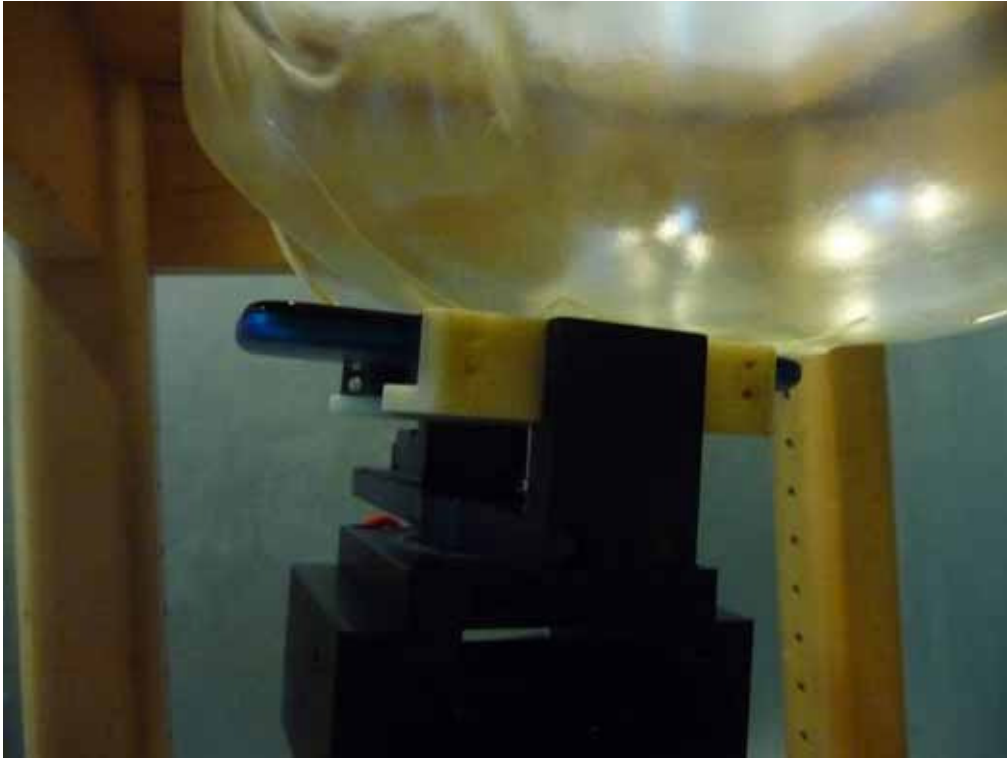

Left Head Tilt Setup Photo

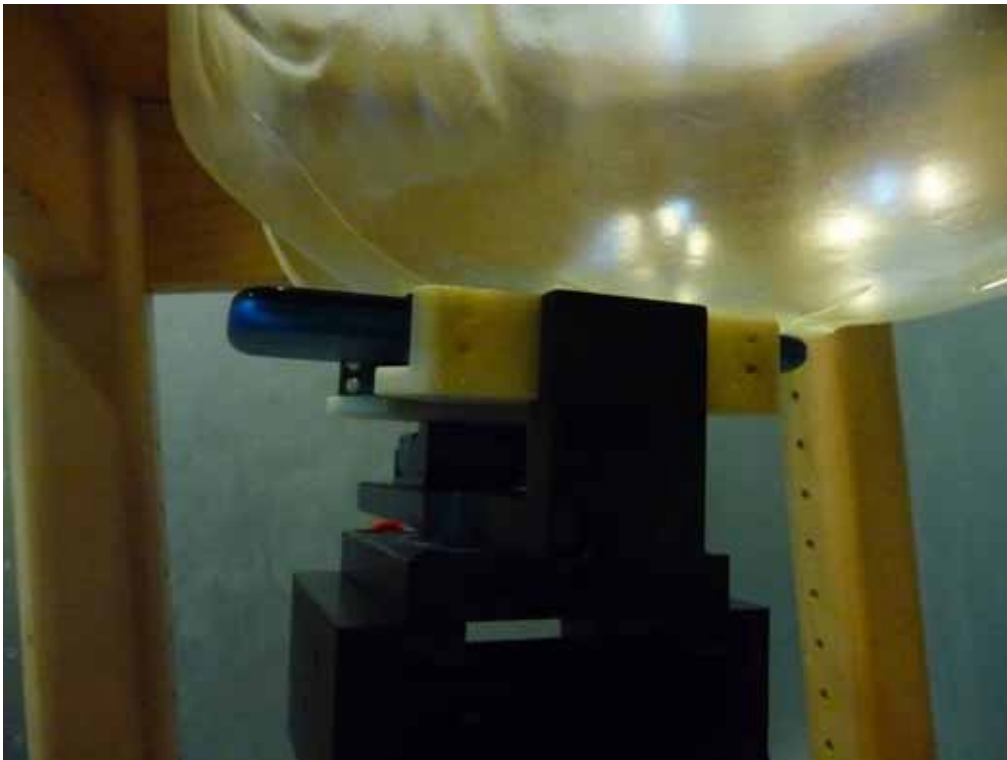

Right Head Touch Setup Photo

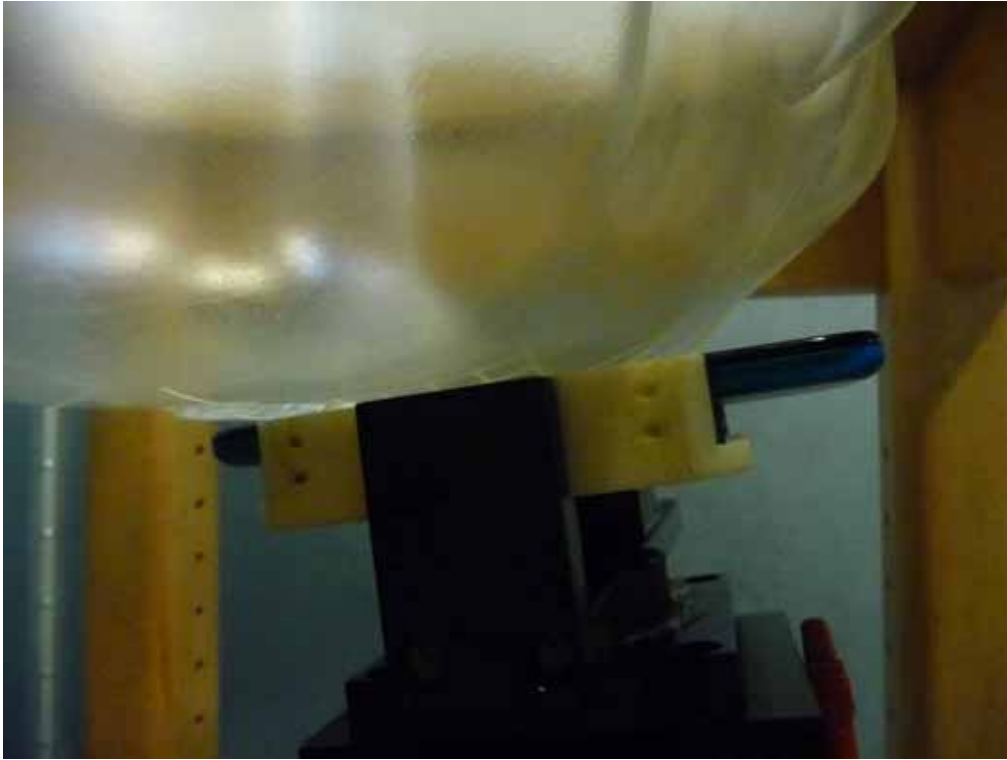

Right Head Tilt Setup Photo

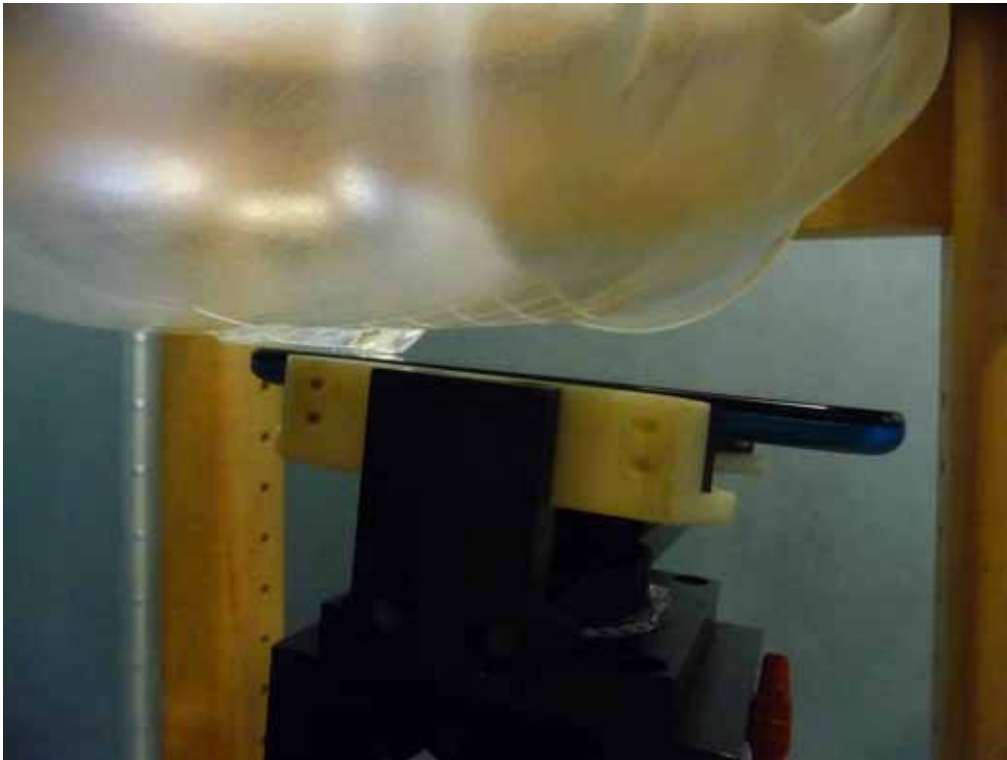

APPENDIX E EUT PHOTOS

EUT – Front View



EUT – Back View



EUT –Right Side View



EUT – Left Side View



EUT – Top View



EUT – Bottom View



APPENDIX F – DECLARATION LETTERS

SWAGTEK

8800NW 23rd Street, Miami, FL33172, United States
Tel: 1-305 421 9938 Fax: 1-305 471 9011

2014/06/17

Product Similarity Declaration

To Whom It May Concern,

We, SWAGTEK, hereby declare that our Mobile Phone, Model Number: 47 is electrically identical with the model number X3 that was tested by BACL. They are just different in model numbers and Appearance colors.

Please contact me if you have any question.

Signature:

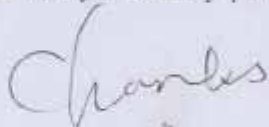

Charles Cheng
Manager

APPENDIX G INFORMATIVE REFERENCES

- [1] Federal Communications Commission, "Report and order: Guidelines for evaluating the environmental effects of radiofrequency radiation", Tech. Rep. FCC 96-326, FCC, Washington, D.C. 20554, 1996.
- [2] David L. Means Kwok Chan, Robert F. Cleveland, "Evaluating compliance with FCC guidelines for human exposure to radiofrequency electromagnetic fields", Tech. Rep., Federal Communication Commission, Office of Engineering & Technology, Washington, DC, 1997.
- [3] Thomas Schmid, Oliver Egger, and Niels Kuster, "Automated E-field scanning system for dosimetric assessments", IEEE Transactions on Microwave Theory and Techniques, vol. 44, pp. 105-113, Jan. 1996.
- [4] Niels Kuster, Ralph Kastle, and Thomas Schmid, "Dosimetric evaluation of mobile communications equipment with known precision", IEEE Transactions on Communications, vol. E80-B, no. 5, pp. 645-652, May 1997.
- [5] CENELEC, "Considerations for evaluating of human exposure to electromagnetic fields (EMFs) from mobile telecommunication equipment (MTE) in the frequency range 30MHz - 6GHz", Tech. Rep., CENELEC, European Committee for Electrotechnical Standardization, Brussels, 1997.
- [6] ANSI, ANSI/IEEE C95.1-1992: IEEE Standard for Safety Levels with Respect to Human Exposure to Radio Frequency Electromagnetic Fields, 3 kHz to 300 GHz, The Institute of Electrical and Electronics Engineers, Inc., New York, NY 10017, 1992.
- [7] Katja Pokovic, Thomas Schmid, and Niels Kuster, "Robust setup for precise calibration of E-field probes in tissue simulating liquids at mobile communications frequencies", in ICECOM '97, Dubrovnik, October 15-17, 1997, pp. 120-24.
- [8] Katja Pokovic, Thomas Schmid, and Niels Kuster, "E-field probe with improved isotropy in brain simulating liquids", in Proceedings of the ELMAR, Zadar, Croatia, 23-25 June, 1996, pp. 172-175.
- [9] Volker Hombach, Klaus Meier, Michael Burkhardt, Eberhard Kuhn, and Niels Kuster, "The dependence of EM energy absorption upon human head modeling at 900 MHz", IEEE Transactions on Microwave Theory and Techniques, vol. 44, no. 10, pp. 1865-1873, Oct. 1996.
- [10] Klaus Meier, Ralf Kastle, Volker Hombach, Roger Tay, and Niels Kuster, "The dependence of EM energy absorption upon human head modeling at 1800 MHz", IEEE Transactions on Microwave Theory and Techniques, Oct. 1997, in press.
- [11] W. Gander, Computermathematik, Birkhaeuser, Basel, 1992.
- [12] W. H. Press, S. A. Teukolsky, W. T. Vetterling, and B. P. Flannery, Numerical Recipes in C, The Art of Scientific Computing, Second Edition, Cambridge University Press, 1992. Dosimetric Evaluation of Sample device, month 1998 9
- [13] NIS81 NAMAS, "The treatment of uncertainty in EMC measurement", Tech. Rep., NAMAS Executive, National Physical Laboratory, Teddington, Middlesex, England, 1994.
- [14] Barry N. Taylor and Christ E. Kuyatt, "Guidelines for evaluating and expressing the uncertainty of NIST measurement results", Tech. Rep., National Institute of Standards and Technology, 1994. Dosimetric Evaluation of Sample device, month 1998 10.

***** END OF REPORT *****