

FCC RADIO TEST REPORT

FCC ID: 055240123

Product : 4G Fixed phone

Trade Mark : LOGIC, ISWAG, UNONU

Model Name : FIXO 240L

Family Model : HEAT 240L

Report No. : STR230201002004E

Issue Date: Mar 01, 2023

Prepared for

SWAGTEK

10205 NW 19th Street STE101 Miami, FL 33172, United States

Prepared by

Shenzhen NTEK Testing Technology Co., Ltd.

1/F, Building E, Fenda Science Park, Sanwei Community,
Xixiang Street Bao'an District, Shenzhen 518126 P.R. China

Tel. 400-800-6106, 0755-2320 0050, 0755-2320 0090

Website: <http://www.ntek.org.cn>

TEST RESULT CERTIFICATION

Applicant's name..... : SWAGTEK INC.
 Address : 10205 NW 19th Street STE101 Miami, FL 33172,United States
Manufacturer's Name : SWAGTEK INC.
 Address : 10205 NW 19th Street STE101 Miami, FL 33172,United States

Product description

Product name : 4G Fixed phone
 Trade Mark : LOGIC, ISWAG, UNONU
 Model and/or type reference : FIXO 240L
 Family Model : HEAT 240L

Test Sample number : T230201002R002

Standards : FCC Part15.407

Test procedure..... ANSI C63.10-2013 and KDB 789033 D02 General UNII Test Procedures New Rules v02r01

This device described above has been tested by NTEK, and the test results show that the equipment under test (EUT) is in compliance with the FCC requirements/ the Industry Canada requirements.. And it is applicable only to the tested sample identified in the report.

This report shall not be reproduced except in full, without the written approval of NTEK, this document may be altered or revised by NTEK, personnel only, and shall be noted in the revision of the document.

Date of Test.....

Date (s) of performance of tests Feb 01, 2023 ~ Mar 01, 2023

Date of Issue Mar 01, 2023

Test Result **Pass**

Testing Engineer : *Mukzi Lee*
 (Mukzi Lee)

Authorized Signatory : *Alex*
 (Alex Li)

Table of Contents

Page

1 . SUMMARY OF TEST RESULTS	6
1.1 FACILITIES AND ACCREDITATIONS	7
1.2 MEASUREMENT UNCERTAINTY	7
2 . GENERAL INFORMATION	8
2.1 GENERAL DESCRIPTION OF EUT	8
2.2 DESCRIPTION OF TEST MODES	10
2.3 BLOCK DIGRAM SHOWING THE CONFIGURATION OF SYSTEM TESTED	11
2.4 DESCRIPTION OF SUPPORT UNITS(CONDUCTED MODE)	12
2.5 EQUIPMENTS LIST FOR ALL TEST ITEMS	13
3 . TEST REQUIREMENTS	15
3.1 CONDUCTED EMISSION MEASUREMENT	15
3.2 RADIATED EMISSION MEASUREMENT	20
3.3 POWER SPECTRAL DENSITY TEST	35
3.4 26DB & 99% EMISSION BANDWIDTH	38
3.5 MINIMUM 6 DB BANDWIDTH	40
3.6 MAXIMUM CONDUCTED OUTPUT POWER	42
3.7 OUT OF BAND EMISSIONS	46
3.8 SPURIOUS RF CONDUCTED EMISSIONS	48
3.9 FREQUENCY STABILITY MEASUREMENT	49
4. ANTENNA REQUIREMENT	56
4.1 STANDARD REQUIREMENT	56
4.2 EUT ANTENNA	56
5. TEST RESULTS	57
5.2G WIFI	57
5.1 DUTY CYCLE	57
5.2 MAXIMUM CONDUCTED OUTPUT POWER	65
5.3 -26DB BANDWIDTH	66
5.4 OCCUPIED CHANNEL BANDWIDTH	74
5.5 MAXIMUM POWER SPECTRAL DENSITY LEVEL	82
5.6 BAND EDGE	90
5.7 CONDUCTED RF SPURIOUS EMISSION	97
5.8G WIFI	105
5.1 DUTY CYCLE	105
5.2 MAXIMUM CONDUCTED OUTPUT POWER	113

Table of Contents**Page**

5.3 -6DB BANDWIDTH	114
5.4 OCCUPIED CHANNEL BANDWIDTH	122
5.5 MAXIMUM POWER SPECTRAL DENSITY LEVEL	130
5.6 BAND EDGE	138
5.7 CONDUCTED RF SPURIOUS EMISSION	145

Revision History

Report No.	Version	Description	Issued Date
STR230201002004E	Rev.01	Initial issue of report	Mar 01, 2023

1. SUMMARY OF TEST RESULTS

Test procedures according to the technical standards:

FCC Part15 (15.407) , Subpart E			
Standard Section	Test Item	Judgment	Remark
15.207	AC Power Line Conducted Emissions	PASS	
15.209(a), 15.407 (b)(1) 15.407 (b)(4)	Spurious Radiated Emissions	PASS	
15.407 (a)(1) 15.407 (a)(3)	26 dB and 99% Emission Bandwidth	PASS	
15.407(e)	Minimum 6 dB bandwidth	PASS	
15.407 (a)(1) 15.407 (a)(3)	Maximum Conducted Output Power	PASS	
15.407(b)(1) 15.407(b)(4)	Band Edge	PASS	
15.407 (a)(1) 15.407 (a)(3)	Power Spectral Density	PASS	
15.407(b)	Spurious Emissions at Antenna Terminals	PASS	
15.203	Antenna Requirement	PASS	
15.407(c)	Automatically discontinue transmission	PASS	

NOTE:

(1) "N/A" denotes test is not applicable in this Test Report

1.1 FACILITIES AND ACCREDITATIONS

FACILITIES

All measurement facilities used to collect the measurement data are located at 1/F, Building E, Fenda Science Park, Sanwei Community, Xixiang Street, Bao'an District, Shenzhen 518126 P.R. China.

The sites are constructed in conformance with the requirements of ANSI C63.7, ANSI C63.10 and CISPR Publication 22.

LABORATORY ACCREDITATIONS AND LISTINGS

Site Description

CNAS-Lab. : The Certificate Registration Number is L5516.

IC-Registration : The Certificate Registration Number is 9270A.
CAB identifier:CN0074

FCC- Accredited : Test Firm Registration Number: 463705.
Designation Number: CN1184

A2LA-Lab. : The Certificate Registration Number is 4298.01
This laboratory is accredited in accordance with the recognized International Standard ISO/IEC 17025:2005 General requirements for the competence of testing and calibration laboratories.
This accreditation demonstrates technical competence for a defined scope and the operation of a laboratory quality management system (refer to joint ISO-ILAC-IAF Communiqué dated 8 January 2009).

Name of Firm : Shenzhen NTEK Testing Technology Co., Ltd.

Site Location : 1/F, Building E, Fenda Science Park, Sanwei Community, Xixiang Street, Bao'an District, Shenzhen 518126 P.R. China.

1.2 MEASUREMENT UNCERTAINTY

The reported uncertainty of measurement $y \pm U$, where expanded uncertainty U is based on a standard uncertainty multiplied by a coverage factor of $k=2$, providing a level of confidence of approximately 95 %.

No.	Item	Uncertainty
1	Conducted Emission Test	$\pm 2.80\text{dB}$
2	RF power, conducted	$\pm 0.16\text{dB}$
3	Spurious emissions, conducted	$\pm 0.21\text{dB}$
4	All emissions, radiated(30MHz~1GHz)	$\pm 2.64\text{dB}$
5	All emissions, radiated(1GHz~6GHz)	$\pm 2.40\text{dB}$
6	All emissions, radiated(> 6GHz)	$\pm 2.52\text{dB}$
7	Temperature	$\pm 0.5^\circ\text{C}$
8	Humidity	$\pm 2\%$
9	All emissions, radiated(9KHz~30MHz)	$\pm 6\text{dB}$

2. GENERAL INFORMATION

2.1 GENERAL DESCRIPTION OF EUT

Equipment	4G Fixed phone	
Trade Mark	LOGIC, ISWAG, UNONU	
FCC ID	O55240123	
Model Name	FIXO 240L	
Family Model	HEAT 240L	
Model Difference	All the model are the same circuit and RF module,except the model name.	
Product Description	IEEE 802.11 WLAN Mode Supported	<input checked="" type="checkbox"/> 802.11a/n/ac (20MHz channel bandwidth) <input checked="" type="checkbox"/> 802.11n/ac (40MHz channel bandwidth) <input checked="" type="checkbox"/> 802.11ac (80MHz channel bandwidth)
	Modulation	OFDM with BPSK/QPSK/16QAM/64QAM/256QAM for 802.11a/n/ac;
	Operating Frequency Range	<input checked="" type="checkbox"/> 5180-5240MHz for 802.11a/n(HT20)/ac(VHT20); 5190-5230MHz for 802.11n(HT40)/ac(VHT40); 5210MHz for 802.11ac(VHT80) <input checked="" type="checkbox"/> 5745-5825 MHz for 802.11a/n(HT20)/ac(VHT20); 5755-5795 MHz for 802.11n(HT40)/ac(VHT40); 5775MHz for 802.11ac(VHT80)
	Number of Channels	<input checked="" type="checkbox"/> 4 channels for 802.11a/n20/ac20 in the 5180-5240MHz band ; 2 channels for 802.11 n40/ac40 in the 5190-5230MHz band ; 1 channels for 802.11 ac80 in the 5210MHz band ; <input checked="" type="checkbox"/> 5 channels for 802.11a/n20/ac20 in the 5745-5825MHz band ; 2 channels for 802.11 n40/ac40 in the 5755-5795MHz band ; 1 channels for 802.11 ac80 in the 5775MHz band ;
	Antenna Type	PIFA Antenna
	Antenna Gain	1.15 dBi
	Based on the application, features, or specification exhibited in User's Manual, More details of EUT technical specification, please refer to the User's Manual.	
Adapter	Model: FIXO 240L Input: AC 100-240V~50/60Hz 0.15A Output: DC 5.0V---500mA	
Battery	DC 3.7V, 1400mAh, 5.18Wh	
Power supply	DC 3.7V from battery or DC 5V from adapter	
Connecting I/O Port(s)	Please refer to the User's Manual	
HW Version	MM6223-MB-V1.0	
SW Version	LOGIC_FIXO_240L	

Note:

1. For a more detailed features description, please refer to the manufacturer's specifications or the User's Manual.
2. Frequency and Channel list for 802.11a/n/ac(20MHz) band I (5180-5240MHz):

802.11a/n/ac(20MHz) Carrier Frequency Channel							
Channel	Frequency (MHz)	Channel	Frequency (MHz)	Channel	Frequency (MHz)	Channel	Frequency (MHz)
36	5180	44	5220	-	-	-	-
40	5200	48	5240	-	-	-	-

Frequency and Channel list for 802.11n/ac(40MHz) band I (5190-5230MHz):

802.11n/ac(40MHz) Carrier Frequency Channel							
Channel	Frequency (MHz)	Channel	Frequency (MHz)	Channel	Frequency (MHz)	Channel	Frequency (MHz)
38	5190	-	-	-	-	-	-
46	5230	-	-	-	-	-	-

Frequency and Channel list for 802.11ac(80MHz) band I (5210MHz):

802.11ac(80MHz) Carrier Frequency Channel							
Channel	Frequency (MHz)	Channel	Frequency (MHz)	Channel	Frequency (MHz)	Channel	Frequency (MHz)
42	5210	-	-	-	-	-	-

Frequency and Channel list for 802.11a/n/ac(20 MHz) band IV (5745-5825MHz):

802.11a/n/ac(20 MHz) Carrier Frequency Channel							
Channel	Frequency (MHz)	Channel	Frequency (MHz)	Channel	Frequency (MHz)	Channel	Frequency (MHz)
149	5745	153	5765	157	5785	161	5805
165	5825	-	-	-	-	-	-

Frequency and Channel list for 802.11n/ac(40MHz) band IV (5755-5795MHz):

802.11n/ac(40MHz) Carrier Frequency Channel					
Channel	Frequency (MHz)	Channel	Frequency (MHz)	Channel	Frequency (MHz)
151	5755	159	5795	-	-

Frequency and Channel list for 802.11ac(80MHz) band IV (5775MHz):

802.11ac(80MHz) Carrier Frequency Channel					
Channel	Frequency (MHz)	Channel	Frequency (MHz)	Channel	Frequency (MHz)
155	5775	-	-	-	-

2.2 DESCRIPTION OF TEST MODES

To investigate the maximum EMI emission characteristics generates from EUT, the test system was pre-scanning tested base on the consideration of following EUT operation mode or test configuration mode which possible have effect on EMI emission level. Each of these EUT operation mode(s) or test configuration mode(s) mentioned above was evaluated respectively.

Pretest Mode	Description
Mode 1	Normal Link Mode
Mode 2	802.11a / n 20 / ac 20 CH36/ CH40/ CH 48 802.11a / n 20 / ac 20 CH149/ CH157/ CH 165
Mode 3	802.11n40 / ac40 CH38/ CH 46 802.11n 40 / ac 40 CH 151 / CH 159
Mode 4	802.11ac80 CH 42 802.11ac 80 CH 155

For Radiated Emission	
Final Test Mode	Description
Mode 1	Normal Link Mode
Mode 2	802.11a / n 20 / ac 20 CH36/ CH40/ CH 48 802.11a / n 20 / ac 20 CH149/ CH157/ CH 165
Mode 3	802.11n40 / ac40 CH38/ CH 46 802.11n 40 / ac 40 CH 151 / CH 159
Mode 4	802.11ac80 CH 42 802.11ac 80 CH 155

Note:

- (1) The measurements are performed at the highest, middle, lowest available channels.
- (2) The measurements are performed at all Bit Rate of Transmitter, the worst data was reported

2.3 BLOCK DIGRAM SHOWING THE CONFIGURATION OF SYSTEM TESTED

For AC Conducted Emission Mode

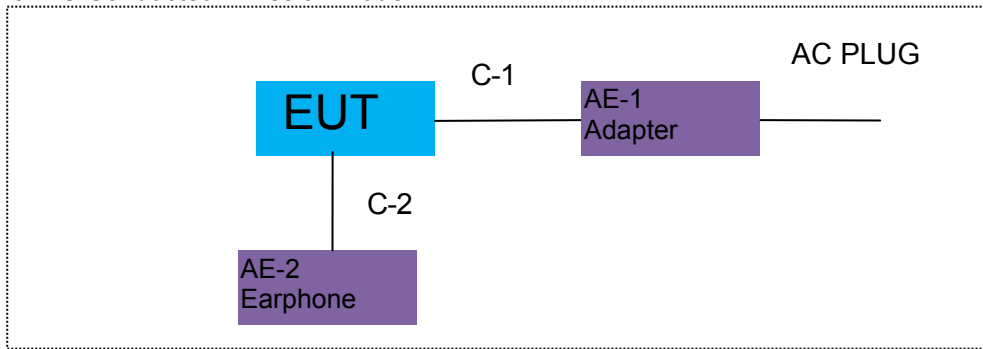

For Radiated Test Cases

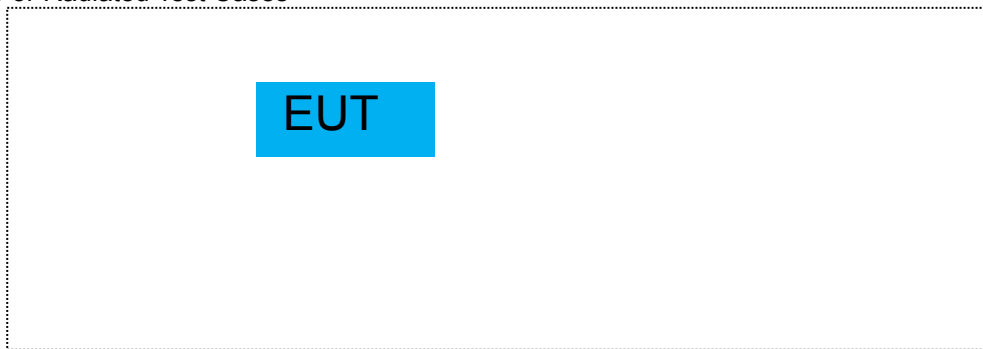

For Conducted Test Cases

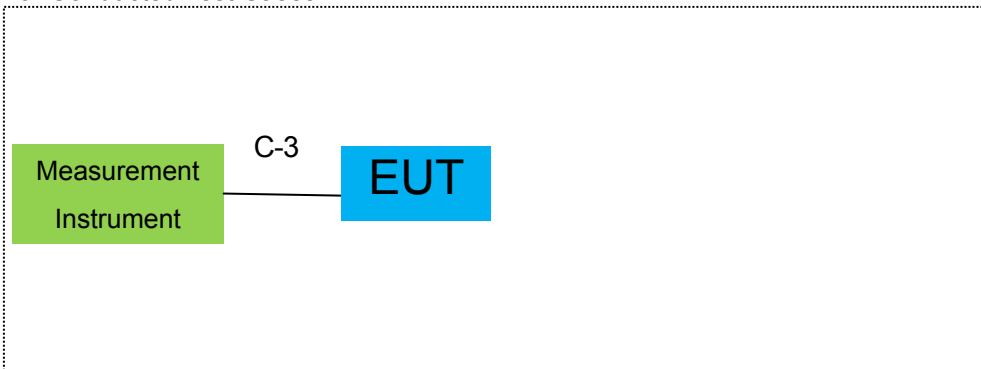

Note:1.The temporary antenna connector is soldered on the PCB board in order to perform conducted tests and this temporary antenna connector is listed in the equipment list.
 2.EUT built-in battery-powered, the battery is fully-charged.

2.4 DESCRIPTION OF SUPPORT UNITS(CONDUCTED MODE)

The EUT has been tested as an independent unit together with other necessary accessories or support units. The following support units or accessories were used to form a representative test configuration during the tests.

Item	Equipment	Model/Type No.	Series No.	Note
AE-1	Adapter	FIXO 240L	N/A	Peripherals
AE-2	Earphone	N/A	N/A	Peripherals

Item	Cable Type	Shielded Type	Ferrite Core	Length
C-1	USB Cable	NO	NO	0.75m
C-2	Earphone Cable	NO	NO	1.2m
C-3	RF Cable	YES	NO	0.1m

Note:

- (1) The support equipment was authorized by Declaration of Confirmation.
- (2) For detachable type I/O cable should be specified the length in cm in 『Length』 column.

2.5 EQUIPMENTS LIST FOR ALL TEST ITEMS

Radiation& Conducted Test equipment

	Kind of Equipment	Manufacturer	Type No.	Serial No.	Last calibration	Calibrated until	Calibration period
1	Spectrum Analyzer	Agilent	E4407B	MY45108040	2022.04.01	2023.03.31	1 year
2	Spectrum Analyzer	Agilent	N9020A	MY49100060	2022.04.01	2023.03.31	1 year
3	Spectrum Analyzer	R&S	FSV40	101417	2022.06.16	2023.06.15	1 year
4	Test Receiver	R&S	ESPI7	101318	2022.04.06	2023.04.05	1 year
5	Bilog Antenna	TESEQ	CBL6111D	31216	2022.03.30	2023.03.29	1 year
6	50Ω Coaxial Switch	Anritsu	MP59B	6200983705	2020.05.11	2023.05.10	3 year
7	Horn Antenna	EM	EM-AH-10180	2011071402	2022.03.31	2023.03.30	1 year
8	Broadband Horn Antenna	SCHWARZBECK	BBHA 9170	803	2022.11.07	2023.11.06	1 year
9	Amplifier	EMC	EMC051835SE	980246	2022.06.17	2023.06.16	1 year
10	Active Loop Antenna	SCHWARZBECK	FMZB 1519B	055	2022.11.04	2023.11.03	1 year
11	Power Meter	DARE	RPR3006W	15I00041SN084	2022.06.16	2023.06.15	1 year
12	Test Cable (9KHz-30MHz)	N/A	R-01	N/A	2022.06.17	2025.06.16	3 year
13	Test Cable (30MHz-1GHz)	N/A	R-02	N/A	2022.06.17	2025.06.16	3 year
14	High Test Cable(1G-40GHz)	N/A	R-03	N/A	2022.06.17	2025.06.16	3 year
15	Filter	TRILTHIC	2400MHz	29	2020.04.07	2023.04.06	3 year
16	temporary antenna connector (Note)	NTS	R001	N/A	N/A	N/A	N/A

Note:

We will use the temporary antenna connector (soldered on the PCB board) When conducted test
 And this temporary antenna connector is listed within the instrument list

AC Conduction Test equipment

Item	Kind of Equipment	Manufacturer	Type No.	Serial No.	Last calibration	Calibrated until	Calibration period
1	Test Receiver	R&S	ESCI	101160	2022.04.06	2023.04.05	1 year
2	LISN	R&S	ENV216	101313	2022.04.06	2023.04.05	1 year
3	LISN	SCHWARZBECK	NNLK 8129	8129245	2022.04.06	2023.04.05	1 year
4	50Ω Coaxial Switch	ANRITSU CORP	MP59B	6200983704	2020.05.11	2023.05.10	3 year
5	Test Cable (9KHz-30MHz)	N/A	C01	N/A	2020.05.11	2023.05.10	3 year
6	Test Cable (9KHz-30MHz)	N/A	C02	N/A	2020.05.11	2023.05.10	3 year
7	Test Cable (9KHz-30MHz)	N/A	C03	N/A	2020.05.11	2023.05.10	3 year

Note: Each piece of equipment is scheduled for calibration once a year except the Test Cable& Aux Equipment which is scheduled for calibration every 3 years.

3. TEST REQUIREMENTS

3.1 CONDUCTED EMISSION MEASUREMENT

3.1.1 APPLICABLE STANDARD

According to FCC Part 15.207(a)

3.1.2 CONFORMANCE LIMIT

Frequency(MHz)	Conducted Emission Limit	
	Quasi-peak	Average
0.15-0.5	66-56*	56-46*
0.5-5.0	56	46
5.0-30.0	60	50

Note: 1. *Decreases with the logarithm of the frequency
 2. The lower limit shall apply at the transition frequencies
 3. The limit decreases in line with the logarithm of the frequency in the range of 0.15 to 0.50MHz.

3.1.3 TEST CONFIGURATION

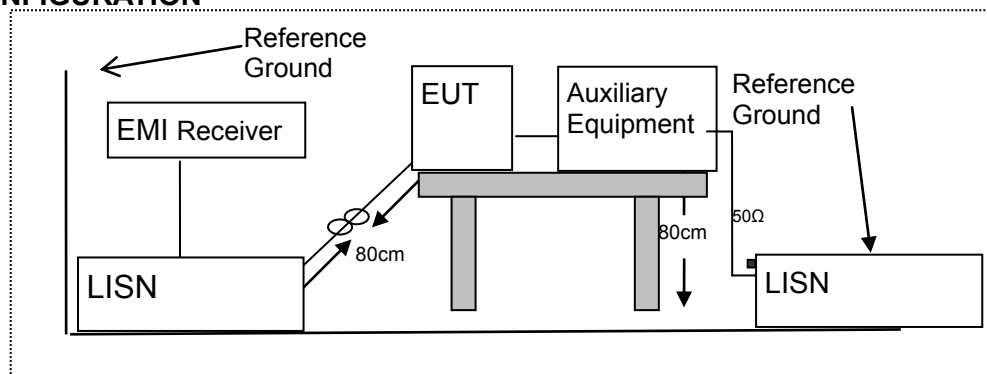

3.1.4 TEST PROCEDURE

According to the requirements in Section 13.1.4.1 of ANSI C63.10-2013 Conducted emissions the EUT measured in the frequency range between 0.15 MHz and 30 MHz using CISPR Quasi-Peak and average detector mode.

1. The EUT was placed 0.4 meter from the conducting wall of the shielding room.
2. The EUT was placed on a table which is 0.8m above ground plane.
3. Connect EUT to the power mains through a line impedance stabilization network (LISN). All other support equipments powered from additional LISN(s). The LISN provide 50 Ohm/ 50uH of coupling impedance for the measuring instrument.
4. Interconnecting cables that hang closer than 40 cm to the ground plane shall be folded back and forth in the center forming a bundle 30 to 40cm long.
5. I/O cables that are not connected to a peripheral shall be bundled in the center. The end of the cable may be terminated, if required, using the correct terminating impedance. The overall length shall not exceed 1 m.
6. LISN at least 80 cm from nearest part of EUT chassis.
7. The frequency range from 150KHz to 30MHz was searched.
8. Set the test-receiver system to Peak Detect Function and specified bandwidth(IF bandwidth=9KHz) with Maximum Hold Mode
9. For the actual test configuration, please refer to the related Item –EUT Test Photos.

3.1.5 TEST RESULTS

EUT :	4G Fixed phone	Model Name :	FIXO 240L
Temperature :	22°C	Relative Humidity :	57%
Pressure :	1010hPa	Phase :	L
Test Voltage :	DC 5V from Adapter AC 120V/60Hz	Test Mode :	Mode 1(5.2G)

Frequency (MHz)	Reading Level (dBμV)	Correct Factor (dB)	Measure-ment (dBμV)	Limits (dBμV)	Margin (dB)	Remark
0.1539	45.69	9.60	55.29	65.78	-10.49	QP
0.1539	21.23	9.60	30.83	55.78	-24.95	AVG
0.1785	37.68	9.61	47.29	64.55	-17.26	QP
0.1785	18.78	9.61	28.39	54.55	-26.16	AVG
0.2300	34.59	9.63	44.22	62.45	-18.23	QP
0.2300	15.63	9.63	25.26	52.45	-27.19	AVG
1.5300	30.80	9.67	40.47	56.00	-15.53	QP
1.5300	21.66	9.67	31.33	46.00	-14.67	AVG
5.5857	20.17	9.80	29.97	60.00	-30.03	QP
5.5857	10.46	9.80	20.26	50.00	-29.74	AVG
15.4657	22.57	10.10	32.67	60.00	-27.33	QP
15.4657	14.05	10.10	24.15	50.00	-25.85	AVG

Remark:

1. All readings are Quasi-Peak and Average values.
2. Factor = Insertion Loss + Cable Loss.

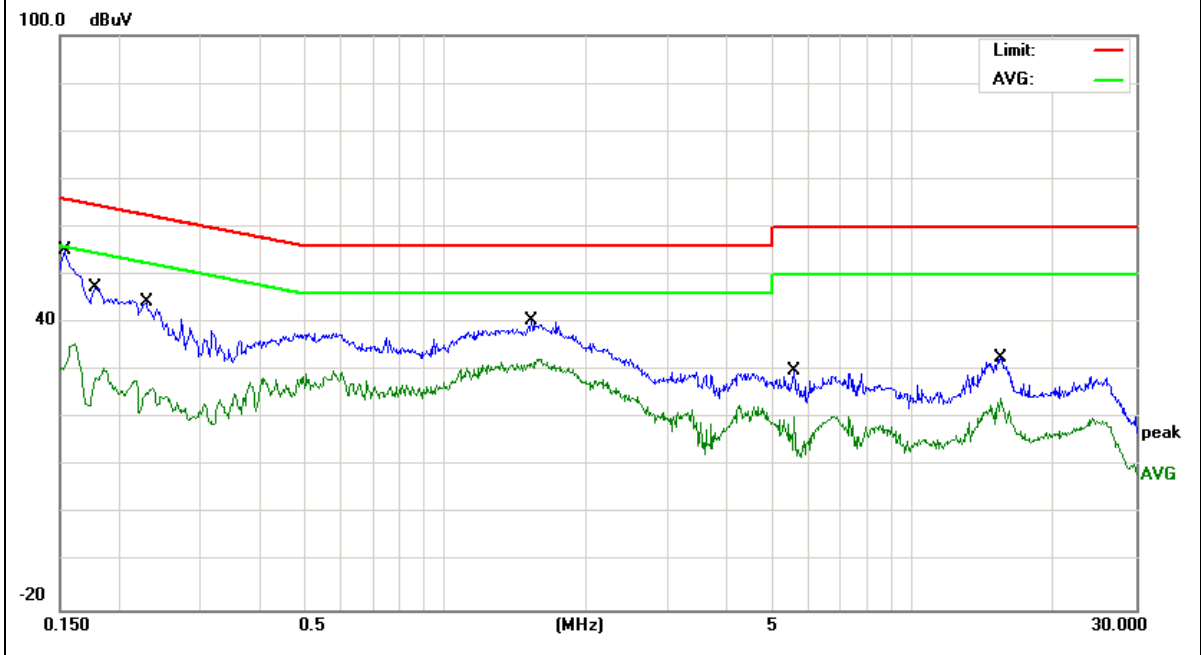

EUT :	4G Fixed phone	Model Name :	FIXO 240L
Temperature :	22°C	Relative Humidity :	57%
Pressure :	1010hPa	Phase :	N
Test Voltage :	DC 5V from Adapter AC 120V/60Hz	Test Mode :	Mode 1(5.2G)

Frequency (MHz)	Reading Level (dBμV)	Correct Factor (dB)	Measure-ment (dBμV)	Limits (dBμV)	Margin (dB)	Remark
0.1940	40.79	9.63	50.42	63.86	-13.44	QP
0.1940	28.85	9.63	38.48	53.86	-15.38	AVG
0.2580	38.14	9.62	47.76	61.49	-13.73	QP
0.2580	25.75	9.62	35.37	51.49	-16.12	AVG
0.4660	32.17	9.66	41.83	56.58	-14.75	QP
0.4660	18.66	9.66	28.32	46.58	-18.26	AVG
1.5500	35.95	9.67	45.62	56.00	-10.38	QP
1.5500	23.88	9.67	33.55	46.00	-12.45	AVG
2.2820	30.70	9.68	40.38	56.00	-15.62	QP
2.2820	17.44	9.68	27.12	46.00	-18.88	AVG
4.1299	30.01	9.72	39.73	56.00	-16.27	QP
4.1299	17.91	9.72	27.63	46.00	-18.37	AVG

Remark:

1. All readings are Quasi-Peak and Average values.
2. Factor = Insertion Loss + Cable Loss.

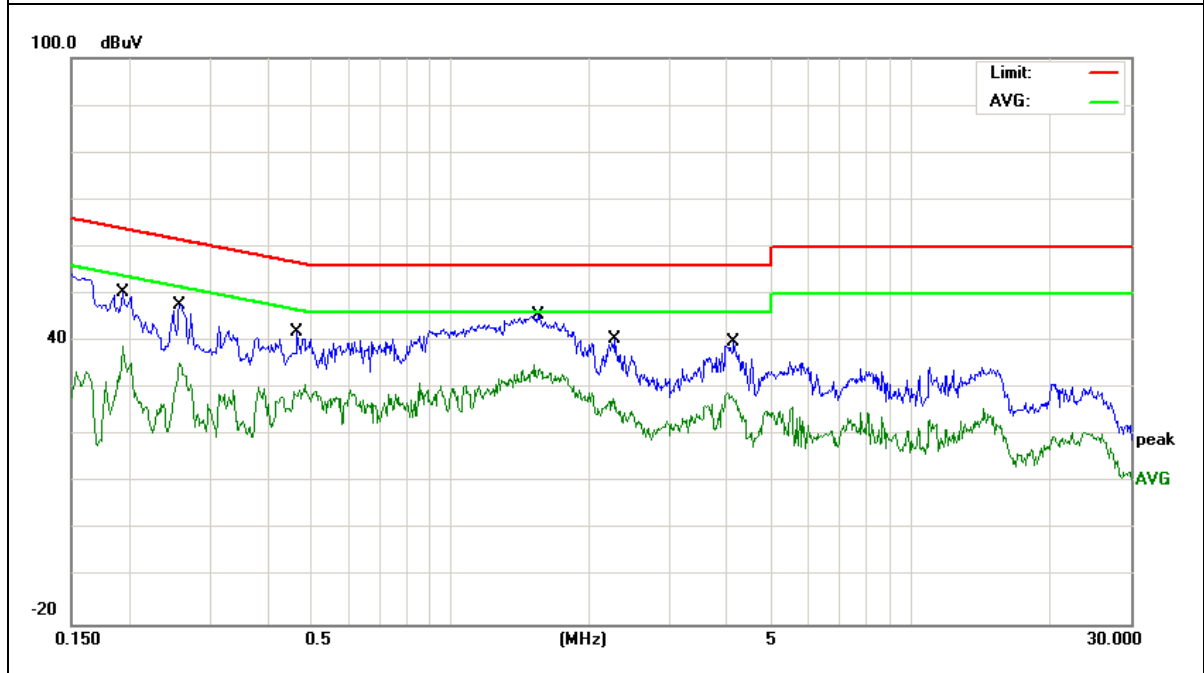

EUT :	4G Fixed phone	Model Name :	FIXO 240L
Temperature :	22 °C	Relative Humidity :	57%
Pressure :	1010hPa	Phase :	L
Test Voltage :	DC 5V from Adapter AC 120V/60Hz	Test Mode :	Mode 1(5.8G)

Frequency (MHz)	Reading Level (dBμV)	Correct Factor (dB)	Measure-ment (dBμV)	Limits (dBμV)	Margin (dB)	Remark
0.1539	46.09	9.60	55.69	65.78	-10.09	QP
0.1539	22.23	9.60	31.83	55.78	-23.95	AVG
0.1779	39.80	9.61	49.41	64.58	-15.17	QP
0.1779	20.78	9.61	30.39	54.58	-24.19	AVG
0.2740	33.14	9.63	42.77	60.99	-18.22	QP
0.2740	13.74	9.63	23.37	50.99	-27.62	AVG
0.3180	31.65	9.64	41.29	59.76	-18.47	QP
0.3180	12.12	9.64	21.76	49.76	-28.00	AVG
1.5300	30.80	9.67	40.47	56.00	-15.53	QP
1.5300	21.66	9.67	31.33	46.00	-14.67	AVG
14.8579	24.83	10.08	34.91	60.00	-25.09	QP
14.8579	11.85	10.08	21.93	50.00	-28.07	AVG

Remark:

- All readings are Quasi-Peak and Average values.
- Factor = Insertion Loss + Cable Loss.

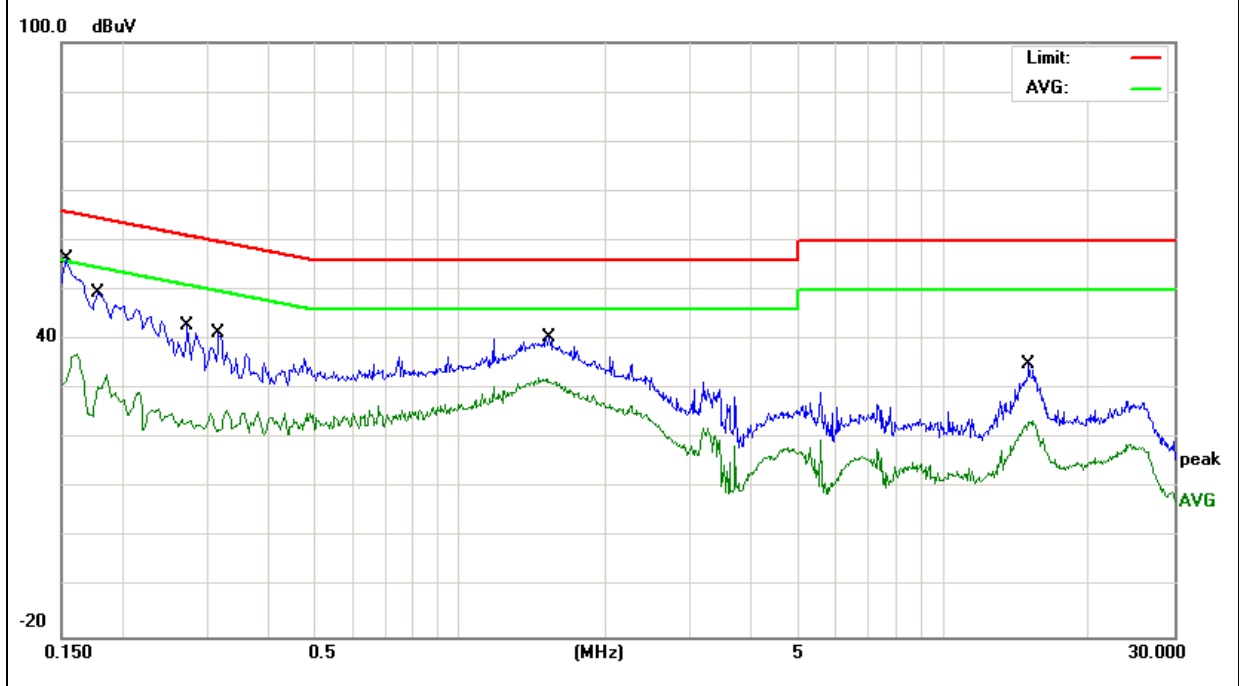

EUT :	4G Fixed phone	Model Name :	FIXO 240L
Temperature :	22 °C	Relative Humidity :	57%
Pressure :	1010hPa	Phase :	N
Test Voltage :	DC 5V from Adapter AC 120V/60Hz	Test Mode :	Mode 1(5.8G)

Frequency (MHz)	Reading Level (dBμV)	Correct Factor (dB)	Measure-ment (dBμV)	Limits (dBμV)	Margin (dB)	Remark
0.1940	46.29	9.63	55.92	63.86	-7.94	QP
0.1940	34.35	9.63	43.98	53.86	-9.88	AVG
0.2580	41.14	9.62	50.76	61.49	-10.73	QP
0.2580	28.75	9.62	38.37	51.49	-13.12	AVG
1.6814	36.48	9.67	46.15	56.00	-9.85	QP
1.6814	24.00	9.67	33.67	46.00	-12.33	AVG
2.2820	35.20	9.68	44.88	56.00	-11.12	QP
2.2820	21.94	9.68	31.62	46.00	-14.38	AVG
15.1979	27.13	10.05	37.18	60.00	-22.82	QP
15.1979	13.66	10.05	23.71	50.00	-26.29	AVG
20.1219	23.26	10.15	33.41	60.00	-26.59	QP
20.1219	8.51	10.15	18.66	50.00	-31.34	AVG

Remark:

1. All readings are Quasi-Peak and Average values.
2. Factor = Insertion Loss + Cable Loss.



3.2 RADIATED EMISSION MEASUREMENT

3.2.1 APPLICABLE STANDARD

According to FCC Part 15.407(b) and 15.209

3.2.2 CONFORMANCE LIMIT

According to FCC Part 15.407(b)(7): radiated emissions which fall in the restricted bands, as defined in §15.205(a), must also comply with the radiated emission limits specified in §15.209(a) (see §15.205(c)).

According to FCC Part 15.205, Restricted bands

MHz	MHz	MHz	GHz
0.090-0.110	16.42-16.423	399.9-410	4.5-5.15
0.495-0.505	16.69475-16.69525	608-614	5.35-5.46
2.1735-2.1905	16.80425-16.80475	960-1240	7.25-7.75
4.125-4.128	25.5-25.67	1300-1427	8.025-8.5
4.17725-4.17775	37.5-38.25	1435-1626.5	9.0-9.2
4.20725-4.20775	73-74.6	1645.5-1646.5	9.3-9.5
6.215-6.218	74.8-75.2	1660-1710	10.6-12.7
6.26775-6.26825	123-138	2200-2300	14.47-14.5
8.291-8.294	149.9-150.05	2310-2390	15.35-16.2
8.362-8.366	156.52475-156.52525	2483.5-2500	17.7-21.4
8.37625-8.38675	156.7-156.9	2690-2900	22.01-23.12
8.41425-8.41475	162.0125-167.17	3260-3267	23.6-24.0
12.29-12.293	167.72-173.2	3332-3339	31.2-31.8
12.51975-12.52025	240-285	3345.8-3358	36.43-36.5
12.57675-12.57725	322-335.4	3600-4400	(2)
13.36-13.41			

20dBc in any 100 kHz bandwidth outside the operating frequency band. In case the emission fall within the restricted band specified on 15.205(a), then the 15.209(a) limit in the table below has to be followed.

Restricted Frequency(MHz)	Field Strength ($\mu\text{V}/\text{m}$)	Field Strength ($\text{dB}\mu\text{V}/\text{m}$)	Measurement Distance
0.009~0.490	2400/F(KHz)	20 log ($\mu\text{V}/\text{m}$)	300
0.490~1.705	24000/F(KHz)	20 log ($\mu\text{V}/\text{m}$)	30
1.705~30.0	30	29.5	30
30-88	100	40	3
88-216	150	43.5	3
216-960	200	46	3
Above 960	500	54	3

Limits of Radiated Emission Measurement(Above 1000MHz)

Frequency(MHz)	Class B ($\text{dB}\mu\text{V}/\text{m}$) (at 3M)	
	PEAK	AVERAGE
Above 1000	74	54

Remark : 1. Emission level in $\text{dB}\mu\text{V}/\text{m}=20 \log (\mu\text{V}/\text{m})$

2. Measurement was performed at an antenna to the closed point of EUT distance of meters.

3. For Frequency 9kHz~30MHz:

Distance extrapolation factor = $40 \log (\text{Specific distance}/ \text{test distance})(\text{dB})$;

Limit line=Specific limits($\text{dB}\mu\text{V}$) + distance extrapolation factor.

For Frequency above 30MHz:

Distance extrapolation factor = $20 \log (\text{Specific distance}/ \text{test distance})(\text{dB})$;

Limit line=Specific limits($\text{dB}\mu\text{V}$) + distance extrapolation factor.

3.2.3 MEASURING INSTRUMENTS

The Measuring equipment is listed in the section 6.3 of this test report.

3.2.4 TEST CONFIGURATION

(a) For radiated emissions below 30MHz

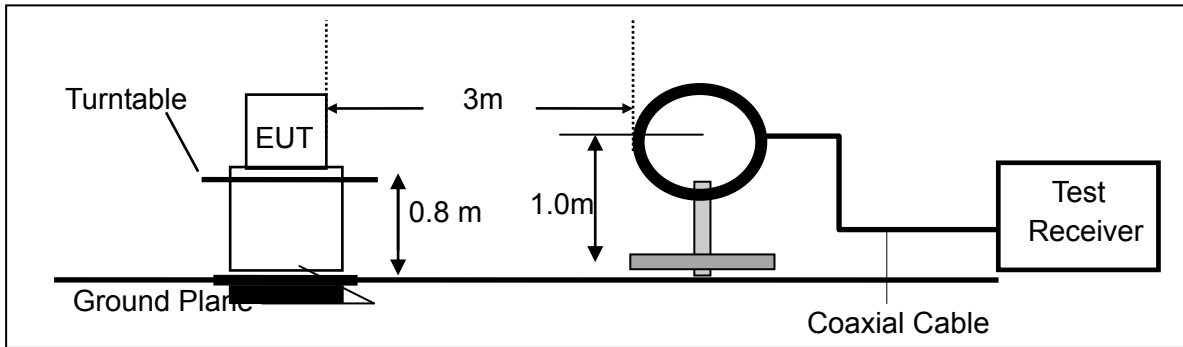

(b) For radiated emissions from 30MHz to 1000MHz

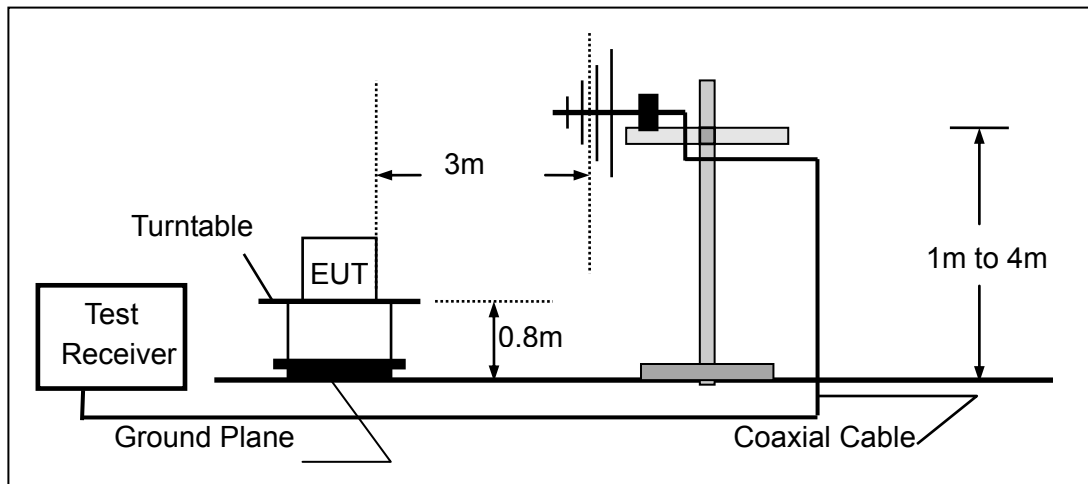

(c) For radiated emissions above 1000MHz

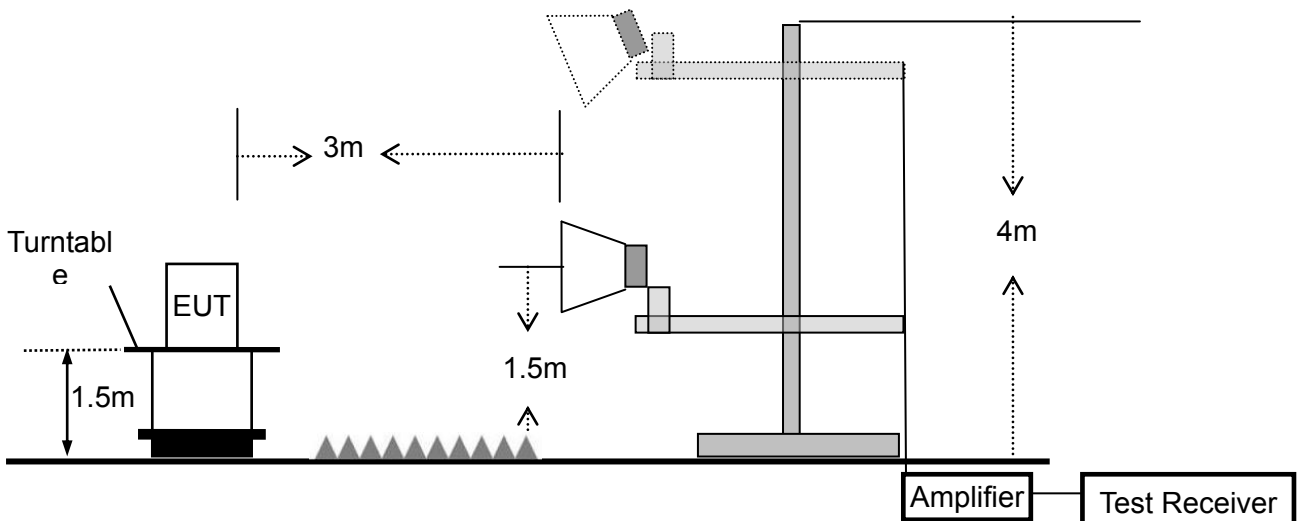

3.2.5 TEST PROCEDURE

The test site semi-anechoic chamber has met the requirement of NSA tolerance 4 dB according to the standards: ANSI C63.10-2013. The test distance is 3m. The setup is according to the requirements in Section 13.1.4.1 of ANSI C63.10-2013 and CAN/CSA-CEI/IEC CISPR 22.

This test is required for any spurious emission that falls in a Restricted Band, as defined in Section 15.205. It must be performed with the highest gain of each type of antenna proposed for use with the EUT.

Use the following spectrum analyzer settings:

Spectrum Parameter	Setting
Attenuation	Auto
Start Frequency	1000 MHz
Stop Frequency	10th carrier harmonic
RB / VB (emission in restricted band)	1 MHz / 1 MHz for Peak, 1 MHz / 1MHz for Average

Receiver Parameter	Setting
Attenuation	Auto
Start ~ Stop Frequency	9kHz~150kHz / RB 200Hz for QP
Start ~ Stop Frequency	150kHz~30MHz / RB 9kHz for QP
Start ~ Stop Frequency	30MHz~1000MHz / RB 120kHz for QP

- The measuring distance of at 3 m shall be used for measurements at frequency up to 1GHz. For frequencies above 1GHz, any suitable measuring distance may be used.
- The EUT was placed on the top of a rotating table 0.8 m for below 1GHz and 1.5m for above 1GHz the ground at a 3 meter. The table was rotated 360 degrees to determine the position of the highest radiation.
- The height of the equipment or of the substitution antenna shall be 0.8 m for below 1GHz and 1.5m for above 1GHz; the height of the test antenna shall vary between 1 m to 4 m. Both horizontal and vertical polarizations of the antenna are set to make the measurement.
- The initial step in collecting conducted emission data is a spectrum analyzer peak detector mode pre-scanning the measurement frequency range. Significant peaks are then marked and then Quasi Peak detector mode re-measured.
- If the Peak Mode measured value compliance with and lower than Quasi Peak Mode Limit, the EUT shall be deemed to meet QP Limits and then no additional QP Mode measurement performed.
- For the actual test configuration, please refer to the related Item –EUT Test Photos.

Note:

Both horizontal and vertical antenna polarities were tested and performed pretest to three orthogonal axis. The worst case emissions were reported

During the radiated emission test, the Spectrum Analyzer was set with the following configurations:

Frequency Band (MHz)	Function	Resolution bandwidth	Video Bandwidth
30 to 1000	QP	120 kHz	300 kHz
Above 1000	Peak	1 MHz	1 MHz
	Average	1 MHz	1 MHz

Note: for the frequency ranges below 30 MHz, a narrower RBW is used for these ranges but the measured value should add a RBW correction factor (RBWCF) where $RBWCF [dB] = 10 \cdot \lg(100 [kHz] / \text{narrower RBW [kHz]})$. , the narrower RBW is 1 kHz and RBWCF is 20 dB for the frequency 9 kHz to 150 kHz, and the narrower RBW is 10 kHz and RBWCF is 10 dB for the frequency 150 kHz to 30 MHz.

3.2.6 TEST RESULTS (9KHz – 30 MHz)

EUT:	4G Fixed phone	Model Name. :	FIXO 240L
Temperature:	20 °C	Relative Humidity:	48%
Pressure:	1010 hPa	Test Voltage :	DC 3.7V
Test Mode :	TX	Polarization :	--

Freq.	Reading	Limit	Margin	State
(MHz)	(dBuV/m)	(dBuV/m)	(dB)	P/F
--	--	--	--	N/A
--	--	--	--	N/A

NOTE:

The amplitude of spurious emissions which are attenuated by more than 20dB below the permissible value has no need to be reported.

3.2.7 TEST RESULTS (30MHz – 1GHz)

EUT :	4G Fixed phone	Model Name. :	FIXO 240L
Temperature :	25°C	Relative Humidity :	55%
Pressure :	1010 hPa	Test Voltage :	DC 3.7V
Test Mode :	TX(5.2G)- 802.11a (Mid CH)		

Polar (H/V)	Frequency	Meter Reading	Factor	Emission Level	Limits	Margin	Remark
	(MHz)	(dBuV)	(dB)	(dBuV/m)	(dBuV/m)	(dB)	
V	30.4237	10.55	25.87	36.42	40.00	-3.58	QP
V	42.4508	14.29	18.96	33.25	40.00	-6.75	QP
V	99.8777	14.79	17.78	32.57	43.50	-10.93	QP
V	252.9482	6.67	19.24	25.91	46.00	-20.09	QP
V	264.7456	5.86	19.64	25.50	46.00	-20.50	QP
V	881.4067	4.79	30.29	35.08	46.00	-10.92	QP

Remark:

Emission Level = Meter Reading + Factor, Margin= Emission Level - Limit

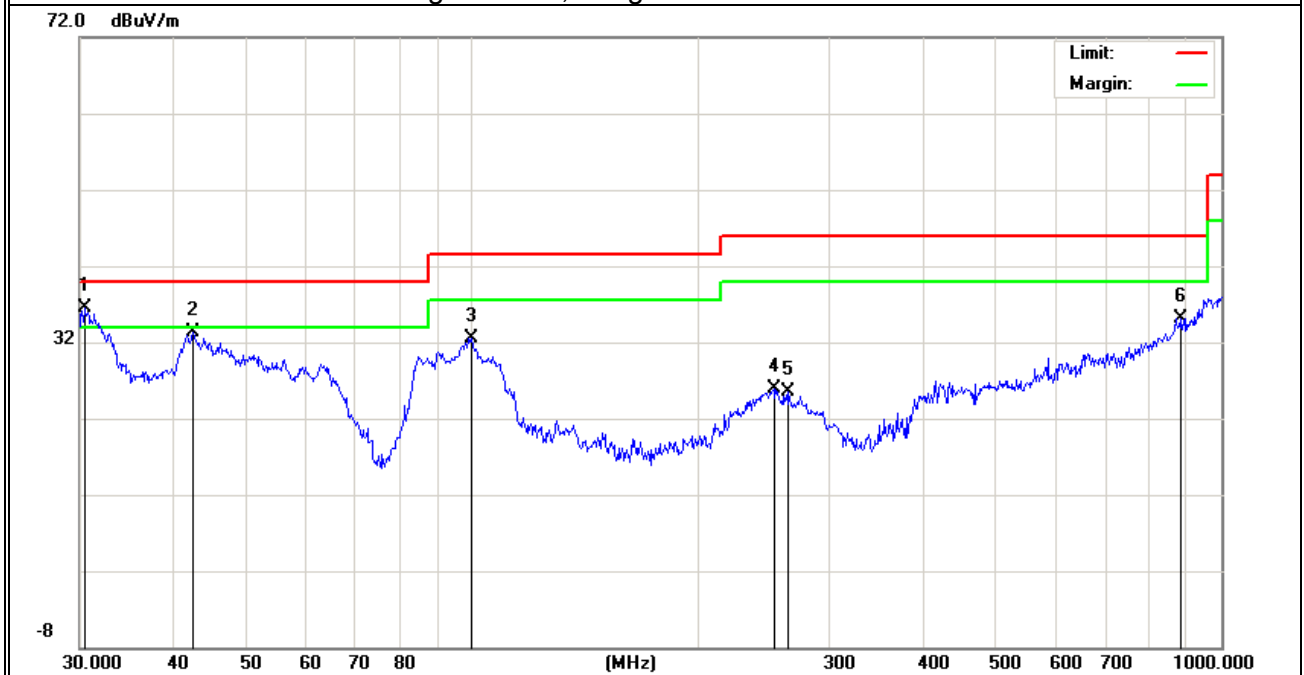

Polar (H/V)	Frequency	Meter Reading	Factor	Emission Level	Limits	Margin	Remark
	(MHz)	(dBuV)	(dB)	(dBuV/m)	(dBuV/m)	(dB)	
H	31.8427	6.21	24.87	31.08	40.00	-8.92	QP
H	85.2980	12.06	16.27	28.33	40.00	-11.67	QP
H	100.9338	13.62	17.59	31.21	43.50	-12.29	QP
H	139.8505	9.08	18.78	27.86	43.50	-15.64	QP
H	305.6800	6.72	20.44	27.16	46.00	-18.84	QP
H	919.2866	5.96	30.63	36.59	46.00	-9.41	QP

Remark:

Emission Level = Meter Reading + Factor, Margin= Emission Level - Limit

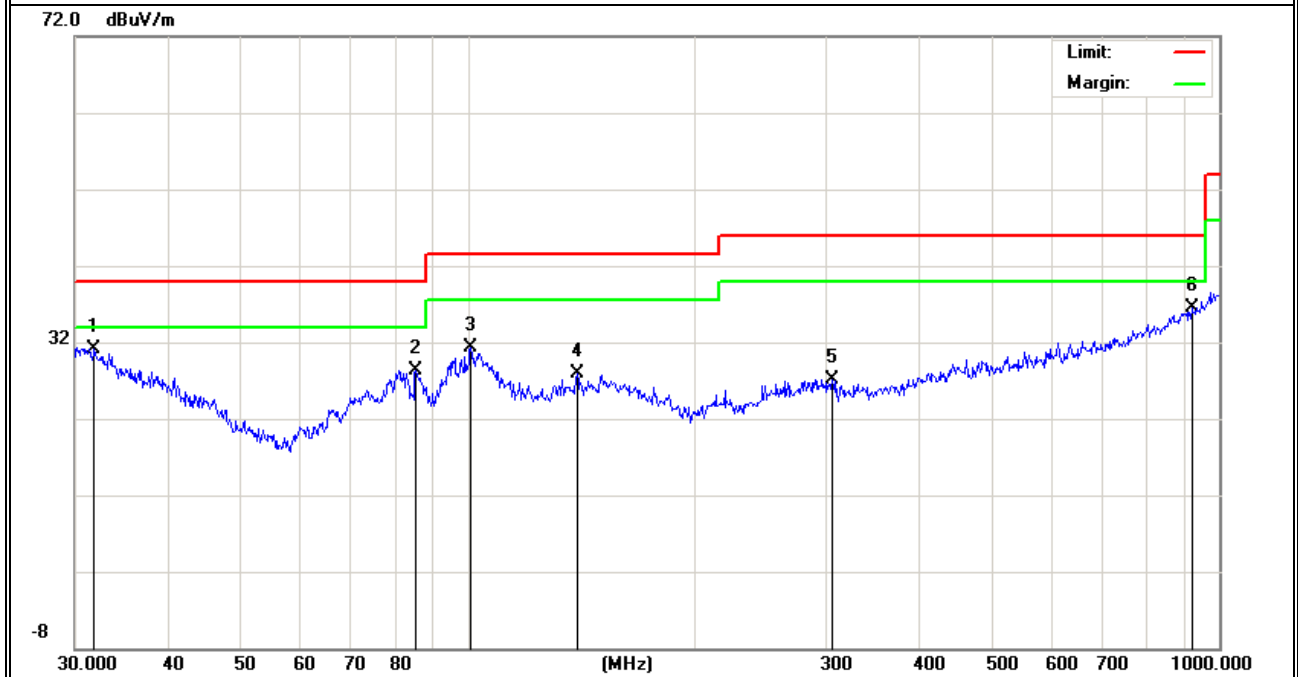

Note(1)“802.11a” mode is the worst mode.

(2)Other emissions are attenuated more than 20dB below the permissible limits, so it does not recorded in the report.

EUT :	4G Fixed phone	Model Name. :	FIXO 240L
Temperature :	25°C	Relative Humidity :	55%
Pressure :	1010 hPa	Test Voltage :	DC 3.7V
Test Mode :	TX(5.8G)- 802.11a(Mid CH)		

Polar (H/V)	Frequency	Meter Reading	Factor	Emission Level	Limits	Margin	Remark
	(MHz)	(dBuV)	(dB)	(dBuV/m)	(dBuV/m)	(dB)	
V	30.4237	13.05	25.87	38.92	40.00	-1.08	QP
V	43.9658	15.66	18.35	34.01	40.00	-5.99	QP
V	60.0690	16.33	12.28	28.61	40.00	-11.39	QP
V	88.3421	16.79	16.23	33.02	43.50	-10.48	QP
V	99.1795	15.12	17.78	32.90	43.50	-10.60	QP
V	896.9963	5.72	30.31	36.03	46.00	-9.97	QP

Remark:

Emission Level = Meter Reading + Factor, Margin= Emission Level - Limit

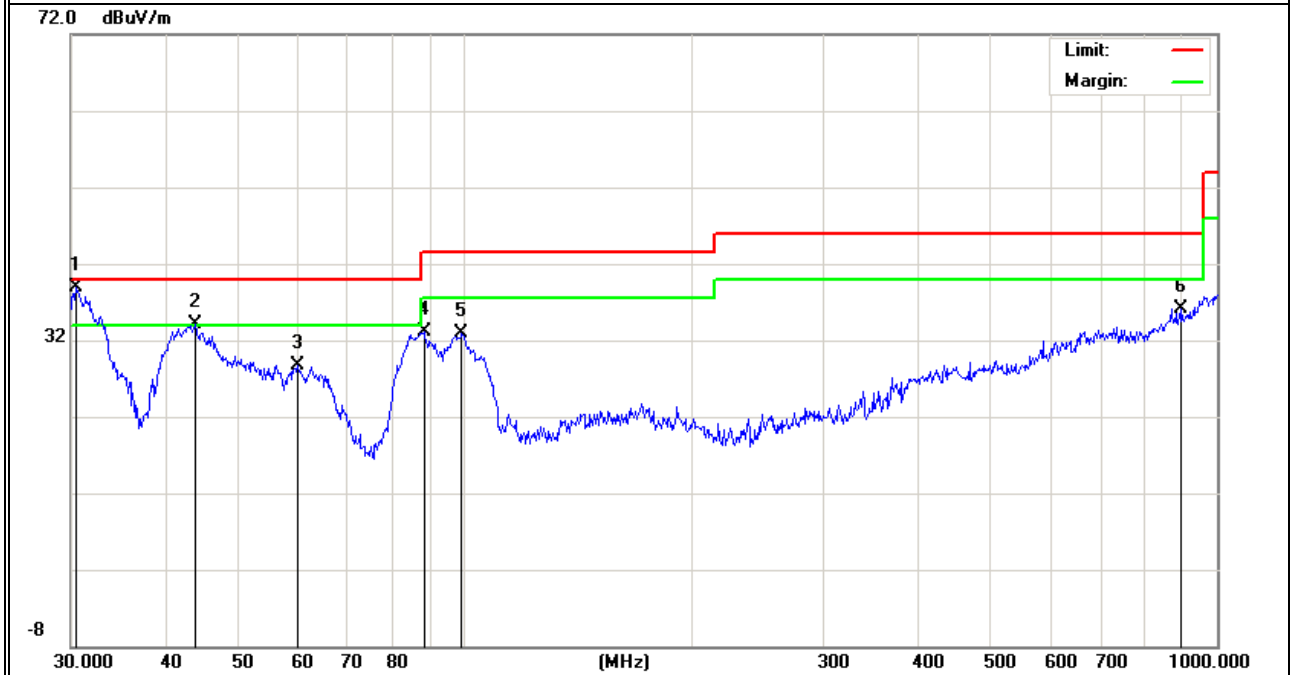

Polar (H/V)	Frequency	Meter Reading	Factor	Emission Level	Limits	Margin	Remark
	(MHz)	(dBuV)	(dB)	(dBuV/m)	(dBuV/m)	(dB)	
H	69.1140	8.99	13.35	22.34	40.00	-17.66	QP
H	94.4282	6.51	17.26	23.77	43.50	-19.73	QP
H	123.2655	6.56	18.85	25.41	43.50	-18.09	QP
H	141.8262	10.38	18.41	28.79	43.50	-14.71	QP
H	155.9096	12.14	18.45	30.59	43.50	-12.91	QP
H	307.8312	10.34	20.23	30.57	46.00	-15.43	QP

Remark:

Emission Level = Meter Reading + Factor, Margin= Emission Level - Limit

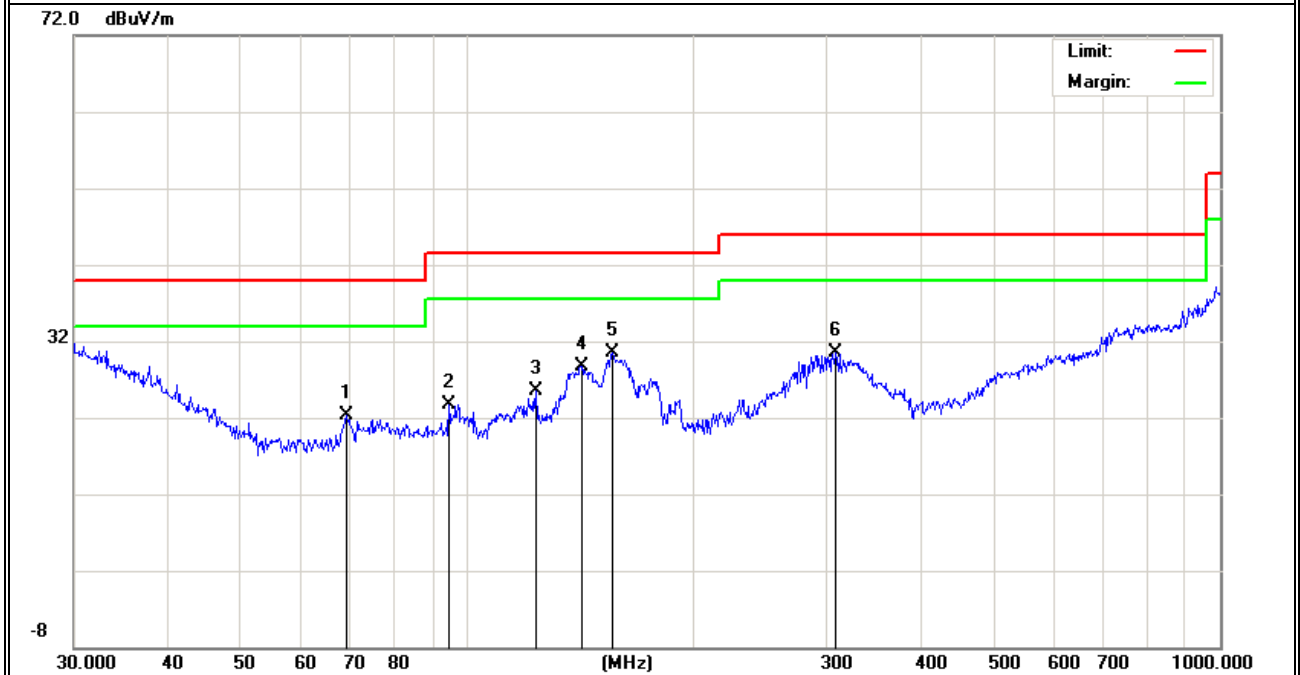

Note(1)“802.11a” mode is the worst mode.

(2)Other emissions are attenuated more than 20dB below the permissible limits, so it does not recorded in the report.

3.2.8 TEST RESULTS (1GHz-18GHz)

EUT :	4G Fixed phone	Model Name. :	FIXO 240L
Temperature :	20 °C	Relative Humidity :	48%
Pressure :	1010 hPa	Test Voltage :	DC 3.7V
Test Mode :	TX(5.2G) - 802.11a		

Polar	Frequency	Meter Reading	Cable loss	Antenna Factor	Preamp Factor	Emission Level	Limits	Margin	Detector Type
(H/V)	(MHz)	(dBuV)	(dB)	dB/m	(dB)	(dBuV/m)	(dBuV/m)	(dB)	
Low Channel (5180 MHz)-Above 1G									
Vertical	3694.37	61.87	5.94	35.40	44.00	59.21	74.00	-14.79	Pk
Vertical	3694.57	42.52	5.94	35.40	44.00	39.86	54.00	-14.14	AV
Vertical	10360.47	58.68	8.46	39.75	44.50	62.39	68.20	-5.81	Pk
Vertical	15540.64	61.30	10.12	38.80	44.10	66.12	74.00	-7.88	Pk
Vertical	15540.48	40.00	10.12	38.80	42.70	46.22	54.00	-7.78	AV
Horizontal	3713.51	63.81	5.94	35.18	44.00	60.93	74.00	-13.07	Pk
Horizontal	3713.57	43.99	5.94	35.18	44.00	41.11	54.00	-12.89	AV
Horizontal	10360.95	59.18	8.46	38.71	44.50	61.85	68.20	-6.35	Pk
Horizontal	15540.83	57.81	10.12	38.38	44.10	62.21	74.00	-11.79	Pk
Horizontal	15540.85	41.05	10.12	38.38	44.10	45.45	54.00	-8.55	AV
middle Channel (5200 MHz)-Above 1G									
Vertical	3624.39	59.04	6.48	36.35	44.05	57.82	74.00	-16.18	Pk
Vertical	3624.69	43.49	6.48	36.35	44.05	42.27	54.00	-11.73	AV
Vertical	10400.34	60.32	8.47	37.88	44.51	62.16	68.20	-6.04	Pk
Vertical	15600.45	60.39	10.12	38.80	44.10	65.21	74.00	-8.79	Pk
Vertical	15600.64	40.02	10.12	38.80	42.70	46.24	54.00	-7.76	AV
Horizontal	4202.53	58.64	6.48	36.37	44.05	57.44	74.00	-16.56	Pk
Horizontal	4202.41	45.28	6.48	36.37	44.05	44.08	54.00	-9.92	AV
Horizontal	10400.58	61.69	8.47	38.64	44.50	64.30	68.20	-3.90	Pk
Horizontal	15600.82	60.40	10.12	38.38	44.10	64.80	74.00	-9.20	Pk
Horizontal	15601.00	41.42	10.12	38.38	44.10	45.82	54.00	-8.18	AV
High Channel (5240 MHz)-Above 1G									
Vertical	4598.21	64.37	7.10	37.24	43.50	65.21	74.00	-8.79	Pk
Vertical	4598.12	43.50	7.10	37.24	43.50	44.34	54.00	-9.66	AV
Vertical	10480.50	60.43	8.46	37.68	44.50	62.07	68.20	-6.13	Pk
Vertical	15720.53	61.87	10.12	38.80	44.10	66.69	74.00	-7.31	Pk
Vertical	15720.40	40.69	10.12	38.80	42.70	46.91	54.00	-7.09	AV
Horizontal	4589.60	61.52	7.10	37.24	43.50	62.36	74.00	-11.64	Pk
Horizontal	4589.66	41.89	7.10	37.24	43.50	42.73	54.00	-11.27	AV
Horizontal	10481.10	62.38	8.46	38.57	44.50	64.91	68.20	-3.29	Pk
Horizontal	15720.53	59.90	10.12	38.38	44.10	64.30	74.00	-9.70	Pk
Horizontal	15720.72	43.26	10.12	38.38	44.10	47.66	54.00	-6.34	AV

Note: "802.11a" mode is the worst mode.

The amplitude of spurious emissions that are attenuated by more than 20dB below the permissible value

has no need to be reported. Emission level (dBuV/m) = 20 log Emission level (uV/m).

Corrected Reading: Antenna Factor + Cable Loss + Read Level - Preamp Factor = Level.

EUT :	4G Fixed phone	Model Name. :	FIXO 240L
Temperature :	20 °C	Relative Humidity :	48%
Pressure :	1010 hPa	Test Voltage :	DC 3.7V
Test Mode :	TX (5.8G) -- 802.11a		

Polar	Frequency	Meter Reading	Cable loss	Antenna Factor	Preamp Factor	Emission Level	Limits	Margin	Detector Type
(H/V)	(MHz)	(dBuV)	(dB)	dB/m	(dB)	(dBuV/m)	(dBuV/m)	(dB)	
Low Channel (5745 MHz)-802.11a									
Vertical	5122.81	64.00	5.94	35.40	44.00	61.34	74.00	-12.66	Pk
Vertical	5123.04	45.94	5.94	35.40	44.00	43.28	54.00	-10.72	AV
Vertical	11491.15	60.50	8.46	39.75	44.50	64.21	74.00	-9.79	Pk
Vertical	11490.91	43.58	8.46	39.75	44.50	47.29	54.00	-6.71	AV
Vertical	17236.12	52.52	10.12	38.80	44.10	57.34	68.20	-10.86	Pk
Horizontal	5166.90	59.71	5.94	35.18	44.00	56.83	68.20	-11.37	Pk
Horizontal	11490.81	59.41	8.46	38.71	44.50	62.08	74.00	-11.92	Pk
Horizontal	11490.71	42.87	8.46	38.71	44.50	45.54	54.00	-8.46	AV
Horizontal	17235.72	51.74	10.12	38.38	44.10	56.14	68.20	-12.06	Pk
middle Channel (5785 MHz)-802.11a									
Vertical	5433.79	63.00	6.48	36.35	44.05	61.78	74.00	-12.22	Pk
Vertical	5433.82	43.28	6.48	36.35	44.05	42.06	54.00	-11.94	AV
Vertical	11570.78	60.84	8.47	37.88	44.51	62.68	74.00	-11.32	Pk
Vertical	11570.82	43.37	8.47	37.88	44.51	45.21	54.00	-8.79	AV
Vertical	17356.23	56.06	10.12	38.80	44.10	60.88	68.20	-7.32	Pk
Horizontal	4866.83	60.29	6.48	36.37	44.05	59.09	74.00	-14.91	Pk
Horizontal	4866.98	43.01	6.48	36.37	44.05	41.81	54.00	-12.19	AV
Horizontal	11570.52	62.89	8.47	38.64	44.50	65.50	74.00	-8.50	Pk
Horizontal	11570.57	44.27	8.47	38.64	44.50	46.88	54.00	-7.12	AV
Horizontal	17355.82	56.80	10.12	38.38	44.10	61.20	68.20	-7.00	Pk
High Channel (5825 MHz)-802.11a									
Vertical	5243.87	62.08	7.10	37.24	43.50	62.92	68.20	-5.28	Pk
Vertical	11651.82	61.93	8.46	37.68	44.50	63.57	74.00	-10.43	Pk
Vertical	11651.65	43.28	8.46	37.68	44.50	44.92	54.00	-9.08	AV
Vertical	17473.14	60.52	10.12	38.80	44.10	65.34	68.20	-2.86	Pk
Vertical	17473.00	60.81	10.12	38.80	44.10	65.63	68.20	-2.57	Pk
Horizontal	5284.45	60.31	7.10	37.24	43.50	61.15	68.20	-7.05	Pk
Horizontal	11651.96	60.51	8.46	38.57	44.50	63.04	74.00	-10.96	Pk
Horizontal	11651.81	42.05	8.46	38.57	44.50	44.58	54.00	-9.42	AV
Horizontal	17474.07	58.42	10.12	38.38	44.10	62.82	68.20	-5.38	Pk
Horizontal	17474.07	58.10	10.12	38.38	44.10	62.50	68.20	-5.70	Pk

Note:"802.11a" mode is the worst mode.

The amplitude of spurious emissions that are attenuated by more than 20dB below the permissible value has no need to be reported.

Emission level (dBuV/m) = 20 log Emission level (uV/m).

Corrected Reading: Antenna Factor + Cable Loss + Read Level - Preamp Factor = Level.

3.2.9 TEST RESULTS (18GHz-40GHz)

EUT :	4G Fixed phone	Model Name. :	FIXO 240L
Temperature :	20 °C	Relative Humidity :	48%
Pressure :	1010 hPa	Test Voltage :	DC 3.7V
Test Mode :	TX (5.2G)-802.11a TX (5.8G)-802.11a		

All the modulation modes have been tested, and the worst result was report as below:

Low Channel (5180 MHz)-Above 1G

Horizontal

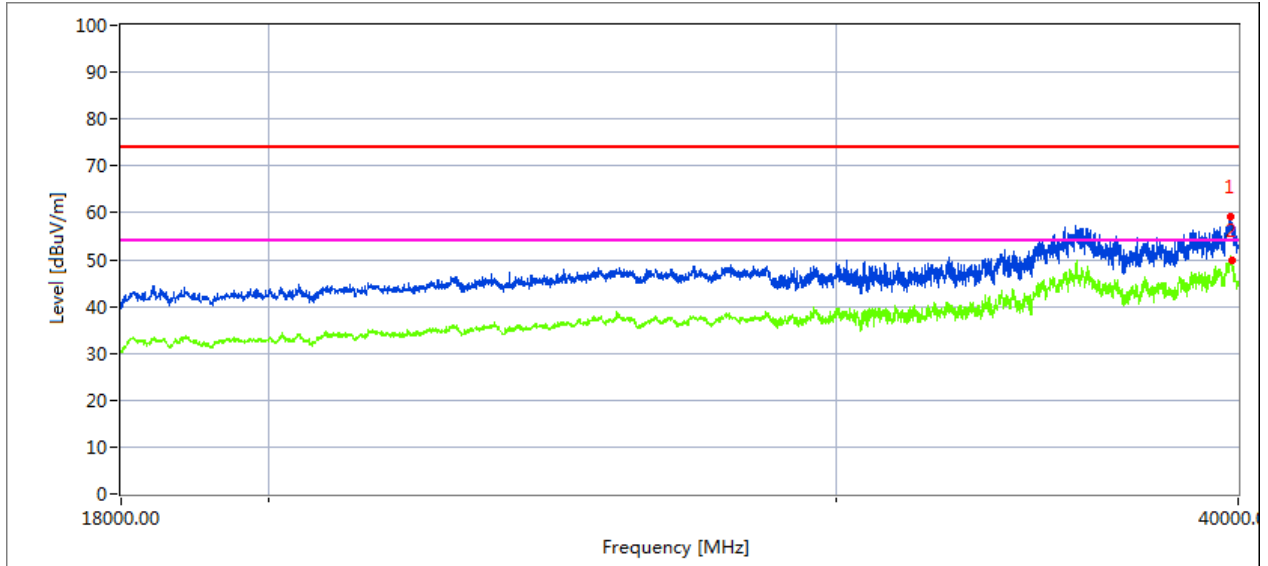

Measurement Result:

Frequency MHz	Meter Reading dBuV	Cable loss dB	Antenna Factor dB/m	Preamp Factor dB	Emission Level dBuV/m	Limits dBuV/m	Margin dB	Detector Type
39768.87	39.22	20.09	44.07	43.48	59.9	68.2	8.3	Peak
39766.99	27.58	20.09	44.04	43.48	48.23	54	5.77	AVG

Vertical

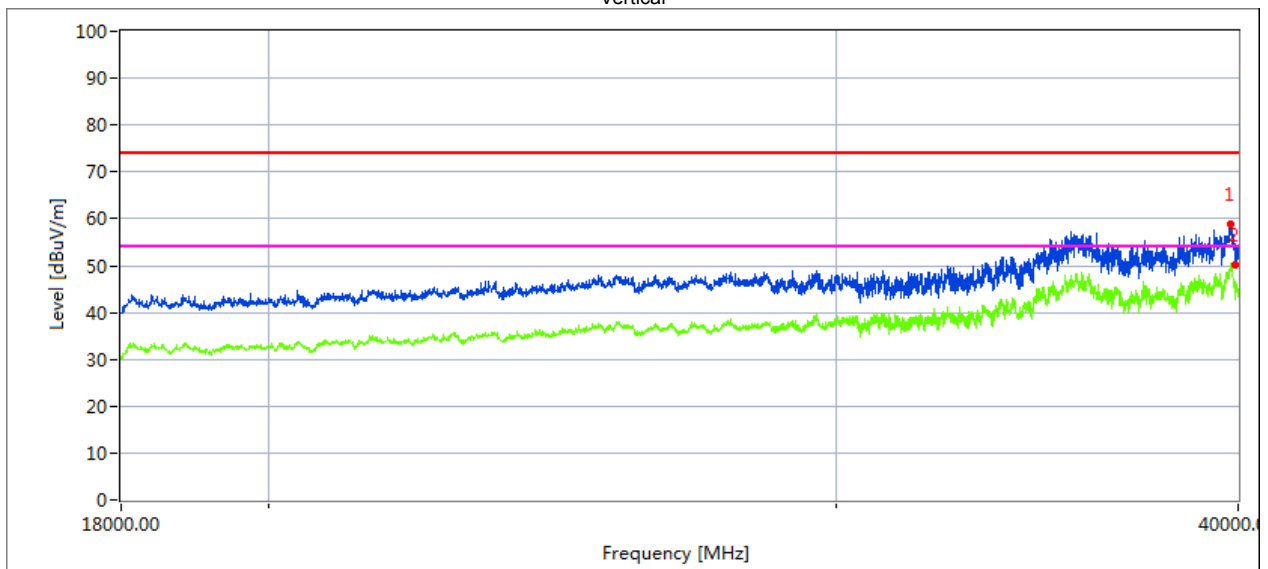

Measurement Result:

Frequency MHz	Meter Reading dBuV	Cable loss dB	Antenna Factor dB/m	Preamp Factor dB	Emission Level dBuV/m	Limits dBuV/m	Margin dB	Detector Type
39769.496	36.09	20.09	44.07	43.48	56.77	68.2	11.43	Peak
39769.205	27.5	20.09	44.04	43.48	48.15	54	5.85	AVG

High Channel (5240 MHz)-Above 1G

Horizontal

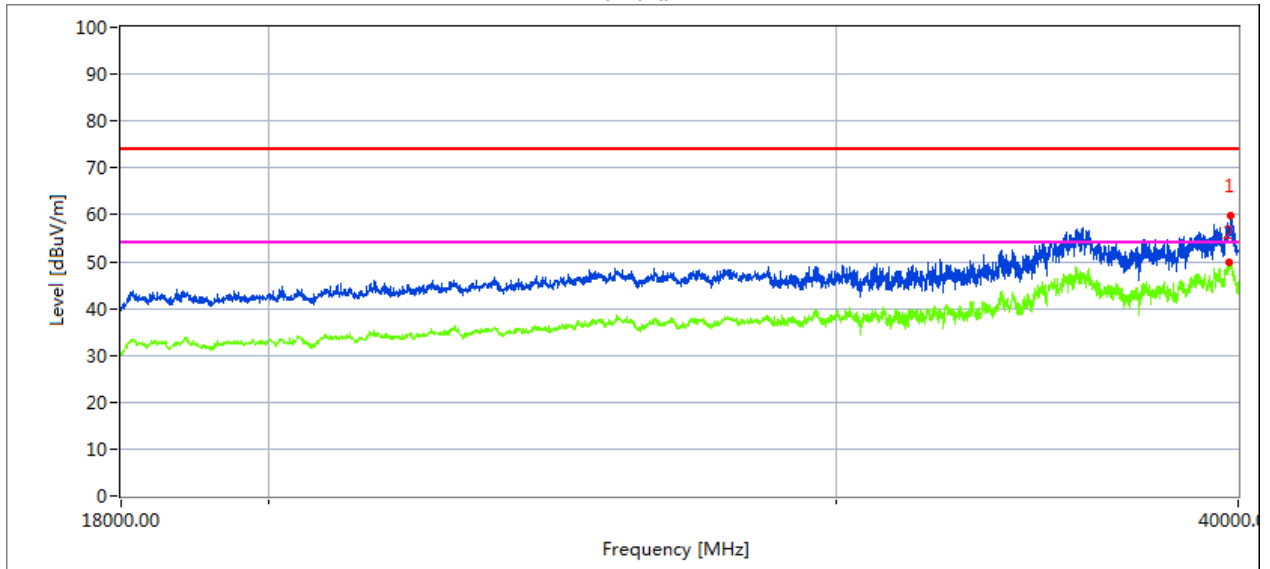

Measurement Result:

Frequency MHz	Meter Reading dBuV	Cable loss dB	Antenna Factor dB/m	Preamp Factor dB	Emission Level dBuV/m	Limits dBuV/m	Margin dB	Detector Type
35628.03	40.99	19.11	42.73	44.61	58.22	68.2	9.98	Peak
35596.456	31.57	19.11	42.73	44.61	48.8	54	5.2	AVG

Vertical

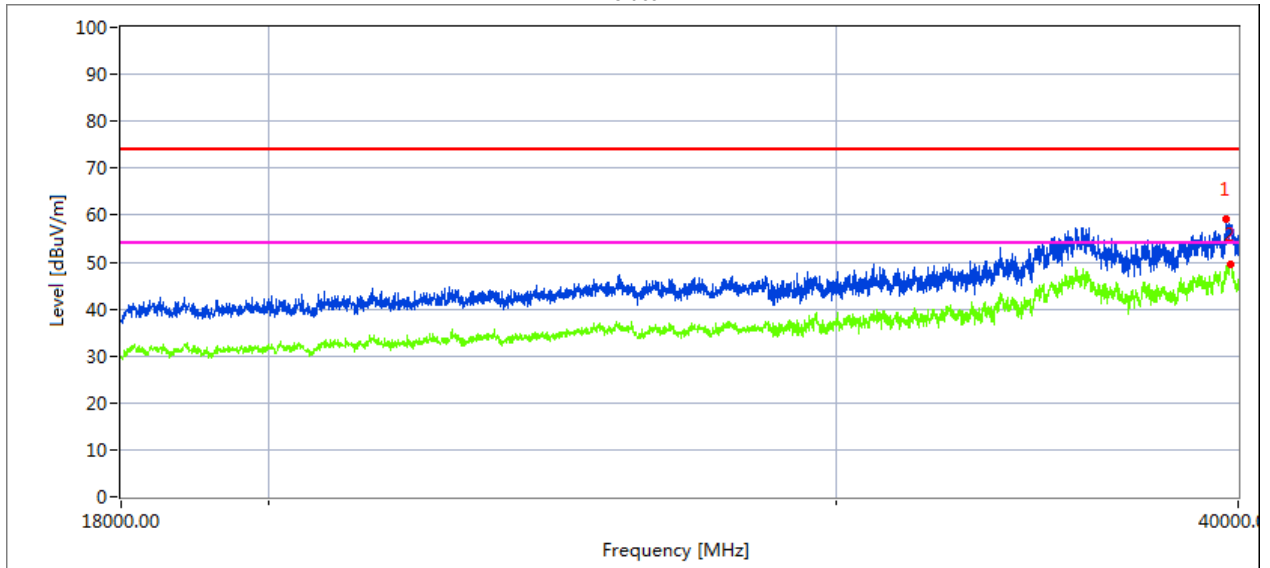

Measurement Result:

Frequency MHz	Meter Reading dBuV	Cable loss dB	Antenna Factor dB/m	Preamp Factor dB	Emission Level dBuV/m	Limits dBuV/m	Margin dB	Detector Type
39769.396	37.21	20.09	44.07	43.48	57.89	68.2	10.31	Peak
39769.266	25.47	20.09	44.04	43.48	46.12	54	7.88	AVG

Low Channel (5745 MHz)-Above 1G

Horizontal

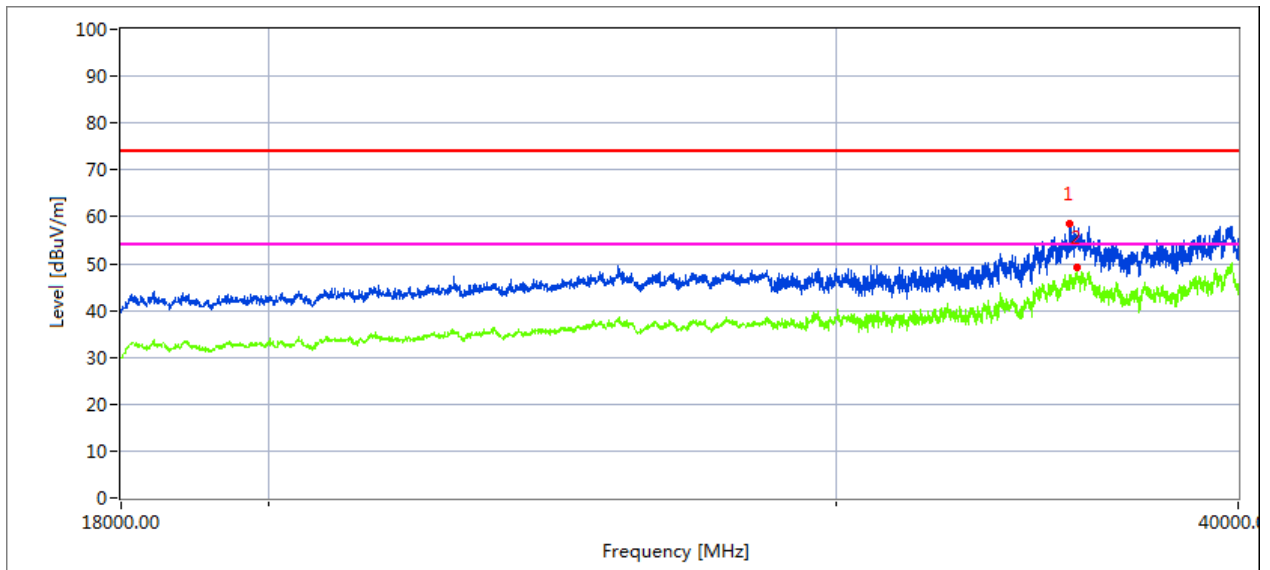

Measurement Result:

Frequency MHz	Meter Reading dBuV	Cable loss dB	Antenna Factor dB/m	Preamp Factor dB	Emission Level dBuV/m	Limits dBuV/m	Margin dB	Detector Type
39669.724	38.58	20.09	44.16	43.48	59.35	68.2	8.85	Peak
39669.804	29.53	20.09	44.16	43.48	50.3	54	3.7	AVG

Vertical

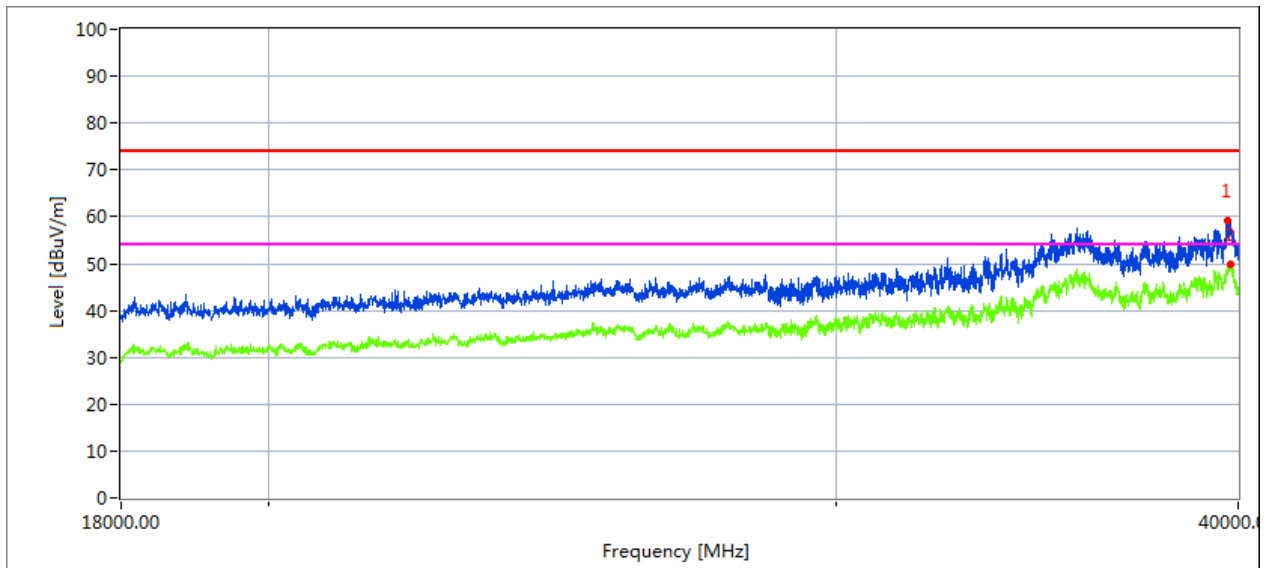

Measurement Result:

Frequency MHz	Meter Reading dBuV	Cable loss dB	Antenna Factor dB/m	Preamp Factor dB	Emission Level dBuV/m	Limits dBuV/m	Margin dB	Detector Type
39731.052	37.48	20.06	44.07	43.21	58.4	68.2	9.8	Peak
39731.232	28.46	20.06	44.07	43.21	49.38	54	4.62	AVG

High Channel (5825 MHz)-Above 1G

Horizontal

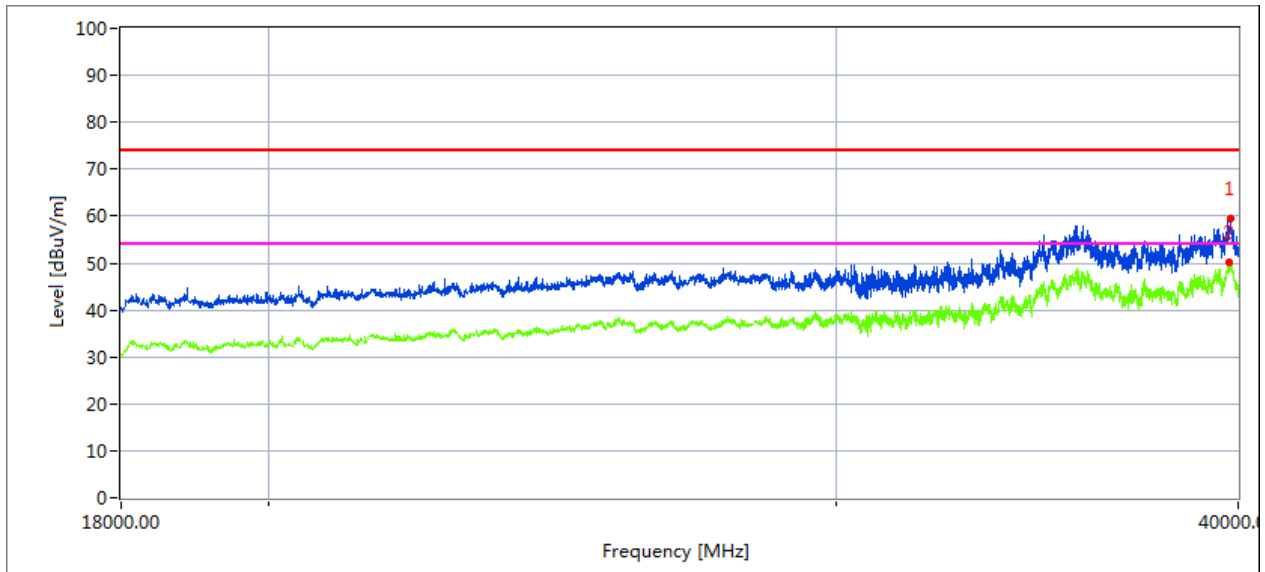

Measurement Result:

Frequency MHz	Meter Reading dBuV	Cable loss dB	Antenna Factor dB/m	Preamp Factor dB	Emission Level dBuV/m	Limits dBuV/m	Margin dB	Detector Type
35628.114	39.66	19.11	42.63	43.48	57.92	68.2	10.28	Peak
35635.788	30.1	19.12	42.63	43.48	48.37	54	5.63	AVG

Vertical

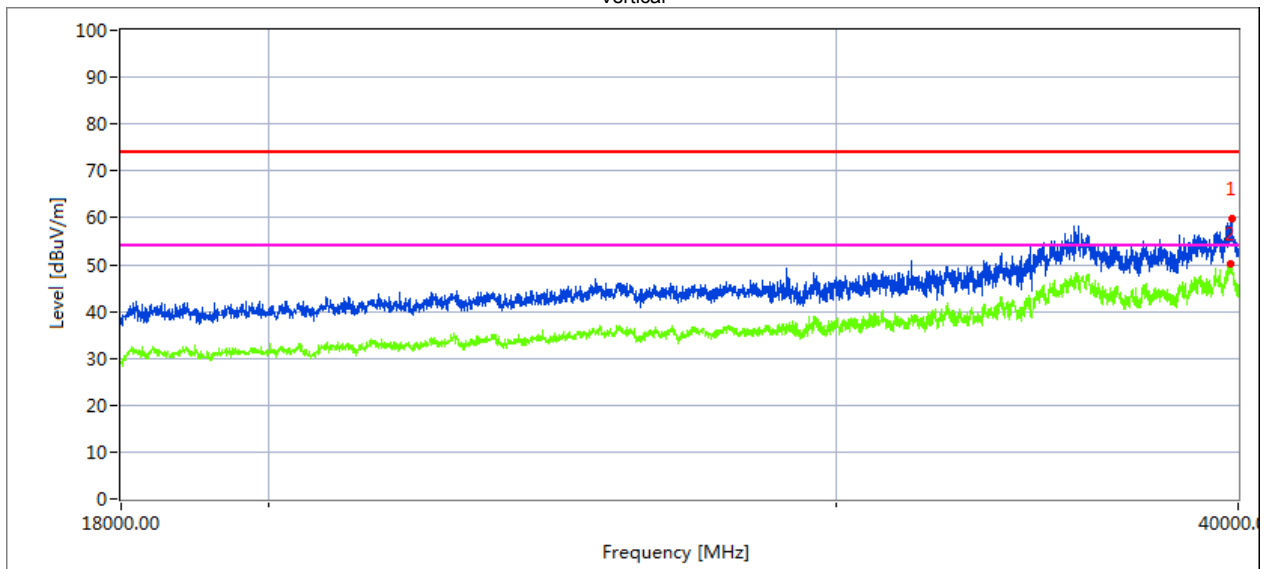

Measurement Result:

Frequency MHz	Meter Reading dBuV	Cable loss dB	Antenna Factor dB/m	Preamp Factor dB	Emission Level dBuV/m	Limits dBuV/m	Margin dB	Detector Type
39821.663	38.33	20.1	44.1	43.22	59.31	68.2	8.89	Peak
39821.683	29.36	20.1	44.1	43.22	50.34	54	3.66	AVG

3.2.10 Spurious Emission in Restricted Band 4.5GHz~5.150 GHz& 5.350GHz~5460GHz

EUT :	4G Fixed phone	Model Name. :	FIXO 240L
Temperature :	20 °C	Relative Humidity :	48%
Pressure :	1010 hPa	Test Voltage :	DC 3.7V
Test Mode :	TX (5.2G)-802.11a		

All the modulation modes have been tested, The report just record the worst data mode.

Frequency	Meter Reading	Cable Loss	Antenna Factor	Preamp Factor	Emission Level	Limits	Margin	Detector	Comment
(MHz)	(dBμV)	(dB)	dB/m	(dB)	(dBμV/m)	(dBμV/m)	(dB)	Type	
5.2G WIFI-802.11a Mode									
4500	56.46	5.2	35.6	44.2	53.06	74	-20.94	Pk	Horizontal
4500	47.32	5.2	35.6	44.2	43.92	54	-10.08	AV	Horizontal
4500	59.47	5.2	35.6	44.2	56.07	74	-17.93	Pk	Vertical
4500	46.28	5.2	35.6	44.2	42.88	54	-11.12	AV	Vertical
5150	70.19	5.36	35.66	44.22	66.99	74	-7.01	Pk	Horizontal
5150	49.82	5.36	35.66	44.22	46.62	54	-7.38	AV	Horizontal
5150	56.96	5.36	35.66	44.22	53.76	74	-20.24	Pk	Vertical
5150	38.40	5.36	35.66	44.22	35.2	54	-18.8	AV	Vertical
5350	65.69	5.68	35.68	44.22	62.83	74	-11.17	Pk	Vertical
5350	47.46	5.68	35.68	44.22	44.6	54	-9.4	AV	Vertical
5350	61.01	5.68	35.68	44.22	58.15	74	-15.85	Pk	Horizontal
5350	45.60	5.68	35.68	44.22	42.74	54	-11.26	AV	Horizontal

Note: (1) Emission Level= Antenna Factor + Cable Loss + Read Level - Preamp Factor

(2) "802.11a" mode is the worst mode. When PK value is lower than the Average value limit, average don't record.

3.3 POWER SPECTRAL DENSITY TEST

3.3.1 Applied procedures / limit

According to FCC §15.407(a)(3)

For the band 5.15-5.25 GHz,

(i) For an outdoor access point operating in the band 5.15-5.25 GHz, the maximum power spectral density shall not exceed 17 dBm in any 1 megahertz band. If transmitting antennas of directional gain greater than 6 dBi are used, both the maximum conducted output power and the maximum power spectral density shall be reduced by the amount in dB that the directional gain of the antenna exceeds 6 dBi. The maximum e.i.r.p. at any elevation angle above 30 degrees as measured from the horizon must not exceed 125 mW (21 dBm).

(ii) For an indoor access point operating in the band 5.15-5.25 GHz, the maximum power spectral density shall not exceed 17 dBm in any 1 megahertz band. If transmitting antennas of directional gain greater than 6 dBi are used, both the maximum conducted output power and the maximum power spectral density shall be reduced by the amount in dB that the directional gain of the antenna exceeds 6 dBi.

(iii) For fixed point-to-point access points operating in the band 5.15-5.25 GHz, the maximum power spectral density shall not exceed 17 dBm in any 1 megahertz band. Fixed point-to-point U-NII devices may employ antennas with directional gain up to 23 dBi without any corresponding reduction in the maximum conducted output power or maximum power spectral density. For fixed point-to-point transmitters that employ a directional antenna gain greater than 23 dBi, a 1 dB reduction in maximum conducted output power and maximum power spectral density is required for each 1 dB of antenna gain in excess of 23 dBi. Fixed, point-to-point operations exclude the use of point-to-multipoint systems, omnidirectional applications, and multiple collocated transmitters transmitting the same information. The operator of the U-NII device, or if the equipment is professionally installed, the installer, is responsible for ensuring that systems employing high gain directional antennas are used exclusively for fixed, point-to-point operations.

(iv) For client devices in the 5.15-5.25 GHz band, the maximum power spectral density shall not exceed 11 dBm in any 1 megahertz band. If transmitting antennas of directional gain greater than 6 dBi are used, both the maximum conducted output power and the maximum power spectral density shall be reduced by the amount in dB that the directional gain of the antenna exceeds 6 dBi.

For the band 5.725-5.85 GHz

(3) For the band 5.725-5.85 GHz, the maximum power spectral density shall not exceed 30 dBm in any 500-kHz band. If transmitting antennas of directional gain greater than 6 dBi are used, both the maximum conducted output power and the maximum power spectral density shall be reduced by the amount in dB that the directional gain of the antenna exceeds 6 dBi.

,

3.3.2 TEST PROCEDURE

For devices operating in the bands 5.15-5.25 GHz, 5.25-5.35 GHz, and 5.47-5.725 GHz, the above procedures make use of 1 MHz RBW to satisfy directly the 1 MHz reference bandwidth specified in § 15.407(a)(5). For devices operating in the band 5.725-5.85 GHz, the rules specify a measurement bandwidth of 500 kHz. Many spectrum analyzers do not have 500 kHz RBW, thus a narrower RBW may need to be used. The rules permit the use of a RBWs less than 1 MHz, or 500 kHz, “provided that the measured power is integrated over the full reference bandwidth” to show the total power over the specified measurement bandwidth (i.e., 1 MHz, or 500 kHz). If measurements are performed using a reduced resolution bandwidth (< 1 MHz, or < 500 kHz) and integrated over 1 MHz, or 500 KHz bandwidth, the following adjustments to the procedures apply:

- a) Set $RBW \geq 1/T$, where T is defined in section II.B.I.a).
- b) Set $VBW \geq 3 RBW$.
- c) If measurement bandwidth of Maximum PSD is specified in 500 kHz, add $10\log(500\text{kHz}/RBW)$ to the measured result, whereas $RBW (< 500 \text{ KHz})$ is the reduced resolution bandwidth of the spectrum analyzer set during measurement.
- d) If measurement bandwidth of Maximum PSD is specified in 1 MHz, add $10\log(1\text{MHz}/RBW)$ to the measured result, whereas $RBW (< 1 \text{ MHz})$ is the reduced resolution bandwidth of spectrum analyzer set during measurement.
- e) Care must be taken to ensure that the measurements are performed during a period of continuous transmission or are corrected upward for duty cycle.

Note: As a practical matter, it is recommended to use reduced RBW of 100 KHz for the sections 5.c) and 5.d) above, since $RBW=100 \text{ KHz}$ is available on nearly all spectrum analyzers.

3.3.3 DEVIATION FROM STANDARD

No deviation.

3.3.4 TEST SETUP

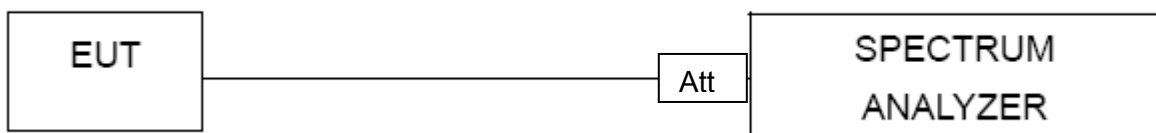

3.3.5 EUT OPERATION CONDITIONS

The EUT tested system was configured as the statements of 2.1 Unless otherwise a special operating condition is specified in the follows during the testing.

3.3.6 TEST RESULTS

EUT :	4G Fixed phone	Model Name. :	FIXO 240L
Temperature :	25 °C	Relative Humidity :	56%
Pressure :	1015 hPa	Test Voltage :	DC 3.7V
Test Mode :	TX Frequency Band I (5150-5250MHz), Band IV (5725-5850MHz)		

Test data reference attachment.

3.4 26DB & 99% EMISSION BANDWIDTH

3.4.1 Applied procedures / limit

The maximum power spectral density is measured as a conducted emission by direct connection of a calibrated test instrument to the equipment under test. If the device cannot be connected directly, alternative techniques acceptable to the Commission may be used. Measurements in the 5.725-5.85 GHz band are made over a reference bandwidth of 500 kHz or the 26 dB emission bandwidth of the device, whichever is less. Measurements in the 5.15-5.25 GHz, 5.25-5.35 GHz, and the 5.47-5.725 GHz bands are made over a bandwidth of 1 MHz or the 26 dB emission bandwidth of the device, whichever is less. A narrower resolution bandwidth can be used, provided that the measured power is integrated over the full reference bandwidth.

3.4.2 TEST PROCEDURE

- a) Set RBW = approximately 1% of the emission bandwidth.
- b) Set the VBW > RBW.
- c) Detector = Peak.
- d) Trace mode = max hold.
- e) Measure the maximum width of the emission that is 26 dB down from the maximum of the emission. Compare this with the RBW setting of the analyzer. Readjust RBW and repeat measurement as needed until the RBW/EBW ratio is approximately 1%.

The following procedure shall be used for measuring (99 %) power bandwidth:

1. Set center frequency to the nominal EUT channel center frequency.
2. Set span = 1.5 times to 5.0 times the OBW.
3. Set RBW = 1 % to 5 % of the OBW
4. Set VBW $\geq 3 \cdot$ RBW
5. Video averaging is not permitted. Where practical, a sample detection and single sweep mode shall be used. Otherwise, peak detection and max hold mode (until the trace stabilizes) shall be used.
6. Use the 99 % power bandwidth function of the instrument (if available).
7. If the instrument does not have a 99 % power bandwidth function, the trace data points are recovered and directly summed in power units. The recovered amplitude data points, beginning at the lowest frequency, are placed in a running sum until 0.5 % of the total is reached; that frequency is recorded as the lower frequency. The process is repeated until 99.5 % of the total is reached; that frequency is recorded as the upper frequency. The 99% occupied bandwidth is the difference between these two frequencies.

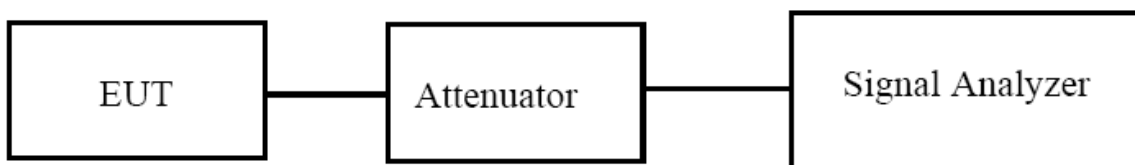

3.4.3 EUT OPERATION CONDITIONS

The EUT tested system was configured as the statements of 2.4 Unless otherwise a special operating condition is specified in the follows during the testing.

3.4.4 TEST RESULTS

EUT :	4G Fixed phone	Model Name. :	FIXO 240L
Temperature :	25 °C	Relative Humidity :	56%
Pressure :	1012 hPa	Test Voltage :	DC 3.7V
Test Mode :	TX Frequency Band I (5150-5250MHz), Band IV (5725-5850MHz)		

Test data reference attachment.

3.5 MINIMUM 6 DB BANDWIDTH

3.5.1 Applied procedures / limit

According to FCC §15.407(e)

(e) Within the 5.725-5.85 GHz band, the minimum 6 dB bandwidth of U-NII devices shall be at least 500 kHz.

3.5.2 TEST PROCEDURE

Section 15.407(e) specifies the minimum 6 dB emission bandwidth of at least 500 KHz for the band 5.715-5.85 GHz. The following procedure shall be used for measuring this bandwidth:

- a) Set RBW = 100 kHz.
- b) Set the video bandwidth (VBW) $\geq 3 \times$ RBW.
- c) Detector = Peak.
- d) Trace mode = max hold.
- e) Sweep = auto couple.
- f) Allow the trace to stabilize.
- g) Measure the maximum width of the emission that is constrained by the frequencies associated with the two outermost amplitude points (upper and lower frequencies) that are attenuated by 6 dB relative to the maximum level measured in the fundamental emission.

3.5.3 DEVIATION FROM STANDARD

No deviation.

3.5.4 TEST SETUP

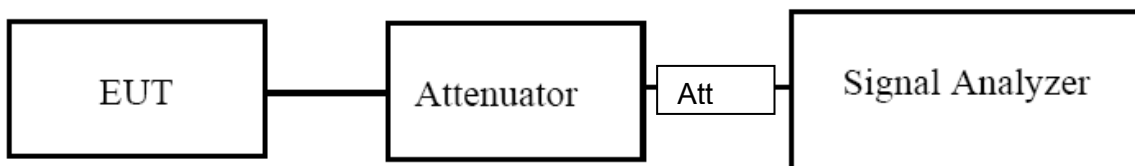

3.5.5 EUT OPERATION CONDITIONS

The EUT tested system was configured as the statements of 2.4 Unless otherwise a special operating condition is specified in the follows during the testing.

3.5.6 TEST RESULTS

EUT :	4G Fixed phone	Model Name. :	FIXO 240L
Temperature :	25 °C	Relative Humidity :	60%
Pressure :	1012 hPa	Test Voltage :	DC 3.7V
Test Mode :	TX (5G) Mode Frequency Band IV (5725-5850MHz)		

Test data reference attachment.

3.6 MAXIMUM CONDUCTED OUTPUT POWER

3.6.1 PPLIED PROCEDURES / LIMIT

According to FCC §15.407

The maximum conducted output power should not exceed:

Frequency Band(MHz)	Limit
5150~5250	250mW
5725~5850	1W

3.6.2 TEST PROCEDURE

· Maximum conducted output power may be measured using a spectrum analyzer/EMI receiver or an RF power meter.

1. Device Configuration

If possible, configure or modify the operation of the EUT so that it transmits continuously at its maximum power control level (see section II.B.).

a) The intent is to test at 100 percent duty cycle; however a small reduction in duty cycle (to no lower than 98 percent) is permitted if required by the EUT for amplitude control purposes. Manufacturers are expected to provide software to the test lab to permit such continuous operation.

b) If continuous transmission (or at least 98 percent duty cycle) cannot be achieved due to hardware limitations (e.g., overheating), the EUT shall be operated at its maximum power control level with the transmit duration as long as possible and the duty cycle as high as possible.

2. Measurement using a Spectrum Analyzer or EMI Receiver (SA)

Measurement of maximum conducted output power using a spectrum analyzer requires integrating the spectrum across a frequency span that encompasses, at a minimum, either the EBW or the 99-percent occupied bandwidth of the signal.¹ However, the EBW must be used to determine bandwidth dependent limits on maximum conducted output power in accordance with § 15.407(a).

a) The test method shall be selected as follows: (i) Method SA-1 or SA-1 Alternative (averaging with the EUT transmitting at full power throughout each sweep) shall be applied if either of the following conditions can be satisfied:

- The EUT transmits continuously (or with a duty cycle ≥ 98 percent).
- Sweep triggering or gating can be implemented in a way that the device transmits at the maximum power control level throughout the duration of each of the instrument sweeps to be averaged. This condition can generally be achieved by triggering the instrument's sweep if the duration of the sweep (with the analyzer configured as in Method SA-1, below) is equal to or shorter than the duration T of each transmission from the EUT and if those transmissions exhibit full power throughout their durations.

(ii) Method SA-2 or SA-2 Alternative (averaging across on and off times of the EUT transmissions, followed by duty cycle correction) shall be applied if the conditions of (i) cannot be achieved and the transmissions exhibit a constant duty cycle during the measurement duration. Duty cycle will be considered to be constant if variations are less than ± 2 percent.

(iii) Method SA-3 (RMS detection with max hold) or SA-3 Alternative (reduced VBW with max hold) shall be applied if the conditions of (i) and (ii) cannot be achieved.

b) Method SA-1 (trace averaging with the EUT transmitting at full power throughout each sweep): (i) Set span to encompass the entire emission bandwidth (EBW) (or, alternatively, the entire 99% occupied bandwidth) of the signal.

(ii) Set RBW = 1 MHz.

(iii) Set VBW ≥ 3 MHz.

(iv) Number of points in sweep ≥ 2 Span / RBW. (This ensures that bin-to-bin spacing is \leq RBW/2, so that narrowband signals are not lost between frequency bins.)

(v) Sweep time = auto.

(vi) Detector = RMS (i.e., power averaging), if available. Otherwise, use sample detector mode.

(vii) If transmit duty cycle < 98 percent, use a video trigger with the trigger level set to enable triggering only on full power pulses. Transmitter must operate at maximum power control level for the entire duration of every sweep. If the EUT transmits continuously (i.e., with no off intervals) or at duty cycle ≥ 98 percent, and if each transmission is entirely at the maximum power control level, then the trigger shall be set to "free run".

(viii) Trace average at least 100 traces in power averaging (i.e., RMS) mode.

(ix) Compute power by integrating the spectrum across the EBW (or, alternatively, the entire 99% occupied bandwidth) of the signal using the instrument's band power measurement function with band limits set equal to the EBW (or occupied bandwidth) band edges. If the instrument does not have a band power function, sum the spectrum

3.6.3 DEVIATION FROM STANDARD

No deviation.

3.6.4 TEST SETUP

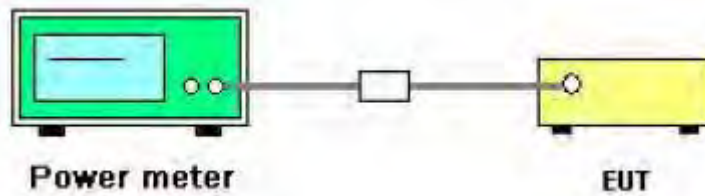

3.6.5 EUT OPERATION CONDITIONS

The EUT tested system was configured as the statements of 2.4 Unless otherwise a special operating condition is specified in the follows during the testing.

3.6.6 TEST RESULTS

EUT :	4G Fixed phone	Model Name. :	FIXO 240L
Temperature :	25 °C	Relative Humidity :	60%
Pressure :	1012 hPa	Test Voltage :	DC 3.7V
Test Mode :	TX (5G) Mode Frequency Band I (5150-5250MHz), Band IV (5725-5850MHz)		

Test data reference attachment.

3.7 OUT OF BAND EMISSIONS

3.7.1 Applicable Standard

According to FCC §15.407(b)

Undesirable emission limits. Except as shown in paragraph (b)(7) of this section, the maximum emissions outside of the frequency bands of operation shall be attenuated in accordance with the following limits:

(1) For transmitters operating in the 5.15-5.25 GHz band: All emissions outside of the 5.15-5.35 GHz band shall not exceed an e.i.r.p. of -27 dBm/MHz.

(2) For transmitters operating in the 5.725-5.85 GHz band: All emissions shall be limited to a level of -27 dBm/MHz at 75 MHz or more above or below the band edge increasing linearly to 10 dBm/MHz at 25 MHz above or below the band edge, and from 25 MHz above or below the band edge increasing linearly to a level of 15.6 dBm/MHz at 5 MHz above or below the band edge, and from 5 MHz above or below the band edge increasing linearly to a level of 27 dBm/MHz at the band edge.

3.7.2 Test Procedure

1. Check the calibration of the measuring instrument using either an internal calibrator or a known signal from an external generator.
2. Position the EUT without connection to measurement instrument. Turn on the EUT and connect its antenna terminal to measurement instrument via a low loss cable. Then set it to any one measured frequency within its operating range, and make sure the instrument is operated in its linear range.
3. Set RBW of spectrum analyzer to 1 MHz with a convenient frequency span.
4. Measure the highest amplitude appearing on spectral display and set it as a reference level. Plot the graph with marking the highest point and edge frequency.
5. Repeat above procedures until all measured frequencies were complete.

3.7.3 DEVIATION FROM STANDARD

No deviation.

3.7.4 TEST SETUP

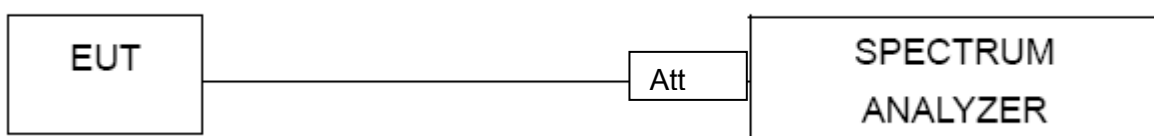

3.7.5 EUT OPERATION CONDITIONS

The EUT tested system was configured as the statements of 2.4 Unless otherwise a special operating condition is specified in the follows during the testing.

3.7.6 TEST RESULTS

EUT :	4G Fixed phone	Model Name. :	FIXO 240L
Temperature :	25 °C	Relative Humidity :	56%
Pressure :	1012 hPa	Test Voltage :	DC 3.7V

Test data reference attachment.

3.8 SPURIOUS RF CONDUCTED EMISSIONS

3.8.1 Conformance Limit

According to FCC §15.407(b)(1) (2) (3) (4)

3.8.2 Measuring Instruments

The Measuring equipment is listed in the section 6.3 of this test report.

3.8.3 Test Setup

Please refer to Section 6.1 of this test report.

3.8.4 Test Procedure

The Spurious RF conducted emissions compliance of RF radiated emission should be measured by following the guidance in ANSI C63.10-2013 with respect to maximizing the emission by rotating the EUT, measuring the emission while the EUT is situated in three orthogonal planes (if appropriate), adjusting the measurement antenna height and polarization etc. Set RBW=100kHz and VBW= 300KHz to measure the peak field strength , and measure frequency range from 30MHz to 40GHz.

3.8.5 Test Results

Remark: The measurement frequency range is from 30MHz to the 10th harmonic of the fundamental frequency. The lowest, middle and highest channels are tested to verify the spurious emissions and bandedge measurement data.

Test data reference attachment.

3.9 FREQUENCY STABILITY MEASUREMENT

3.9.1 LIMIT

Manufactures of U-NII devices are responsible for ensuring frequency stability such that an emission is maintained within the band of operation under all conditions of normal operation as specified in the user's manual.

3.9.2 TEST PROCEDURES

1. The transmitter output (antenna port) was connected to the spectrum analyzer.
2. EUT have transmitted absence of modulation signal and fixed channelize.
3. Set the spectrum analyzer span to view the entire absence of modulation emissions bandwidth.
4. Set RBW = 10 kHz, VBW = 10 kHz with peak detector and maxhold settings.
5. f_c is declaring of channel frequency. Then the frequency error formula is $(f_c - f) / f_c \times 10^6 \text{ ppm}$.
6. The test extreme voltage is to change the primary supply voltage from 85 to 115 percent of the nominal value
7. Extreme temperature is $-20^\circ\text{C} \sim 70^\circ\text{C}$.

3.9.3 TEST SETUP LAYOUT

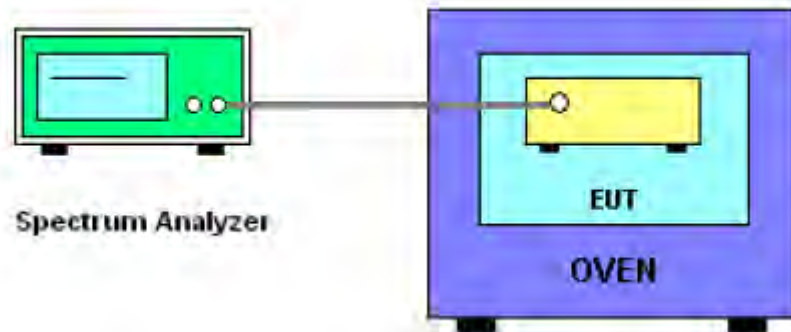

3.9.4 EUT OPERATION DURING TEST

The EUT was programmed to be in continuously un-modulation transmitting mode.

3.9.5 TEST RESULTS

EUT :	4G Fixed phone	Model Name. :	FIXO 240L
Temperature :	25 °C	Relative Humidity :	56%
Pressure :	1012 hPa	Test Voltage :	DC 3.7V
Test Mode :	TX Frequency Band I (5150-5250MHz)		

Voltage vs. Frequency Stability

TEST CONDITIONS				Reference Frequency: 5180MHz			
				f	fc	Max. Deviation (MHz)	Max. Deviation (ppm)
T nom (°C)	20	V nom (V)	3.70	5180.0323	5180	0.0323	-6.2355
		V max (V)	4.26	5180.0238	5180	0.0238	-4.5946
		V min (V)	3.15	5180.0056	5180	0.0056	-1.0811
Limits				Within 5150-5250MHz			
Result				Complies			

Temperature vs. Frequency Stability

TEST CONDITIONS				Reference Frequency: 5180MHz			
				f	fc	Max. Deviation (MHz)	Max. Deviation (ppm)
V nom (V)	3.70	T (°C)	-20	5180.0130	5180	0.0130	-2.5097
		T (°C)	-10	5180.0221	5180	0.0221	-4.2664
		T (°C)	0	5180.0193	5180	0.0193	-3.7259
		T (°C)	10	5180.0156	5180	0.0156	-3.0116
		T (°C)	20	5180.0276	5180	0.0276	-5.3282
		T (°C)	30	5180.0092	5180	0.0092	-1.7761
		T (°C)	40	5180.0266	5180	0.0266	-5.1351
		T (°C)	50	5180.0133	5180	0.0133	-2.5676
		T (°C)	60	5180.0293	5180	0.0293	-5.6564
		T (°C)	70	5180.0019	5180	0.0019	-0.3668
Limits				Within 5150-5250MHz			
Result				Complies			

Voltage vs. Frequency Stability

TEST CONDITIONS				Reference Frequency: 5200MHz			
				f	fc	Max. Deviation (MHz)	Max. Deviation (ppm)
T nom (°C)	20	V nom (V)	3.70	5200.0050	5200	0.0050	-0.9615
		V max (V)	4.26	5200.0032	5200	0.0032	-0.6154
		V min (V)	3.15	5200.0217	5200	0.0217	-4.1731
Limits				Within 5150-5250MHz			
Result				Complies			

Temperature vs. Frequency Stability

TEST CONDITIONS				Reference Frequency: 5200MHz			
				f	fc	Max. Deviation (MHz)	Max. Deviation (ppm)
V nom (V)	3.70	T (°C)	-20	5200.0116	5200	0.0116	-2.2308
		T (°C)	-10	5200.0089	5200	0.0089	-1.7115
		T (°C)	0	5200.0099	5200	0.0099	-1.9038
		T (°C)	10	5200.0057	5200	0.0057	-1.0962
		T (°C)	20	5200.0321	5200	0.0321	-6.1731
		T (°C)	30	5200.0270	5200	0.0270	-5.1923
		T (°C)	40	5200.0281	5200	0.0281	-5.4038
		T (°C)	50	5200.0048	5200	0.0048	-0.9231
		T (°C)	60	5200.0192	5200	0.0192	-3.6923
		T (°C)	70	5200.0067	5200	0.0067	-1.2885
Limits				Within 5150-5250MHz			
Result				Complies			

Voltage vs. Frequency Stability

TEST CONDITIONS				Reference Frequency: 5240MHz			
				f	fc	Max. Deviation (MHz)	Max. Deviation (ppm)
T nom (°C)	20	V nom (V)	3.70	5240.0338	5240	0.0338	-6.4504
		V max (V)	4.26	5240.0045	5240	0.0045	-0.8588
		V min (V)	3.15	5240.0233	5240	0.0233	-4.4466
Limits				Within 5150-5250MHz			
Result				Complies			

Temperature vs. Frequency Stability

TEST CONDITIONS				Reference Frequency: 5240MHz			
				f	fc	Max. Deviation (MHz)	Max. Deviation (ppm)
V nom (V)	3.70	T (°C)	-20	5240.0247	5240	0.0247	-4.7137
		T (°C)	-10	5240.0123	5240	0.0123	-2.3473
		T (°C)	0	5240.0024	5240	0.0024	-0.4580
		T (°C)	10	5240.0085	5240	0.0085	-1.6221
		T (°C)	20	5240.0115	5240	0.0115	-2.1947
		T (°C)	30	5240.0199	5240	0.0199	-3.7977
		T (°C)	40	5240.0183	5240	0.0183	-3.4924
		T (°C)	50	5240.0029	5240	0.0029	-0.5534
		T (°C)	60	5240.0235	5240	0.0235	-4.4847
		T (°C)	70	5240.0018	5240	0.0018	-0.3435
Limits				Within 5150-5250MHz			
Result				Complies			

EUT :	4G Fixed phone	Model Name. :	FIXO 240L
Temperature :	25 °C	Relative Humidity :	56%
Pressure :	1012 hPa	Test Voltage :	DC 3.7V
Test Mode :	TX Frequency(5745-5825MHz)		

Voltage vs. Frequency Stability

TEST CONDITIONS				Reference Frequency: 5745MHz			
				f	fc	Max. Deviation (MHz)	Max. Deviation (ppm)
T nom (°C)	20	V nom (V)	3.70	5745.0012	5745	0.00120	-0.2089
		V max (V)	4.26	5745.0242	5745	0.02420	-4.2124
		V min (V)	3.15	5745.0259	5745	0.02590	-4.5083
Limits				Within 5745-5850MHz			
Result				Complies			

Temperature vs. Frequency Stability

TEST CONDITIONS				Reference Frequency: 5745MHz			
				f	fc	Max. Deviation (MHz)	Max. Deviation (ppm)
V nom (V)	3.70	T (°C)	-20	5745.0175	5745	0.01750	-3.0461
		T (°C)	-10	5745.0116	5745	0.01160	-2.0191
		T (°C)	0	5745.0126	5745	0.01260	-2.1932
		T (°C)	10	5745.0056	5745	0.00560	-0.9748
		T (°C)	20	5745.0202	5745	0.02020	-3.5161
		T (°C)	30	5745.0203	5745	0.02030	-3.5335
		T (°C)	40	5745.0135	5745	0.01350	-2.3499
		T (°C)	50	5745.0134	5745	0.01340	-2.3325
		T (°C)	60	5745.0116	5745	0.01160	-2.0191
		T (°C)	70	5745.0237	5745	0.02370	-4.1253
Limits				Within 5745-5850MHz			
Result				Complies			

Voltage vs. Frequency Stability

TEST CONDITIONS				Reference Frequency: 5785MHz			
				f	fc	Max. Deviation (MHz)	Max. Deviation (ppm)
T nom (°C)	20	V nom (V)	3.70	5785.0334	5785	0.03340	-5.7736
		V max (V)	4.26	5785.0054	5785	0.00540	-0.9334
		V min (V)	3.15	5785.0193	5785	0.01930	-3.3362
Limits				Within 5745-5850MHz			
Result				Complies			

Temperature vs. Frequency Stability

TEST CONDITIONS				Reference Frequency: 5785MHz			
				f	fc	Max. Deviation (MHz)	Max. Deviation (ppm)
V nom (V)	3.70	T (°C)	-20	5785.0332	5785	0.03320	-5.7390
		T (°C)	-10	5785.0231	5785	0.02310	-3.9931
		T (°C)	0	5785.0315	5785	0.03150	-5.4451
		T (°C)	10	5785.0007	5785	0.00070	-0.1210
		T (°C)	20	5785.0079	5785	0.00790	-1.3656
		T (°C)	30	5785.0070	5785	0.00700	-1.2100
		T (°C)	40	5785.0232	5785	0.02320	-4.0104
		T (°C)	50	5785.0295	5785	0.02950	-5.0994
		T (°C)	60	5785.0015	5785	0.00150	-0.2593
		T (°C)	70	5785.0170	5785	0.01700	-2.9386
Limits				Within 5745-5850MHz			
Result				Complies			

Voltage vs. Frequency Stability

TEST CONDITIONS				Reference Frequency: 5825MHz			
				f	fc	Max. Deviation (MHz)	Max. Deviation (ppm)
T nom (°C)	20	V nom (V)	3.70	5825.0174	5825	0.01740	-2.9871
		V max (V)	4.26	5825.0096	5825	0.00960	-1.6481
		V min (V)	3.15	5825.0095	5825	0.00950	-1.6309
Limits				Within 5745-5850MHz			
Result				Complies			

Temperature vs. Frequency Stability

TEST CONDITIONS				Reference Frequency: 5825MHz			
				f	fc	Max. Deviation (MHz)	Max. Deviation (ppm)
V nom (V)	3.70	T (°C)	-20	5825.0065	5825	0.00650	-1.1159
		T (°C)	-10	5825.0121	5825	0.01210	-2.0773
		T (°C)	0	5825.0133	5825	0.01330	-2.2833
		T (°C)	10	5825.0315	5825	0.03150	-5.4077
		T (°C)	20	5825.0198	5825	0.01980	-3.3991
		T (°C)	30	5825.0013	5825	0.00130	-0.2232
		T (°C)	40	5825.0004	5825	0.00040	-0.0687
		T (°C)	50	5825.0213	5825	0.02130	-3.6567
		T (°C)	60	5825.0181	5825	0.01810	-3.1073
		T (°C)	70	5825.0220	5825	0.02200	-3.7768
Limits				Within 5745-5850MHz			
Result				Complies			

4. ANTENNA REQUIREMENT

4.1 STANDARD REQUIREMENT

15.203 requirement: For intentional device, according to 15.203: an intentional radiator shall be designed to ensure that no antenna other than that furnished by the responsible party shall be used with the device.

4.2 EUT ANTENNA

The EUT antenna is permanent attached PIFA antenna (antenna gain: 1.15 dBi). It comply with the standard requirement.

5. TEST RESULTS

5.2G WIFI

5.1 DUTY CYCLE

Condition	Mode	Frequency (MHz)	Antenna	Duty Cycle (%)	Correction Factor (dB)	1/T (kHz)
NVNT	a	5180	Ant1	97.58	0.11	0.72
NVNT	a	5200	Ant1	97.59	0.11	0.72
NVNT	a	5240	Ant1	97.62	0.1	0.71
NVNT	n20	5180	Ant1	97.43	0.11	0.77
NVNT	n20	5200	Ant1	97.41	0.11	0.77
NVNT	n20	5240	Ant1	97.4	0.11	0.77
NVNT	n40	5190	Ant1	95.09	0.22	1.54
NVNT	n40	5230	Ant1	95.08	0.22	1.54
NVNT	ac20	5180	Ant1	97.43	0.11	0.76
NVNT	ac20	5200	Ant1	97.48	0.11	0.76
NVNT	ac20	5240	Ant1	97.48	0.11	0.76
NVNT	ac40	5190	Ant1	95.08	0.22	1.54
NVNT	ac40	5230	Ant1	95.11	0.22	1.54
NVNT	ac80	5210	Ant1	90.66	0.43	3.13

Test Graphs

Duty Cycle NVNT a 5180MHz Ant1

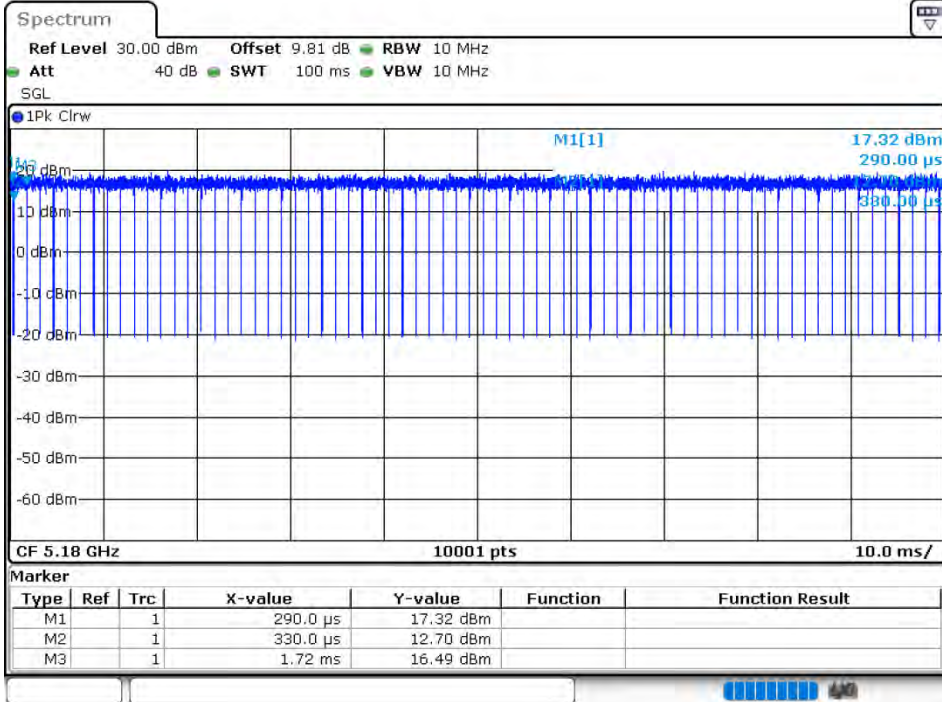

Duty Cycle NVNT a 5200MHz Ant1

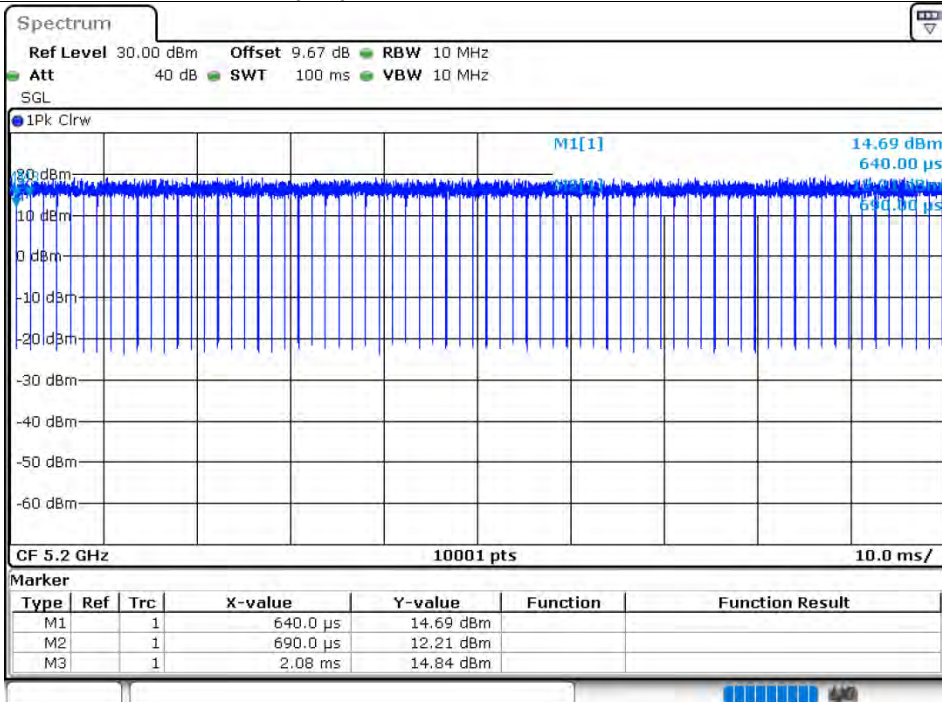

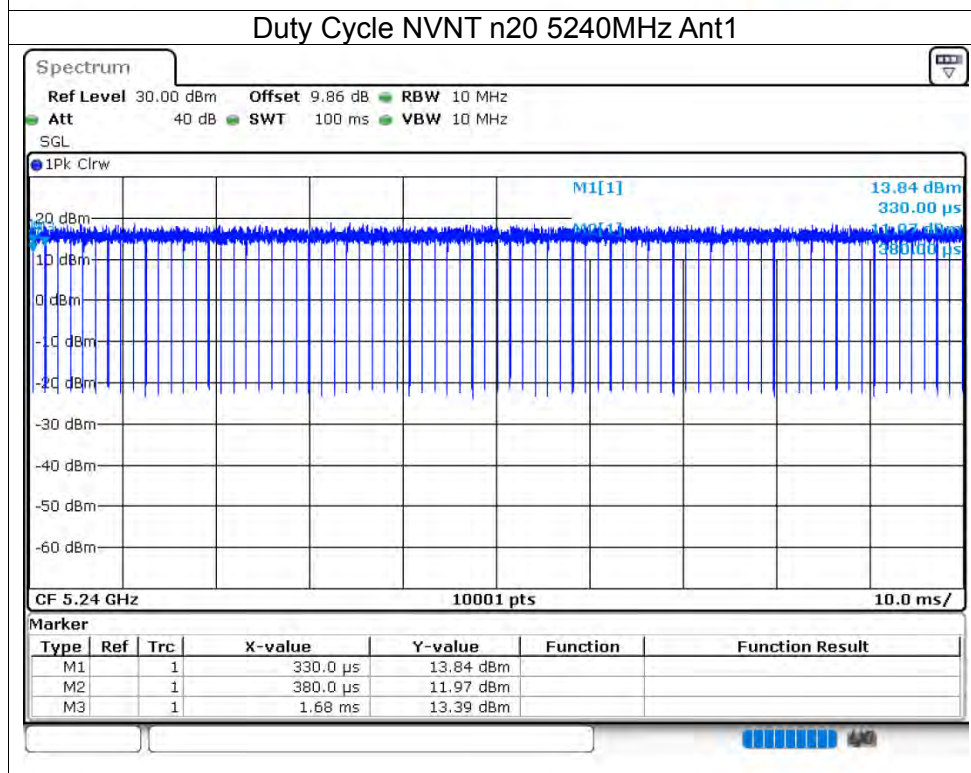
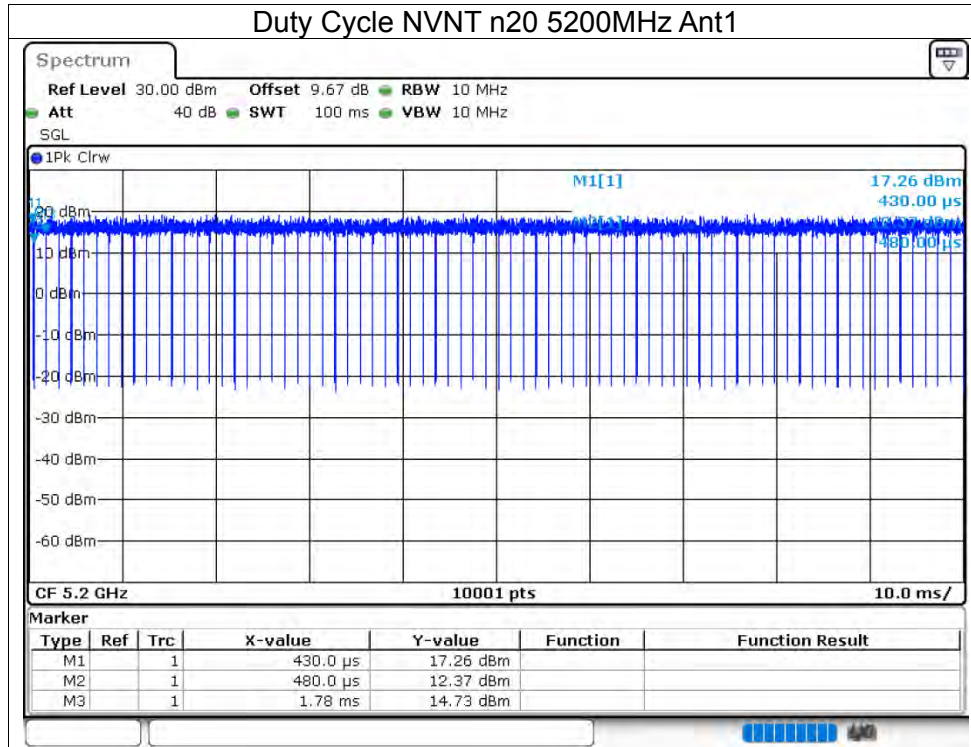

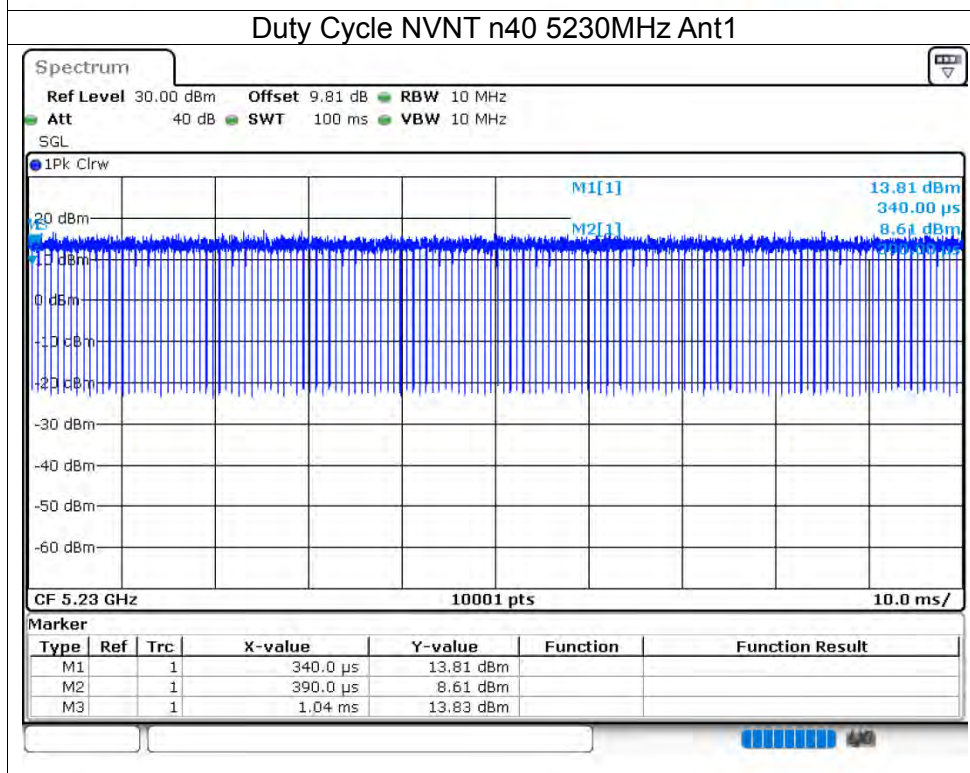
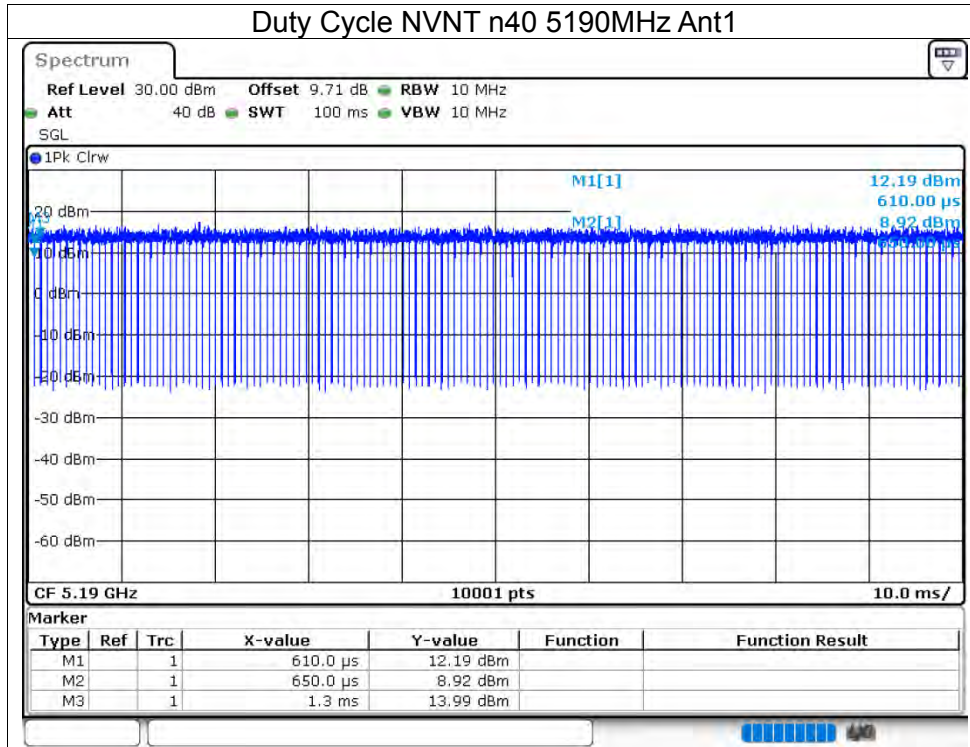

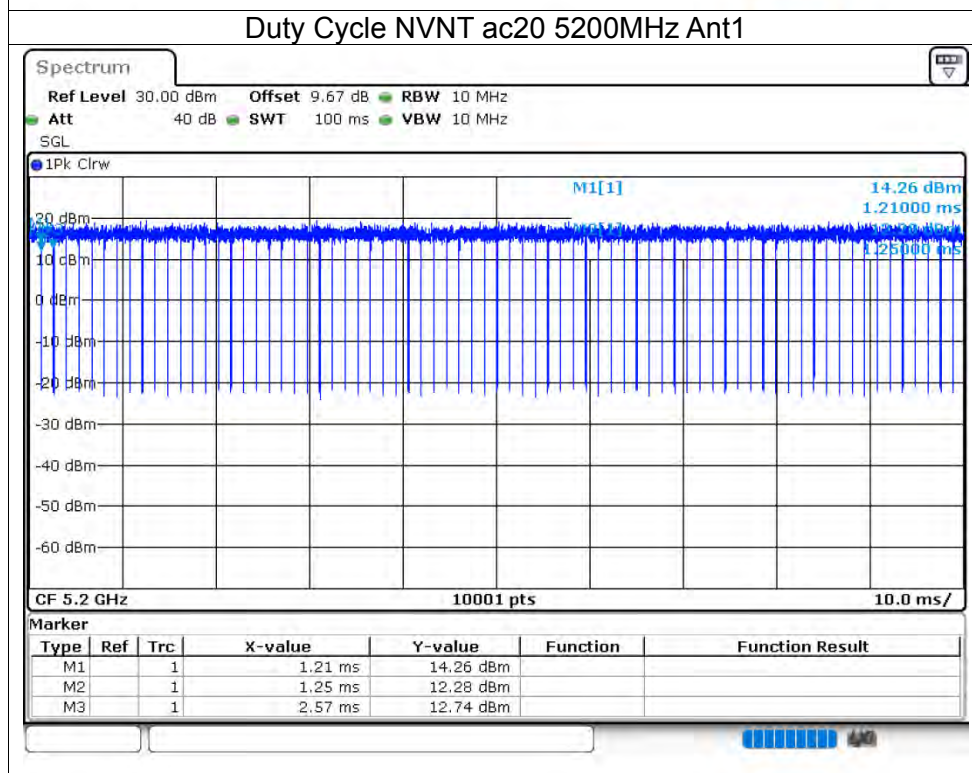
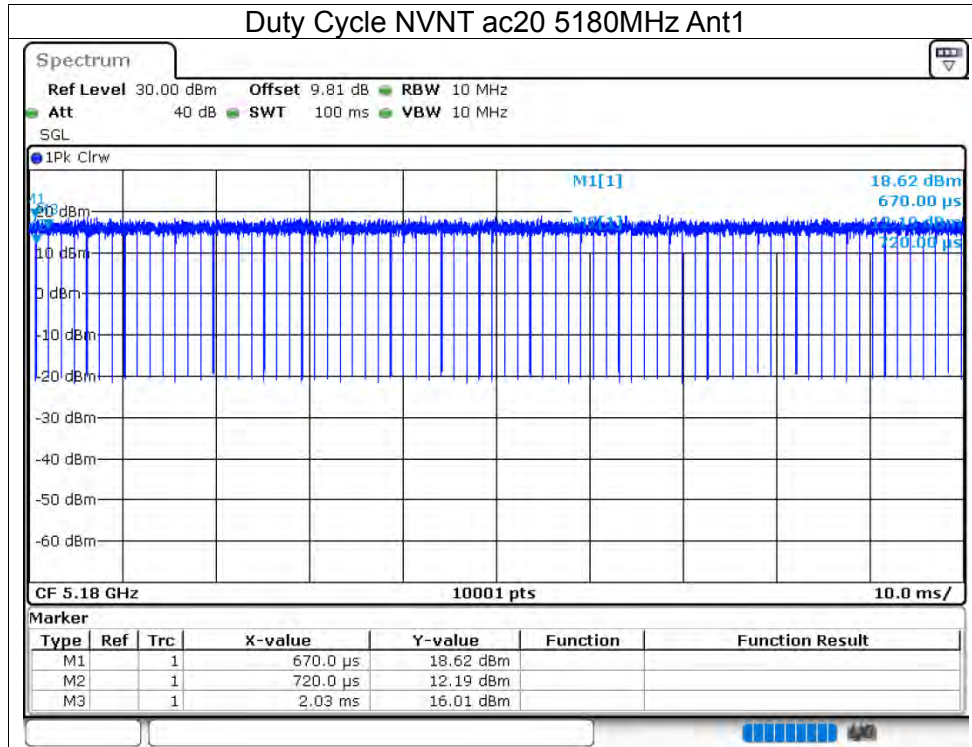

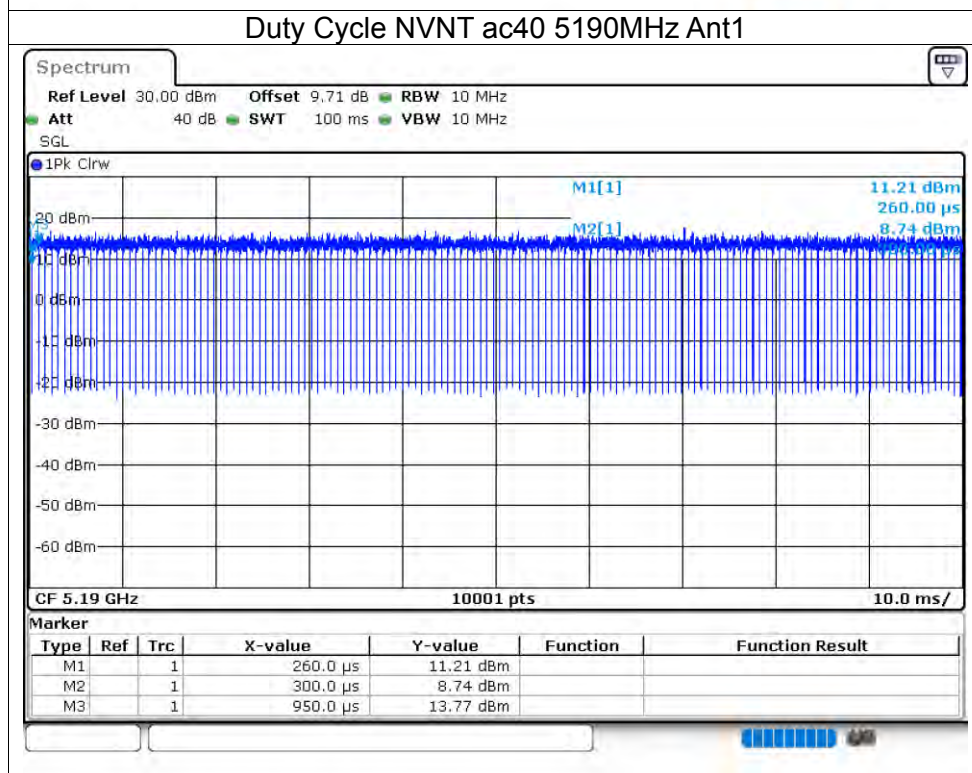
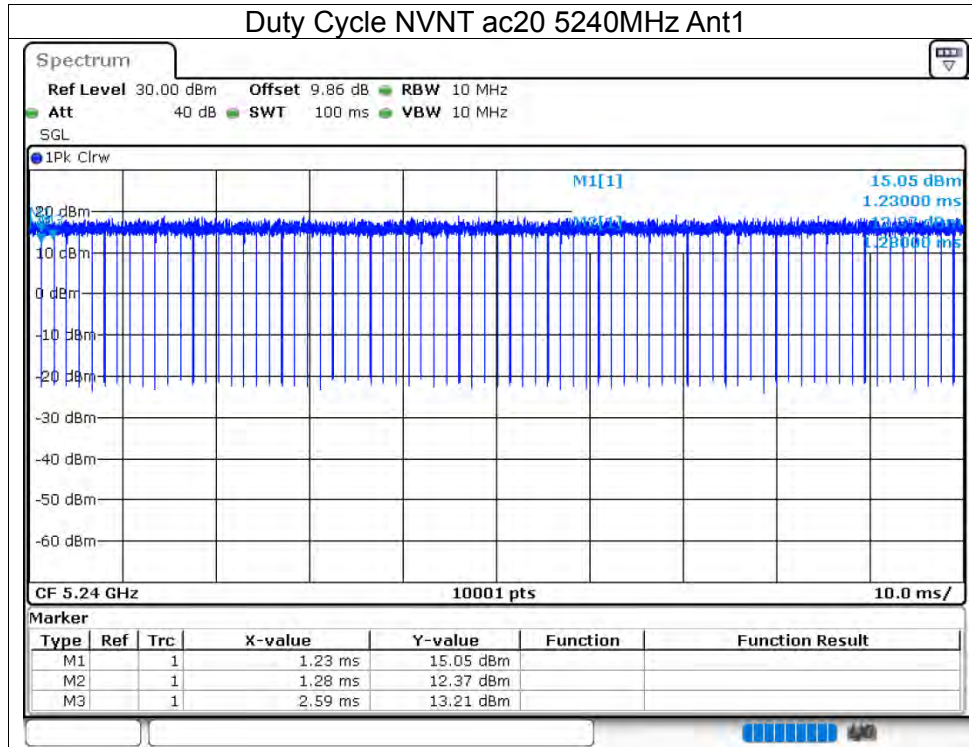

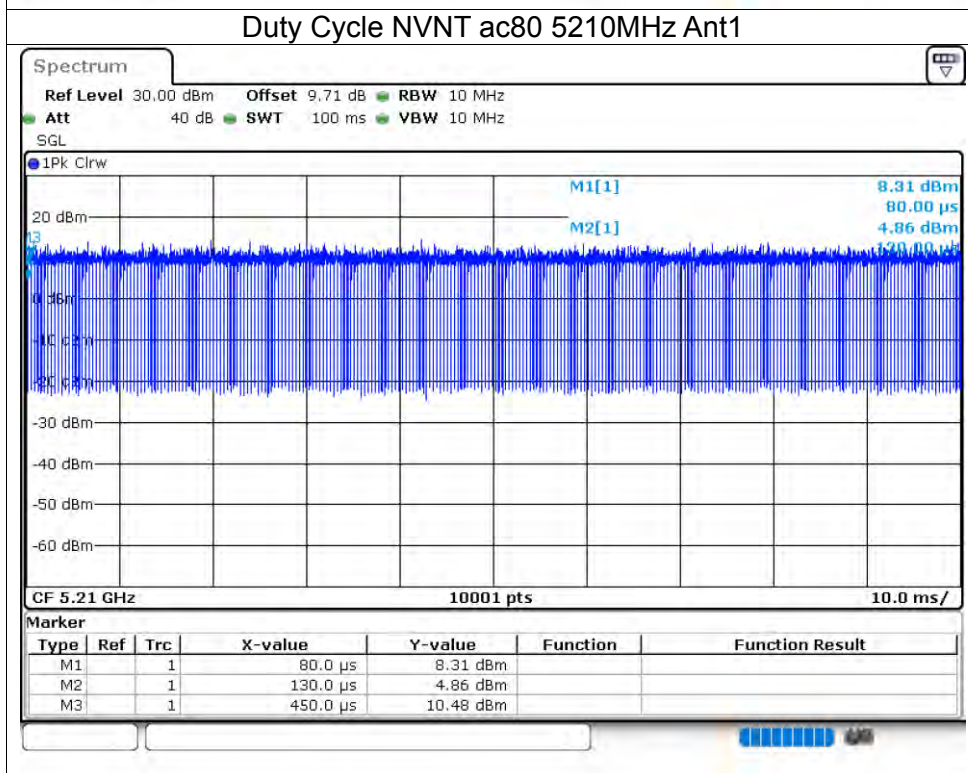
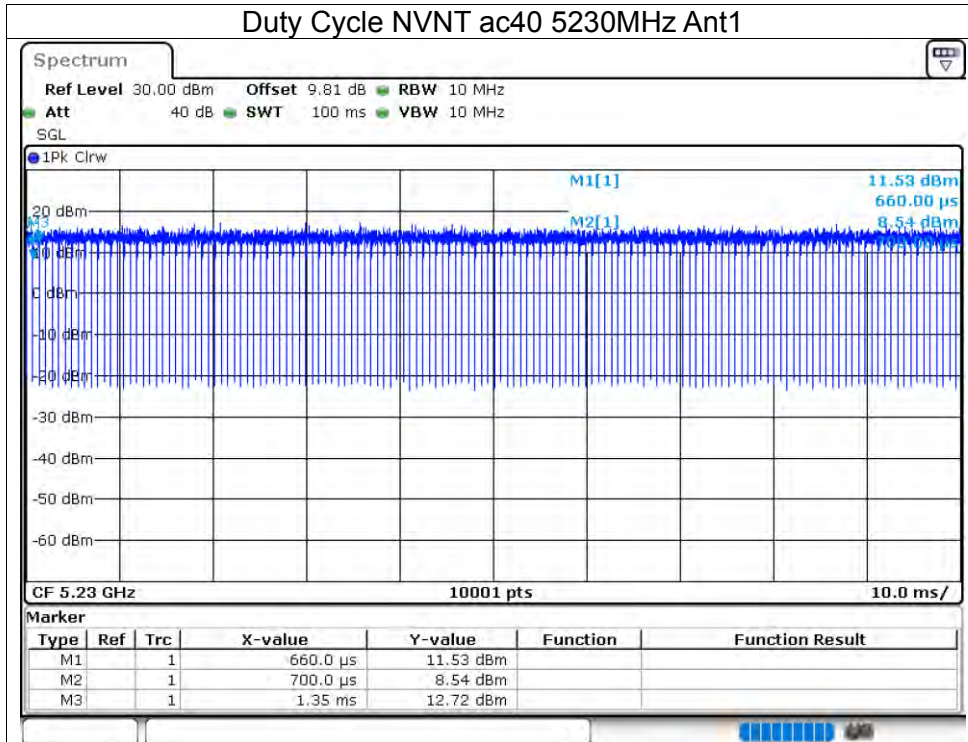

5.2 MAXIMUM CONDUCTED OUTPUT POWER

Condition	Mode	Frequency (MHz)	Antenna	Conducted Power (dBm)	Duty Factor (dB)	Total Power (dBm)	Limit (dBm)	Verdict
NVNT	a	5180	Ant1	9.81	0.11	9.92	24	Pass
NVNT	a	5200	Ant1	9.82	0.11	9.93	24	Pass
NVNT	a	5240	Ant1	9.05	0.1	9.15	24	Pass
NVNT	n20	5180	Ant1	8.78	0.11	8.89	24	Pass
NVNT	n20	5200	Ant1	9.73	0.11	9.84	24	Pass
NVNT	n20	5240	Ant1	9	0.11	9.11	24	Pass
NVNT	n40	5190	Ant1	9.39	0.22	9.61	24	Pass
NVNT	n40	5230	Ant1	9.17	0.22	9.39	24	Pass
NVNT	ac20	5180	Ant1	9.2	0.11	9.31	24	Pass
NVNT	ac20	5200	Ant1	9.76	0.11	9.87	24	Pass
NVNT	ac20	5240	Ant1	9.2	0.11	9.31	24	Pass
NVNT	ac40	5190	Ant1	9.41	0.22	9.63	24	Pass
NVNT	ac40	5230	Ant1	9.3	0.22	9.52	24	Pass
NVNT	ac80	5210	Ant1	9.27	0.43	9.7	24	Pass

5.3 -26DB BANDWIDTH

Condition	Mode	Frequency (MHz)	Antenna	-26 dB Bandwidth (MHz)	Verdict
NVNT	a	5180	Ant1	19.926	Pass
NVNT	a	5200	Ant1	19.371	Pass
NVNT	a	5240	Ant1	19.896	Pass
NVNT	n20	5180	Ant1	20.043	Pass
NVNT	n20	5200	Ant1	20.232	Pass
NVNT	n20	5240	Ant1	20.184	Pass
NVNT	n40	5190	Ant1	40.572	Pass
NVNT	n40	5230	Ant1	41.01	Pass
NVNT	ac20	5180	Ant1	20.235	Pass
NVNT	ac20	5200	Ant1	20.259	Pass
NVNT	ac20	5240	Ant1	19.962	Pass
NVNT	ac40	5190	Ant1	41.226	Pass
NVNT	ac40	5230	Ant1	40.878	Pass
NVNT	ac80	5210	Ant1	81.732	Pass

Test Graphs

-26dB Bandwidth NVNT a 5180MHz Ant1

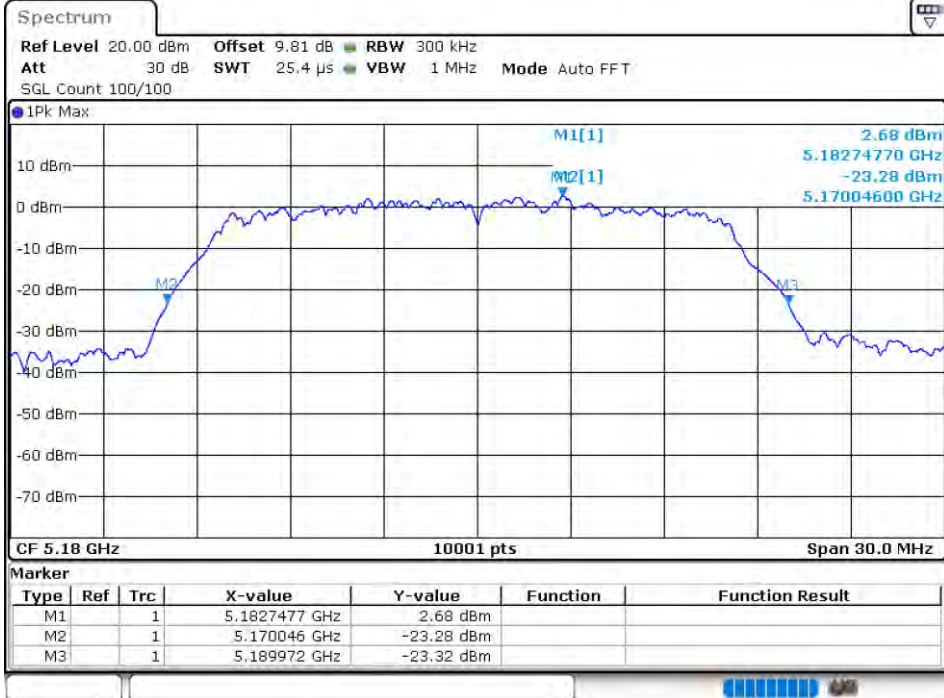

-26dB Bandwidth NVNT a 5200MHz Ant1

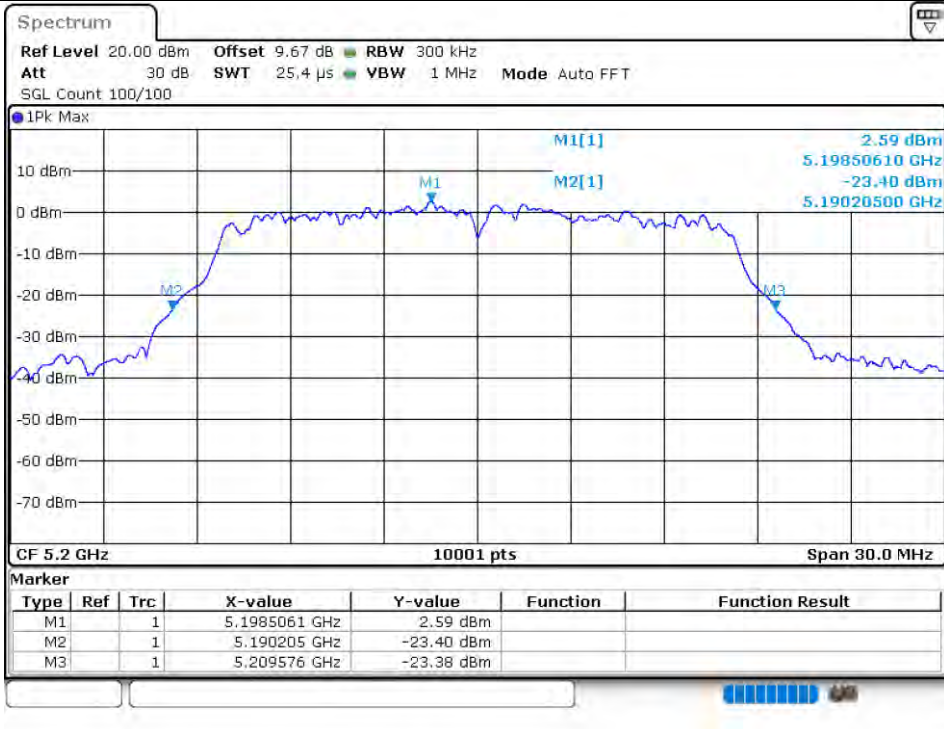

-26dB Bandwidth NVNT a 5240MHz Ant1

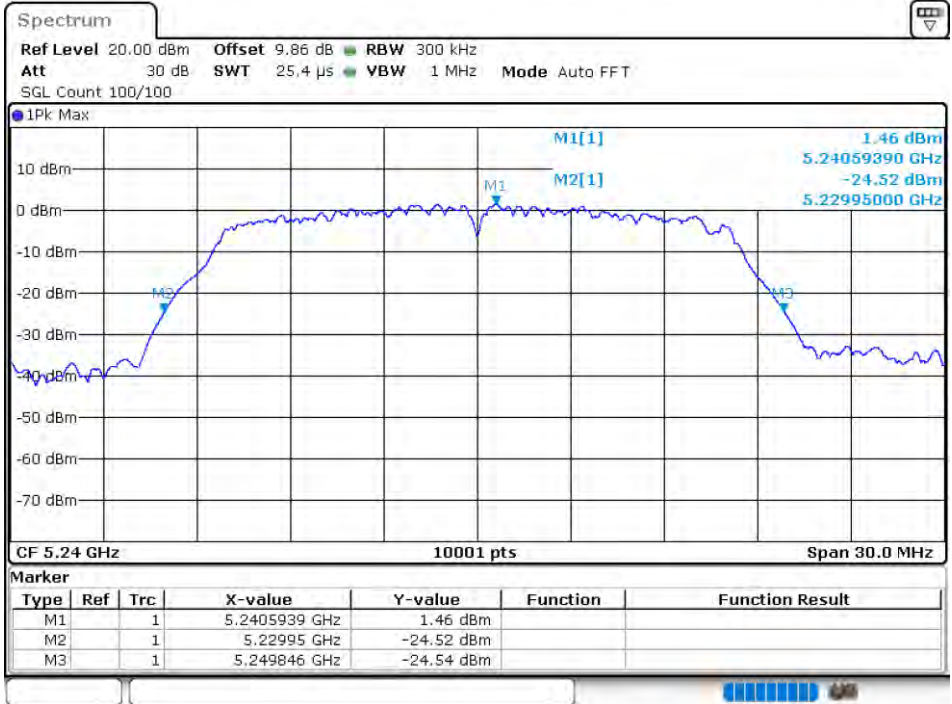

-26dB Bandwidth NVNT n20 5180MHz Ant1

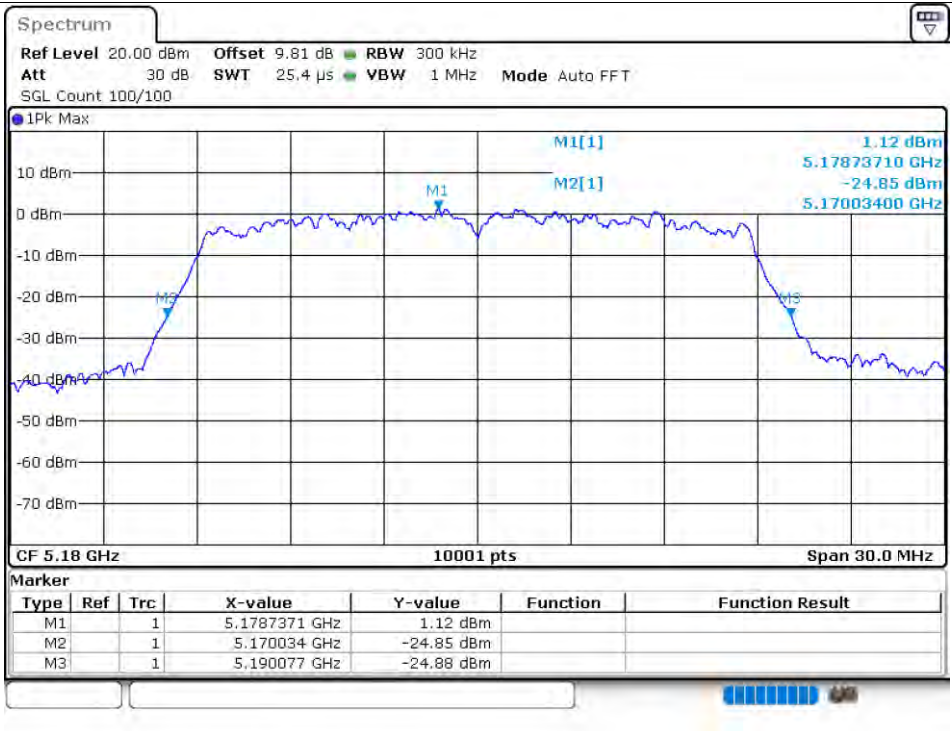

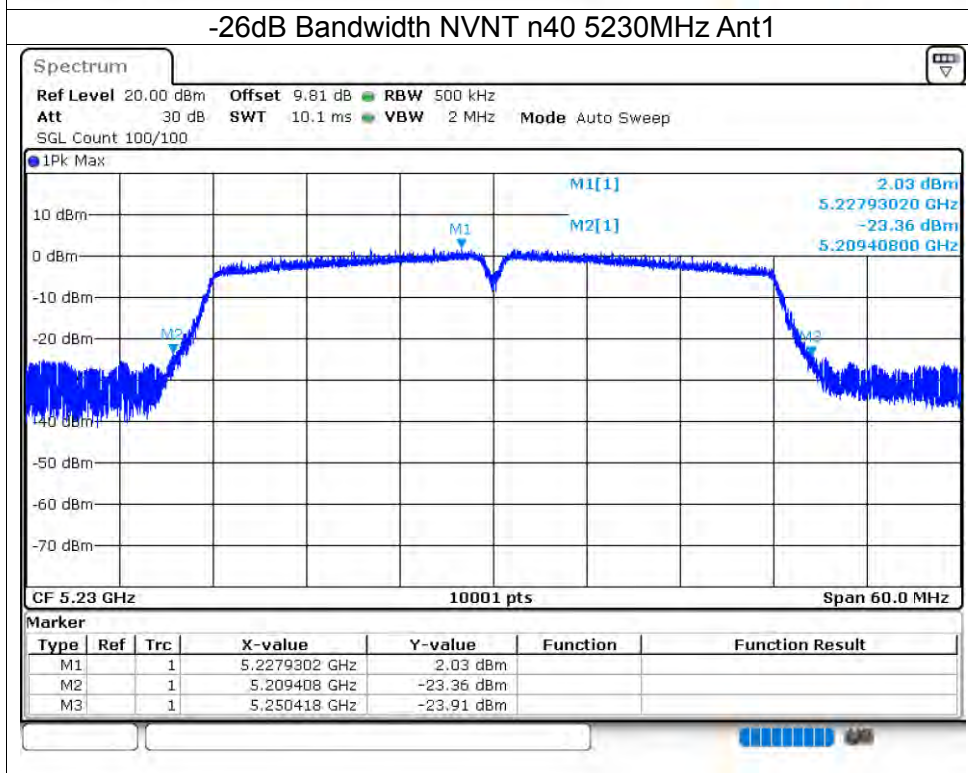
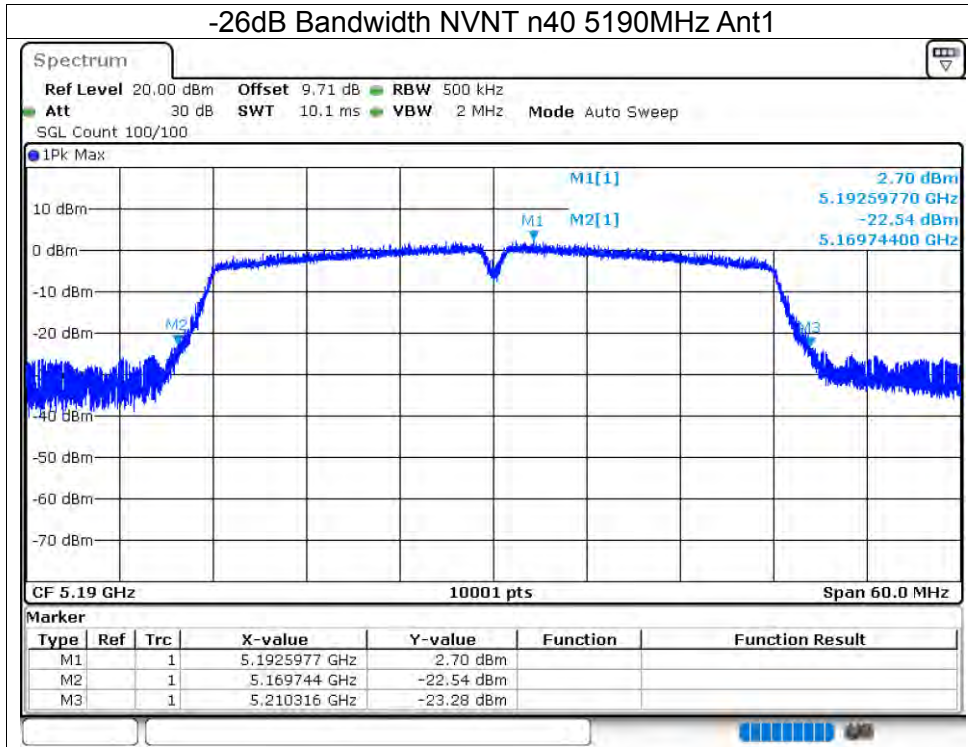

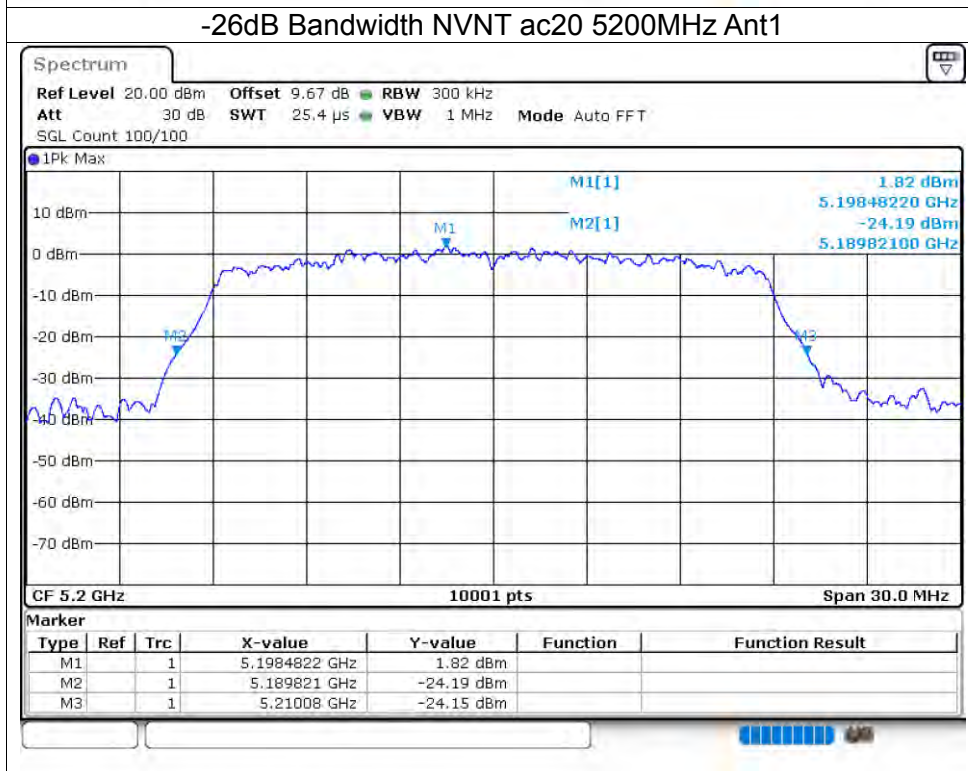
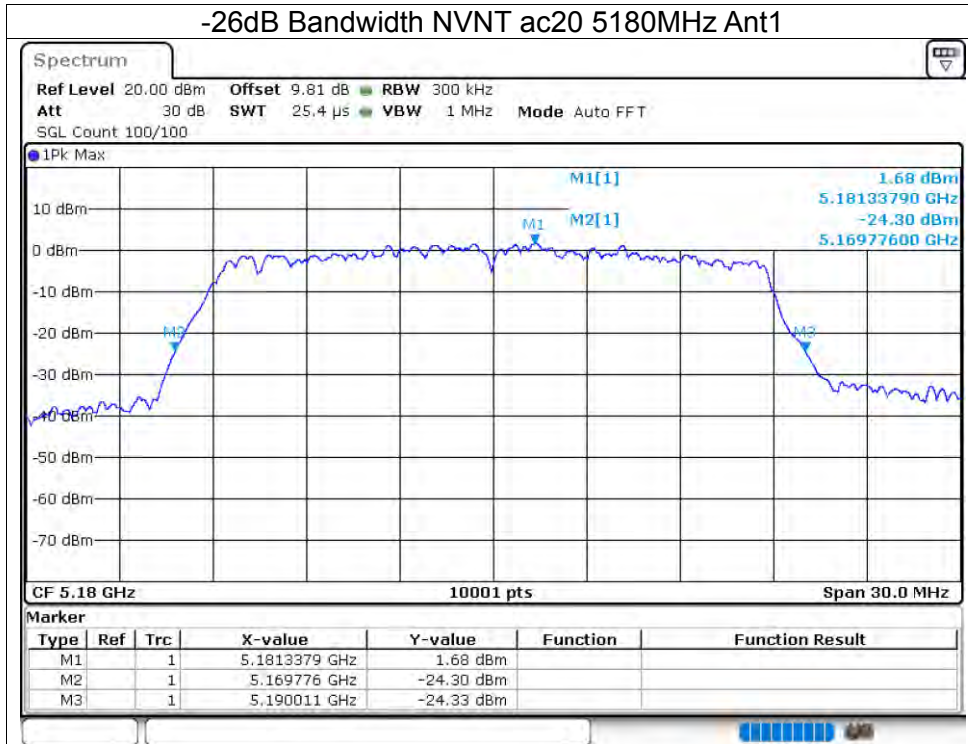

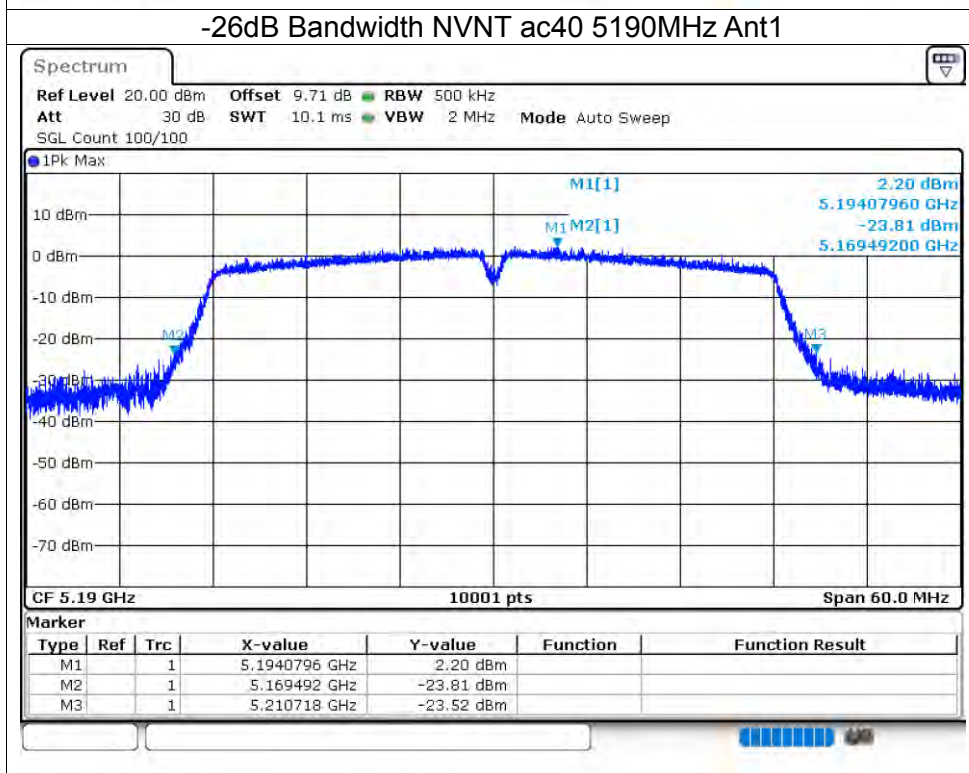
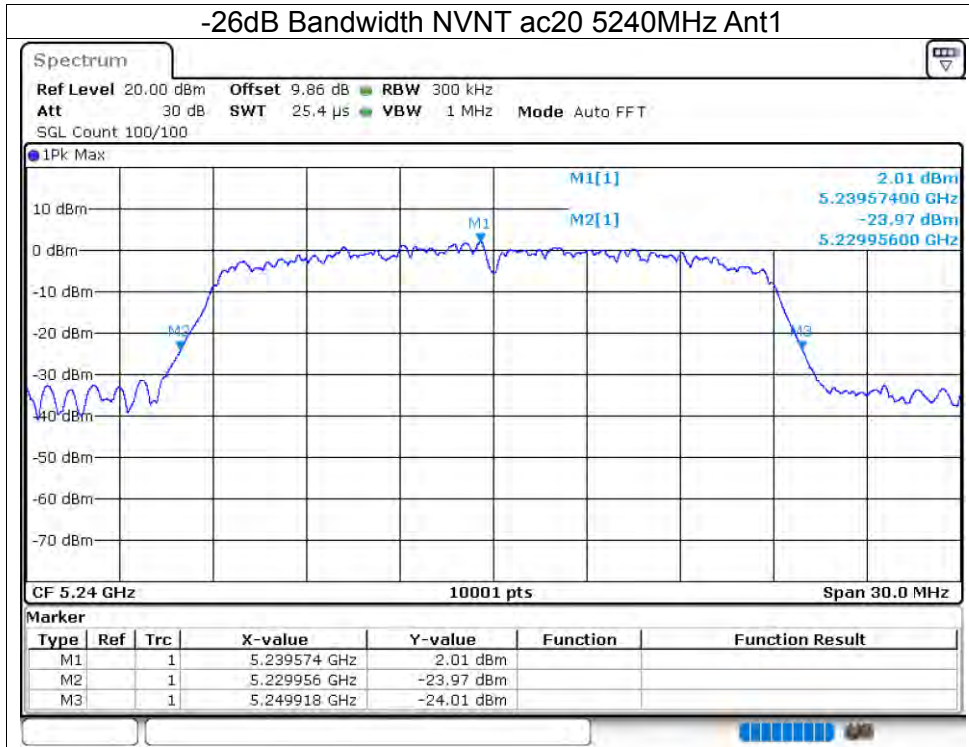

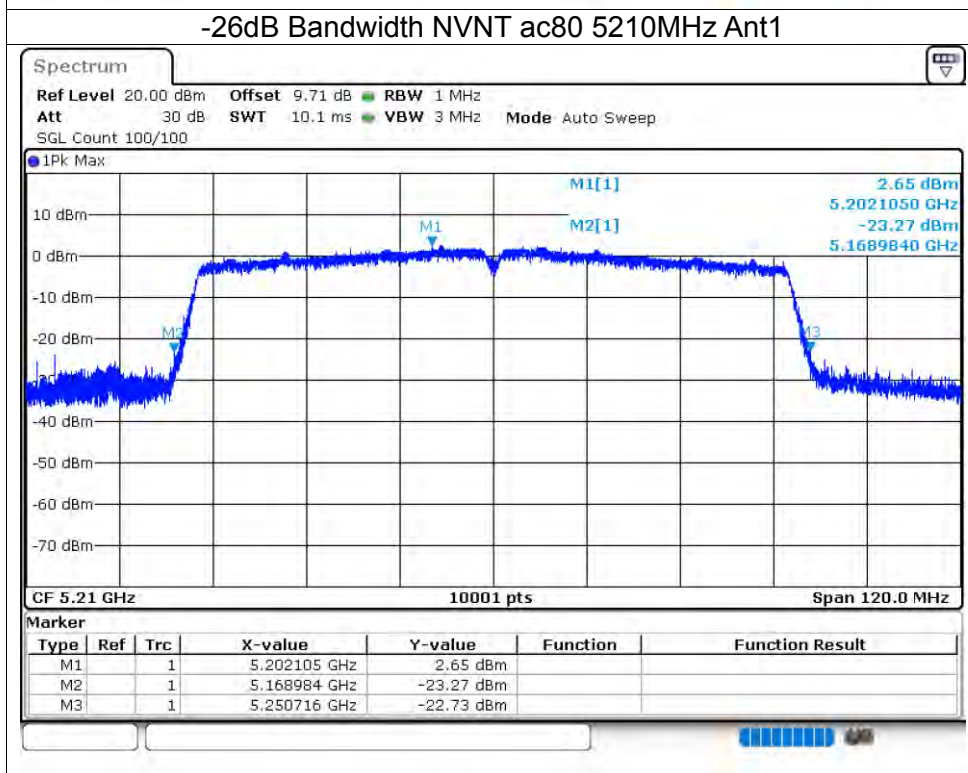
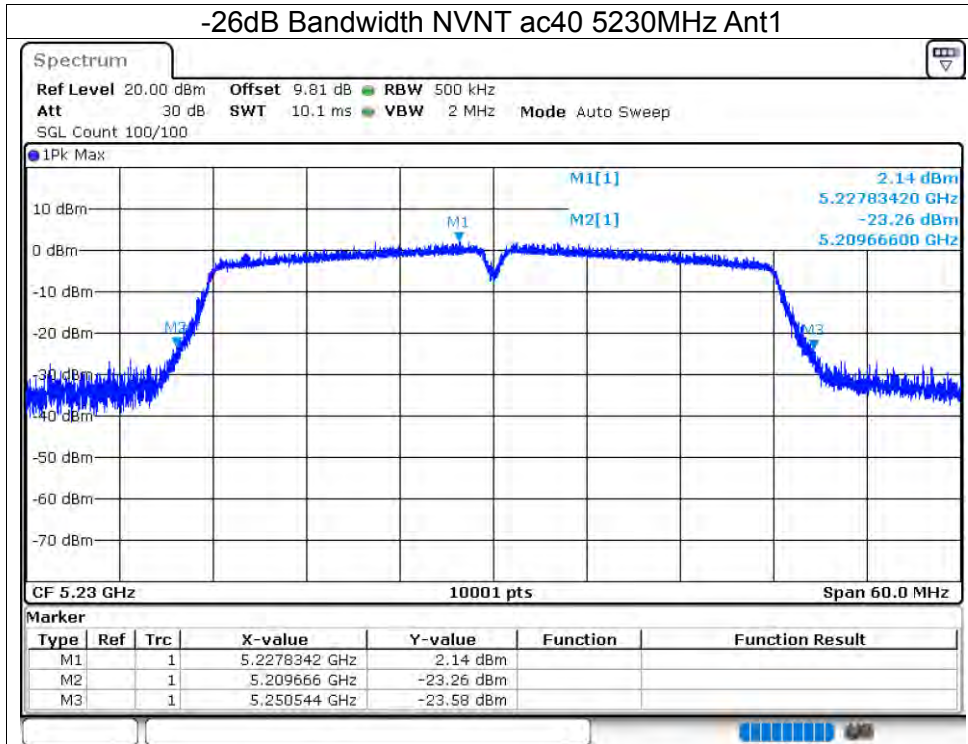

5.4 OCCUPIED CHANNEL BANDWIDTH

Condition	Mode	Frequency (MHz)	Antenna	99% OBW (MHz)
NVNT	a	5180	Ant1	16.354
NVNT	a	5200	Ant1	16.336
NVNT	a	5240	Ant1	16.441
NVNT	n20	5180	Ant1	17.545
NVNT	n20	5200	Ant1	17.518
NVNT	n20	5240	Ant1	17.503
NVNT	n40	5190	Ant1	36.038
NVNT	n40	5230	Ant1	36.104
NVNT	ac20	5180	Ant1	17.551
NVNT	ac20	5200	Ant1	17.575
NVNT	ac20	5240	Ant1	17.527
NVNT	ac40	5190	Ant1	36.02
NVNT	ac40	5230	Ant1	36.056
NVNT	ac80	5210	Ant1	75.208

Test Graphs

OBW NVNT a 5180MHz Ant1



OBW NVNT a 5200MHz Ant1



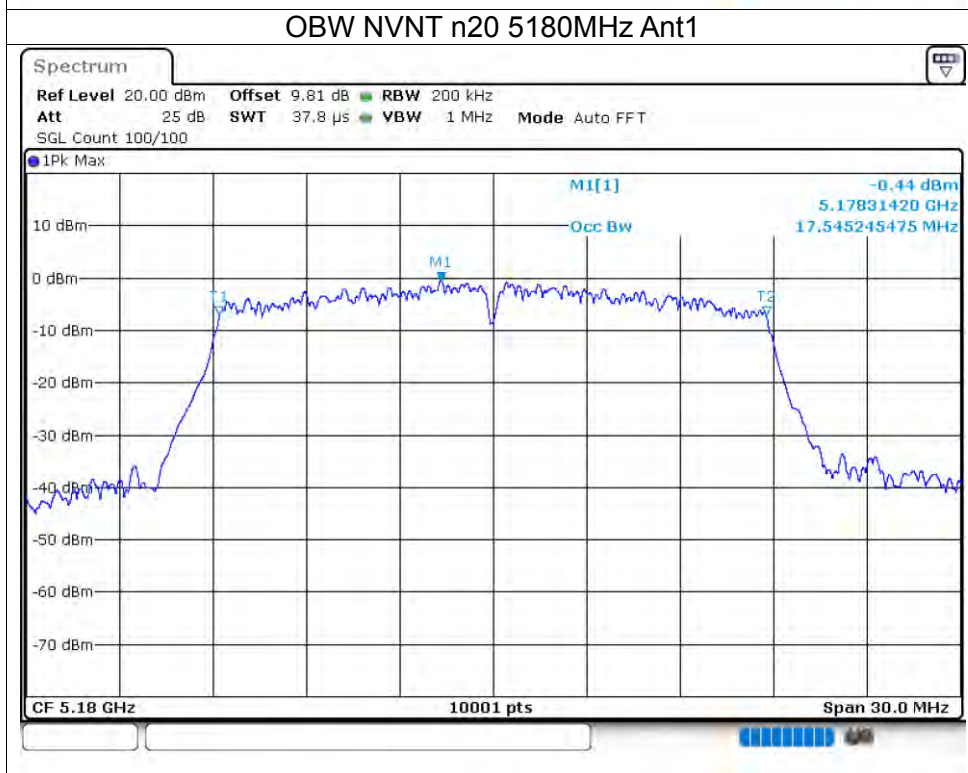
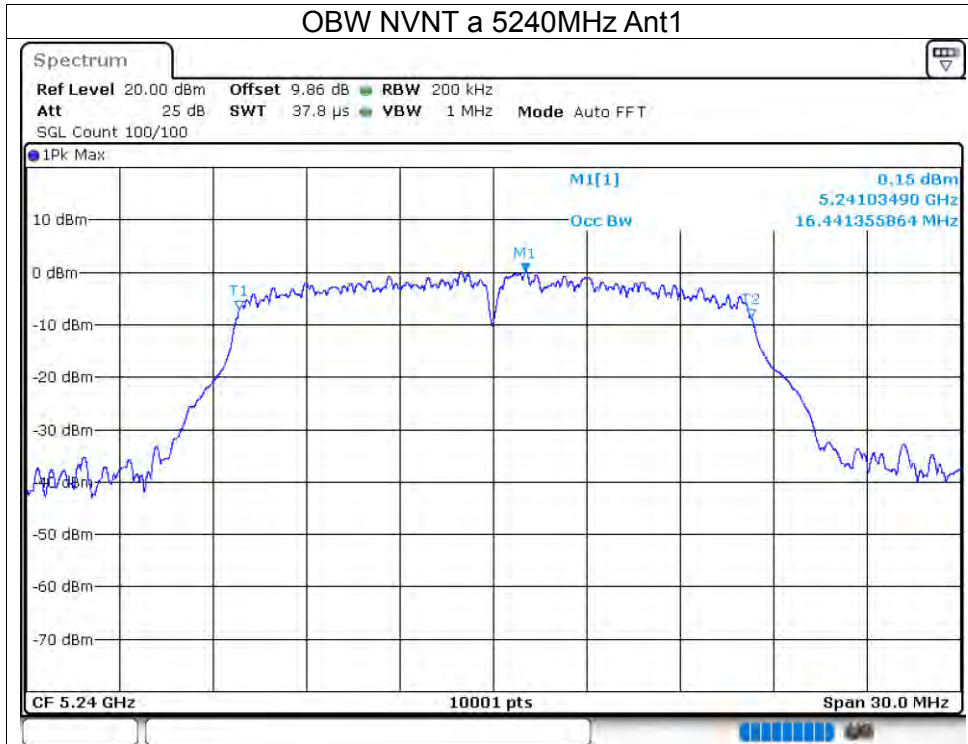

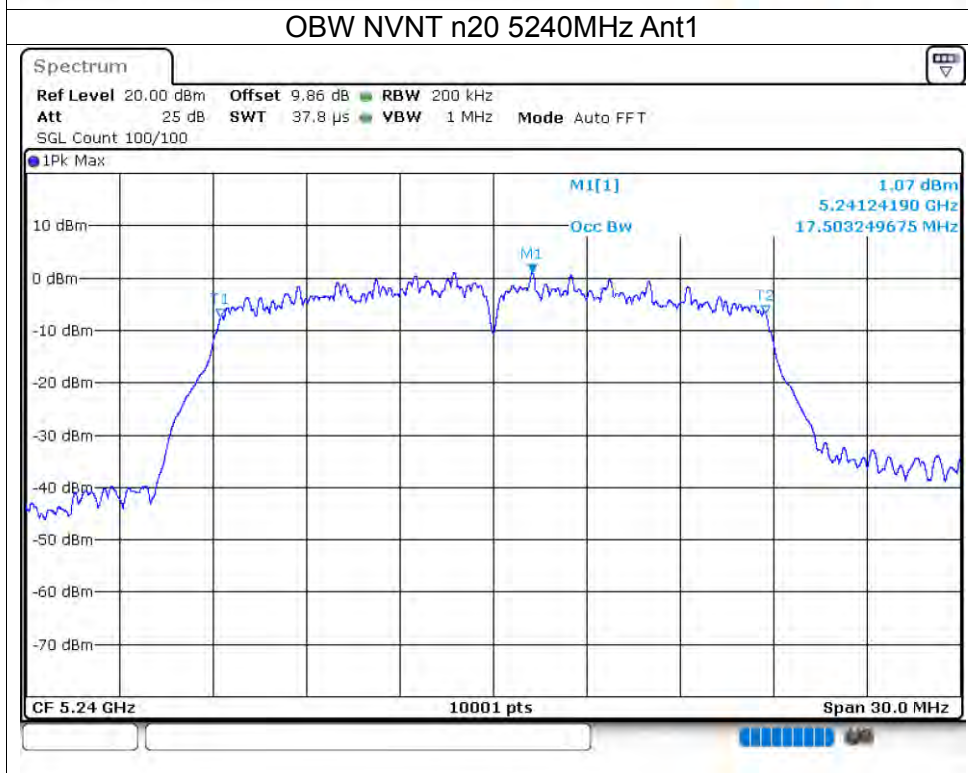
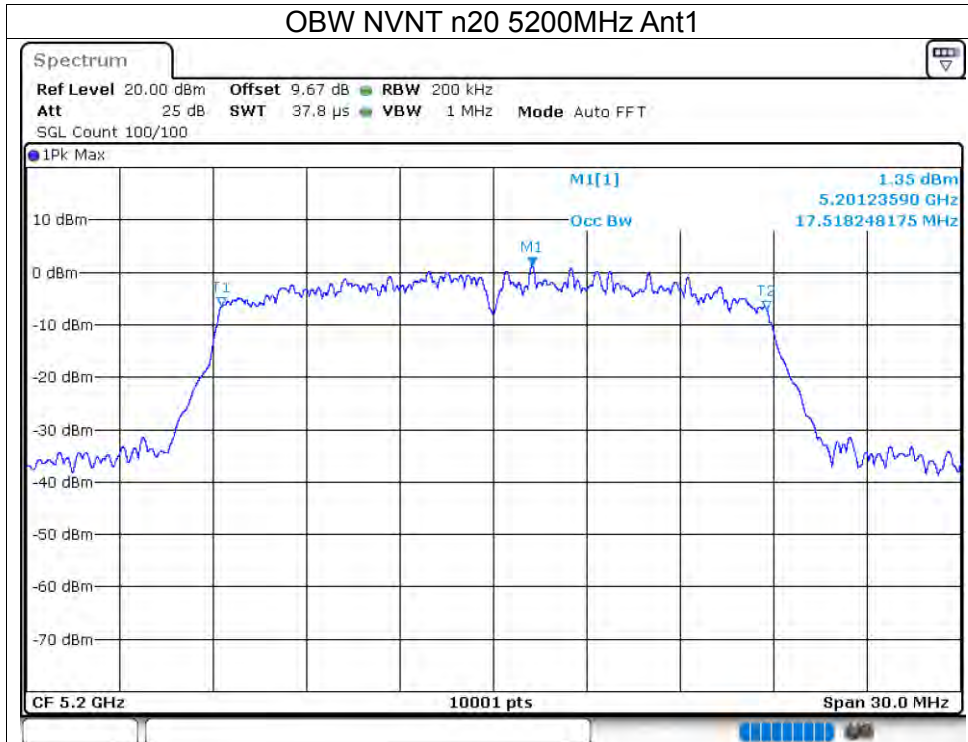

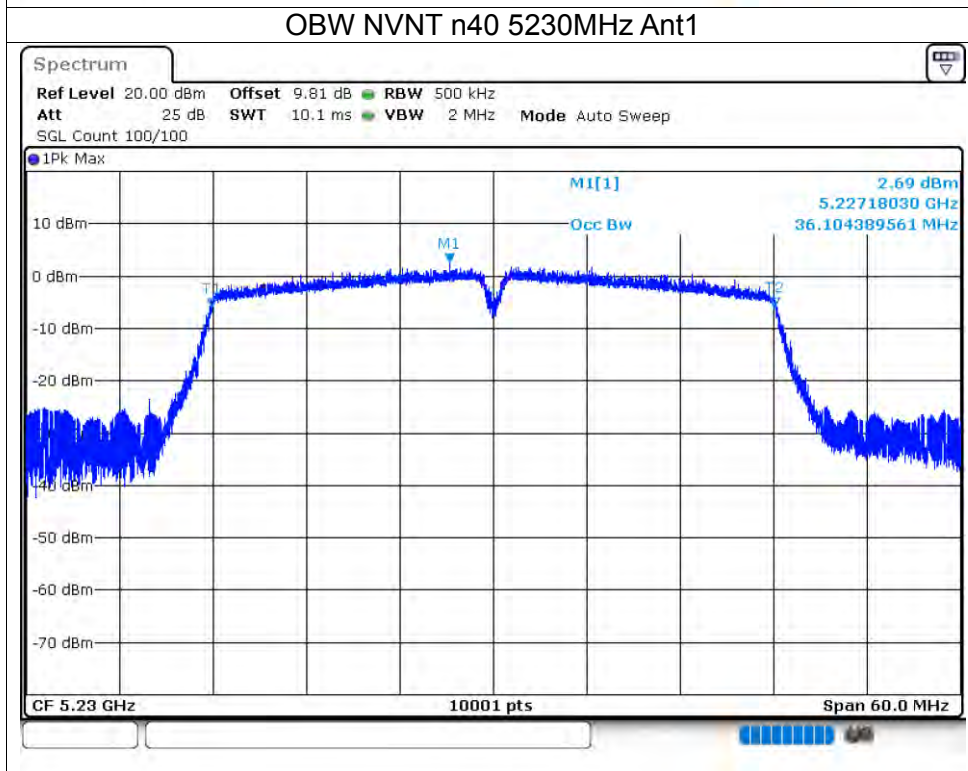
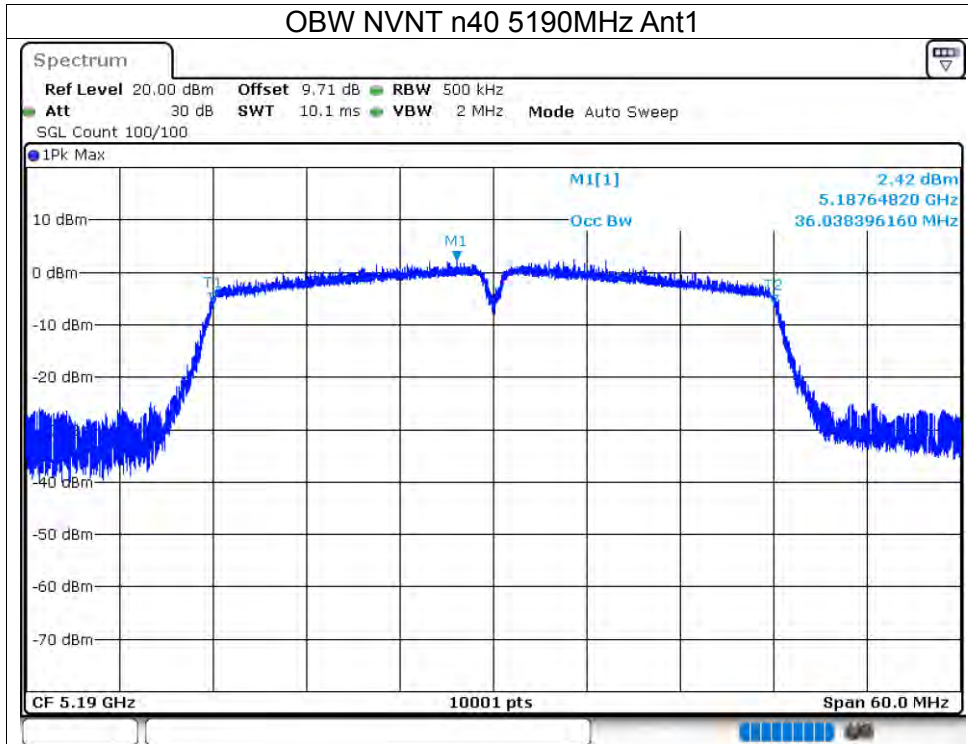

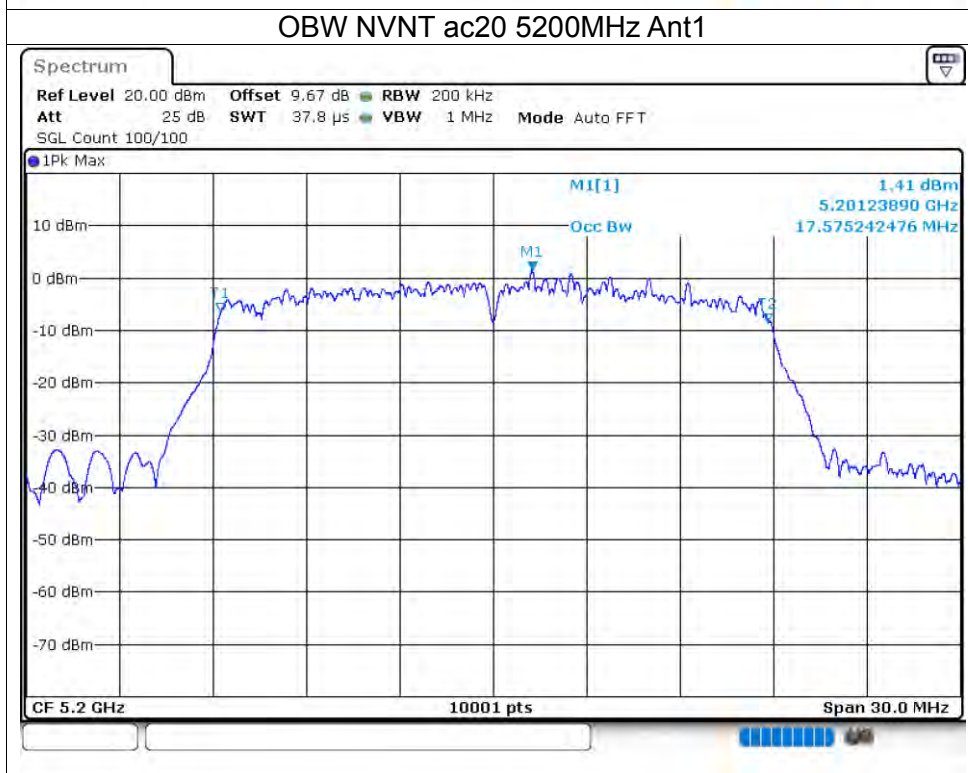
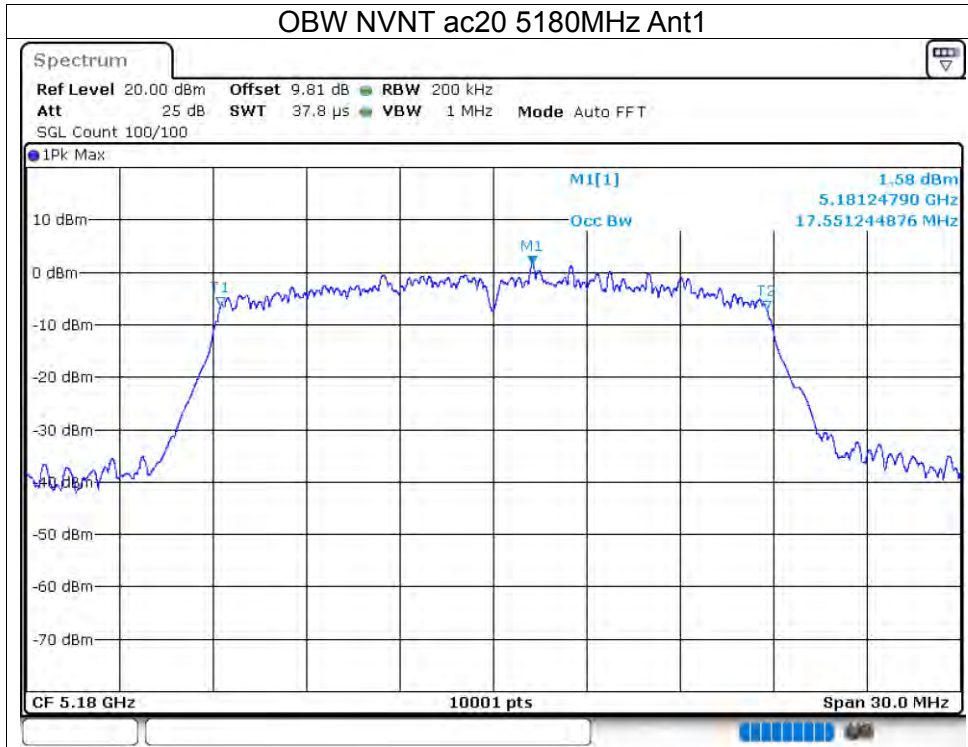

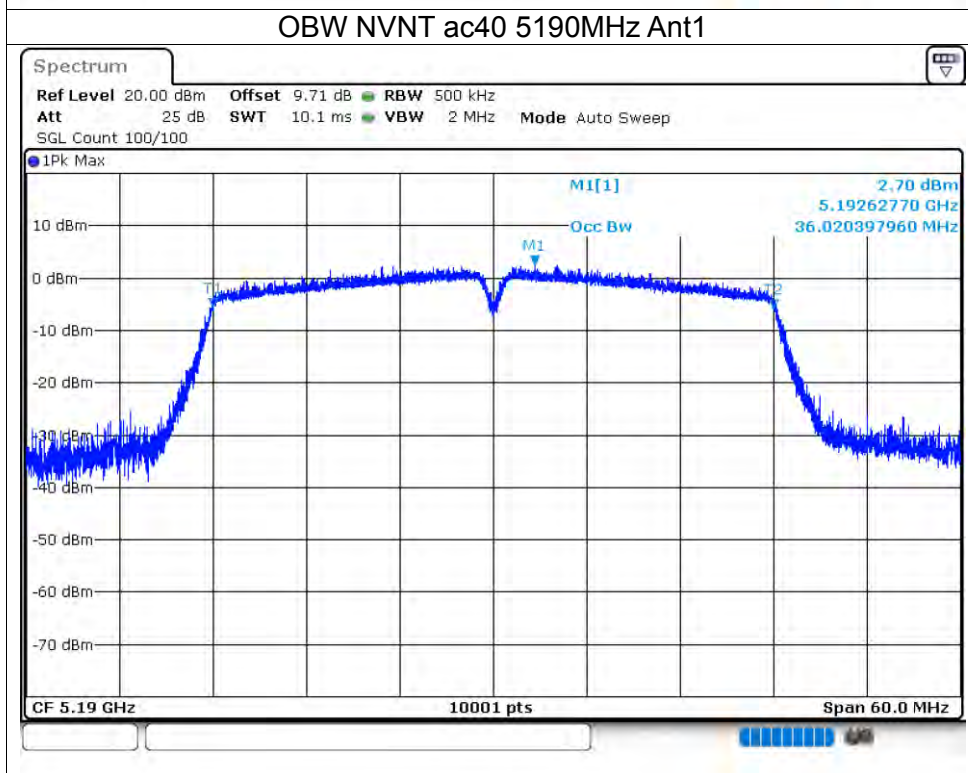
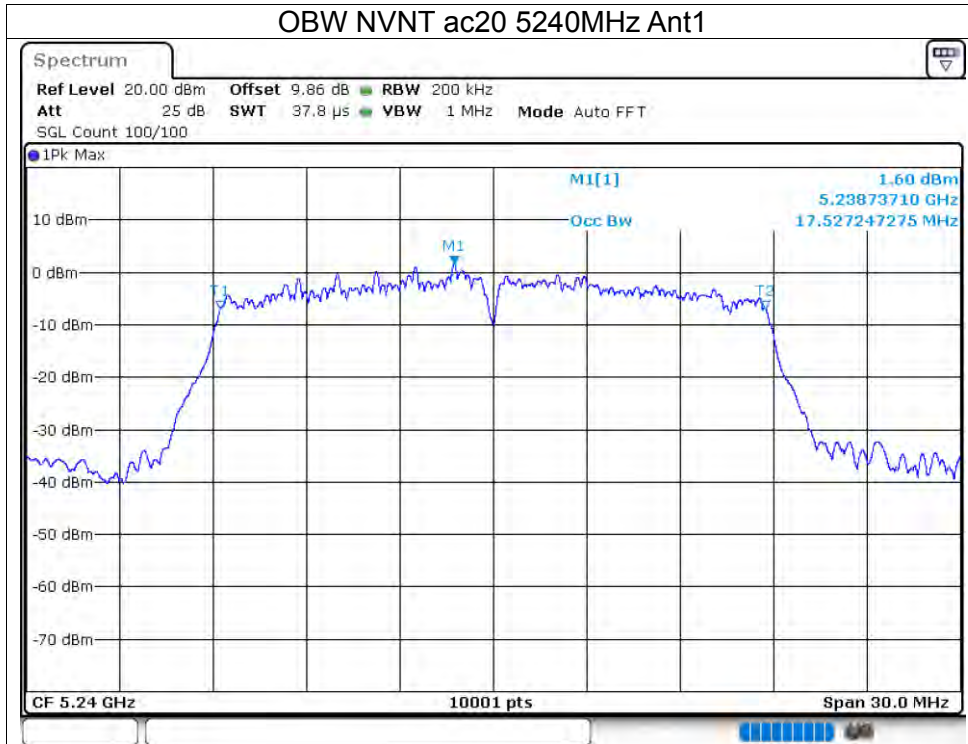

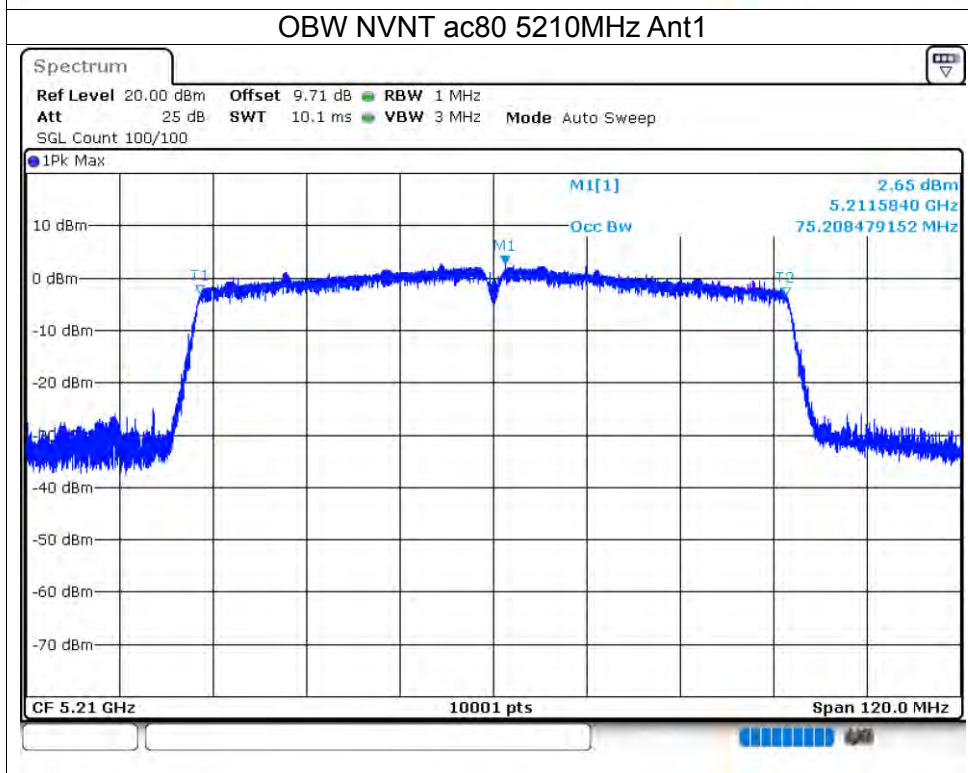
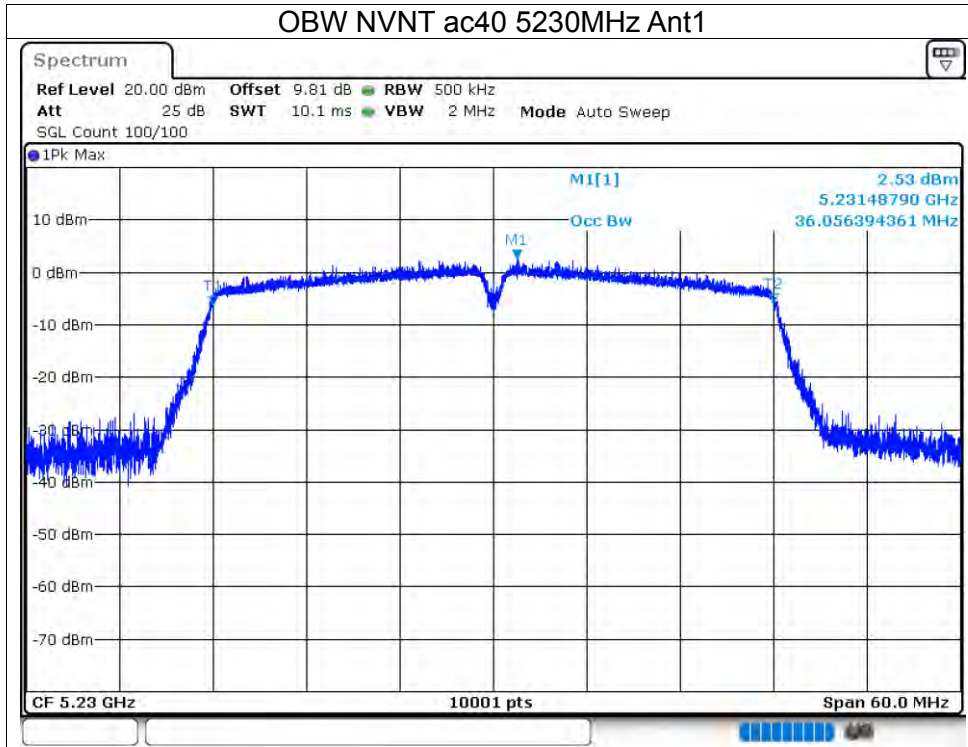

5.5 MAXIMUM POWER SPECTRAL DENSITY LEVEL

Condition	Mode	Frequency (MHz)	Antenna	Conducted PSD (dBm)	Duty Factor (dB)	Total PSD (dBm)	Limit (dBm)	Verdict
NVNT	a	5180	Ant1	0.27	0.11	0.38	11	Pass
NVNT	a	5200	Ant1	-0.95	0.11	-0.84	11	Pass
NVNT	a	5240	Ant1	-0.82	0.1	-0.72	11	Pass
NVNT	n20	5180	Ant1	-1.49	0.11	-1.38	11	Pass
NVNT	n20	5200	Ant1	-0.75	0.11	-0.64	11	Pass
NVNT	n20	5240	Ant1	-1.75	0.11	-1.64	11	Pass
NVNT	n40	5190	Ant1	-4.59	0.22	-4.37	11	Pass
NVNT	n40	5230	Ant1	-5.23	0.22	-5.01	11	Pass
NVNT	ac20	5180	Ant1	-0.66	0.11	-0.55	11	Pass
NVNT	ac20	5200	Ant1	-1.1	0.11	-0.99	11	Pass
NVNT	ac20	5240	Ant1	-0.9	0.11	-0.79	11	Pass
NVNT	ac40	5190	Ant1	-4.18	0.22	-3.96	11	Pass
NVNT	ac40	5230	Ant1	-4.66	0.22	-4.44	11	Pass
NVNT	ac80	5210	Ant1	-9.28	0.43	-8.85	11	Pass

Test Graphs

PSD NVNT a 5180MHz Ant1

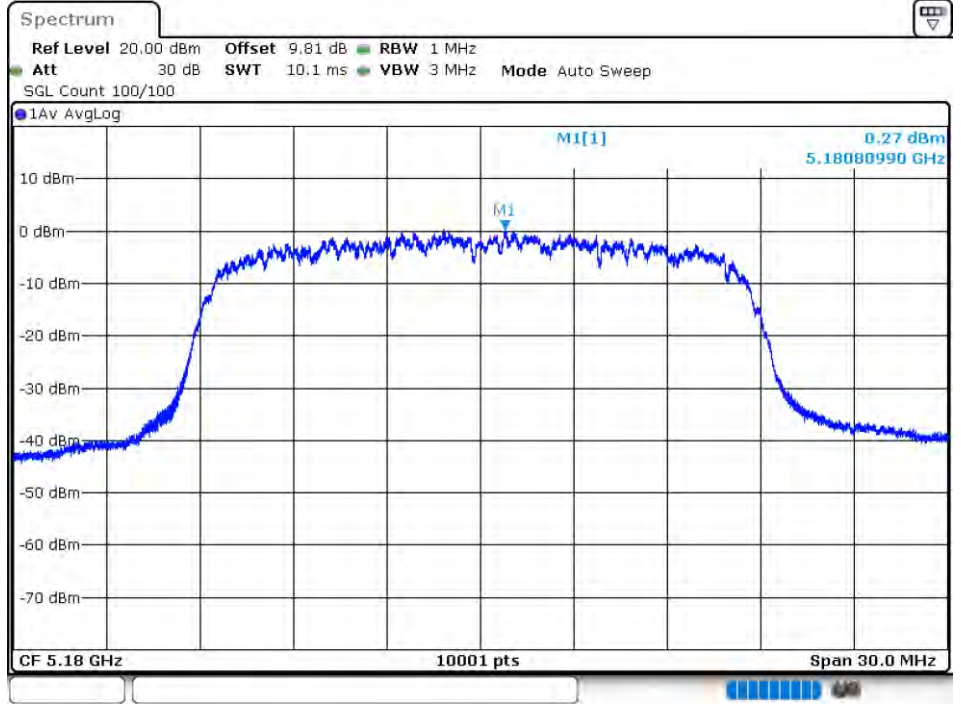

PSD NVNT a 5200MHz Ant1

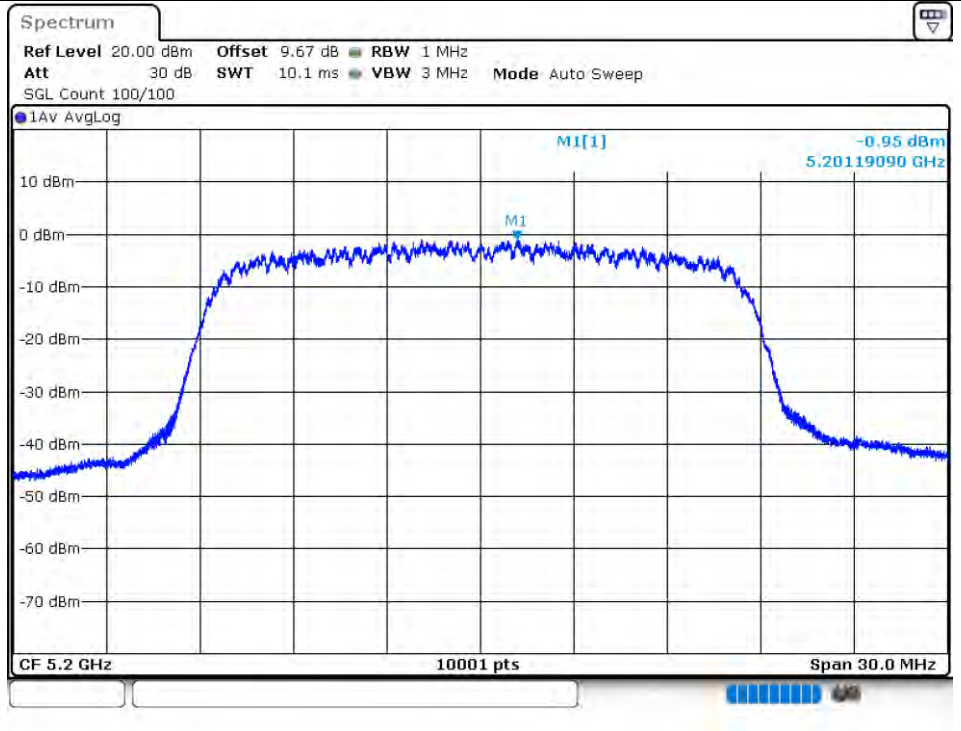

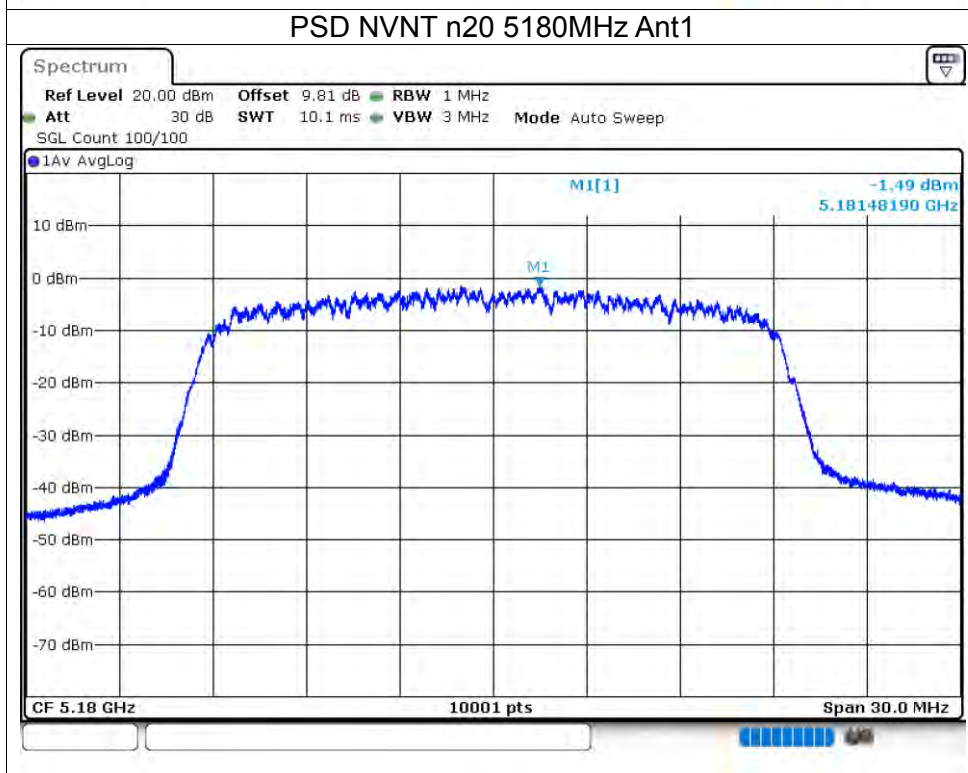
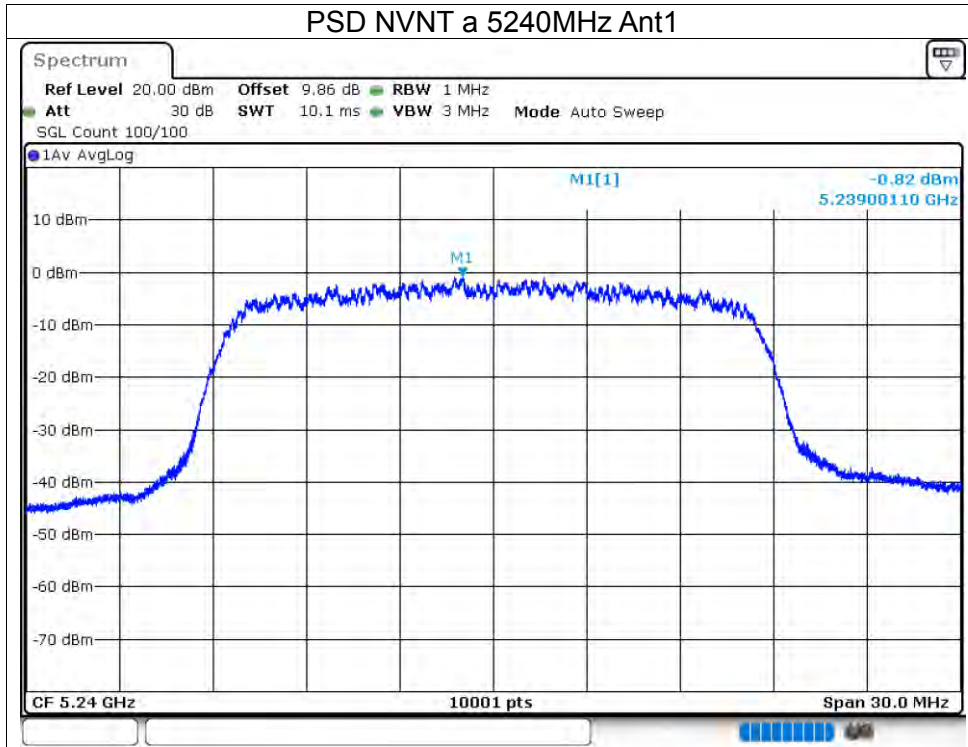

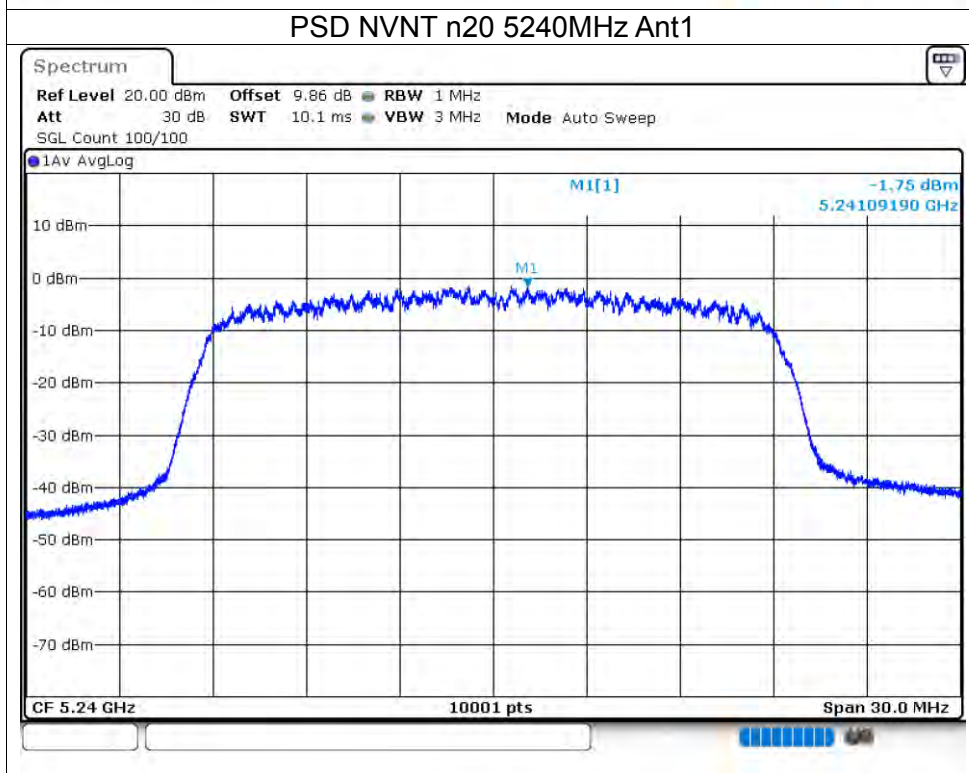
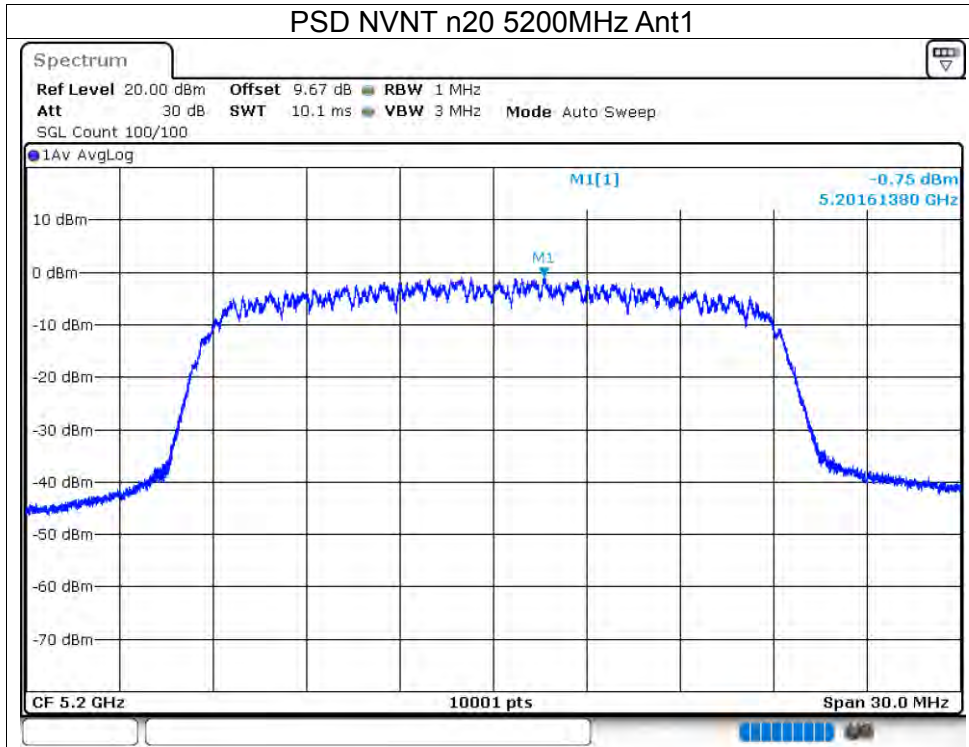

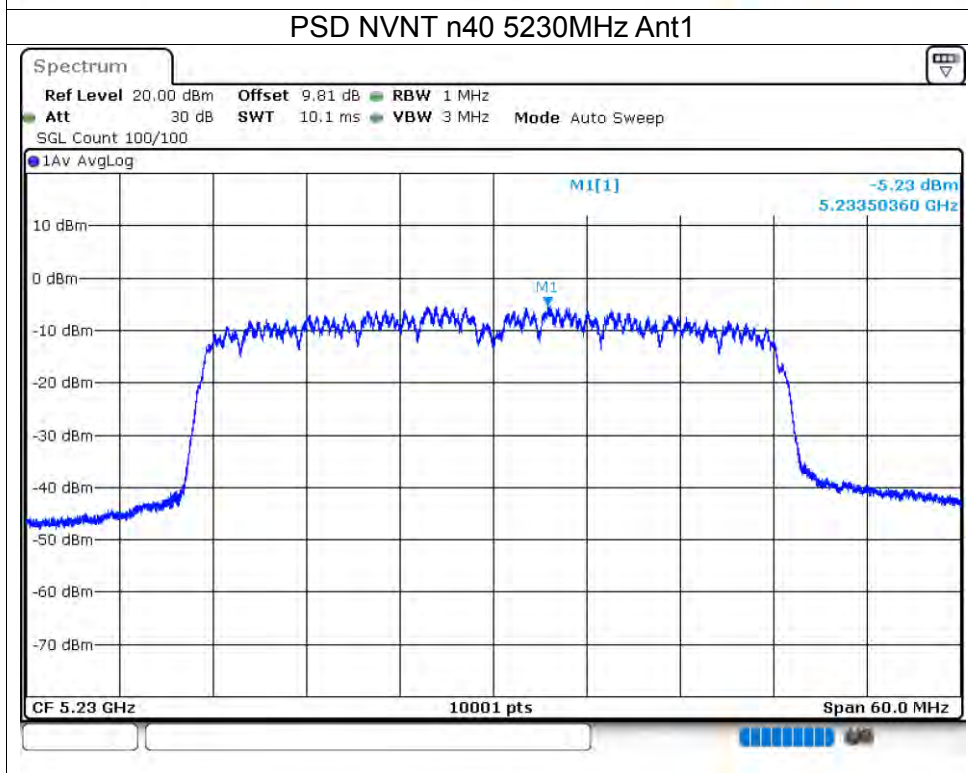
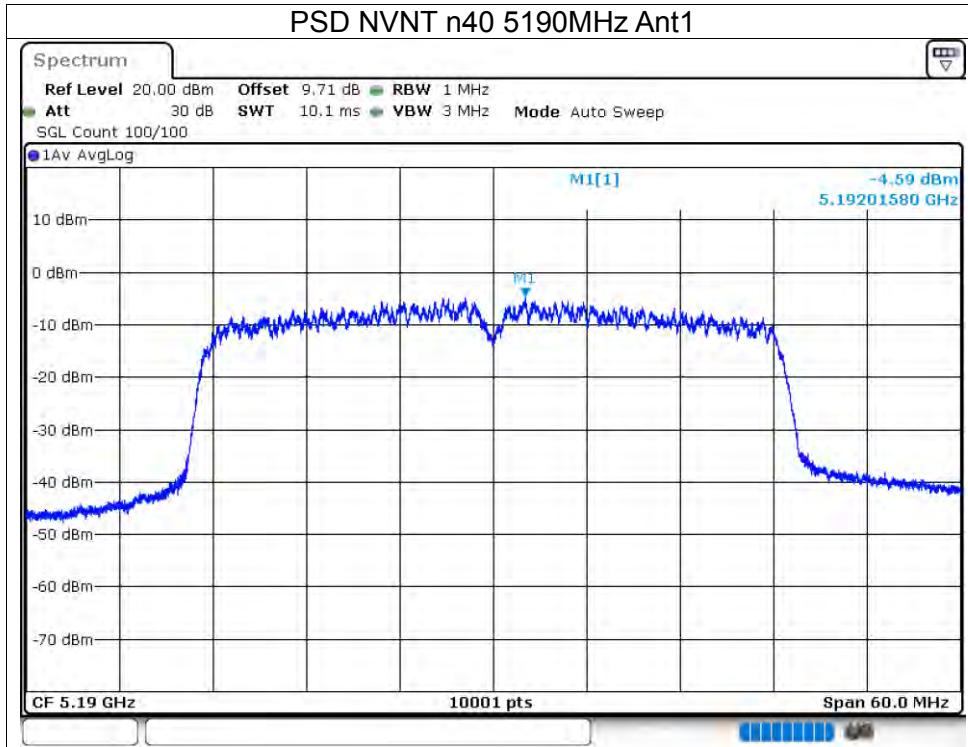

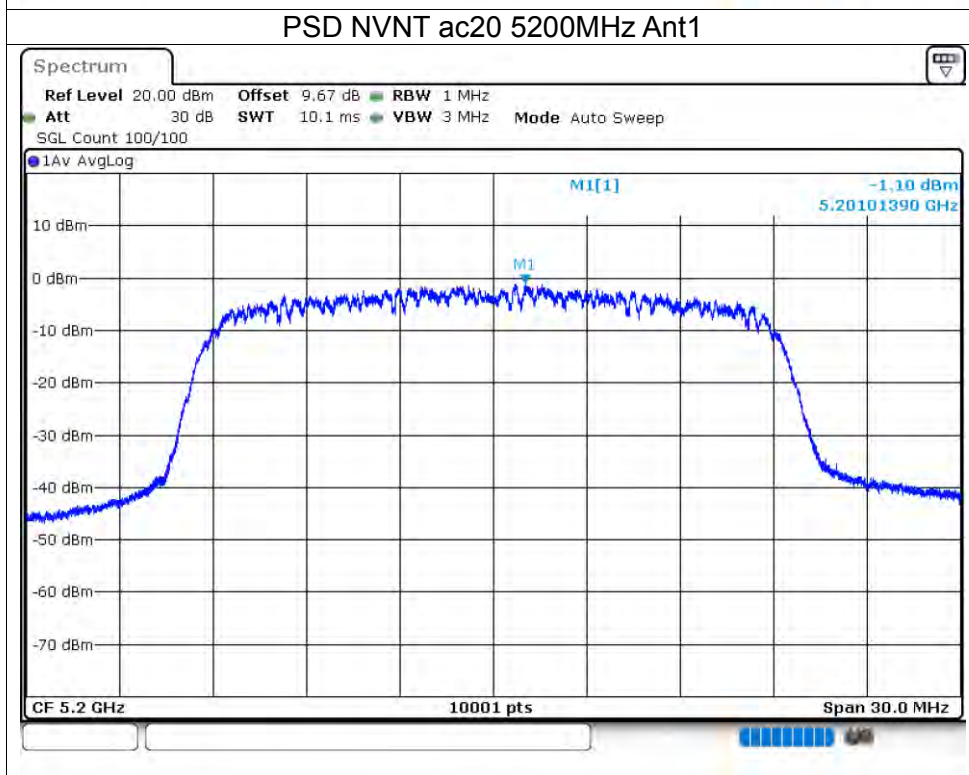
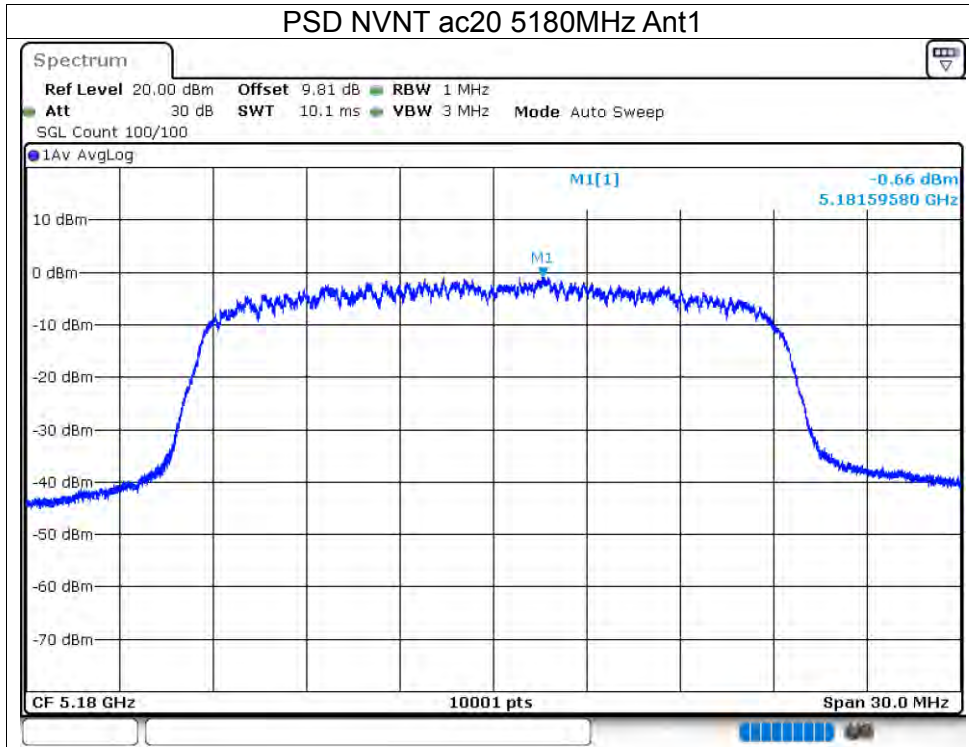

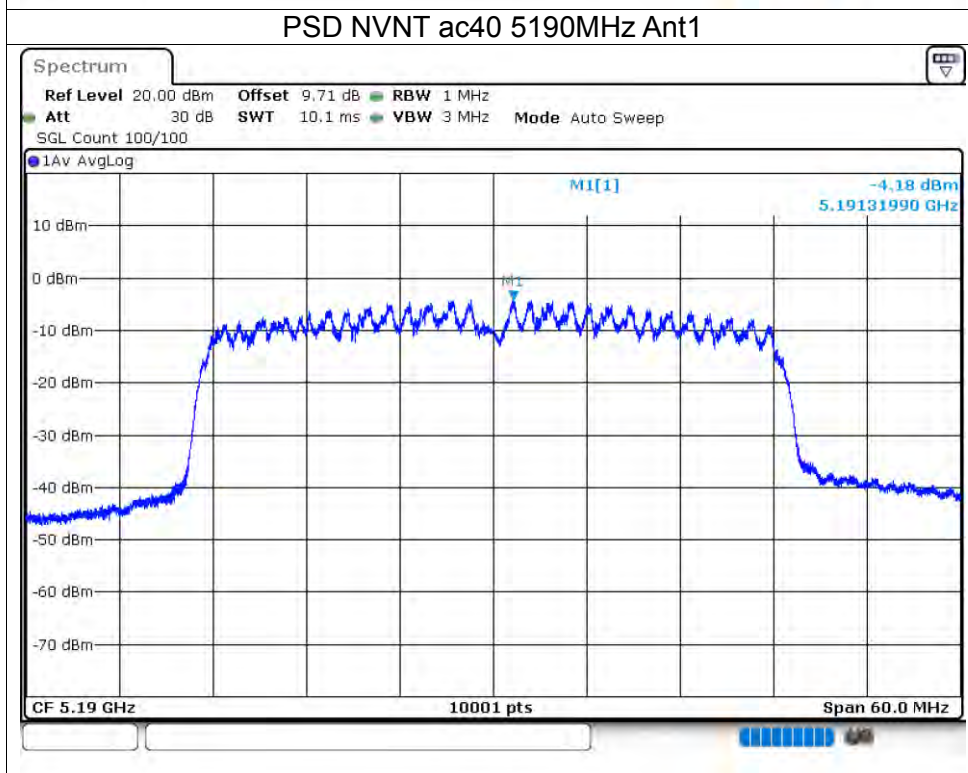
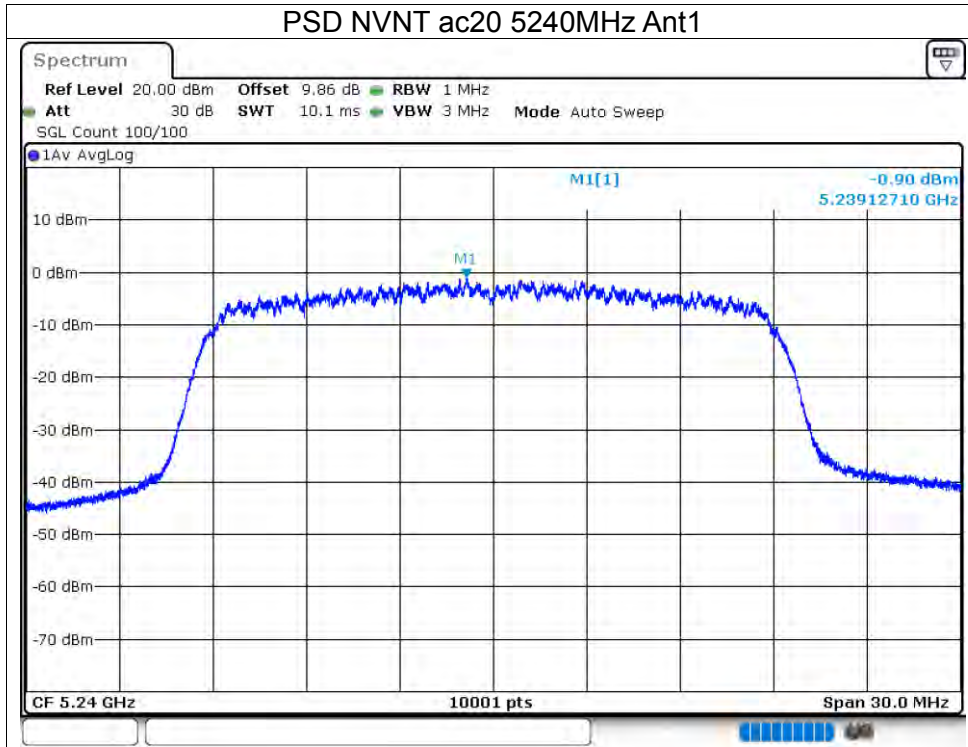

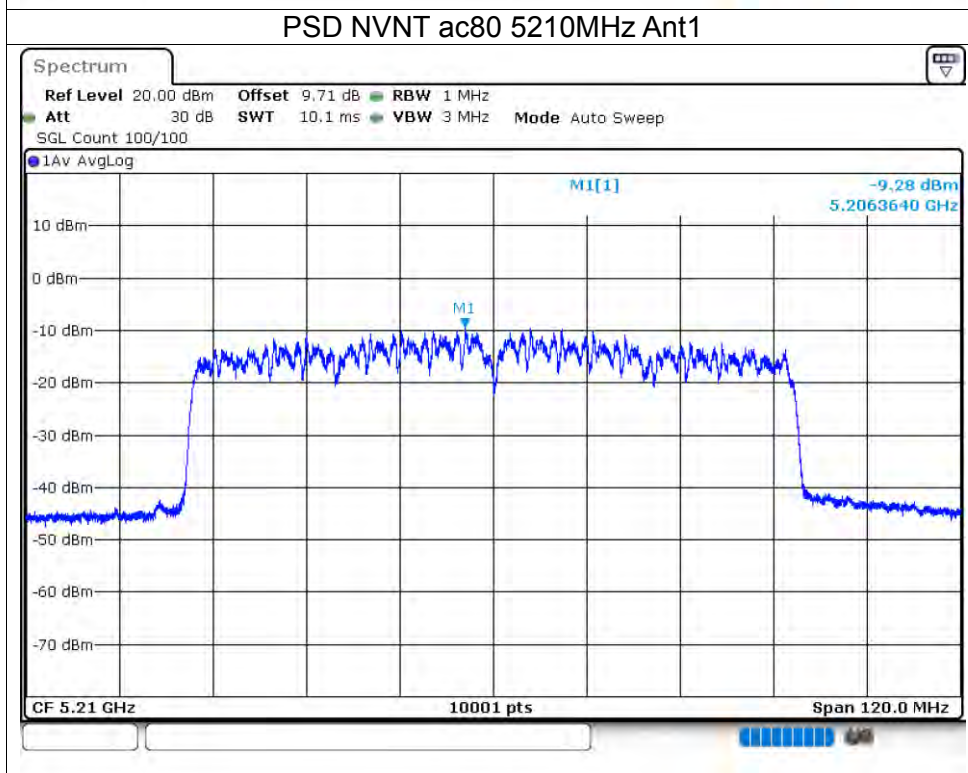
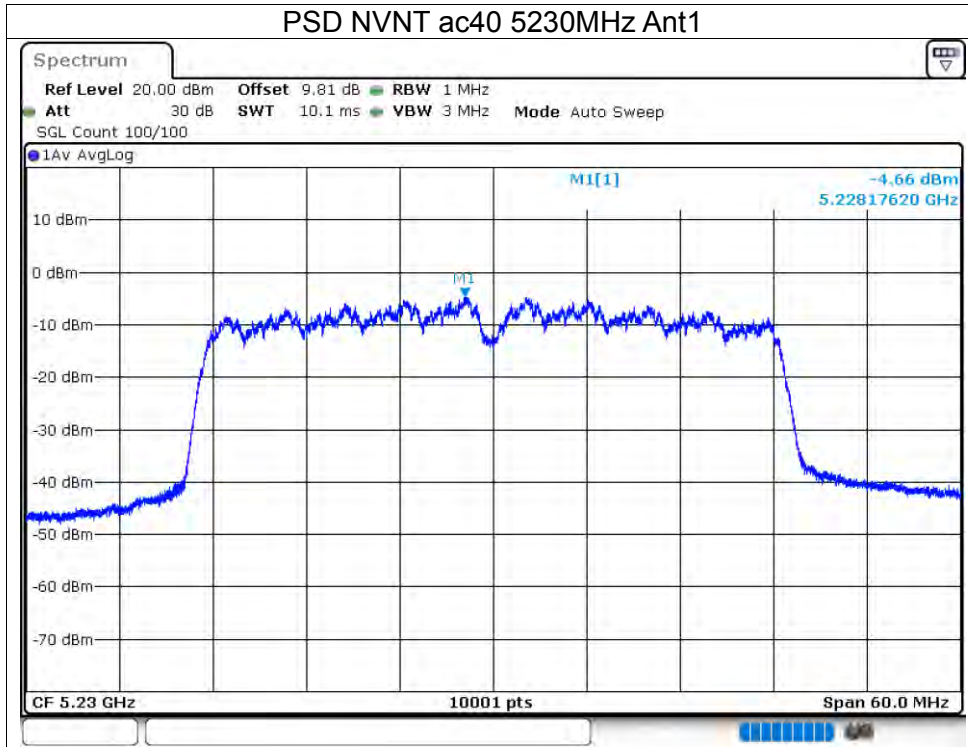

5.6 BAND EDGE

Condition	Mode	Frequency (MHz)	Antenna	Max Value (dBc)	Limit (dBc)	Verdict
NVNT	a	5180	Ant1	-35.65	-27	Pass
NVNT	a	5240	Ant1	-45.84	-27	Pass
NVNT	n20	5180	Ant1	-38.86	-27	Pass
NVNT	n20	5240	Ant1	-45.09	-27	Pass
NVNT	n40	5190	Ant1	-28.66	-27	Pass
NVNT	n40	5230	Ant1	-46.19	-27	Pass
NVNT	ac20	5180	Ant1	-35.92	-27	Pass
NVNT	ac20	5240	Ant1	-44.66	-27	Pass
NVNT	ac40	5190	Ant1	-30.49	-27	Pass
NVNT	ac40	5230	Ant1	-46.14	-27	Pass
NVNT	ac80	5210	Ant1	-44.49	-27	Pass
NVNT	ac80	5210	Ant1	-30.2	-27	Pass

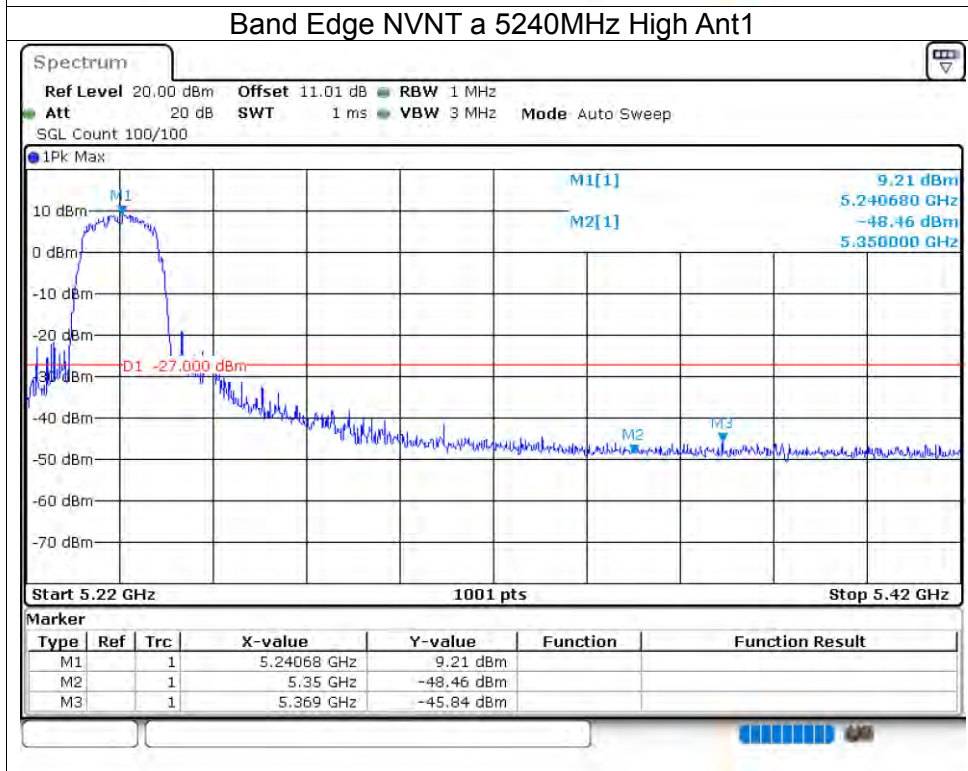
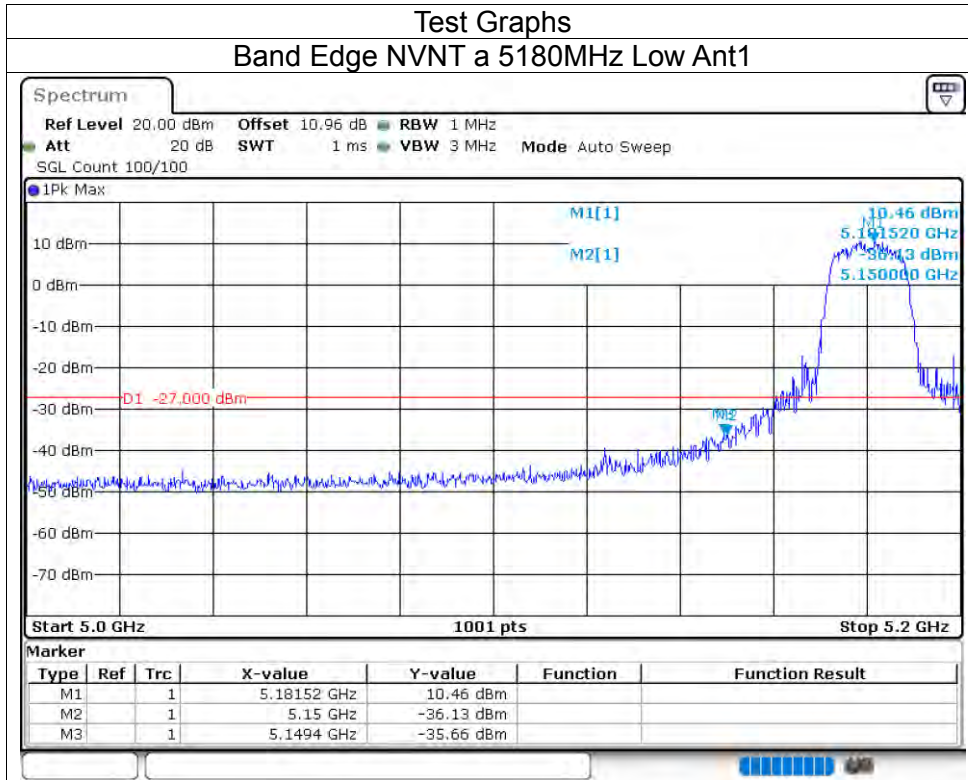

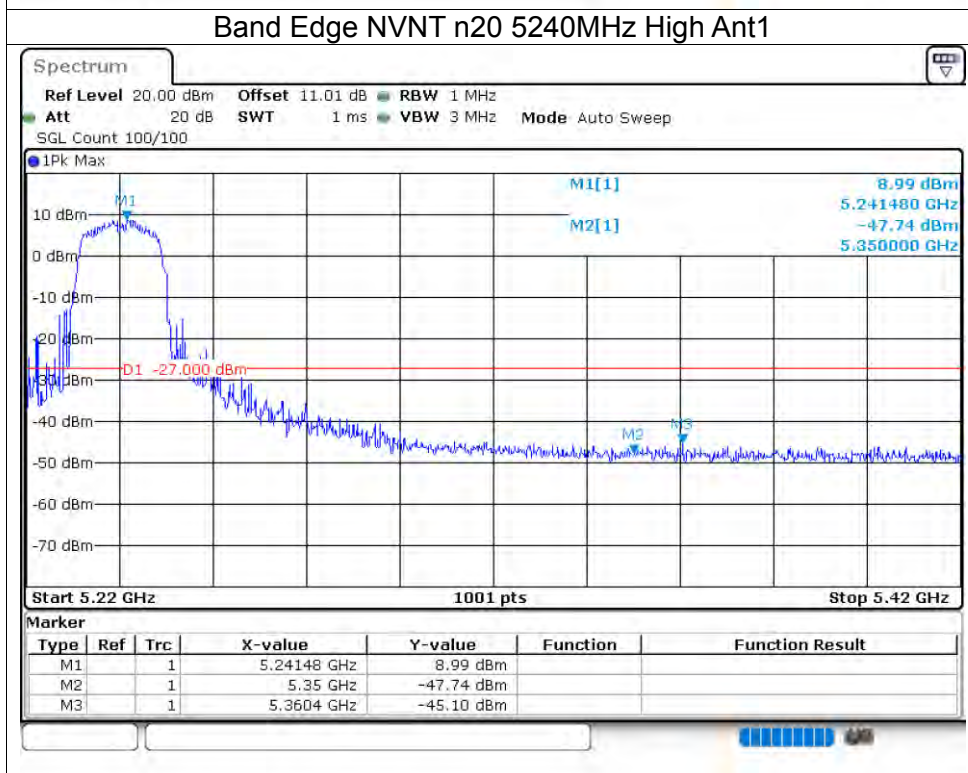
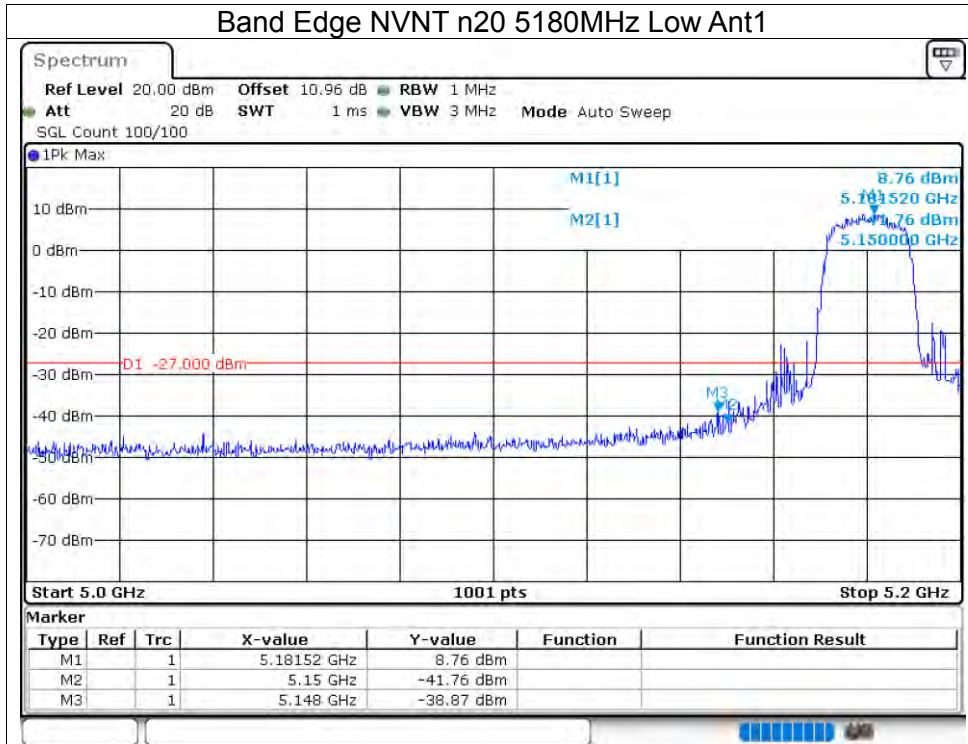

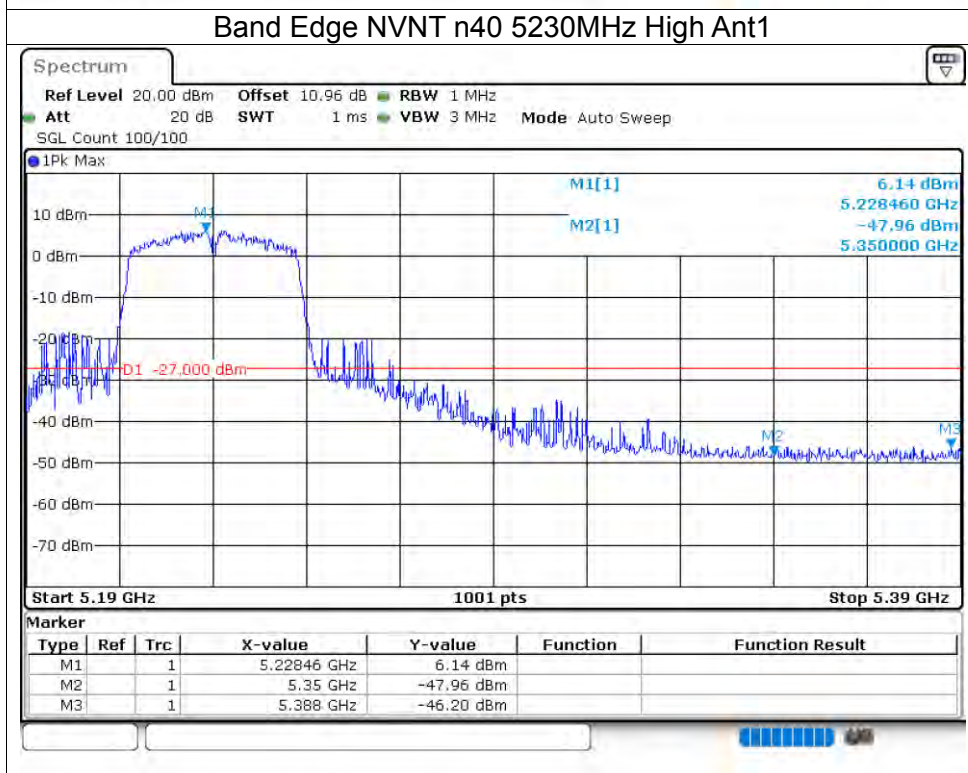
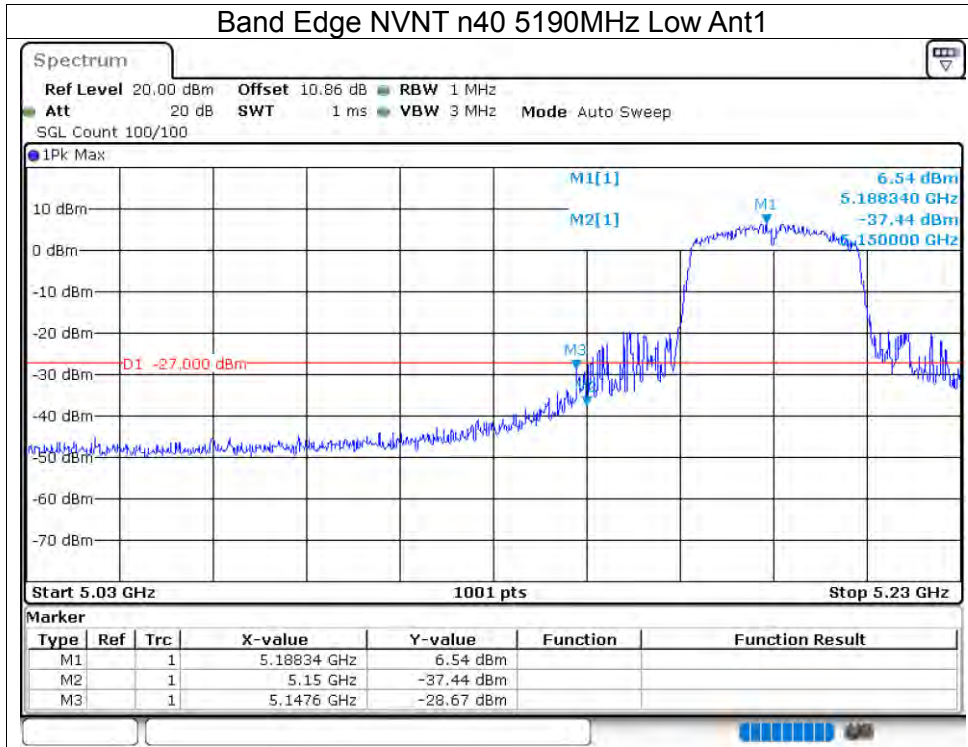

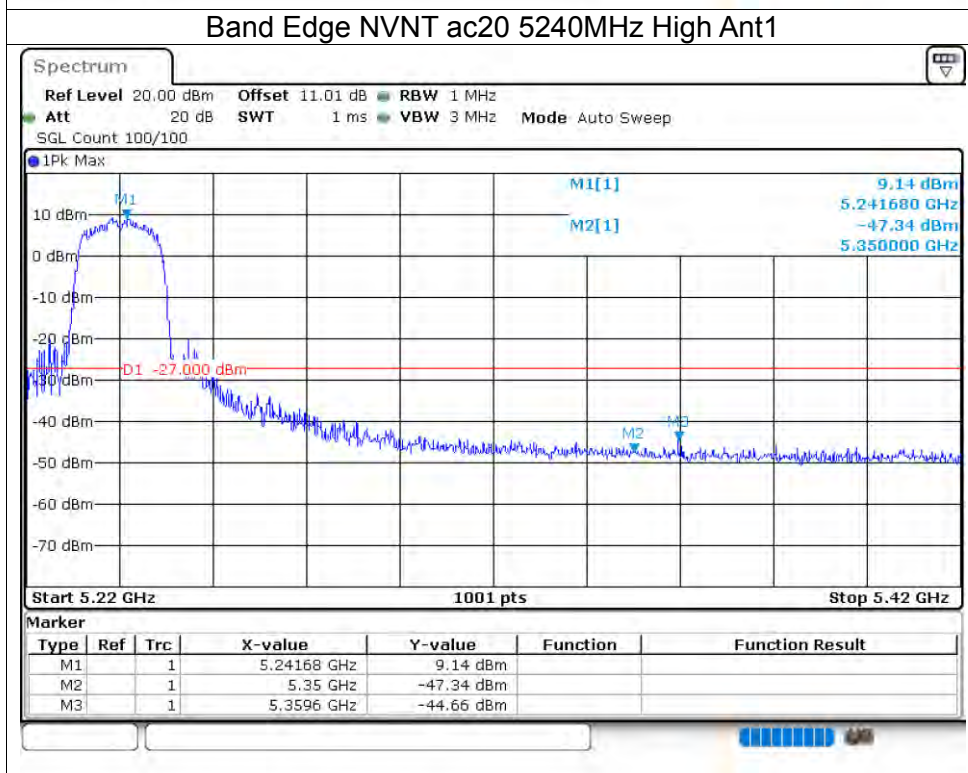
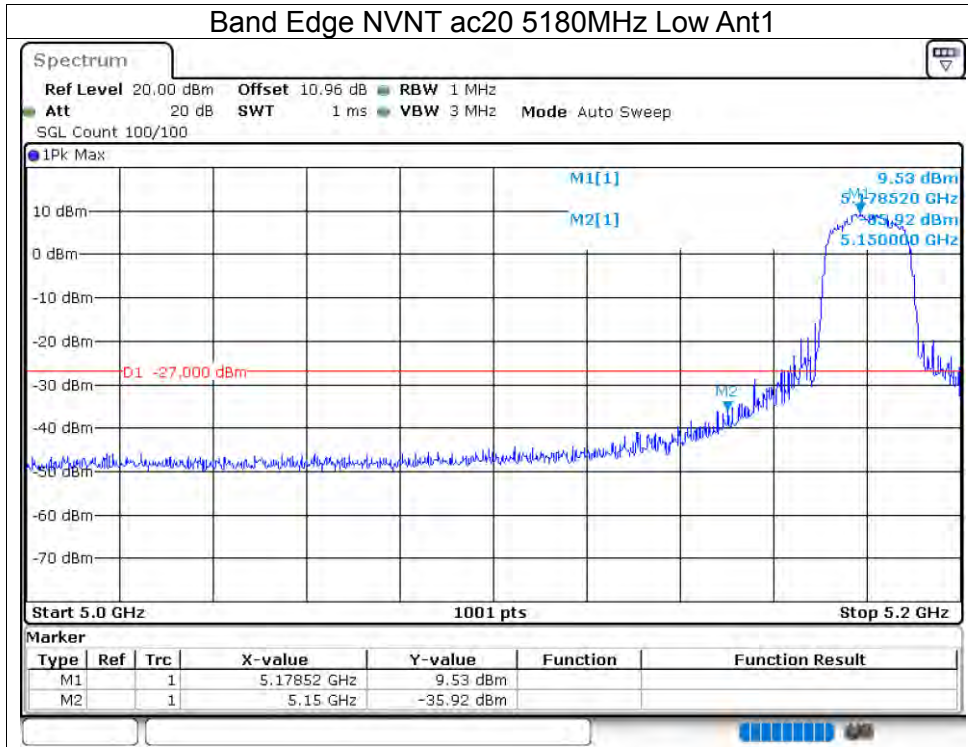

Band Edge NVNT ac40 5190MHz Low Ant1

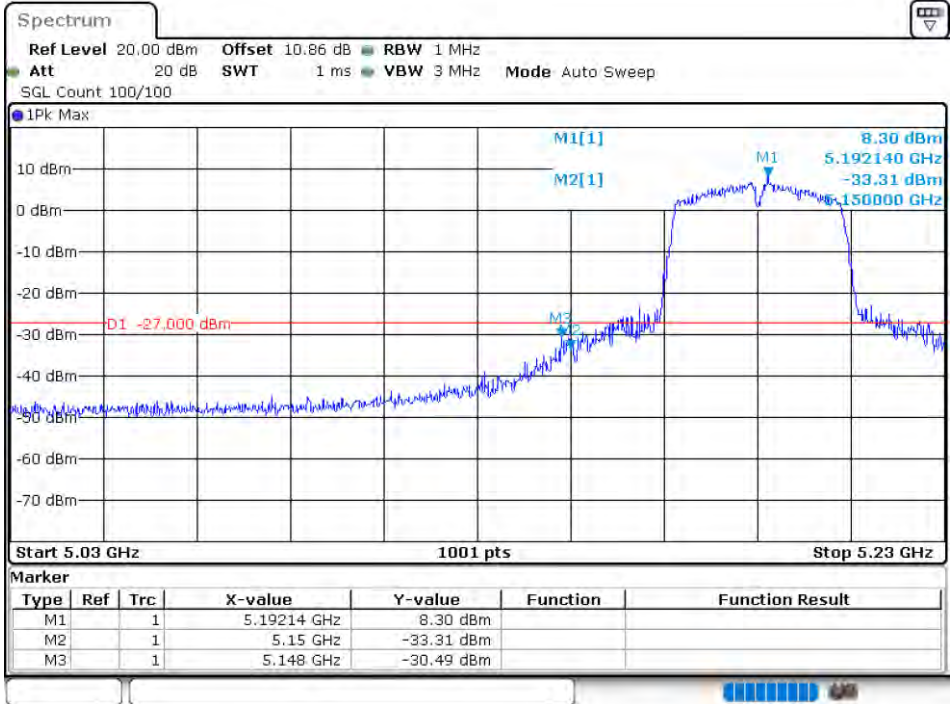

Band Edge NVNT ac40 5230MHz High Ant1

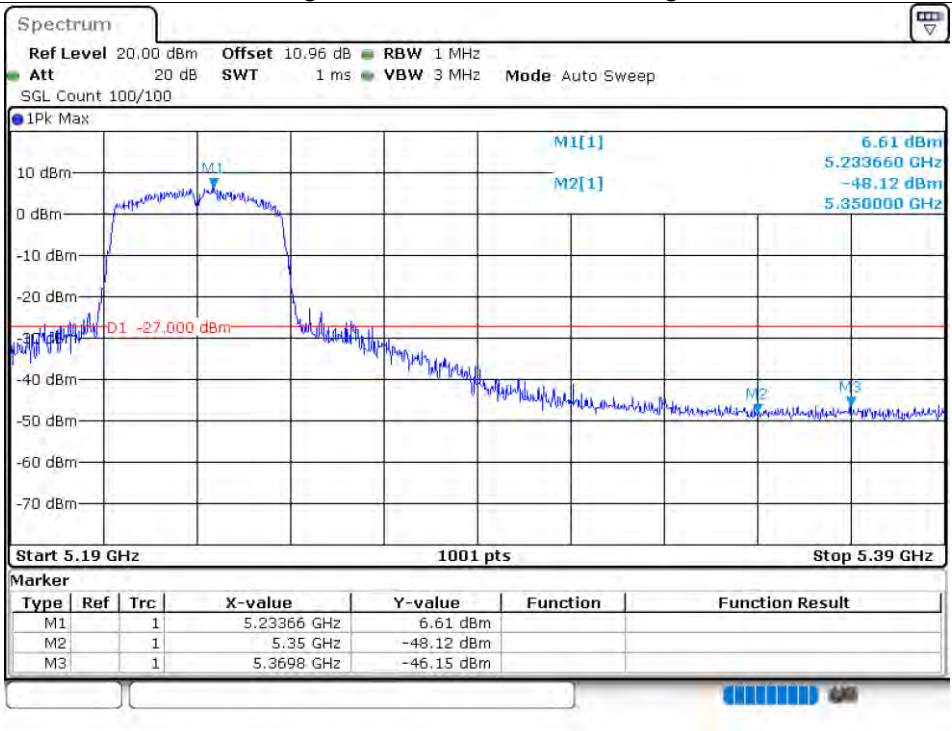

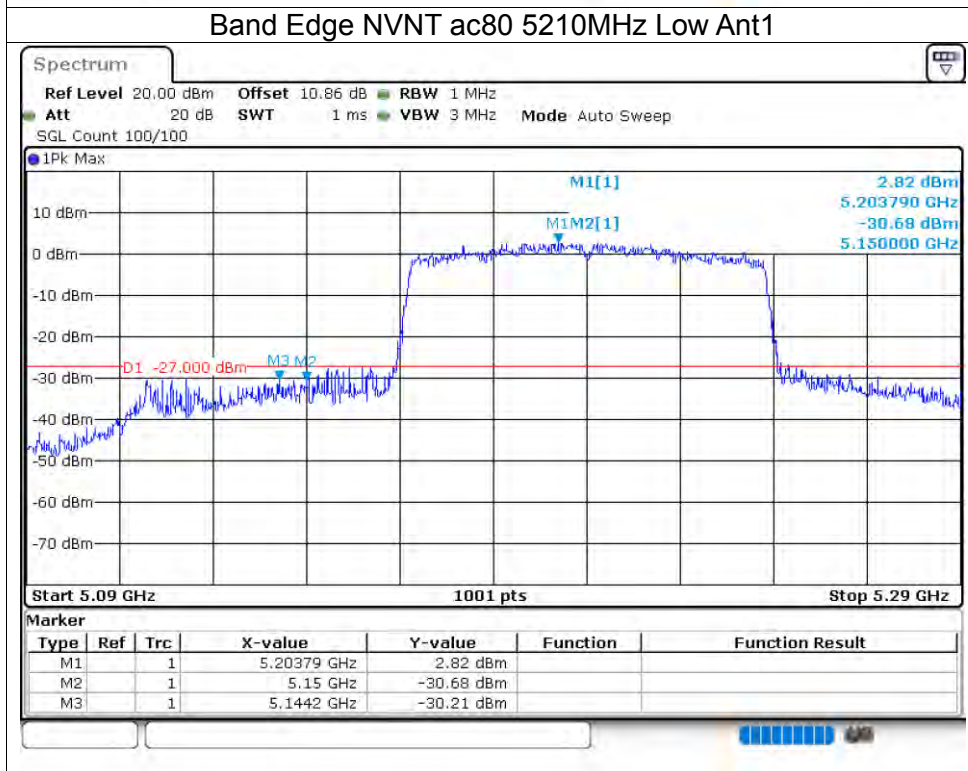
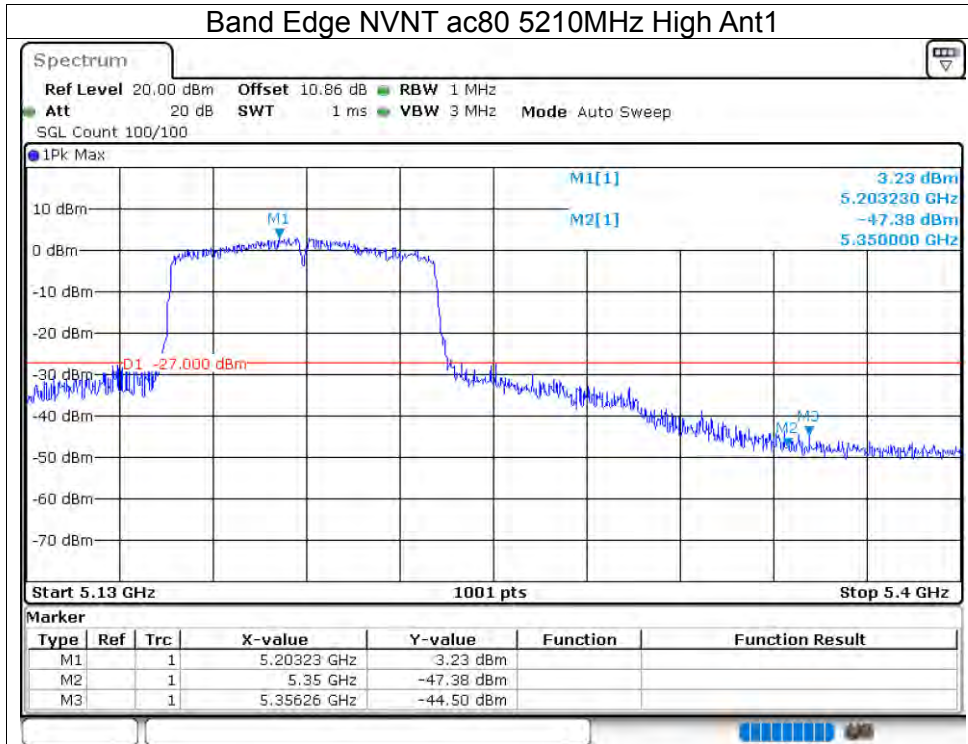

5.7 CONDUCTED RF SPURIOUS EMISSION

Condition	Mode	Frequency (MHz)	Antenna	Max Value (dBc)	Limit (dBc)	Verdict
NVNT	a	5180	Ant1	-36.71	-27	Pass
NVNT	a	5200	Ant1	-36.35	-27	Pass
NVNT	a	5240	Ant1	-36.19	-27	Pass
NVNT	n20	5180	Ant1	-35.88	-27	Pass
NVNT	n20	5200	Ant1	-37.58	-27	Pass
NVNT	n20	5240	Ant1	-36.88	-27	Pass
NVNT	n40	5190	Ant1	-36.62	-27	Pass
NVNT	n40	5230	Ant1	-36.79	-27	Pass
NVNT	ac20	5180	Ant1	-36.82	-27	Pass
NVNT	ac20	5200	Ant1	-29.64	-27	Pass
NVNT	ac20	5240	Ant1	-36.21	-27	Pass
NVNT	ac40	5190	Ant1	-37.49	-27	Pass
NVNT	ac40	5230	Ant1	-37.28	-27	Pass
NVNT	ac80	5210	Ant1	-36.5	-27	Pass

Test Graphs

Tx. Spurious NVNT a 5180MHz Ant1 Emission

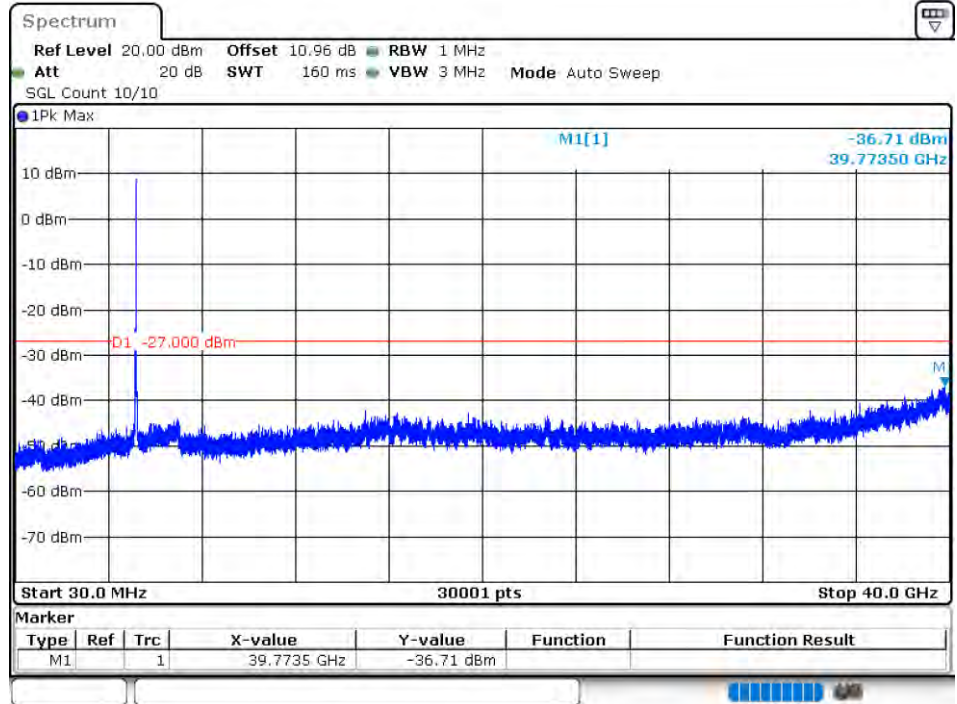

Tx. Spurious NVNT a 5200MHz Ant1 Emission

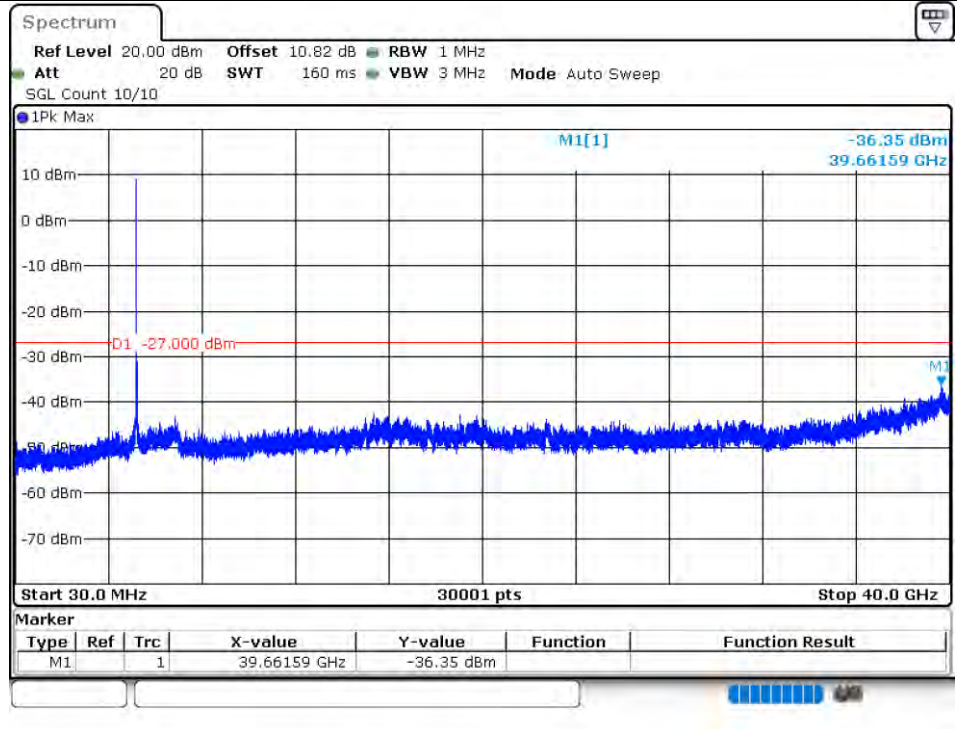

Tx. Spurious NVNT a 5240MHz Ant1 Emission

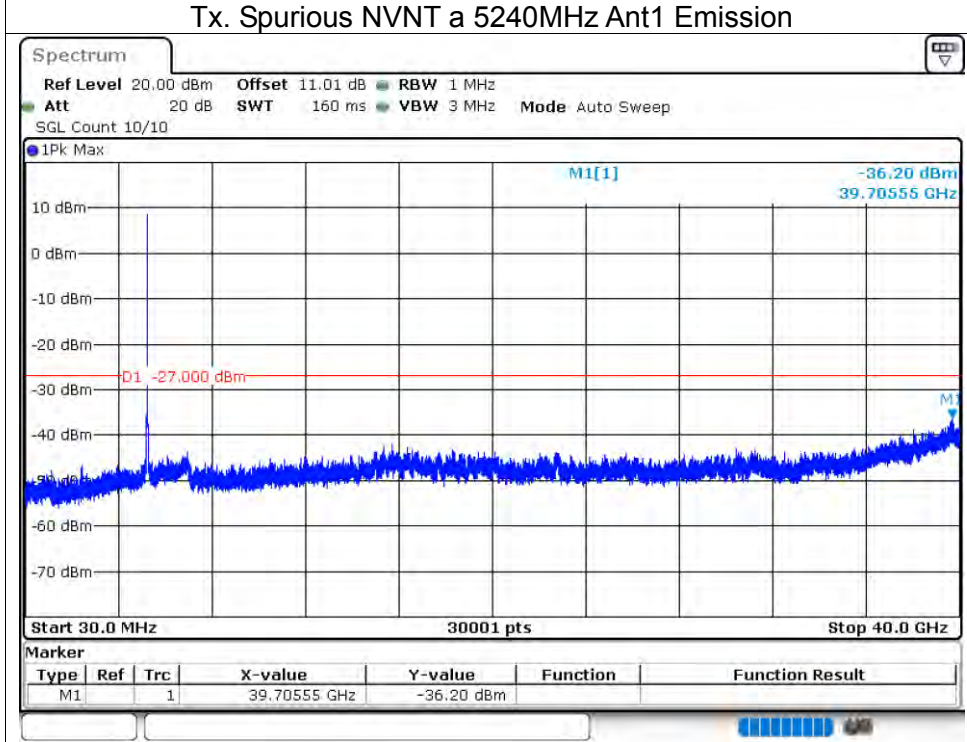

Tx. Spurious NVNT n20 5180MHz Ant1 Emission

