



RF TEST REPORT

Product Name: 2G feature phone

Model Name: U10

Family Model: B10

FCC ID: O55185023

Issued For : SWAGTEK

10205 NW 19th Street STE101 Miami, FL33172

Issued By : Shenzhen LGT Test Service Co., Ltd.

Room 205, Building 13, Zone B, Zhenxiong Industrial Park,
No.177, Renmin West Road, Jinsha, Kengzi Street, Pingshan
District, Shenzhen, Guangdong, China

Report Number: LGT23L045RF01

Sample Received Date: Dec. 14, 2023

Date of Test: Dec. 14, 2023 – Dec. 27, 2023

Date of Issue: Dec. 27, 2023

The test report is effective only with both signature and specialized stamp. This report shall not be reproduced except in full without the written approval of the Laboratory. The results in this report only apply to the tested sample.



TEST REPORT CERTIFICATION

Applicant: SWAGTEK
Address: 10205 NW 19th Street STE101 Miami, FL33172
Manufacturer: SWAGTEK
Address: 10205 NW 19th Street STE101 Miami, FL33172
Product Name: 2G feature phone
Trademark: UNONU, LOGIC, iSWAG
Model Name: U10
Family Model: B10
Sample Status: Normal

APPLICABLE STANDARDS	
STANDARD	TEST RESULTS
FCC Part 15.247, Subpart C ANSI C63.10-2013	PASS

Prepared by:

Zane Shan

Zane Shan
Engineer

Approved by:

Vita Li

Vita Li
Technical Director





Table of Contents	Page
1. SUMMARY OF TEST RESULTS	6
1.1 TEST FACTORY	7
1.2 MEASUREMENT UNCERTAINTY	7
2. GENERAL INFORMATION	8
2.1 GENERAL DESCRIPTION OF THE EUT	8
2.2 DESCRIPTION OF THE TEST MODES	10
2.3 FREQUENCY HOPPING SYSTEM REQUIREMENTS	10
2.4 TABLE OF PARAMETERS OF TEST SOFTWARE SETTING	12
2.5 DESCRIPTION OF NECESSARY ACCESSORIES AND SUPPORT UNITS	12
2.6 EQUIPMENTS LIST	13
3. EMC EMISSION TEST	14
3.1 CONDUCTED EMISSION MEASUREMENT	14
3.2 RADIATED EMISSION MEASUREMENT	18
4. CONDUCTED SPURIOUS & BAND EDGE EMISSION	30
4.1 LIMIT	30
4.2 TEST PROCEDURE	30
4.3 TEST SETUP	31
4.4 EUT OPERATION CONDITIONS	31
4.5 TEST RESULTS	31
5. NUMBER OF HOPPING CHANNEL	32
5.1 LIMIT	32
5.2 TEST PROCEDURE	32
5.3 TEST SETUP	32
5.4 EUT OPERATION CONDITIONS	32
5.5 TEST RESULTS	32
6. AVERAGE TIME OF OCCUPANCY	33
6.1 LIMIT	33
6.2 TEST PROCEDURE	33
6.3 TEST SETUP	33
6.4 EUT OPERATION CONDITIONS	33
6.5 TEST RESULTS	33
7. HOPPING CHANNEL SEPARATION MEASUREMENT	34
7.1 LIMIT	34
7.2 TEST PROCEDURE	34



Table of Contents	Page
7.3 TEST SETUP	34
7.4 EUT OPERATION CONDITIONS	34
7.5 TEST RESULTS	34
8. BANDWIDTH TEST	35
8.1 LIMIT	35
8.2 TEST PROCEDURE	35
8.3 TEST SETUP	35
8.4 EUT OPERATION CONDITIONS	35
8.5 TEST RESULTS	35
9. OUTPUT POWER TEST	36
9.1 LIMIT	36
9.2 TEST PROCEDURE	36
9.3 TEST SETUP	36
9.4 EUT OPERATION CONDITIONS	36
9.5 TEST RESULTS	36
10. ANTENNA REQUIREMENT	37
10.1 STANDARD REQUIREMENT	37
10.2 EUT ANTENNA	37
APPENDIX I - TEST RESULTS	38
DUTY CYCLE	38
MAXIMUM PEAK CONDUCTED OUTPUT POWER	42
-20DB BANDWIDTH	43
OCCUPIED CHANNEL BANDWIDTH	47
CARRIER FREQUENCIES SEPARATION	51
BAND EDGE	55
BAND EDGE(HOPPING)	60
CONDUCTED RF SPURIOUS EMISSION	65
NUMBER OF HOPPING CHANNEL	72
DWELL TIME	74



Revision History

Rev.	Issue Date	Contents
00	Dec. 27, 2023	Initial Issue



1. SUMMARY OF TEST RESULTS

Test procedures according to the technical standards:
KDB 558074 D01 15.247 Meas Guidance v05r02.

FCC Part 15.247, Subpart C			
Standard Section	Test Item	Judgment	Remark
15.207	Conducted Emission	PASS	--
15.247(a)(1)	Hopping Channel Separation	PASS	--
15.247(a)(1)&(b)(1)	Output Power	PASS	--
15.209	Radiated Spurious Emission	PASS	--
15.247(d)	Conducted Spurious & Band Edge Emission	PASS	--
15.247(a)(1)(iii)	Number of Hopping Frequency	PASS	--
15.247(a)(1)(iii)	Dwell Time	PASS	--
15.247(a)(1)	Bandwidth	PASS	--
15.205	Restricted bands of operation	PASS	--
Part 15.247(d)/part 15.209(a)	Band Edge Emission	PASS	--
15.203	Antenna Requirement	PASS	--

NOTE:

- (1) 'N/A' denotes test is not applicable in this Test Report.
- (2) All tests are according to ANSI C63.10-2013.



1.1 TEST FACTORY

Company Name:	Shenzhen LGT Test Service Co., Ltd.
Address:	Room 205, Building 13, Zone B, Zhenxiang Industrial Park, No.177, Renmin West Road, Jinsha, Kengzi Street, Pingshan District, Shenzhen, Guangdong, China
Accreditation Certificate	A2LA Certificate No.: 6727.01
	FCC Registration No.: 746540
	CAB ID: CN0136

1.2 MEASUREMENT UNCERTAINTY

The reported uncertainty of measurement $y \pm U$, where expanded uncertainty U is based on a standard uncertainty multiplied by a coverage factor of $k=2$, providing a level of confidence of approximately **95** %.

No.	Item	Uncertainty
1	RF output power, conducted	± 0.68 dB
2	Unwanted Emissions, conducted	± 2.988 dB
3	All emissions, radiated 9K-30MHz	± 2.84 dB
4	All emissions, radiated 30M-1GHz	± 4.39 dB
5	All emissions, radiated 1G-6GHz	± 5.10 dB
6	All emissions, radiated >6G	± 5.48 dB
7	Conducted Emission (9KHz-150KHz)	± 2.79 dB
8	Conducted Emission (150KHz-30MHz)	± 2.80 dB

Note: The measurement uncertainty is not included in the test result.



2. GENERAL INFORMATION

2.1 GENERAL DESCRIPTION OF THE EUT

Product Name:	2G feature phone
Trademark:	UNONU, LOGIC, iSWAG
Model Name:	U10
Family Model:	B10
Model Difference:	Only different in model name and Trademark
Channel List:	Please refer to the Note 3.
Bluetooth:	Frequency:2402 – 2480 MHz Modulation: GFSK(1Mbps), $\pi/4$ -DQPSK(2Mbps), 8DPSK(3Mbps)
Antenna Type:	Monopole
Antenna Gain:	0.31dBi
Adapter:	Input: 100-240V, 50-60Hz, 0.2A Output: 5.0V, 500mA
Battery:	Capacity: 1800mAh Rated Voltage: 3.7V
Hardware Version:	FD18_MB_V2.0
Software Version:	U_U10_OM_V1.0_20122023
Connecting I/O Port(s):	Please refer to the Note 1.

Note:

1. For a more detailed features description, please refer to the manufacturer's specifications or the User Manual.
2. The antenna information refers to the manufacturer provide report, applicable only to the tested sample identified in the report. Due to the incorrect antenna information, a series of problems such as the accuracy of the test results will be borne by the customer.



3.

Channel List					
Channel	Frequency (MHz)	Channel	Frequency (MHz)	Channel	Frequency (MHz)
00	2402	27	2429	54	2456
01	2403	28	2430	55	2457
02	2404	29	2431	56	2458
03	2405	30	2432	57	2459
04	2406	31	2433	58	2460
05	2407	32	2434	59	2461
06	2408	33	2435	60	2462
07	2409	34	2436	61	2463
08	2410	35	2437	62	2464
09	2411	36	2438	63	2465
10	2412	37	2439	64	2466
11	2413	38	2440	65	2467
12	2414	39	2441	66	2468
13	2415	40	2442	67	2469
14	2416	41	2443	68	2470
15	2417	42	2444	69	2471
16	2418	43	2445	70	2472
17	2419	44	2446	71	2473
18	2420	45	2447	72	2474
19	2421	46	2448	73	2475
20	2422	47	2449	74	2476
21	2423	48	2450	75	2477
22	2424	49	2451	76	2478
23	2425	50	2452	77	2479
24	2426	51	2453	78	2480
25	2427	52	2454		
26	2428	53	2455		



2.2 DESCRIPTION OF THE TEST MODES

To investigate the maximum EMI emission characteristics generated from EUT, the test system was pre-scanning tested based on the consideration of following EUT operation mode or test configuration mode which possibly have effect on EMI emission level. Each of these EUT operation mode(s) or test configuration mode(s) mentioned above was evaluated respectively.

Worst Mode	Description	Data Rate/Modulation
Mode 1	TX CH00	1Mbps/GFSK
Mode 2	TX CH39	1Mbps/GFSK
Mode 3	TX CH78	1Mbps/GFSK
Mode 4	TX CH00	2 Mbps/ $\pi/4$ -DQPSK
Mode 5	TX CH39	2 Mbps/ $\pi/4$ -DQPSK
Mode 6	TX CH78	2 Mbps/ $\pi/4$ -DQPSK
Mode 7	TX CH00	3 Mbps/8DPSK
Mode 8	TX CH39	3 Mbps/8DPSK
Mode 9	TX CH78	3 Mbps/8DPSK
Mode 10	Hopping	GFSK
Mode 11	Hopping	$\pi/4$ -DQPSK
Mode 12	Hopping	8DPSK

Note:

- (1) The measurements are performed at all Bit Rate of Transmitter, the worst data was reported.
- (2) We tested for all available U.S. voltage and frequencies (For 120V, 50/60Hz and 240V, 50/60Hz) for which the device is capable of operation, and the worst case of 120V/ 60Hz is shown in the report.
- (3) The battery is fully charged during the radiated and RF conducted test.

For AC Conducted Emission

Test Case	
AC Conducted Emission	Mode 13: Keeping BT TX

2.3 FREQUENCY HOPPING SYSTEM REQUIREMENTS

(1) Standard and Limit

According to FCC Part 15.247(a)(1), The system shall hop to channel frequencies that are selected at the system hopping rate from a pseudo randomly ordered list of hopping frequencies. Each frequency must be used equally on the average by each transmitter. The system receivers shall have input bandwidths that match the hopping channel bandwidths of their corresponding transmitters and shall shift frequencies in synchronization with the transmitted signals.

Frequency hopping spread spectrum systems are not required to employ all available hopping channels during each transmission. However, the system, consisting of both the transmitter and the receiver, must be designed to comply with all of the regulations in this section should the transmitter be presented with a continuous data (or information) stream. In addition, a system employing short transmission bursts must comply with the definition of a frequency hopping system and must distribute its transmissions over the minimum number of hopping channels specified in this section.

The incorporation of intelligence within a frequency hopping spread spectrum system that permits the system to recognize other users within the spectrum band so that it individually and independently chooses and adapts its hop sets to avoid hopping on occupied channels is permitted. The coordination of frequency hopping systems in any other manner for the express purpose of avoiding the simultaneous occupancy of individual hopping frequencies by multiple transmitters is not permitted.

(2) The Pseudorandom sequence may be generated in a nine-stage shift register whose 5th and 9th



stage outputs are added in a modulo-two addition stage. And the result is fed back to the input of the first stage. The sequence begins with the first one of 9 consecutive ones: i.e. the shift register is initialized with nine ones.

Number of shift register stages:9

Length of pseudo-random sequence: $2^9-1=511$ bits

Longest sequence of zeros: 8(non-inverted signal)

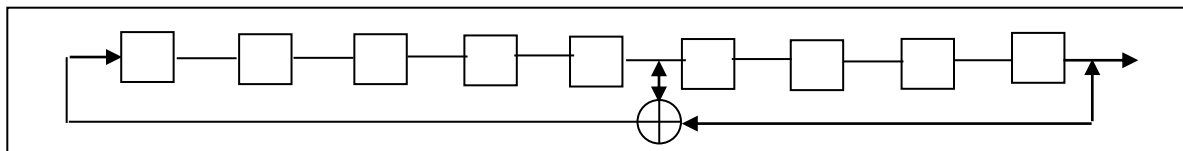

Linear Feedback Shift Register for Generator of the PRBS sequence

An example of Pseudorandom Frequency Hopping Sequence as follow:

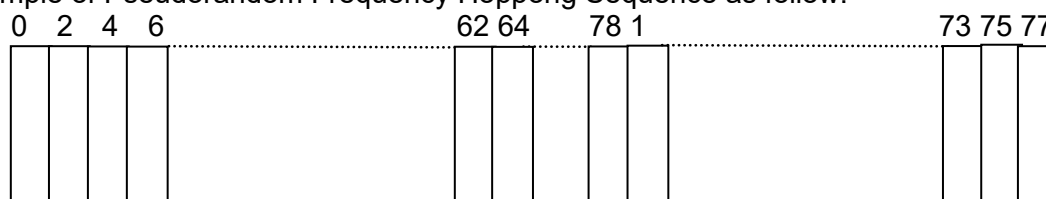

Each frequency used equally on the average by each transmitter.

The system receivers have input bandwidths that match the hopping channel bandwidths of their corresponding transmitters and shift frequencies in synchronization with the transmitted signals.

(3) Frequency Hopping System

This transmitter device is frequency hopping device and complies with FCC part 15.247 rule.

This device uses Bluetooth radio which operates in 2400-2483.5 MHz band. Bluetooth uses a radio technology called frequency-hopping spread spectrum, which chops up the data being sent and transmits chunks of it on up to 79 bands (1 MHz each; centred from 2402 to 2480 MHz) in the range 2,400-2,483.5MHz. The transmitter switches hop frequencies 1,600 times per second to assure a high degree of data security. All Bluetooth devices participating in a given piconet are synchronized to the frequency-hopping channel for the piconet. The frequency hopping sequence is determined by the master's device address and the phase of the hopping sequence (the frequency to hop at a specific time) is determined by the master's internal clock. Therefore, all slaves in a piconet must know the master's device address and must synchronize their clocks with the master's clock.

Adaptive Frequency Hopping (AFH) was introduced in the Bluetooth specification to provide an effective way for a Bluetooth radio to counteract normal interference. AFH identifies "bad" channels, where either other wireless device are interfering with the Bluetooth signal or the Bluetooth signal is interfering with another device. The AFH-enabled Bluetooth device will then communicate with other devices within its piconet to share details of any identified bad channels. The devices will then switch to alternative available "good" channels, away from the areas of interference, thus having no impact on the bandwidth used.

This device was tested with a bluetooth system receiver to check that the device maintained hopping synchronization, and the device complied with these requirements FCC Part 15.247 rule.



2.4 TABLE OF PARAMETERS OF TEST SOFTWARE SETTING

During testing channel & power controlling software provided by the customer was used to control the operating channel as well as the output power level. The RF output power selection is for the setting of RF output power expected by the customer and is going to be fixed on the firmware of the final end product power parameters of FHSS.

Test software Version	Test program: Bluetooth	
Engineering mode	1M	Default
	2M	Default
	3M	Default

2.5 DESCRIPTION OF NECESSARY ACCESSORIES AND SUPPORT UNITS

The EUT has been tested as an independent unit together with other necessary accessories or support units. The following support units or accessories were used to form a representative test configuration during the tests.

Accessories Equipment

Description	Manufacturer	Model	S/N	Rating
Adapter	UNONU	YLT-Y02A-2	N/A	Input: 100-240V ~ 50/60Hz 0.2A Output: 5V, 0.5A

Auxiliary Equipment

Description	Manufacturer	Model	S/N	Rating

Note:

- (1) For detachable type I/O cable should be specified the length in cm in 『Length』 column.
- (2) “YES” is means “with core”; “NO” is means “without core”.



2.6 EQUIPMENTS LIST

Conducted Emission					
Equipment	Manufacturer	Model No.	Serial No.	Cal. Date	Cal. Until
EMI Test Receiver	R&S	ESU8	100372	2023.04.13	2024.04.12
LISN	COM-POWER	LI-115	02032	2023.04.07	2024.04.06
LISN	SCHWARZBECK	NNLK 8122	00160	2023.04.07	2024.04.06
Transient Limiter	CYBERTEK	EM5010A	E2250100049	2023.04.07	2024.04.06
Temperature & Humidity	KTJ	TA218B	N.A	2023.04.24	2024.04.23
Testing Software	EMC-I_V1.4.0.3_SKET				

Radiation Test equipment					
Equipment	Manufacturer	Model No.	Serial No.	Cal. Date	Cal. Until
EMI Test Receiver	R&S	ESU	100372	2023.04.13	2024.04.12
Spectrum Analyzer	Keysight	N9010B	MY60242508	2023.04.10	2024.04.09
Active loop Antenna	ETS	6502	00049544	2023.04.10	2024.04.09
Bilog Antenna	SCHWARZBECK	VULB 9168	01447	2022.06.05	2025.06.04
Horn Antenna	SCHWARZBECK	3115	10SL0060	2022.06.02	2025.06.01
Pre-amplifier (9kHz-1GHz)	EMtrace	RP01A	02017	2023.04.07	2024.04.06
Pre-amplifier(1-26.5G)	Agilent	8449B	3008A4722	2023.04.07	2024.04.06
RE Cable (9K-1G)	N.A	R01	N.A	2023.04.07	2024.04.06
RE Cable (1-26G)	N.A	R02	N.A	2023.04.07	2024.04.06
Temperature & Humidity	KTJ	TA218B	N.A	2023.04.24	2024.04.23
Testing Software	EMC-I_V1.4.0.3_SKET				

RF Connected Test equipment					
Equipment	Manufacturer	Model No.	Serial No.	Cal. Date	Cal. Until
Signal Generator	Keysight	N5182B	MY59100717	2023.04.10	2024.04.09
Signal Analyzer	Keysight	N9010B	MY60242508	2023.04.13	2024.04.12
Wireless Communications Test Set	R&S	CMW 500	137737	2023.04.13	2024.04.12
Temperature & Humidity	KTJ	TA218B	N/A	2023.04.24	2024.04.23
Temperature & Humidity test chamber	AISRY	LX-1000L	171200018	2023.05.10	2024.05.09
Attenuator	eastsheep	90db	N/A	2023.04.10	2024.04.09
Testing Software	MTS 8310_2.0.0.0_MWRF-TEST				



3. EMC EMISSION TEST

3.1 CONDUCTED EMISSION MEASUREMENT

3.1.1 POWER LINE CONDUCTED EMISSION LIMITS

The radio frequency voltage that is conducted back onto the AC power line on any frequency or frequencies, within the band 150 kHz to 30 MHz, shall not exceed the limits in the following table.

FREQUENCY (MHz)	Conducted Emissionlimit (dBuV)	
	Quasi-peak	Average
0.15 -0.5	66 - 56 *	56 - 46 *
0.50 -5.0	56.00	46.00
5.0 -30.0	60.00	50.00

Note:

- (1) The tighter limit applies at the band edges.
- (2) The limit of “ * ” marked band means the limitation decreases linearly with the logarithm of the frequency in the range.

The following table is the setting of the receiver

Receiver Parameters	Setting
Attenuation	10 dB
Start Frequency	0.15 MHz
Stop Frequency	30 MHz
IF Bandwidth	9 kHz



3.1.2 TEST PROCEDURE

- a. The EUT is 0.8 m from the horizontal ground plane and 0.4 m from the vertical ground plane with EUT being connected to the power mains through a line impedance stabilization network (LISN). All other support equipments are powered from additional LISN(s). The LISN provides 50 Ohm/ 50uH of coupling impedance for the measuring instrument.
- b. Interconnecting cables that hang closer than 40 cm to the ground plane shall be folded back and forth in the center forming a bundle 30 to 40 cm long.
- c. I/O cables that are not connected to a peripheral shall be bundled in the center. The end of the cable may be terminated, if required, using the correct terminating impedance. The overall length shall not exceed 1 m.
- d. LISN is at least 80 cm from the nearest part of EUT chassis.
- e. For the actual test configuration, please refer to the related Item –EUT Test Photos.

3.1.3 TEST SETUP

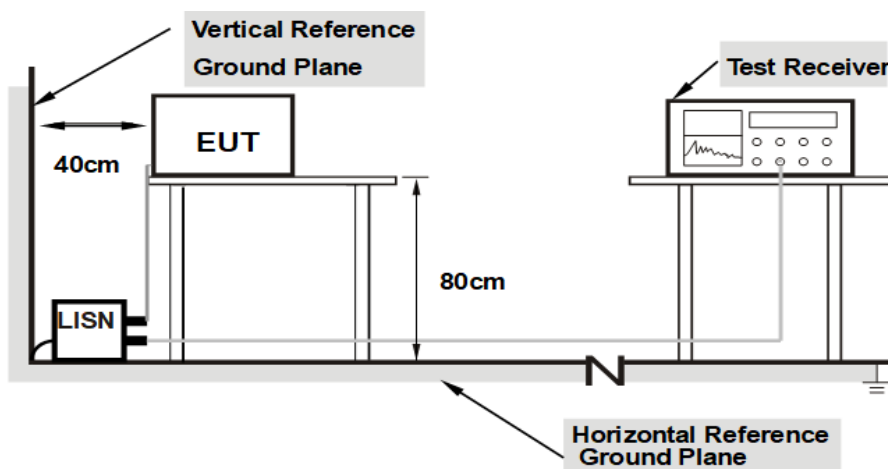

- Note:**
1. Support units were connected to second LISN.
 2. Both of LISNs (AMN) are 80 cm from EUT and at least 80 cm from other units and other metal planes support units.

3.1.4 EUT OPERATING CONDITIONS

The EUT was configured for testing in a typical fashion (as a customer would normally use it). The EUT has been programmed to continuously transmit during test. This operating condition was tested and used to collect the included data.



3.1.5 TEST RESULT

Project: LGT23L045	Test Engineer: LiuH
EUT: 2G feature phone	Temperature: 17.4°C
M/N: U10	Humidity: 42%RH
Test Voltage: AC 120V/60Hz	Test Data: 2023-12-20
Test Mode: TX DH5 2402	
Note:	

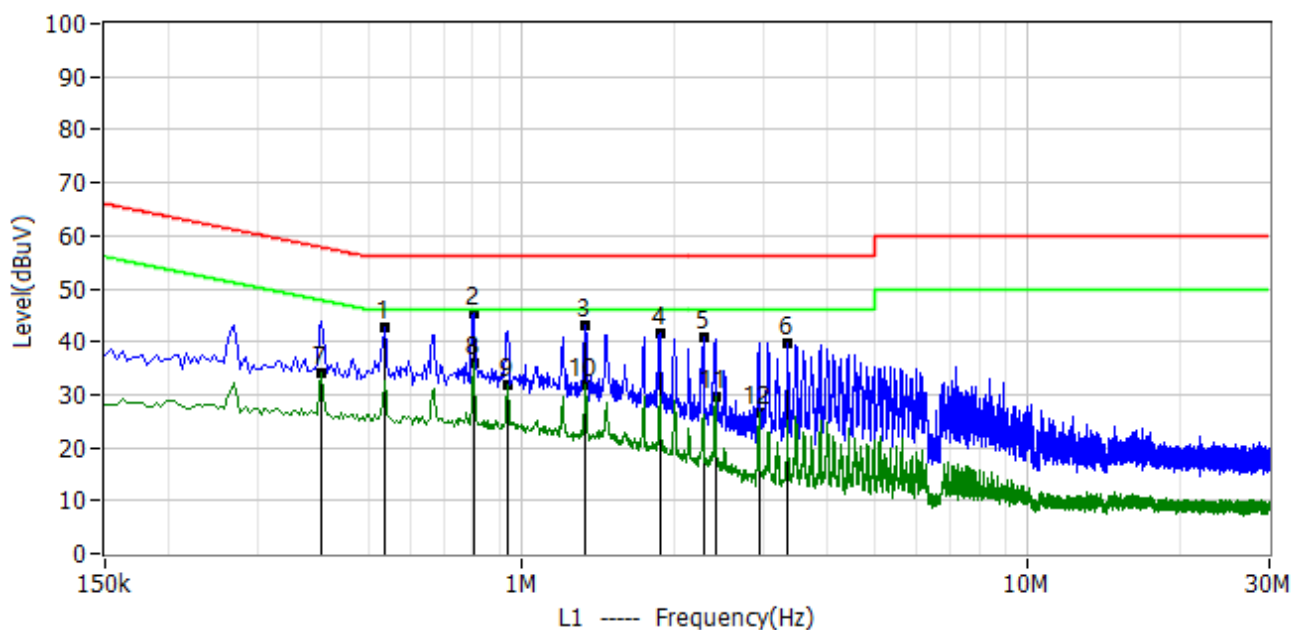

No.	Frequency MHz	Reading dBuV	Factor dB	Level dBuV	Limit dBuV	Margin dB	Detector	Polar
1*	0.534	32.33	10.50	42.83	56.00	-13.17	QP	L1
2*	0.802	34.93	10.51	45.44	56.00	-10.56	QP	L1
3*	1.330	32.58	10.58	43.16	56.00	-12.84	QP	L1
4*	1.874	31.04	10.70	41.74	56.00	-14.26	QP	L1
5*	2.282	30.21	10.73	40.94	56.00	-15.06	QP	L1
6*	3.354	29.05	10.76	39.81	56.00	-16.19	QP	L1
7*	0.402	23.52	10.49	34.01	47.81	-13.80	AV	L1
8*	0.802	25.34	10.51	35.85	46.00	-10.15	AV	L1
9*	0.934	21.24	10.51	31.75	46.00	-14.25	AV	L1
10*	1.334	21.15	10.59	31.74	46.00	-14.26	AV	L1
11*	2.410	18.83	10.73	29.56	46.00	-16.44	AV	L1
12*	2.942	15.72	10.74	26.46	46.00	-19.54	AV	L1



Project: LGT23L045	Test Engineer: LiuH
EUT: 2G feature phone	Temperature: 17.4°C
M/N: U10	Humidity: 42%RH
Test Voltage: AC 120V/60Hz	Test Data: 2023-12-20
Test Mode: TX DH5 2402	
Note:	

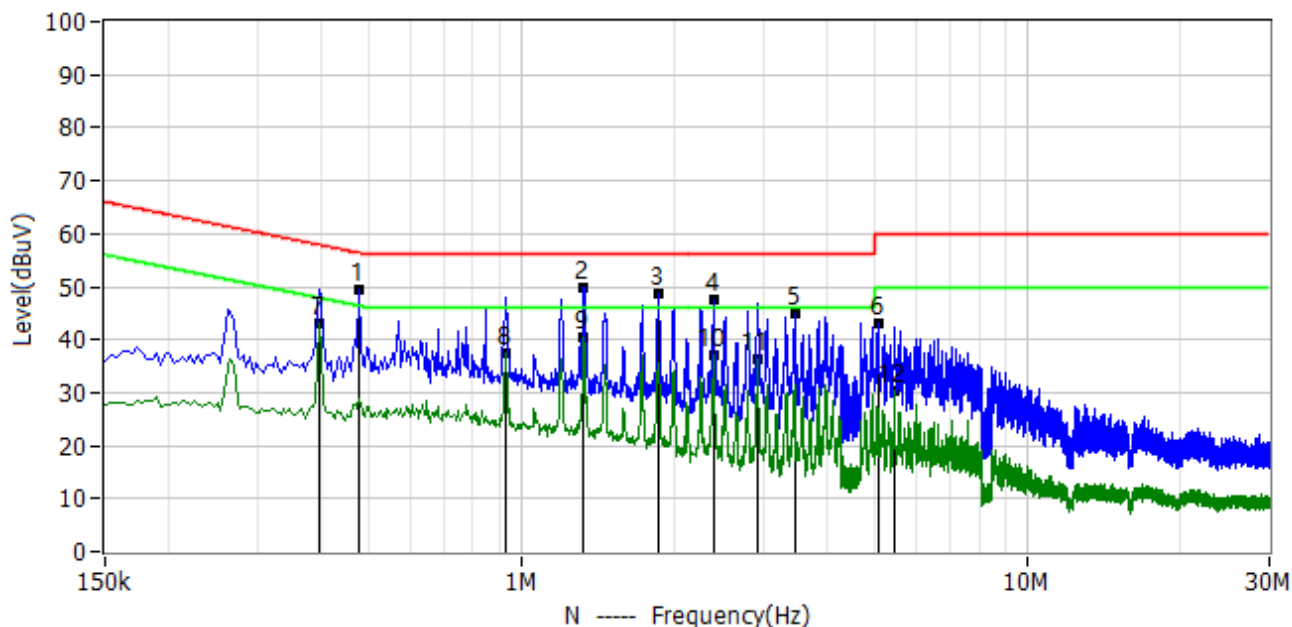

No.	Frequency MHz	Reading dBuV	Factor dB	Level dBuV	Limit dBuV	Margin dB	Detector	Polar
1*	0.478	38.97	10.50	49.47	56.37	-6.91	QP	N
2*	1.326	39.23	10.58	49.81	56.00	-6.19	QP	N
3*	1.862	37.95	10.69	48.64	56.00	-7.36	QP	N
4*	2.390	36.80	10.73	47.53	56.00	-8.47	QP	N
5*	3.454	34.29	10.76	45.05	56.00	-10.95	QP	N
6*	5.058	32.19	10.81	43.00	60.00	-17.00	QP	N
7*	0.398	32.52	10.49	43.01	47.90	-4.88	AV	N
8*	0.930	26.77	10.51	37.28	46.00	-8.72	AV	N
9*	1.326	29.76	10.58	40.34	46.00	-5.66	AV	N
10*	2.394	26.26	10.73	36.99	46.00	-9.01	AV	N
11*	2.926	25.45	10.75	36.20	46.00	-9.80	AV	N
12*	5.462	19.51	10.82	30.33	50.00	-19.67	AV	N



3.2 RADIATED EMISSION MEASUREMENT

3.2.1 RADIATED EMISSION LIMITS

In any 100 kHz bandwidth outside the operating frequency band. In case the emission fall within the Restricted band specified on Part15.205 (a)&209(a) limit in the table and according to ANSI C63.10-2013 below has to be followed.

LIMITS OF RADIATED EMISSION MEASUREMENT (0.009MHz - 1000MHz)

Frequencies (MHz)	Field Strength (micorvolts/meter)	Measurement Distance (meters)
0.009~0.490	2400/F(KHz)	300
0.490~1.705	24000/F(KHz)	30
1.705~30.0	30	30
30~88	100	3
88~216	150	3
216~960	200	3
Above 960	500	3

LIMITS OF RADIATED EMISSION MEASUREMENT (1GHz-25 GHz)

FREQUENCY (MHz)	(dBuV/m) (at 3M)	
	PEAK	AVERAGE
Above 1000	74	54

Notes:

- (1) The limit for radiated test was performed according to FCC PART 15C.
- (2) The tighter limit applies at the band edges.
- (3) Emission level (dBuV/m)=20log Emission level (uV/m).

LIMITS OF RESTRICTED FREQUENCY BANDS

FREQUENCY (MHz)	FREQUENCY (MHz)	FREQUENCY (MHz)	FREQUENCY (GHz)
0.090-0.110	16.42-16.423	399.9-410	4.5-5.15
0.495-0.505	16.69475-16.69525	608-614	5.35-5.46
2.1735-2.1905	16.80425-16.80475	960-1240	7.25-7.75
4.125-4.128	25.5-25.67	1300-1427	8.025-8.5
4.17725-4.17775	37.5-38.25	1435-1626.5	9.0-9.2
4.20725-4.20775	73-74.6	1645.5-1646.5	9.3-9.5
6.215-6.218	74.8-75.2	1660-1710	10.6-12.7
6.26775-6.26825	108-121.94	1718.8-1722.2	13.25-13.4
6.31175-6.31225	123-138	2200-2300	14.47-14.5
8.291-8.294	149.9-150.05	2310-2390	15.35-16.2
8.362-8.366	156.52475-156.52525	2483.5-2500	17.7-21.4
8.37625-8.38675	156.7-156.9	2690-2900	22.01-23.12
8.41425-8.41475	162.0125-167.17	3260-3267	23.6-24.0
12.29-12.293	167.72-173.2	3332-3339	31.2-31.8
12.51975-12.52025	240-285	3345.8-3358	36.43-36.5
12.57675-12.57725	322-335.4	3600-4400	Above 38.6
13.36-13.41			



For Radiated Emission

Spectrum Parameter	Setting
Attenuation	Auto
Detector	Peak/QP/AV
Start Frequency	9 KHz/150KHz (Peak/QP/AV)
Stop Frequency	150KHz/30MHz (Peak/QP/AV)
RB / VB (emission in restricted band)	200Hz (From 9kHz to 0.15MHz)/ 9KHz (From 0.15MHz to 30MHz); 200Hz (From 9kHz to 0.15MHz)/ 9KHz (From 0.15MHz to 30MHz)

Spectrum Parameter	Setting
Attenuation	Auto
Detector	Peak/QP
Start Frequency	30 MHz (Peak/QP)
Stop Frequency	1000 MHz (Peak/QP)
RB / VB (emission in restricted band)	120 KHz / 300 KHz

Spectrum Parameter	Setting
Attenuation	Auto
Detector	Peak
Start Frequency	1000 MHz (Peak/AV)
Stop Frequency	10th carrier hamonic (Peak/AV)
RB / VB (emission in restricted band)	1 MHz / 3 MHz(Peak) 1 MHz/1/T MHz(AVG)

For Restricted band

Spectrum Parameter	Setting
Detector	Peak
Start/Stop Frequency	Lower Band Edge: 2310 to 2410 MHz Upper Band Edge: 2476 to 2500 MHz
RB / VB	1 MHz / 3 MHz(Peak) 1 MHz/1/T MHz(AVG)

Receiver Parameter	Setting
Attenuation	Auto
Start ~ Stop Frequency	9kHz~90kHz / RB 200Hz for PK & AV
Start ~ Stop Frequency	90kHz~110kHz / RB 200Hz for QP
Start ~ Stop Frequency	110kHz~490kHz / RB 200Hz for PK & AV
Start ~ Stop Frequency	490kHz~30MHz / RB 9kHz for QP
Start ~ Stop Frequency	30MHz~1000MHz / RB 120kHz for QP



3.2.2 TEST PROCEDURE

- a. The measuring distance at 3 m shall be used for measurements at frequency 0.009MHz up to 1GHz, and above 1GHz.
- b. The EUT was placed on the top of a rotating table 0.8 m (above 1GHz is 1.5 m) above the ground at a 3 m anechoic chamber test site. The table was rotated 360 degree to determine the position of the highest radiation.
- c. The height of the equipment shall be 0.8 m (above 1GHz is 1.5 m); the height of the test antenna shall vary between 1 m to 4 m. Horizontal and vertical polarization of the antenna are set to make the measurement.
- d. The initial step in collecting conducted emission data is a spectrum analyzer peak detector mode pre-scanning the measurement frequency range. Significant peaks are then marked and QuasiPeak detector mode will be re-measured.
- e. If the Peak Mode measured value is compliance with and lower than Quasi Peak Mode Limit, the EUT shall be deemed to meet QP Limits and no additional QP Mode measurement was performed.
- f. For the actual test configuration, please refer to the related Item –EUT Test Photos.

Note:

Both horizontal and vertical antenna polarities were tested and performed pretest to three orthogonal axis. The worst case emissions were reported.

3.2.3 DEVIATION FROM TEST STANDARD

No deviation.

3.2.4 TESTSETUP

(A) Radiated Emission Test-Up Frequency Below 30MHz

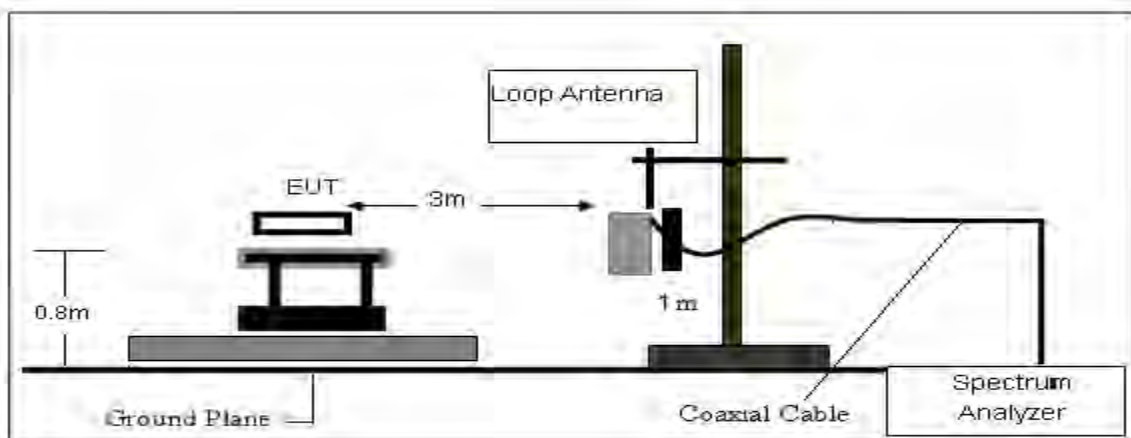

(B) Radiated Emission Test-Up Frequency 30MHz~1GHz

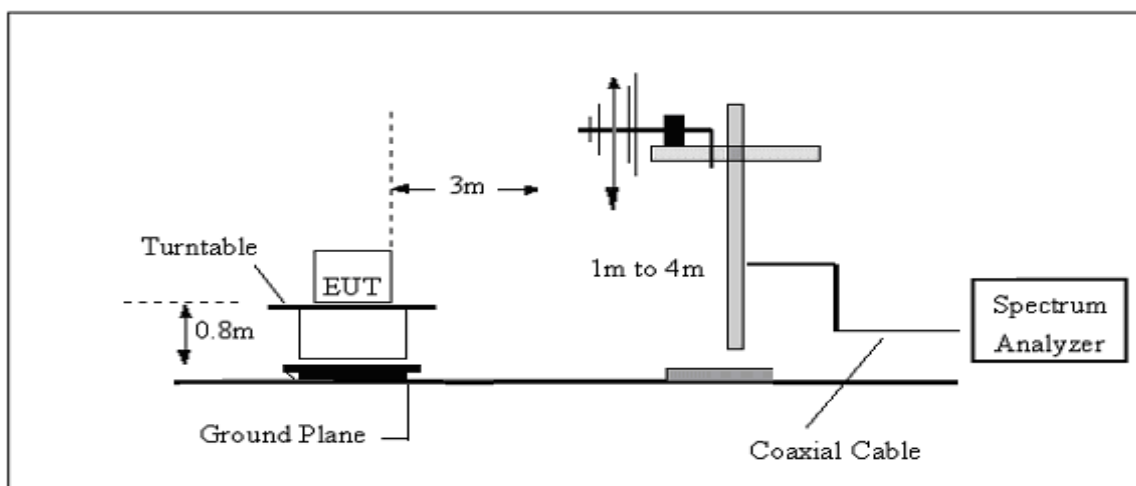

(C) Radiated Emission Test-Up Frequency Above 1GHz

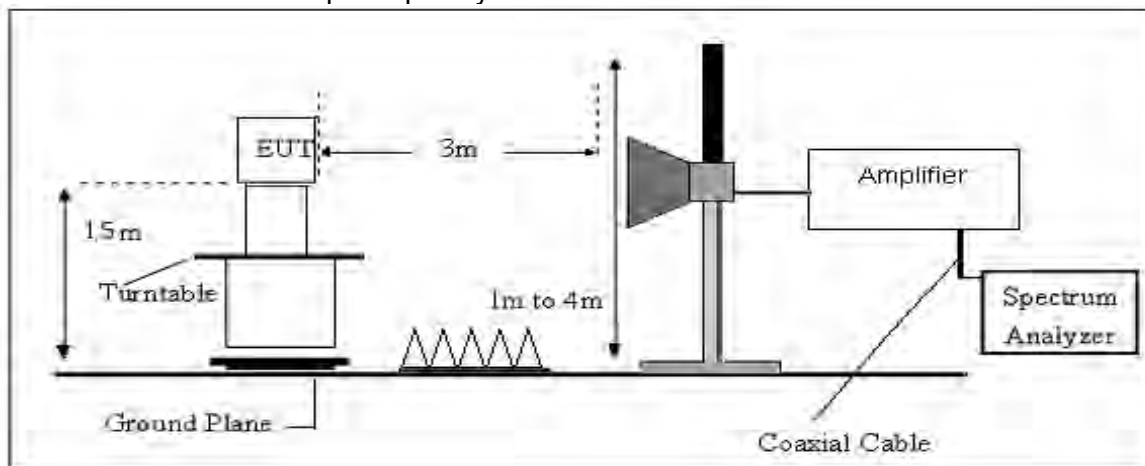

3.2.5 EUT OPERATING CONDITIONS

Please refer to section 3.1.4 of this report.



3.2.6 FIELD STRENGTH CALCULATION

The field strength is calculated by adding the Antenna Factor and Cable Factor and subtracting the Amplifier Gain and Duty Cycle Correction Factor (if any) from the measured reading. The basic equation with a sample calculation is as follows:

$$FS = RA + AF + CL - AG$$

Where

FS = Field Strength

CL = Cable Attenuation Factor (Cable Loss)

RA = Reading Amplitude

AG = Amplifier Gain

AF = Antenna Factor

For example

Frequency (MHz)	FS (dB μ V/m)	RA (dB μ V/m)	AF (dB)	CL (dB)	AG (dB)	Factor (dB)
300	40	58.1	12.2	1.6	31.9	-18.1

$$\text{Factor} = \text{AF} + \text{CL} - \text{AG}$$



3.2.7 TEST RESULTS

Results of Radiated Emissions (9 KHz~30MHz)

No.	Frequency	Reading dBuV	Factor dB/m	Level dBuV/m	Limit dBuV/m	Margin dB	Detector	Remark
1*	-	-	-	-	-	-	-	See Note

Note:

The emission from 9 kHz to 30MHz was pre-tested and found the result was 20dB lower than the limit, and the permissible value has no need to be reported.

Distance extrapolation factor = $40 \log (\text{specific distance} / \text{test distance})$ (dB);

Limit line = specific limits (dBuV) + distance extrapolation factor.



Results of Radiated Emissions (30MHz~1000MHz)

Project: LGT23L045	Test Engineer: Xiangdong Ma
EUT: 2G feature phone	Temperature: 26.5°C
M/N: U10	Humidity: 50%RH
Test Voltage: Battery	Test Data: 2023-12-16
Test Mode: TX DH5 2402	
Note:	

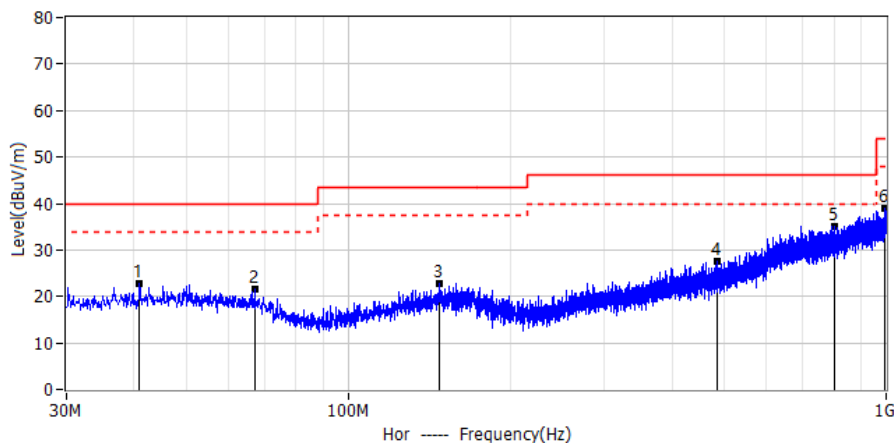

No.	Frequency MHz	Reading dBuV	Factor dB/m	Level dBuV/m	Limit dBuV/m	Margin dB	Detector	Polar
1*	41.034	3.41	19.35	22.76	40.00	-17.24	QP	Hor
2*	67.224	3.42	18.19	21.61	40.00	-18.39	QP	Hor
3*	148.219	2.99	19.82	22.81	43.50	-20.69	QP	Hor
4*	486.506	2.91	24.65	27.56	46.00	-18.44	QP	Hor
5*	803.939	3.83	31.21	35.04	46.00	-10.96	QP	Hor
6*	995.514	4.41	34.55	38.96	54.00	-15.04	QP	Hor

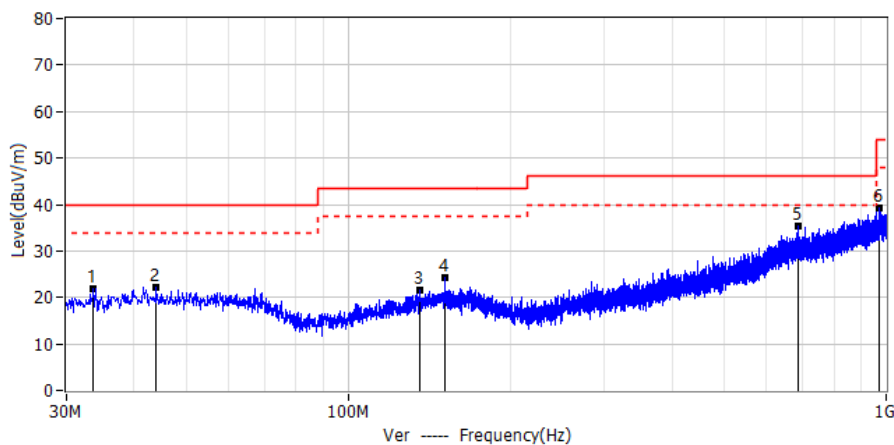

No.	Frequency MHz	Reading dBuV	Factor dB/m	Level dBuV/m	Limit dBuV/m	Margin dB	Detector	Polar
1*	33.638	3.50	18.45	21.95	40.00	-18.05	QP	Ver
2*	44.065	2.98	19.25	22.23	40.00	-17.77	QP	Ver
3*	135.730	2.83	18.81	21.64	43.50	-21.86	QP	Ver
4*	151.493	4.16	19.97	24.13	43.50	-19.37	QP	Ver
5*	687.539	5.67	29.69	35.36	46.00	-10.64	QP	Ver
6*	969.930	4.87	34.34	39.21	54.00	-14.79	QP	Ver



Results of Radiated Emissions (Above 1000MHz)

Note: All the modes have been tested, found worst case at GFSK(1Mbps), recorded the worst case results in this report.

Project: LGT23L045	Test Engineer: Xiangdong Ma
EUT: 2G feature phone	Temperature: 26.5°C
M/N: U10	Humidity: 50%RH
Test Voltage: Battery	Test Data: 2023-12-16
Test Mode: 3DH5 2402	
Note:	

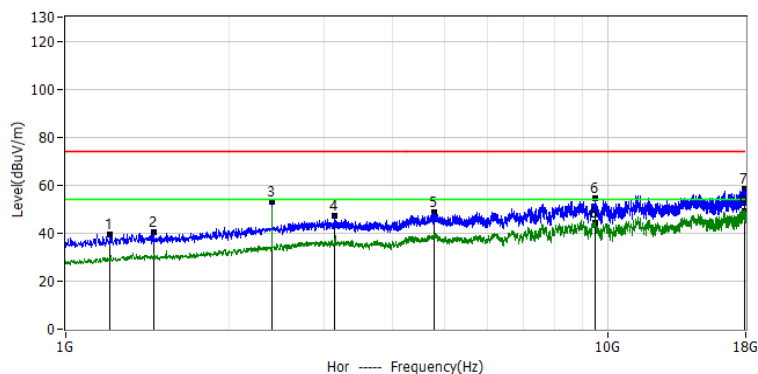

No.	Frequency	Reading dBuV	Factor dB/m	Level dBuV/m	Limit dBuV/m	Margin dB	Detector	Polar
1*	1.2061GHz	62.50	-22.92	39.58	74.00	-34.42	PK	Hor
2*	1.4505GHz	61.33	-21.11	40.22	74.00	-33.78	PK	Hor
3*	2.4025GHz	64.85	-12.01	52.84	--	--	PK	Hor
4*	3.1399GHz	55.49	-8.39	47.10	74.00	-26.90	PK	Hor
5*	4.7889GHz	54.81	-5.98	48.83	74.00	-25.17	PK	Hor
6*	9.4702GHz	55.79	-1.17	54.62	74.00	-19.38	PK	Hor
7*	17.9447GHz	49.83	8.48	58.31	74.00	-15.69	PK	Hor
8*	9.4702GHz	45.57	-1.17	44.40	54.00	-9.60	AV	Hor
9*	17.9447GHz	40.62	8.48	49.10	54.00	-4.90	AV	Hor

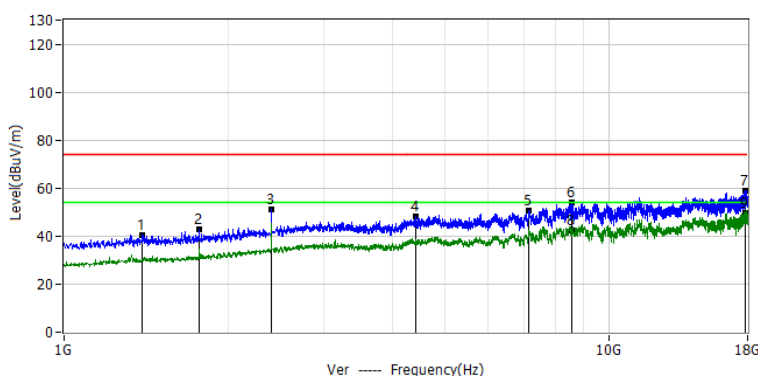

No.	Frequency	Reading dBuV	Factor dB/m	Level dBuV/m	Limit dBuV/m	Margin dB	Detector	Polar
1*	1.3910GHz	61.84	-21.45	40.39	74.00	-33.61	PK	Ver
2*	1.7714GHz	61.22	-18.53	42.69	74.00	-31.31	PK	Ver
3*	2.4025GHz	63.08	-12.01	51.07	--	--	PK	Ver
4*	4.4340GHz	54.37	-6.03	48.34	74.00	-25.66	PK	Ver
5*	7.1306GHz	55.73	-5.33	50.40	74.00	-23.60	PK	Ver
6*	8.5756GHz	56.43	-2.37	54.06	74.00	-19.94	PK	Ver
7*	17.8342GHz	50.63	8.40	59.03	74.00	-14.97	PK	Ver
8*	8.5756GHz	44.77	-2.37	42.40	54.00	-11.60	AV	Ver
9*	17.8342GHz	41.40	8.40	49.80	54.00	-4.20	AV	Ver



Project: LGT23L045	Test Engineer: Xiangdong Ma
EUT: 2G feature phone	Temperature: 26.5°C
M/N: U10	Humidity: 50%RH
Test Voltage: Battery	Test Data: 2023-12-16
Test Mode: 3DH5 2440	
Note:	

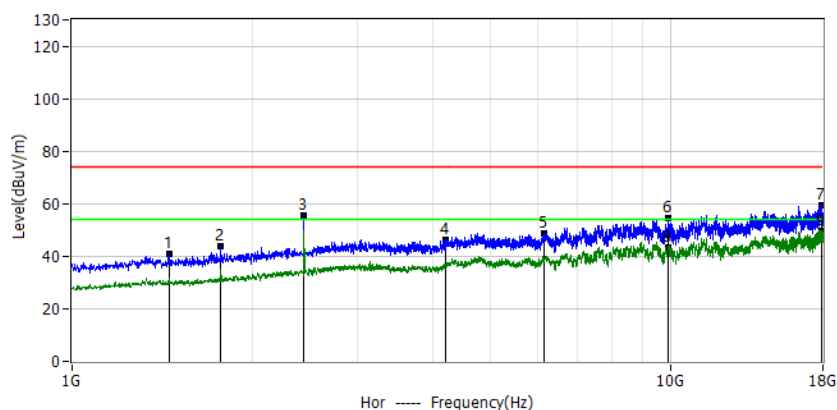

No.	Frequency	Reading dBuV	Factor dB/m	Level dBuV/m	Limit dBuV/m	Margin dB	Detector	Polar
1*	1.4505GHz	61.91	-21.11	40.80	74.00	-33.20	PK	Hor
2*	1.7714GHz	62.28	-18.53	43.75	74.00	-30.25	PK	Hor
3*	2.4407GHz	66.89	-11.61	55.28	--	--	PK	Hor
4*	4.2024GHz	53.13	-7.01	46.12	74.00	-27.88	PK	Hor
5*	6.1467GHz	56.05	-7.25	48.80	74.00	-25.20	PK	Hor
6*	9.9441GHz	55.73	-1.18	54.55	74.00	-19.45	PK	Hor
7*	17.9426GHz	51.15	8.48	59.63	74.00	-14.37	PK	Hor
8*	9.9441GHz	44.38	-1.18	43.20	54.00	-10.80	AV	Hor
9*	17.9426GHz	41.22	8.48	49.70	54.00	-4.30	AV	Hor

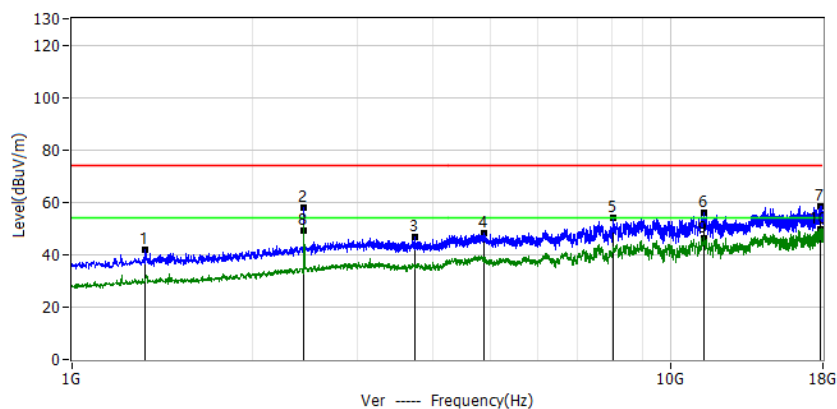

No.	Frequency	Reading dBuV	Factor dB/m	Level dBuV/m	Limit dBuV/m	Margin dB	Detector	Polar
1*	1.3272GHz	63.67	-21.96	41.71	74.00	-32.29	PK	Ver
2*	2.4407GHz	69.31	-11.61	57.70	--	--	PK	Ver
3*	3.7349GHz	54.96	-8.21	46.75	74.00	-27.25	PK	Ver
4*	4.8887GHz	54.02	-6.05	47.97	74.00	-26.03	PK	Ver
5*	8.0295GHz	58.03	-3.92	54.11	74.00	-19.89	PK	Ver
6*	11.3912GHz	54.00	1.86	55.86	74.00	-18.14	PK	Ver
7*	17.8342GHz	50.15	8.40	58.55	74.00	-15.45	PK	Ver
8*	2.4407GHz	60.61	-11.61	49.00	54.00	-5.00	AV	Ver
9*	11.3912GHz	44.34	1.86	46.20	54.00	-7.80	AV	Ver
10*	17.8342GHz	41.20	8.40	49.60	54.00	-4.40	AV	Ver



Project: LGT23L045	Test Engineer: Xiangdong Ma
EUT: 2G feature phone	Temperature: 26.5°C
M/N: U10	Humidity: 50%RH
Test Voltage: Battery	Test Data: 2023-12-16
Test Mode: 3DH5 2480	
Note:	

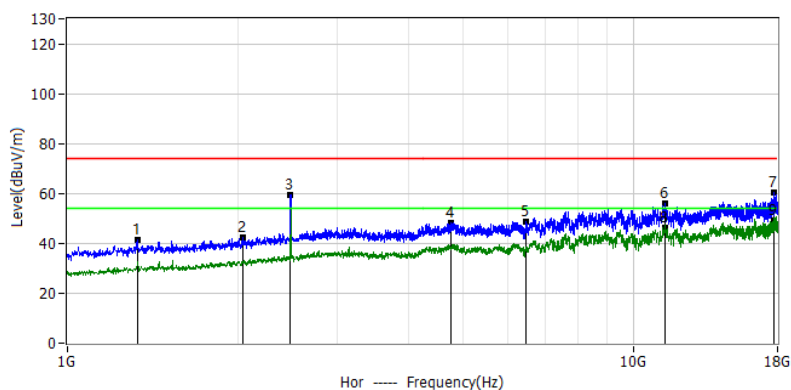

No.	Frequency	Reading dBuV	Factor dB/m	Level dBuV/m	Limit dBuV/m	Margin dB	Detector	Polar
1*	1.3294GHz	63.22	-21.94	41.28	74.00	-32.72	PK	Hor
2*	2.0391GHz	58.09	-15.82	42.27	74.00	-31.73	PK	Hor
3*	2.4790GHz	70.46	-11.21	59.25	--	--	PK	Hor
4*	4.7634GHz	54.06	-5.96	48.10	74.00	-25.90	PK	Hor
5*	6.4697GHz	55.29	-6.62	48.67	74.00	-25.33	PK	Hor
6*	11.3955GHz	54.02	1.86	55.88	74.00	-18.12	PK	Hor
7*	17.7131GHz	51.88	8.32	60.20	74.00	-13.80	PK	Hor
8*	11.3955GHz	44.24	1.86	46.10	54.00	-7.90	AV	Hor
9*	17.7131GHz	40.78	8.32	49.10	54.00	-4.90	AV	Hor

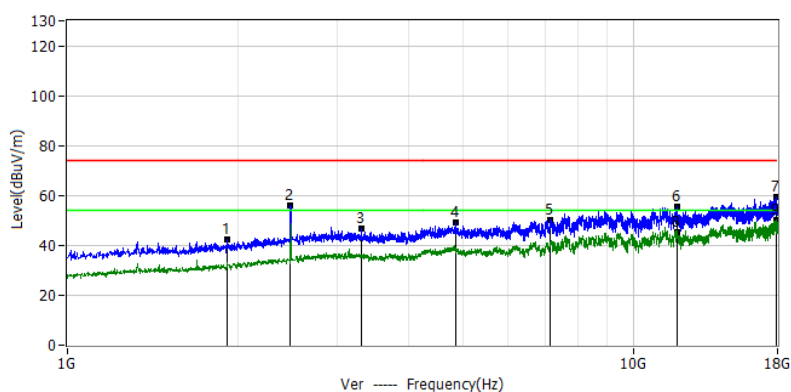

No.	Frequency	Reading dBuV	Factor dB/m	Level dBuV/m	Limit dBuV/m	Margin dB	Detector	Polar
1*	1.9180GHz	59.66	-17.06	42.60	74.00	-31.40	PK	Ver
2*	2.4790GHz	67.16	-11.21	55.95	--	--	PK	Ver
3*	3.3077GHz	55.18	-8.44	46.74	74.00	-27.26	PK	Ver
4*	4.8484GHz	55.10	-6.02	49.08	74.00	-24.92	PK	Ver
5*	7.1242GHz	55.58	-5.34	50.24	74.00	-23.76	PK	Ver
6*	11.9395GHz	53.26	2.18	55.44	74.00	-18.56	PK	Ver
7*	17.9469GHz	50.97	8.48	59.45	74.00	-14.55	PK	Ver
8*	11.9395GHz	43.02	2.18	45.20	54.00	-8.80	AV	Ver
9*	17.9469GHz	41.72	8.48	50.20	54.00	-3.80	AV	Ver

Remark:

In frequency ranges 18~25GHz no any other harmonic emissions detected which are tested to compliance with the limit. No recording in the test report. No any other emissions level which are attenuated less than 20dB below the limit. No recording in the test report.



3.2.8 TEST RESULTS (BAND EDGE REQUIREMENTS)

Note: All the modes have been tested, found worst case at GFSK(1Mbps), recorded the worst case results in this report.

Project: LGT23L045	Test Engineer: Xiangdong Ma
EUT: 2G feature phone	Temperature: 26.5°C
M/N: U10	Humidity: 50%RH
Test Voltage: Battery	Test Data: 2023-12-16
Test Mode: 3DH5 2402	
Note:	

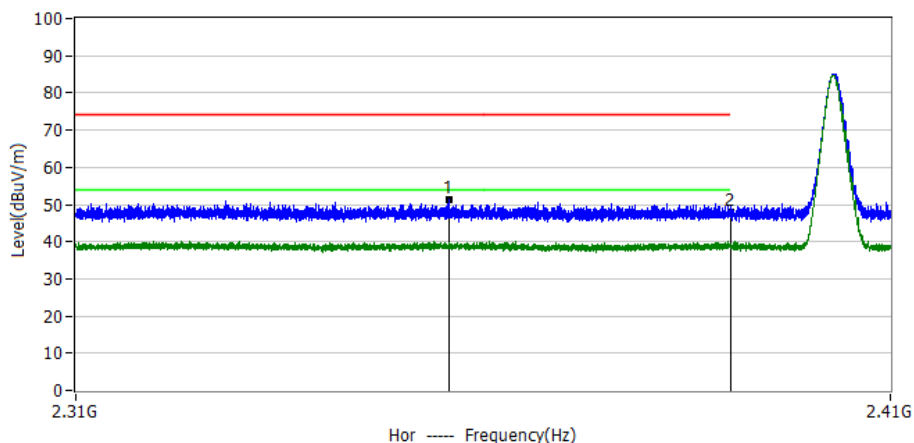

No.	Frequency MHz	Reading dBuV	Factor dB/m	Level dBuV/m	Limit dBuV/m	Margin dB	Detector	Polar
1*	2355.3000	17.16	34.04	51.20	74.00	-22.80	PK	Hor
2*	2390.0000	14.05	33.95	48.00	74.00	-26.00	PK	Hor

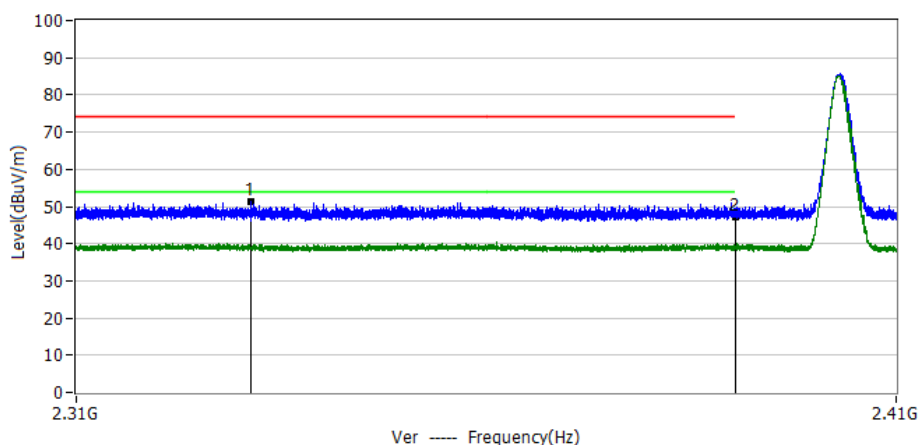

No.	Frequency MHz	Reading dBuV	Factor dB/m	Level dBuV/m	Limit dBuV/m	Margin dB	Detector	Polar
1*	2331.0000	17.06	34.09	51.15	74.00	-22.85	PK	Ver
2*	2390.0000	13.15	33.95	47.10	74.00	-26.90	PK	Ver



Project: LGT23L045	Test Engineer: Xiangdong Ma
EUT: 2G feature phone	Temperature: 26.5°C
M/N: U10	Humidity: 50%RH
Test Voltage: Battery	Test Data: 2023-12-16
Test Mode: 3DH5 2480	
Note:	

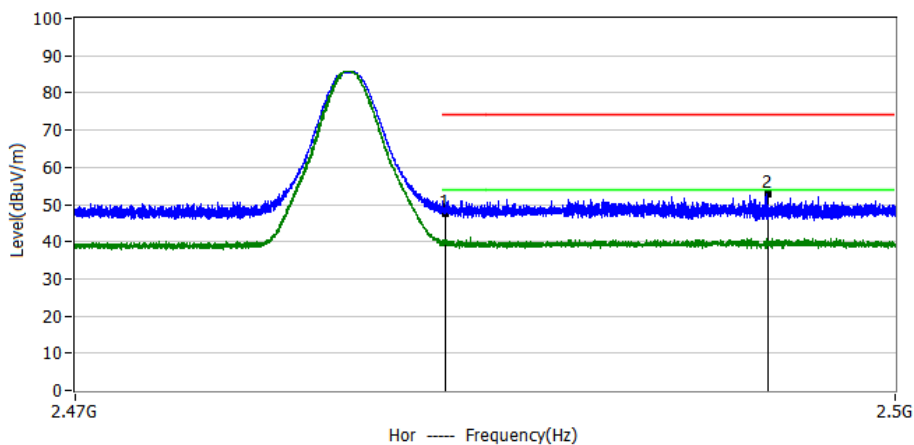

No.	Frequency MHz	Reading dBuV	Factor dB/m	Level dBuV/m	Limit dBuV/m	Margin dB	Detector	Polar
1*	2483.5000	13.57	34.13	47.70	74.00	-26.30	PK	Hor
2*	2495.3000	18.60	34.15	52.75	74.00	-21.25	PK	Hor

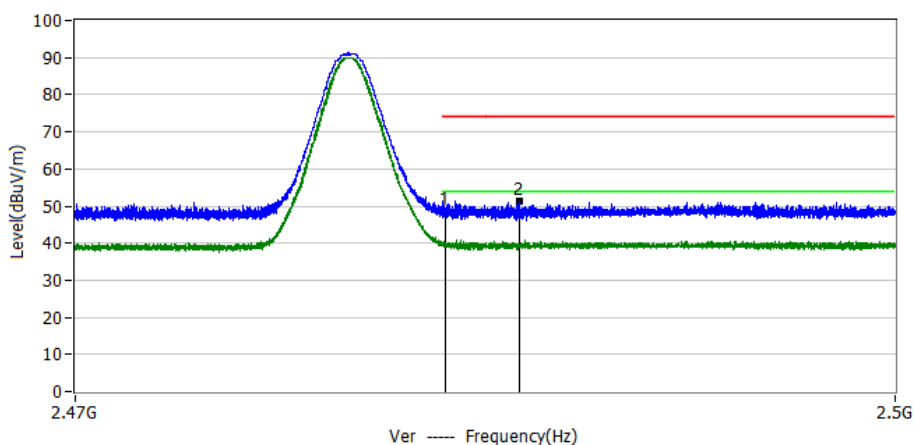

No.	Frequency MHz	Reading dBuV	Factor dB/m	Level dBuV/m	Limit dBuV/m	Margin dB	Detector	Polar
1*	2483.5000	14.67	34.13	48.80	74.00	-25.20	PK	Ver
2*	2486.2000	17.07	34.13	51.20	74.00	-22.80	PK	Ver



4. CONDUCTED SPURIOUS & BAND EDGE EMISSION

4.1 LIMIT

According to FCC section 15.247(d), in any 100kHz bandwidth outside the frequency band in which the spread spectrum or digitally modulated intentional radiator is operating, the radio frequency power that is produced by the intentional radiator shall be at least 20dB below that in the 100kHz bandwidth within the band that contains the highest level of the desired power, based on either an RF conducted or a radiated measurement.

4.2 TEST PROCEDURE

Spectrum Parameter	Setting
Detector	Peak
Start/Stop Frequency	30 MHz to 10th carrier harmonic
RB / VB (emission in restricted band)	100 KHz/300 KHz
Trace-Mode:	Max hold

For Band edge

Spectrum Parameter	Setting
Detector	Peak
Start/Stop Frequency	Lower Band Edge: 2300 – 2407 MHz Upper Band Edge: 2475 – 2500 MHz
RB / VB (emission in restricted band)	100 KHz/300 KHz
Trace-Mode:	Max hold

For Hopping Band edge

Spectrum Parameter	Setting
Detector	Peak
Start/Stop Frequency	Lower Band Edge: 2300– 2403 MHz Upper Band Edge: 2479 – 2500 MHz
RB / VB (emission in restricted band)	100 KHz/300 KHz
Trace-Mode:	Max hold



4.3 TEST SETUP



The EUT is connected to the Spectrum Analyzer; the RF load attached to the EUT antenna terminal is 50Ohm; the path loss as the factor is calibrated to correct the reading. Tune the measurement with the spectrum analyzer's resolution bandwidth (RBW) = 100 kHz. In order to make an accurate measurement, the span is set to be greater than RBW.

4.4 EUT OPERATION CONDITIONS

Please refer to section 3.1.4 of this report.

4.5 TEST RESULTS

For the measurement records, refer to the appendix I.



5. NUMBER OF HOPPING CHANNEL

5.1 LIMIT

FCC Part 15.247, Subpart C				
Section	Test Item	Limit	FrequencyRange (MHz)	Result
15.247 (a)(1)(iii)	Number of Hopping Channel	≥15	2400-2483.5	PASS

Spectrum Parameters	Setting
Attenuation	Auto
Span Frequency	> Operating FrequencyRange
RB	300KHz
VB	300KHz
Detector	Peak
Trace	Max Hold
Sweep Time	Auto

5.2 TEST PROCEDURE

- a. The EUT was directly connected to the spectrum analyzer and antenna output port as show in the block diagram below.
- b. Spectrum Setting: RBW= 300KHz, VBW=300KHz, Sweep time = Auto.

5.3 TEST SETUP



5.4 EUT OPERATION CONDITIONS

Please refer to section 3.1.4 of this report.

5.5 TEST RESULTS

For the measurement records, refer to the appendix I.



6. AVERAGE TIME OF OCCUPANCY

6.1 LIMIT

FCC Part 15.247, Subpart C				
Section	Test Item	Limit	FrequencyRange (MHz)	Result
15.247 (a)(1)(iii)	Average Time of Occupancy	0.4sec	2400-2483.5	PASS

6.2 TEST PROCEDURE

- a. The transmitter output (antenna port) was connected to the spectrum analyzer.
- b. Set RBW =1MHz/VBW =3MHz.
- c. Use a video trigger with the trigger level set to enable triggering only on full pulses.
- d. Sweep Time is more than once pulse time.
- e. Set the center frequency on any frequency would be measure and set the frequency span to zero span.
- f. Measure the maximum time duration of one single pulse.
- g. Set the EUT for DH5, DH3 and DH1 packet transmitting.
- h. Measure the maximum time duration of one single pulse.
- i. DH5 Packet permit maximum $1600 / 79 / 6 = 3.37$ hops per second in each channel (5 time slots RX, 1 time slot TX). So the number of pulses in the observation period of 31.6 seconds is $3.37 \times 31.6 = 106.6$.
- j. DH3 Packet permit maximum $1600 / 79 / 4 = 5.06$ hops per second in each channel (3 time slots RX, 1 time slot TX). So the number of pulses in the observation period of 31.6 seconds is $5.06 \times 31.6 = 160$.
- k. DH1 Packet permit maximum $1600 / 79 / 2 = 10.12$ hops per second in each channel (1 time slot RX, 1 time slot TX). So the number of pulses in the observation period of 31.6 seconds is $10.12 \times 31.6 = 320$.

6.3 TEST SETUP



6.4 EUT OPERATION CONDITIONS

Please refer to section 3.1.4 of this report.

6.5 TEST RESULTS

For the measurement records, refer to the appendix I.



7. HOPPING CHANNEL SEPARATION MEASUREMENT

7.1 LIMIT

Frequency hopping systems shall have hopping channel carrier frequencies separated by a minimum of 25 kHz or the 20 dB bandwidth of the hopping channel, whichever is greater. Alternatively, frequency hopping systems operating in the 2400-2483.5 MHz band may have hopping channel carrier frequencies that are separated by 25 kHz or two-thirds of the 20 dB bandwidth of the hopping channel, whichever is greater, provided the systems operate with an output power no greater than 125 mW.

Spectrum Parameter	Setting
Attenuation	Auto
Span Frequency	> 20 dB Bandwidth or Channel Separation
RB	30 kHz (20dB Bandwidth) / 30 kHz (Channel Separation)
VB	100 kHz (20dB Bandwidth) / 100 kHz (Channel Separation)
Detector	Peak
Trace	Max Hold
Sweep Time	Auto

7.2 TEST PROCEDURE

- The transmitter output (antenna port) was connected to the spectrum analyser in peak hold mode.
- The resolution bandwidth of 30 kHz and the video bandwidth of 100 kHz were utilised for 20 dB bandwidth measurement.
- The resolution bandwidth of 30 kHz and the video bandwidth of 100 kHz were utilised for channel separation measurement.

7.3 TEST SETUP



7.4 EUT OPERATION CONDITIONS

The EUT was programmed to be in continuously transmitting mode.

7.5 TEST RESULTS

For the measurement records, refer to the appendix I.



8. BANDWIDTH TEST

8.1 LIMIT

FCC Part15 15.247, Subpart C				
Section	Test Item	Limit	FrequencyRange (MHz)	Result
15.247 (a)(1)	Bandwidth	N/A	2400-2483.5	PASS

Spectrum Parameter	Setting
Attenuation	Auto
Span Frequency	> Measurement Bandwidth or Channel Separation
RB	30 kHz (20dB Bandwidth) / 30 kHz (Channel Separation)
VB	100 kHz (20dB Bandwidth) / 100 kHz (Channel Separation)
Detector	Peak
Trace	Max Hold
Sweep Time	Auto

8.2 TEST PROCEDURE

- a. The EUT was directly connected to the spectrum analyzer and antenna output port as show in the block diagram below.
- b. Spectrum Setting: RBW= 30KHz, VBW=100KHz, Sweep time = Auto.

8.3 TEST SETUP



8.4 EUT OPERATION CONDITIONS

Please refer to section 3.1.4 of this report.

8.5 TEST RESULTS

For the measurement records, refer to the appendix I.



9. OUTPUT POWER TEST

9.1 LIMIT

FCC Part 15.247, Subpart C				
Section	Test Item	Limit	Frequency Range (MHz)	Result
15.247 (a)(1)&(b)(1)	Output Power	1 W or 0.125W	2400-2483.5	PASS
		if channel separation > 2/3 bandwidth provided the systems operate with an output power no greater than 125 mW (20.97dBm)		

9.2 TEST PROCEDURE

This is an RF-conducted test to evaluate maximum peak output power. Use a direct connection between the antenna port of the unlicensed wireless device and the spectrum analyzer, through suitable attenuation. The hopping shall be disabled for this test:

a) Use the following spectrum analyzer settings:

- 1) Span: Approximately five times the 20 dB bandwidth, centered on a hopping channel.
- 2) RBW > 20 dB bandwidth of the emission being measured.
- 3) VBW \geq RBW.
- 4) Sweep: Auto.
- 5) Detector function: Peak.
- 6) Trace: Max hold.

b) Allow trace to stabilize.

c) Use the marker-to-peak function to set the marker to the peak of the emission.

d) The indicated level is the peak output power, after any corrections for external attenuators and cables.

e) A plot of the test results and setup description shall be included in the test report.

NOTE—A peak responding power meter may be used, where the power meter and sensor system video bandwidth is greater than the occupied bandwidth of the unlicensed wireless device, rather than a spectrum analyzer.

PKPM1 Peak power meter method:

The maximum peak conducted output power may be measured using a broadband peak RF power meter. The power meter shall have a video bandwidth that is greater than or equal to the DSS bandwidth and shall use a fast-responding diode detector.

9.3 TEST SETUP

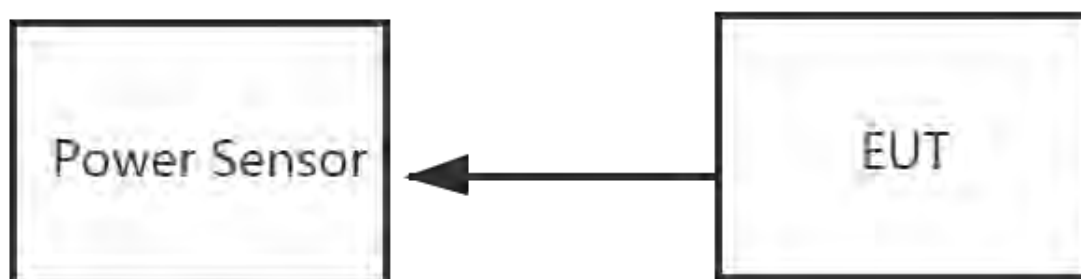

9.4 EUT OPERATION CONDITIONS

Please refer to section 3.1.4 of this report.

9.5 TEST RESULTS

For the measurement records, refer to the appendix I.



10. ANTENNA REQUIREMENT

10.1 STANDARD REQUIREMENT

15.203 requirement: For intentional device, according to 15.203: an intentional radiator shall be designed to ensure that no antenna other than that furnished by the responsible party shall be used with the device.

10.2 EUT ANTENNA

The EUT antenna is Monopole Antenna. It comply with the standard requirement.



APPENDIX I - TEST RESULTS

Duty Cycle

Condition	Mode	Frequency (MHz)	Antenna	Duty Cycle (%)	Correction Factor (dB)	1/T (kHz)
NVNT	1-DH5	2402	Ant1	77.22	1.12	0.35
NVNT	1-DH5	2441	Ant1	77.22	1.12	0.35
NVNT	1-DH5	2480	Ant1	77.23	1.12	0.35
NVNT	2-DH5	2402	Ant1	76.89	1.14	0.35
NVNT	2-DH5	2441	Ant1	76.96	1.14	0.35
NVNT	2-DH5	2480	Ant1	76.89	1.14	0.35
NVNT	3-DH5	2402	Ant1	76.91	1.14	0.35
NVNT	3-DH5	2441	Ant1	76.89	1.14	0.35
NVNT	3-DH5	2480	Ant1	76.89	1.14	0.35

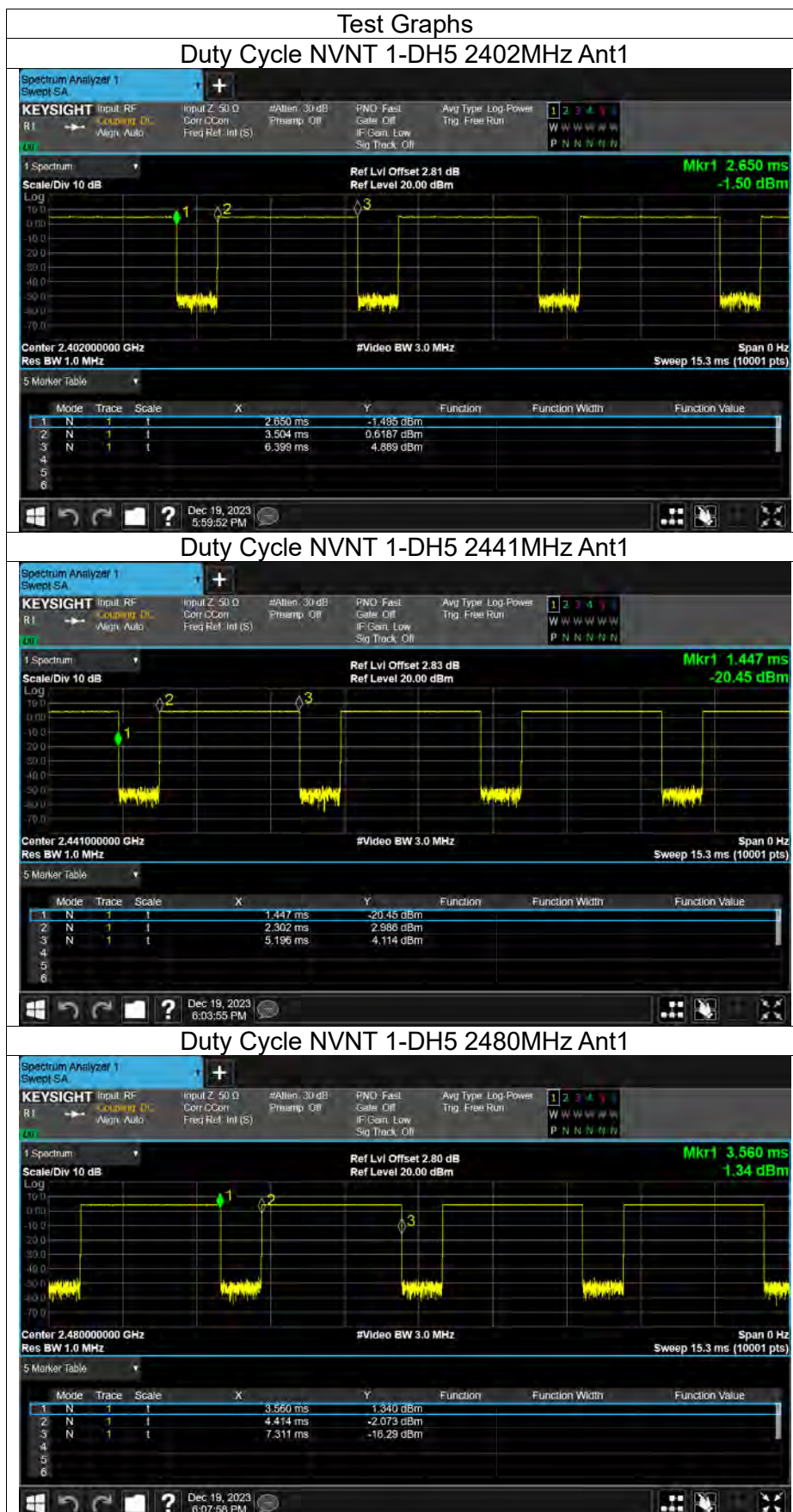

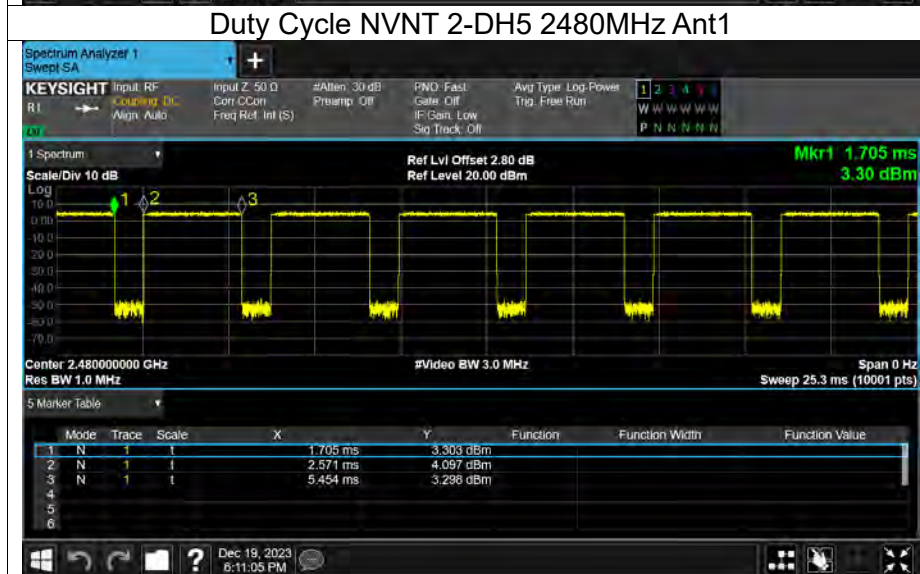
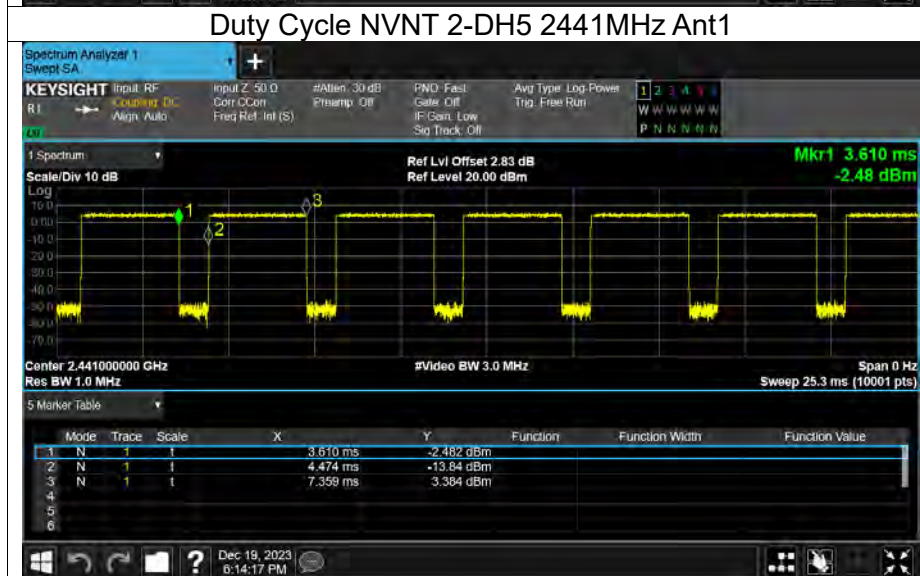
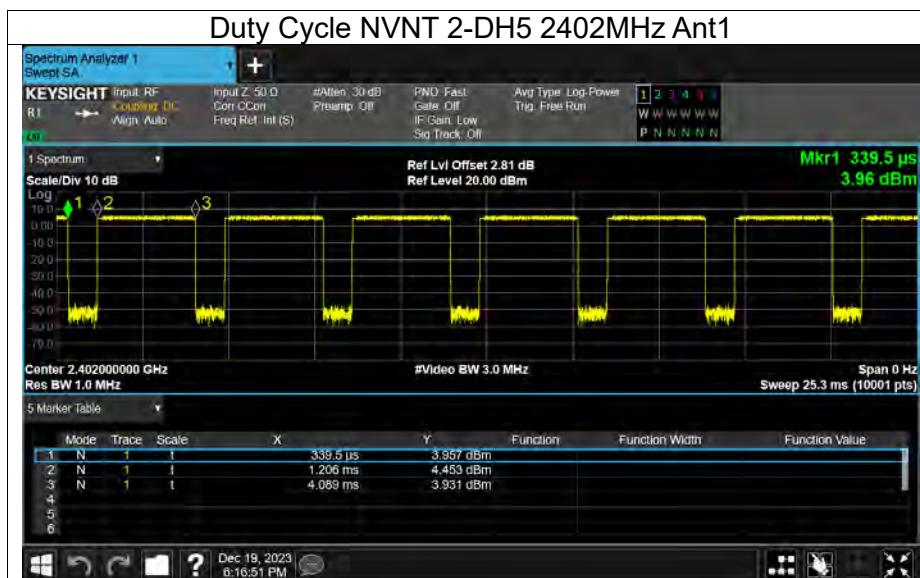

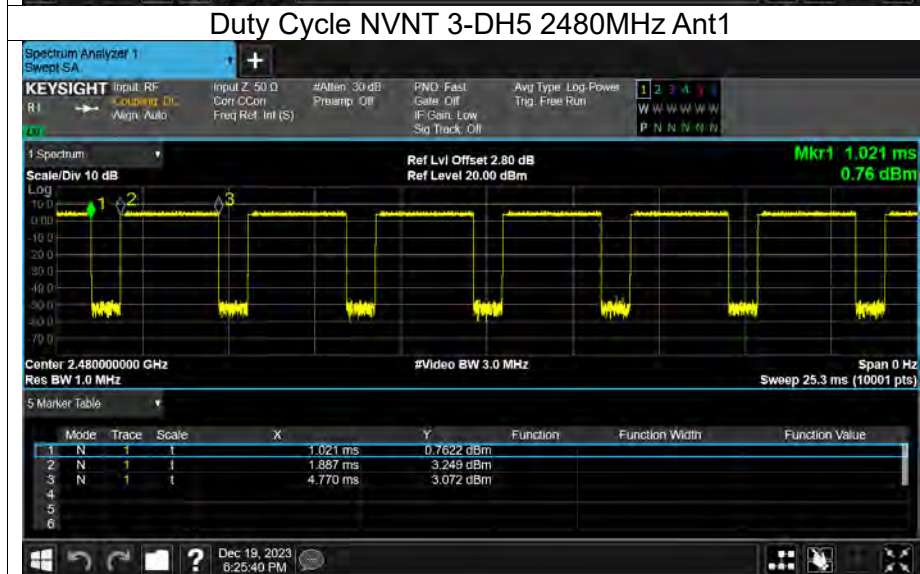
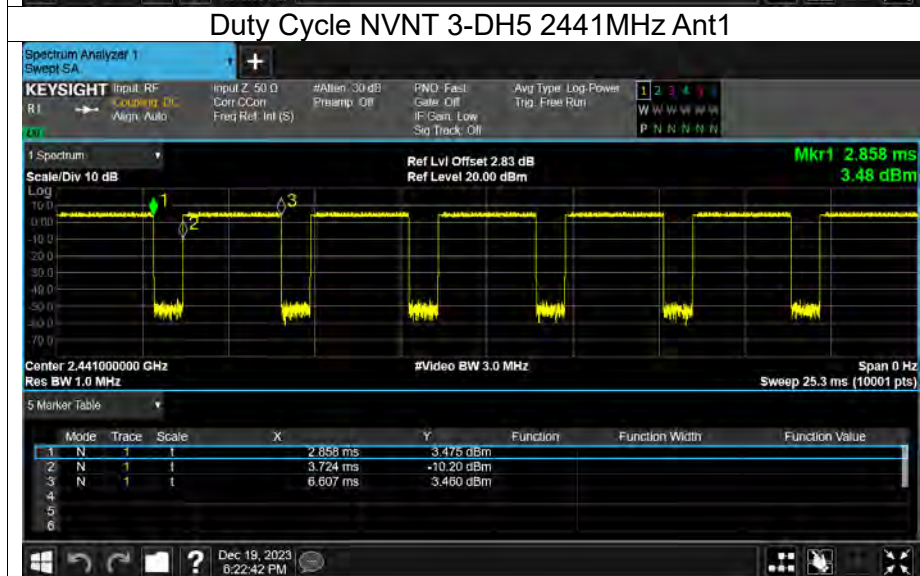
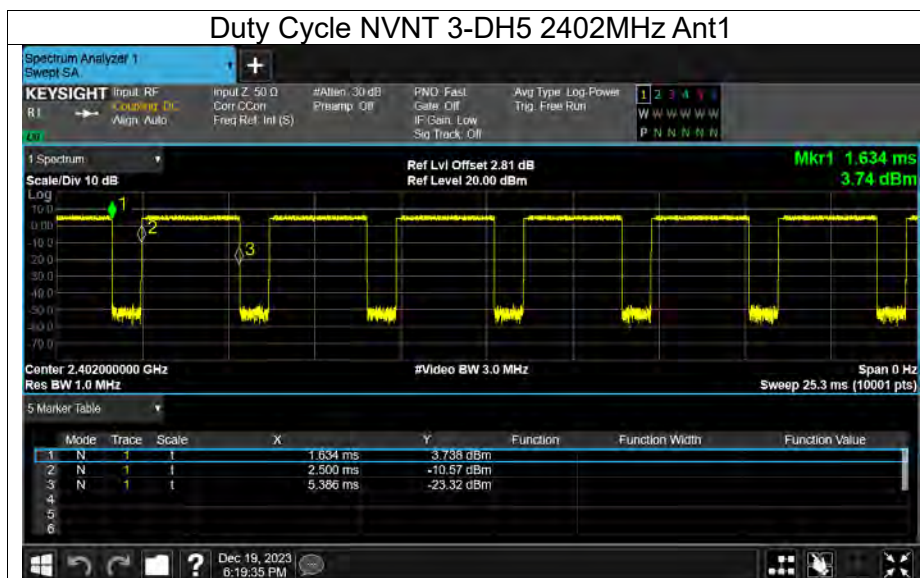



Maximum Peak Conducted Output Power

Condition	Mode	Frequency (MHz)	Antenna	Conducted Power (dBm)	Limit (dBm)	Verdict
NVNT	1-DH5	2402	Ant1	5.32	21	Pass
NVNT	1-DH5	2441	Ant1	4.97	21	Pass
NVNT	1-DH5	2480	Ant1	5.1	21	Pass
NVNT	2-DH5	2402	Ant1	6.58	21	Pass
NVNT	2-DH5	2441	Ant1	6.33	21	Pass
NVNT	2-DH5	2480	Ant1	6.1	21	Pass
NVNT	3-DH5	2402	Ant1	6.87	21	Pass
NVNT	3-DH5	2441	Ant1	6.54	21	Pass
NVNT	3-DH5	2480	Ant1	6.3	21	Pass



-20dB Bandwidth

Condition	Mode	Frequency (MHz)	Antenna	-20 dB Bandwidth (MHz)	Verdict
NVNT	1-DH5	2402	Ant1	1.019	Pass
NVNT	1-DH5	2441	Ant1	0.951	Pass
NVNT	1-DH5	2480	Ant1	0.952	Pass
NVNT	2-DH5	2402	Ant1	1.327	Pass
NVNT	2-DH5	2441	Ant1	1.318	Pass
NVNT	2-DH5	2480	Ant1	1.333	Pass
NVNT	3-DH5	2402	Ant1	1.309	Pass
NVNT	3-DH5	2441	Ant1	1.286	Pass
NVNT	3-DH5	2480	Ant1	1.303	Pass



Test Graphs

-20dB Bandwidth NVNT 1-DH5 2402MHz Ant1



-20dB Bandwidth NVNT 1-DH5 2441MHz Ant1



-20dB Bandwidth NVNT 1-DH5 2480MHz Ant1



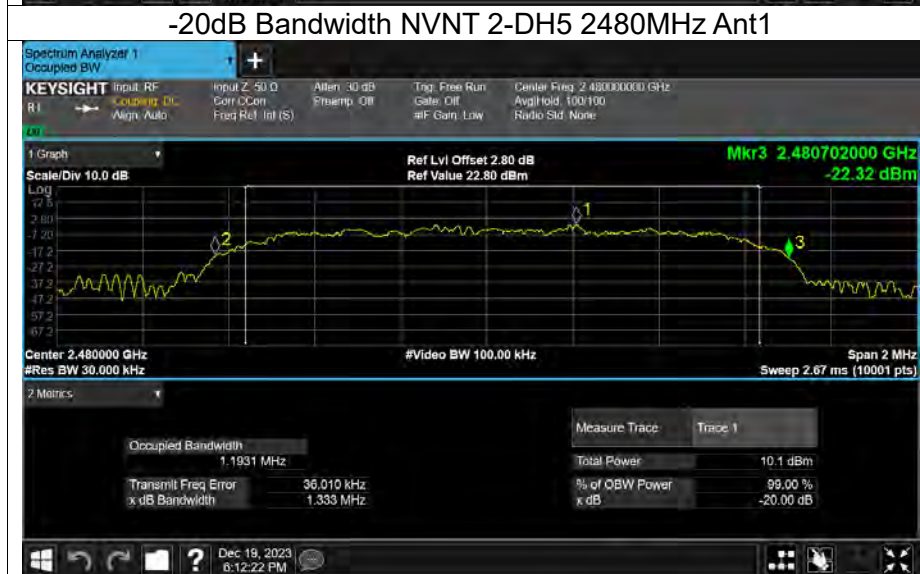
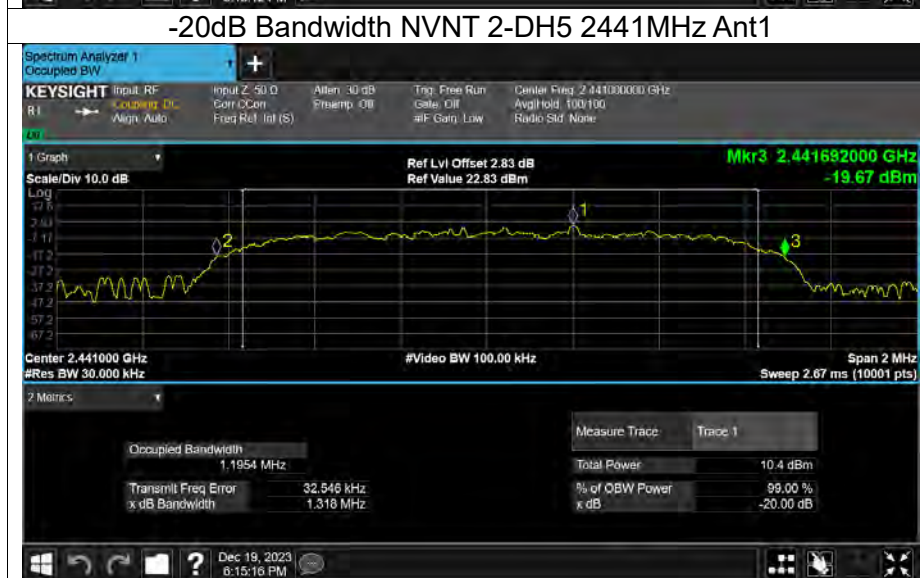
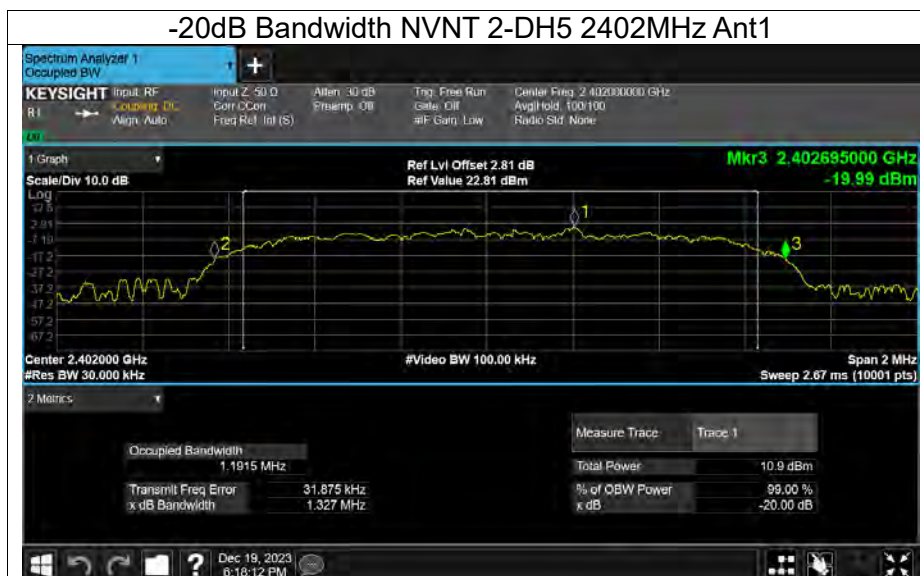

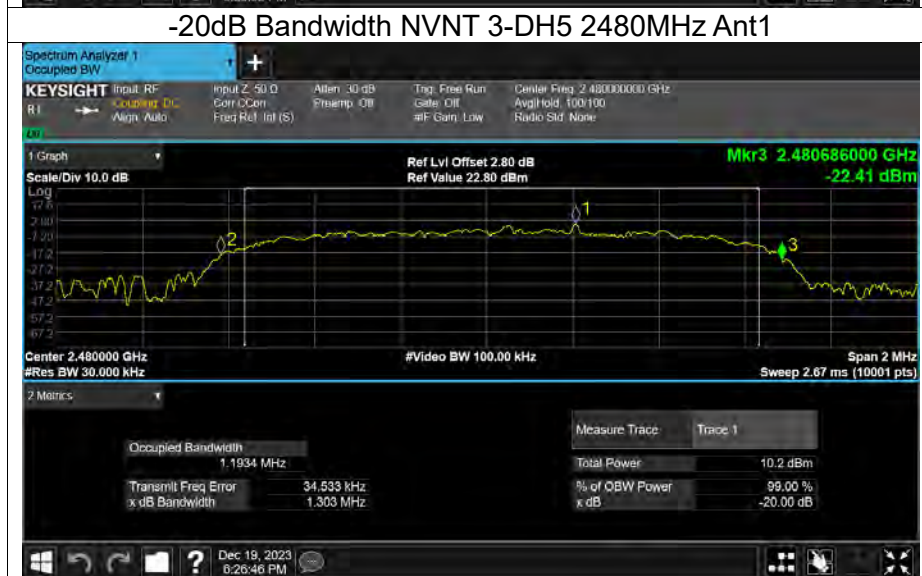
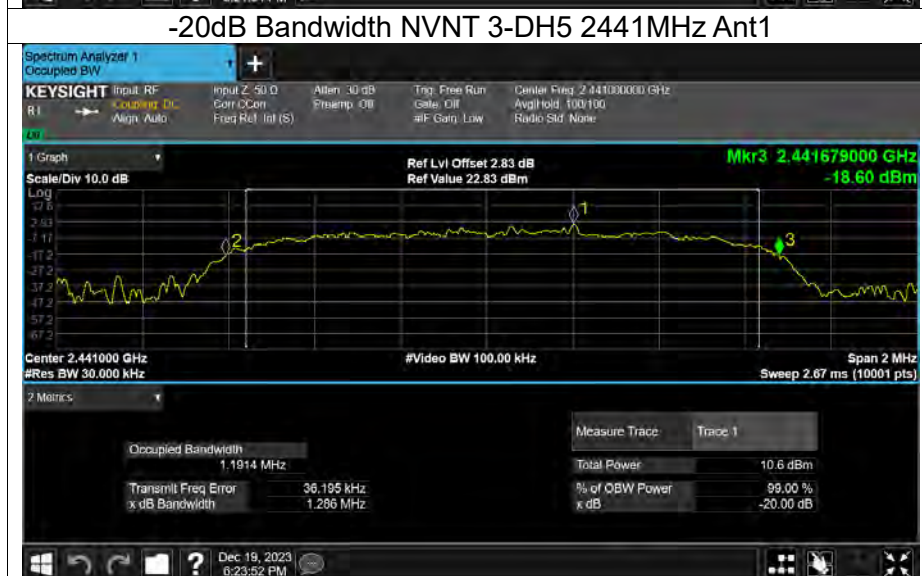
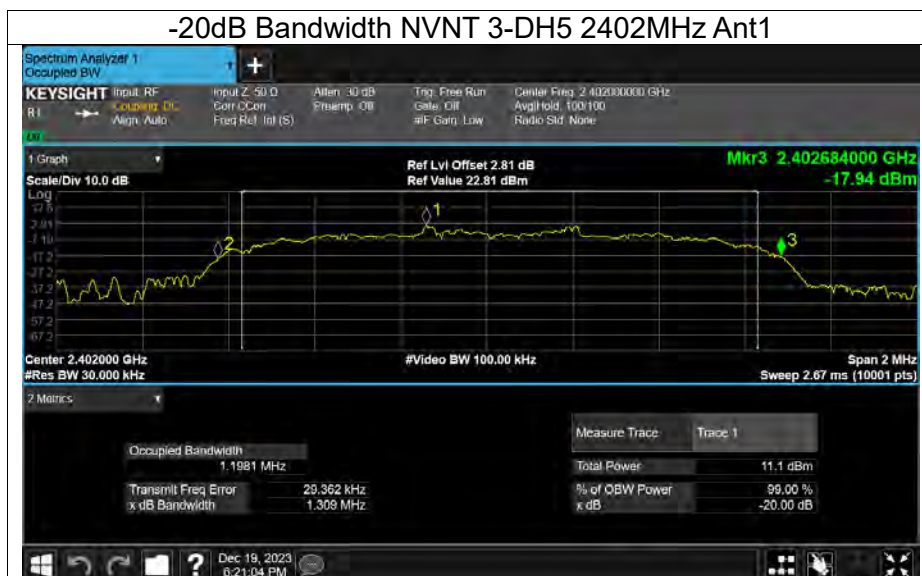



Occupied Channel Bandwidth

Condition	Mode	Frequency (MHz)	Antenna	99% OBW (MHz)
NVNT	1-DH5	2402	Ant1	0.894
NVNT	1-DH5	2441	Ant1	0.902
NVNT	1-DH5	2480	Ant1	0.895
NVNT	2-DH5	2402	Ant1	1.192
NVNT	2-DH5	2441	Ant1	1.195
NVNT	2-DH5	2480	Ant1	1.193
NVNT	3-DH5	2402	Ant1	1.204
NVNT	3-DH5	2441	Ant1	1.195
NVNT	3-DH5	2480	Ant1	1.204



Test Graphs

OBW NVNT 1-DH5 2402MHz Ant1



OBW NVNT 1-DH5 2441MHz Ant1



OBW NVNT 1-DH5 2480MHz Ant1



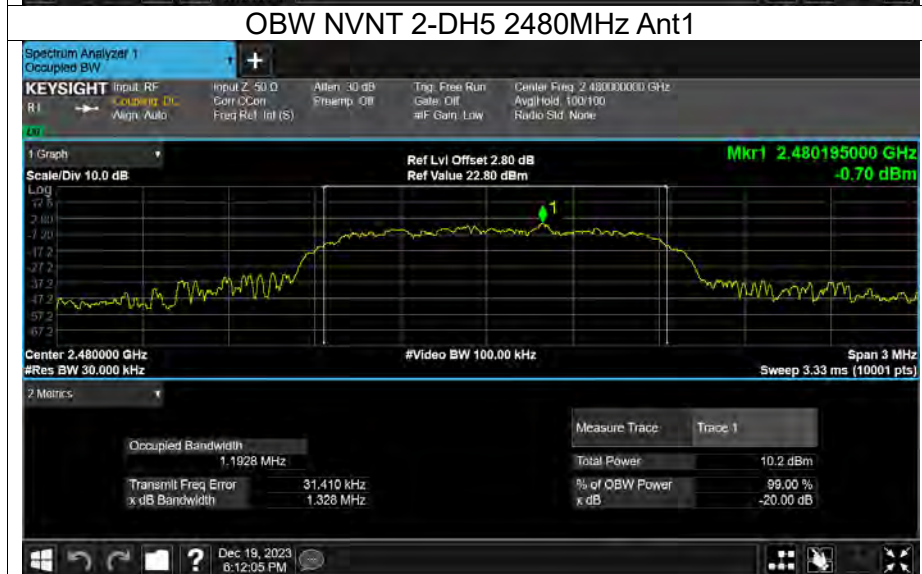
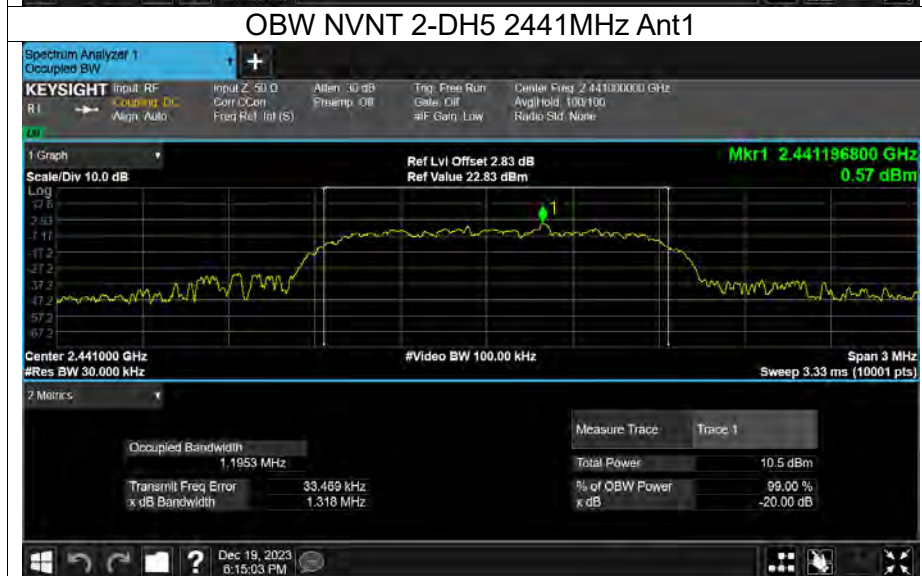
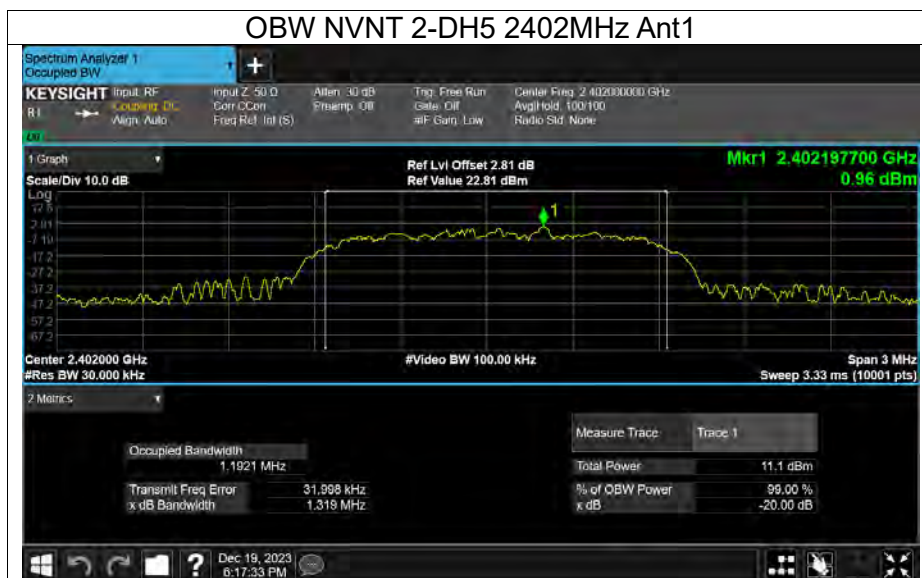

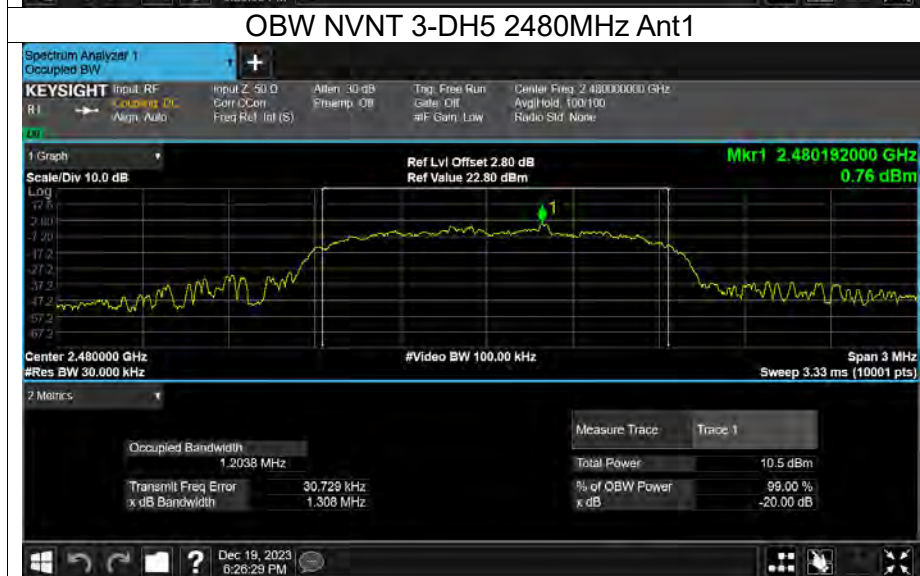
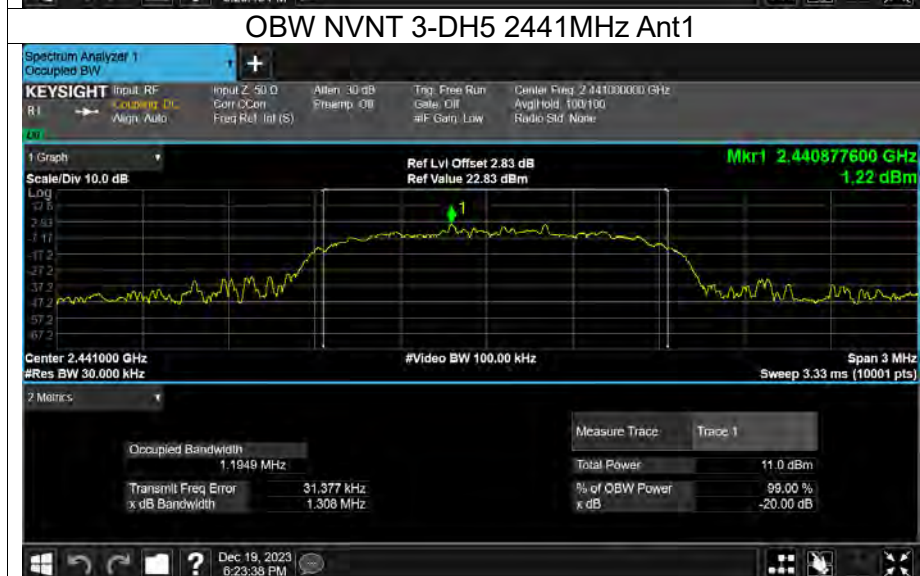
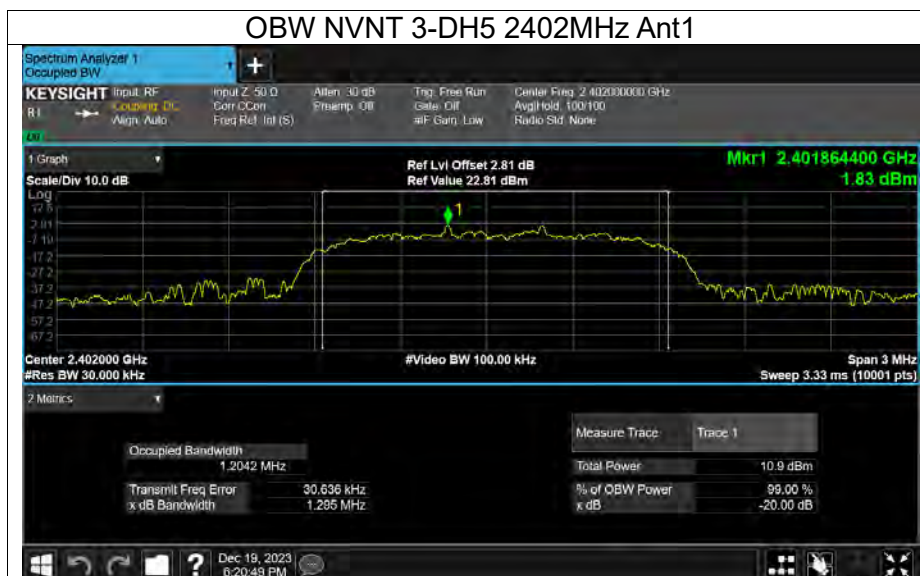



Carrier Frequencies Separation

Condition	Mode	Antenna	Hopping Freq1 (MHz)	Hopping Freq2 (MHz)	HFS (MHz)	Limit (MHz)	Verdict
NVNT	1-DH5	Ant1	2401.924	2403.09	1.166	0.679	Pass
NVNT	1-DH5	Ant1	2441.004	2442.044	1.04	0.634	Pass
NVNT	1-DH5	Ant1	2479.05	2480.022	0.972	0.635	Pass
NVNT	2-DH5	Ant1	2402.054	2402.952	0.898	0.885	Pass
NVNT	2-DH5	Ant1	2440.93	2441.946	1.016	0.879	Pass
NVNT	2-DH5	Ant1	2479.05	2480.06	1.01	0.889	Pass
NVNT	3-DH5	Ant1	2401.932	2403.066	1.134	0.873	Pass
NVNT	3-DH5	Ant1	2440.978	2441.98	1.002	0.857	Pass
NVNT	3-DH5	Ant1	2478.926	2480.046	1.12	0.869	Pass



Test Graphs

CFS NVNT 1-DH5 2402MHz Ant1

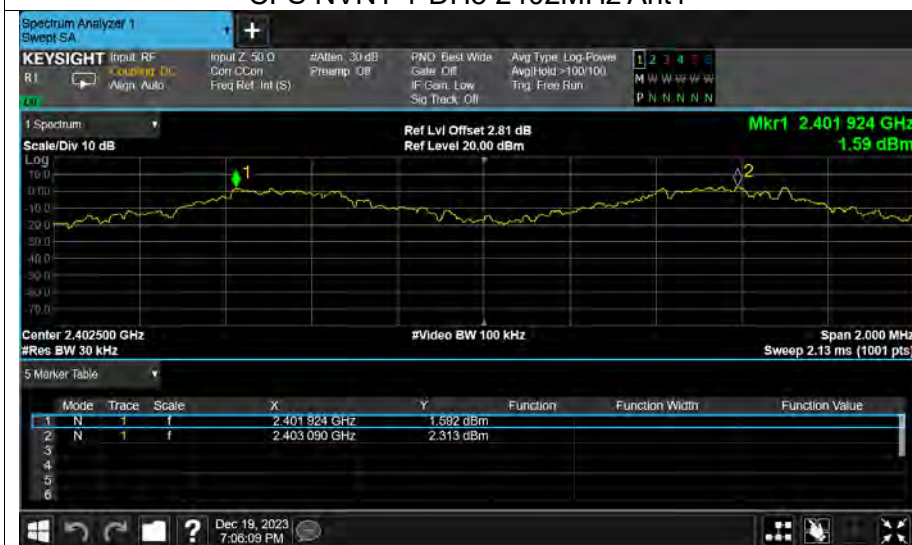

CFS NVNT 1-DH5 2441MHz Ant1



CFS NVNT 1-DH5 2480MHz Ant1



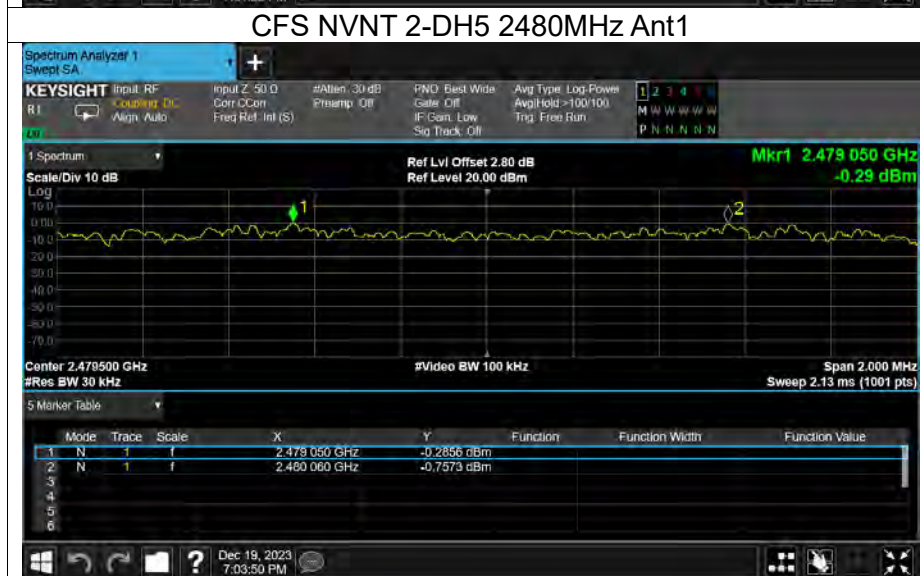
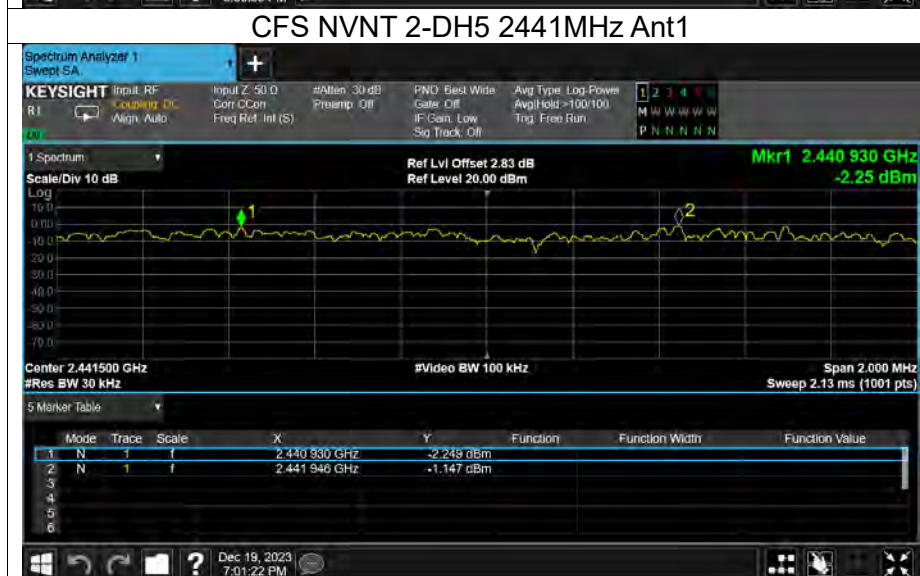
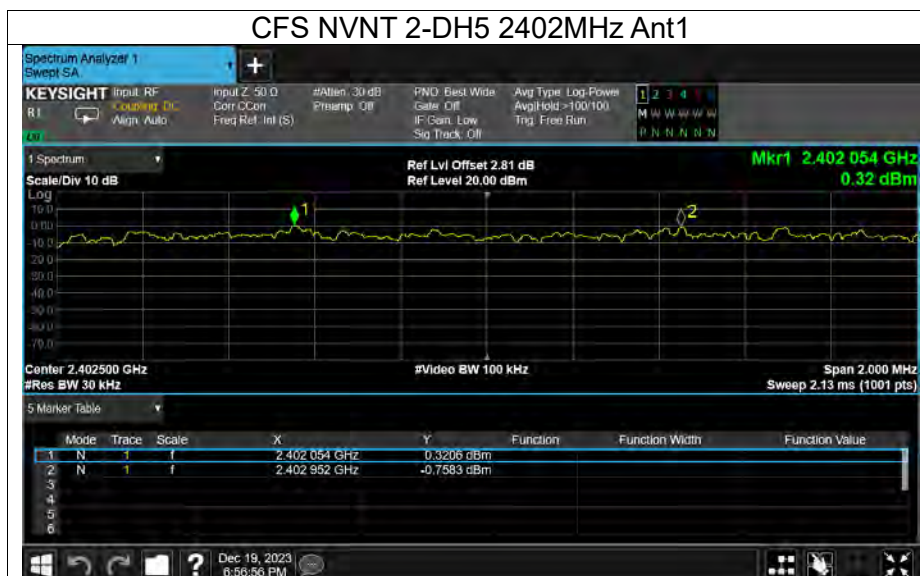

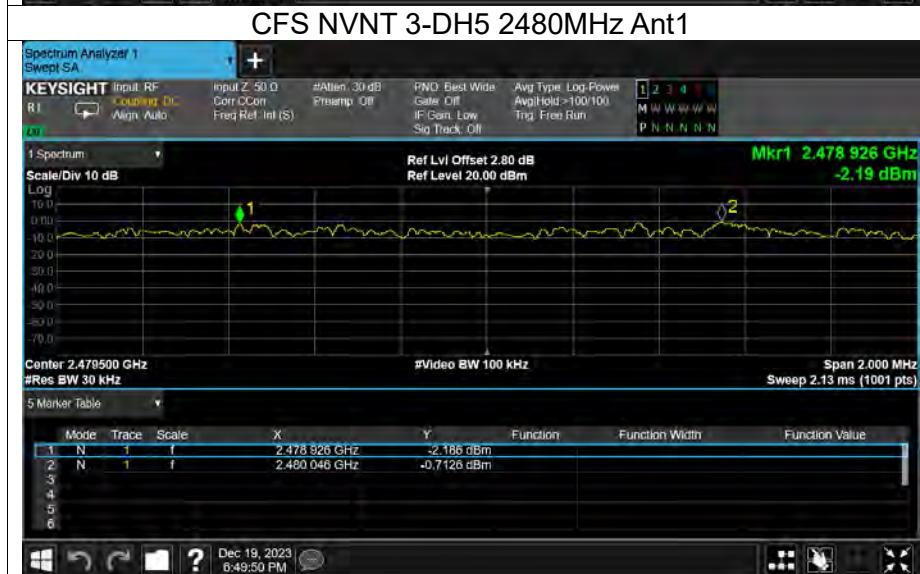
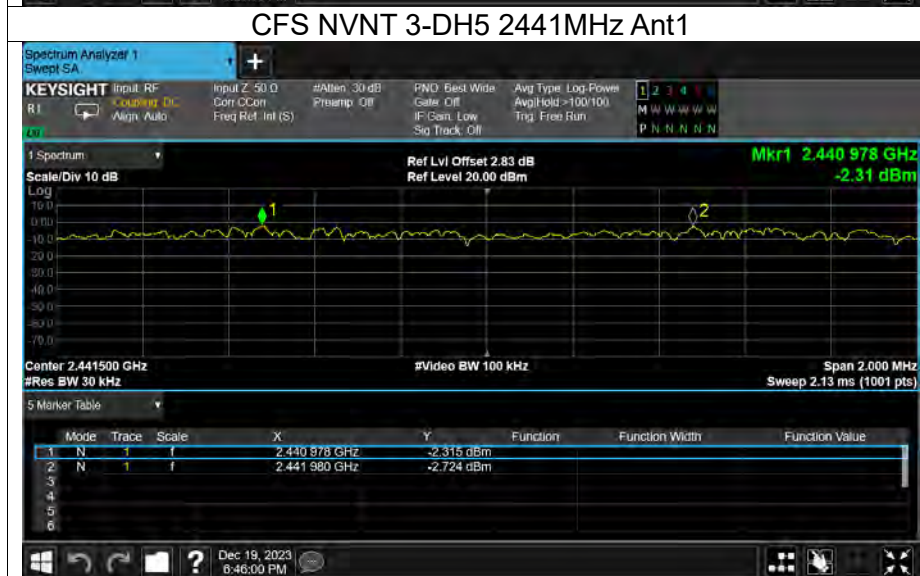
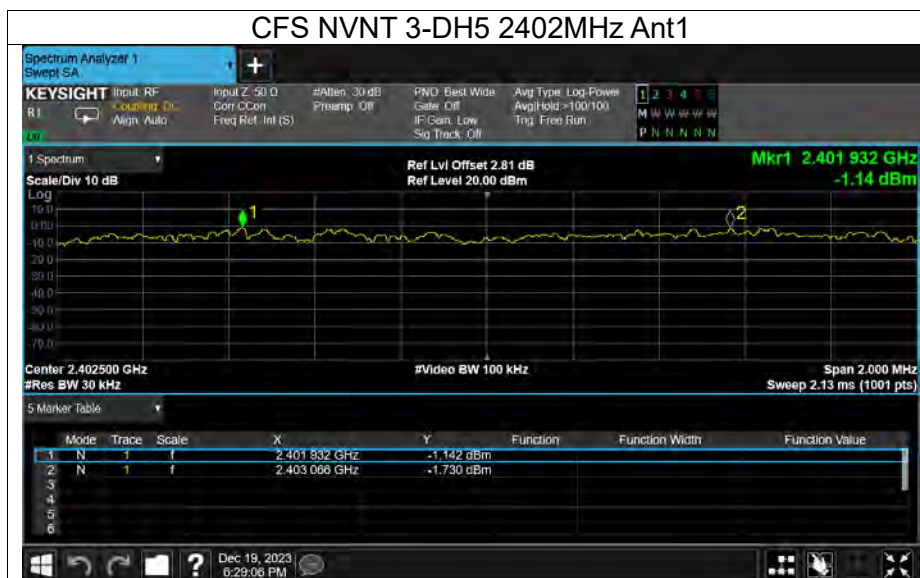



Band Edge

Condition	Mode	Frequency (MHz)	Antenna	Hopping Mode	Max Value (dBc)	Limit (dBc)	Verdict
NVNT	1-DH5	2402	Ant1	No-Hopping	-57.5	-20	Pass
NVNT	1-DH5	2480	Ant1	No-Hopping	-59.22	-20	Pass
NVNT	2-DH5	2402	Ant1	No-Hopping	-51.68	-20	Pass
NVNT	2-DH5	2480	Ant1	No-Hopping	-58	-20	Pass
NVNT	3-DH5	2402	Ant1	No-Hopping	-51.66	-20	Pass
NVNT	3-DH5	2480	Ant1	No-Hopping	-58.59	-20	Pass



Test Graphs

Band Edge NVNT 1-DH5 2402MHz Ant1 No-Hopping Ref



Band Edge NVNT 1-DH5 2402MHz Ant1 No-Hopping Emission



Band Edge NVNT 1-DH5 2480MHz Ant1 No-Hopping Ref





Band Edge NVNT 1-DH5 2480MHz Ant1 No-Hopping Emission

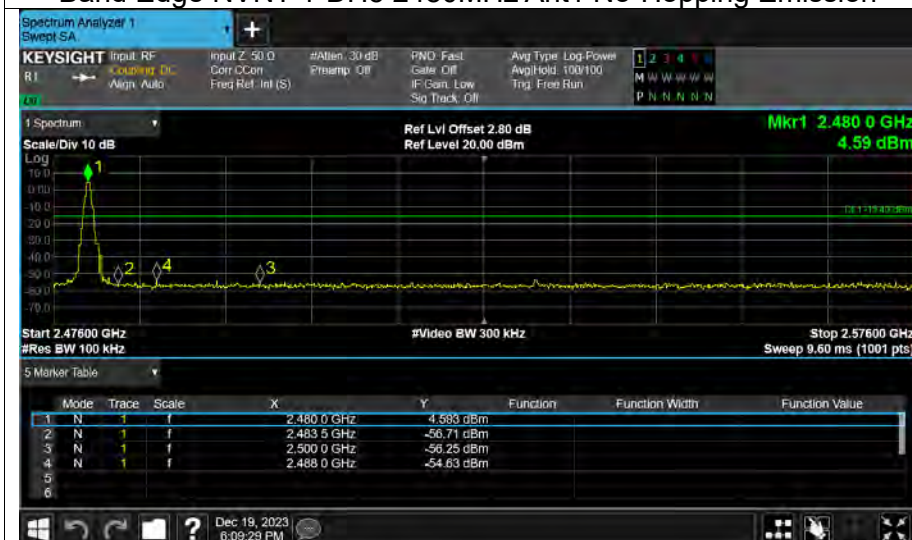

Band Edge NVNT 2-DH5 2402MHz Ant1 No-Hopping Ref



Band Edge NVNT 2-DH5 2402MHz Ant1 No-Hopping Emission

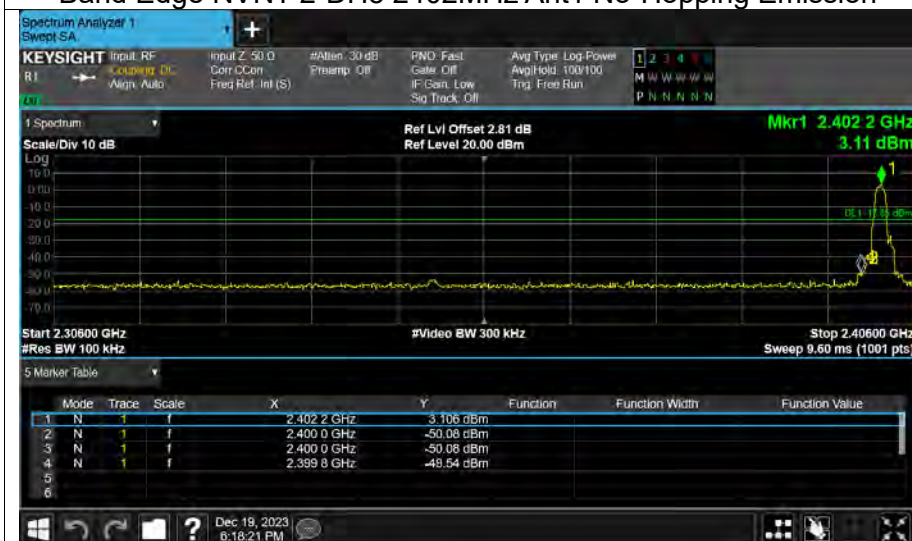



Band Edge NVNT 2-DH5 2480MHz Ant1 No-Hopping Ref

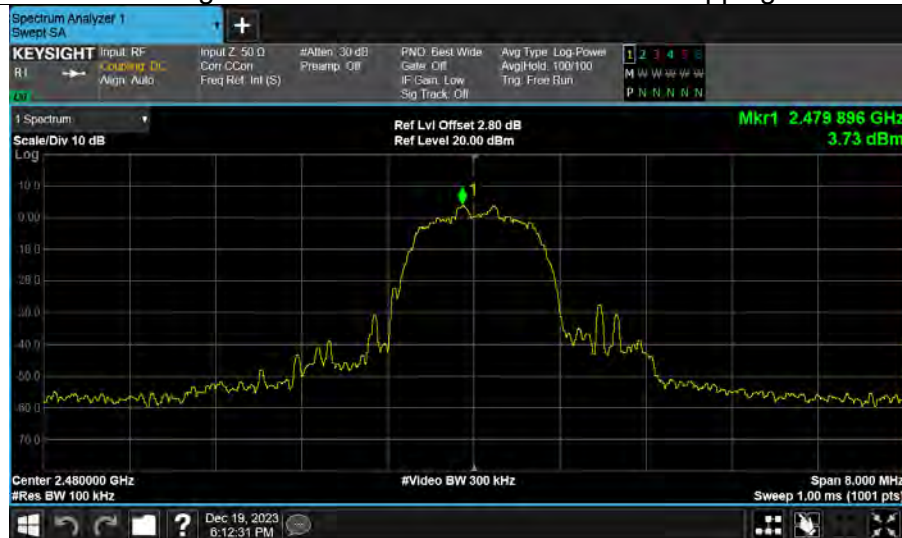

Band Edge NVNT 2-DH5 2480MHz Ant1 No-Hopping Emission



Band Edge NVNT 3-DH5 2402MHz Ant1 No-Hopping Ref





Band Edge NVNT 3-DH5 2402MHz Ant1 No-Hopping Emission



Band Edge NVNT 3-DH5 2480MHz Ant1 No-Hopping Ref



Band Edge NVNT 3-DH5 2480MHz Ant1 No-Hopping Emission

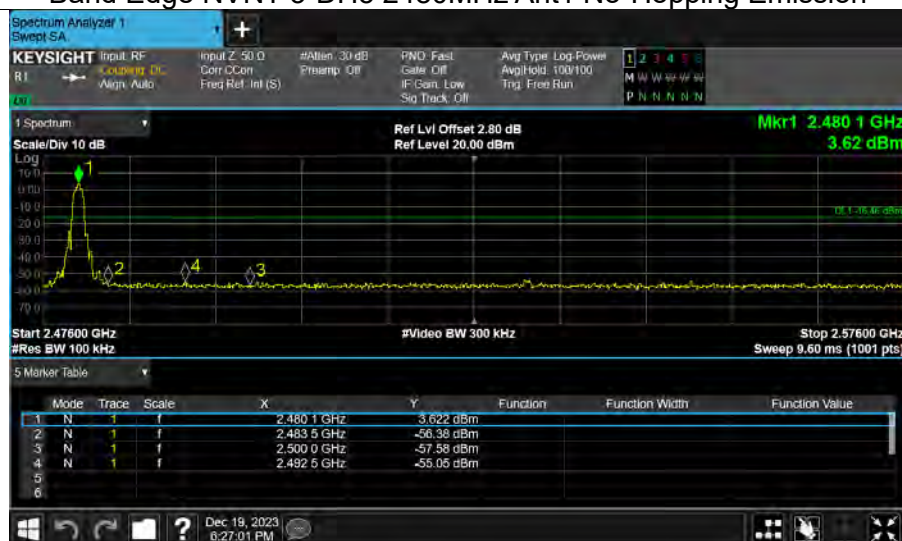



Band Edge(Hopping)

Condition	Mode	Frequency (MHz)	Antenna	Hopping Mode	Max Value (dBc)	Limit (dBc)	Verdict
NVNT	1-DH5	2402	Ant1	Hopping	-50.11	-20	Pass
NVNT	1-DH5	2480	Ant1	Hopping	-51.38	-20	Pass
NVNT	2-DH5	2402	Ant1	Hopping	-50.1	-20	Pass
NVNT	2-DH5	2480	Ant1	Hopping	-51.91	-20	Pass
NVNT	3-DH5	2402	Ant1	Hopping	-52.17	-20	Pass
NVNT	3-DH5	2480	Ant1	Hopping	-52.98	-20	Pass



Test Graphs

Band Edge(Hopping) NVNT 1-DH5 2402MHz Ant1 Hopping Ref



Band Edge(Hopping) NVNT 1-DH5 2402MHz Ant1 Hopping Emission

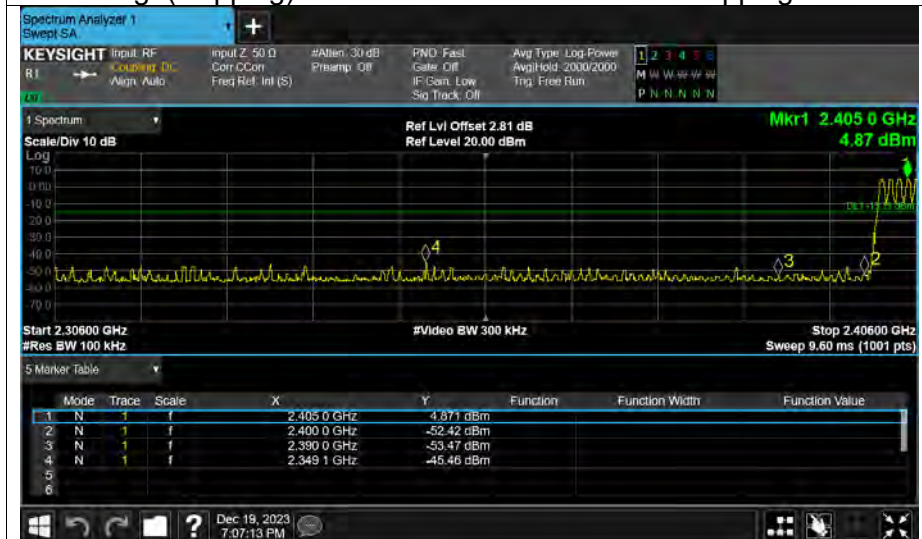

Band Edge(Hopping) NVNT 1-DH5 2480MHz Ant1 Hopping Ref





Band Edge(Hopping) NVNT 1-DH5 2480MHz Ant1 Hopping Emission

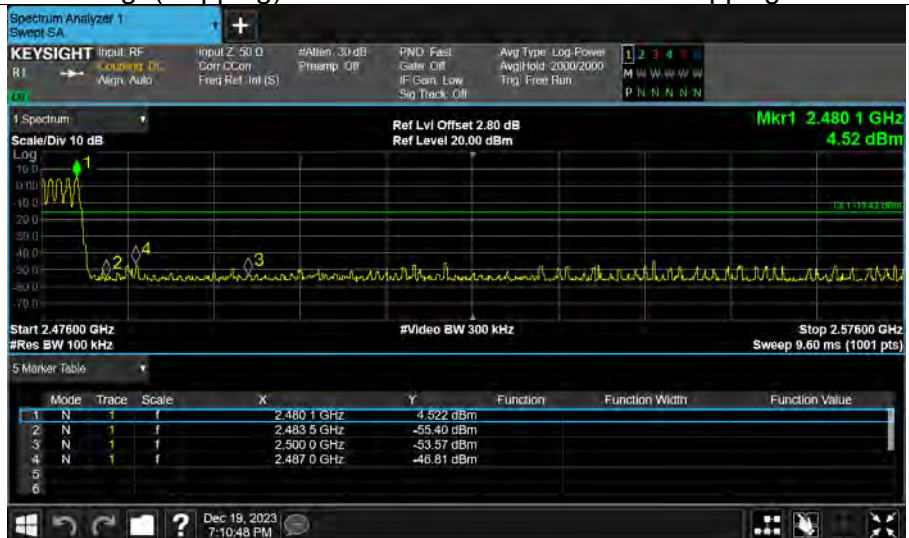

Band Edge(Hopping) NVNT 2-DH5 2402MHz Ant1 Hopping Ref



Band Edge(Hopping) NVNT 2-DH5 2402MHz Ant1 Hopping Emission



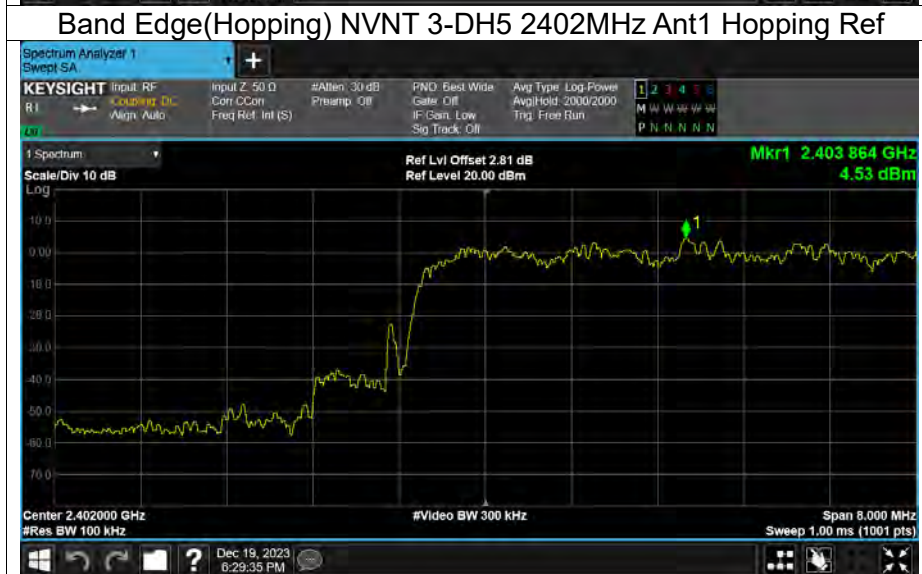
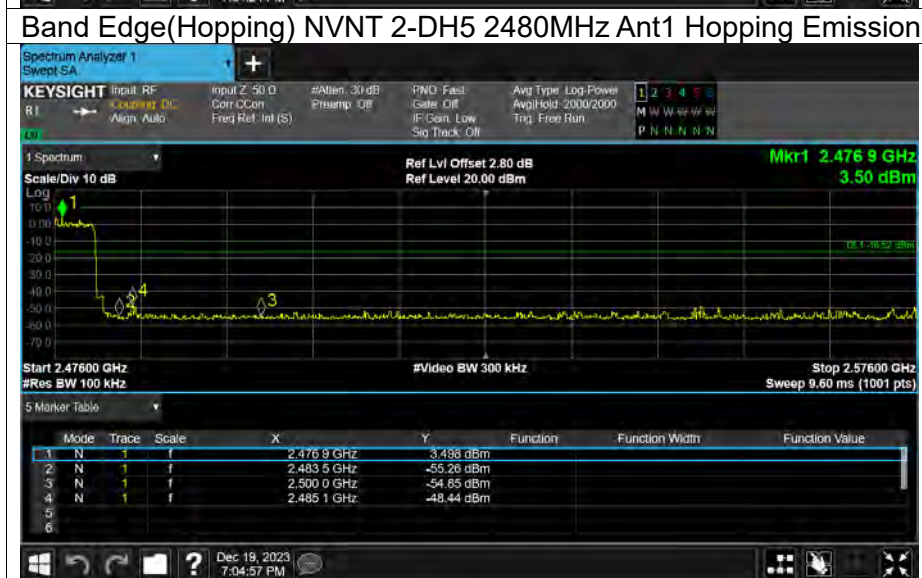
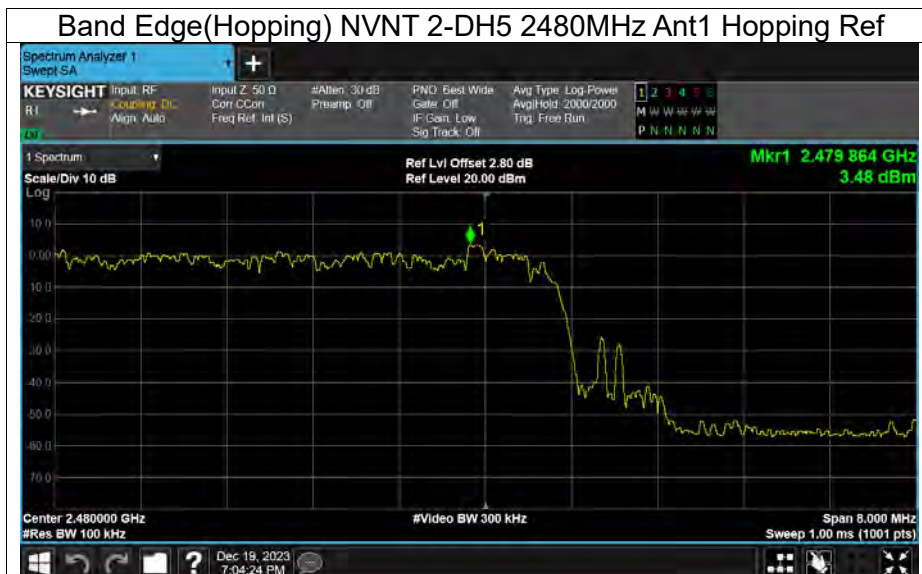



Band Edge(Hopping) NVNT 3-DH5 2402MHz Ant1 Hopping Emission



Band Edge(Hopping) NVNT 3-DH5 2480MHz Ant1 Hopping Ref



Band Edge(Hopping) NVNT 3-DH5 2480MHz Ant1 Hopping Emission

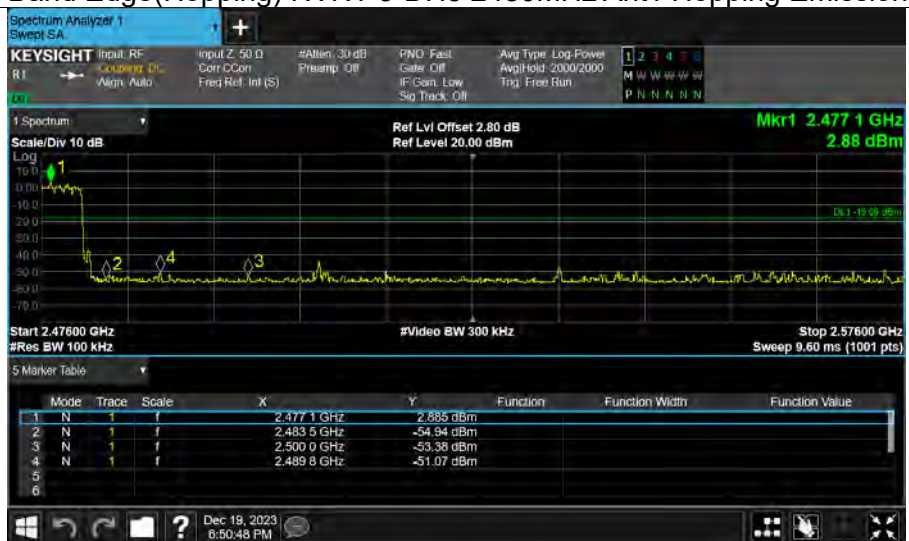



Conducted RF Spurious Emission

Condition	Mode	Frequency (MHz)	Antenna	Max Value (dBc)	Limit (dBc)	Verdict
NVNT	1-DH5	2402	Ant1	-55.72	-20	Pass
NVNT	1-DH5	2441	Ant1	-56	-20	Pass
NVNT	1-DH5	2480	Ant1	-47.16	-20	Pass
NVNT	2-DH5	2402	Ant1	-62.95	-20	Pass
NVNT	2-DH5	2441	Ant1	-45.44	-20	Pass
NVNT	2-DH5	2480	Ant1	-61.84	-20	Pass
NVNT	3-DH5	2402	Ant1	-55.81	-20	Pass
NVNT	3-DH5	2441	Ant1	-54.65	-20	Pass
NVNT	3-DH5	2480	Ant1	-56.95	-20	Pass



Test Graphs

Tx. Spurious NVNT 1-DH5 2402MHz Ant1 Ref

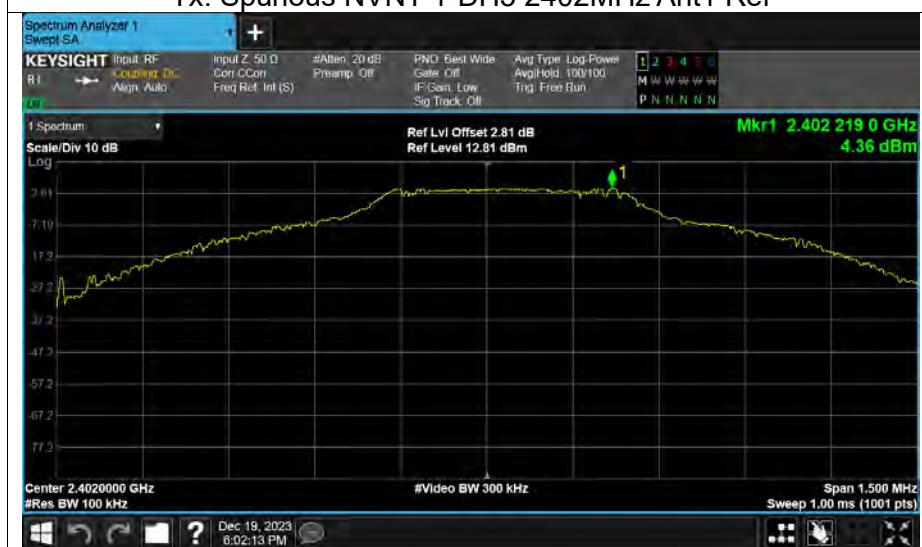

Tx. Spurious NVNT 1-DH5 2402MHz Ant1 Emission

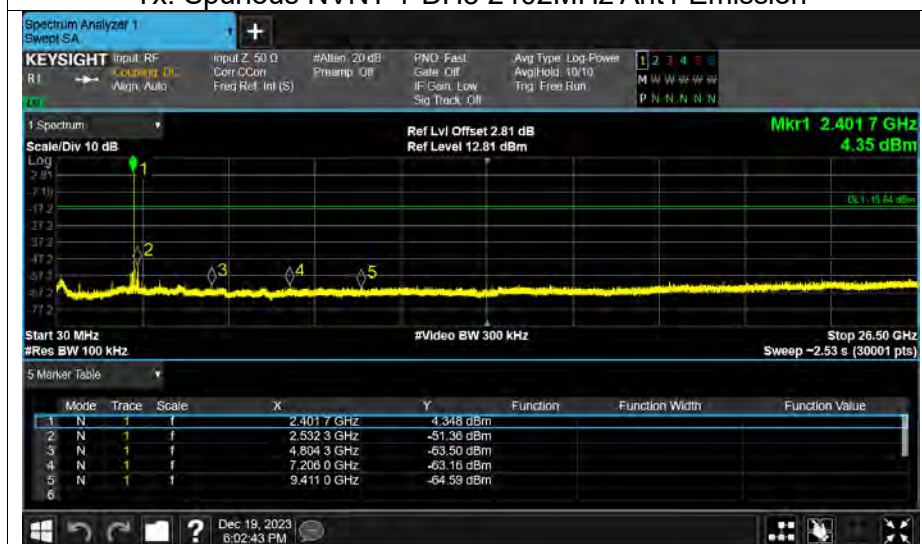

Tx. Spurious NVNT 1-DH5 2441MHz Ant1 Ref

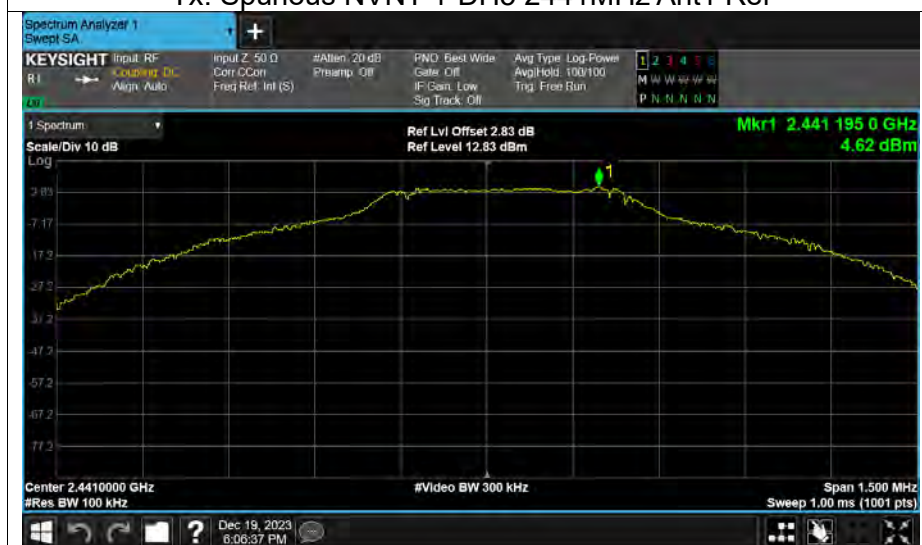

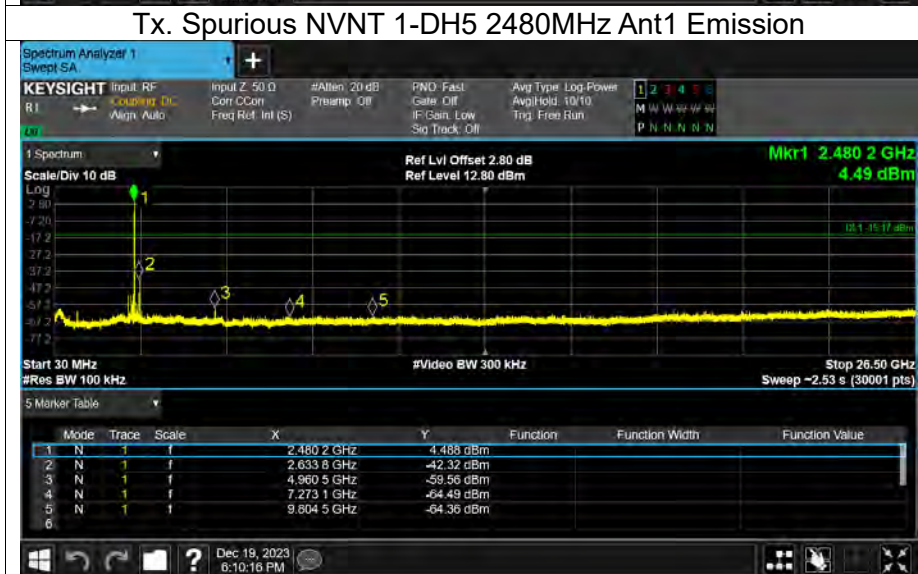
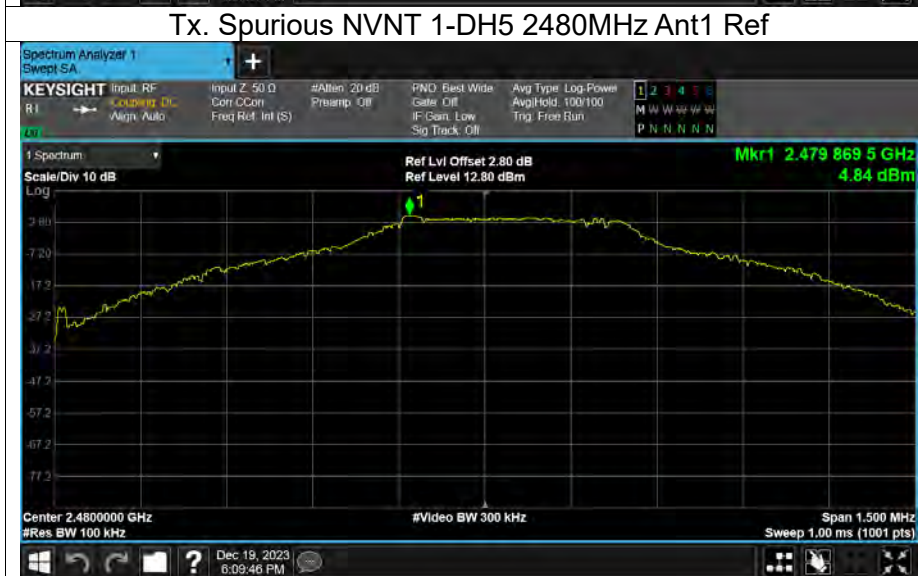
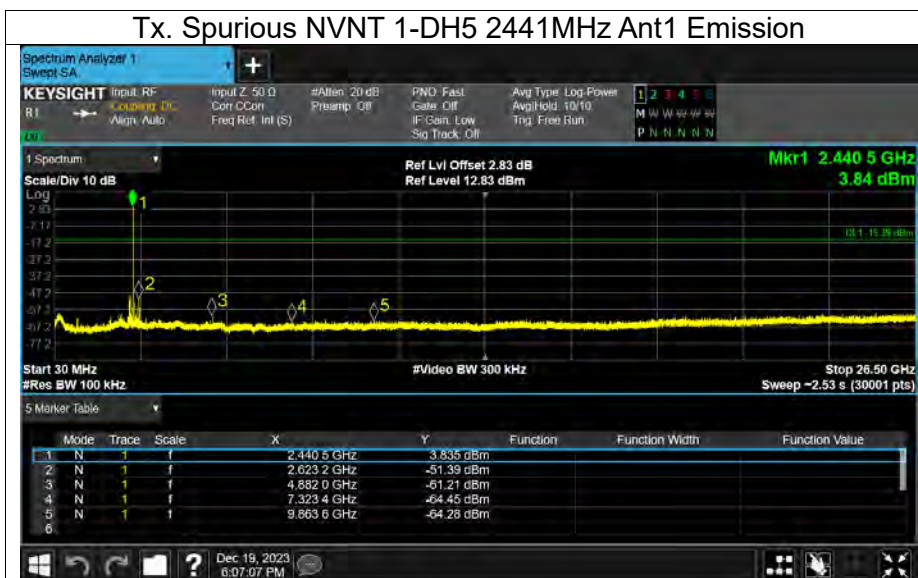

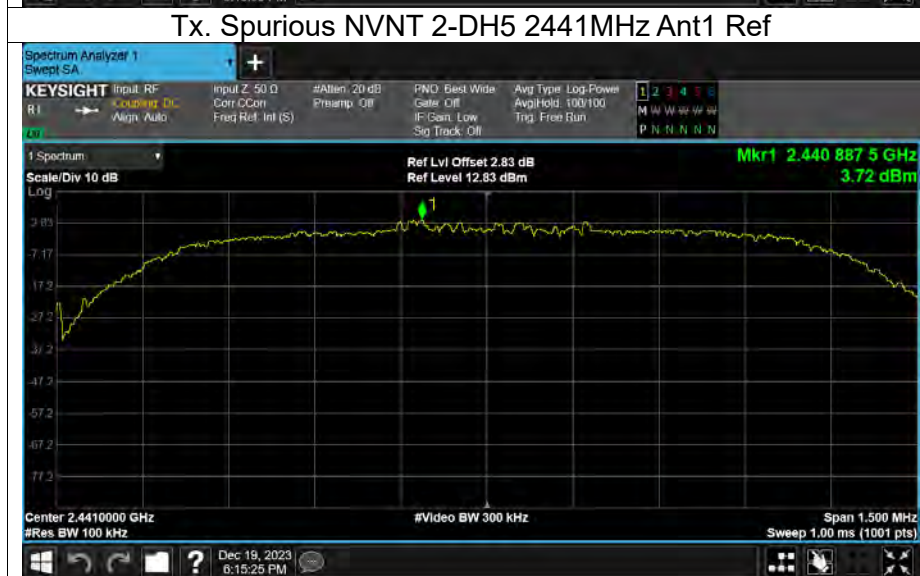
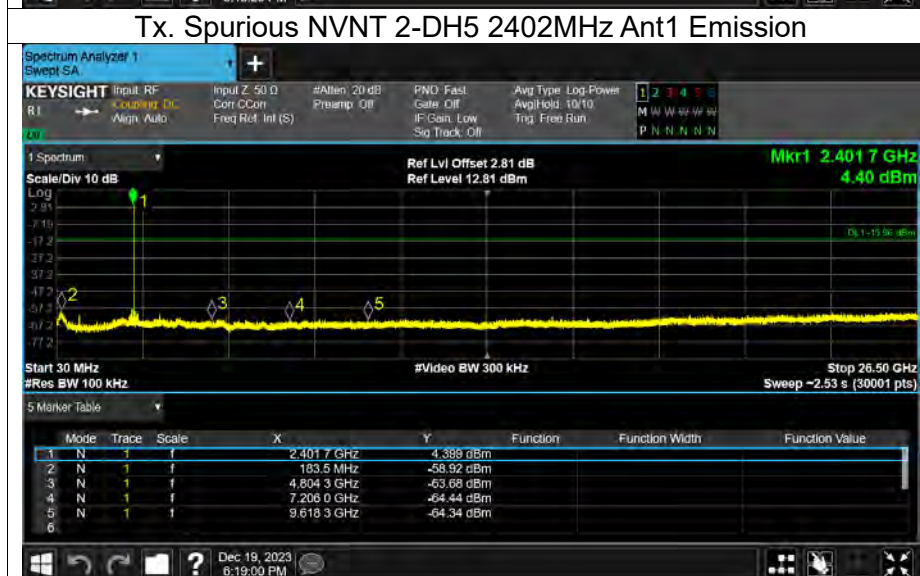
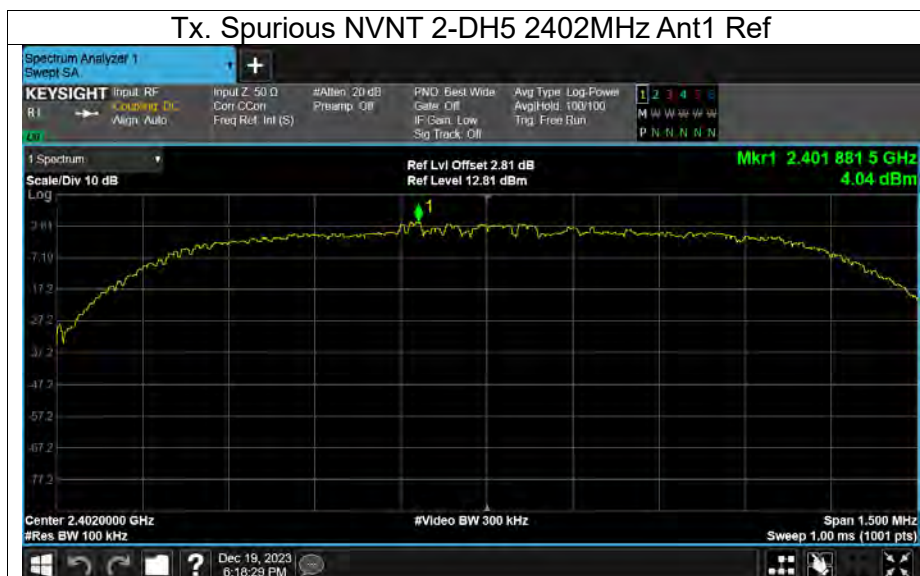

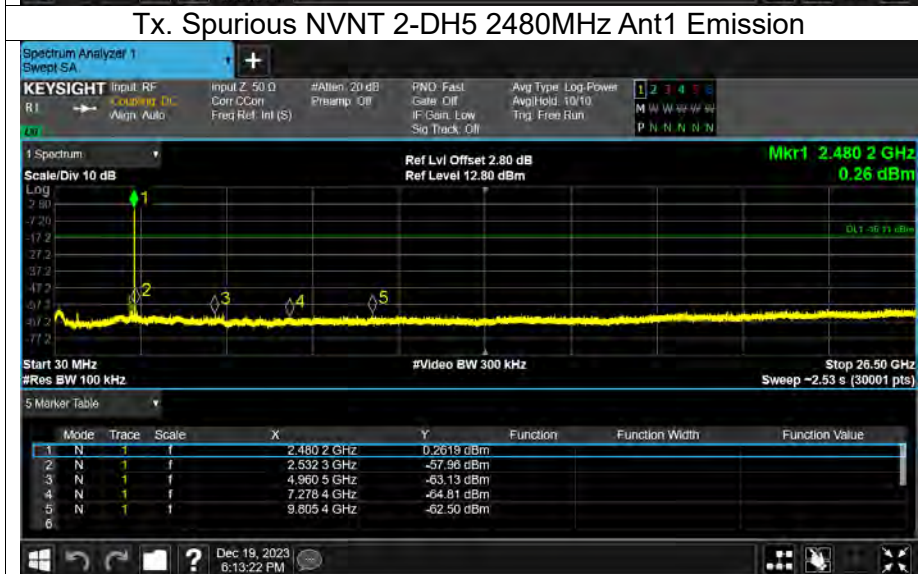
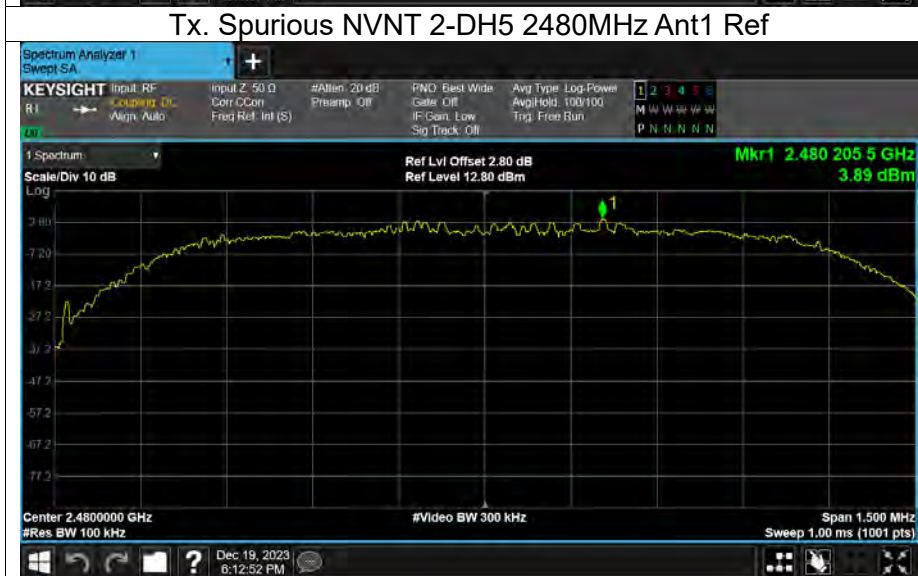
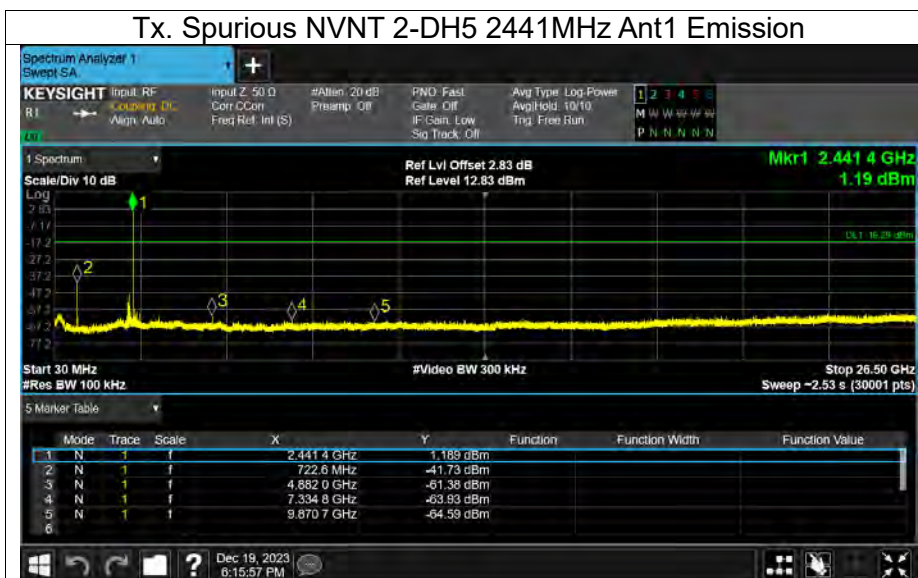

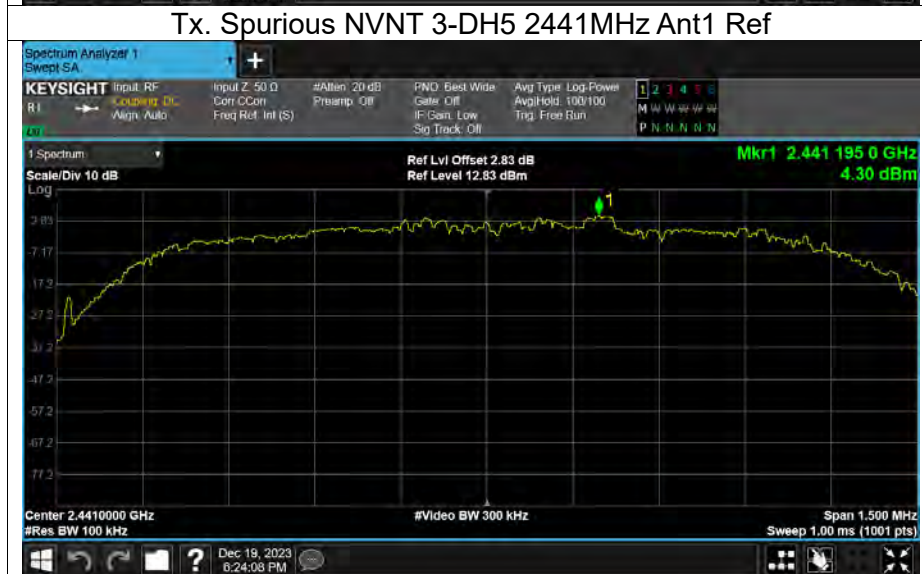
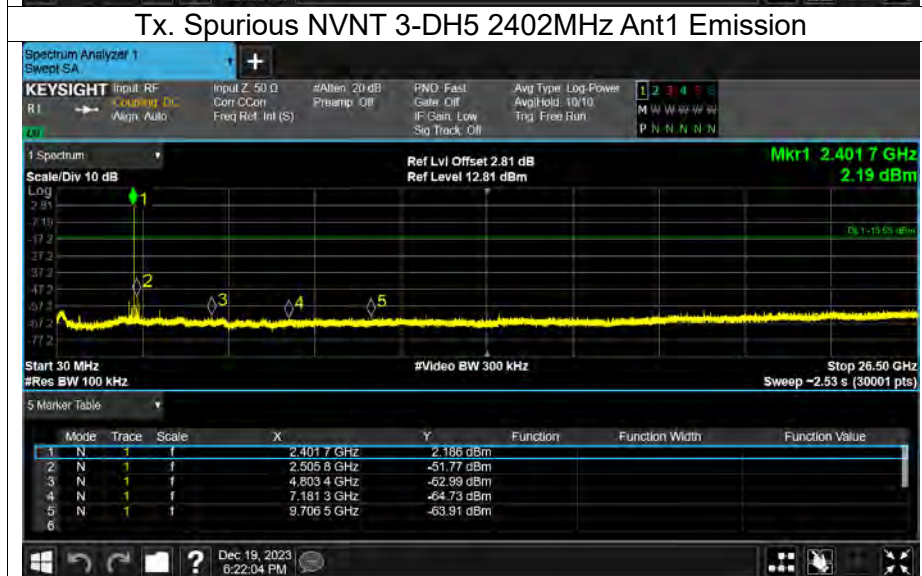
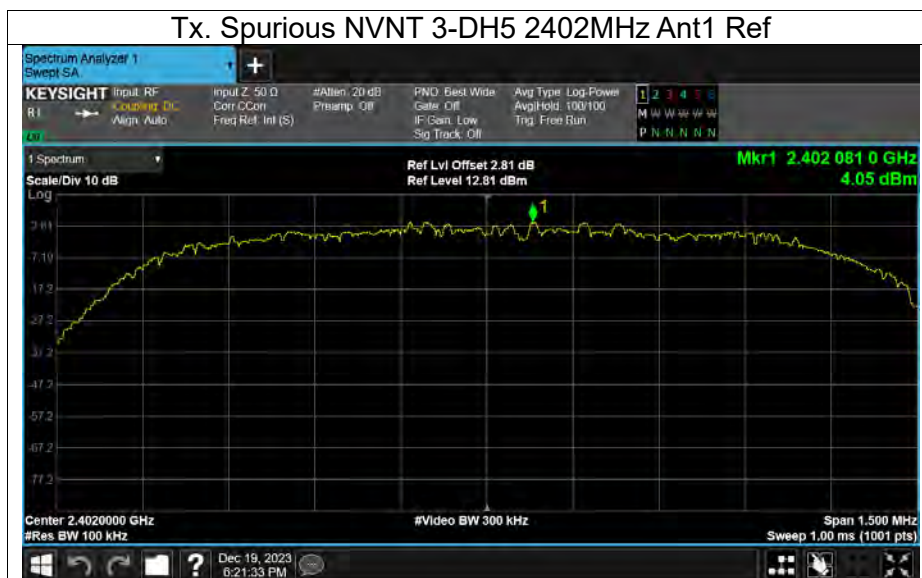

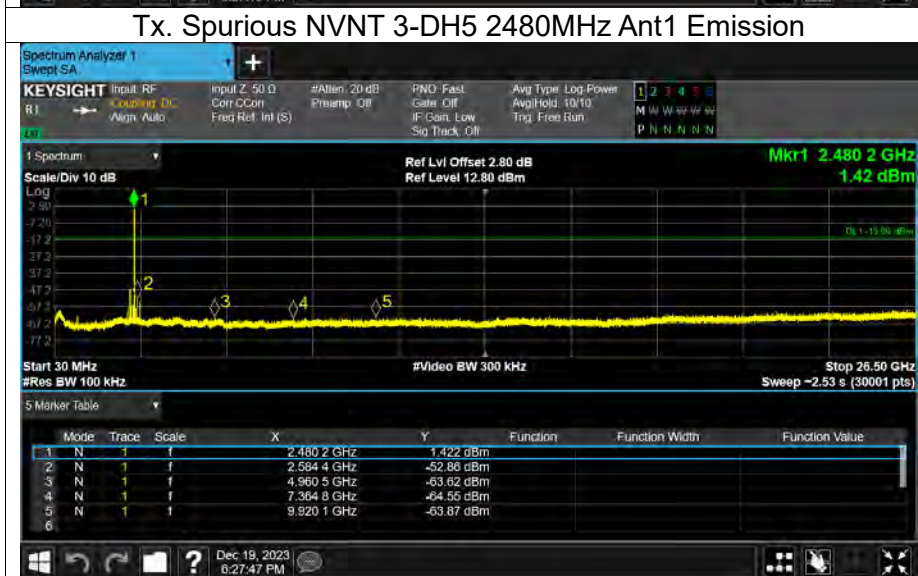
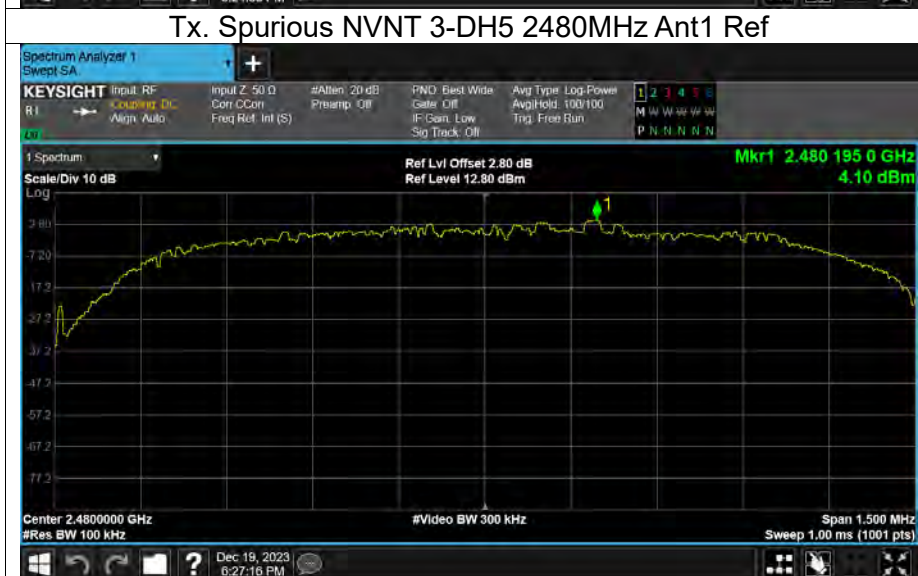
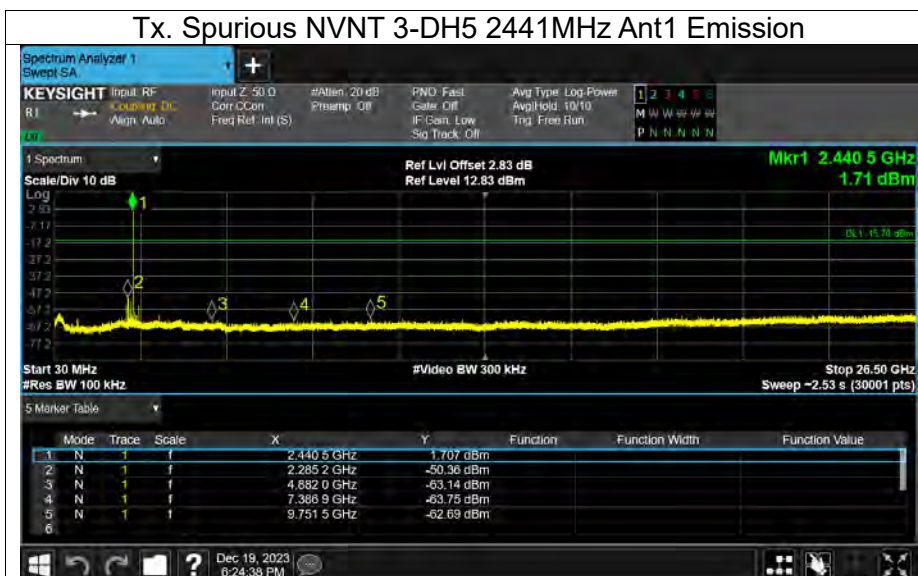



Number of Hopping Channel

Condition	Mode	Antenna	Hopping Number	Limit	Verdict
NVNT	1-DH5	Ant1	79	15	Pass
NVNT	2-DH5	Ant1	79	15	Pass
NVNT	3-DH5	Ant1	79	15	Pass



Test Graphs

Hopping No. NVNT 1-DH5 2441MHz Ant1

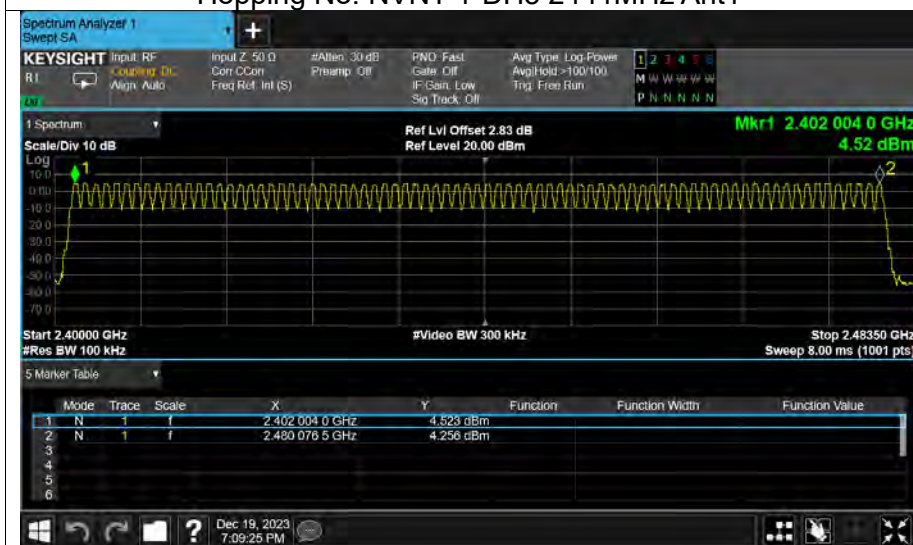

Hopping No. NVNT 2-DH5 2441MHz Ant1

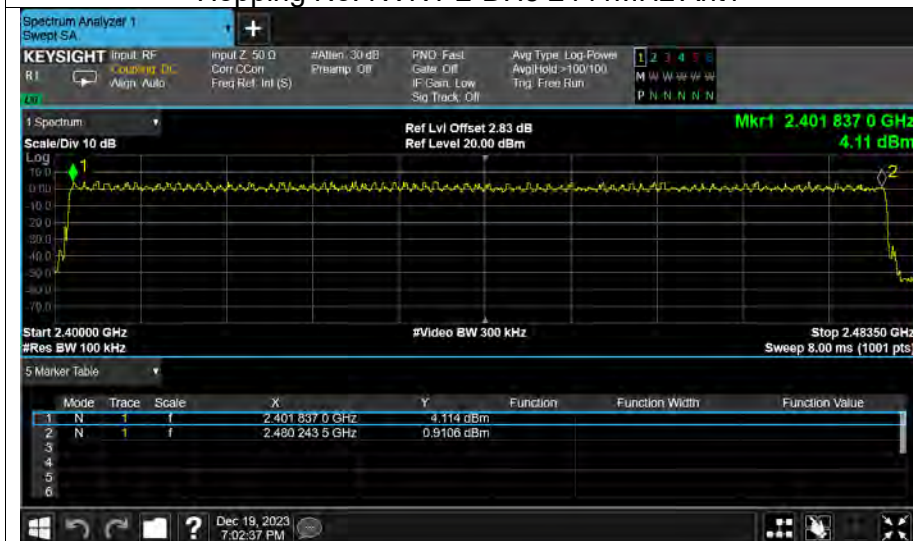

Hopping No. NVNT 3-DH5 2441MHz Ant1

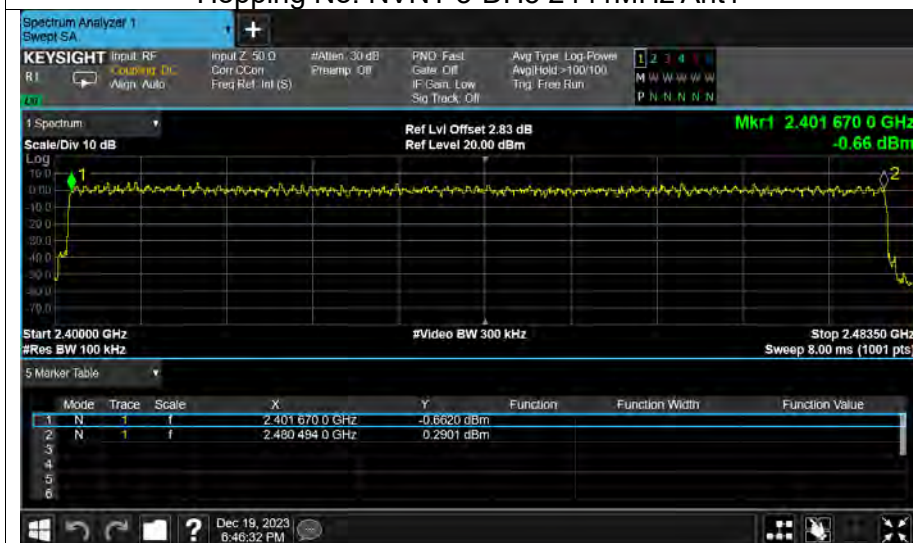



Dwell Time

Condition	Mode	Frequency (MHz)	Antenna	Pulse Time (ms)	Total Dwell Time (ms)	Burst Count	Period Time (ms)	Limit (ms)	Verdict
NVNT	1-DH5	2441	Ant1	2.895	327.135	113	31600	400	Pass
NVNT	2-DH5	2441	Ant1	2.883	285.417	99	31600	400	Pass
NVNT	3-DH5	2441	Ant1	2.882	262.262	91	31600	400	Pass



Test Graphs

Dwell NVNT 1-DH5 2441MHz Ant1 One Burst

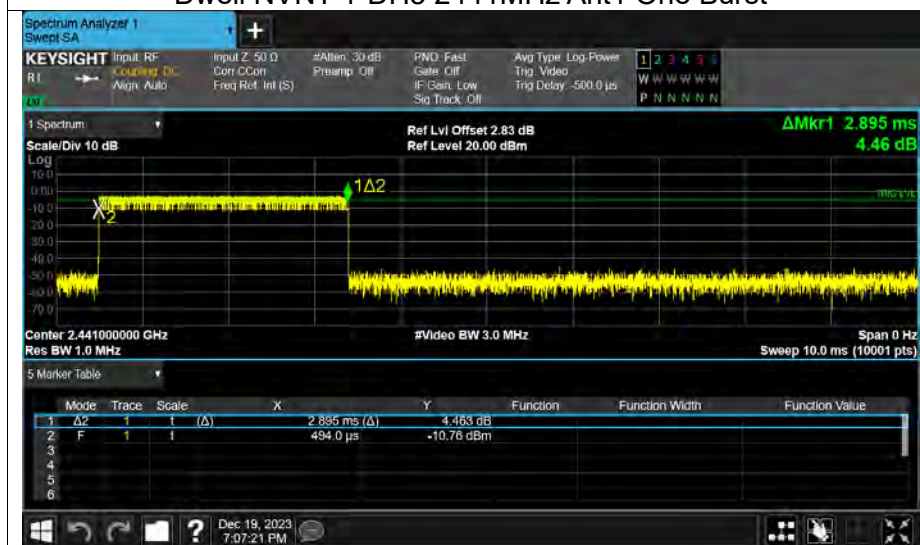

Dwell NVNT 1-DH5 2441MHz Ant1 Accumulated



Dwell NVNT 2-DH5 2441MHz Ant1 One Burst

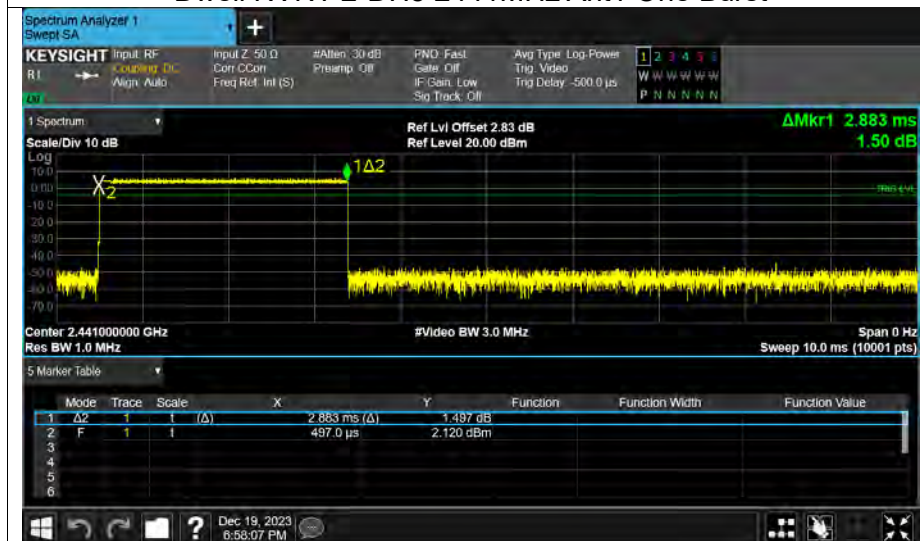

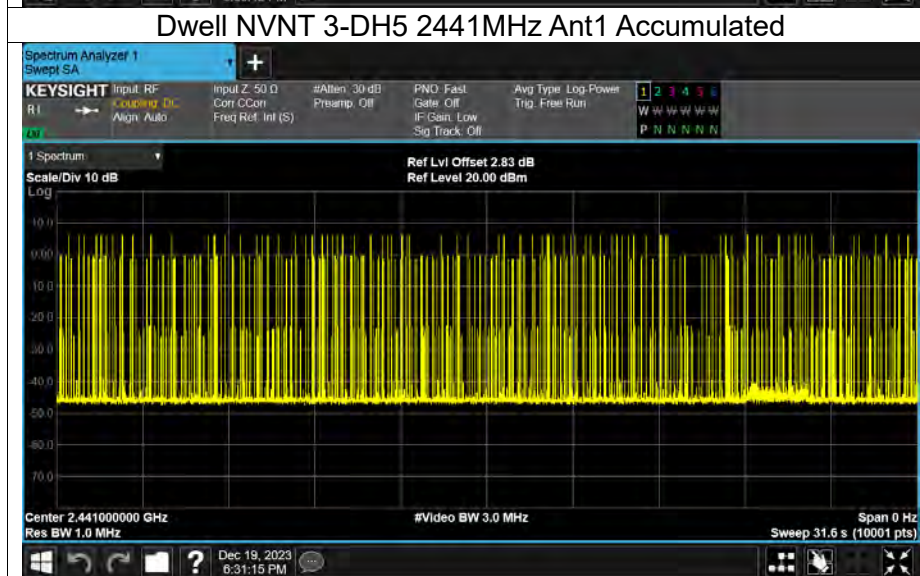
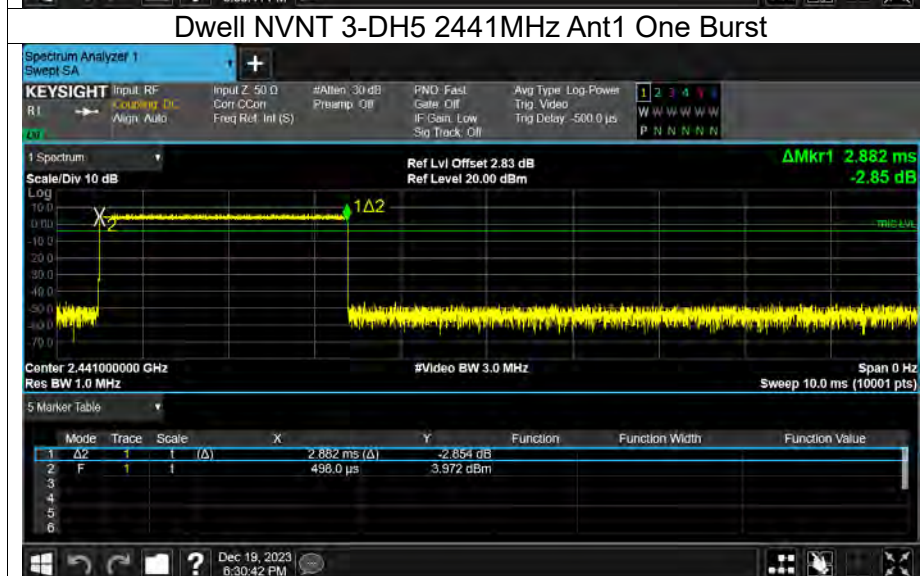
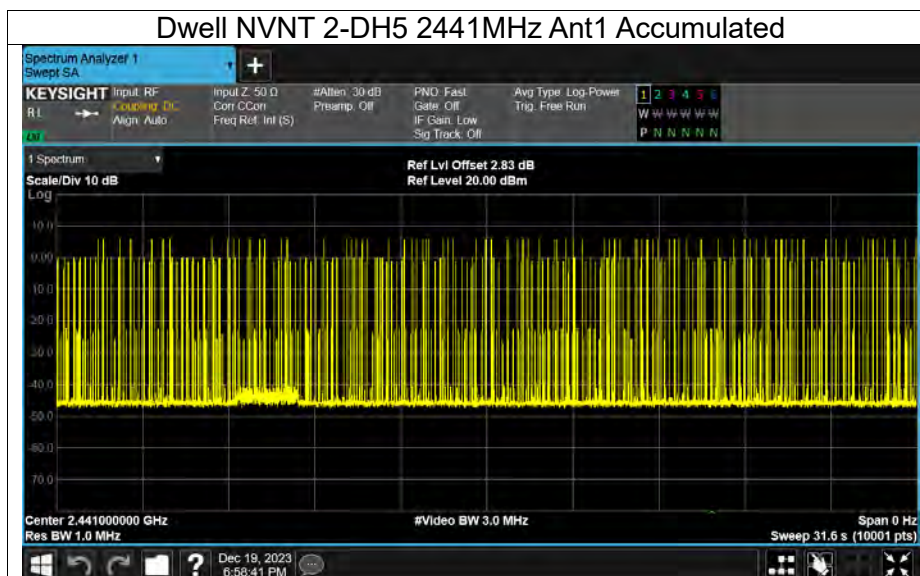

*****END OF THE REPORT*****