

FCC SAR EVALUATION REPORT

In accordance with the requirements of
FCC 47 CFR Part 2(2.1093), ANSI/IEEE C95.1-1992 and
IEEE Std 1528-2013

Product Name : 2G flip phone

Brand Name : LOGIC, ISWAG, UNONU

Model Name : LOGIC F11

Family Model : Folder, U28

Report No. : STR230328003004E

FCC ID : O55181823

Prepared for

SWAGTEK

10205 NW 19th Street STE101 Miami, FL 33172, United States

Prepared by

Shenzhen NTEK Testing Technology Co., Ltd.

1/F, Building E, Fenda Science Park, Sanwei Community, Xixiang Street,

Bao'an District, Shenzhen 518126 P.R.China.

Tel.: 400-800-6106, 0755-2320 0050, 0755-2320 0090

Website: <http://www.ntek.org.cn>

TEST RESULT CERTIFICATION

Applicant's name : SWAGTEK
Address..... : 10205 NW 19th Street STE101 Miami, FL 33172,United States
Manufacturer's Name : SWAGTEK
Address..... : 10205 NW 19th Street STE101 Miami, FL 33172,United States

Product description

Product name : 2G flip phone
Trademark : LOGIC, ISWAG, UNONU
Model Name : LOGIC F11
Family Model : Folder, U28

Standards : FCC 47 CFR Part 2(2.1093)
ANSI/IEEE C95.1-1992;
IEEE Std 1528-2013
Published RF exposure KDB procedures

This device described above has been tested by Shenzhen NTEK. In accordance with the measurement methods and procedures specified in IEEE Std 1528-2013 and KDB 865664 D01. Testing has shown that this device is capable of compliance with localized specific absorption rate (SAR) specified in FCC 47 CFR Part 2(2.1093) and ANSI/IEEE C95.1-1992. The test results in this report apply only to the tested sample of the stated device/equipment. Other similar device/equipment will not necessarily produce the same results due to production tolerance and measurement uncertainties.

This report shall not be reproduced except in full, without the written approval of Shenzhen NTEK, this document may be altered or revised by Shenzhen NTEK, personal only, and shall be noted in the revision of the document.

Test Sample Number T230328002R003

Date of Test

Date (s) of performance of tests.....: Apr. 03, 2023 ~ Apr. 04, 2023
Date of Issue: May. 06, 2023
Test Result.....: **Pass**

Prepared By : Jack Li
(Test Engineer) :
(Jack Li)

Approved By : Alex
(Lab Manager) :
(Alex Li)

※ ※ Revision History ※ ※

| REV. | DESCRIPTION | ISSUED DATE | REMARK |
|---------|-----------------------------|---------------|---------|
| Rev.1.0 | Initial Test Report Release | May. 06, 2023 | Jack Li |
| | | | |
| | | | |
| | | | |

TABLE OF CONTENTS

| | |
|--|----|
| 1. General Information | 6 |
| 1.1. RF exposure limits..... | 6 |
| 1.2. Statement of Compliance | 7 |
| 1.3. EUT Description | 7 |
| 1.4. Test specification(s) | 9 |
| 1.5. Ambient Condition..... | 9 |
| 2. SAR Measurement System | 10 |
| 2.1. SATIMO SAR Measurement Set-up Diagram | 10 |
| 2.2. Robot | 11 |
| 2.3. E-Field Probe..... | 12 |
| 2.3.1. E-Field Probe Calibration | 12 |
| 2.4. SAM phantoms | 13 |
| 2.4.1. Technical Data | 14 |
| 2.5. Device Holder | 15 |
| 2.6. Test Equipment List | 16 |
| 3. SAR Measurement Procedures | 18 |
| 3.1. Power Reference | 18 |
| 3.2. Area scan & Zoom scan..... | 18 |
| 3.3. Description of interpolation/extrapolation scheme | 20 |
| 3.4. Volumetric Scan | 20 |
| 3.5. Power Drift | 20 |
| 4. System Verification Procedure | 21 |
| 4.1. Tissue Verification | 21 |
| 4.1.1. Tissue Dielectric Parameter Check Results | 22 |
| 4.2. System Verification Procedure | 23 |
| 4.2.1. System Verification Results..... | 24 |
| 5. SAR Measurement variability and uncertainty | 25 |
| 5.1. SAR measurement variability..... | 25 |
| 5.2. SAR measurement uncertainty | 25 |
| 6. RF Exposure Positions..... | 26 |
| 6.1. Ear and handset reference point | 26 |
| 6.2. Definition of the cheek position | 26 |
| 6.3. Definition of the tilt position | 28 |
| 6.4. Body Worn Accessory | 28 |
| 7. RF Output Power | 30 |
| 7.1. GSM Conducted Power | 30 |
| 7.2. Bluetooth Output Power..... | 30 |
| 8. Stand-alone SAR test exclusion..... | 31 |
| 9. SAR Results | 32 |

| | |
|--|----|
| 9.1. SAR measurement Result..... | 32 |
| 9.1.1. SAR measurement Result of GSM850..... | 32 |
| 9.1.2. SAR measurement Result of GSM1900..... | 32 |
| 9.2. Simultaneous Transmission Analysis..... | 33 |
| 10. Appendix A. Photo documentation | 33 |
| 11. Appendix B. System Check Plots..... | 34 |
| 12. Appendix C. Plots of High SAR Measurement..... | 39 |
| 13. Appendix D. Calibration Certificate | 48 |

1. General Information

1.1. RF exposure limits

(A).Limits for Occupational/Controlled Exposure (W/kg)

| Whole-Body | Partial-Body | Hands, Wrists, Feet and Ankles |
|------------|--------------|--------------------------------|
| 0.4 | 8.0 | 20.0 |

(B).Limits for General Population/Uncontrolled Exposure (W/kg)

| Whole-Body | Partial-Body | Hands, Wrists, Feet and Ankles |
|------------|--------------|--------------------------------|
| 0.08 | 1.6 | 4.0 |

NOTE: **Whole-Body SAR** is averaged over the entire body, **partial-body SAR** is averaged over any 1 gram of tissue defined as a tissue volume in the shape of a cube. **SAR for hands, wrists, feet and ankles** is averaged over any 10 grams of tissue defined as a tissue volume in the shape of a cube.

Occupational/Controlled Environments:

Are defined as locations where there is exposure that may be incurred by people who are aware of the potential for exposure, (i.e. as a result of employment or occupation).

General Population/Uncontrolled Environments:

Are defined as locations where there is the exposure of individuals who have no knowledge or control of their exposure.

NOTE
 HEAD AND TRUNK LIMIT
 1.6 W/kg
 APPLIED TO THIS EUT

1.2. Statement of Compliance

The maximum results of Specific Absorption Rate (SAR) found during testing for LOGIC F11 are as follows.

| RF Exposure Conditions | | Equipment Class -Highest Reported SAR (W/kg) | | | |
|--|-----------|--|-----|-----|-------|
| | | PCE | DTS | NII | DSS |
| 1-g Head | | 0.583 | N/A | N/A | N/A |
| 1-g Body-Worn (Separation distance of 10mm) | | 0.627 | N/A | N/A | N/A |
| Max Simultaneous Tx | Head | 0.876 | N/A | N/A | 0.876 |
| | Body-Worn | 0.773 | N/A | N/A | 0.773 |

Note: The Max Simultaneous Tx is calculated based on the same configuration and test position.

This device is in compliance with Specific Absorption Rate (SAR) for general population/uncontrolled exposure limits (1.6 W/kg) specified in FCC 47 CFR Part 2(2.1093) and ANSI/IEEE C95.1-1992, and had been tested in accordance with the measurement methods and procedures specified in IEEE Std 1528-2013 & KDB 865664 D01.

1.3. EUT Description

| Device Information | | | |
|---------------------------------|--|-----------|-----------|
| Product Name | 2G flip phone | | |
| Brand Name | LOGIC, ISWAG, UNONU | | |
| Model Name | LOGIC F11 | | |
| Family Model | Folder, U28 | | |
| Model Difference | All the model are the same circuit and RF module,except the Model names. | | |
| FCC ID | O55181823 | | |
| Device Phase | Identical Prototype | | |
| Exposure Category | General population / Uncontrolled environment | | |
| Antenna Type | PIFA Antenna | | |
| Battery Information | DC 3.7V, 800mAh | | |
| HW Version | M28_MB_V3.0 | | |
| SW Version | LOGIC_F11_TIGO_GT | | |
| Device Operating Configurations | | | |
| Supporting Mode(s) | GSM 850/1900, Bluetooth | | |
| Test Modulation | GSM(GMSK), Bluetooth(GFSK, $\pi/4$ -DQPSK, 8DPSK) | | |
| Device Class | B | | |
| Operating Frequency Range(s) | Band | Tx (MHz) | Rx (MHz) |
| | GSM 850 | 824-849 | 869-894 |
| | GSM 1900 | 1850-1910 | 1930-1990 |

| | | |
|-------------|--|-----------|
| | Bluetooth | 2402-2480 |
| Power Class | 4, tested with power level 5(GSM 850) | |
| | 1, tested with power level 0(GSM 1900) | |

1.4. Test specification(s)

| |
|---|
| FCC 47 CFR Part 2(2.1093) |
| ANSI/IEEE C95.1-1992 |
| IEEE Std 1528-2013 |
| KDB 865664 D01 SAR measurement 100 MHz to 6 GHz |
| KDB 865664 D02 RF Exposure Reporting |
| KDB 447498 D01 General RF Exposure Guidance |
| KDB 648474 D04 Handset SAR |

1.5. Ambient Condition

| | |
|---------------------|-------------|
| Ambient temperature | 20°C – 24°C |
| Relative Humidity | 30% – 70% |

2. SAR Measurement System

2.1. SATIMO SAR Measurement Set-up Diagram

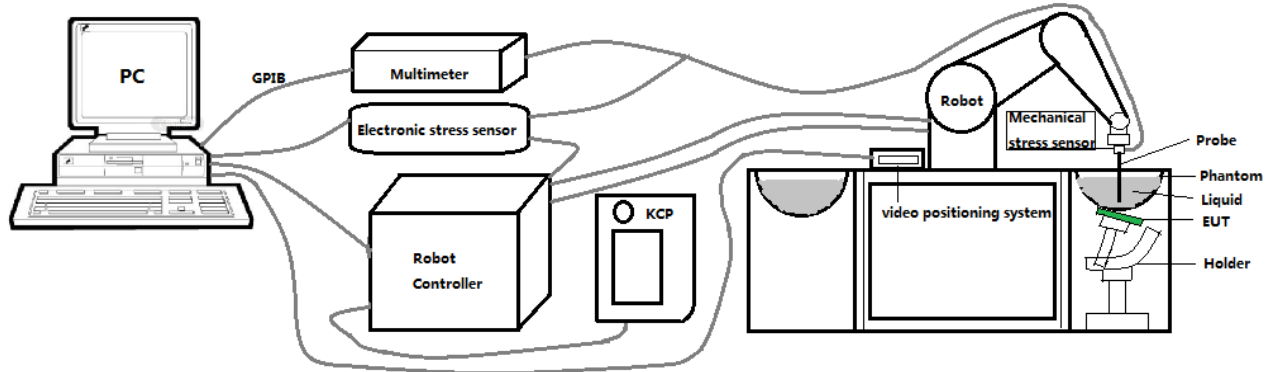

These measurements were performed with the automated near-field scanning system OPENSAR from SATIMO. The system is based on a high precision robot (working range: 901 mm), which positions the probes with a positional repeatability of better than ± 0.03 mm. The SAR measurements were conducted with dosimetric probe (manufactured by SATIMO), designed in the classical triangular configuration and optimized for dosimetric evaluation.

The first step of the field measurement is the evaluation of the voltages induced on the probe by the device under test. Probe diode detectors are nonlinear. Below the diode compression point, the output voltage is proportional to the square of the applied E-field; above the diode compression point, it is linear to the applied E-field. The compression point depends on the diode, and a calibration procedure is necessary for each sensor of the probe.

The Keithley multimeter reads the voltage of each sensor and send these three values to the PC. The corresponding E field value is calculated using the probe calibration factors, which are stored in the working directory. This evaluation includes linearization of the diode characteristics. The field calculation is done separately for each sensor. Each component of the E field is displayed on the "Dipole Area Scan Interface" and the total E field is displayed on the "3D Interface"

2.2. Robot

The SATIMO SAR system uses the high precision robots from KUKA. For the 6-axis controller system, the robot controller version (KUKA) from KUKA is used. The KUKA robot series have many features that are important for our application:



- High precision (repeatability ± 0.03 mm)
- High reliability (industrial design)
- Jerk-free straight movements
- Low ELF interference (the closed metallic construction shields against motor control fields)

2.3. E-Field Probe

This E-field detection probe is composed of three orthogonal dipoles linked to special Schottky diodes with low detection thresholds. The probe allows the measurement of electric fields in liquids such as the one defined in the IEEE and CENELEC standards.

For the measurements the Specific Dosimetric E-Field Probe SN 08/16 EPGO287 with following specifications is used



- Dynamic range: 0.01-100 W/kg
 - Tip Diameter : 2.5 mm
 - Distance between probe tip and sensor center: 1 mm
 - Distance between sensor center and the inner phantom surface: 2 mm (repeatability better than ± 1 mm).
 - Probe linearity: ± 0.08 dB
 - Axial isotropy: ± 0.01 dB
 - Hemispherical Isotropy: ± 0.01 dB
 - Calibration range: 650MHz to 5900MHz for head & body simulating liquid.
 - Lower detection limit: 8mW/kg
- Angle between probe axis (evaluation axis) and surface normal line: less than 30° .

2.3.1. E-Field Probe Calibration

Each probe needs to be calibrated according to a dosimetric assessment procedure with accuracy better than $\pm 10\%$. The spherical isotropy shall be evaluated and within ± 0.25 dB. The sensitivity parameters (Norm X, Norm Y, and Norm Z), the diode compression parameter (DCP) and the conversion factor (Conv F) of the probe are tested. The calibration data can be referred to appendix D of this report.

2.4. SAM phantoms

Photo of SAM phantom SN 16/15 SAM119



The SAM phantom is used to measure the SAR relative to people exposed to electro-magnetic field radiated by mobile phones.

2.4.1. Technical Data

| Serial Number | Shell thickness | Filling volume | Dimensions | Positionner Material | Permittivity | Loss Tangent |
|-----------------|-----------------|----------------|---|-------------------------|--------------|--------------|
| SN 16/15 SAM119 | 2 mm ±0.2 mm | 27 liters | Length:1000 mm Width:500 mm Height:200 mm | Gelcoat with fiberglass | 3.4 | 0.02 |

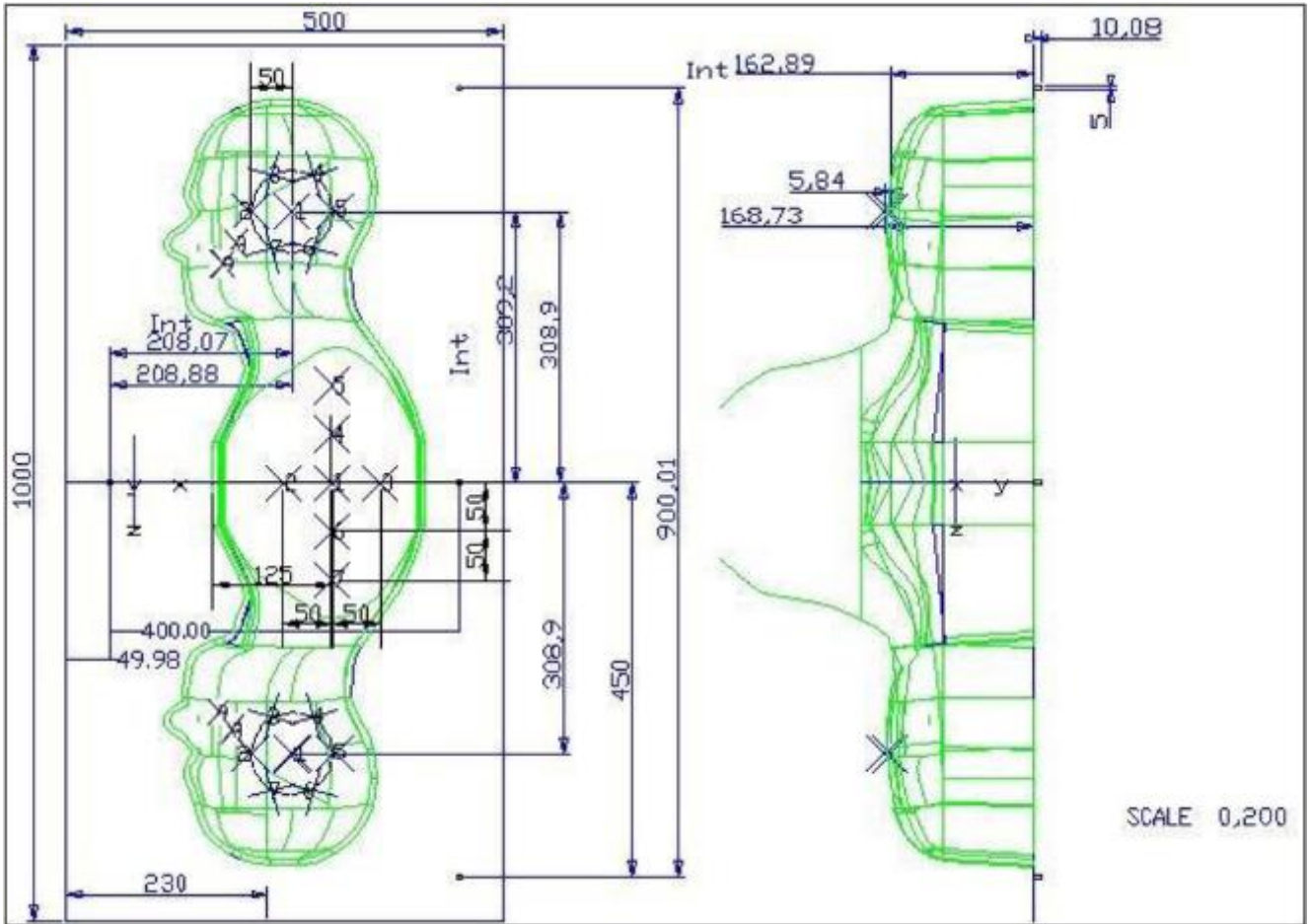

| Serial Number | Left Head(mm) | | Right Head(mm) | | Flat Part(mm) | |
|-----------------|---------------|------|----------------|------|---------------|------|
| | 1 | 2 | 1 | 2 | 1 | 2 |
| SN 16/15 SAM119 | 2 | 2.02 | 2 | 2.08 | 1 | 2.09 |
| | 3 | 2.05 | 3 | 2.06 | 2 | 2.06 |
| | 4 | 2.07 | 4 | 2.07 | 3 | 2.08 |
| | 5 | 2.08 | 5 | 2.08 | 4 | 2.10 |
| | 6 | 2.05 | 6 | 2.07 | 5 | 2.10 |
| | 7 | 2.05 | 7 | 2.05 | 6 | 2.07 |
| | 8 | 2.07 | 8 | 2.06 | 7 | 2.07 |
| | 9 | 2.08 | 9 | 2.06 | - | - |

The test, based on ultrasonic system, allows measuring the thickness with an accuracy of 10 µm.

2.5. Device Holder

The positioning system allows obtaining cheek and tilting position with a very good accuracy. In compliance with CENELEC, the tilt angle uncertainty is lower than 1 degree.

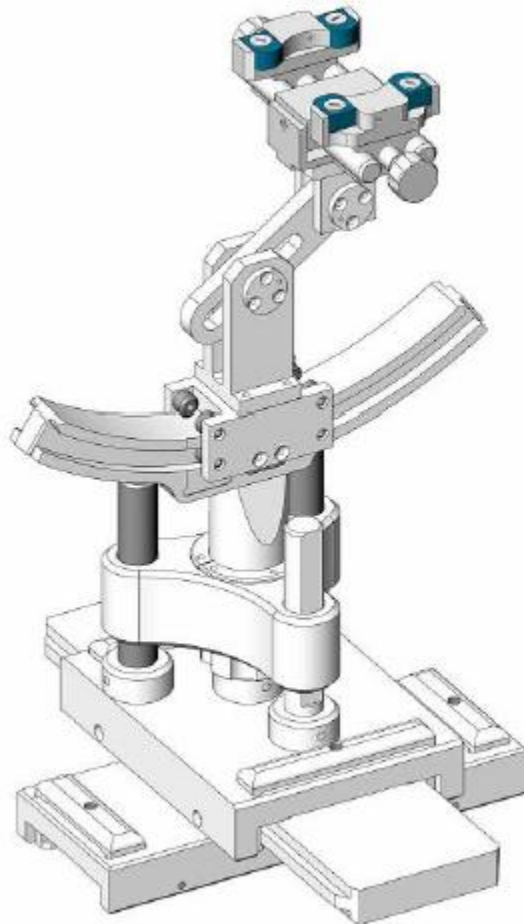

| Serial Number | Holder Material | Permittivity | Loss Tangent |
|-----------------|-----------------|--------------|--------------|
| SN 16/15 MSH100 | Delrin | 3.7 | 0.005 |

2.6. Test Equipment List

This table gives a complete overview of the SAR measurement equipment.

Devices used during the test described are marked

| | Manufacturer | Name of Equipment | Type/Model | Serial Number | Calibration | |
|-------------------------------------|--------------|--------------------------------------|------------|---------------------------|---------------|---------------|
| | | | | | Last Cal. | Due Date |
| <input checked="" type="checkbox"/> | MVG | E FIELD PROBE | SSE2 | SN 08/16 EPGO287 | Jan. 10, 2023 | Jan. 09, 2024 |
| <input type="checkbox"/> | MVG | 750 MHz Dipole | SID750 | SN 03/15 DIP 0G750-355 | Mar. 01, 2021 | Feb. 28, 2024 |
| <input checked="" type="checkbox"/> | MVG | 835 MHz Dipole | SID835 | SN 03/15 DIP 0G835-347 | Mar. 01, 2021 | Feb. 28, 2024 |
| <input type="checkbox"/> | MVG | 900 MHz Dipole | SID900 | SN 03/15 DIP 0G900-348 | Mar. 01, 2021 | Feb. 28, 2024 |
| <input type="checkbox"/> | MVG | 1800 MHz Dipole | SID1800 | SN 03/15 DIP 1G800-349 | Mar. 01, 2021 | Feb. 28, 2024 |
| <input checked="" type="checkbox"/> | MVG | 1900 MHz Dipole | SID1900 | SN 03/15 DIP 1G900-350 | Mar. 01, 2021 | Feb. 28, 2024 |
| <input type="checkbox"/> | MVG | 2000 MHz Dipole | SID2000 | SN 03/15 DIP 2G000-351 | Mar. 01, 2021 | Feb. 28, 2024 |
| <input type="checkbox"/> | MVG | 2450 MHz Dipole | SID2450 | SN 03/15 DIP 2G450-352 | Mar. 01, 2021 | Feb. 28, 2024 |
| <input type="checkbox"/> | MVG | 2600 MHz Dipole | SID2600 | SN 03/15 DIP 2G600-356 | Mar. 01, 2021 | Feb. 28, 2024 |
| <input type="checkbox"/> | MVG | 5000 MHz Dipole | SWG5500 | SN 13/14 WGA 33 | Mar. 01, 2021 | Feb. 28, 2024 |
| <input checked="" type="checkbox"/> | MVG | Liquid measurement Kit | SCLMP | SN 21/15 OCPG 72 | NCR | NCR |
| <input checked="" type="checkbox"/> | MVG | Power Amplifier | N.A | AMPLISAR_28/14_003 | NCR | NCR |
| <input checked="" type="checkbox"/> | KEITHLEY | Millivoltmeter | 2000 | 4072790 | NCR | NCR |
| <input checked="" type="checkbox"/> | R&S | Universal radio communication tester | CMU200 | 117858 | Jun. 17, 2022 | Jun. 16, 2023 |
| <input type="checkbox"/> | R&S | Wideband radio communication tester | CMW500 | 103917 | Jun. 17, 2022 | Jun. 16, 2023 |
| <input checked="" type="checkbox"/> | HP | Network Analyzer | 8753D | 3410J01136 | Jun. 17, 2022 | Jun. 16, 2023 |
| <input checked="" type="checkbox"/> | Agilent | MXG Vector Signal Generator | N5182A | MY47070317 | Jun. 16, 2022 | Jun. 15, 2023 |

| | | | | | | |
|-------------------------------------|----------|------------------------|---------|-----------------|------------------|------------------|
| <input checked="" type="checkbox"/> | Agilent | Power meter | E4419B | MY45102538 | Jun. 17, 2022 | Jun. 16, 2023 |
| <input checked="" type="checkbox"/> | Agilent | Power sensor | E9301A | MY41495644 | Jun. 17, 2022 | Jun. 16, 2023 |
| <input checked="" type="checkbox"/> | Agilent | Power sensor | E9301A | US39212148 | Jun. 17, 2022 | Jun. 16, 2023 |
| <input checked="" type="checkbox"/> | MCLI/USA | Directional Coupler | CB11-20 | 0D2L51502 | Jul. 17, 2020 | Jul. 16, 2023 |
| <input checked="" type="checkbox"/> | MVG | SAM Phantom | SSM2 | SN 16/15 SAM119 | NCR | NCR |
| <input checked="" type="checkbox"/> | MVG | Device Holder | SMPPD | SN 16/15 MSH100 | NCR | NCR |

3. SAR Measurement Procedures

The measurement procedures are as follows:

<Conducted power measurement>

- (a) For WWAN power measurement, use base station simulator to configure EUT WWAN transmission in conducted connection with RF cable, at maximum power in each supported wireless interface and frequency band.
- (b) Read the WWAN RF power level from the base station simulator.
- (c) For Wi-Fi/BT power measurement, use engineering software to configure EUT Wi-Fi/BT continuously transmission, at maximum RF power in each supported wireless interface and frequency band.
- (d) Connect EUT RF port through RF cable to the power meter, and measure Wi-Fi/BT output power.

<SAR measurement>

- (a) Use base station simulator to configure EUT WWAN transmission in radiated connection, and engineering software to configure EUT Wi-Fi/BT continuously transmission, at maximum RF power, in the highest power channel.
- (b) Place the EUT in the positions as Appendix A demonstrates.
- (c) Set scan area, grid size and other setting on the OPENSAR software.
- (d) Measure SAR results for the highest power channel on each testing position.
- (e) Find out the largest SAR result on these testing positions of each band.
- (f) Measure SAR results for other channels in worst SAR testing position if the reported SAR of highest power channel is larger than 0.8 W/kg.

According to the test standard, the recommended procedure for assessing the peak spatial-average SAR value consists of the following steps:

- (a) Power reference measurement
- (b) Area scan
- (c) Zoom scan
- (d) Power drift measurement

3.1. Power Reference

The Power Reference Measurement and Power Drift Measurements are for monitoring the power drift of the device under test in the batch process. The minimum distance of probe sensors to surface determines the closest measurement point to phantom surface. This distance cannot be smaller than the distance of sensor calibration points to probe tip as defined in the probe properties.

3.2. Area scan & Zoom scan

The area scan is a 2D scan to find the hot spot location on the DUT. The zoom scan is a 3D scan

above the hot spot to calculate the 1g and 10g SAR value.

Measurement of the SAR distribution with a grid of 8 to 16 mm * 8 to 16 mm and a constant distance to the inner surface of the phantom. Since the sensors cannot directly measure at the inner phantom surface, the values between the sensors and the inner phantom surface are extrapolated. With these values the area of the maximum SAR is calculated by an interpolation scheme. Around this point, a cube of 30 * 30 * 30 mm or 32 * 32 * 32 mm is assessed by measuring 5 or 8 * 5 or 8 * 4 or 5 mm. With these data, the peak spatial-average SAR value can be calculated.

From the scanned SAR distribution, identify the position of the maximum SAR value, in addition identify the positions of any local maxima with SAR values within 2 dB of the maximum value that will not be within the zoom scan of other peaks; additional peaks shall be measured only when the primary peak is within 2 dB of the SAR compliance limit (e.g., 1 W/kg for 1,6 W/kg 1 g limit, or 1,26 W/kg for 2 W/kg, 10 g limit).

Area scan & Zoom scan scan parameters extracted from FCC KDB 865664 D01 SAR measurement 100 MHz to 6 GHz.

| | | ≤ 3 GHz | > 3 GHz |
|--|---|---|--|
| Maximum distance from closest measurement point (geometric center of probe sensors) to phantom surface | | 5 ± 1 mm | ½·δ·ln(2) ± 0.5 mm |
| Maximum probe angle from probe axis to phantom surface normal at the measurement location | | 30° ± 1° | 20° ± 1° |
| Maximum area scan spatial resolution: Δx _{Area} , Δy _{Area} | | ≤ 2 GHz: ≤ 15 mm 2 – 3 GHz: ≤ 12 mm | 3 – 4 GHz: ≤ 12 mm 4 – 6 GHz: ≤ 10 mm |
| | | When the x or y dimension of the test device, in the measurement plane orientation, is smaller than the above, the measurement resolution must be ≤ the corresponding x or y dimension of the test device with at least one measurement point on the test device. | |
| Maximum zoom scan spatial resolution: Δx _{Zoom} , Δy _{Zoom} | | ≤ 2 GHz: ≤ 8 mm 2 – 3 GHz: ≤ 5 mm* | 3 – 4 GHz: ≤ 5 mm* 4 – 6 GHz: ≤ 4 mm* |
| Maximum zoom scan spatial resolution, normal to phantom surface | uniform grid: Δz _{Zoom} (n) | ≤ 5 mm | 3 – 4 GHz: ≤ 4 mm 4 – 5 GHz: ≤ 3 mm 5 – 6 GHz: ≤ 2 mm |
| | graded grid Δz _{Zoom} (1): between 1 st two points closest to phantom surface Δz _{Zoom} (n>1): between subsequent points | ≤ 4 mm | 3 – 4 GHz: ≤ 3 mm 4 – 5 GHz: ≤ 2.5 mm 5 – 6 GHz: ≤ 2 mm |
| | | ≤ 1.5·Δz _{Zoom} (n-1) | |
| Minimum zoom scan volume | x, y, z | ≥ 30 mm | 3 – 4 GHz: ≥ 28 mm 4 – 5 GHz: ≥ 25 mm 5 – 6 GHz: ≥ 22 mm |

Note: δ is the penetration depth of a plane-wave at normal incidence to the tissue medium; see draft standard IEEE P1528-2011 for details.

* When zoom scan is required and the *reported* SAR from the *area scan based 1-g SAR estimation* procedures of KDB 447498 is ≤ 1.4 W/kg, ≤ 8 mm, ≤ 7 mm and ≤ 5 mm zoom scan resolution may be applied, respectively, for 2 GHz to 3 GHz, 3 GHz to 4 GHz and 4 GHz to 6 GHz.

3.3. Description of interpolation/extrapolation scheme

The local SAR inside the phantom is measured using small dipole sensing elements inside a probe body. The probe tip must not be in contact with the phantom surface in order to minimise measurements errors, but the highest local SAR will occur at the surface of the phantom.

An extrapolation is using to determinate this highest local SAR values. The extrapolation is based on a fourth-order least-square polynomial fit of measured data. The local SAR value is then extrapolated from the liquid surface with a 1 mm step.

The measurements have to be performed over a limited time (due to the duration of the battery) so the step of measurement is high. It could vary between 5 and 8 mm. To obtain an accurate assessment of the maximum SAR averaged over 10 grams and 1 gram requires a very fine resolution in the three dimensional scanned data array.

3.4. Volumetric Scan

The volumetric scan consists to a full 3D scan over a specific area. This 3D scan is useful form multi Tx SAR measurement. Indeed, it is possible with OpenSAR to add, point by point, several volumetric scan to calculate the SAR value of the combined measurement as it is define in the standard IEEE1528 and IEC62209.

3.5. Power Drift

All SAR testing is under the EUT install full charged battery and transmit maximum output power. In OpenSAR measurement software, the power reference measurement and power drift measurement procedures are used for monitoring the power drift of EUT during SAR test. Both these procedures measure the field at a specified reference position before and after the SAR testing. The software will calculate the field difference in V/m. If the power drifts more than $\pm 5\%$, the SAR will be retested.

4. System Verification Procedure

4.1. Tissue Verification

The following tissue formulations are provided for reference only as some of the parameters have not been thoroughly verified. The composition of ingredients may be modified accordingly to achieve the desired target tissue parameters required for routine SAR evaluation.

| Ingredients (% of weight) | Head Tissue | | | | | | | | | |
|---------------------------|-------------|-------|-------|-------|-------|-------|-------|-------|-------|-------|
| | 750 | 835 | 900 | 1800 | 1900 | 2000 | 2450 | 2600 | 5200 | 5800 |
| Frequency Band (MHz) | | | | | | | | | | |
| Water | 34.40 | 34.40 | 34.40 | 55.36 | 55.36 | 57.87 | 57.87 | 57.87 | 65.53 | 65.53 |
| NaCl | 0.79 | 0.79 | 0.79 | 0.35 | 0.35 | 0.16 | 0.16 | 0.16 | 0.00 | 0.00 |
| 1,2-Propanediol | 64.81 | 64.81 | 64.81 | 0.00 | 0.00 | 0.00 | 0.00 | 0.00 | 0.00 | 0.00 |
| Triton X-100 | 0.00 | 0.00 | 0.00 | 30.45 | 30.45 | 19.97 | 19.97 | 19.97 | 24.24 | 24.24 |
| DGBE | 0.00 | 0.00 | 0.00 | 13.84 | 13.84 | 22.00 | 22.00 | 22.00 | 10.23 | 10.23 |

For SAR measurement of the field distribution inside the phantom, the phantom must be filled with homogeneous tissue simulating liquid to a depth of at least 15 cm. For head SAR testing, the liquid depth from the ear reference point (ERP) of the phantom to the liquid top surface is larger than 15 cm.

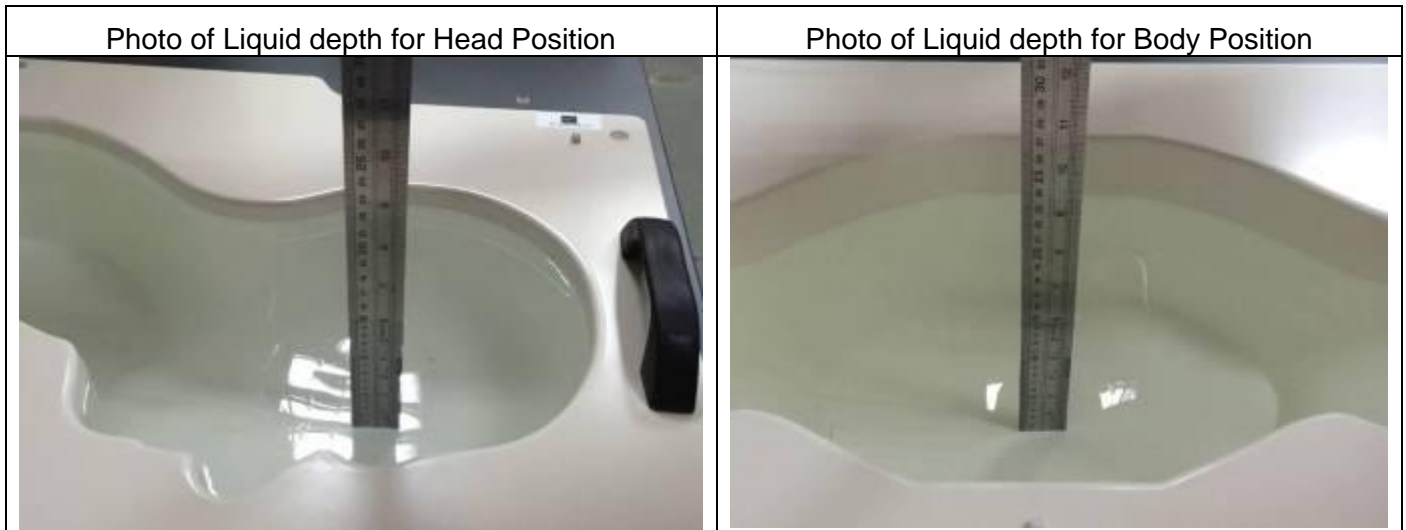

4.1.1. Tissue Dielectric Parameter Check Results

The simulating liquids should be checked at the beginning of a series of SAR measurements to determine if the dielectric parameters are within the tolerances of the specified target values. The measured conductivity and relative permittivity should be within $\pm 5\%$ of the target values.

| Tissue Type | Measured Frequency (MHz) | Target Tissue | | Measured Tissue | | Liquid Temp. | Test Date |
|-------------|--------------------------|------------------------|------------------------------|-----------------|----------------|--------------|---------------|
| | | $\epsilon_r (\pm 5\%)$ | σ (S/m) ($\pm 5\%$) | ϵ_r | σ (S/m) | | |
| Head 850 | 835 | 41.50 (39.43~43.58) | 0.90 (0.86~0.95) | 41.15 | 0.92 | 21.3 °C | Apr. 04, 2023 |
| Head 1900 | 1900 | 40.00 (38.00~42.00) | 1.40 (1.33~1.47) | 38.55 | 1.44 | 21.2 °C | Apr. 03, 2023 |

NOTE: The dielectric parameters of the tissue-equivalent liquid should be measured under similar ambient conditions and within 2 °C of the conditions expected during the SAR evaluation to satisfy protocol requirements.

4.2. System Verification Procedure

The system verification is performed for verifying the accuracy of the complete measurement system and performance of the software. The dipole is connected to the signal source consisting of signal generator and amplifier via a directional coupler, N-connector cable and adaption to SMA. It is fed with a power of 100mW (below 5GHz) or 100mW (above 5GHz). To adjust this power a power meter is used. The power sensor is connected to the cable before the system verification to measure the power at this point and do adjustments at the signal generator. At the outputs of the directional coupler both return loss as well as forward power are controlled during the system verification to make sure that emitted power at the dipole is kept constant. This can also be checked by the power drift measurement after the test (result on plot).

The system verification is shown as below picture:

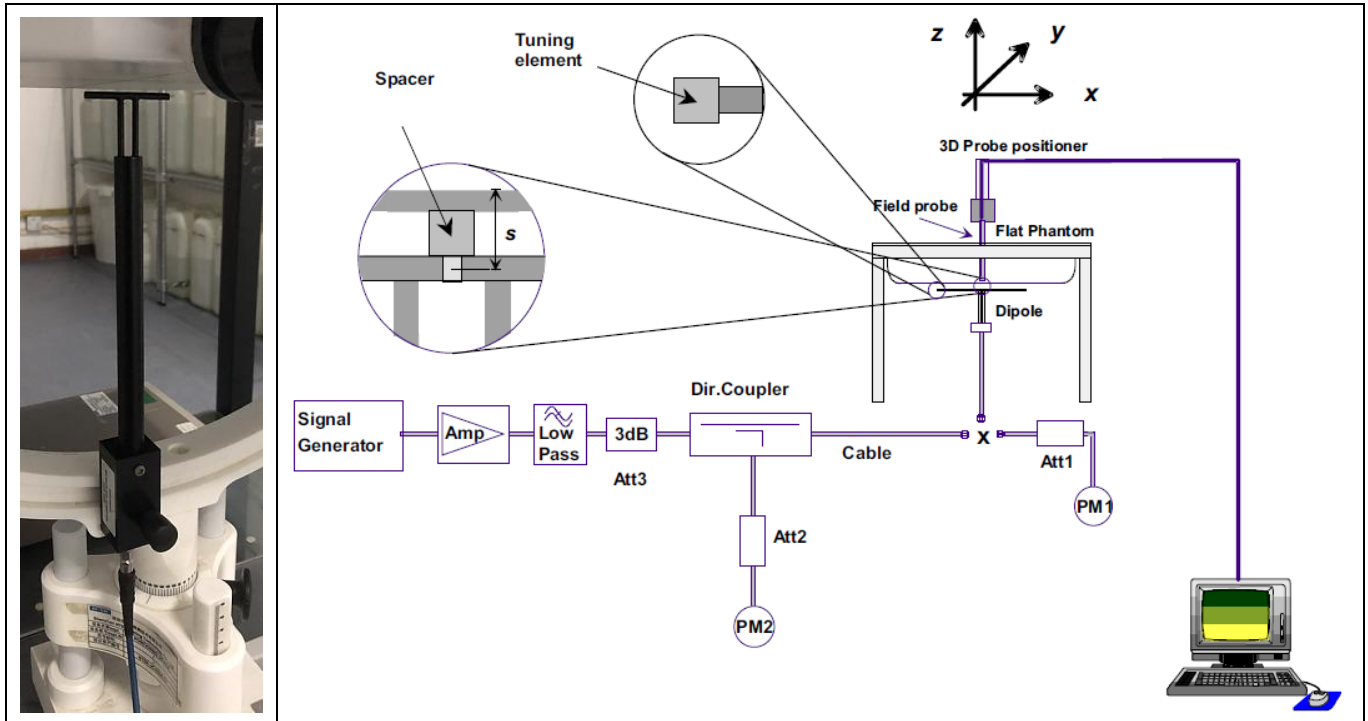

4.2.1. System Verification Results

Comparing to the original SAR value provided by SATIMO, the verification data should be within its specification of $\pm 10\%$. Below table shows the target SAR and measured SAR after normalized to 1W input power. The table below indicates the system performance verification can meet the variation criterion and the plots can be referred to Appendix B of this report.

| System Verification | Target SAR (1W) ($\pm 10\%$) | | Measured SAR (Normalized to 1W) | | Liquid Temp. | Test Date |
|---------------------|-----------------------------------|------------------------|------------------------------------|-------------------|--------------|---------------|
| | 1-g (W/Kg) | 10-g (W/Kg) | 1-g (W/Kg) | 10-g (W/Kg) | | |
| 835MHz | 9.84 (8.86~10.82) | 6.22 (5.60~6.84) | 10.31 (4.78%) | 6.34 (1.93%) | 21.3 °C | Apr. 04, 2023 |
| 1900MHz | 40.37 (36.34~44.40) | 20.48 (18.44~22.52) | 41.10 (1.81%) | 19.53 (-4.64%) | 21.2 °C | Apr. 03, 2023 |

5. SAR Measurement variability and uncertainty

5.1. SAR measurement variability

Per KDB865664 D01 SAR measurement 100 MHz to 6 GHz, SAR measurement variability must be assessed for each frequency band, which is determined by the SAR probe calibration point and tissue-equivalent medium used for the device measurements. The additional measurements are repeated after the completion of all measurements requiring the same head or body tissue-equivalent medium in a frequency band. The test device should be returned to ambient conditions (normal room temperature) with the battery fully charged before it is re-mounted on the device holder for the repeated measurement(s) to minimize any unexpected variations in the repeated results.

- 1) Repeated measurement is not required when the original highest measured SAR is < 0.80 W/kg; steps 2) through 4) do not apply.
- 2) When the original highest measured SAR is ≥ 0.80 W/kg, repeat that measurement once.
- 3) Perform a second repeated measurement only if the ratio of largest to smallest SAR for the original and first repeated measurements is > 1.20 or when the original or repeated measurement is ≥ 1.45 W/kg (~ 10% from the 1-g SAR limit).
- 4) Perform a third repeated measurement only if the original, first or second repeated measurement is ≥ 1.5 W/kg and the ratio of largest to smallest SAR for the original, first and second repeated measurements is > 1.20 .

5.2. SAR measurement uncertainty

Per KDB865664 D01 SAR Measurement 100 MHz to 6 GHz, when the highest measured 1-g SAR within a frequency band is < 1.5 W/kg, the extensive SAR measurement uncertainty analysis described in IEEE Std 1528-2013 is not required in SAR reports submitted for equipment approval. The equivalent ratio (1.5/1.6) is applied to extremity and occupational exposure conditions.

6. RF Exposure Positions

6.1. Ear and handset reference point

Figure 6.1.1 shows the front, back, and side views of the SAM phantom. The center-of-mouth reference point is labeled “M”, the left ear reference point (ERP) is marked “LE”, and the right ERP is marked “RE”.



Fig 6.1.1 Front, back, and side views of SAM phantom

6.2. Definition of the cheek position

1. Define two imaginary lines on the handset, the vertical centerline and the horizontal line. The vertical centerline passes through two points on the front side of the handset: the midpoint of the width w_t of the handset at the level of the acoustic output (point A in Figure 6.2.1 and Figure 6.2.2), and the midpoint of the width w_b of the bottom of the handset (point B). The horizontal line is perpendicular to the vertical centerline and passes through the center of the acoustic output (see Figure 6.2.1). The two lines intersect at point A. Note that for many handsets, point A coincides with the center of the acoustic output; however, the acoustic output may be located elsewhere on the horizontal line. Also note that the vertical centerline is not necessarily parallel to the front face of the handset (see Figure 6.2.2), especially for clamshell handsets, handsets with flip covers, and other irregularly-shaped handsets.
2. Position the handset close to the surface of the phantom such that point A is on the (virtual) extension of the line passing through points RE and LE on the phantom (see Figure 6.2.3), such that the plane defined by the vertical centerline and the horizontal line of the handset is approximately parallel to the sagittal plane of the phantom.
3. Translate the handset towards the phantom along the line passing through RE and LE until handset point A touches the pinna at the ERP
4. While maintaining the handset in this plane, rotate it around the LE-RE line until the vertical centerline is in the plane normal to the plane containing B-M and N-F lines, i.e., the Reference Plane.
5. Rotate the handset around the vertical centerline until the handset (horizontal line) is parallel to the N-F line.

6. While maintaining the vertical centerline in the Reference Plane, keeping point A on the line passing through RE and LE, and maintaining the handset contact with the pinna, rotate the handset about the N-F line until any point on the handset is in contact with a phantom point below the pinna on the cheek. See Figure 6.2.3. The actual rotation angles should be documented in the test report.

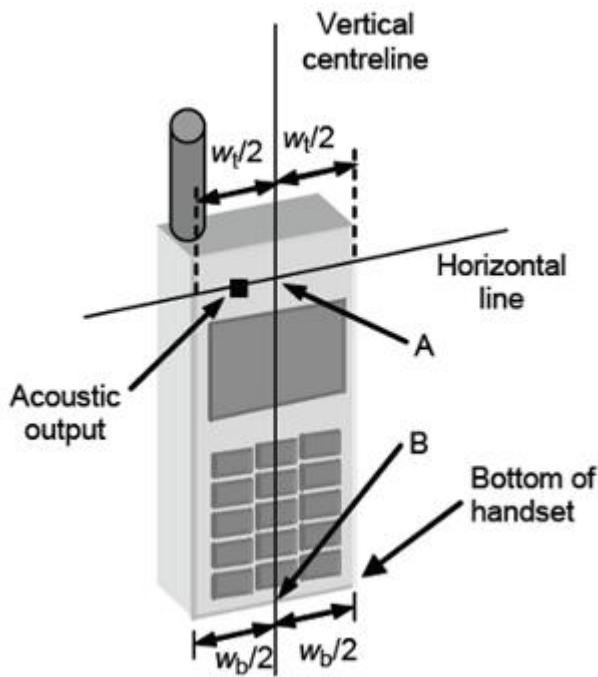

Fig 6.2.1 Handset vertical and horizontal reference lines—“fixed case”

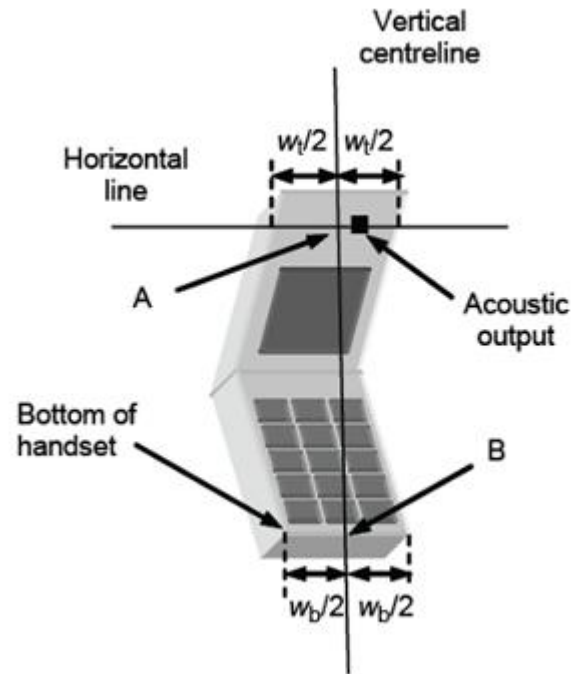

Fig 6.2.2 Handset vertical and horizontal reference lines—“clam-shell case”

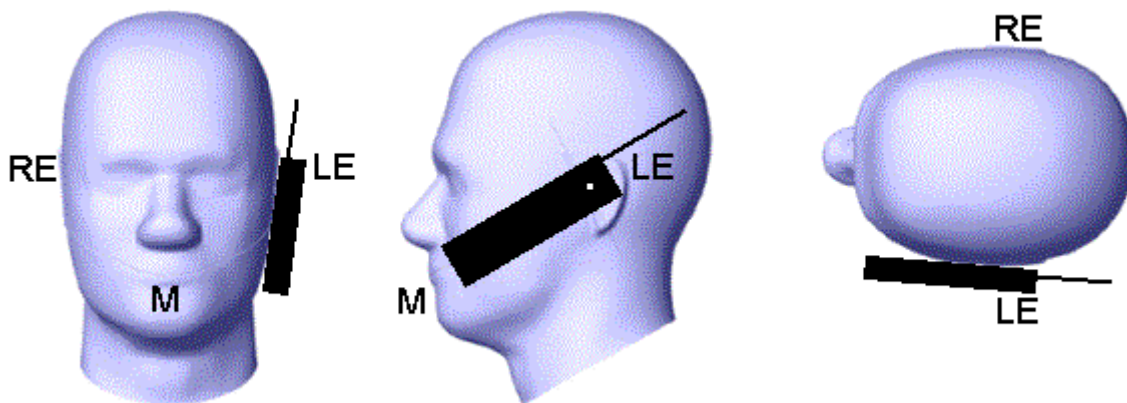

Fig 6.2.3 cheek or touch position. The reference points for the right ear (RE), left ear (LE), and mouth (M), which establish the Reference Plane for handset positioning, are indicated.

6.3. Definition of the tilt position

1. While maintaining the orientation of the handset, retract the handset parallel to the reference plane far enough away from the phantom to enable a rotation of the device by 15 degree.
2. Rotate the Handset around the horizontal line by 15 degree (see Figure 6.3.1).
3. While maintaining the orientation of the handset, move the handset towards the phantom on a line passing through RE and LE until any part of the handset touches the ear. The tilt position is obtained when the contact is on the pinna. If the contact is at any location other than the pinna, e.g., the antenna with the back of the phantom head, the angle of the handset shall be reduced. In this case, the tilt position is obtained if any part of the handset is in contact with the pinna as well as a second part of the handset is in contact with the phantom, e.g., the antenna with the back of the head.

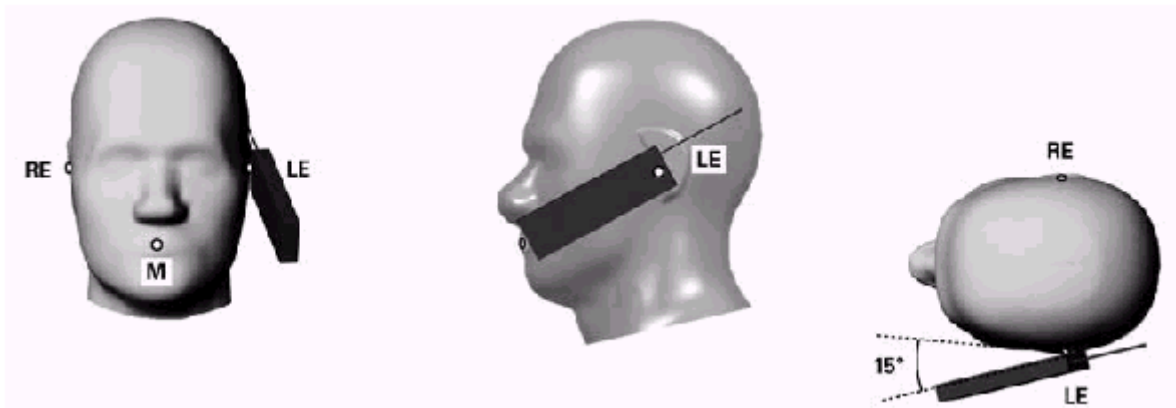

Figure 6.3.1 – Tilt position of the wireless device on the left side of SAM

6.4. Body Worn Accessory

1. Body-worn operating configurations are tested with the belt-clips and holsters attached to the device and positioned against a flat phantom in a normal use configuration (see Figure 6.4.1). Per KDB 648474 D04, body-worn accessory exposure is typically related to voice mode operations when handsets are carried in body-worn accessories. The body-worn accessory procedures in FCC KDB 447498 D01 should be used to test for body-worn accessory SAR compliance, without a headset connected to it. This enables the test results for such configuration to be compatible with that required for hotspot mode when the body-worn accessory test separation distance is greater than or equal to that required for hotspot mode, when applicable. When the reported SAR for body-worn accessory, measured without a headset connected to the handset is < 1.2 W/kg, the highest reported SAR configuration for that wireless mode and frequency band should be repeated for that body-worn accessory with a headset attached to the handset.
2. Accessories for body-worn operation configurations are divided into two categories: those that do not contain metallic components and those that do contain metallic components and those that do contain metallic components. When multiple accessories that do not contain metallic components are supplied with the device, the device is tested with only the accessory that dictates the closest

spacing to the body. Then multiple accessories that contain metallic components are test with the device with each accessory. If multiple accessories share an identical metallic component (i.e. the same metallic belt-chip used with different holsters with no other metallic components) only the accessory that dictates the closest spacing to the body is tested.

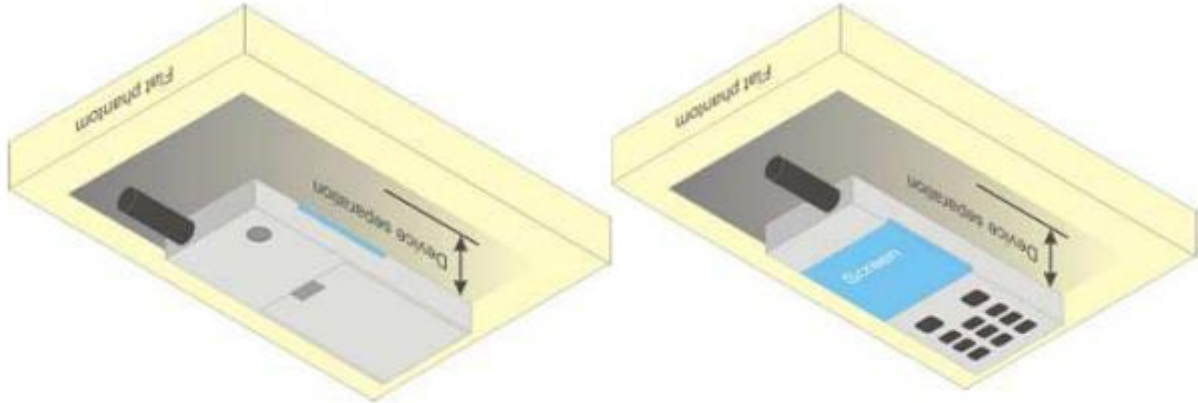

Figure 6.4.1 – Test positions for body-worn devices

7. RF Output Power

7.1. GSM Conducted Power

| Band GSM850 | Burst-Averaged output Power (dBm) | | | | Frame-Averaged output Power (dBm) | | | |
|-----------------|-----------------------------------|--------|--------|--------|-----------------------------------|--------|--------|--------|
| Tx Channel | Tune-up | 128 | 189 | 251 | Tune-up | 128 | 189 | 251 |
| Frequency (MHz) | (dBm) | 824.2 | 836.4 | 848.8 | (dBm) | 824.2 | 836.4 | 848.8 |
| GSM (GMSK) | 32.00 | 31.90 | 31.92 | 31.67 | 22.97 | 22.87 | 22.89 | 22.64 |
| Band GSM1900 | Burst-Averaged output Power (dBm) | | | | Frame-Averaged output Power (dBm) | | | |
| Tx Channel | Tune-up | 512 | 661 | 810 | Tune-up | 512 | 661 | 810 |
| Frequency (MHz) | (dBm) | 1850.2 | 1880.0 | 1909.8 | (dBm) | 1850.2 | 1880.0 | 1909.8 |
| GSM (GMSK) | 31.50 | 31.21 | 30.99 | 30.58 | 22.47 | 22.18 | 21.96 | 21.55 |

Note: The frame-averaged power is linearly scaled the maximum burst averaged power over 8 time slots.

The calculated method are shown as below:

Frame-averaged power = Maximum burst averaged power (1 TS) - 9.03 dB

Frame-averaged power = Maximum burst averaged power (2 TS) - 6.02 dB

Frame-averaged power = Maximum burst averaged power (3 TS) - 4.26 dB

Frame-averaged power = Maximum burst averaged power (4 TS) - 3.01 dB

7.2. Bluetooth Output Power

| BR+EDR | Output Power (dBm) | | | | |
|--------|--------------------|------------------|---------|------|------|
| | Data Rates | Tune-up (dBm) | Channel | | |
| | | | 0CH | 39CH | 78CH |
| 1M | 7.00 | 6.49 | 6.54 | 6.47 | |
| 2M | 6.00 | 4.73 | 5.97 | 5.32 | |
| 3M | 4.00 | 3.55 | 3.97 | 3.55 | |

NOTE: Power measurement results of Bluetooth.

8. Stand-alone SAR test exclusion

Refer to FCC KDB 447498D01, the 1-g SAR and 10-g SAR test exclusion thresholds for 100 MHz to 6 GHz at test separation distances ≤ 50 mm are determined by:

$[(\text{max. power of channel, including tune-up tolerance, mW}) / (\text{min. test separation distance, mm})] \cdot [\sqrt{f_{(\text{GHz})}}] \leq 3.0$ for 1-g SAR and ≤ 7.5 for 10-g extremity SAR, where:

- $f_{(\text{GHz})}$ is the RF channel transmit frequency in GHz
- Power and distance are rounded to the nearest mW and mm before calculation
- The result is rounded to one decimal place for comparison

When the minimum test separation distance is < 5 mm, a distance of 5 mm is applied to determine SAR test exclusion.

| Mode | P_{max} (dBm) | P_{max} (mW) | Distance (mm) | f (GHz) | Calculation Result | SAR Exclusion threshold | SAR test exclusion |
|-----------|---------------------------|--------------------------|------------------|------------|-----------------------|----------------------------|-----------------------|
| Bluetooth | 7.00 | 5.01 | 5 | 2.480 | 1.6 | 3 | Yes |

NOTE: Standalone SAR test exclusion for Bluetooth.

When standalone SAR test exclusion applies to an antenna that transmits simultaneously with other antennas, the standalone SAR must be estimated according to following to determine simultaneous transmission SAR test exclusion:

$[(\text{max. power of channel, including tune-up tolerance, mW}) / (\text{min. test separation distance, mm})] \cdot [\sqrt{f_{(\text{GHz})}} / x] \text{ W/kg}$ for test separation distances ≤ 50 mm, where $x = 7.5$ for 1-g SAR and $x = 18.75$ for 10-g SAR.

When the minimum test separation distance is < 5 mm, a distance of 5 mm is applied to determine SAR test exclusion.

| Mode | Position | P_{max} (dBm) | P_{max} (mW) | Distance (mm) | f (GHz) | x | Estimated SAR (W/Kg) |
|-----------|----------|---------------------------|--------------------------|------------------|------------|-----|-------------------------|
| Bluetooth | Head | 7.00 | 5.01 | 5 | 2.48 | 7.5 | 0.293 |
| Bluetooth | Body | 7.00 | 5.01 | 10 | 2.48 | 7.5 | 0.146 |

NOTE: Estimated SAR calculation for Bluetooth

9. SAR Results

9.1. SAR measurement Result

9.1.1. SAR measurement Result of GSM850

| Test Position of Head | Test channel /Freq. | Mode | SAR Value (W/kg) | | Power Drift(%) | Conducted Power (dBm) | Tune-up Power (dBm) | Scaled SAR 1-g (W/Kg) | Date | Plot |
|-----------------------|---------------------|-------|------------------|-------|----------------|-----------------------|---------------------|-----------------------|-----------|------|
| | | | 1-g | 10-g | | | | | | |
| Left Cheek | 189/836.4 | Voice | 0.572 | 0.347 | 0.06 | 31.92 | 32.00 | 0.583 | 2023/4/04 | 1# |
| Left Tilt 15 Degree | 189/836.4 | Voice | 0.297 | 0.171 | -2.41 | 31.92 | 32.00 | 0.303 | 2023/4/04 | |
| Right Cheek | 189/836.4 | Voice | 0.525 | 0.318 | -2.34 | 31.92 | 32.00 | 0.535 | 2023/4/04 | |
| Right Tilt 15 Degree | 189/836.4 | Voice | 0.288 | 0.166 | 2.46 | 31.92 | 32.00 | 0.293 | 2023/4/04 | |

NOTE: Head SAR test results of GSM850.

| Test Position of Body-Worn with 10mm | Test channel /Freq. | Mode | SAR Value (W/kg) | | Power Drift(%) | Conducted Power (dBm) | Tune-up Power (dBm) | Scaled SAR 1-g (W/Kg) | Date | Plot |
|--------------------------------------|---------------------|-------|------------------|-------|----------------|-----------------------|---------------------|-----------------------|-----------|------|
| | | | 1-g | 10-g | | | | | | |
| Front Side | 189/836.4 | Voice | 0.396 | 0.246 | 2.01 | 31.92 | 32.00 | 0.403 | 2023/4/04 | |
| Back Side | 189/836.4 | Voice | 0.616 | 0.391 | -1.52 | 31.92 | 32.00 | 0.627 | 2023/4/04 | 2# |

NOTE: Body-Worn SAR test results of GSM850

9.1.2. SAR measurement Result of GSM1900

| Test Position of Head | Test channel /Freq. | Mode | SAR Value (W/kg) | | Power Drift(%) | Conducted Power (dBm) | Tune-up Power (dBm) | Scaled SAR 1-g (W/Kg) | Date | Plot |
|-----------------------|---------------------|-------|------------------|-------|----------------|-----------------------|---------------------|-----------------------|-----------|------|
| | | | 1-g | 10-g | | | | | | |
| Left Cheek | 661/1880 | Voice | 0.429 | 0.208 | 0.59 | 30.99 | 31.50 | 0.482 | 2023/4/03 | 3# |
| Left Tilt 15 Degree | 661/1880 | Voice | 0.254 | 0.118 | -2.00 | 30.99 | 31.50 | 0.286 | 2023/4/03 | |
| Right Cheek | 661/1880 | Voice | 0.375 | 0.182 | 2.21 | 30.99 | 31.50 | 0.422 | 2023/4/03 | |
| Right Tilt 15 Degree | 661/1880 | Voice | 0.184 | 0.086 | 3.05 | 30.99 | 31.50 | 0.207 | 2023/4/03 | |

NOTE: Head SAR test results of GSM1900

| Test Position of | Test channel | Mode | SAR Value (W/kg) | Power Drift(%) | Conducted Power | Tune-up Power | Scaled SAR | Date | Plot |
|------------------|--------------|------|------------------|----------------|-----------------|---------------|------------|------|------|
|------------------|--------------|------|------------------|----------------|-----------------|---------------|------------|------|------|

| | | | | | | | | | | |
|---------------------|----------|-------|--------------|-------|------|-------|-------|--------------|-----------|----|
| Body-Worn with 10mm | /Freq. | | 1-g | 10-g | | (dBm) | (dBm) | 1-g (W/Kg) | | |
| Front Side | 661/1880 | Voice | 0.180 | 0.098 | 1.82 | 30.99 | 31.50 | 0.202 | 2023/4/03 | |
| Back Side | 661/1880 | Voice | 0.293 | 0.167 | 2.98 | 30.99 | 31.50 | 0.330 | 2023/4/03 | 4# |

NOTE: Body-Worn SAR test results of GSM1900

9.2. Simultaneous Transmission Analysis

Per KDB 447498 D01, simultaneous transmission SAR is compliant if,

- 1) Scalar SAR summation < 1.6W/kg.
- 2) $SPLSR = (SAR_1 + SAR_2)^{1.5} / (\text{min. separation distance, mm})$, and the peak separation distance is determined from the square root of $[(x_1-x_2)^2 + (y_1-y_2)^2 + (z_1-z_2)^2]$, where (x_1, y_1, z_1) and (x_2, y_2, z_2) are the coordinates of the extrapolated peak SAR locations in the zoom scan. If $SPLSR \leq 0.04$, simultaneously transmission SAR measurement is not necessary.

| Test Position | | Scaled SAR _{MAX} | | Σ 1-g SAR (W/Kg) | SPLSR | Remark |
|---------------|----------------------|---------------------------|-------|------------------|-------|--------|
| | | WWAN | DSS | | | |
| Head | Left Cheek | 0.583 | 0.293 | 0.876 | N/A | N/A |
| | Left Tilt 15 Degree | 0.303 | 0.293 | 0.596 | N/A | N/A |
| | Right Cheek | 0.535 | 0.293 | 0.828 | N/A | N/A |
| | Right Tilt 15 Degree | 0.293 | 0.293 | 0.586 | N/A | N/A |
| Body-Worn | Front Side | 0.403 | 0.146 | 0.549 | N/A | N/A |
| | Back Side | 0.627 | 0.146 | 0.773 | N/A | N/A |

10. Appendix A. Photo documentation

Refer to appendix Test Setup photo---SAR

11. Appendix B. System Check Plots

| |
|---|
| Table of contents |
| MEASUREMENT 1 System Performance Check - 835MHz |
| MEASUREMENT 2 System Performance Check - 1900MHz |

MEASUREMENT 1

Date of measurement: 4/4/2023

A. Experimental conditions.

| | |
|------------------------|------------------------------------|
| Area Scan | <u>dx=15mm dy=15mm, h= 5.00 mm</u> |
| ZoomScan | <u>5x5x7, dx=8mm dy=8mm dz=5mm</u> |
| Phantom | <u>Validation plane</u> |
| Device Position | <u>Dipole</u> |
| Band | <u>CW835</u> |
| Channels | <u>Middle</u> |
| Signal | <u>CW (Crest factor: 1.0)</u> |
| ConvF | <u>1.50</u> |

B. SAR Measurement Results

| | |
|---|------------|
| Frequency (MHz) | 835.000000 |
| Relative permittivity (real part) | 41.146055 |
| Relative permittivity (imaginary part) | 19.802383 |
| Conductivity (S/m) | 0.918611 |
| Variation (%) | 1.410000 |

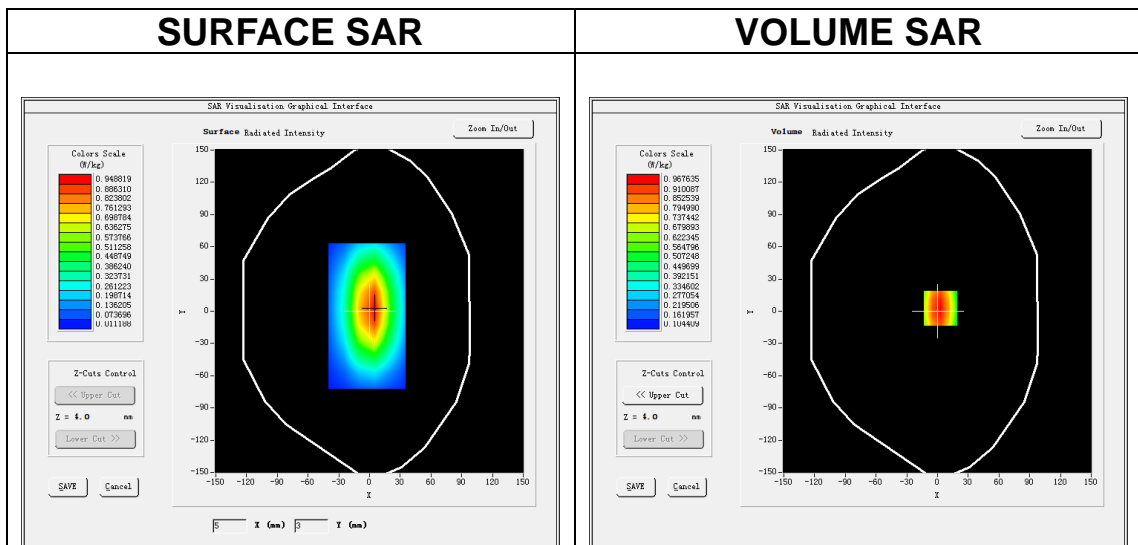

Maximum location: X=3.00, Y=3.00
SAR Peak: 1.30 W/kg

| | |
|-----------------------|----------|
| SAR 10g (W/Kg) | 0.634016 |
| SAR 1g (W/Kg) | 1.031147 |

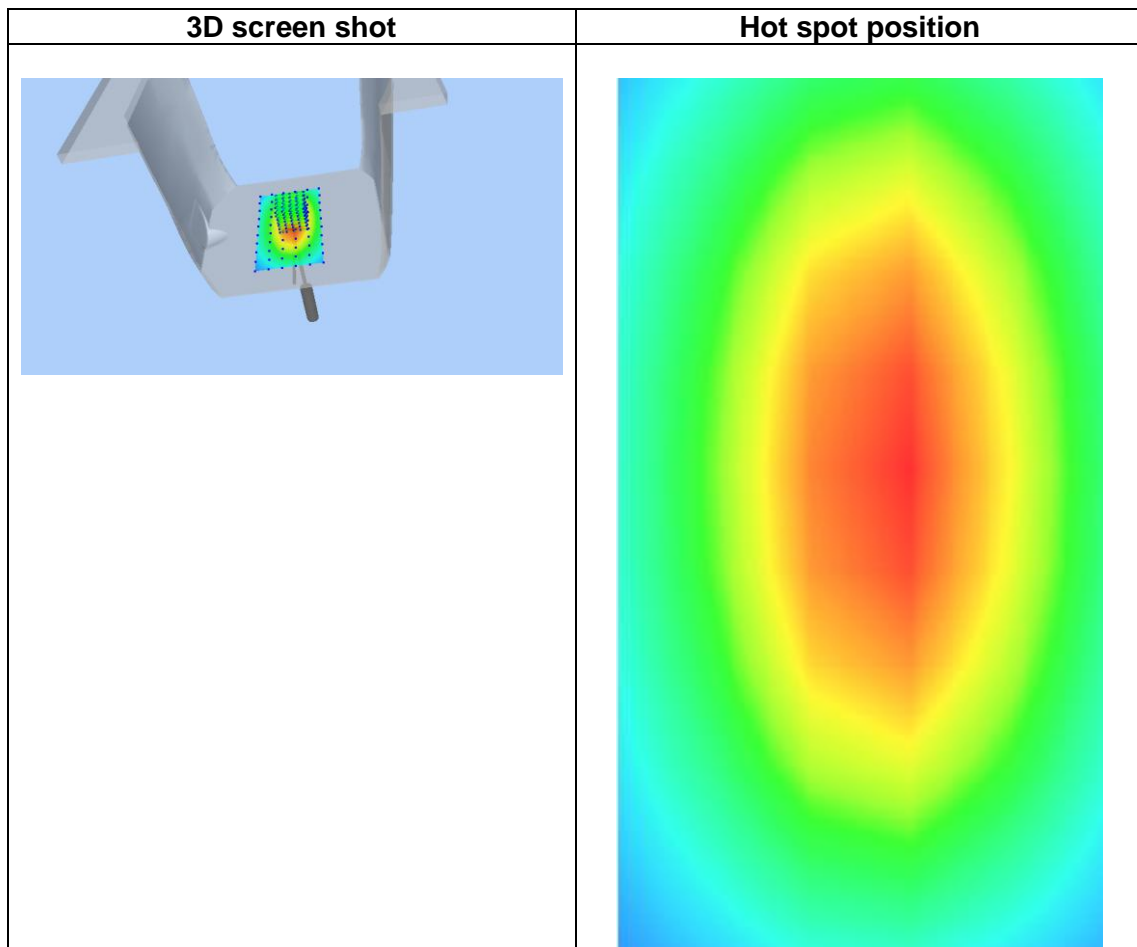
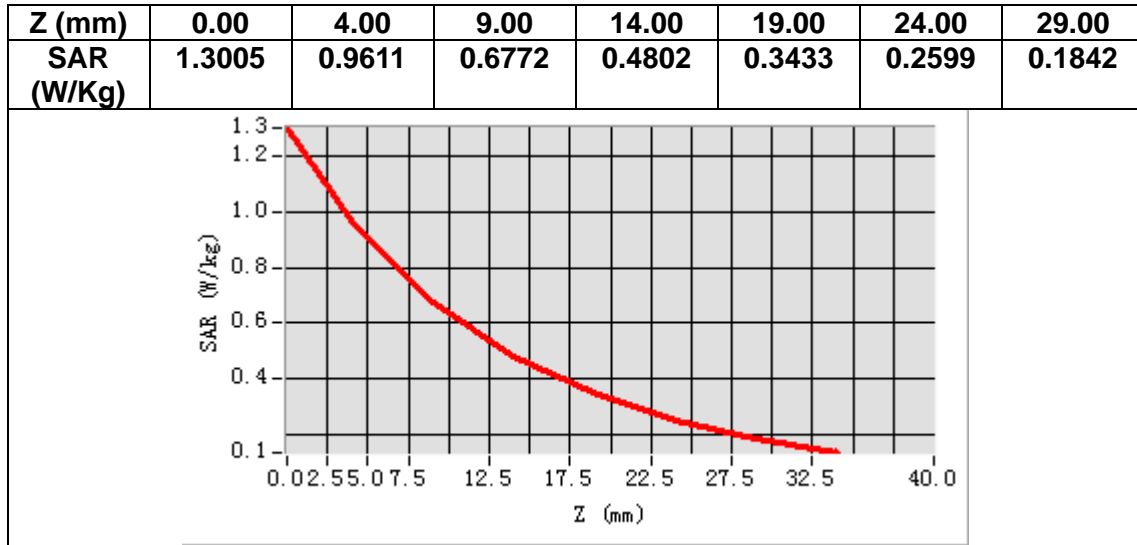

MEASUREMENT 2

Date of measurement: 3/4/2023

A. Experimental conditions.

| | |
|------------------------|------------------------------------|
| Area Scan | <u>dx=15mm dy=15mm, h= 5.00 mm</u> |
| ZoomScan | <u>5x5x7, dx=8mm dy=8mm dz=5mm</u> |
| Phantom | <u>Validation plane</u> |
| Device Position | <u>Dipole</u> |
| Band | <u>CW1900</u> |
| Channels | <u>Middle</u> |
| Signal | <u>CW (Crest factor: 1.0)</u> |
| ConvF | <u>1.91</u> |

B. SAR Measurement Results

| | |
|---|-------------|
| Frequency (MHz) | 1900.000000 |
| Relative permittivity (real part) | 38.550669 |
| Relative permittivity (imaginary part) | 13.629836 |
| Conductivity (S/m) | 1.438705 |
| Variation (%) | -1.390000 |

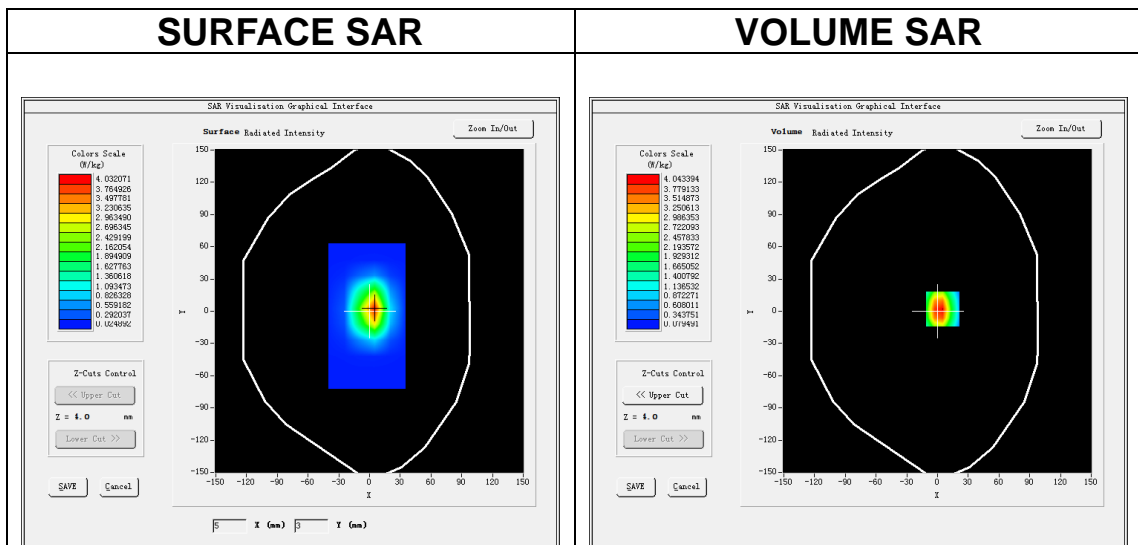

Maximum location: X=5.00, Y=2.00
SAR Peak: 6.70 W/kg

| | |
|-----------------------|----------|
| SAR 10g (W/Kg) | 1.953105 |
| SAR 1g (W/Kg) | 4.110298 |

| Z (mm) | 0.00 | 4.00 | 9.00 | 14.00 | 19.00 | 24.00 | 29.00 |
|------------|--------|--------|--------|--------|--------|--------|--------|
| SAR (W/Kg) | 6.3262 | 4.0415 | 2.2604 | 1.3092 | 0.7673 | 0.4529 | 0.2766 |

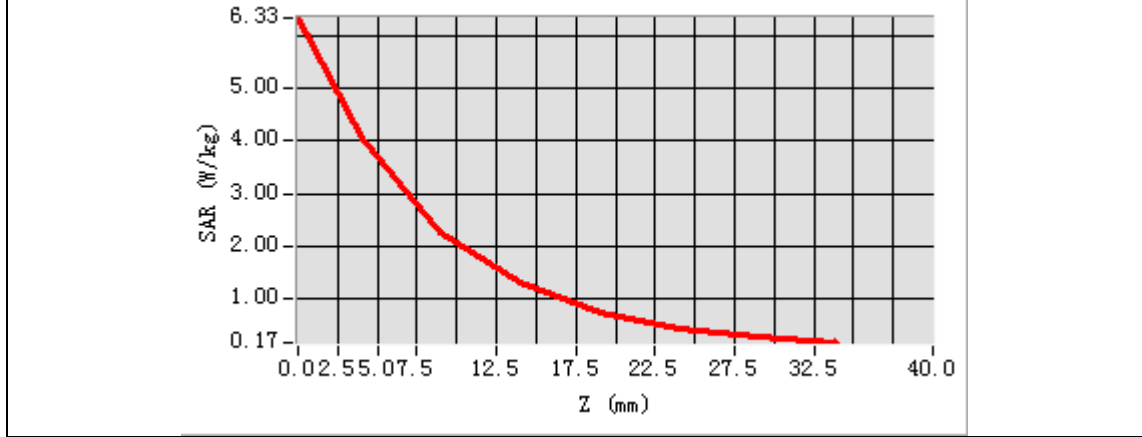

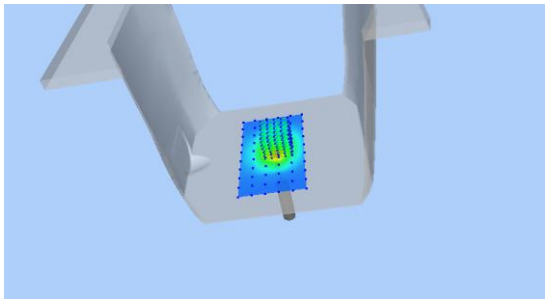
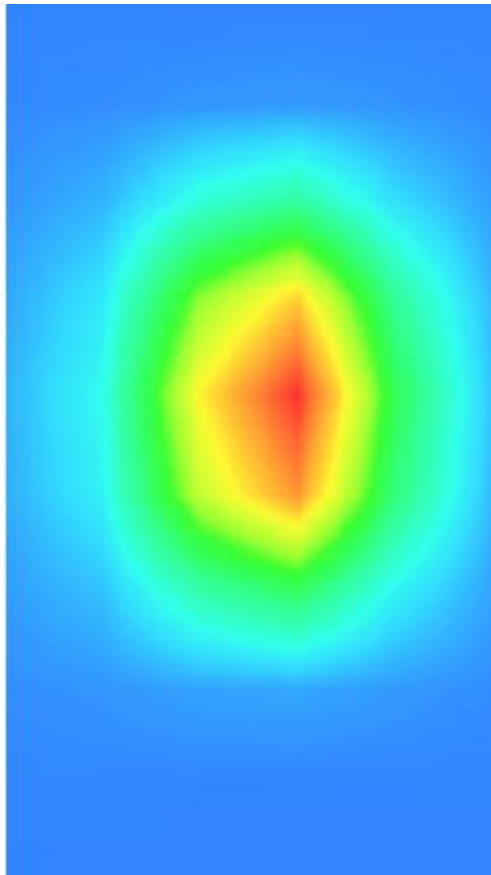
| 3D screen shot | Hot spot position |
|---|--|
|  |  |

12. Appendix C. Plots of High SAR Measurement

| Table of contents |
|-----------------------------|
| MEASUREMENT 1 GSM 850 Head |
| MEASUREMENT 2 GSM 850 Body |
| MEASUREMENT 3 GSM 1900 Head |
| MEASUREMENT 4 GSM 1900 Body |

MEASUREMENT 1

Date of measurement: 4/4/2023

A. Experimental conditions.

| | |
|------------------------|------------------------------------|
| Area Scan | <u>dx=15mm dy=15mm, h= 5.00 mm</u> |
| ZoomScan | <u>5x5x7,dx=8mm dy=8mm dz=5mm</u> |
| Phantom | <u>Left head</u> |
| Device Position | <u>Cheek</u> |
| Band | <u>GSM850</u> |
| Channels | <u>Middle</u> |
| Signal | <u>TDMA (Crest factor: 8.0)</u> |
| ConvF | <u>1.50</u> |

B. SAR Measurement Results

| | |
|---|------------|
| Frequency (MHz) | 836.400000 |
| Relative permittivity (real part) | 41.061714 |
| Relative permittivity (imaginary part) | 19.828222 |
| Conductivity (S/m) | 0.921351 |
| Variation (%) | 0.060000 |

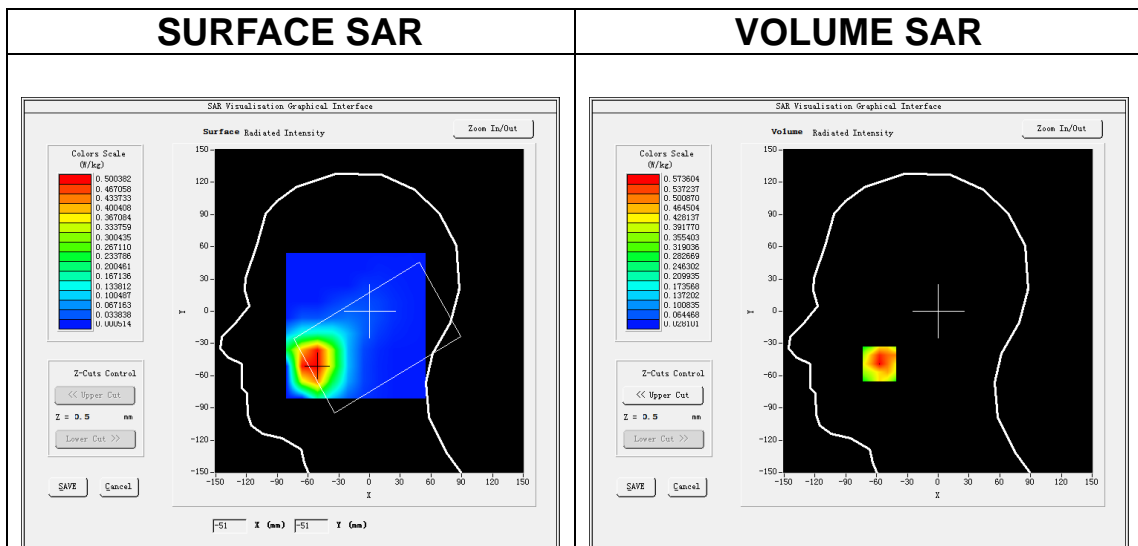

Maximum location: X=-57.00, Y=-49.00
SAR Peak: 0.93 W/kg

| | |
|-----------------------|----------|
| SAR 10g (W/Kg) | 0.346564 |
| SAR 1g (W/Kg) | 0.572382 |

| Z (mm) | 0.00 | 4.00 | 9.00 | 14.00 | 19.00 | 24.00 | 29.00 |
|------------|--------|--------|--------|--------|--------|--------|--------|
| SAR (W/Kg) | 0.9091 | 0.5736 | 0.3501 | 0.2499 | 0.1952 | 0.1297 | 0.0894 |

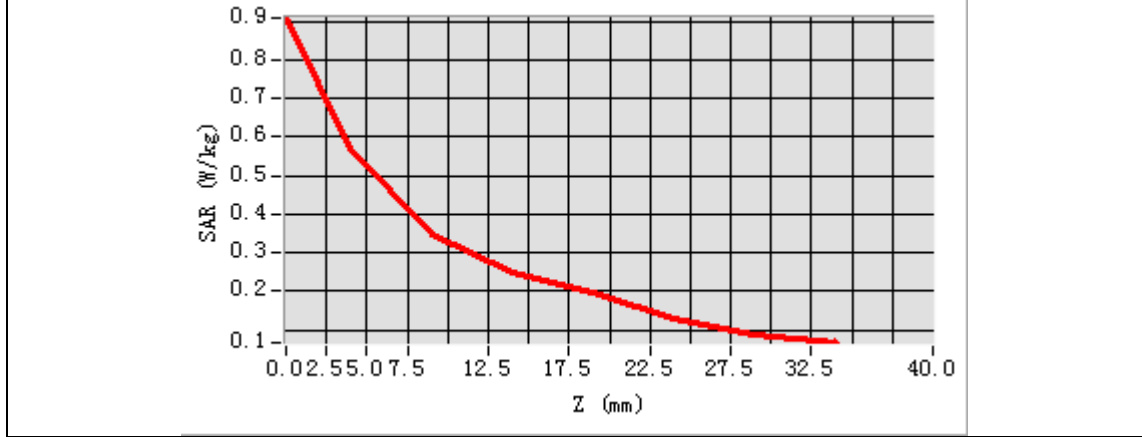

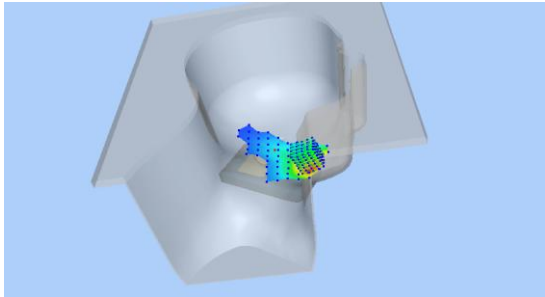
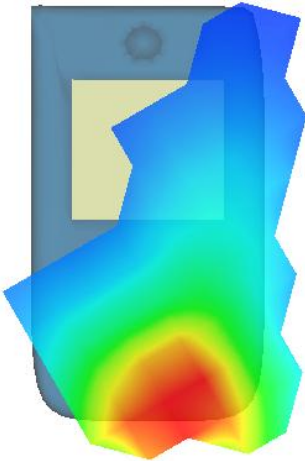
| 3D screen shot | Hot spot position |
|---|--|
|  |  |

MEASUREMENT 2

Date of measurement: 4/4/2023

A. Experimental conditions.

| | |
|------------------------|------------------------------------|
| Area Scan | <u>dx=15mm dy=15mm, h= 5.00 mm</u> |
| ZoomScan | <u>5x5x7, dx=8mm dy=8mm dz=5mm</u> |
| Phantom | <u>Validation plane</u> |
| Device Position | <u>Body</u> |
| Band | <u>GSM850</u> |
| Channels | <u>Middle</u> |
| Signal | <u>TDMA (Crest factor: 8.0)</u> |
| ConvF | <u>1.50</u> |

B. SAR Measurement Results

| | |
|---|------------|
| Frequency (MHz) | 836.400000 |
| Relative permittivity (real part) | 41.061714 |
| Relative permittivity (imaginary part) | 19.828222 |
| Conductivity (S/m) | 0.921351 |
| Variation (%) | -1.520000 |

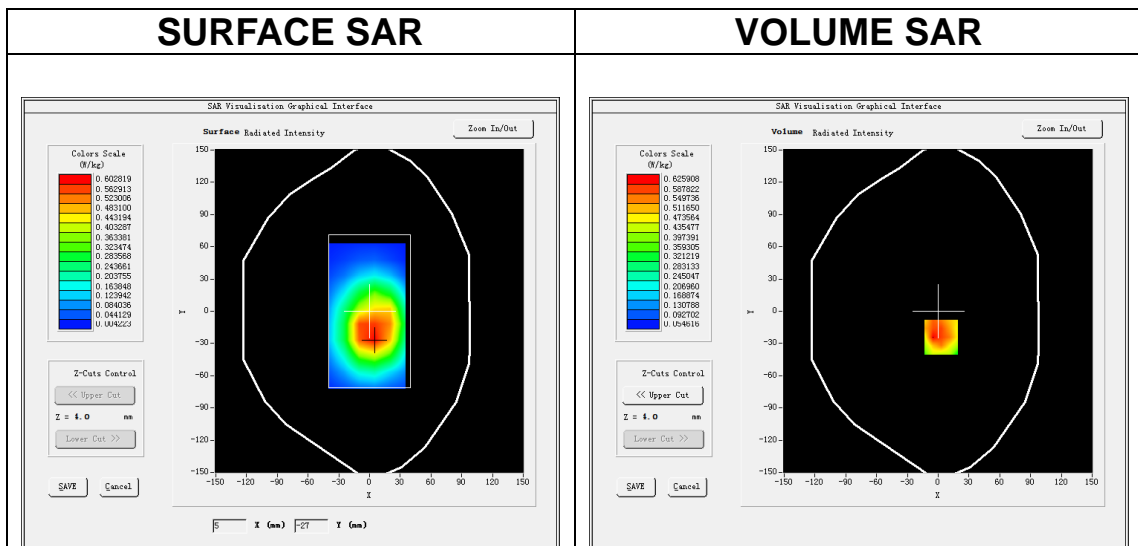

Maximum location: X=3.00, Y=-24.00
SAR Peak: 0.96 W/kg

| | |
|-----------------------|----------|
| SAR 10g (W/Kg) | 0.390829 |
| SAR 1g (W/Kg) | 0.615633 |

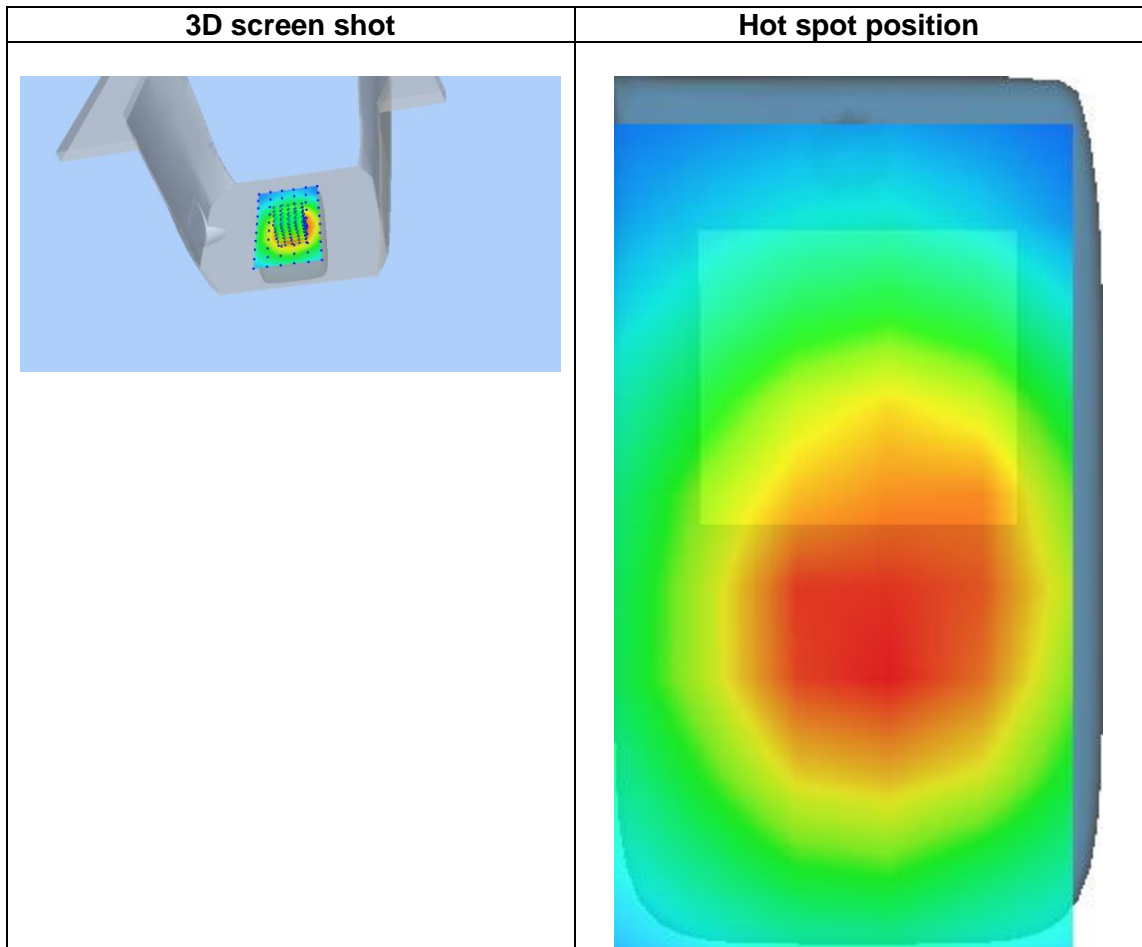
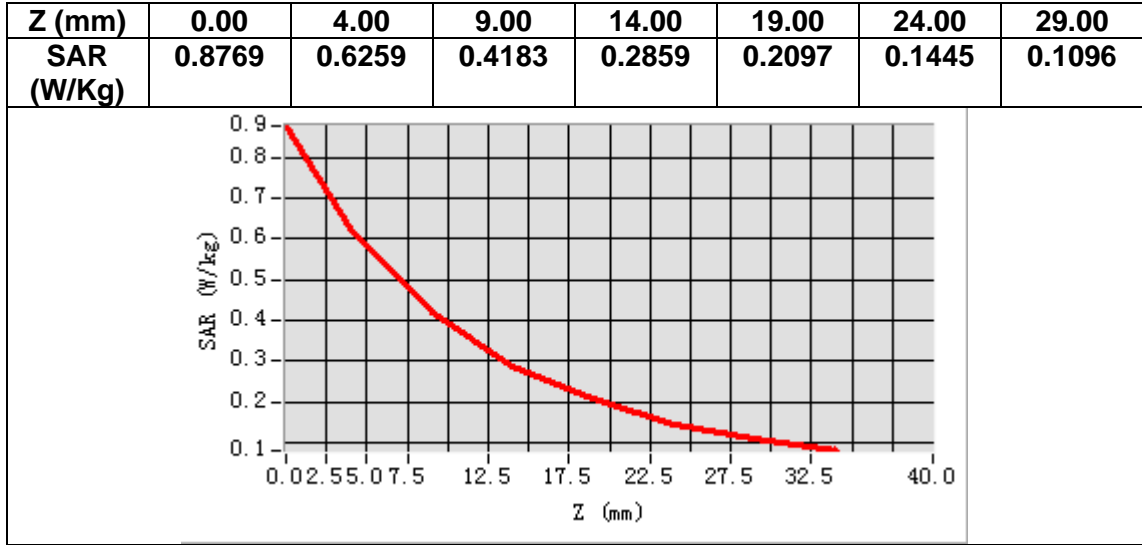

MEASUREMENT 3

Date of measurement: 3/4/2023

A. Experimental conditions.

| | |
|------------------------|------------------------------------|
| Area Scan | <u>dx=15mm dy=15mm, h= 5.00 mm</u> |
| ZoomScan | <u>5x5x7,dx=8mm dy=8mm dz=5mm</u> |
| Phantom | <u>Left head</u> |
| Device Position | <u>Cheek</u> |
| Band | <u>GSM1900</u> |
| Channels | <u>Middle</u> |
| Signal | <u>TDMA (Crest factor: 8.0)</u> |
| ConvF | <u>1.91</u> |

B. SAR Measurement Results

| | |
|---|-------------|
| Frequency (MHz) | 1880.000000 |
| Relative permittivity (real part) | 38.637070 |
| Relative permittivity (imaginary part) | 13.647636 |
| Conductivity (S/m) | 1.425420 |
| Variation (%) | 0.590000 |

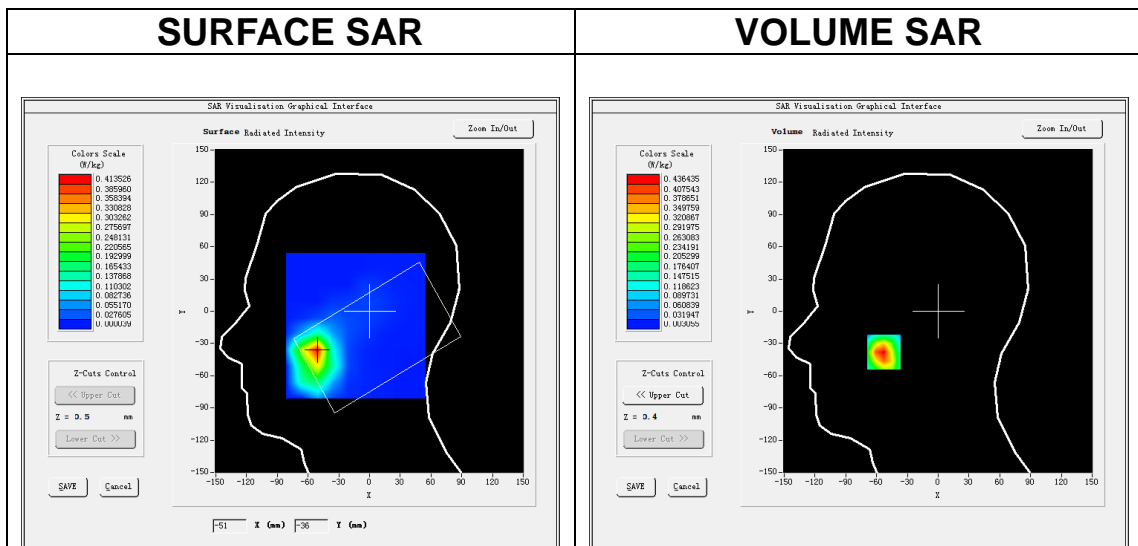

Maximum location: X=-53.00, Y=-38.00
SAR Peak: 0.74 W/kg

| | |
|-----------------------|----------|
| SAR 10g (W/Kg) | 0.207845 |
| SAR 1g (W/Kg) | 0.429026 |

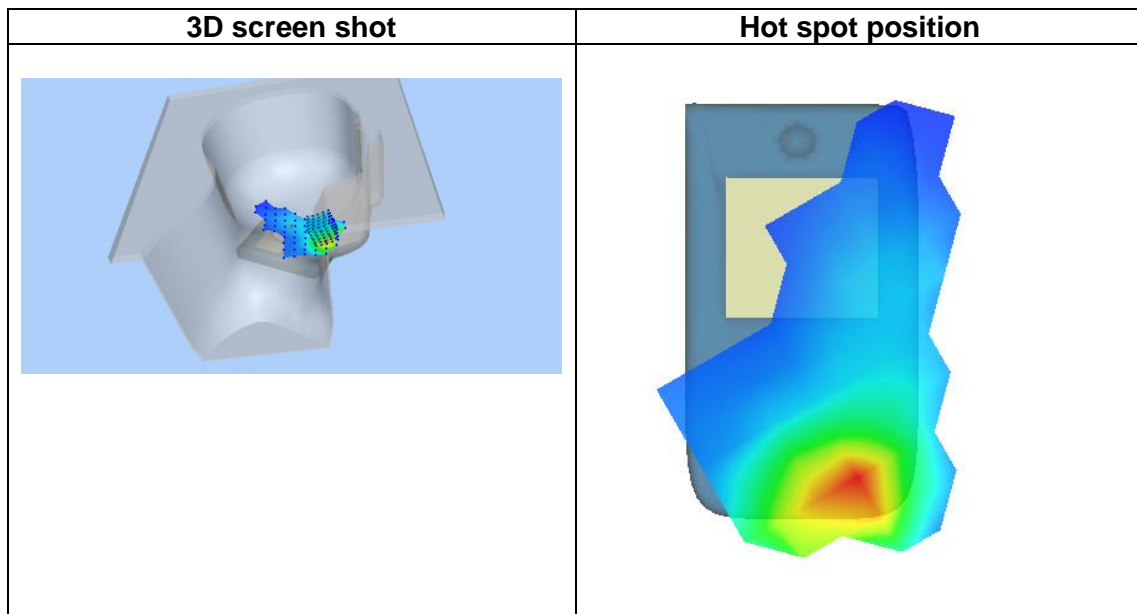
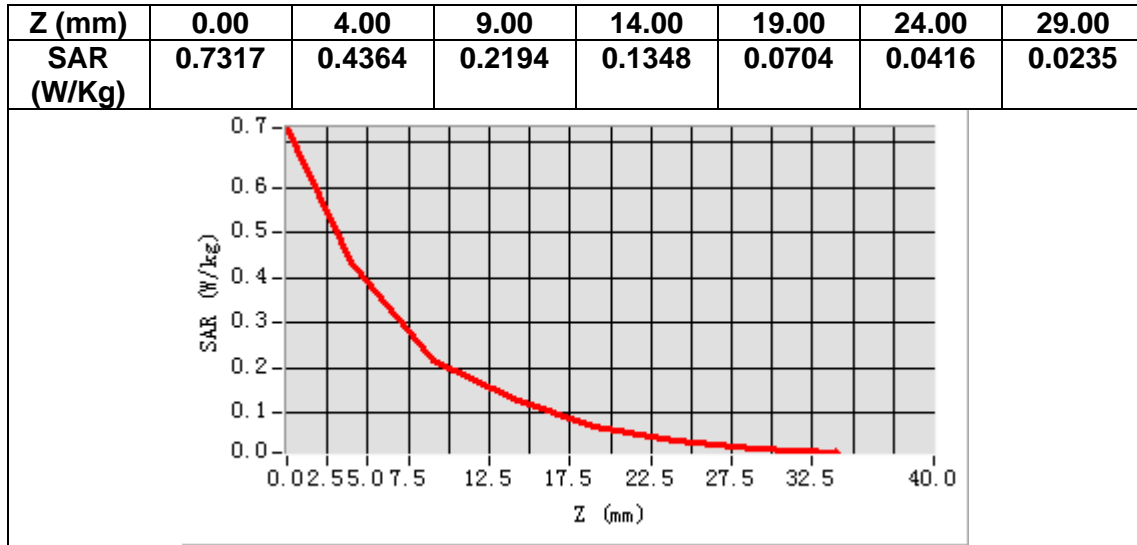

MEASUREMENT 4

Date of measurement: 3/4/2023

A. Experimental conditions.

| | |
|------------------------|------------------------------------|
| Area Scan | <u>dx=15mm dy=15mm, h= 5.00 mm</u> |
| ZoomScan | <u>5x5x7, dx=8mm dy=8mm dz=5mm</u> |
| Phantom | <u>Validation plane</u> |
| Device Position | <u>Body</u> |
| Band | <u>GSM1900</u> |
| Channels | <u>Middle</u> |
| Signal | <u>TDMA (Crest factor: 8.0)</u> |
| ConvF | <u>1.91</u> |

B. SAR Measurement Results

| | |
|---|-------------|
| Frequency (MHz) | 1880.000000 |
| Relative permittivity (real part) | 38.637070 |
| Relative permittivity (imaginary part) | 13.647636 |
| Conductivity (S/m) | 1.425420 |
| Variation (%) | 2.980000 |

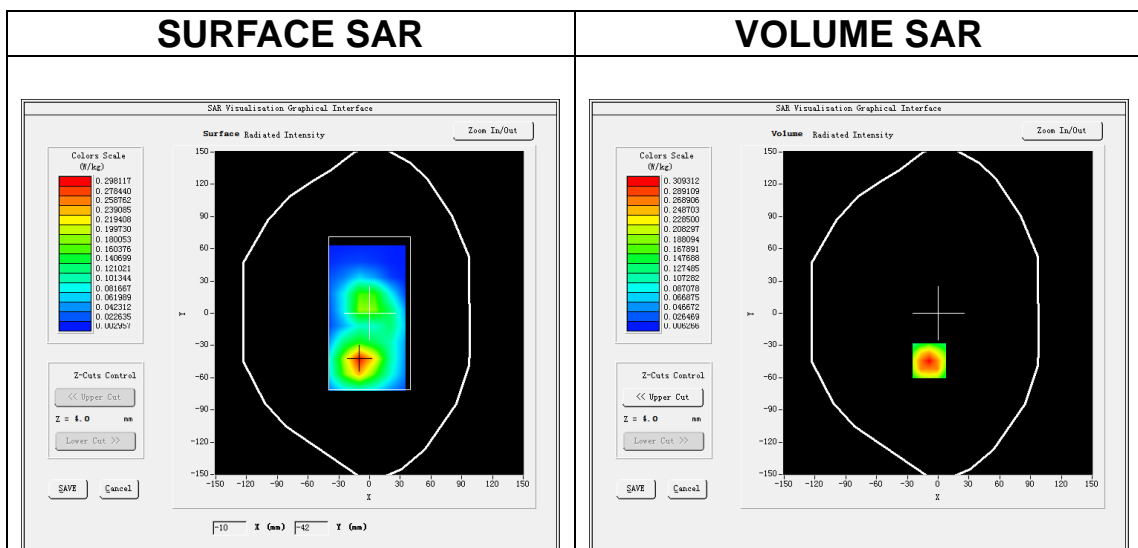

Maximum location: X=-9.00, Y=-44.00
SAR Peak: 0.45 W/kg

| | |
|-----------------------|----------|
| SAR 10g (W/Kg) | 0.166879 |
| SAR 1g (W/Kg) | 0.293314 |

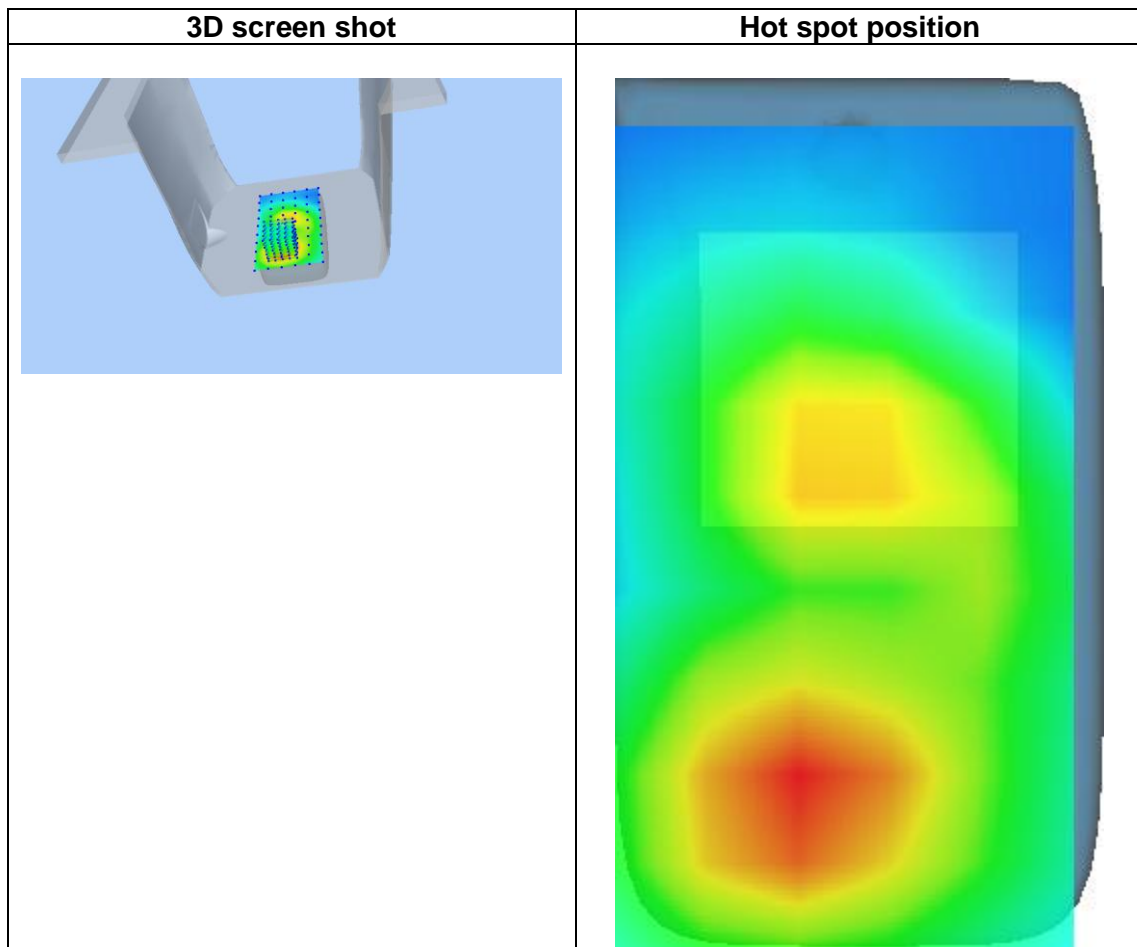
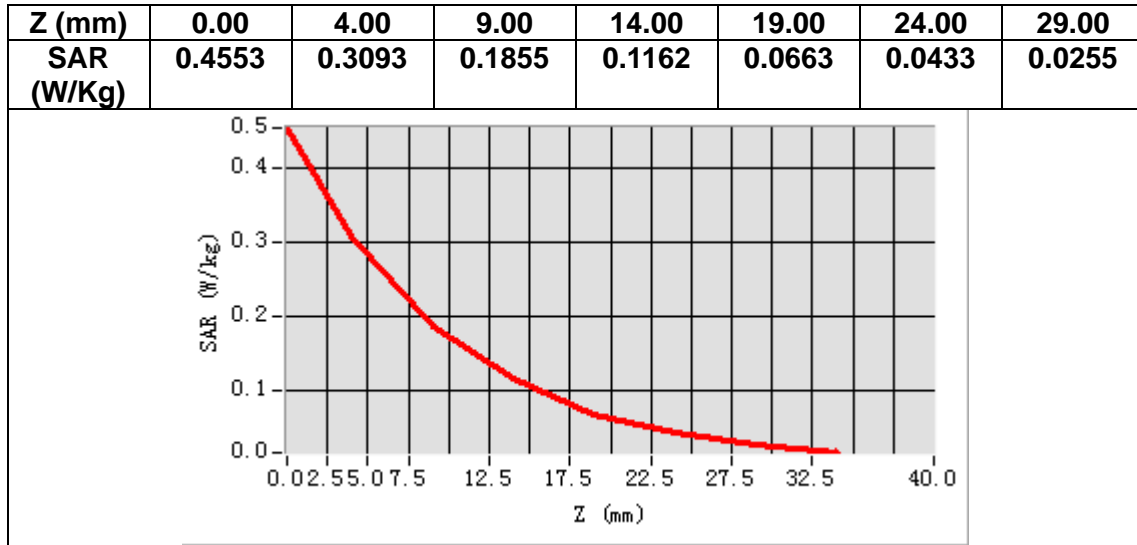

13. Appendix D. Calibration Certificate

| Table of contents |
|--|
| E Field Probe - SN 08/16 EPGO287 |
| 835 MHz Dipole - SN 03/15 DIP 0G835-347 |
| 1900 MHz Dipole - SN 03/15 DIP 1G900-350 |
| Extended Calibration Certificate |



COMOSAR E-Field Probe Calibration Report

Ref : ACR.60.1.21.MVGB.A

**SHENZHEN NTEK TESTING TECHNOLOGY
CO., LTD.**

**BUILDING E, FENDA SCIENCE PARK, SANWEI
COMMUNITY, XIXIANG STREET,
BAO'AN DISTRICT, SHENZHEN GUANGDONG, CHINA
MVG COMOSAR DOSIMETRIC E-FIELD PROBE
SERIAL NO.: SN 08/16 EPG0287**

Calibrated at MVG

Z.I. de la pointe du diable

**Technopôle Brest Iroise – 295 avenue Alexis de Rochon
29280 PLOUZANE - FRANCE**

Calibration date: 01/10/2023



Accreditations #2-6789 and #2-6814
Scope available on www.cofrac.fr

Summary:

This document presents the method and results from an accredited COMOSAR E-Field Probe calibration performed at MVG, using the CALIPROBE test bench, for use with a MVG COMOSAR system only. The test results covered by accreditation are traceable to the International System of Units (SI).



COMOSAR E-FIELD PROBE CALIBRATION REPORT

Ref: ACR.60.1.21.MVGB.A

| | Name | Function | Date | Signature |
|---------------|--------------|---------------------|-----------|---------------------|
| Prepared by : | Jérôme Luc | Technical Manager | 1/10/2023 | <i>JL</i> |
| Checked by : | Jérôme Luc | Technical Manager | 1/10/2023 | <i>JL</i> |
| Approved by : | Yann Toutain | Laboratory Director | 1/10/2023 | <i>Yann Toutain</i> |

2023.01.10
11:27:33
+01'00'

| | |
|----------------|--|
| | Customer Name |
| Distribution : | SHENZHEN NTEK TESTING TECHNOLOGY CO., LTD. |

| Issue | Name | Date | Modifications |
|-------|------------|-----------|-----------------|
| A | Jérôme Luc | 1/10/2023 | Initial release |
| | | | |
| | | | |



COMOSAR E-FIELD PROBE CALIBRATION REPORT

Ref: ACR.60.1.21.MVGB.A

TABLE OF CONTENTS

| | | |
|-----|---------------------------------------|----|
| 1 | Device Under Test | 4 |
| 2 | Product Description | 4 |
| 2.1 | General Information | 4 |
| 3 | Measurement Method | 4 |
| 3.1 | Linearity | 4 |
| 3.2 | Sensitivity | 5 |
| 3.3 | Lower Detection Limit | 5 |
| 3.4 | Isotropy | 5 |
| 3.1 | Boundary Effect | 5 |
| 4 | Measurement Uncertainty | 6 |
| 5 | Calibration Measurement Results | 6 |
| 5.1 | Sensitivity in air | 6 |
| 5.2 | Linearity | 7 |
| 5.3 | Sensitivity in liquid | 8 |
| 5.4 | Isotropy | 9 |
| 6 | List of Equipment | 10 |



COMOSAR E-FIELD PROBE CALIBRATION REPORT

Ref: ACR.60.1.21.MVGB.A

1 DEVICE UNDER TEST

| Device Under Test | |
|--|---|
| Device Type | COMOSAR DOSIMETRIC E FIELD PROBE |
| Manufacturer | MVG |
| Model | SSE2 |
| Serial Number | SN 08/16 EPGO287 |
| Product Condition (new / used) | Used |
| Frequency Range of Probe | 0.15 GHz-6GHz |
| Resistance of Three Dipoles at Connector | Dipole 1: R1=0.211 MΩ Dipole 2: R2=0.199 MΩ Dipole 3: R3=0.199 MΩ |

2 PRODUCT DESCRIPTION

2.1 GENERAL INFORMATION

MVG's COMOSAR E field Probes are built in accordance to the IEEE 1528, FCC KDB865664 D01, CENELEC EN62209 and CEI/IEC 62209 standards.



Figure 1 – MVG COMOSAR Dosimetric E field Dipole

| | |
|--|--------|
| Probe Length | 330 mm |
| Length of Individual Dipoles | 2 mm |
| Maximum external diameter | 8 mm |
| Probe Tip External Diameter | 2.5 mm |
| Distance between dipoles / probe extremity | 1 mm |

3 MEASUREMENT METHOD

The IEEE 1528, FCC KDB865664 D01, CENELEC EN62209 and CEI/IEC 62209 standards provide recommended practices for the probe calibrations, including the performance characteristics of interest and methods by which to assess their affect. All calibrations / measurements performed meet the fore mentioned standards.

3.1 LINEARITY

The evaluation of the linearity was done in free space using the waveguide, performing a power sweep to cover the SAR range 0.01W/kg to 100W/kg.



COMOSAR E-FIELD PROBE CALIBRATION REPORT

Ref. ACR.60.1.21.MVGB.A

3.2 SENSITIVITY

The sensitivity factors of the three dipoles were determined using a two step calibration method (air and tissue simulating liquid) using waveguides as outlined in the standards.

3.3 LOWER DETECTION LIMIT

The lower detection limit was assessed using the same measurement set up as used for the linearity measurement. The required lower detection limit is 10 mW/kg.

3.4 ISOTROPY

The axial isotropy was evaluated by exposing the probe to a reference wave from a standard dipole with the dipole mounted under the flat phantom in the test configuration suggested for system validations and checks. The probe was rotated along its main axis from 0 to 360 degrees in 15-degree steps. The hemispherical isotropy is determined by inserting the probe in a thin plastic box filled with tissue-equivalent liquid, with the plastic box illuminated with the fields from a half wave dipole. The dipole is rotated about its axis (0°–180°) in 15° increments. At each step the probe is rotated about its axis (0°–360°).

3.1 BOUNDARY EFFECT

The boundary effect is defined as the deviation between the SAR measured data and the expected exponential decay in the liquid when the probe is oriented normal to the interface. To evaluate this effect, the liquid filled flat phantom is exposed to fields from either a reference dipole or waveguide. With the probe normal to the phantom surface, the peak spatial average SAR is measured and compared to the analytical value at the surface.

The boundary effect uncertainty can be estimated according to the following uncertainty approximation formula based on linear and exponential extrapolations between the surface and $d_{be} + d_{step}$ along lines that are approximately normal to the surface:

$$SAR_{uncertainty} [\%] = \Delta SAR_{be} \frac{(d_{be} + d_{step})^2}{2d_{step}} \frac{(e^{-d_{be}/\delta})}{\delta/2} \text{ for } (d_{be} + d_{step}) < 10 \text{ mm}$$

where

- $SAR_{uncertainty}$ is the uncertainty in percent of the probe boundary effect
- d_{be} is the distance between the surface and the closest *zoom-scan* measurement point, in millimetre
- Δ_{step} is the separation distance between the first and second measurement points that are closest to the phantom surface, in millimetre, assuming the boundary effect at the second location is negligible
- δ is the minimum penetration depth in millimetres of the head tissue-equivalent liquids defined in this standard, i.e., $\delta \approx 14$ mm at 3 GHz;
- ΔSAR_{be} in percent of SAR is the deviation between the measured SAR value, at the distance d_{be} from the boundary, and the analytical SAR value.



COMOSAR E-FIELD PROBE CALIBRATION REPORT

Ref: ACR.60.1.21.MVGB.A

The measured worst case boundary effect SAR uncertainty [%] for scanning distances larger than 4mm is 1.0% Limit (±2%).

4 MEASUREMENT UNCERTAINTY

The guidelines outlined in the IEEE 1528, OET 65 Bulletin C, CENELEC EN50361 and CEI/IEC 62209 standards were followed to generate the measurement uncertainty associated with an E-field probe calibration using the waveguide technique. All uncertainties listed below represent an expanded uncertainty expressed at approximately the 95% confidence level using a coverage factor of k=2, traceable to the Internationally Accepted Guides to Measurement Uncertainty.

| Uncertainty analysis of the probe calibration in waveguide | | | | | |
|--|-----------------------|--------------------------|---------|----|--------------------------|
| ERROR SOURCES | Uncertainty value (%) | Probability Distribution | Divisor | ci | Standard Uncertainty (%) |
| Expanded uncertainty 95 % confidence level k = 2 | | | | | 14 % |

5 CALIBRATION MEASUREMENT RESULTS

| Calibration Parameters | |
|------------------------|-------------|
| Liquid Temperature | 20 +/- 1 °C |
| Lab Temperature | 20 +/- 1 °C |
| Lab Humidity | 30-70 % |

5.1 SENSITIVITY IN AIR

| Normx dipole 1 (µV/(V/m) ²) | Normy dipole 2 (µV/(V/m) ²) | Normz dipole 3 (µV/(V/m) ²) |
|---|---|---|
| 0.72 | 0.66 | 0.77 |

| DCP dipole 1 (mV) | DCP dipole 2 (mV) | DCP dipole 3 (mV) |
|-------------------|-------------------|-------------------|
| 107 | 110 | 110 |

Calibration curves $e_i=f(V)$ (i=1,2,3) allow to obtain E-field value using the formula:

$$E = \sqrt{E_1^2 + E_2^2 + E_3^2}$$



COMOSAR E-FIELD PROBE CALIBRATION REPORT

Ref: ACR.60.1.21.MVGB.A

Calibration curves

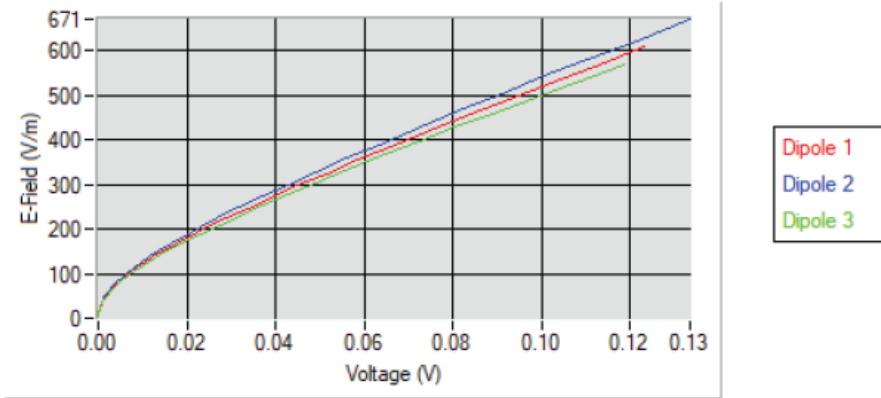

5.2 LINEARITY

Linearity

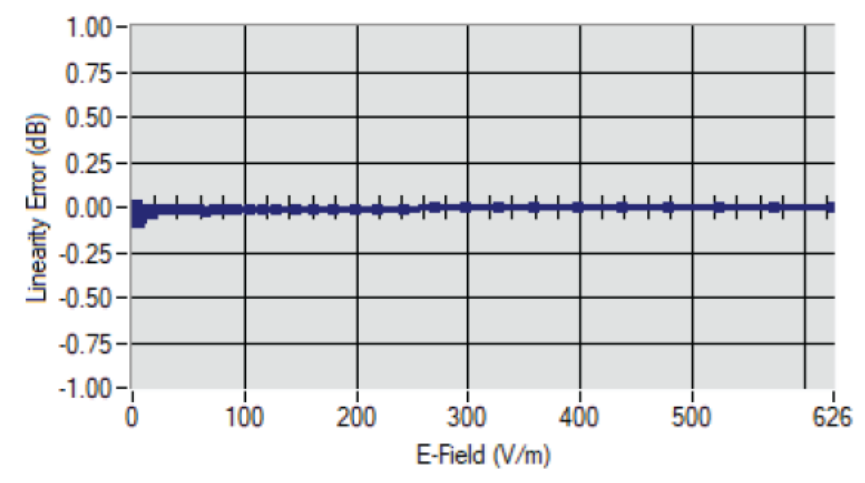

Linearity: +/-1.90% (+/-0.08dB)



COMOSAR E-FIELD PROBE CALIBRATION REPORT

Ref: ACR.60.1.21.MVGB.A

5.3 SENSITIVITY IN LIQUID

| <u>Liquid</u> | <u>Frequency</u> <u>(MHz +/-</u> <u>100MHz)</u> | <u>ConvF</u> |
|---------------|---|--------------|
| HL750 | 750 | 1.49 |
| HL850 | 835 | 1.50 |
| HL900 | 900 | 1.61 |
| HL1800 | 1800 | 1.73 |
| HL1900 | 1900 | 1.91 |
| HL2000 | 2000 | 1.97 |
| HL2300 | 2300 | 1.92 |
| HL2450 | 2450 | 1.98 |
| HL2600 | 2600 | 1.87 |
| HL3300 | 3300 | 1.79 |
| HL3500 | 3500 | 1.85 |
| HL3700 | 3700 | 1.79 |
| HL3900 | 3900 | 2.07 |
| HL4200 | 4200 | 2.21 |
| HL4600 | 4600 | 2.25 |
| HL4900 | 4900 | 2.05 |
| HL5200 | 5200 | 1.80 |
| HL5400 | 5400 | 2.05 |
| HL5600 | 5600 | 2.16 |
| HL5800 | 5800 | 2.07 |

LOWER DETECTION LIMIT: 8mW/kg



COMOSAR E-FIELD PROBE CALIBRATION REPORT

Ref: ACR.60.1.21.MVGB.A

5.4 ISOTROPY

HL1800 MHz

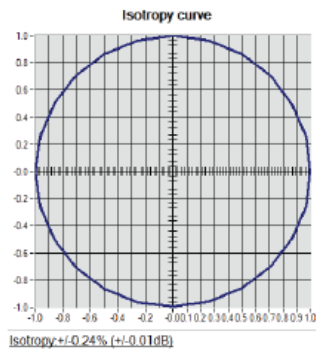



COMOSAR E-FIELD PROBE CALIBRATION REPORT

Ref. ACR.60.1.21.MVGB.A

6 LIST OF EQUIPMENT

| Equipment Summary Sheet | | | | |
|------------------------------------|-------------------------|--------------------|---|---|
| Equipment Description | Manufacturer / Model | Identification No. | Current Calibration Date | Next Calibration Date |
| Flat Phantom | MVG | SN-20/09-SAM71 | Validated. No cal required. | Validated. No cal required. |
| COMOSAR Test Bench | Version 3 | NA | Validated. No cal required. | Validated. No cal required. |
| Network Analyzer | Rohde & Schwarz ZVM | 100203 | 05/2022 | 05/2025 |
| Network Analyzer – Calibration kit | Rohde & Schwarz ZV-Z235 | 101223 | 05/2022 | 05/2025 |
| Multimeter | Keithley 2000 | 1160271 | 02/2022 | 02/2025 |
| Signal Generator | Rohde & Schwarz SMB | 106589 | 04/2022 | 04/2025 |
| Amplifier | Aethercomm | SN 046 | Characterized prior to test. No cal required. | Characterized prior to test. No cal required. |
| Power Meter | NI-USB 5680 | 170100013 | 05/2022 | 05/2025 |
| Directional Coupler | Narda 4216-20 | 01386 | Characterized prior to test. No cal required. | Characterized prior to test. No cal required. |
| Waveguide | Mega Industries | 069Y7-158-13-712 | Validated. No cal required. | Validated. No cal required. |
| Waveguide Transition | Mega Industries | 069Y7-158-13-701 | Validated. No cal required. | Validated. No cal required. |
| Waveguide Termination | Mega Industries | 069Y7-158-13-701 | Validated. No cal required. | Validated. No cal required. |
| Temperature / Humidity Sensor | Testo 184 H1 | 44220687 | 05/2020 | 05/2023 |



SAR Reference Dipole Calibration Report

Ref : ACR.60.3.21.MVGB.A

SHENZHEN NTEK TESTING TECHNOLOGY CO., LTD.

BUILDING E, FENDA SCIENCE PARK, SANWEI
COMMUNITY, XIXIANG STREET,
BAO'AN DISTRICT, SHENZHEN GUANGDONG, CHINA

MVG COMOSAR REFERENCE DIPOLE

FREQUENCY: 835 MHZ

SERIAL NO.: SN 03/15 DIP0G835-347

Calibrated at MVG

Z.I. de la pointe du diable

Technopôle Brest Iroise – 295 avenue Alexis de Rochon

29280 PLOUZANE - FRANCE

Calibration date: 03/01/2021



Accreditations #2-6789 and #2-6814
Scope available on www.cofrac.fr

Summary:

This document presents the method and results from an accredited SAR reference dipole calibration performed at MVG, using the COMOSAR test bench. The test results covered by accreditation are traceable to the International System of Units (SI).



SAR REFERENCE DIPOLE CALIBRATION REPORT

Ref: ACR.60.3.21.MVGB.A

| | Name | Function | Date | Signature |
|---------------|--------------|---------------------|----------|---------------------|
| Prepared by : | Jérôme Luc | Technical Manager | 3/1/2021 | <i>JLS</i> |
| Checked by : | Jérôme Luc | Technical Manager | 3/1/2021 | <i>JLS</i> |
| Approved by : | Yann Toutain | Laboratory Director | 3/1/2021 | <i>Yann Toutain</i> |

Made d'emploi: 2021.03.01 13:09:12 +01'00'

PHILIPS

| | Customer Name |
|----------------|--|
| Distribution : | SHENZHEN NTEK TESTING TECHNOLOGY CO., LTD. |

| Issue | Name | Date | Modifications |
|-------|------------|----------|-----------------|
| A | Jérôme Luc | 3/1/2021 | Initial release |
| | | | |
| | | | |



SAR REFERENCE DIPOLE CALIBRATION REPORT

Ref. ACR.60.3.21.MVGB.A

TABLE OF CONTENTS

| | | |
|-----|--------------------------------------|----|
| 1 | Introduction..... | 4 |
| 2 | Device Under Test..... | 4 |
| 3 | Product Description..... | 4 |
| 3.1 | General Information..... | 4 |
| 4 | Measurement Method..... | 5 |
| 4.1 | Return Loss Requirements..... | 5 |
| 4.2 | Mechanical Requirements..... | 5 |
| 5 | Measurement Uncertainty..... | 5 |
| 5.1 | Return Loss..... | 5 |
| 5.2 | Dimension Measurement..... | 5 |
| 5.3 | Validation Measurement..... | 5 |
| 6 | Calibration Measurement Results..... | 6 |
| 6.1 | Return Loss and Impedance..... | 6 |
| 6.2 | Mechanical Dimensions..... | 6 |
| 7 | Validation measurement..... | 7 |
| 7.1 | Measurement Condition..... | 7 |
| 7.2 | Head Liquid Measurement..... | 7 |
| 7.3 | Measurement Result..... | 8 |
| 8 | List of Equipment..... | 10 |



SAR REFERENCE DIPOLE CALIBRATION REPORT

Ref: ACR.60.3.21.MVGB.A

1 INTRODUCTION

This document contains a summary of the requirements set forth by the IEEE 1528, FCC KDBs and CEI/IEC 62209 standards for reference dipoles used for SAR measurement system validations and the measurements that were performed to verify that the product complies with the fore mentioned standards.

2 DEVICE UNDER TEST

| Device Under Test | |
|--------------------------------|----------------------------------|
| Device Type | COMOSAR 835 MHz REFERENCE DIPOLE |
| Manufacturer | MVG |
| Model | SID835 |
| Serial Number | SN 03/15 DIP0G835-347 |
| Product Condition (new / used) | Used |

3 PRODUCT DESCRIPTION

3.1 GENERAL INFORMATION

MVG’s COMOSAR Validation Dipoles are built in accordance to the IEEE 1528, FCC KDBs and CEI/IEC 62209 standards. The product is designed for use with the COMOSAR test bench only.



Figure 1 – MVG COMOSAR Validation Dipole



SAR REFERENCE DIPOLE CALIBRATION REPORT

Ref: ACR.60.3.21.MVGB.A

4 MEASUREMENT METHOD

The IEEE 1528, FCC KDBs and CEI/IEC 62209 standards provide requirements for reference dipoles used for system validation measurements. The following measurements were performed to verify that the product complies with the fore mentioned standards.

4.1 RETURN LOSS REQUIREMENTS

The dipole used for SAR system validation measurements and checks must have a return loss of -20 dB or better. The return loss measurement shall be performed against a liquid filled phantom, with the phantom constructed as outlined in the fore mentioned standards. A direct method is used with a network analyser and its calibration kit, both with a valid ISO17025 calibration.

4.2 MECHANICAL REQUIREMENTS

The IEEE Std. 1528 and CEI/IEC 62209 standards specify the mechanical components and dimensions of the validation dipoles, with the dimension's frequency and phantom shell thickness dependent. The COMOSAR test bench employs a 2 mm phantom shell thickness therefore the dipoles sold for use with the COMOSAR test bench comply with the requirements set forth for a 2 mm phantom shell thickness. A direct method is used with a ISO17025 calibrated caliper.

5 MEASUREMENT UNCERTAINTY

All uncertainties listed below represent an expanded uncertainty expressed at approximately the 95% confidence level using a coverage factor of k=2, traceable to the Internationally Accepted Guides to Measurement Uncertainty.

5.1 RETURN LOSS

The following uncertainties apply to the return loss measurement:

| Frequency band | Expanded Uncertainty on Return Loss |
|----------------|-------------------------------------|
| 400-6000MHz | 0.08 LIN |

5.2 DIMENSION MEASUREMENT

The following uncertainties apply to the dimension measurements:

| Length (mm) | Expanded Uncertainty on Length |
|-------------|--------------------------------|
| 0 - 300 | 0.20 mm |
| 300 - 450 | 0.44 mm |

5.3 VALIDATION MEASUREMENT

The guidelines outlined in the IEEE 1528, FCC KDBs, CENELEC EN50361 and CEI/IEC 62209 standards were followed to generate the measurement uncertainty for validation measurements.

| Scan Volume | Expanded Uncertainty |
|-------------|----------------------|
| | |



SAR REFERENCE DIPOLE CALIBRATION REPORT

Ref. ACR.60.3.21.MVGB.A

| | |
|------|------------|
| 1 g | 19 % (SAR) |
| 10 g | 19 % (SAR) |

6 CALIBRATION MEASUREMENT RESULTS

6.1 RETURN LOSS AND IMPEDANCE

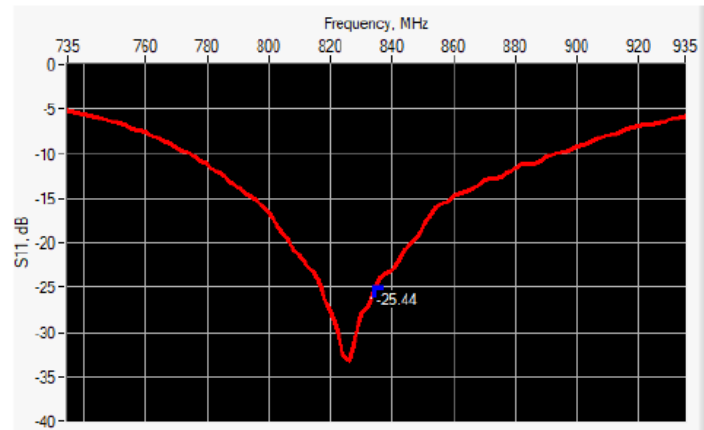

| Frequency (MHz) | Return Loss (dB) | Requirement (dB) | Impedance |
|-----------------|------------------|------------------|-----------------|
| 835 | -25.44 | -20 | 54.4 Ω - 2.9 jΩ |

6.2 MECHANICAL DIMENSIONS

| Frequency MHz | L mm | | h mm | | d mm | |
|---------------|-------------|----------|-------------|----------|------------|----------|
| | required | measured | required | measured | required | measured |
| 300 | 420.0 ±1 %. | | 250.0 ±1 %. | | 6.35 ±1 %. | |
| 450 | 290.0 ±1 %. | | 166.7 ±1 %. | | 6.35 ±1 %. | |
| 750 | 176.0 ±1 %. | | 100.0 ±1 %. | | 6.35 ±1 %. | |
| 835 | 161.0 ±1 %. | - | 89.8 ±1 %. | - | 3.6 ±1 %. | - |
| 900 | 149.0 ±1 %. | | 83.3 ±1 %. | | 3.6 ±1 %. | |
| 1450 | 89.1 ±1 %. | | 51.7 ±1 %. | | 3.6 ±1 %. | |
| 1500 | 80.5 ±1 %. | | 50.0 ±1 %. | | 3.6 ±1 %. | |
| 1640 | 79.0 ±1 %. | | 45.7 ±1 %. | | 3.6 ±1 %. | |
| 1750 | 75.2 ±1 %. | | 42.9 ±1 %. | | 3.6 ±1 %. | |
| 1800 | 72.0 ±1 %. | | 41.7 ±1 %. | | 3.6 ±1 %. | |
| 1900 | 68.0 ±1 %. | | 39.5 ±1 %. | | 3.6 ±1 %. | |
| 1950 | 66.3 ±1 %. | | 38.5 ±1 %. | | 3.6 ±1 %. | |
| 2000 | 64.5 ±1 %. | | 37.5 ±1 %. | | 3.6 ±1 %. | |
| 2100 | 61.0 ±1 %. | | 35.7 ±1 %. | | 3.6 ±1 %. | |
| 2300 | 55.5 ±1 %. | | 32.6 ±1 %. | | 3.6 ±1 %. | |
| 2450 | 51.5 ±1 %. | | 30.4 ±1 %. | | 3.6 ±1 %. | |



SAR REFERENCE DIPOLE CALIBRATION REPORT

Ref. ACR.60.3.21.MVGB.A

| | | | | | | |
|------|------------|--|------------|--|-----------|--|
| 2600 | 48.5 ±1 %. | | 28.8 ±1 %. | | 3.6 ±1 %. | |
| 3000 | 41.5 ±1 %. | | 25.0 ±1 %. | | 3.6 ±1 %. | |
| 3500 | 37.0±1 %. | | 26.4 ±1 %. | | 3.6 ±1 %. | |
| 3700 | 34.7±1 %. | | 26.4 ±1 %. | | 3.6 ±1 %. | |

7 VALIDATION MEASUREMENT

The IEEE Std. 1528, FCC KDBs and CEI/IEC 62209 standards state that the system validation measurements must be performed using a reference dipole meeting the fore mentioned return loss and mechanical dimension requirements. The validation measurement must be performed against a liquid filled flat phantom, with the phantom constructed as outlined in the fore mentioned standards. Per the standards, the dipole shall be positioned below the bottom of the phantom, with the dipole length centered and parallel to the longest dimension of the flat phantom, with the top surface of the dipole at the described distance from the bottom surface of the phantom.

7.1 MEASUREMENT CONDITION

| | |
|---|--|
| Software | OPENSAR V5 |
| Phantom | SN 13/09 SAM68 |
| Probe | SN 41/18 EPGO333 |
| Liquid | Head Liquid Values: eps' : 40.6 sigma : 0.89 |
| Distance between dipole center and liquid | 15.0 mm |
| Area scan resolution | dx=8mm/dy=8mm |
| Zoon Scan Resolution | dx=8mm/dy=8mm/dz=5mm |
| Frequency | 835835 MHz |
| Input power | 20 dBm |
| Liquid Temperature | 20 +/- 1 °C |
| Lab Temperature | 20 +/- 1 °C |
| Lab Humidity | 30-70 % |

7.2 HEAD LIQUID MEASUREMENT

| Frequency MHz | Relative permittivity (ε _r) | | Conductivity (σ) S/m | |
|---------------|---|----------|----------------------|----------|
| | required | measured | required | measured |
| 300 | 45.3 ±10 % | | 0.87 ±10 % | |
| 450 | 43.5 ±10 % | | 0.87 ±10 % | |
| 750 | 41.9 ±10 % | | 0.89 ±10 % | |
| 835 | 41.5 ±10 % | 40.6 | 0.90 ±10 % | 0.89 |
| 900 | 41.5 ±10 % | | 0.97 ±10 % | |
| 1450 | 40.5 ±10 % | | 1.20 ±10 % | |
| 1500 | 40.4 ±10 % | | 1.23 ±10 % | |
| 1640 | 40.2 ±10 % | | 1.31 ±10 % | |
| 1750 | 40.1 ±10 % | | 1.37 ±10 % | |
| 1800 | 40.0 ±10 % | | 1.40 ±10 % | |
| 1900 | 40.0 ±10 % | | 1.40 ±10 % | |
| 1950 | 40.0 ±10 % | | 1.40 ±10 % | |
| 2000 | 40.0 ±10 % | | 1.40 ±10 % | |



SAR REFERENCE DIPOLE CALIBRATION REPORT

Ref: ACR.60.3.21.MVGB.A

| | | | | |
|------|------------|--|------------|--|
| 2100 | 39.8 ±10 % | | 1.49 ±10 % | |
| 2300 | 39.5 ±10 % | | 1.67 ±10 % | |
| 2450 | 39.2 ±10 % | | 1.80 ±10 % | |
| 2600 | 39.0 ±10 % | | 1.96 ±10 % | |
| 3000 | 38.5 ±10 % | | 2.40 ±10 % | |
| 3500 | 37.9 ±10 % | | 2.91 ±10 % | |

7.3 MEASUREMENT RESULT

The IEEE Std. 1528 and CEI/IEC 62209 standards state that the system validation measurements should produce the SAR values shown below (for phantom thickness of 2 mm), within the uncertainty for the system validation. All SAR values are normalized to 1 W forward power. In bracket, the measured SAR is given with the used input power.

| Frequency MHz | 1 g SAR (W/kg/W) | | 10 g SAR (W/kg/W) | |
|---------------|------------------|-------------|-------------------|-------------|
| | required | measured | required | measured |
| 300 | 2.85 | | 1.94 | |
| 450 | 4.58 | | 3.06 | |
| 750 | 8.49 | | 5.55 | |
| 835 | 9.56 | 9.84 (0.98) | 6.22 | 6.22 (0.62) |
| 900 | 10.9 | | 6.99 | |
| 1450 | 29 | | 16 | |
| 1500 | 30.5 | | 16.8 | |
| 1640 | 34.2 | | 18.4 | |
| 1750 | 36.4 | | 19.3 | |
| 1800 | 38.4 | | 20.1 | |
| 1900 | 39.7 | | 20.5 | |
| 1950 | 40.5 | | 20.9 | |
| 2000 | 41.1 | | 21.1 | |
| 2100 | 43.6 | | 21.9 | |
| 2300 | 48.7 | | 23.3 | |
| 2450 | 52.4 | | 24 | |
| 2600 | 55.3 | | 24.6 | |
| 3000 | 63.8 | | 25.7 | |
| 3500 | 67.1 | | 25 | |



SAR REFERENCE DIPOLE CALIBRATION REPORT

Ref: ACR.60.3.21.MVGB.A

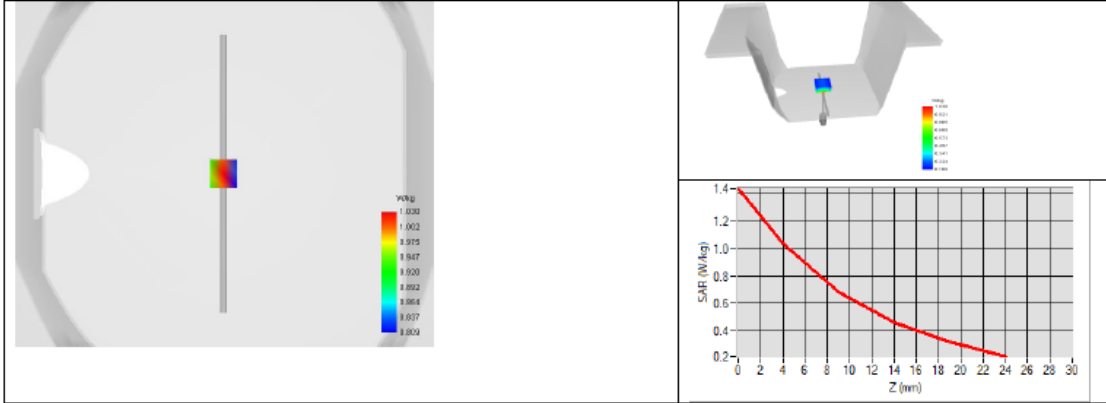



SAR REFERENCE DIPOLE CALIBRATION REPORT

Ref: ACR.60.3.21.MVGB.A

8 LIST OF EQUIPMENT

| Equipment Summary Sheet | | | | |
|------------------------------------|-------------------------|--------------------|---|---|
| Equipment Description | Manufacturer / Model | Identification No. | Current Calibration Date | Next Calibration Date |
| SAM Phantom | MVG | SN-13/09-SAM68 | Validated. No cal required. | Validated. No cal required. |
| COMOSAR Test Bench | Version 3 | NA | Validated. No cal required. | Validated. No cal required. |
| Network Analyzer | Rohde & Schwarz ZVM | 100203 | 05/2019 | 05/2022 |
| Network Analyzer – Calibration kit | Rohde & Schwarz ZV-Z235 | 101223 | 05/2019 | 05/2022 |
| Calipers | Mitutoyo | SN 0009732 | 10/2019 | 10/2022 |
| Reference Probe | MVG | EPGO333 SN 41/18 | 05/2020 | 05/2021 |
| Multimeter | Keithley 2000 | 1160271 | 02/2020 | 02/2023 |
| Signal Generator | Rohde & Schwarz SMB | 106589 | 04/2019 | 04/2022 |
| Amplifier | Aethercomm | SN 046 | Characterized prior to test. No cal required. | Characterized prior to test. No cal required. |
| Power Meter | NI-USB 5680 | 170100013 | 05/2019 | 05/2022 |
| Directional Coupler | Narda 4216-20 | 01386 | Characterized prior to test. No cal required. | Characterized prior to test. No cal required. |
| Temperature / Humidity Sensor | Testo 184 H1 | 44220687 | 05/2020 | 05/2023 |



SAR Reference Dipole Calibration Report

Ref : ACR.60.6.21.MVGB.A

**SHENZHEN NTEK TESTING TECHNOLOGY
CO., LTD.**

**BUILDING E, FENDA SCIENCE PARK, SANWEI
COMMUNITY, XIXIANG STREET,
BAO'AN DISTRICT, SHENZHEN GUANGDONG, CHINA
MVG COMOSAR REFERENCE DIPOLE**

**FREQUENCY: 1900 MHZ
SERIAL NO.: SN 03/15 DIP1G900-350**

**Calibrated at MVG
Z.I. de la pointe du diable
Technopôle Brest Iroise – 295 avenue Alexis de Rochon
29280 PLOUZANE - FRANCE**

Calibration date: 03/01/2021



Accreditations #2-6789 and #2-6814
Scope available on www.cofrac.fr

Summary:

This document presents the method and results from an accredited SAR reference dipole calibration performed at MVG, using the COMOSAR test bench. The test results covered by accreditation are traceable to the International System of Units (SI).



SAR REFERENCE DIPOLE CALIBRATION REPORT

Ref. ACR.60.6.21.MVGB.A

| | Name | Function | Date | Signature |
|---------------|--------------|---------------------|----------|---------------------|
| Prepared by : | Jérôme Luc | Technical Manager | 3/1/2021 | <i>JL</i> |
| Checked by : | Jérôme Luc | Technical Manager | 3/1/2021 | <i>JL</i> |
| Approved by : | Yann Toutain | Laboratory Director | 3/1/2021 | <i>Yann Toutain</i> |

Mode d'emploi
2021.03.0
1 13:11:42
+01'00'

PHILIPS

| | Customer Name |
|----------------|---|
| Distribution : | SHENZHEN NTEK TESTING TECHNOLOGY CO., LTD. |

| Issue | Name | Date | Modifications |
|-------|------------|----------|-----------------|
| A | Jérôme Luc | 3/1/2021 | Initial release |
| | | | |
| | | | |



SAR REFERENCE DIPOLE CALIBRATION REPORT

Ref: ACR.60.6.21.MVGB.A

TABLE OF CONTENTS

| | | |
|-----|--------------------------------------|----|
| 1 | Introduction..... | 4 |
| 2 | Device Under Test | 4 |
| 3 | Product Description | 4 |
| 3.1 | General Information | 4 |
| 4 | Measurement Method | 5 |
| 4.1 | Return Loss Requirements | 5 |
| 4.2 | Mechanical Requirements | 5 |
| 5 | Measurement Uncertainty..... | 5 |
| 5.1 | Return Loss | 5 |
| 5.2 | Dimension Measurement | 5 |
| 5.3 | Validation Measurement | 5 |
| 6 | Calibration Measurement Results..... | 6 |
| 6.1 | Return Loss and Impedance | 6 |
| 6.2 | Mechanical Dimensions | 6 |
| 7 | Validation measurement | 7 |
| 7.1 | Measurement Condition | 7 |
| 7.2 | Head Liquid Measurement | 7 |
| 7.3 | Measurement Result | 8 |
| 8 | List of Equipment | 10 |



SAR REFERENCE DIPOLE CALIBRATION REPORT

Ref: ACR.60.6.21.MVGB.A

1 INTRODUCTION

This document contains a summary of the requirements set forth by the IEEE 1528, FCC KDBs and CEI/IEC 62209 standards for reference dipoles used for SAR measurement system validations and the measurements that were performed to verify that the product complies with the fore mentioned standards.

2 DEVICE UNDER TEST

| Device Under Test | |
|--------------------------------|-----------------------------------|
| Device Type | COMOSAR 1900 MHz REFERENCE DIPOLE |
| Manufacturer | MVG |
| Model | SID1900 |
| Serial Number | SN 03/15 DIP1G900-350 |
| Product Condition (new / used) | Used |

3 PRODUCT DESCRIPTION

3.1 GENERAL INFORMATION

MVG’s COMOSAR Validation Dipoles are built in accordance to the IEEE 1528, FCC KDBs and CEI/IEC 62209 standards. The product is designed for use with the COMOSAR test bench only.



Figure 1 – MVG COMOSAR Validation Dipole



SAR REFERENCE DIPOLE CALIBRATION REPORT

Ref. ACR.60.6.21.MVGB.A

4 MEASUREMENT METHOD

The IEEE 1528, FCC KDBs and CEI/IEC 62209 standards provide requirements for reference dipoles used for system validation measurements. The following measurements were performed to verify that the product complies with the fore mentioned standards.

4.1 RETURN LOSS REQUIREMENTS

The dipole used for SAR system validation measurements and checks must have a return loss of -20 dB or better. The return loss measurement shall be performed against a liquid filled flat phantom, with the phantom constructed as outlined in the fore mentioned standards. A direct method is used with a network analyser and its calibration kit, both with a valid ISO17025 calibration.

4.2 MECHANICAL REQUIREMENTS

The IEEE Std. 1528 and CEI/IEC 62209 standards specify the mechanical components and dimensions of the validation dipoles, with the dimension's frequency and phantom shell thickness dependent. The COMOSAR test bench employs a 2 mm phantom shell thickness therefore the dipoles sold for use with the COMOSAR test bench comply with the requirements set forth for a 2 mm phantom shell thickness. A direct method is used with a ISO17025 calibrated caliper.

5 MEASUREMENT UNCERTAINTY

All uncertainties listed below represent an expanded uncertainty expressed at approximately the 95% confidence level using a coverage factor of k=2, traceable to the Internationally Accepted Guides to Measurement Uncertainty.

5.1 RETURN LOSS

The following uncertainties apply to the return loss measurement:

| Frequency band | Expanded Uncertainty on Return Loss |
|----------------|-------------------------------------|
| 400-6000MHz | 0.08 LIN |

5.2 DIMENSION MEASUREMENT

The following uncertainties apply to the dimension measurements:

| Length (mm) | Expanded Uncertainty on Length |
|-------------|--------------------------------|
| 0 - 300 | 0.20 mm |
| 300 - 450 | 0.44 mm |

5.3 VALIDATION MEASUREMENT

The guidelines outlined in the IEEE 1528, FCC KDBs, CENELEC EN50361 and CEI/IEC 62209 standards were followed to generate the measurement uncertainty for validation measurements.

| Scan Volume | Expanded Uncertainty |
|-------------|----------------------|
| | |



SAR REFERENCE DIPOLE CALIBRATION REPORT

Ref. ACR.60.6.21.MVGB.A

| | |
|------|------------|
| 1 g | 19 % (SAR) |
| 10 g | 19 % (SAR) |

6 CALIBRATION MEASUREMENT RESULTS

6.1 RETURN LOSS AND IMPEDANCE

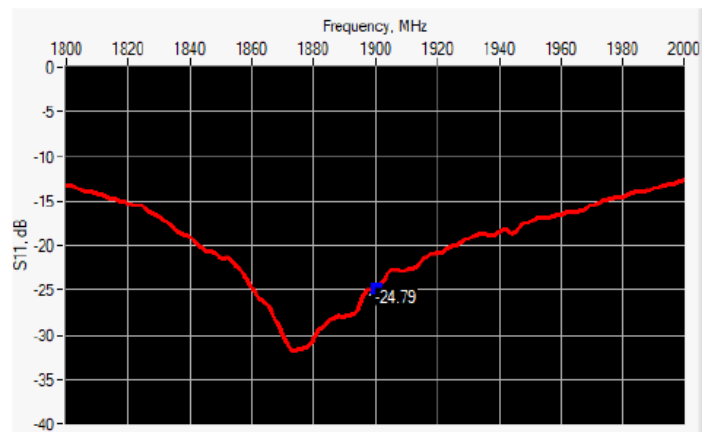

| Frequency (MHz) | Return Loss (dB) | Requirement (dB) | Impedance |
|-----------------|------------------|------------------|-----------------|
| 1900 | -24.79 | -20 | 50.8 Ω + 5.7 jΩ |

6.2 MECHANICAL DIMENSIONS

| Frequency MHz | L mm | | h mm | | d mm | |
|---------------|-------------|----------|-------------|----------|------------|----------|
| | required | measured | required | measured | required | measured |
| 300 | 420.0 ±1 %. | | 250.0 ±1 %. | | 6.35 ±1 %. | |
| 450 | 290.0 ±1 %. | | 166.7 ±1 %. | | 6.35 ±1 %. | |
| 750 | 176.0 ±1 %. | | 100.0 ±1 %. | | 6.35 ±1 %. | |
| 835 | 161.0 ±1 %. | | 89.8 ±1 %. | | 3.6 ±1 %. | |
| 900 | 149.0 ±1 %. | | 83.3 ±1 %. | | 3.6 ±1 %. | |
| 1450 | 89.1 ±1 %. | | 51.7 ±1 %. | | 3.6 ±1 %. | |
| 1500 | 80.5 ±1 %. | | 50.0 ±1 %. | | 3.6 ±1 %. | |
| 1640 | 79.0 ±1 %. | | 45.7 ±1 %. | | 3.6 ±1 %. | |
| 1750 | 75.2 ±1 %. | | 42.9 ±1 %. | | 3.6 ±1 %. | |
| 1800 | 72.0 ±1 %. | | 41.7 ±1 %. | | 3.6 ±1 %. | |
| 1900 | 68.0 ±1 %. | - | 39.5 ±1 %. | - | 3.6 ±1 %. | - |
| 1950 | 66.3 ±1 %. | | 38.5 ±1 %. | | 3.6 ±1 %. | |
| 2000 | 64.5 ±1 %. | | 37.5 ±1 %. | | 3.6 ±1 %. | |
| 2100 | 61.0 ±1 %. | | 35.7 ±1 %. | | 3.6 ±1 %. | |
| 2300 | 55.5 ±1 %. | | 32.6 ±1 %. | | 3.6 ±1 %. | |
| 2450 | 51.5 ±1 %. | | 30.4 ±1 %. | | 3.6 ±1 %. | |



SAR REFERENCE DIPOLE CALIBRATION REPORT

Ref: ACR.60.6.21.MVGB.A

| | | | | | | |
|------|------------|--|------------|--|-----------|--|
| 2600 | 48.5 ±1 %. | | 28.8 ±1 %. | | 3.6 ±1 %. | |
| 3000 | 41.5 ±1 %. | | 25.0 ±1 %. | | 3.6 ±1 %. | |
| 3500 | 37.0±1 %. | | 26.4 ±1 %. | | 3.6 ±1 %. | |
| 3700 | 34.7±1 %. | | 26.4 ±1 %. | | 3.6 ±1 %. | |

7 VALIDATION MEASUREMENT

The IEEE Std. 1528, FCC KDBs and CEI/IEC 62209 standards state that the system validation measurements must be performed using a reference dipole meeting the fore mentioned return loss and mechanical dimension requirements. The validation measurement must be performed against a liquid filled flat phantom, with the phantom constructed as outlined in the fore mentioned standards. Per the standards, the dipole shall be positioned below the bottom of the phantom, with the dipole length centered and parallel to the longest dimension of the flat phantom, with the top surface of the dipole at the described distance from the bottom surface of the phantom.

7.1 MEASUREMENT CONDITION

| | |
|---|--|
| Software | OPENSAR V5 |
| Phantom | SN 13/09 SAM68 |
| Probe | SN 41/18 EPGO333 |
| Liquid | Head Liquid Values: ϵ_r' : 43.3 σ : 1.41 |
| Distance between dipole center and liquid | 10.0 mm |
| Area scan resolution | $dx=8mm/dy=8mm$ |
| Zoon Scan Resolution | $dx=8mm/dy=8mm/dz=5mm$ |
| Frequency | 19001900 MHz |
| Input power | 20 dBm |
| Liquid Temperature | 20 +/- 1 °C |
| Lab Temperature | 20 +/- 1 °C |
| Lab Humidity | 30-70 % |

7.2 HEAD LIQUID MEASUREMENT

| Frequency MHz | Relative permittivity (ϵ_r') | | Conductivity (σ) S/m | |
|------------------|---|----------|-------------------------------|----------|
| | required | measured | required | measured |
| 300 | 45.3 ±10 % | | 0.87 ±10 % | |
| 450 | 43.5 ±10 % | | 0.87 ±10 % | |
| 750 | 41.9 ±10 % | | 0.89 ±10 % | |
| 835 | 41.5 ±10 % | | 0.90 ±10 % | |
| 900 | 41.5 ±10 % | | 0.97 ±10 % | |
| 1450 | 40.5 ±10 % | | 1.20 ±10 % | |
| 1500 | 40.4 ±10 % | | 1.23 ±10 % | |
| 1640 | 40.2 ±10 % | | 1.31 ±10 % | |
| 1750 | 40.1 ±10 % | | 1.37 ±10 % | |
| 1800 | 40.0 ±10 % | | 1.40 ±10 % | |
| 1900 | 40.0 ±10 % | 43.3 | 1.40 ±10 % | 1.41 |
| 1950 | 40.0 ±10 % | | 1.40 ±10 % | |
| 2000 | 40.0 ±10 % | | 1.40 ±10 % | |

Page: 7/10

Template_ACR.DDD.N.YY.MVGB.ISSUE_SAR Reference Dipole vG

This document shall not be reproduced, except in full or in part, without the written approval of MVG. The information contained herein is to be used only for the purpose for which it is submitted and is not to be released in whole or part without written approval of MVG.



SAR REFERENCE DIPOLE CALIBRATION REPORT

Ref. ACR.60.6.21.MVGB.A

| | | | | |
|------|------------|--|------------|--|
| 2100 | 39.8 ±10 % | | 1.49 ±10 % | |
| 2300 | 39.5 ±10 % | | 1.67 ±10 % | |
| 2450 | 39.2 ±10 % | | 1.80 ±10 % | |
| 2600 | 39.0 ±10 % | | 1.96 ±10 % | |
| 3000 | 38.5 ±10 % | | 2.40 ±10 % | |
| 3500 | 37.9 ±10 % | | 2.91 ±10 % | |

7.3 MEASUREMENT RESULT

The IEEE Std. 1528 and CEI/IEC 62209 standards state that the system validation measurements should produce the SAR values shown below (for phantom thickness of 2 mm), within the uncertainty for the system validation. All SAR values are normalized to 1 W forward power. In bracket, the measured SAR is given with the used input power.

| Frequency MHz | 1 g SAR (W/kg/W) | | 10 g SAR (W/kg/W) | |
|---------------|------------------|--------------|-------------------|--------------|
| | required | measured | required | measured |
| 300 | 2.85 | | 1.94 | |
| 450 | 4.58 | | 3.06 | |
| 750 | 8.49 | | 5.55 | |
| 835 | 9.56 | | 6.22 | |
| 900 | 10.9 | | 6.99 | |
| 1450 | 29 | | 16 | |
| 1500 | 30.5 | | 16.8 | |
| 1640 | 34.2 | | 18.4 | |
| 1750 | 36.4 | | 19.3 | |
| 1800 | 38.4 | | 20.1 | |
| 1900 | 39.7 | 40.37 (4.04) | 20.5 | 20.48 (2.05) |
| 1950 | 40.5 | | 20.9 | |
| 2000 | 41.1 | | 21.1 | |
| 2100 | 43.6 | | 21.9 | |
| 2300 | 48.7 | | 23.3 | |
| 2450 | 52.4 | | 24 | |
| 2600 | 55.3 | | 24.6 | |
| 3000 | 63.8 | | 25.7 | |
| 3500 | 67.1 | | 25 | |



SAR REFERENCE DIPOLE CALIBRATION REPORT

Ref: ACR.60.6.21.MVGB.A

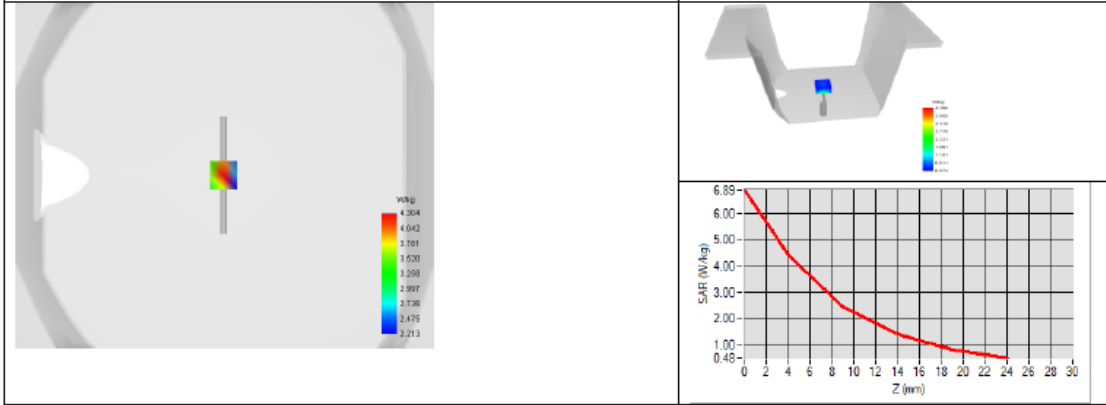



SAR REFERENCE DIPOLE CALIBRATION REPORT

Ref: ACR.60.6.21.MVGB.A

8 LIST OF EQUIPMENT

| Equipment Summary Sheet | | | | |
|------------------------------------|-------------------------|--------------------|---|---|
| Equipment Description | Manufacturer / Model | Identification No. | Current Calibration Date | Next Calibration Date |
| SAM Phantom | MVG | SN-13/09-SAM68 | Validated. No cal required. | Validated. No cal required. |
| COMOSAR Test Bench | Version 3 | NA | Validated. No cal required. | Validated. No cal required. |
| Network Analyzer | Rohde & Schwarz ZVM | 100203 | 05/2019 | 05/2022 |
| Network Analyzer – Calibration kit | Rohde & Schwarz ZV-Z235 | 101223 | 05/2019 | 05/2022 |
| Calipers | Mitutoyo | SN 0009732 | 10/2019 | 10/2022 |
| Reference Probe | MVG | EPGO333 SN 41/18 | 05/2020 | 05/2021 |
| Multimeter | Keithley 2000 | 1160271 | 02/2020 | 02/2023 |
| Signal Generator | Rohde & Schwarz SMB | 106589 | 04/2019 | 04/2022 |
| Amplifier | Aethercomm | SN 046 | Characterized prior to test. No cal required. | Characterized prior to test. No cal required. |
| Power Meter | NI-USB 5680 | 170100013 | 05/2019 | 05/2022 |
| Directional Coupler | Narda 4216-20 | 01386 | Characterized prior to test. No cal required. | Characterized prior to test. No cal required. |
| Temperature / Humidity Sensor | Testo 184 H1 | 44220687 | 05/2020 | 05/2023 |

<Justification of the extended calibration>

If dipoles are verified in return loss (<-20dB, within 20% of prior calibration for below 3GHz, and <-8dB, within 20% of prior calibration for 5GHz to 6GHz), and in impedance (within 5 ohm of prior calibration), the annual calibration is not necessary and the calibration interval can be extended.

<Head 835MHz>

| Return Loss (dB) | Delta (%) | Impedance | Delta(ohm) | Date of Measurement |
|------------------|-----------|-----------|------------|---------------------|
| -25.44 | - | 54.40 | - | Mar. 01, 2021 |
| -25.803 | 1.43 | 54.492 | 0.092 | Feb. 28, 2022 |
| -23.947 | 5.87 | 56.615 | 2.215 | Feb. 18, 2023 |

The return loss is <-20dB, within 20% of prior calibration; the impedance is within 5 ohm of prior calibration. Therefore the verification result should support extended calibration.

Dipole Verification Data

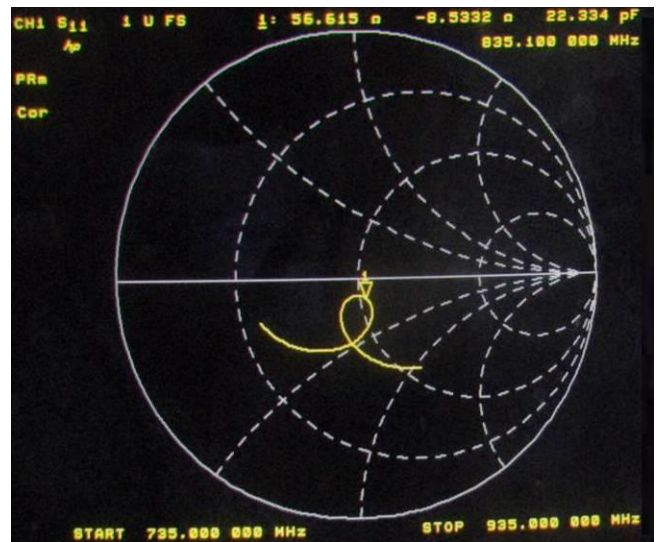
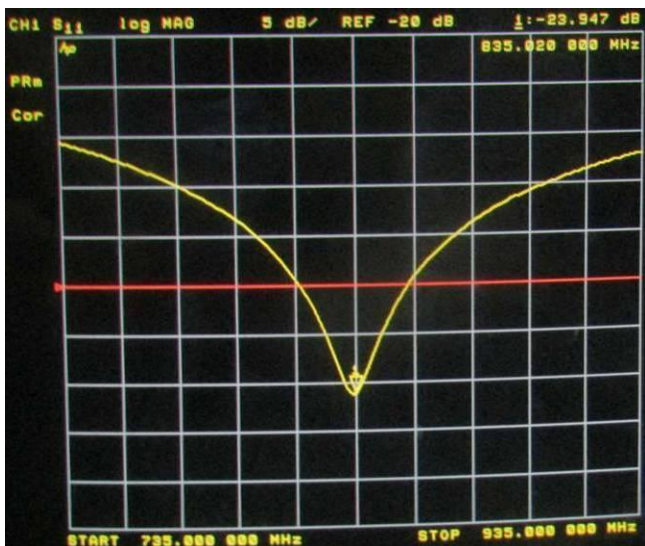
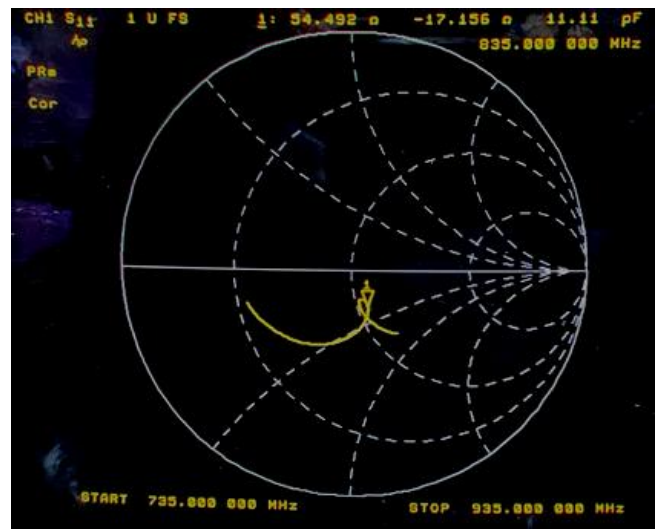
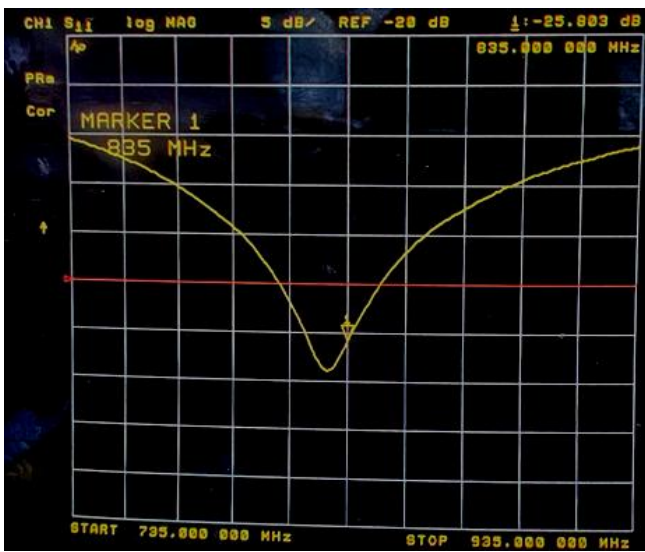

<Head 1900MHz>

| Return Loss (dB) | Delta (%) | Impedance | Delta(ohm) | Date of Measurement |
|------------------|-----------|-----------|------------|---------------------|
| -24.79 | - | 50.80 | - | Mar. 01, 2021 |
| -24.518 | 1.10 | 50.516 | 0.284 | Feb. 28, 2022 |
| -23.144 | 6.64 | 53.604 | 2.804 | Feb. 20, 2023 |

The return loss is <-20dB, within 20% of prior calibration; the impedance is within 5 ohm of prior calibration. Therefore the verification result should support extended calibration.

Dipole Verification Data

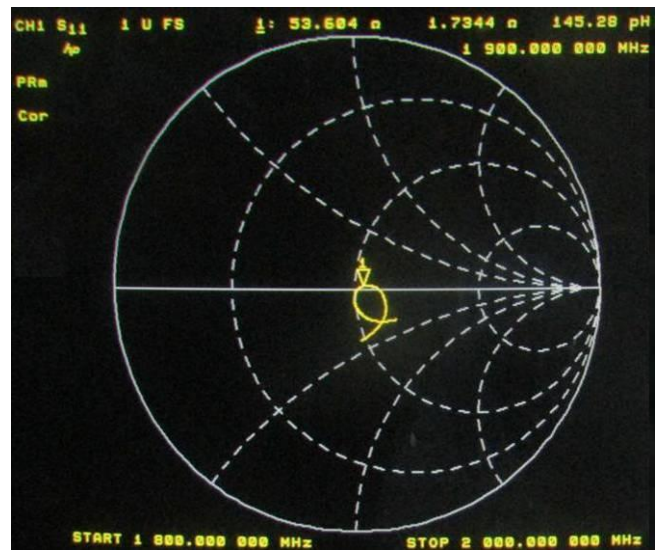
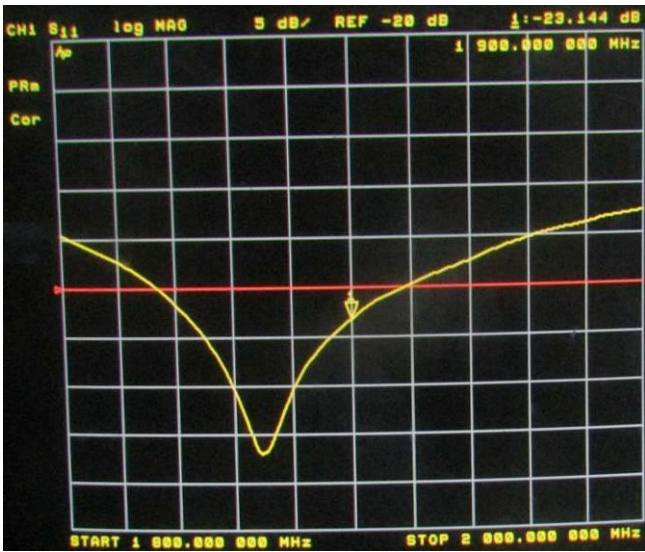
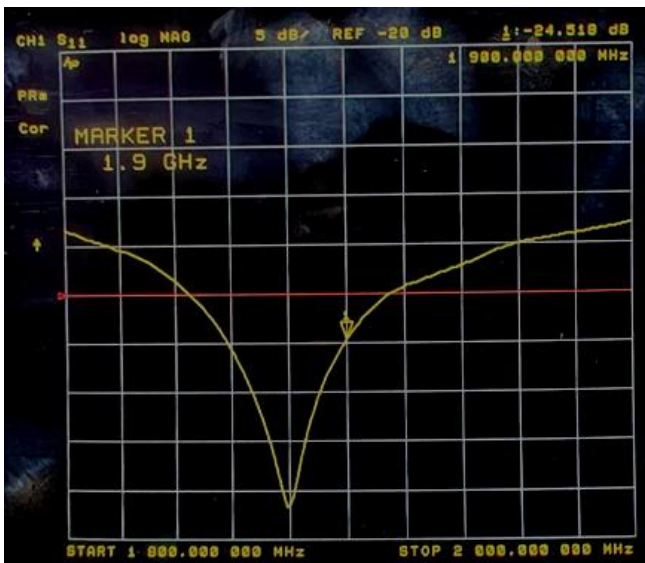

END