

# SKYVIPER VISTA

HD VIDEO DRONE  
STREAM AND RECORD

STREAM AND RECORD  
HI-DEF VIDEO

12+



## POWERING UP AND PAIRING REMOTE

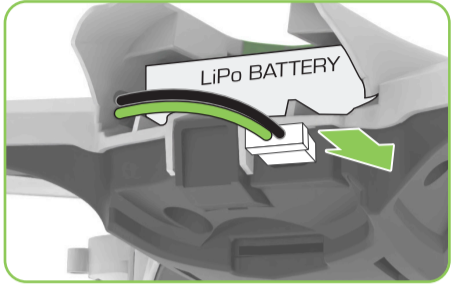

Insert fully charged LiPo battery.



Place the drone on level surface.



Turn on controller.



Once blinking lights turn solid, drone is ready to fly.

## FLIGHT CONTROLS

### THROTTLE STICK

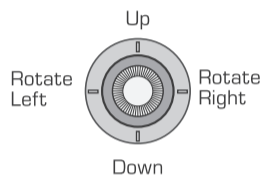

### DIRECTIONAL STICK

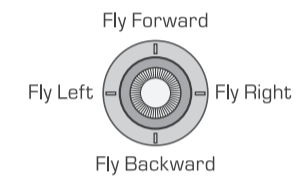

### Stunt and Recording Buttons



### TAKING PHOTOS OR RECORDING VIDEO

- Once Vista is connected to the app, choose photo or video mode by pressing the icon on the app screen.
- Press the shoulder button on the remote to take a still image or to start and stop video recordings. Still images and videos will be stored in the photo library on your device.

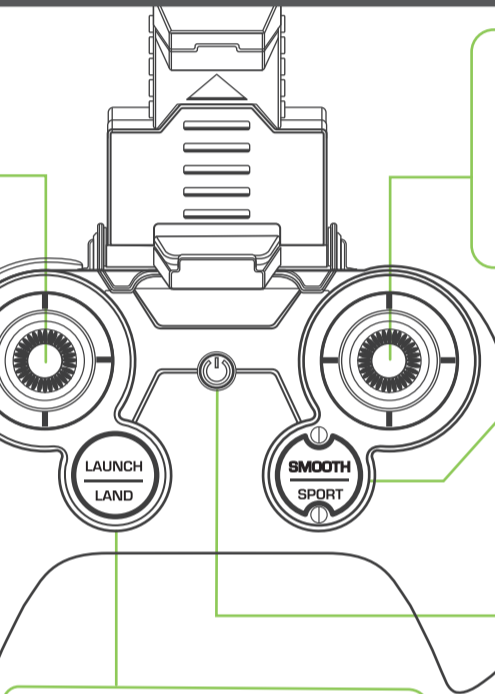

### Flight Mode Button



### Power Button

PRESS to turn remote on.  
PRESS AND HOLD to turn remote off.

### EMERGENCY STOP

If you PRESS during flight, the drone will initiate an immediate quick-fall emergency landing. This should be done ONLY if absolutely necessary, as an emergency landing could result in damage if flying over 10 feet.

### LAUNCH/LAND BUTTON

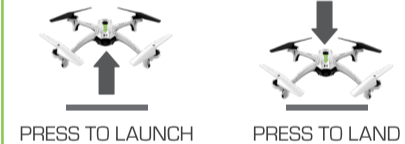

## FLIGHT BASICS

To make flying easier, place the drone on the ground in front of you with the drone facing away from you (green blades forward). You should be facing the same way the drone is facing.



Press LAUNCH to automatically launch a few feet off the ground.



Move Throttle thumbstick up or down to make drone fly higher or lower and left or right to rotate.



Use Directional thumbstick to fly forward, backward, left or right.



Press LAND to automatically land.

You can also manually land the drone by holding throttle in the down position to descend. Continue holding down once the drone reaches the ground. When the drone recognizes it has landed, the controller will play two beeps and the propellers will stop spinning.

## FLIGHT MODES

**SMOOTH** mode is best when streaming live video. In this mode, movements are slightly dampened and flying is steadier to help improve video quality.



**SPORT** mode is best when flying just for the fun of it. The drone's response rate is increased for sharper turns and faster speeds.



### POSITION HOLD

Position Hold uses Surface Scan™ ground tracking (optical flow) to maintain a perfect hover. It also prevents drifting when you have no hands on the controller. Position Hold is active in both SMOOTH and SPORT modes. Always make sure the Surface Scan viewer on the underside of the drone is unobstructed.

**IMPORTANT:** Ground tracking requires good lighting for maximum performance, therefore flying in low light conditions is NOT RECOMMENDED.



## STREAMING AND RECORDING VIDEO

### DOWNLOAD THE SKYVIPER VIDEO VIEWER 2.0 APP FROM THE APP STORE OR GOOGLE PLAY.



- Open your device's WiFi setting and select the network starting with SKYVIPER\_
- Default WiFi password : skyviper
- Open the SkyViper Video View 2.0 app.
- To reset drone WiFi password to the default, plug battery into drone and place upside-down on a flat surface, turn on controller and wait for them to pair, hold both video & stunt buttons for 5 seconds until you hear a beep from the controller and the drone's LEDs flash.

### ADJUSTABLE CAMERA ANGLE

The drone camera angle is adjustable to suit your preference. Point forward for recording flying action, straight down for aerial photos. (Remove protective film from lens before use.)



## ONE TOUCH STUNTS

### BARREL ROLL LEFT OR RIGHT

While flying forward (or reverse), tap the STUNT button.

### FLIP IN 4 DIRECTIONS

While hovering, hold the STUNT button and tap the direction stick in the direction you want the drone to flip.

### CAUTION!

The drone should be flying at least 10 feet in the air with a minimum clearance of 10 feet in all directions before attempting stunt functions.

# SKYVIPER VISTA

## HD VIDEO DRONE STREAM AND RECORD

### CONTENTS

- Streaming Video Drone
- USB Charging Cable
- Rechargeable 3.7V 1200 mAh LiPo Battery
- Controller
- Phone Mount
- Screwdriver & Extra Screws
- Blade Guards
- 4 Replacement Propellers

### INSTALLING BLADE GUARDS AND REPLACING DAMAGED PROPELLERS

Blade guards are not required for flight, but are recommended for extending the life of the propellers, especially if you are a beginning pilot. Insert blade guards into motor mounts as shown.

Use the included screwdriver to remove propellers, then pull up to detach. Both propellers and motor mounts are marked with a letter. Propellers must be properly matched with the corresponding motor mount in order for the drone to fly properly.



### CONNECTING BATTERY



- Open the battery latch (Press back of latch and lift up)
- Insert battery
- Close the battery latch
- Connect the battery

### ADULT SUPERVISION REQUIRED

Before each use, an adult should check this product and the LiPo battery to ensure no damage or hazards exist. Drone has rotating blades that move at high speed, posing danger of damage and injury. Use of included blade guards strongly recommended. Pilots are responsible for any actions that result in damage or injury from the improper operation of drone. Adequate flying space is required. Avoid flying near interior fans and/or vents as they may make flying difficult to control. Keep a safe distance away from streets, public thoroughfares and power lines. Never attempt to retrieve drone from any location higher than your reach (such as rooftops or trees) or from any location that poses a safety hazard. Never fly drone at night. Keep drone in sight at all times during operation. Discontinue operation immediately if drone flies out of your field of view. Do not fly near spectators or animals. Keep spinning rotors away from fingers, hair, eyes and other body parts. Always launch from a flat surface. Never leave drone unattended while it is turned on. Read all enclosed information before operating.

### THIS PRODUCT CONTAINS A LITHIUM-POLYMER BATTERY 3.7V 1200mAh:

LiPo batteries have a severe risk of fire and injury if they are improperly handled or misused. They may explode, overheat or ignite. Read all following precautions and instructions regarding the care and use of LiPo batteries.

The LiPo battery is only to be used with the drone and charger included with this product.

- Keep away from flammable materials.
- Do not expose to direct sunlight.
- Do not place in fire or leave in hot places.
- Do not drop or make subject to strong impact.
- Keep dry and away from water.
- Remove exhausted battery as soon as possible and discard properly.
- Remove battery from the compartment if toy is not used for a long period of time.
- The supply terminals are not to be short circuited.
- Never throw battery in a fire or attempt to open outer casing.
- Do not leave battery connected to drone when not in use.
- Do not stress, press or drop the battery.
- Never charge battery unattended. When charging battery you should always remain in constant observation to monitor the charging process and react to potential problems that may occur.
- Disconnect with the charging wire if the battery is fully charged.
- Never store or charge battery inside the car in extreme temperatures, since extreme temperature could ignite fire.
- Use caution to avoid puncture of the battery. Puncture of battery may cause a fire.

LiPo Battery Disposal: LiPo batteries must be recycled or disposed of properly. They should not be disposed of with other household waste. Check your local laws and regulations for correct recycling and/or battery disposal.

#### AAA BATTERY CAUTIONS

- Do not use rechargeable batteries.
- Non-rechargeable batteries are not to be recharged.
- Do not mix old and new batteries and Do not mix alkaline, standard (carbon-zinc) or rechargeable (ni-cad, ni-mh, etc.) batteries.
- Batteries are to be inserted using correct polarity (+ and -).
- Remove exhausted batteries as soon as possible and discard properly.
- Remove all batteries from compartment if toy is not used for a long period of time.
- The supply terminals are not to be short circuited.
- Batteries should be replaced by an adult.
- Never throw batteries in a fire or attempt to open the outer casing.

**WARNING:** Batteries are harmful if swallowed. Please keep away from children.

Battery Disposal: Dispose of batteries according to the local laws and regulations of your region. Some batteries may be recycled, and may be accepted for disposal at your local recycling center. If you are not able to identify the applicable rules in your area, please check the instructions of the battery manufacturer.

### FLY MORE!

Why wait for your battery to recharge. Increase your flight time with an extra battery on standby! (Sold separately).

Sky Viper 1200mAh LiPo battery recommended, or comparable 3.7V LiPo battery with JST connector plug.



### INSTALLING BATTERIES IN THE CONTROLLER

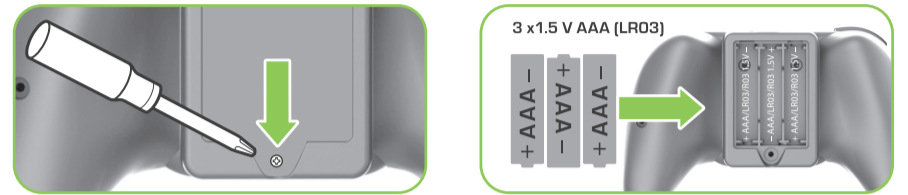

\*Batteries not included.

### CHARGING THE LiPo BATTERY

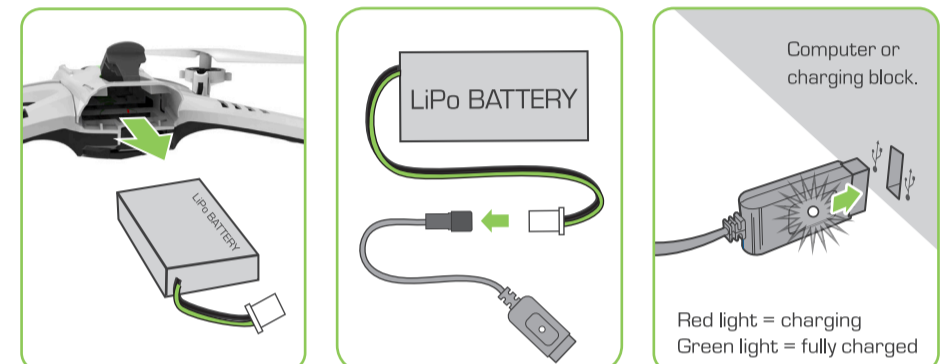

Remove LiPo battery from compartment and unplug cable

Plug battery into USB charging cable

Red light = charging  
Green light = fully charged

Insert charging cable into USB charging block or computer. Charge until light turns green then unplug.

#### CHARGING PRECAUTIONS:

- After use, allow battery to cool down to room temperature before charging again.
- Charge battery in an isolated area, away from excessive heat or moisture.
- If you suspect that the battery is damaged or swelling, discard the battery in accordance with your country's recycling laws.
- Do not modify, heat, or wet the battery in any way. Only recharge with provided charger.

### FAILSAFE GUIDE

- When the drone turns upside down, the motors will stop spinning.
- When the drone goes out of range of the controller, it will automatically land itself in its current position. If the controller comes back in to range before the drone lands, press up on throttle to cancel landing.
- When the drone's battery is low, the LEDs on the drone will begin to blink rapidly, and a tone is played continuously on the controller. The drone will begin to land. Press up on throttle to cancel landing.
- When the drone's battery is depleted, the drone will automatically land itself in its current position. This automatic landing cannot be interrupted with the controller.
- When the propeller is jammed or blocked by an obstacle switch off the controller immediately to prevent possible or further damage.

This device complies with PART 15 of the FCC Rules. Operation is subject to the following two conditions. (1) This device may not cause harmful interference, and (2) this device must accept any interference received, including interference that may cause undesired operation.

CAUTION: Changes or modifications to this unit not expressly approved by the party responsible for compliance could void the user's authority to operate the equipment.

NOTE: This equipment has been tested and found to comply with the limits for a Class B digital device, pursuant to Part 15 of the FCC Rules. These limits are designed to provide reasonable protection against harmful interference in a residential installation. This equipment generates, uses and can radiate radio frequency energy and, if not installed and used in accordance with the instructions, may cause harmful interference to radio communications. However, there is no guarantee that interference will not occur in a particular installation. If this equipment does cause harmful interference to radio or television reception, which can be determined by turning the equipment off and on, the user is encouraged to try to correct the interference by one or more of the following measures: Reorient or relocate the receiving antenna - Increase the separation between the equipment and receiver - Connect the equipment into an outlet on a circuit different from that to which the receiver is connected - Consult the dealer or an experienced radio/TV technician for help.

Caution: To maintain compliance with the FCC's RF exposure guidelines, place the unit at least 20cm from nearby persons.

**WARNING:** This toy produces flashes that may trigger epilepsy in sensitized individuals.

Remove all packaging attachments before giving the toy to a child. Not suitable for children under 3 years due to small parts that could be swallowed.

Conforms to product safety standards ASTM F963. Keep instructions for future reference. Do not discard.

#### WE'RE HERE TO HELP

For questions about this product: support@skyrockettoys.com

©2024 Skyrocket LLC, Los Angeles CA 90292 USA. All Rights Reserved. Skyrocket and their respective logos are trademarks and/or registered trademarks of Skyrocket Toys LLC. All other trademarks, logos and copyrights are the property of their respective owners, and there is no relationship express or implied with Skyrocket Toys LLC.

**MADE IN CHINA. SKYROCKET**

The software included in this product contains copyrighted software that is licensed under the GPLv3. A copy of that license is included in our website at the URL below. You may obtain the complete Corresponding Source code from us for a period of three years after our last shipment of this product and/or spare parts therefor, which will be no earlier than 05-01-2021, on our website at <http://www.skyviper.com/opensource>

MODEL NO: 18721



**WARNING:**  
CHOKING HAZARD - Small parts.  
Not for children under 3 years.