

深圳正华兴科技有限公司

天线规格承认书

Antenna Specification for Approval

客户名称

Customer Name: 蓝光科技

产品名称:

Product Name: 2.4G 天线 全长33mm

客户型号:

Product Name: _____

产品料号:

Part NO.: C1.1-27-3

制表:

Write By: 林宇宏

日期:

Issued Date: 2022-12-30

客 户:

工程R&D Dept	采购Business Dept	承认 Approved By
林宇宏		

正华兴科技

研发R&D Dept	工程 Engineer Dept	审核 Approval



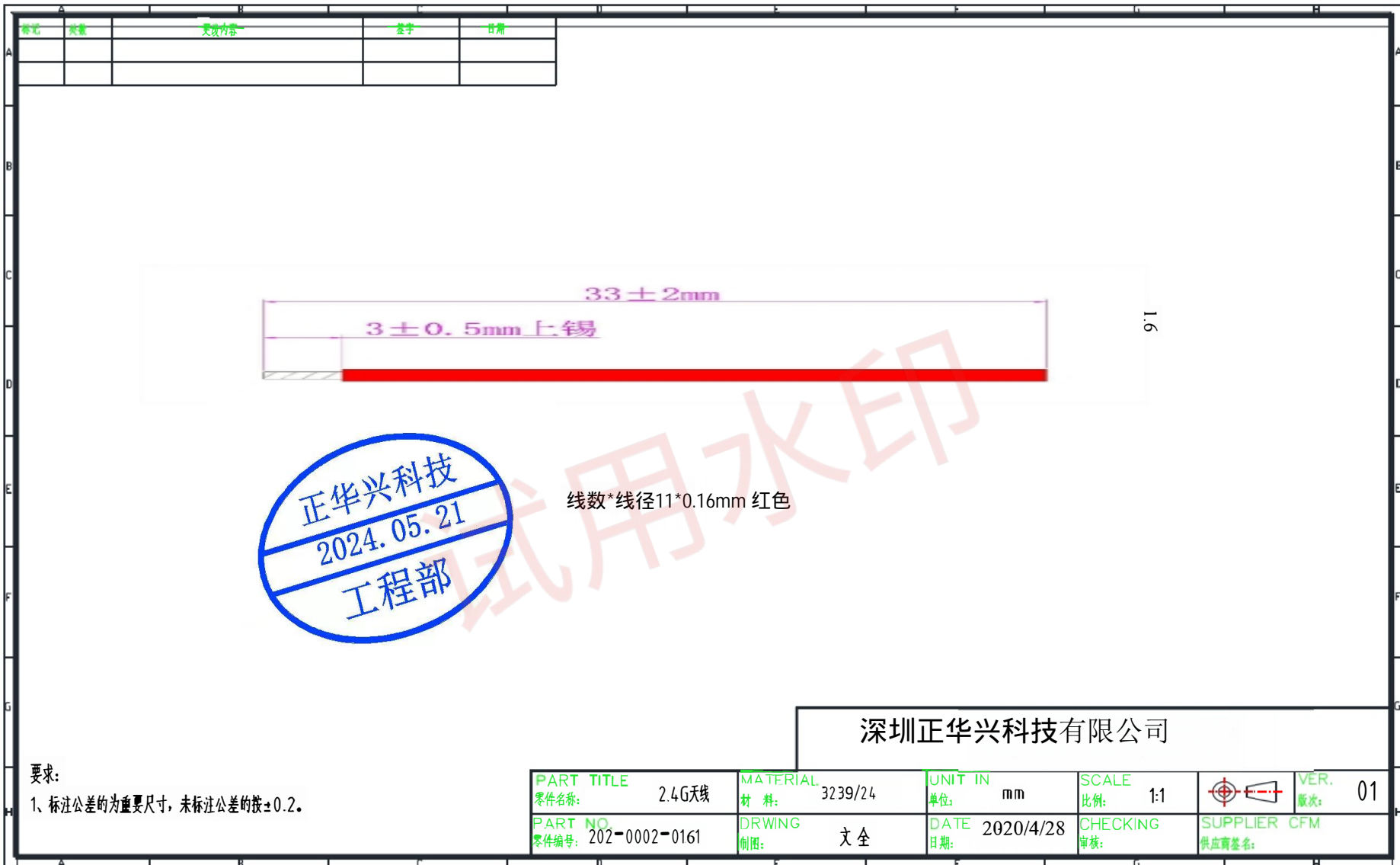

Product Specification

A. Electrical Characteristics

Frequency 2400MHz ~2500MHz

VSWR <1.0

Efficiency >20%

Impedance 50 Ohm

Polarization Line

Gain 0DBi

B. Material & Mechanical Characteristics

Material of Radiator Cu

Connector Type : NO

Dimension

C. Environmental

Operation Temperature - 30 °C ~ + 80 °C

Storage Temperature - 30 °C ~ + 85 °C

Test Equipment & Conditions

1. Network Analyzers :

Agilent 8753D 5071B

2. Communications Test Set:

Agilent E5515C

3. 3D Chamber Test System

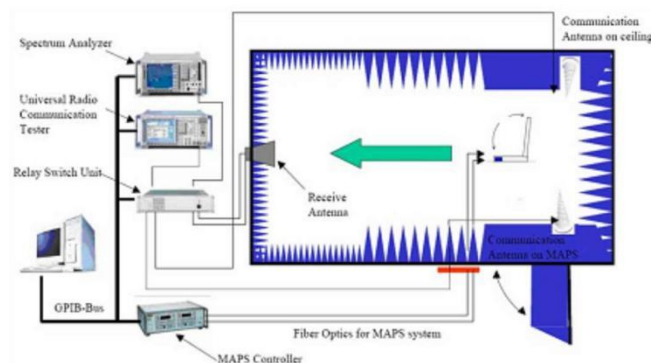

(Testing by 3D anechoic chamber)

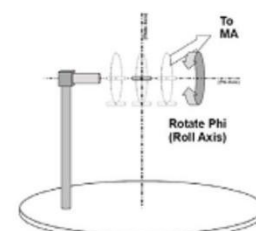

Phi axis test

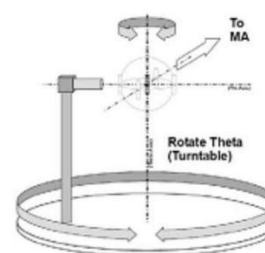

Theta axis test

Efficiency & Gain

2.40 -0.01
 2.440 0.12
 2.48 0.17

Radiation Pattern:

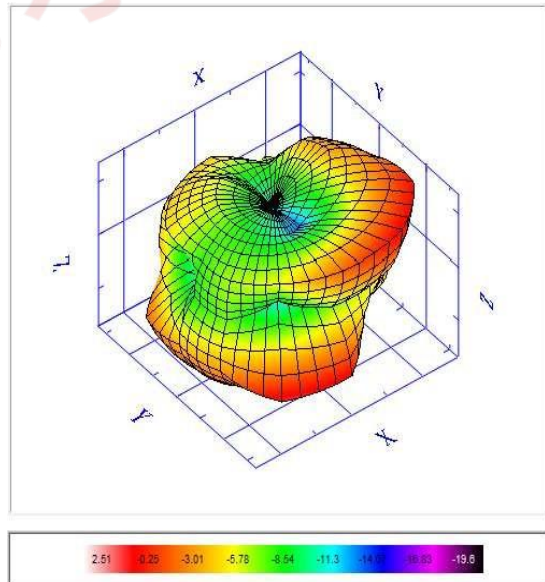
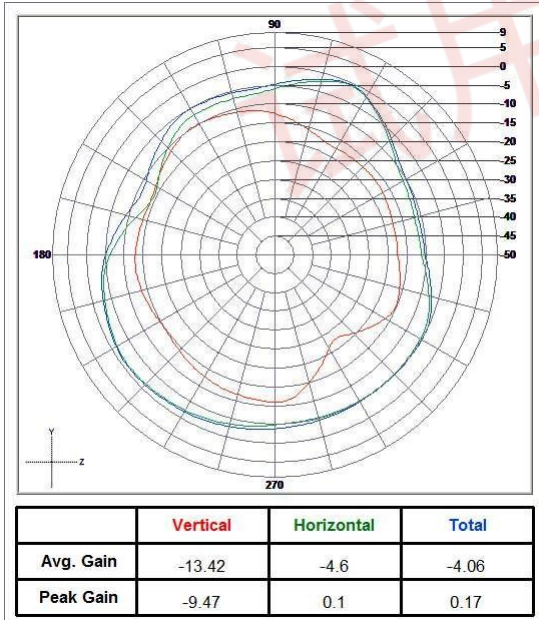
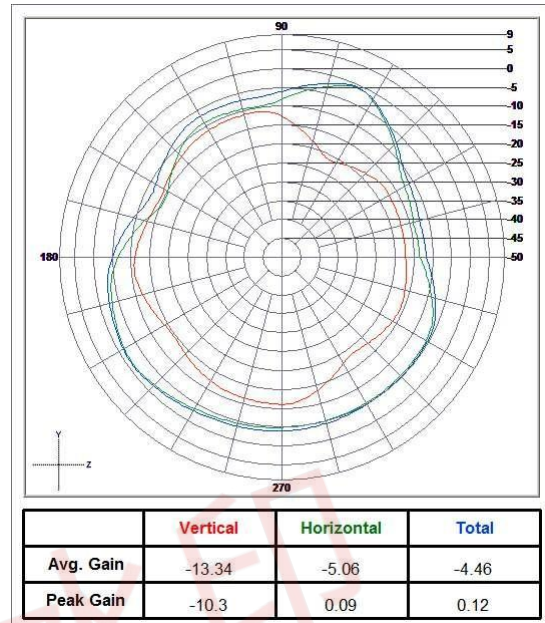
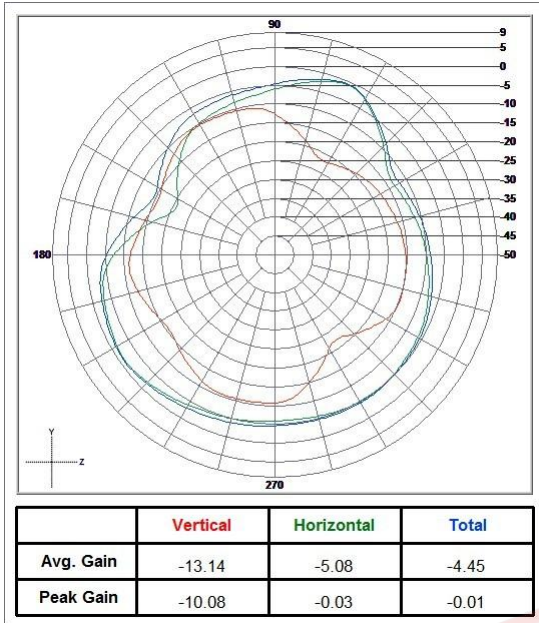

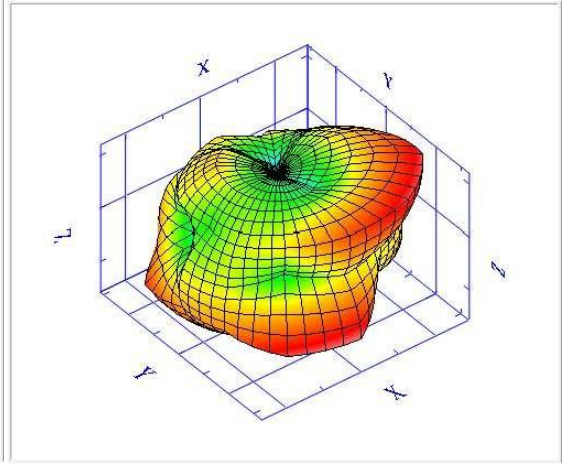
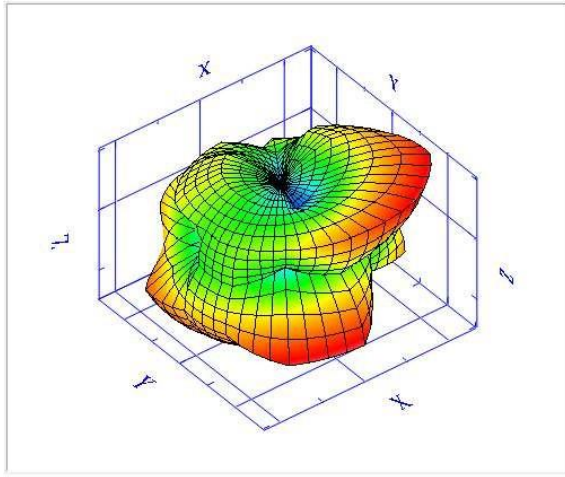

试用水印

REDDOTINFORMATIONTECHNOIOGYSHENZHENCO, LTD

PRODUCT SPECIFICATION

Customer	
Customers part number	
ProductMaterialCode	HD. f-34. 5-9-75-1PEX
Working Band	2400MHz-2500MHz
Issue Date	2024-05-04
ReleaseVersion	A4
Author	Zou yang cheng

Directory

Cover	1
Directory	2
One、Product paraneters	3
Two、Vswr	4
Three、Efficiency/Gain/Directivi tyDiagram.....	5-6
Four、Product drawing	7

One 、PRODUCT TECHNICAL SPECIFICATION

Frequency Range (MHz)	2400-2500
Input Impedance (Ω)	50
VSWR	≤ 2.0
Radiation	Omnidirectional
Gain (dBi)	3
Polarization Type	Linear polarization
Admitted Power Connector	2W
Connect Type	weld
Bandwidth (MHz)	100
Chassis Color	Black
Operation temperature ($^{\circ}\text{C}$)	$-40 \sim +85$
Store temperature ($^{\circ}\text{C}$)	$-40 \sim +85$

Two 、 VSWR

Frequency (MHz)	2400	2450	2500
VSWR	-10.5	-14.8	-10.2

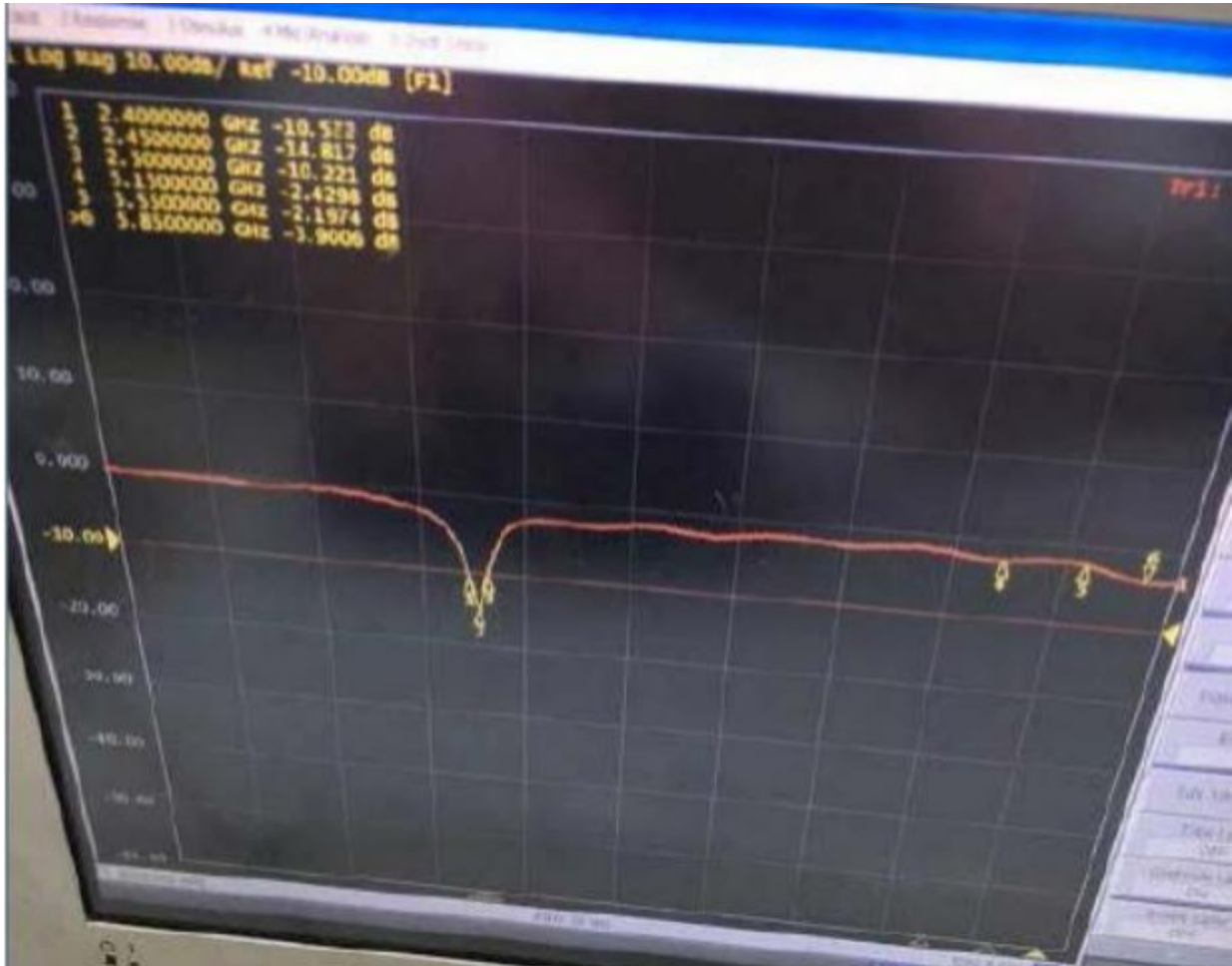

Three、Efficiency/Gain/Directivity Diagram

Passive Test For WIFI2.4				
Freq (MHz)	Effi (%)	Effi (dB)	Gain (dBi)	Gain (dBd)
2400	56.8	-2.37	3.1	1.06
2410	60.05	-2.22	3.38	1.25
2420	61	-2.08	3.56	1.41
2430	63.05	-3	3.85	1.68
2440	62.57	-2.56	3.58	1.45
2450	62.07	-2.1	3.76	1.7
2460	58.9	-2.39	3.48	1.3
2470	61.23	-2.25	3.7	1.56
2480	56.5	-2.6	3.39	1.25
2490	59.05	-2.38	3.46	1.35
2500	53.05	-2.31	2.85	0.67

2400.000MHz

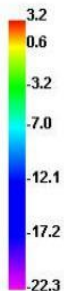
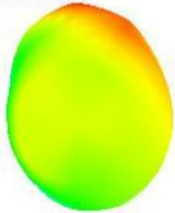

2400.000MHz H

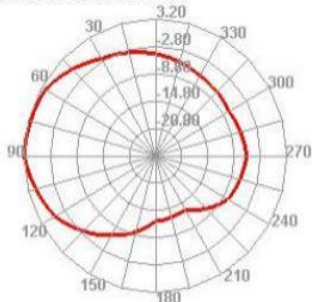

2400.000MHz E1

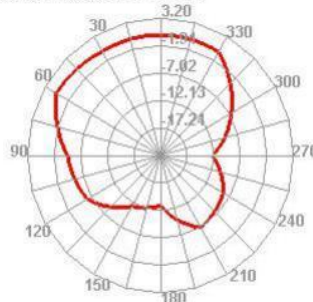

2400.000MHz E2

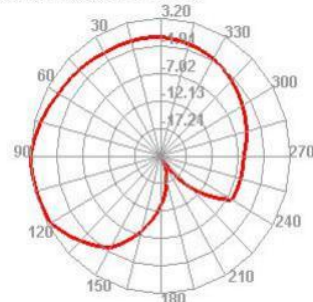

2450.000MHz

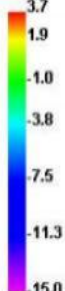
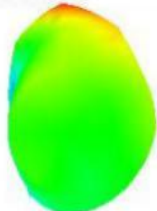

2450.000MHz H

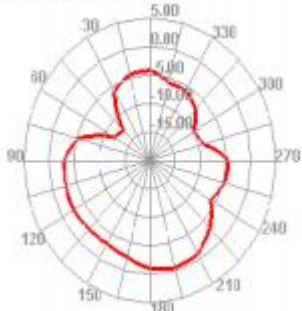

2450.000MHz E1

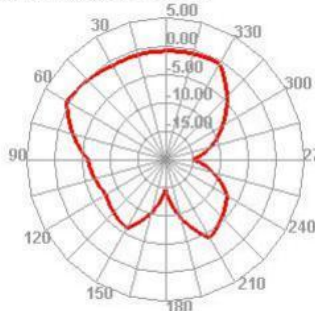

2450.000MHz E2

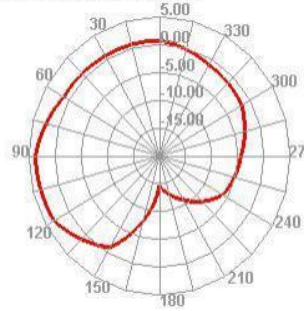

2500.000MHz

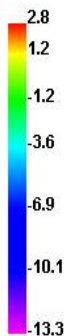
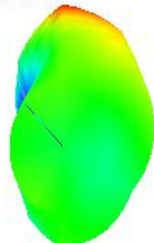

2500.000MHz H

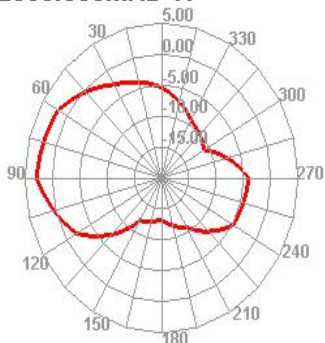

2500.000MHz E1

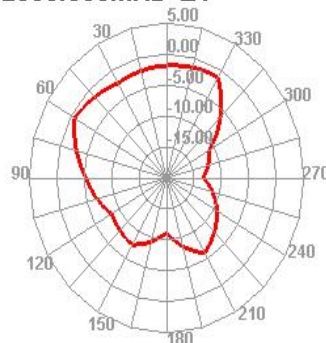

2500.000MHz E2

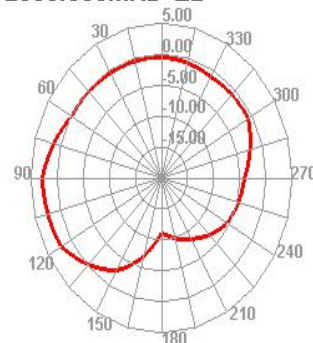

Four、Product drawing

