

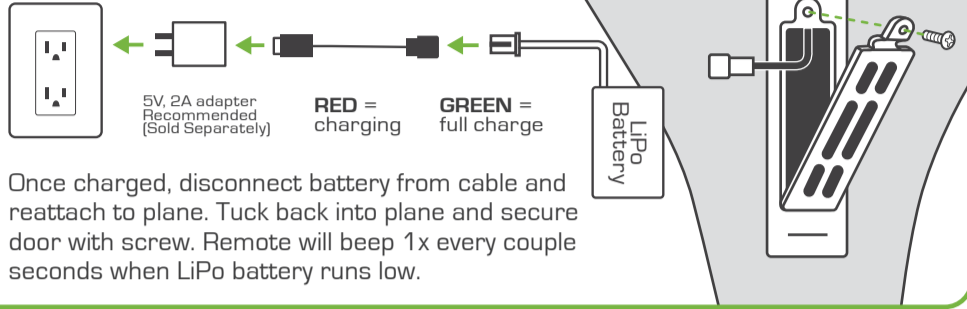

CHARGING PLANE BATTERY

Remove battery from plane and attach to charging cable. (Use included cable only)



Once charged, disconnect battery from cable and reattach to plane. Tuck back into plane and secure door with screw. Remote will beep 1x every couple seconds when LiPo battery runs low.

FLY MORE!

Why wait for your battery to recharge. Increase your flight time with an extra battery on standby! (Sold separately).

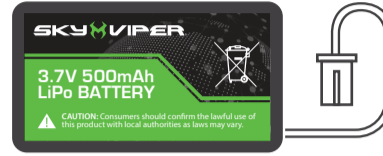

Sky Viper 500mAh LiPo battery recommended, or comparable 3.7V LiPo battery with JST connector plug.

REMOTE BATTERIES

Insert batteries as shown. Replace door and secure with screw. Remote will beep 2x every couple seconds when batteries run low and need to be replaced.

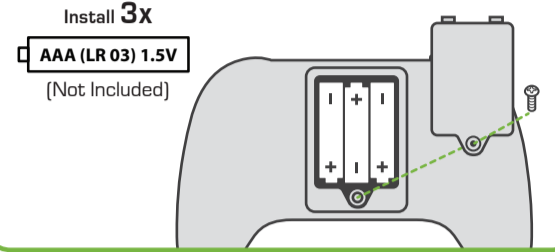

LANDING GEAR INSTALLATION

Landing gear is recommended when landing on concrete or other smooth paved surfaces to avoid damage.

Firmly insert wheels into slots as shown, ensuring that the longer wheel is inserted in front, with wheel pointing forward. Back wheels should point outward.

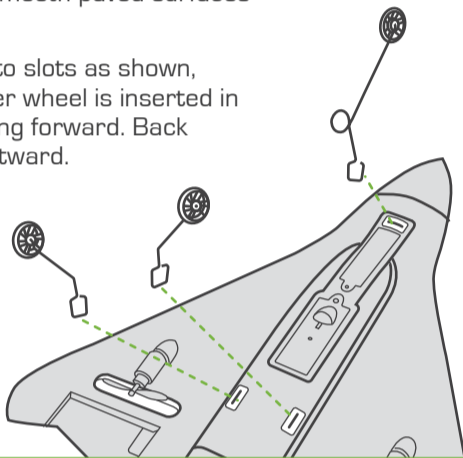

INSPECTING AND REPLACING DAMAGED PROPS

For best performance, periodically inspect prop blades for damage or debris wrapped around motor shaft. If damaged, firmly hold motor housing and pull damaged blade from shaft. Make note of A or B marking on prop and replace with corresponding new prop.

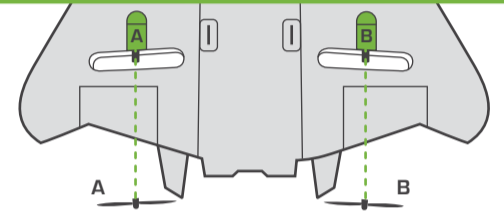

IMPACT RESISTANT DESIGN

Vector is designed to take the abuse of learning to fly. However, if plane is damaged from severe impact or rough extended use, it can likely be sufficiently repaired with the included mending tape.

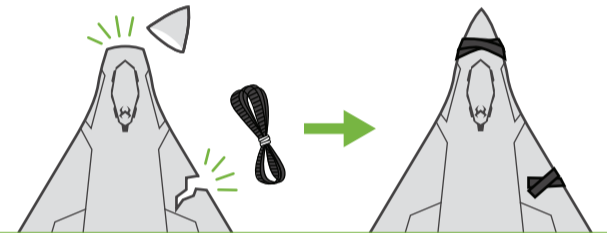

TROUBLESHOOTING

Plane is beeping after crash or landing and no longer responds to remote.	Turn plane off then on again to deactivate crash detection (auto-beep) and restore normal plane controls.
Remote beeps 5x quickly during flight, while plane is far away.	You are in danger of flying out of range. Turn back immediately to prevent losing remote connection.
Remote beeps 5x quickly during flight, and plane starts radial descent.	Plane has flown out of range. Plane auto-lands for safety and starts auto-beeping to help you locate it.
- Plane cannot maintain altitude and drifts to ground. - Plane LED is flashing. - Remote starts to beep 1x every couple seconds.	Plane battery is running low. Recharge LiPo battery to full power.
Remote beeps 2x every couple seconds and/or doesn't connect to plane.	Remote batteries are running low. Replace with fresh batteries.
Plane bounces around or flips over when attempting runway take-off.	Take-off surface may be too bumpy or plane battery may no longer have enough power to complete a runway take-off. Try again with a freshly charged battery, or launch by hand instead.
- Plane does not respond to remote. - Plane starts to fly erratically or becomes difficult to control.	Turn off both remote and plane. Unplug then re-attach plane battery. Ensure remote batteries are new and plane battery is fully charged, then reattempt flight.

SKYROCKET TOYS 30-DAY LIMITED WARRANTY

Skyrocket warrants to the original purchaser that this product is free of defects in materials or workmanship for 30 days from the original purchase. This warranty only applies to defects in material and workmanship and is not valid if the product has been misused or not assembled and maintained per instructions. Proof of defect or malfunction must be provided and verified, along with original sales receipt with date. For quickest resolution, defective product should be returned to the original point of purchase for exchange or refund. If you have questions or difficulties, please contact Skyrocket Toys customer service department at support@skyrockettoys.com.

Before each use, an adult should check this product and the LiPo battery to ensure no damage or hazards exist. Plane has rotating blades that move at high speed, posing danger of damage and injury. Pilots are responsible for any actions that result in damage or injury from the improper operation of plane. Do not fly near spectators or animals. Keep spinning props away from fingers, hair, eyes and other body parts. Never leave plane unattended while it is turned on. Read all enclosed information before operating. Please do not remove the triangle screws for any maintenance.

PLANE CONTAINS A LITHIUM-POLYMER BATTERY 3.7V 500mAh:

LiPo batteries have a severe risk of fire and injury if they are improperly handled or misused. They may explode, overheat or ignite. Read all following precautions and instructions regarding the care and use of LiPo batteries. The LiPo battery is only to be used with the drone and charger included with this product.

- Keep away from flammable materials.
- Do not expose to direct sunlight.
- Do not place in a fire or leave in hot places.
- Do not drop or make subject to strong impact.
- Keep dry and away from water.
- The supply terminals are not to be short circuited.
- Never throw into a fire or attempt to open outer case.
- Do not stress, press or drop.
- Never charge unattended. When charging you should always remain in constant observation to monitor the charging process and react to potential problems that may occur.
- Disconnect charging cable if fully charged.
- Never store or charge inside a car in extreme temperatures, since extreme temperature could ignite fire.
- Use caution to avoid puncture. Puncture of battery may cause a fire.

LiPo Battery Disposal: LiPo batteries must be recycled or disposed of properly. They should not be disposed of with other household waste. Check your local laws and regulations for correct recycling and/or battery disposal.



Vector (model no. 18601) FCC ID: O5318601RX
Remote controller (model no. 18601TX)
FCC ID: O5318601TX

REMOTE AAA BATTERY WARNINGS & SPECIFICATIONS:

- Do not use rechargeable batteries.
- Non-rechargeable batteries are not to be recharged.
- Do not mix old and new batteries and Do not mix alkaline, standard (carbon-zinc) or rechargeable (ni-cad, ni-mh, etc.) batteries.
- Batteries are to be inserted using correct polarity.
- Remove exhausted batteries as soon as possible and discard properly.
- Remove all batteries from compartment if beacon is not used for a long period of time.
- The supply terminals are not to be short circuited.
- Batteries should be replaced by an adult.
- Never throw batteries in a fire or attempt to open the outer casing.

WARNING: Batteries are harmful if swallowed. Please keep away from children.

Battery Disposal: Dispose of batteries according to the local laws and regulations of your region. Some batteries may be recycled, and may be accepted for disposal at your local recycling center. If you are not able to identify the application rules in your areas, please check the instructions of the battery manufacturer.

This device complies with PART 15 of the FCC Rules. Operation is subject to the following two conditions. [1] This device may not cause harmful interference, and [2] this device must accept any interference received, including interference that may cause undesired operation.

CAUTION: Changes or modifications to this unit not expressly approved by the party responsible for compliance could void the user's authority to operate the equipment.

NOTE: This equipment has been tested and found to comply with the limits for a Class B digital device, pursuant to Part 15 of the FCC rules.

These limits are designed to provide reasonable protection against harmful interference in a residential installation. This equipment generates, uses and can radiate radio frequency energy and, if not installed and used in accordance with the instructions, may cause harmful interference to radio communications. However, there is no guarantee that interference will not occur in a particular installation. If this equipment does cause harmful interference to radio or television reception, which can be determined by turning the equipment off and on, the user is encouraged to try to correct the interference by one or more of the following measures: Reorient or relocate the receiving antenna - Increase the separation between the equipment and receiver - Connect the equipment into an outlet on a circuit different from that to which the receiver is connected - Consult the dealer or an experienced radio/TV technician for help.



ADULT SUPERVISION REQUIRED

Adequate flying space is required. Keep a safe distance away from streets, public thoroughfares and power lines. Never attempt to retrieve plane from any location that poses a safety hazard. Never fly plane at night. Keep plane in sight at all times during operation. Discontinue operation immediately if plane flies out of your field of view.

TURNING ON POWER

Ensure plane batteries are fully charged and remote has fresh batteries installed. Press and hold remote button for 1 second to turn on or off. Slide plane button forward to turn on and back to turn off.

PRESS & HOLD
for one second

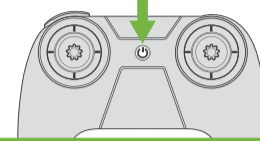

SLIDE FORWARD

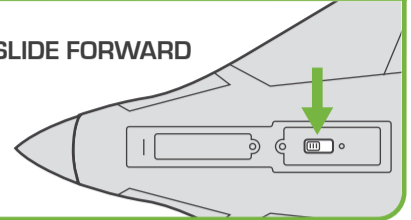

UNDERSTANDING FLIGHT CONTROLS

Sky Viper flight software helps compensate for wind, but additional manual compensation is normal during flight. For best performance, avoid flying in windy conditions.

THROTTLE STICK

Throttle forward to go faster

Throttle back to go slower

Throttle back full to cut power to motors

OPTIONAL: Throttle stick is also capable of applying left and right turning force during flight. Most pilots however, may prefer using only the direction stick for making turns.

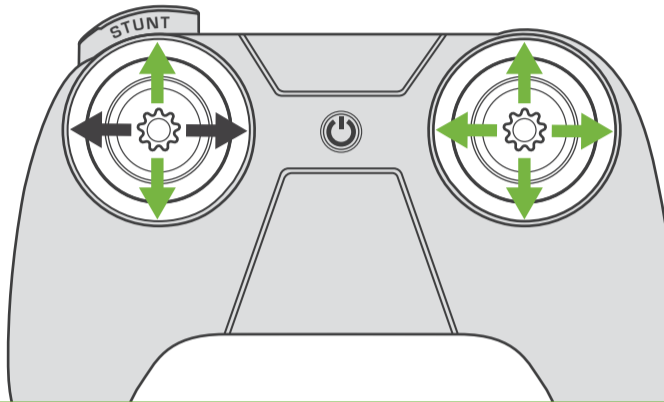
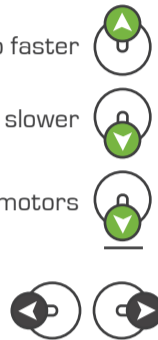

DIRECTION STICK

Direction forward to dive down

Direction back to pull up

Direction left to bank left

Direction right to bank right



SMOOTH SURFACE TAKE-OFF

Place plane on smooth flat surface with at least 30 ft (10 m) of room for take-off. Push *throttle forward* full to build speed then *direction back* full to take-off.

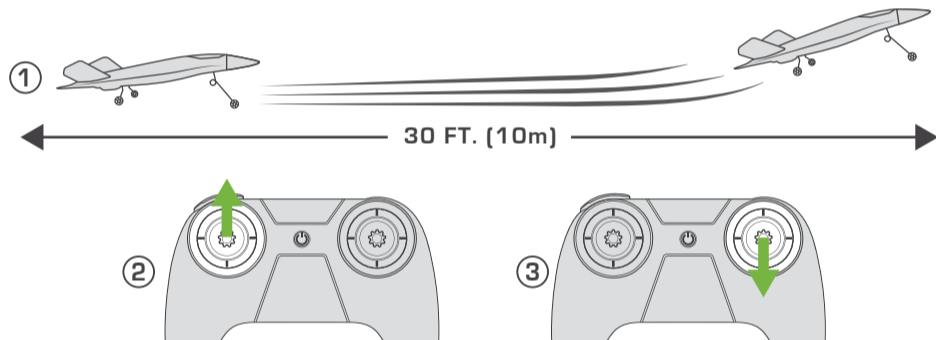

LAUNCHING BY HAND

Hold remote with left hand, with *throttle back* and *motors off*.

Hold plane in right hand, gripping the underside near the LED light. Point plane forward and away from you.

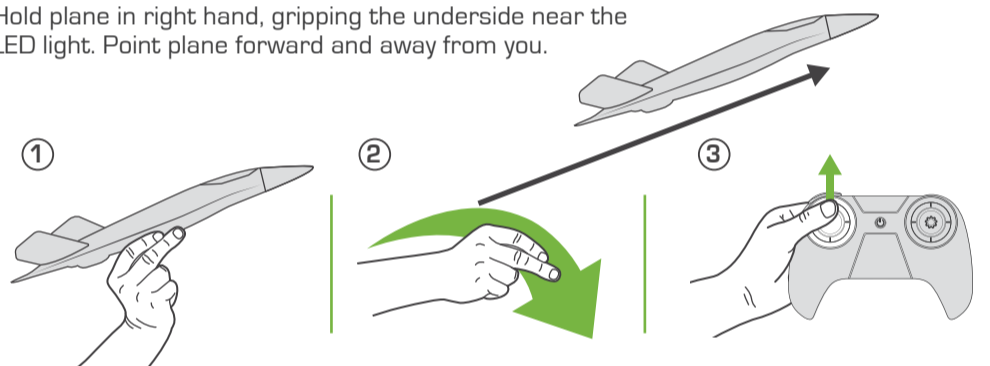

Toss and release plane slightly up and forward, then immediately push *throttle forward full* to complete launch.



WARNING: Push throttle forward immediately after release, but NOT BEFORE, to avoid possible injury to back of hand from spinning props.

LANDING

Throttle back slightly to slowly descend. As plane nears ground, *throttle back* a little more to create a stalling effect for a softer landing.



PERFORMING AEROBATIC STUNTS

UPWARD LOOP

Tap stunt button then quickly pull *direction back* to pull up. Plane will climb and auto-complete an upward loop.

! Ensure plane is flying high enough to safely complete maneuvers.

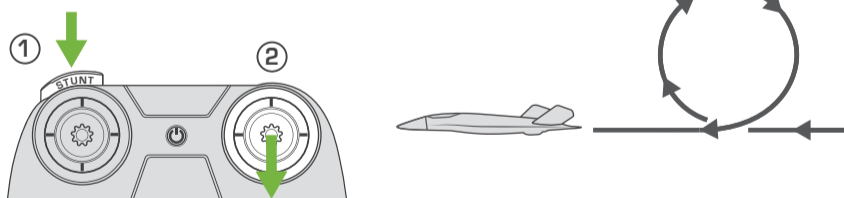

LEFT OR RIGHT BARREL ROLL

Tap stunt button then quickly push *direction left* or *direction right*. Plane will roll in corresponding direction and auto-complete a barrel roll.

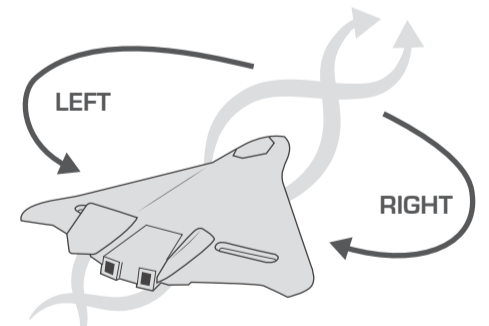
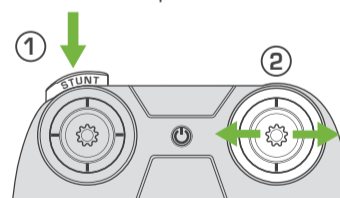

FIND MY PLANE / AUDIO TRACER

Remote will beep 5x quickly when you're in danger of flying out of range, allowing time to turn back before losing connection. If plane flies out of range, remote will continue beeping and plane will auto-land in a radial descent. Audio tracer will turn on and plane will start beeping to help you find it. Turn plane off and on again to deactivate audio tracer.

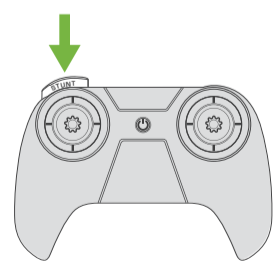

Audio tracer can be toggled on and off with stunt button when plane is not flying.

