

Black 7C.

PMS 7691

 Art Release for Production (Mechanical)	
VRSE File Name: 01764-VRSEBATTMAN_ML_011217_G4-4 Revision: Licensee Approval Date: Production Release Date: Artist: SARA GOTT Color: 37%COLOR PMS 7691C; BLACK 7C Trim Size: Name:	<b>APPROVALS</b> _____ _____ _____ _____ _____

**TROUBLESHOOTING** For more troubleshooting and tips, visit [www.VRSE-VR.com](http://www.VRSE-VR.com)

PROBLEM	SOLUTION
Adjusting the volume	Make sure to adjust the volume on your smartphone before inserting it into headset.
If the 3D effect is blurry	Use your adjustable lens sliders on the top of the headset to find the best focus settings for your eyes. Make sure smartphone is properly aligned in the tray.
Your controller is not being recognized by the App	Make sure Bluetooth setting is turned ON in your smartphone. Make sure controller is powered on with full batteries. If problem persists, attempt to close app and turn off controller, then launch app again and turn controller back on.
Smartphone buttons are pressed when the phone is clamped into the headset.	Use included foam stickers on headset tray to prevent unwanted buttons being pressed during clamping.
Controller calibration	Occasionally the motion controller may need to be calibrated in app. Follow in-app instructions for more details.

Android and Google Play™ are trademarks of Google Inc. Nexus is a trademark of Google Inc. Apple, the Apple logo, the iPhone and the App Store are trademarks of Apple Inc., registered in the U.S. and other countries. The App Store is a service mark of Apple Inc. Samsung Galaxy and Galaxy Note are trademarks of Samsung Electronics Co. Ltd. LG and the LG logo are registered trademarks of LG Electronics, Inc. G3 and G4 are trademarks of LG Electronics, Inc. MOTOROLA, MOTO X and the Stylized M Logo are trademarks or registered trademarks of Motorola Trademark Holdings, LLC. DROID is a trademark of Lucasfilm Ltd. HTC, HTC ONE, and the HTC logo are trademarks of HTC Corporation.

REQUIRES 2x **AAA (LR03) 1.5V**  
Not Included

- Do not use rechargeable batteries.
- Non-rechargeable batteries are not to be recharged.
- Different types of batteries or new and old batteries are not to be mixed.
- Batteries are to be inserted using correct polarity.
- Remove exhausted batteries as soon as possible and discard properly.
- Remove all batteries from compartment if toy is not used for a long period (seven months).
- The supply terminals are not to be short circuited.
- Do not wear this product without a phone attached.
- Exposure of the device's lens to direct sunlight may cause damage to your VRSE Headset and its surroundings and present a fire hazard.

This device complies with PART 15 of the FCC Rules. Operation is subject to the following two conditions. (1) This device may not cause harmful interference, and (2) this device must accept any interference received, including interference that may cause undesired operation.

CAUTION: Changes or modifications to this unit not expressly approved by the party responsible for compliance could void the user's authority to operate the equipment. NOTE: This equipment has been tested and found to comply with the limits for a Class B digital device, pursuant to Part 15 of the FCC Rules. These limits are designed to provide reasonable protection against harmful interference in a residential installation. This equipment generates, uses and can radiate radio frequency energy and, if not installed and used in accordance with the instructions, may cause harmful interference to radio communications. However, there is no guarantee that interference will not occur in a particular installation. If this equipment does cause harmful interference to radio or television reception, which can be determined by turning the equipment off and on, the user is encouraged to try to correct the interference by one or more of the following measures: Reorient or relocate the receiving antenna - Increase the separation between the equipment and receiver - Connect the equipment into an outlet on a circuit different from that to which the receiver is connected - Consult the dealer or an experienced radio/TV technician for help.

**WARNING:** Batteries are harmful if swallowed. Please keep away from children. Battery Disposal: Dispose of batteries according to the local laws and regulations of your region. Some batteries may be recycled, and may be accepted for disposal at your local recycling center. If you are not able to identify the applicable rules in your area, please check the instructions of the battery manufacturer.

**SAFETY WARNINGS**

- Never use the headset without a smartphone docked in the product.
- The product does not have UV protection; never look at the sun directly through the bare product.
- Some users may experience motion sickness while using this product. If you experience dizziness or disorientation, immediately discontinue use until the discomfort subsides.
- Vision of the user may be blocked by the product when in use. Always be aware of your surroundings and only use in a safe environment. Users should not walk or run while using this product and should remain stationary. Make sure you have adequate room to use your controller without it colliding with your surrounding area. Do not use this product in crowded areas. Use caution to avoid injury.
- Avoid prolong use. Take a 10 minute break every 10 minutes you play, even if you don't think you need it.
- Use the wrist safety strap at all times to prevent damage and injury.
- Headstraps or headset should be adjusted and properly fitted to user's head, to prevent headset displacements resulting in eye injuries.

Questions or comments?  
Please call 888-674-5650  
or visit [www.VRSE-VR.com](http://www.VRSE-VR.com)

**SKYROCKET**

**UNIVERSAL** **Jurassic World™**  
A COMCAST COMPANY  
Jurassic Park and Jurassic World are trademarks and copyrights of Universal Studios and Amblin Entertainment, Inc. Licensed by Universal Studios. All Rights Reserved.

Conforms to product safety standards ASTM F963. Not suitable for children under 3 years due to small parts. Remove and discard wire ties before giving this product to children. Retain this package for future reference. PRODUCT COLORS AND STYLES MAY VARY FROM THOSE SHOWN.

©2017 Skyrocket LLC, Los Angeles, CA 90066 USA. All Rights Reserved. VRSE and the Skyrocket logo are trademarks of Skyrocket LLC. Other trademarks and trade names are those of their respective owners, and there is no relationship express or implied with Skyrocket LLC. MADE IN CHINA.

01764-IM-G4



**VRSE™**  
VR ENTERTAINMENT SYSTEM



**CONTENTS:**

- VRSE Headset
- VRSE Motion Controller
- Jurassic World Stun Baton
- Safety Wrist Strap
- Foam Sticker Insert
- Instruction Sheet



SMARTPHONE REQUIRED  
(NOT INCLUDED).

Download the FREE  
**Jurassic World VRSE Game**



**VRSE-ATILITY**

The VRSE VR headset can also be used to view VR movies and other VR media supported by your smart phone.



360° MOVIES



FPV DRONE FLYING

**VRSE-VR.com**

AGES  
**8+**

**Compatible Smartphone Required**

VRSE Headset works best with the following smartphones or newer (not included)

iPhone 7 Plus	Samsung Galaxy S7 Edge	LG G5	Google Nexus 5X
iPhone 7	Samsung Galaxy S7	LG G4	Google Nexus 6P
iPhone 6s Plus	Samsung Galaxy S6 Edge+		Google Pixel
iPhone 6s	Samsung Galaxy S6 Edge		Huawei P9
iPhone 6 Plus	Samsung Galaxy S6		OS Lollipop 5.0 and above
iPhone 6	Samsung Galaxy Note 5		
iOS 10 and above			

NOTE: VRSE™ may also work with some smartphones not listed above that have screens between 5 and 6 inches.

**INSTRUCTIONS**



## INSTALL BATTERIES

- 1 Open the battery compartment on the back of VRSE Motion Controller.

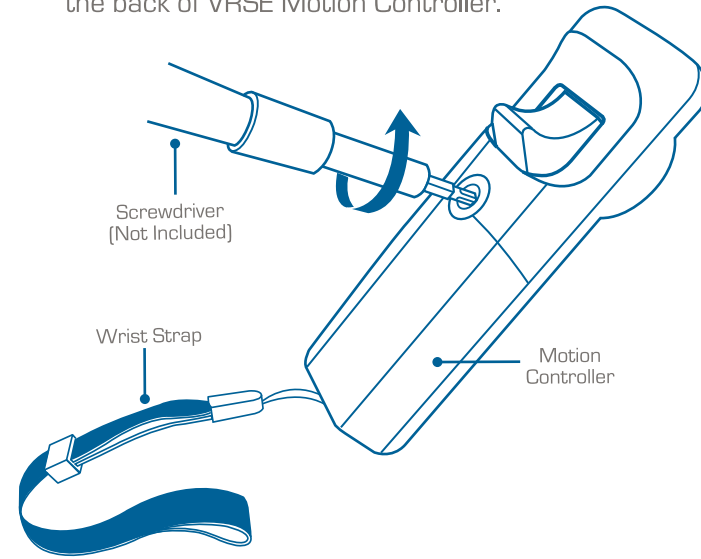

- 2 Place batteries into the battery compartment.

REQUIRES 2x  
AAA (LR03) 1.5V  
Not Included

- 3 Place the compartment door back on VRSE Motion Controller and secure in place.

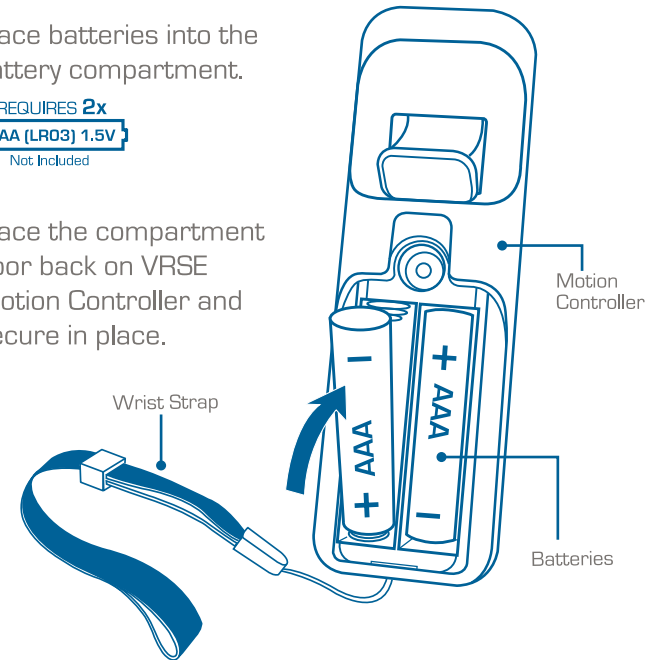

## ASSEMBLE CONTROLLER

- 1 Thread wrist strap through opening in Baton front.

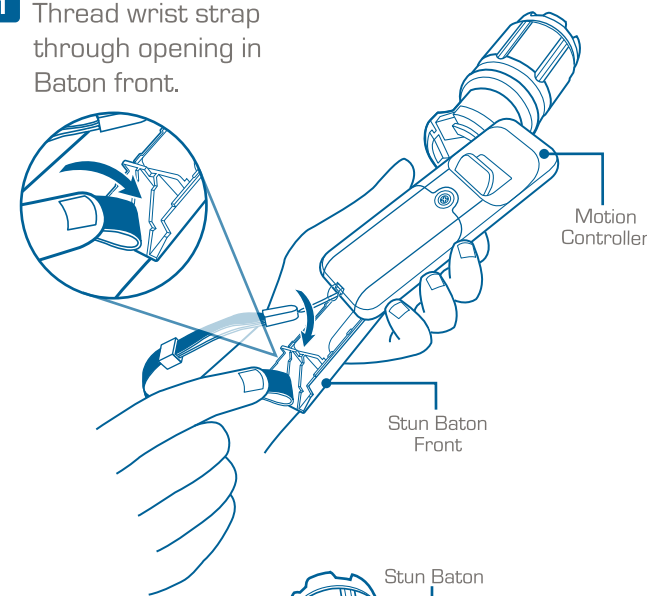

- 2 Place Motion Controller into front section of Baton.

- 3 Attach back of Baton to the front.

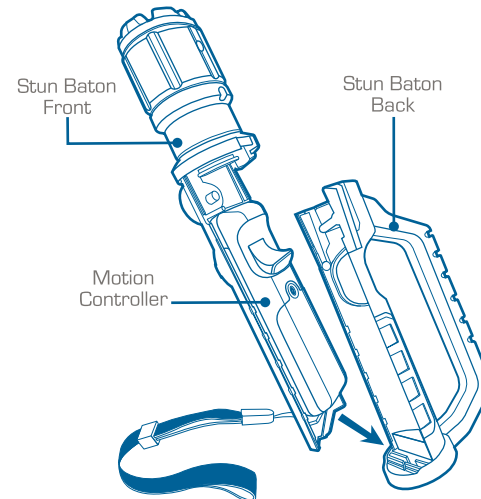

- 4 Place your hand through the wrist strap and hold the VRSE Motion Controller and tighten strap. Hold firmly so that controller will not fall or fly off during play.

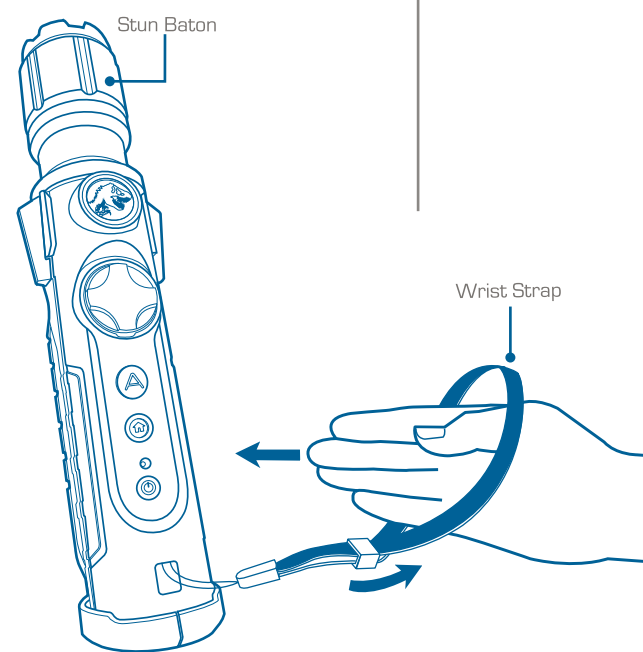

### HOW TO USE CONTROLLER

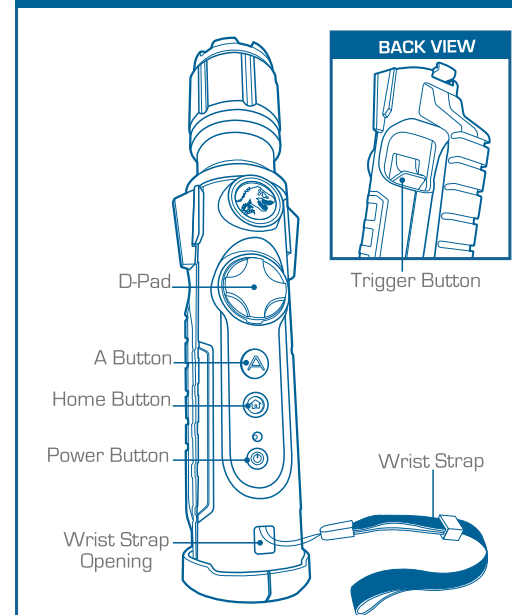

## LOAD PHONE INTO TRAY

- 1 Slide out smartphone tray from headset. Launch the VRSE App on your smartphone and make sure your device's Bluetooth setting is turned ON.

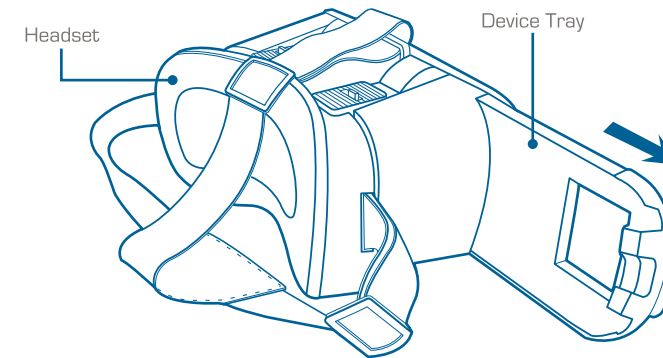

- 3 Align smartphone so that the headphone port is accessible and plug in headphones now.

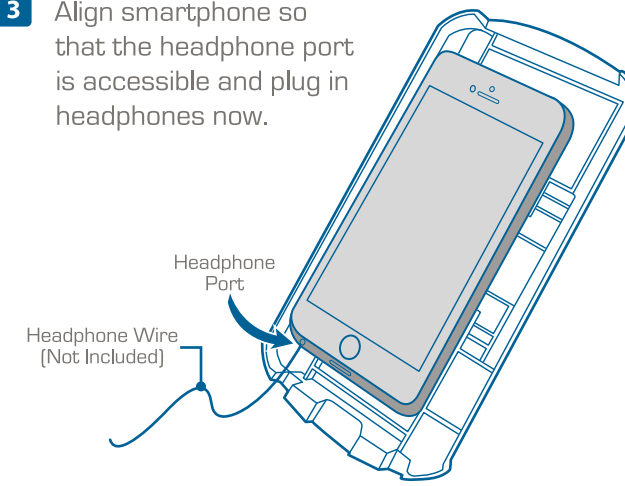

- 2 Insert your smartphone into the tray by securely positioning it under the clamp and align the middle of the phone with the midline on the tray clamp. Make sure the phone screen is facing forward. **NOTE:** You may need to adhere included Foam Stickers to the tray to prevent the clamp from pressing down on your smartphone's side buttons.

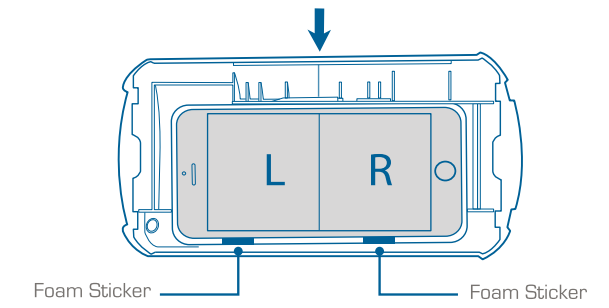

- 4 Slide tray back into headset.

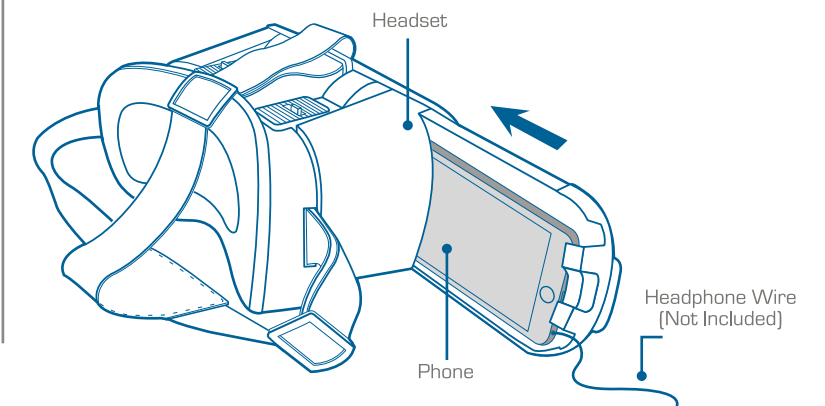

## ADJUST HEADSET AND LENSES

- 1 Adjust head straps on top and sides to secure your fit.

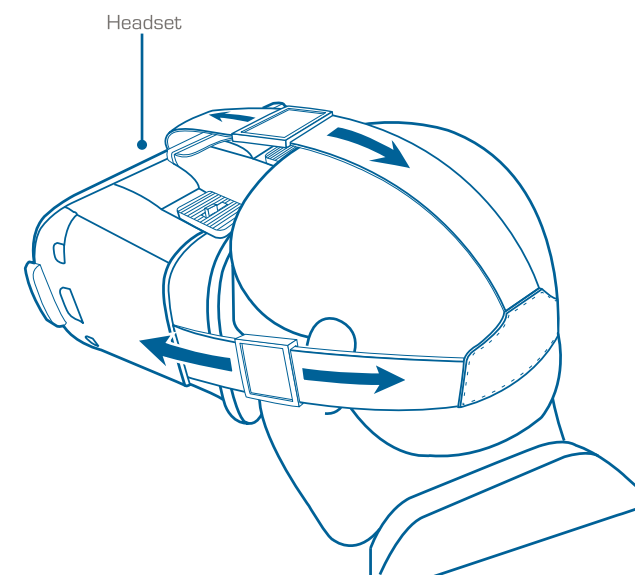

- 2 Adjust lenses by moving the sliders forward and back and side to side. Keep adjusting and trying different positions until the screen image is in focus. **NOTE:** Make sure to remove protective films from lenses.

