

### 1 INSTALL THE SKY VIPER HOVER RACER APP

Download and install free **Sky Viper Hover Racer** app onto your smart phone.



### 2 ATTACH YOUR PHONE TO THE REMOTE

If not already assembled, attach phone mount to remote.

Push upper lip of phone mount upward and insert your phone into mount as shown.

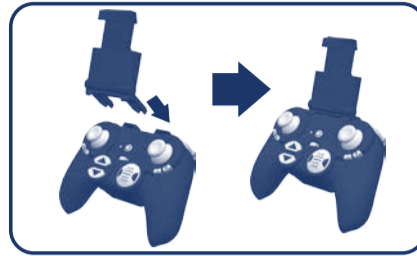

### 3 TURN ON HOVER RACER AND SYNC WITH REMOTE & SMART PHONE

Charge LiPo battery and insert into Hover Racer. Install fresh batteries into remote, (see battery instructions for details).

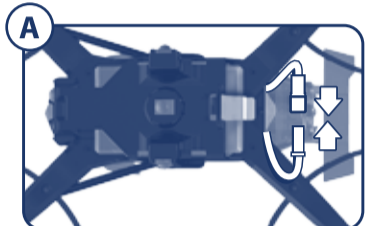

Connect battery plugs on the underside of the racer to turn it on.



Align forward facing edge of connectors against short tabs before snapping into locked position against connector's tab.

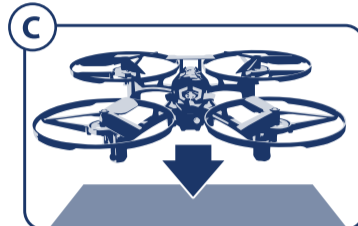

Place racer on a flat level surface.



Push power button on remote. Blinking light should turn solid. (If not, turn off racer and remote and repeat steps A thru C).



Ensure that Bluetooth is activated on your smart phone. Open the Hover Racer app. Beacon setup is required to use app properly.

### 4 ASSEMBLE & SYNC CHECKPOINT BEACONS (one time set up only).

Install fresh batteries into beacons, (see battery instructions for details). Assemble beacons as shown and adhere number stickers to each. Stickers are color-coded to match each beacon. Beacon stands can be adjusted to point straight up or point on an angle as desired. When initiating a Hover Racer battle or race for the first time, the app will automatically guide you through the process of syncing each beacon. Simply follow in-app instructions. This will only need to be done once.



### 5 SETTING UP A VIRTUAL RACE COURSE WITH BEACONS

Create a virtual race track or obstacle course with your checkpoint beacons and surrounding objects. Beacons act as checkpoints to help track time and status, but courses can be made more interesting by adding other objects that need to be passed or flown around between checkpoints.

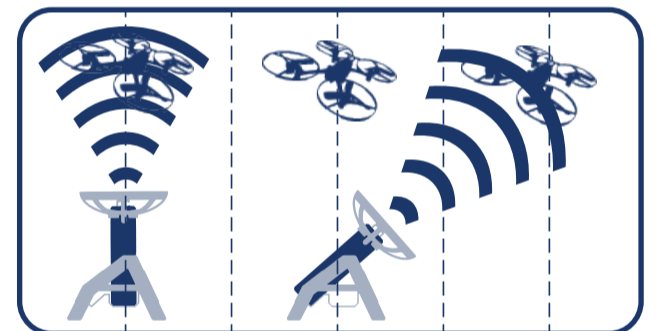

### 6 BASIC FLIGHT MANEUVERS

Hover Racers are designed to automatically maintain a hover three feet above the ground. Use **Altitude up and down** buttons to easily control altitude.

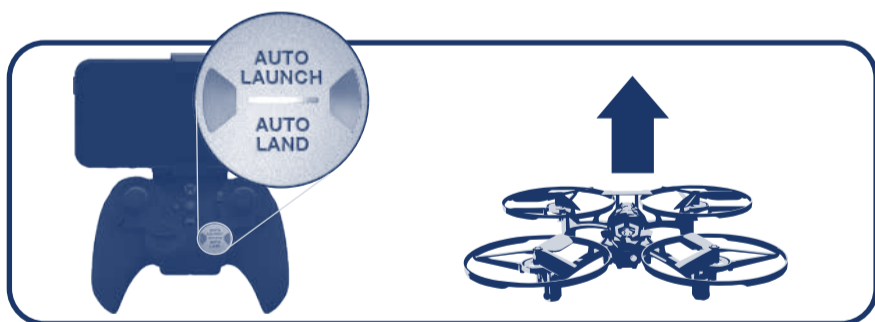

Press **Auto Launch** to launch a few feet off the ground.

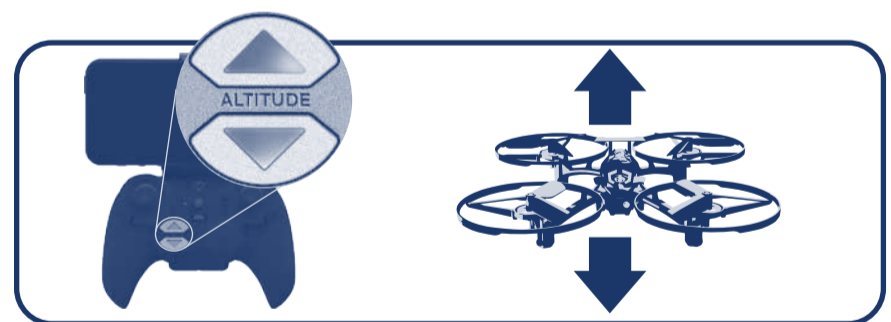

Press the **Altitude up** or **down** button to fly 12" higher or lower.

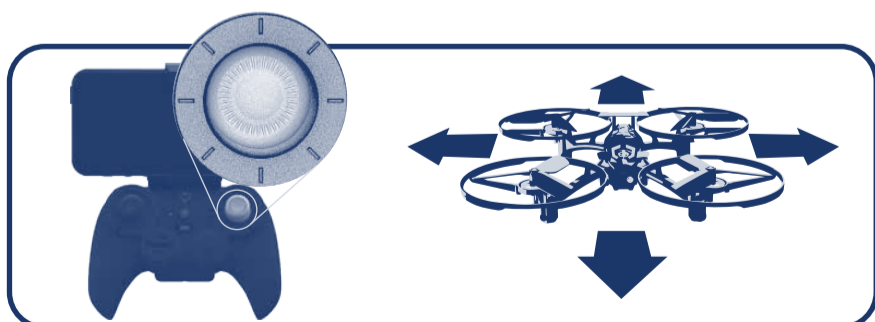

Press the **Directional Thumbstick** to fly in any direction.

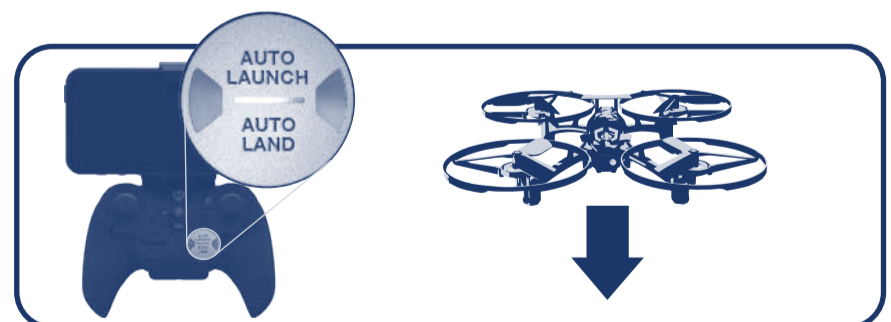

Press the **Auto Land** button to land.

### 7 FOLLOW APP GAME INSTRUCTIONS FOR RACING & BATTLING

#### SINGLE PLAYER MODE

Practice your racing skills and complete challenges. Beat your best time or race against the clock!

#### MULTI-PLAYER MODE

Link up to 4 Racers for multi-player races and battles! Play 2 against 2 or every person for themselves! Combine up to 16 checkpoint beacons together to create bigger courses!

#### CO-OP MODE

Only one racer? 2 can play at the same time as pilot and co-pilot! (requires 2 smart devices, one for each player)

# FLIGHT CONTROLS

## THROTTLE/ROTATION STICK

- While in manual flight mode push the throttle stick forward to make racer lift.
- The further you push the throttle stick, the faster you lift. Up and down controls only apply to manual flight mode.



Press up to lift



Press down to descend



Press left to rotate counter-clockwise



Press right to rotate clockwise

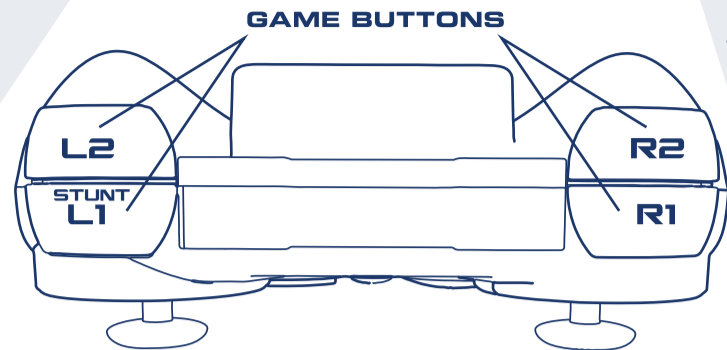

## GAME BUTTONS

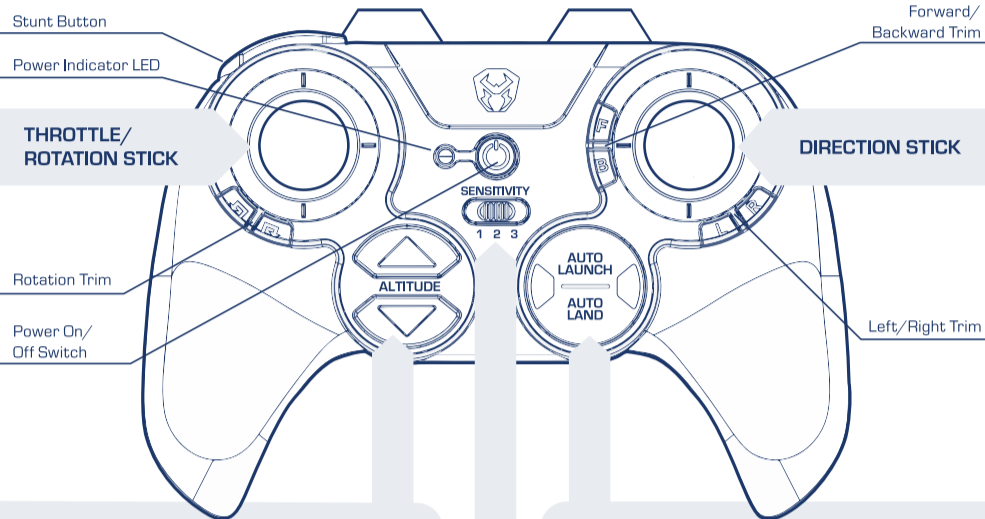

## DIRECTION STICK

- Push the direction stick forward to fly forward or away from you. Push backwards to fly backward. The further you push, the faster the racer will fly in that direction.
- Push the direction stick left to fly left. Push right to fly right. The further you push, the faster the racer will fly sideways.



Press up to fly forward



Press down to fly backward



Press left to fly left



Press right to fly right

## TRIM ADJUSTMENTS

Make adjustments to keep racer from drifting during hover

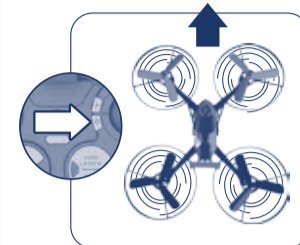

If the racer drifts forward - Press B button

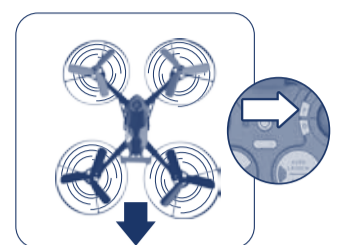

If the racer drifts backwards - Press F button

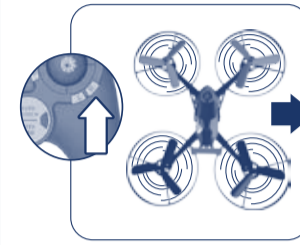

If the racer drifts left - Press R button

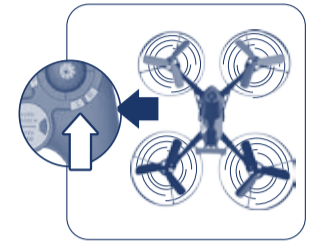

If the racer drifts right - Press L button

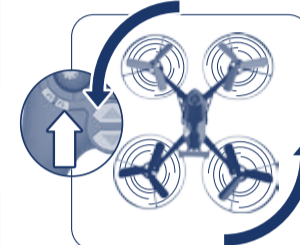

If the racer spins counter-clockwise, when viewed from the top - Press R button

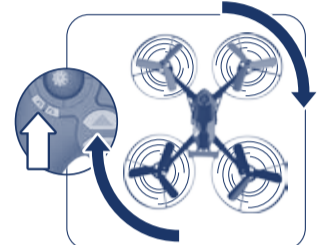

If the racer spins clockwise, when viewed from the top - Press L button

**NOTE:** The remote will beep/flash 3 times when trim adjustment is set to the neutral position (the middle of the trim range) and beep once when it has reached the end of its range.

## ALTITUDE BUTTONS

- Tap the up or down arrow to adjust the racer's altitude. The racer will lift or lower approximately 12" each time the up or down arrow is pressed. (Distance may vary.)
- Press and hold the up or down buttons for continuous lift or descent.



## AUTO LAUNCH/LAND BUTTON

- Tap the auto launch button to launch a few feet from the ground. (Exact height may vary.)
- Tap the auto land button to land the racer by itself.
- Press and hold the auto land button for 1 second to kill motors



## FLIGHT SENSITIVITY SWITCH

The Racer's responsiveness may be adjusted on the controller to match your flying skills.

There are three options:

1 LOW sensitivity 2 MEDIUM sensitivity 3 HIGH sensitivity

It is best to start in the low sensitivity position until you have mastered flying.

Flight sensitivity can be adjusted before or during flight.



## 8 MANUAL FLIGHT MODE

Hover Racers are designed to automatically maintain a hover. Controls can be switched to manual flight mode for experience pilots who want manual throttle control. Control will always default back to Auto-Hover mode when remote is switched off.

### TOGGLE INTO MANUAL FLIGHT BEFORE TAKE-OFF

- Hold **stunt** button and press **auto land/auto launch** button and a tone will sound from the remote. Make sure your **throttle stick** is in the down position.
- Push the **throttle stick** up to begin manual flight.

### TOGGLE INTO MANUAL FLIGHT WHILE IN AUTO-HOVER

- Hold **stunt/L1** button and press **auto land/auto launch** button and a tone will sound from the remote. Make sure your **throttle stick** is in the down position.
- After the tone is heard, move the **throttle stick** up until the racer starts to rise (If throttle is not matched in 5 seconds then manual flight will be cancelled).

### TOGGLE INTO AUTO HOVER WHILE IN MANUAL FLIGHT

- Press either the up or down altitude locking button to toggle back into auto hover, (your racer will hover at the current throttle speed).

## 9 FREE FLIGHT MODE - FLYING HOVER RACER WITHOUT SMART DEVICE OR APP

The Hover Racer's basic flight controls work independently of Hover Racer app, therefore the app is not required for recreational flying.

When the Hover Racer app is turned off, game buttons at the top of the flight controller are deactivated. All other controller functions remain the same.

## 10 FREE FLIGHT ONE-TOUCH STUNTS

When in free flight mode, you have the option of performing one-touch stunts using the **Stunt/L1** button on the top of the controller. One-touch stunts only work in free flight mode and are deactivated when using the Hover Racer app.

### CAUTION!

The racer should be flying at least 6 feet in the air with a minimum clearance of 6 feet in all directions before attempting stunt functions.

### NOTE:

Once a stunt has been initiated, DO NOT adjust Throttle or press any other controls until the stunt has been completed.

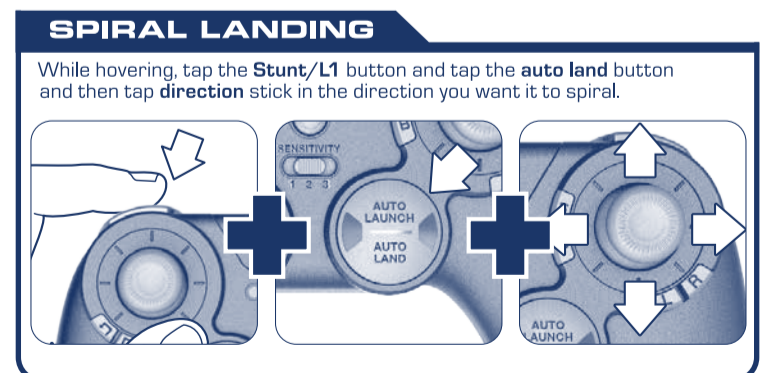
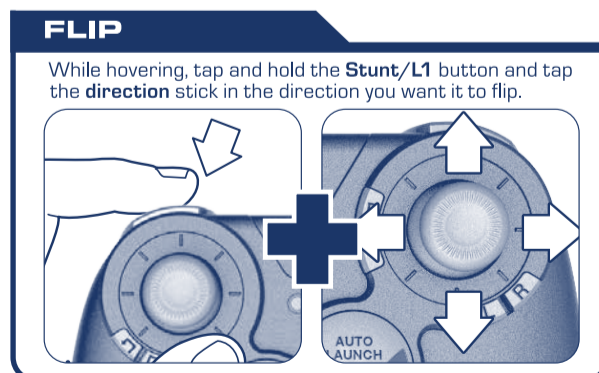
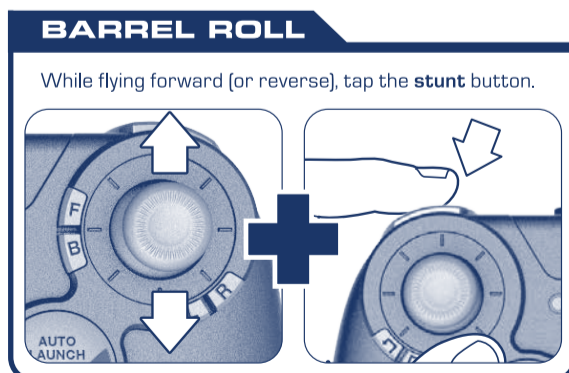

## FLIGHT TIPS

- To launch manually, press the throttle stick up slowly until the Hover Racer gains altitude.
- Pulling the throttle backwards will reduce power and the Hover Racer will land.
- When launching the racer, face the same direction as the racer. Red or Gray blades should be in front.
- If your racer drifts in any direction when you are hovering, you will need to make Trim adjustments to correct the drifting. Trim adjustments are sometimes needed when the racer is first flown after purchase. See TRIM ADJUSTMENTS section for details.
- Practice launching, hovering and landing before attempting to learn other moves.
- Flying 2 to 3 feet above the ground will reduce ground turbulence and make flying easier.
- When first attempting to fly in different directions, start by tapping the direction stick until you have a feel for it. Always move controls slowly until you become comfortable operating the racer.
- Once you've mastered flying in directions, practice rotational controls. Spinning and keeping racer facing the same direction as you make flying easier and more intuitive.
- Stay 2 to 3 feet away from walls and ceilings as racer will be drawn towards them if you fly too close.
- If propeller blades come in contact with another object or you crash, throttle down or auto land immediately to prevent possible or further damage.
- If anything prevents racer's blades from spinning or they become jammed, throttle down or auto land immediately. Do not attempt to fly until obstruction has been removed and damage fixed.
- Should something prevent racer's blades from spinning, racer may auto shutdown. LiPo battery will need to be unplugged then reconnected to restore flying power.
- If the racer flies too far away, beyond the control range of the remote, the racer will auto-land to prevent the racer from flying away out of control.

## CONTENTS

- |                                 |                        |
|---------------------------------|------------------------|
| 1 - Hover Racer                 | 1 - Phone mount        |
| 1 - Controller                  | 4 - Replacement blades |
| 4 - Interchangeable thumbsticks | 4 - Screws             |
| 4 - Checkpoint beacons          | 1 - Screwdriver        |
| 1 - 650mAh 3.7V LiPo battery    | 1 - Operator manual    |
| 1 - USB charger cable           |                        |



## REMOTE BATTERIES

Loosen the screw in the Remote Control battery compartment door with a Phillips screwdriver and insert batteries as shown. Replace door and tighten screw.

3 x 1.5 V AAA (LR03)

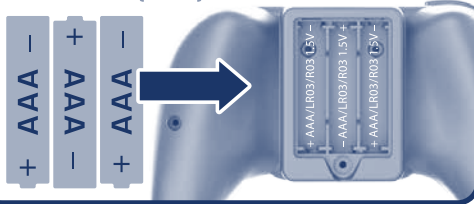

## BEACON BATTERIES

Loosen the screw in the Remote Control battery compartment door with a Phillips screwdriver and insert batteries as shown. Replace door and tighten screw.

8 x 1.5 V AAA (LR03)

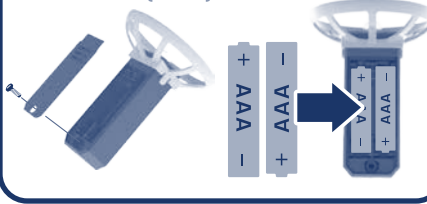

## BATTERY REPLACEMENT

Double your flying time with a 2nd battery! Details of how to purchase additional or replacement battery packs available at [SKYVIPER.COM](http://SKYVIPER.COM)



## CHARGING THE RACER

- 1 Disconnect battery wires. Push down the battery box holder on the rear side of the racer. Pull battery box out of underside of racer.
- 2 Plug charging cord into computer or USB power block. Once charged, disconnect battery from USB charging cable.
- 3 Insert LiPo battery into back of racer. Reconnect the battery wires.

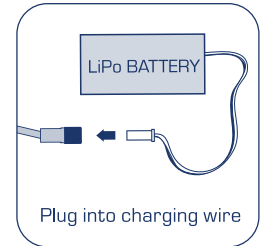
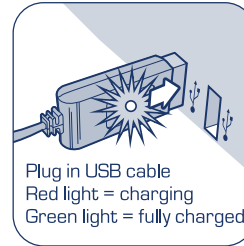
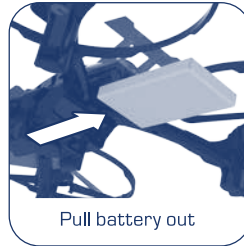
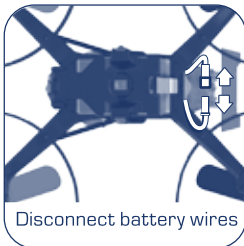

## CHARGING PRECAUTIONS:

- After use, allow racer (battery on bottom) to cool down to room temperature before charging again.
- Charge racer in an isolated area, away from excessive heat or moisture.
- If you suspect that the battery is damaged or swelling, turn off the racer immediately.
- Do not modify, heat, or wet the battery in any way. Only recharge with provided charger.

## REPAIRING DAMAGED BLADES

- 1 Unplug battery on racer.
- 2 Make note of the blade color and letter (A or B) before removing the blade from racer. (Markings are located on the underside of blades and racer).
- 3 Remove the small screw using the mini screwdriver provided.
- 4 Replace the damaged blade with a new blade with matching color and letter. Secure the blade with the retaining screw.

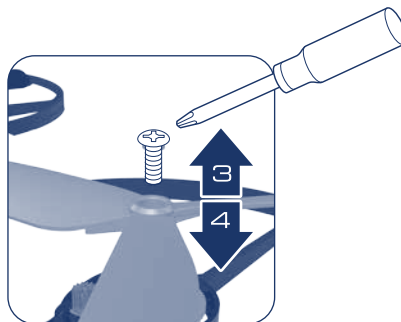
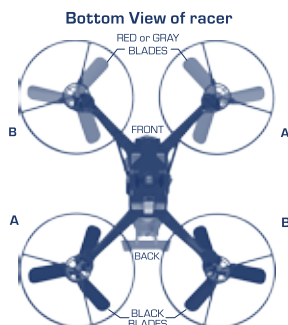

## MAINTENANCE

- Over time, loose hair or carpet fibers may get wound in blades, reducing performance. Unplug the racer and remove fibers from motors, (remove blades if necessary).

## ALTERNATIVE PRO THUMBSTICKS

- Lift thumbstick upward to remove.
- Insert thumbstick into stem to replace.

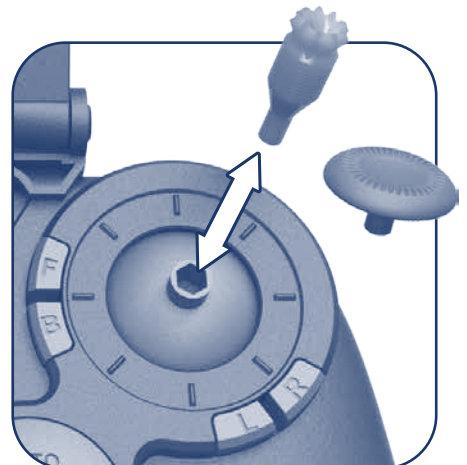

## DOWNLOAD THE SKY VIPER FLIGHT SIMULATOR APP ON YOUR DEVICE

Learn and practice maneuvers on your phone, then apply your new skills in real life.

- Download the Sky Viper Flight Simulator app for free!
- Auto & Manual Flight Modes
- Practice & Challenge Simulations
- 1st and 3rd Person Views
- Choose from the entire Sky Viper fleet



## TROUBLESHOOTING

| PROBLEM   | SOLUTION   |
|---|--|
| Racer drifts in any direction during flight without direction from the remote | <ul style="list-style-type: none"> <li>Adjust the trim controls until drifting ceases.</li> </ul>  |
| All blades spin, but racer will not fly properly or crashes immediately       | <ul style="list-style-type: none"> <li>Racer's blade may have been installed incorrectly. Reinstall and remember that the GREEN blades point forward.</li> </ul>   |
| Racer is unresponsive   | <ul style="list-style-type: none"> <li>Ensure the remote has fresh batteries and the LiPo battery is fully charged.</li> <li>Racer may be miscalibrated by launching from an un-level surface. Turn the remote off. Turn off the racer then turn them back on and try again from a flat, level launching surface.</li> <li>Inspect racer for any possible damage.</li> </ul>   |
| Racer crashes when attempting stunt functions                                 | <ul style="list-style-type: none"> <li>Ensure that racer is flying a minimum distance of 6 feet from the ground with a minimum 6 feet clearance in all directions.</li> </ul>  |
| Beacons do not seem responsive  | <ul style="list-style-type: none"> <li>Ensure that you are flying your Racer close enough to the beacons. Beacons must be pointing toward the Racer and within 10-15 feet to communicate properly.</li> <li>Ensure that beacons are positioned at least 6 feet apart from other beacons.</li> <li>Ensure beacons have fresh batteries and are turned on. Power indicator will light up green. If not, replace batteries.</li> <li>Beacon may go into energy saving mode after 30 minutes. Turn beacon power off then on again to reactivate.</li> <li>Ensure that all components are on...Hover Racer, remote control, app game and beacons. All components must be on for communication to work properly.</li> <li>Ensure that bluetooth on your smart device is enabled.</li> <li>Beacons need to be synced with your Hover Racer and app game before first use. If not, follow app instructions for Beacon Set Up.</li> <li>If using more than 4 beacons, make sure to sync additional beacons in the Beacon Set Up menu in the app game. All beacons must be synced with a same single smart device that is hosting the race or battle.</li> </ul> |

### THIS PRODUCT CONTAINS A LITHIUM-POLYMER BATTERY 3.7V 650mAh:

LiPo batteries have a severe risk of fire and injury if they are improperly handled or misused. They may explode, overheat or ignite. Read all following precautions and instructions regarding the care and use of LiPo batteries. The built-in LiPo battery is only to be used with the racer and charger included with this product.

- Keep away from flammable materials.
- Do not expose to direct sunlight.
- Do not place in fires or leave in hot places.
- Do not drop or make subject to strong impact.
- Keep dry and away from water.
- Remove exhausted batteries as soon as possible and discard properly.
- Remove all batteries from the compartment if toy is not used for a long period.
- The supply terminals are not to be short circuited.
- Never throw batteries in a fire or attempt to open outer casing.

LiPo Battery Disposal: LiPo batteries must be recycled or disposed of properly. They should not be disposed of with other household waste. Check your local laws and regulations for correct recycling and/or battery disposal.

### ALKALINE BATTERY CAUTIONS

- Do not use rechargeable batteries.
- Different types of batteries or new and old batteries are not to be mixed.
- Batteries are to be inserted using correct polarity.
- Remove exhausted batteries as soon as possible and discard properly.
- Remove all batteries from compartment if toy is not used for a long period.
- Never throw batteries in a fire or attempt to open the outer casing.

**WARNING:** Batteries are harmful if swallowed. Please keep away from children.

Battery Disposal: Dispose of batteries according to the local laws and regulations of your region. Some batteries may be recycled, and may be accepted for disposal at your local recycling center. If you are not able to identify the applicable rules in your area, please check the instructions of the battery manufacturer.

This device complies with PART 15 of the FCC Rules. Operation is subject to the following two conditions. (1) This device may not cause harmful interference, and (2) this device must accept any interference received, including interference that may cause undesired operation.

CAUTION: Changes or modifications to this unit not expressly approved by the party responsible for compliance could void the user's authority to operate the equipment.

NOTE: This equipment has been tested and found to comply with the limits for a Class B digital device, pursuant to Part 15 of the FCC Rules. These limits are designed to provide reasonable protection against harmful interference in a residential installation. This equipment generates, uses and can radiate radio frequency energy and, if not installed and used in accordance with the instructions, may cause harmful interference to radio communications. However, there is no guarantee that interference will not occur in a particular installation. If this equipment does cause harmful interference to radio or television reception, which can be determined by turning the equipment off and on, the user is encouraged to try to correct the interference by one or more of the following measures: Reorient or relocate the receiving antenna - Increase the separation between the equipment and receiver - Connect the equipment into an outlet on a circuit different from that to which the receiver is connected - Consult the dealer or an experienced radio/TV technician for help.

This equipment complies with FCC radiation exposure limits set forth for an uncontrolled environment.

This transmitter must not be co-located or operating in conjunction with any other antenna or transmitter.

For Quadcopter: This equipment should be installed and operated with minimum distance 20cm between the radiator & your body.

Remove all packaging attachments before giving the toy to a child.

Not suitable for children under 3 years due to small parts that could be swallowed.

Conforms to product safety standards ASTM F963.

Keep instructions for future reference. Do not discard.



©2016 Skyrocket Toys LLC, Los Angeles CA 90066 USA. All Rights Reserved. Sky Viper and Skyrocket and their respective logos are trademarks and/or registered trademarks of Skyrocket Toys LLC. All other trademarks, logos and copyrights are the property of their respective owners, and there is no relationship or affiliation with Skyrocket Toys LLC.

MADE IN CHINA. SKYROCKET

The software included in this product contains copyrighted software that is licensed under the GPLv3. A copy of that license is included in our website at the URL below. You may obtain the complete Corresponding Source code from us for a period of three years after our last shipment of this product and/or spare parts therefor, which will be no earlier than 05-01-2019, on our website at <http://www.skyrockettoys.com/GPL/>