

FCC REPORT

Applicant: Skyrocket Toys, LLC

Address of Applicant: 606 Venice Blvd, Suite D, Venice, CA 90291, U.S.A

Equipment Under Test (EUT)

Product Name: Sky Viper X-Quad

Model No.: 01330

FCC ID: O5301330TX24G

Applicable standards: FCC CFR Title 47 Part 15 Subpart C Section 15.249:2013

Date of sample receipt: May 13, 2014

Date of Test: May 13 - May 19, 2014

Date of report issued: May 19, 2014

Test Result : PASS *

* In the configuration tested, the EUT complied with the standards specified above.

Authorized Signature:



The logo is circular with 'GTS' in the center, 'GLOBAL UNITED TECHNOLOGY SERVICES CO.' around the perimeter, and 'ELECTRICAL TESTING' at the bottom. A handwritten signature is written over the logo.

Robinson Lo
Laboratory Manager

This report details the results of the testing carried out on one sample. The results contained in this test report do not relate to other samples of the same product and does not permit the use of the GTS product certification mark. The manufacturer should ensure that all products in series production are in conformity with the product sample detailed in this report.

This report may only be reproduced and distributed in full. If the product in this report is used in any configuration other than that detailed in the report, the manufacturer must ensure the new system complies with all relevant standards. Any mention of GTS International Electrical Approvals or testing done by GTS International Electrical Approvals in connection with, distribution or use of the product described in this report must be approved by GTS International Electrical Approvals in writing.

This document cannot be reproduced except in full, without prior written approval of the Company. Any unauthorized alteration, forgery or falsification of the content or appearance of this document is unlawful and offenders may be prosecuted to the fullest extent of the law. Unless otherwise stated the results shown in this test report refer only to the sample(s) tested and such sample(s) are retained for 90 days only.*

2 Version

Version No.	Date	Description
00	May 19, 2014	Original

Prepared By:

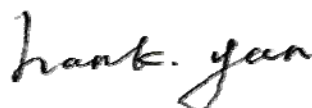

Date:

May 19, 2014

Project Engineer

Check By:



Date:

May 19, 2014

Reviewer

3 Contents

	Page
1 COVER PAGE.....	1
2 VERSION.....	2
3 CONTENTS.....	3
4 TEST SUMMARY.....	4
5 GENERAL INFORMATION.....	5
5.1 CLIENT INFORMATION.....	5
5.2 GENERAL DESCRIPTION OF E.U.T.....	5
5.3 TEST MODE.....	5
6 TEST FACILITY.....	6
6.1 TEST LOCATION.....	6
7 TEST INSTRUMENTS LIST.....	7
8 TEST RESULTS AND MEASUREMENT DATA.....	8
8.1 ANTENNA REQUIREMENT:.....	8
8.2 RADIATED EMISSION METHOD.....	9
8.2.1 <i>Field Strength of The Fundamental Signal</i>	11
8.2.2 <i>Spurious emissions</i>	11
8.2.3 <i>Bandedge emissions</i>	15
8.3 20dB OCCUPY BANDWIDTH.....	16

4 Test Summary

Test Item	Section in CFR 47	Result
Antenna requirement	15.203	Pass
Field strength of the fundamental signal	15.249 (a)	Pass
Spurious emissions	15.249 (a) (d)/15.209	Pass
Band edge	15.249 (d)/15.205	Pass
20dB Occupied Bandwidth	15.215 (c)	Pass

Pass: The EUT complies with the essential requirements in the standard.

N/A: not applicable.

5 General Information

5.1 Client Information

Applicant:	Skyrocket Toys, LLC
Address of Applicant:	606 Venice Blvd, Suite D, Venice, CA 90291, U.S.A
Manufacturer:	Skyrocket Toys, LLC
Address of Manufacturer:	606 Venice Blvd, Suite D, Venice, CA 90291, U.S.A
Factory:	Guangzhou Spinmark Electronics Technology Co., Ltd
Address of factory:	1/F & 2/F, Block A, 64 Songshan Road, Shilou Town, Panyu District Guangzhou, China

5.2 General Description of E.U.T.

Product Name:	Sky Viper X-Quad
Model No.:	01330
Operation Frequency:	2414MHz~2472.7MHz
Modulation technology:	GFSK
Test frequency:	Lowest channel=2414MHz, Middle channel=2448.7MHz, Highest channel=2472.7MHz
Antenna Type:	Integral
Antenna gain:	2dBi
Power supply:	DC 6.0V(4 x "AAA" Size)

5.3 Test mode

Transmitting mode	Keep the EUT in transmitting mode. New battery is used during all test .		
Per-test mode.			
We have verified the construction and function in typical operation, The EUT was placed on three different polar directions; i.e. X axis, Y axis, Z axis. which was shown in this test report and defined as follows:			
Axis	X	Y	Z
Field Strength(dBuV/m)	84.22	88.49	81.83
Final Test Mode:			
According to ANSI C63.4 standards, the test results are both the "worst case" and "worst setup": Y axis (see the test setup photo)			

6 Test Facility

The test facility is recognized, certified, or accredited by the following organizations:

- **CNAS —Registration No.: CNAS L5775**

CNAS has accredited Global United Technology Services Co., Ltd. To ISO/IEC 17025 General Requirements for the competence of testing and calibration laboratories (CNAS-CL01 Accreditation Criteria for the Competence of Testing and Calibration Laboratories) for the competence in the field of testing.

- **FCC —Registration No.: 600491**

Global United Technology Services Co., Ltd., Shenzhen EMC Laboratory has been registered and fully described in a report filed with the (FCC) Federal Communications Commission. The acceptance letter from the FCC is maintained in files. Registration 600491

- **Industry Canada (IC)**

The 3m Semi-anechoic chamber of Global United Technology Services Co., Ltd. Has been Registered by Certification and Engineering Bureau of Industry Canada for radio equipment testing with Registration No.: 9079A-2.

6.1 Test Location

All tests were performed at:

Global United Technology Services Co., Ltd.

Address: 2nd Floor, Block No.2, Laodong Industrial Zone, Xixiang Road Baoan District, Shenzhen, China

Tel: 0755-27798480

Fax: 0755-27798960

7 Test Instruments list

Radiated Emission:						
Item	Test Equipment	Manufacturer	Model No.	Inventory No.	Cal.Date (mm-dd-yy)	Cal.Due date (mm-dd-yy)
1	3m Semi- Anechoic Chamber	ZhongYu Electron	9.2(L)*6.2(W)* 6.4(H)	GTS250	Mar. 30 2013	Mar. 29 2015
2	Control Room	ZhongYu Electron	6.2(L)*2.5(W)* 2.4(H)	GTS251	N/A	N/A
3	EMI Test Receiver	Rohde & Schwarz	ESU26	GTS203	Jul. 03 2013	Jul. 02 2014
4	BiConiLog Antenna	SCHWARZBECK MESS-ELEKTRONIK	VULB9163	GTS214	Jul. 03 2013	Jul. 02 2014
5	Double -ridged waveguide horn	SCHWARZBECK MESS-ELEKTRONIK	9120D-829	GTS208	Jul. 03 2013	Jul. 02 2014
6	Horn Antenna	ETS-LINDGREN	3160	GTS217	Jul. 03 2013	Jul. 02 2014
7	EMI Test Software	AUDIX	E3	N/A	N/A	N/A
8	Coaxial Cable	GTS	N/A	GTS213	Jul. 03 2013	Jul. 02 2014
9	Coaxial Cable	GTS	N/A	GTS211	Jul. 03 2013	Jul. 02 2014
10	Coaxial cable	GTS	N/A	GTS210	Jul. 03 2013	Jul. 02 2014
11	Coaxial Cable	GTS	N/A	GTS212	Jul. 03 2013	Jul. 02 2014
12	Amplifier(100kHz-3GHz)	HP	8347A	GTS204	Jul. 03 2013	Jul. 02 2014
13	Amplifier(2GHz-20GHz)	HP	8349B	GTS206	Jul. 03 2013	Jul. 02 2014
14	Amplifier (18-26GHz)	Rohde & Schwarz	AFS33-18002 650-30-8P-44	GTS218	Jul. 03 2013	Jul. 02 2014
15	Band filter	Amindeon	82346	GTS219	Jul. 03 2013	Jul. 02 2014

8 Test results and Measurement Data

8.1 Antenna requirement:

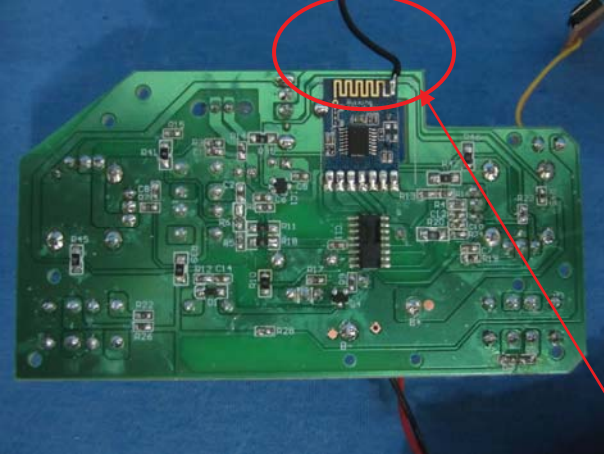
Standard requirement:	FCC Part15 C Section 15.203 /247(c)
<p>15.203 requirement:</p> <p>An intentional radiator shall be designed to ensure that no antenna other than that furnished by the responsible party shall be used with the device. The use of a permanently attached antenna or of an antenna that uses a unique coupling to the intentional radiator, the manufacturer may design the unit so that a broken antenna can be replaced by the user, but the use of a standard antenna jack or electrical connector is prohibited.</p>	
<p>E.U.T Antenna:</p> <p><i>The antenna is Integral antenna, the best case gain of the antenna is 2dBi</i></p>	
 <p style="text-align: right; color: red;">RF Antenna</p>	

8.2 Radiated Emission Method

Test Requirement:	FCC Part15 C Section 15.209				
Test Method:	ANSI C63.4:2003				
Test Frequency Range:	30MHz to 25GHz				
Test site:	Measurement Distance: 3m				
Receiver setup:	Frequency	Detector	RBW	VBW	Value
	30MHz-1GHz	Quasi-peak	120KHz	300KHz	Quasi-peak
	Above 1GHz	Peak	1MHz	3MHz	Peak
		Peak	1MHz	10Hz	Average
Limit: (Field strength of the fundamental signal)	Frequency	Limit (dBuV/m @3m)		Value	
	2400MHz-2483.5MHz	94.00		Average	
		114.00		Peak	
Limit: (Spurious Emissions)	Frequency	Limit (dBuV/m @3m)		Value	
	30MHz-88MHz	40.00		Quasi-peak	
	88MHz-216MHz	43.50		Quasi-peak	
	216MHz-960MHz	46.00		Quasi-peak	
	960MHz-1GHz	54.00		Quasi-peak	
	Above 1GHz	54.00		Average	
74.00		Peak			
Limit: (band edge)	Emissions radiated outside of the specified frequency bands, except for harmonics, shall be attenuated by at least 50 dB below the level of the fundamental or to the general radiated emission limits in Section 15.209, whichever is the lesser attenuation.				
Test Procedure:	<ol style="list-style-type: none"> The EUT was placed on the top of a rotating table 0.8 meters above the ground at a 3 meter camber. The table was rotated 360 degrees to determine the position of the highest radiation. The EUT was set 3 meters away from the interference-receiving antenna, which was mounted on the top of a variable-height antenna tower. The antenna height is varied from one meter to four meters above the ground to determine the maximum value of the field strength. Both horizontal and vertical polarizations of the antenna are set to make the measurement. For each suspected emission, the EUT was arranged to its worst case and then the antenna was tuned to heights from 1 meter to 4 meters and the rota table was turned from 0 degrees to 360 degrees to find the maximum reading. The test-receiver system was set to Peak Detect Function and Specified Bandwidth with Maximum Hold Mode. If the emission level of the EUT in peak mode was 10dB lower than the limit specified, then testing could be stopped and the peak values of the EUT would be reported. Otherwise the emissions that did not have 10dB margin would be re-tested one by one using peak, quasi-peak or average method as specified and then reported in a data 				

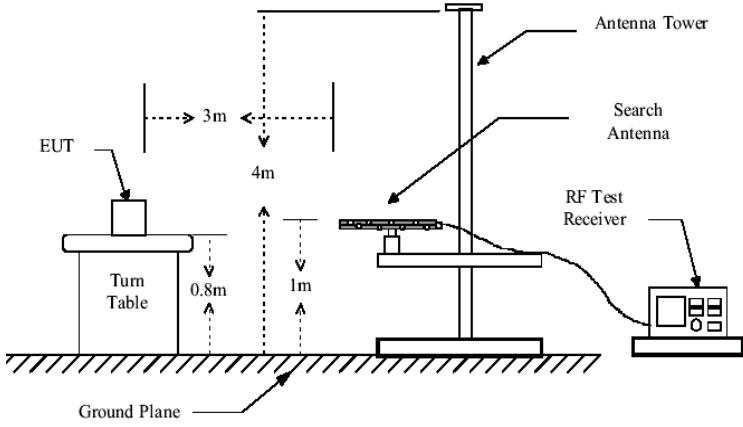
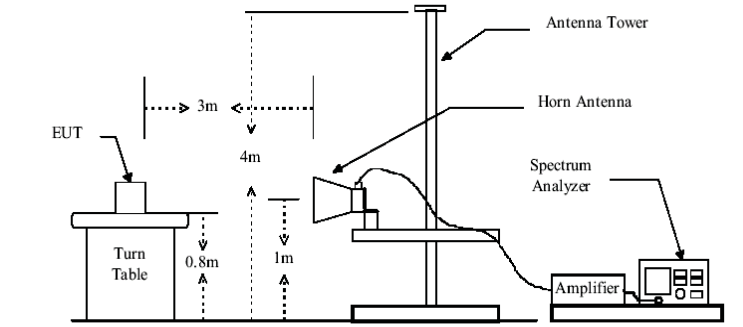
	sheet.
Test setup:	<p>Below 1GHz</p>  <p>Above 1GHz</p> 
Test Instruments:	Refer to section 6.0 for details
Test mode:	Refer to section 5.3 for details
Test results:	Pass

Measurement data:

8.2.1 Field Strength of The Fundamental Signal

Peak value:

Frequency (MHz)	Read Level (dBuV)	Antenna Factor (dB/m)	Cable Loss (dB)	Preamp Factor (dB)	Level (dBuV/m)	Limit Line (dBuV/m)	Over Limit (dB)	polarization
2414.00	86.48	27.55	5.41	33.98	85.46	114.00	-28.54	Horizontal
2414.00	89.51	27.55	5.41	33.98	88.49	114.00	-25.51	Vertical
2448.70	86.84	27.45	5.44	33.95	85.78	114.00	-28.22	Horizontal
2448.70	89.90	27.45	5.44	33.95	88.84	114.00	-25.16	Vertical
2472.70	87.25	27.51	5.47	33.91	86.32	114.00	-27.68	Horizontal
2472.70	89.42	27.51	5.47	33.91	88.49	114.00	-25.51	Vertical

Average value:

Frequency (MHz)	Read Level (dBuV)	Antenna Factor (dB/m)	Cable Loss (dB)	Preamp Factor (dB)	Level (dBuV/m)	Limit Line (dBuV/m)	Over Limit (dB)	polarization
2414.00	54.98	27.55	5.41	33.98	53.96	94.00	-40.04	Horizontal
2414.00	56.87	27.55	5.41	33.98	55.85	94.00	-38.15	Vertical
2448.70	55.26	27.45	5.44	33.95	54.20	94.00	-39.80	Horizontal
2448.70	57.14	27.45	5.44	33.95	56.08	94.00	-37.92	Vertical
2472.70	54.73	27.51	5.47	33.91	53.80	94.00	-40.20	Horizontal
2472.70	56.85	27.51	5.47	33.91	55.92	94.00	-38.08	Vertical

Note: For fundamental frequency, RBW=2MHz, VBW =6MHz, peak detector for PK value and AV detector for AV value.

8.2.2 Spurious emissions

■ Below 1GHz

Frequency (MHz)	Read Level (dBuV)	Antenna Factor (dB/m)	Cable Loss (dB)	Preamp Factor (dB)	Level (dBuV/m)	Limit Line (dBuV/m)	Over Limit (dB)	polarization
38.08	33.10	15.11	0.64	32.06	16.79	40.00	-23.21	Vertical
68.15	32.23	11.34	0.93	31.89	12.61	40.00	-27.39	Vertical
96.10	38.65	14.90	1.16	31.75	22.96	43.50	-20.54	Vertical
159.78	37.25	10.64	1.63	32.02	17.50	43.50	-26.00	Vertical
201.39	35.03	12.60	1.85	32.14	17.34	43.50	-26.16	Vertical
878.32	32.72	22.87	4.77	31.21	29.15	46.00	-16.85	Vertical
40.99	34.67	15.57	0.67	32.05	18.86	40.00	-21.14	Horizontal
104.54	36.73	14.73	1.23	31.78	20.91	43.50	-22.59	Horizontal
159.78	40.12	10.64	1.63	32.02	20.37	43.50	-23.13	Horizontal
284.98	37.48	14.75	2.29	32.17	22.35	46.00	-23.65	Horizontal
432.55	34.42	17.53	3.01	31.78	23.18	46.00	-22.82	Horizontal
968.93	36.77	23.55	5.11	31.22	34.21	54.00	-19.79	Horizontal

■ Above 1GHz

Test channel:	Lowest channel
---------------	----------------

Peak value:

Frequency (MHz)	Read Level (dBuV)	Antenna Factor (dB/m)	Cable Loss (dB)	Preamp Factor (dB)	Level (dBuV/m)	Limit Line (dBuV/m)	Over Limit (dB)	polarization
4824.00	46.76	31.81	8.62	32.10	55.09	74.00	-18.91	Vertical
7236.00	36.15	36.24	11.68	32.10	51.97	74.00	-22.03	Vertical
9648.00	27.23	38.07	14.18	31.68	47.80	74.00	-26.20	Vertical
12060.00	*					74.00		Vertical
14472.00	*					74.00		Vertical
4824.00	43.02	31.81	8.62	32.10	51.35	74.00	-22.65	Horizontal
7236.00	29.86	36.24	11.68	32.10	45.68	74.00	-28.32	Horizontal
9648.00	25.92	38.07	14.18	31.68	46.49	74.00	-27.51	Horizontal
12060.00	*					74.00		Horizontal
14472.00	*					74.00		Horizontal

Average value:

Frequency (MHz)	Read Level (dBuV)	Antenna Factor (dB/m)	Cable Loss (dB)	Preamp Factor (dB)	Level (dBuV/m)	Limit Line (dBuV/m)	Over Limit (dB)	polarization
4824.00	29.45	31.81	8.62	32.10	37.78	54.00	-16.22	Vertical
7236.00	19.05	36.24	11.68	32.10	34.87	54.00	-19.13	Vertical
9648.00	11.99	38.07	14.18	31.68	32.56	54.00	-21.44	Vertical
12060.00	*					54.00		Vertical
14472.00	*					54.00		Vertical
4824.00	27.45	31.81	8.62	32.10	35.78	54.00	-18.22	Horizontal
7236.00	16.53	36.24	11.68	32.10	32.35	54.00	-21.65	Horizontal
9648.00	10.45	38.07	14.18	31.68	31.02	54.00	-22.98	Horizontal
12060.00	*					54.00		Horizontal
14472.00	*					54.00		Horizontal

Remark:

1. Final Level = Receiver Read level + Antenna Factor + Cable Loss – Preamplifier Factor
2. The emission levels of other frequencies are very lower than the limit and not show in test report.
3. “*”, means this data is the too weak instrument of signal is unable to test.

Test channel:	Middle channel
---------------	----------------

Peak value:

Frequency (MHz)	Read Level (dBuV)	Antenna Factor (dB/m)	Cable Loss (dB)	Preamp Factor (dB)	Level (dBuV/m)	Limit Line (dBuV/m)	Over Limit (dB)	polarization
4897.40	44.87	31.88	8.68	32.13	53.30	74.00	-20.70	Vertical
7346.10	34.80	36.56	11.79	31.80	51.35	74.00	-22.65	Vertical
9794.80	27.80	38.43	14.29	31.65	48.87	74.00	-25.13	Vertical
12243.50	*					74.00		Vertical
14692.20	*					74.00		Vertical
4897.40	41.13	31.88	8.68	32.13	49.56	74.00	-24.44	Horizontal
7346.10	29.89	36.56	11.79	31.80	46.44	74.00	-27.56	Horizontal
9794.80	26.32	38.43	14.29	31.65	47.39	74.00	-26.61	Horizontal
12243.50	*					74.00		Horizontal
14692.20	*					74.00		Horizontal

Average value:

Frequency (MHz)	Read Level (dBuV)	Antenna Factor (dB/m)	Cable Loss (dB)	Preamp Factor (dB)	Level (dBuV/m)	Limit Line (dBuV/m)	Over Limit (dB)	polarization
4897.40	29.44	31.88	8.68	32.13	37.87	54.00	-16.13	Vertical
7346.10	19.79	36.56	11.79	31.80	36.34	54.00	-17.66	Vertical
9794.80	14.45	38.43	14.29	31.65	35.52	54.00	-18.48	Vertical
12243.50	*					54.00		Vertical
14692.20	*					54.00		Vertical
4897.40	26.44	31.88	8.68	32.13	34.87	54.00	-19.13	Horizontal
7346.10	14.87	36.56	11.79	31.80	31.42	54.00	-22.58	Horizontal
9794.80	11.45	38.43	14.29	31.65	32.52	54.00	-21.48	Horizontal
12243.50	*					54.00		Horizontal
14692.20	*					54.00		Horizontal

Remark:

1. Final Level = Receiver Read level + Antenna Factor + Cable Loss – Pre-amplifier Factor
2. The emission levels of other frequencies are very lower than the limit and not show in test report.
3. “*”, means this data is the too weak instrument of signal is unable to test.

Test channel:	Highest channel
---------------	-----------------

Peak value:

Frequency (MHz)	Read Level (dBuV)	Antenna Factor (dB/m)	Cable Loss (dB)	Preamp Factor (dB)	Level (dBuV/m)	Limit Line (dBuV/m)	Over Limit (dB)	polarization
4945.40	44.20	31.91	8.71	32.16	52.66	74.00	-21.34	Vertical
7418.10	29.87	36.56	11.77	31.81	46.39	74.00	-27.61	Vertical
9890.80	25.73	38.72	14.35	31.82	46.98	74.00	-27.02	Vertical
12363.50	*					74.00		Vertical
14836.20	*					74.00		Vertical
4945.40	37.74	31.91	8.71	32.16	46.20	74.00	-27.80	Horizontal
7418.10	28.60	36.56	11.77	31.81	45.12	74.00	-28.88	Horizontal
9890.80	25.70	38.72	14.35	31.82	46.95	74.00	-27.05	Horizontal
12363.50	*					74.00		Horizontal
14836.20	*					74.00		Horizontal

Average value:

Frequency (MHz)	Read Level (dBuV)	Antenna Factor (dB/m)	Cable Loss (dB)	Preamp Factor (dB)	Level (dBuV/m)	Limit Line (dBuV/m)	Over Limit (dB)	polarization
4945.40	29.79	31.91	8.71	32.16	38.25	54.00	-15.75	Vertical
7418.10	14.46	36.56	11.77	31.81	30.98	54.00	-23.02	Vertical
9890.80	10.87	38.72	14.35	31.82	32.12	54.00	-21.88	Vertical
12363.50	*					54.00		Vertical
14836.20	*					54.00		Vertical
4945.40	24.89	31.91	8.71	32.16	33.35	54.00	-20.65	Horizontal
7418.10	13.88	36.56	11.77	31.81	30.40	54.00	-23.60	Horizontal
9890.80	10.46	38.72	14.35	31.82	31.71	54.00	-22.29	Horizontal
12363.50	*					54.00		Horizontal
14836.20	*					54.00		Horizontal

Remark:

1. *Final Level = Receiver Read level + Antenna Factor + Cable Loss – Preamplifier Factor*
2. *The emission levels of other frequencies are very lower than the limit and not show in test report.*
3. *“*”, means this data is the too weak instrument of signal is unable to test.*

8.2.3 Bandedge emissions

Test channel:	Lowest channel
---------------	----------------

Peak value:

Frequency (MHz)	Read Level (dBuV)	Antenna Factor (dB/m)	Cable Loss (dB)	Preamp Factor (dB)	Level (dBuV/m)	Limit Line (dBuV/m)	Over Limit (dB)	polarization
2310.00	44.00	27.91	5.30	34.11	43.10	74.00	-30.90	Vertical
2390.00	44.87	27.59	5.38	34.01	43.83	74.00	-30.17	Vertical
2400.00	45.74	27.55	5.40	34.00	44.69	74.00	-29.31	Vertical
2310.00	44.76	27.91	5.30	34.11	43.86	74.00	-30.14	Horizontal
2390.00	44.91	27.59	5.38	34.01	43.87	74.00	-30.13	Horizontal
2400.00	45.83	27.55	5.40	34.00	44.78	74.00	-29.22	Horizontal

Average value:

Frequency (MHz)	Read Level (dBuV)	Antenna Factor (dB/m)	Cable Loss (dB)	Preamp Factor (dB)	Level (dBuV/m)	Limit Line (dBuV/m)	Over Limit (dB)	polarization
2310.00	27.50	27.91	5.30	34.11	26.60	54.00	-27.40	Vertical
2390.00	27.00	27.59	5.38	34.01	25.96	54.00	-28.04	Vertical
2400.00	27.45	27.55	5.40	34.00	26.40	54.00	-27.60	Vertical
2310.00	27.56	27.91	5.30	34.11	26.66	54.00	-27.34	Horizontal
2390.00	27.19	27.59	5.38	34.01	26.15	54.00	-27.85	Horizontal
2400.00	27.39	27.55	5.40	34.00	26.34	54.00	-27.66	Horizontal

Test channel:	Highest channel
---------------	-----------------

Peak value:

Frequency (MHz)	Read Level (dBuV)	Antenna Factor (dB/m)	Cable Loss (dB)	Preamp Factor (dB)	Level (dBuV/m)	Limit Line (dBuV/m)	Over Limit (dB)	polarization
2483.50	47.05	27.53	5.47	33.92	46.13	74.00	-27.87	Vertical
2500.00	44.50	27.55	5.49	33.90	43.64	74.00	-30.36	Vertical
2483.50	46.38	27.53	5.47	33.92	45.46	74.00	-28.54	Horizontal
2500.00	44.67	27.55	5.49	33.90	43.81	74.00	-30.19	Horizontal

Average value:

Frequency (MHz)	Read Level (dBuV)	Antenna Factor (dB/m)	Cable Loss (dB)	Preamp Factor (dB)	Level (dBuV/m)	Limit Line (dBuV/m)	Over Limit (dB)	polarization
2483.50	27.40	27.53	5.47	33.92	26.48	54.00	-27.52	Vertical
2500.00	24.53	27.55	5.49	33.90	23.67	54.00	-30.33	Vertical
2483.50	26.49	27.53	5.47	33.92	25.57	54.00	-28.43	Horizontal
2500.00	24.13	27.55	5.49	33.90	23.27	54.00	-30.73	Horizontal

Remark:

- Final Level = Receiver Read level + Antenna Factor + Cable Loss – Pre-amplifier Factor

8.3 20dB Occupy Bandwidth

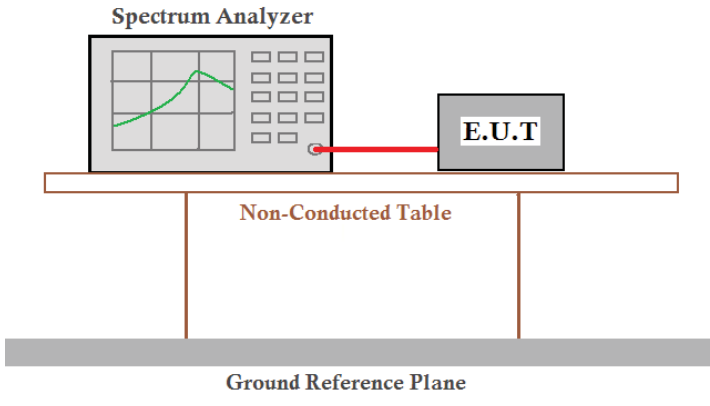
Test Requirement:	FCC Part15 C Section 15.249/15.215
Test Method:	ANSI C63.4:2003
Limit:	Operation Frequency range 2400MHz~2483.5MHz
Test setup:	
Test Instruments:	Refer to section 6.0 for details
Test mode:	Refer to section 5.3 for details
Test results:	Pass

Measurement Data

Test channel (MHz)	20dB bandwidth(MHz)	Result
2414.00	1.048	Pass
2448.70	1.429	Pass
2472.70	1.575	Pass

Test plot as follows:

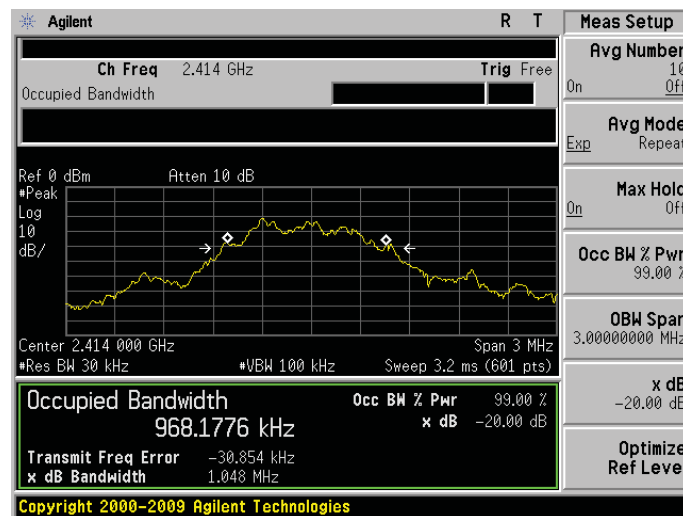

2405MHz



2435MHz

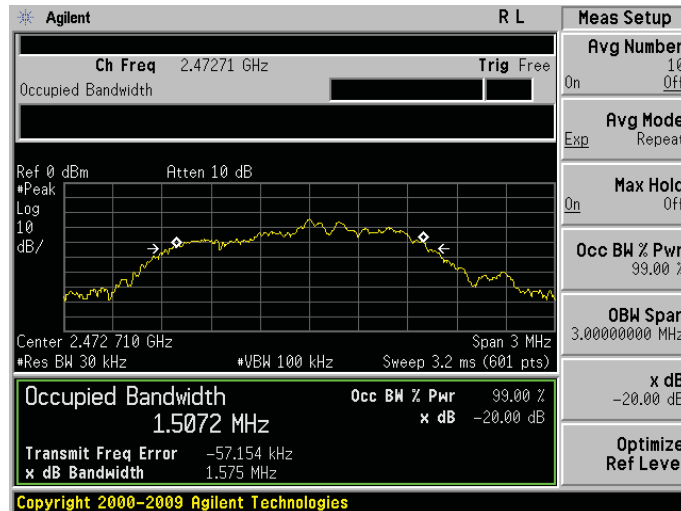

2468MHz

-----End-----