

PAGE:		2 OF 2			
DOC.No:		DWG-EB-SR006T-00-SZ-49M			
Item	Change content	Date	Change point	Remark	

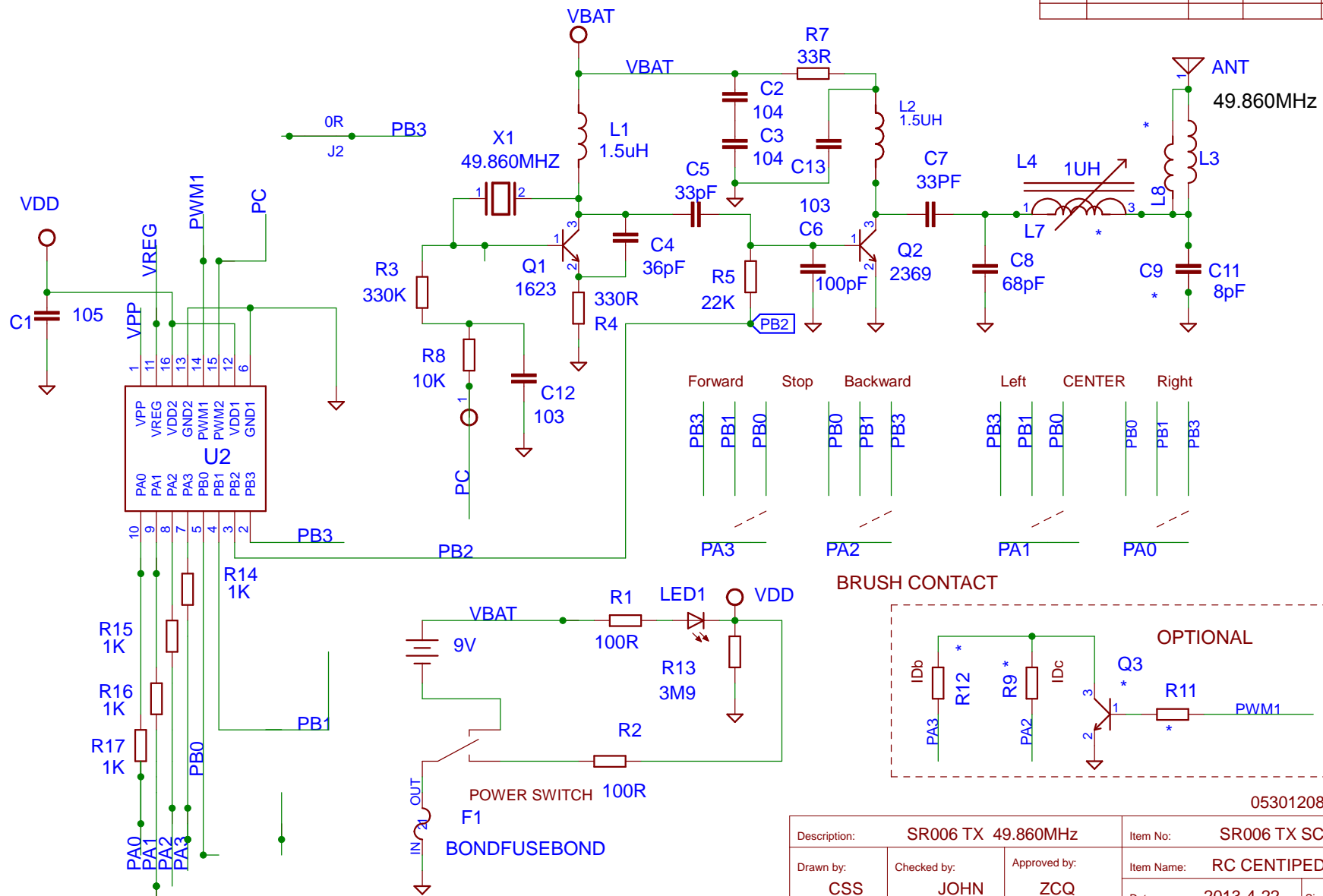

Description: SR006 TX 49.860MHz			Item No: SR006 TX SCH		
Drawn by: CSS	Checked by: JOHN	Approved by: ZCQ	Item Name: RC CENTIPEDE		
TAT KEI WAH SING ELECTRONIC (SHENZHEN) CO.,LTD.			Date: 2013-4-22	Size: A4	
			DWG.No: OE13521A	Rev: A/0	

05301208