

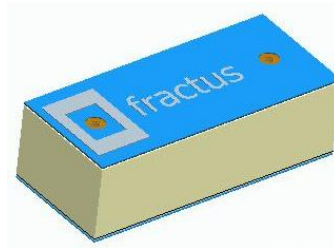

Fractus Compact Reach Xtend™

Bluetooth® , Zigbee® , 802.11 b/g/n WLAN

Chip Antenna



**Antenna Part Number:
FR05-S1-N-0-102**

This product is protected by at least the following patents PAT. US 7,148,850, US 7,202,822 and other domestic and international patents pending. Any update on new patents linked to this product will appear in <http://www.fractus.com/index.php/fractus/patents>

All information contained within this document is property of Fractus and is subject to change without prior notice. Information is provided "as is" and without warranties. It is prohibited to copy or reproduce this information without prior approval.

Fractus is an ISO 9001:2008 certified company. All our antennas are lead-free and RoHS compliant.





TABLE OF CONTENTS

| | |
|---|-----------|
| 1. ANTENNA DESCRIPTION | 3 |
| 2. QUICK REFERENCE GUIDE | 3 |
| 3. ELECTRICAL PERFORMANCE | 4 |
| 3.1. FRACTUS EVALUATION BOARD | 4 |
| 3.2. VSWR AND EFFICIENCY | 4 |
| 3.3. RADIATION PATTERNS (at 2.45 GHz), GAIN AND EFFICIENCY | 5 |
| 3.4. CAPABILITIES AND MEASUREMENT SYSTEMS | 6 |
| 4. MECHANICAL CHARACTERISTICS | 7 |
| 4.1. DIMENSIONS, TOLERANCES & MATERIALS | 7 |
| 4.2. COLOUR RANGE FOR THE INK | 7 |
| 4.3. ANTENNA FOOTPRINT (as used in the evaluation board) | 8 |
| 5. MATCHING NETWORK | 8 |
| 6. ASSEMBLY PROCESS | 9 |
| 7. PACKAGING | 11 |



1. ANTENNA DESCRIPTION

Fractus® Compact Reach Xtend™ chip antenna is engineered specifically for Bluetooth®, WLAN 802.11 b/g/n and other wireless devices operating at the ISM 2.4 GHz band. Compact Reach Xtend combines small form factor size and high performance to improve the functionality of your wireless devices.

The Compact Reach Xtend is a low-cost antenna solution that combines small form factor and high performance with integration flexibility making it ideal for small consumer electronics devices such as wireless headsets and USB dongles.

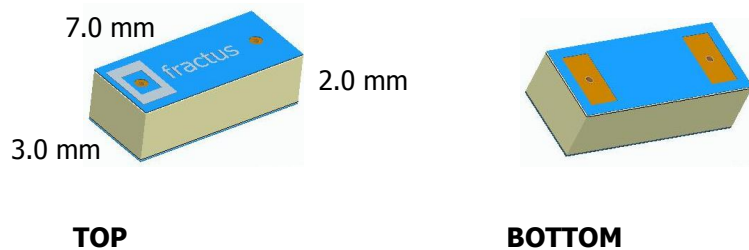

APPLICATIONS

- Headsets, Headphones
- Medical devices
- Modules WiFi, Bluetooth, Zigbee...
- USB Dongles
- Sensors (bike speed, telemetry...)
- Military
- Digital cameras

BENEFITS

- High efficiency and gain
- Cost-effective
- Small footprint
- Easy to use (pick and place)

2. QUICK REFERENCE GUIDE

| Technical Features | |
|------------------------|--------------------------|
| Frequency range | 2.4 GHz - 2.5 GHz |
| Average Efficiency | 72.0 % |
| Radiation Pattern | Omnidirectional |
| Peak Gain | 1.7 dB |
| VSWR | < 2:1 |
| Polarization | Linear |
| Weight (approx.) | 0.1 g |
| Temperature | -40 to + 85 °C |
| Impedance | 50 Ω |
| Dimensions (L x W x H) | 7.0 mm x 3.0 mm x 2.0 mm |

Table 1 -Technical Features. Measures from the evaluation board (47.0 mm x 23.0 mm x 1.0 mm PCB). See picture in page 5.

Please contact info@fractus.com if you require additional information on antenna integration or optimisation on your PCB.

FRACTUS S.A.
www.fractus.com
Tel: +34 935442690
Fax: +34 935442691



3. ELECTRICAL PERFORMANCE

3.1. FRACTUS EVALUATION BOARD

The Fractus configuration used in testing the Compact Reach Xtend chip antenna is displayed in Figure 1.

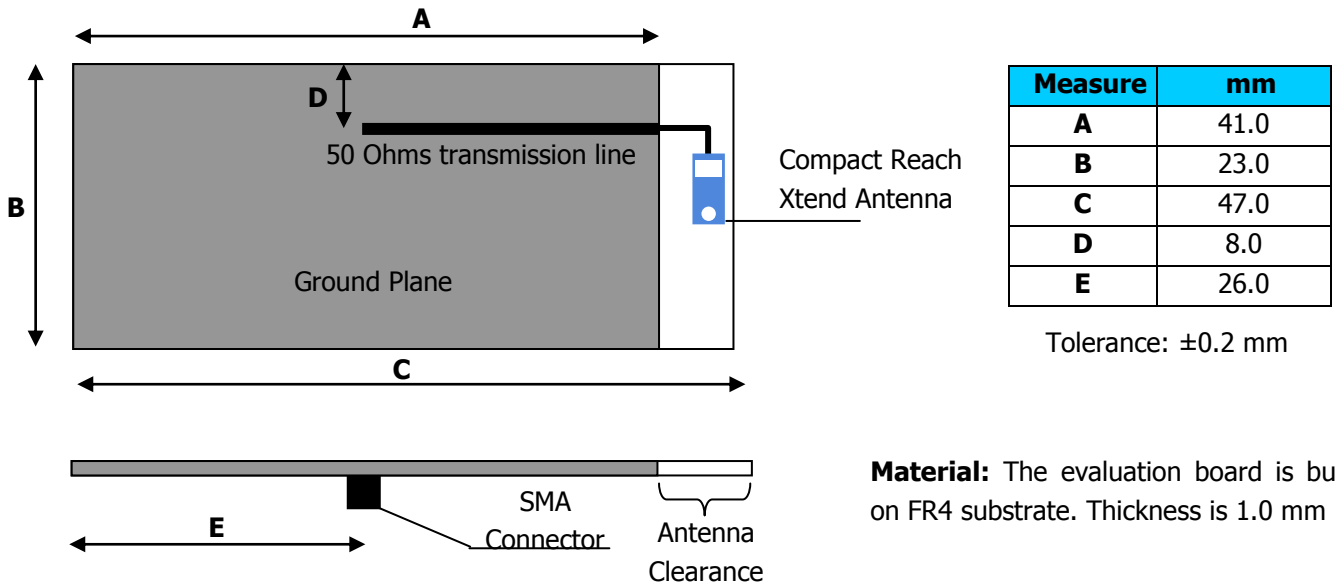
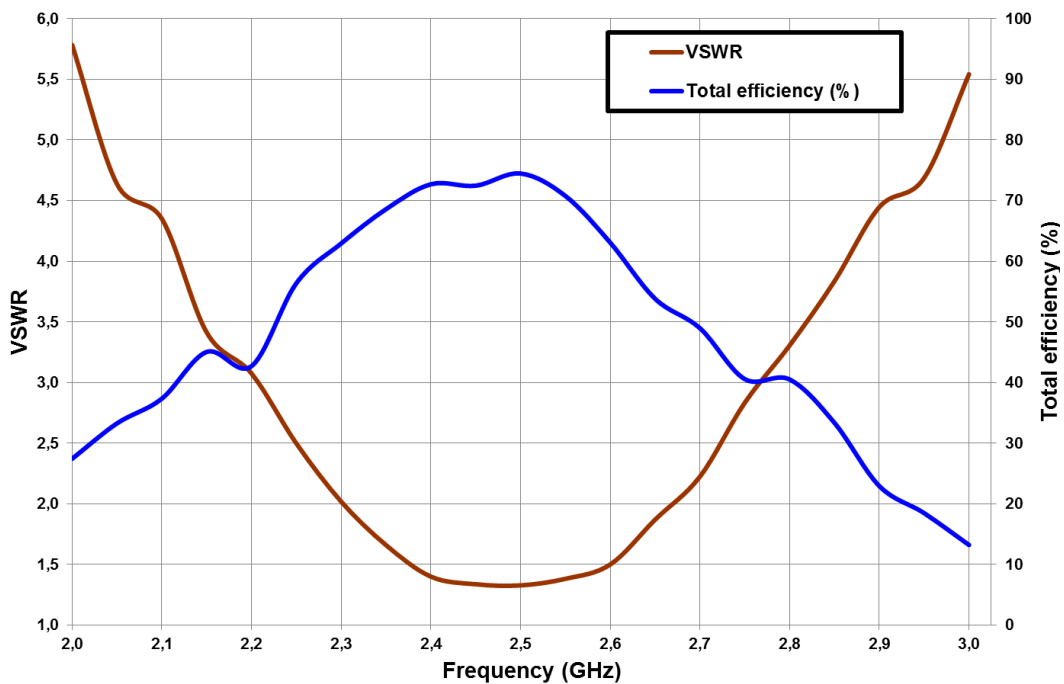

Figure 1 – Compact Reach Xtend Evaluation Board. See picture in page 5

3.2. VSWR AND EFFICIENCY



Graph 1 - VSWR (Voltage Standing Wave Ratio) and Efficiency (%) vs. Frequency (GHz)



3.3. RADIATION PATTERNS (at 2.45 GHz), GAIN AND EFFICIENCY

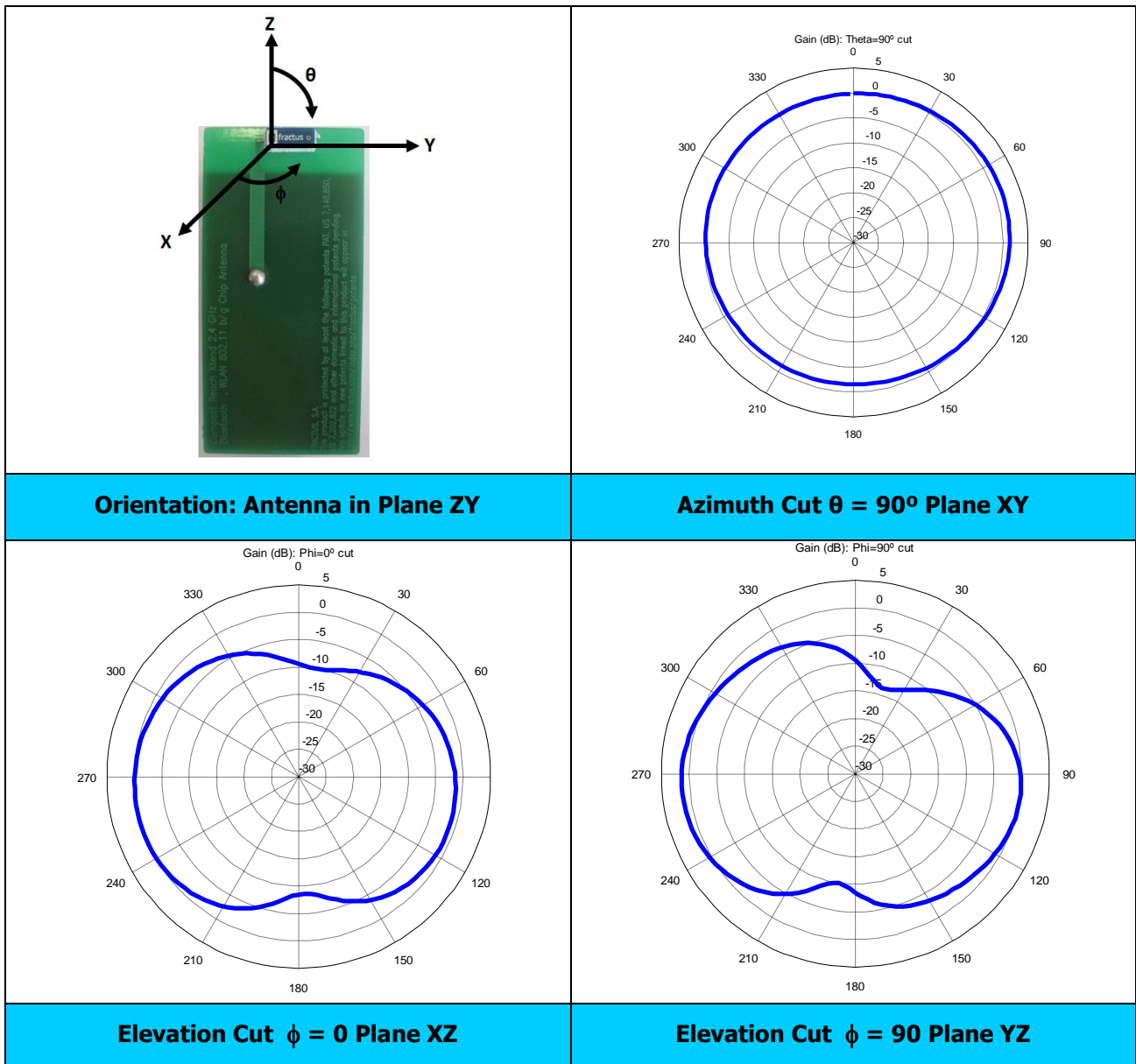

| | | |
|-------------------|--|-------------------|
| Gain | Peak Gain | 1.7 dB |
| | Average Gain across the band | 1.3 dB |
| | Gain Range across the band (min, max) | 0.7 dB <-> 1.7 dB |
| Efficiency | Peak Efficiency | 75.0 % |
| | Average Efficiency across the band | 72.0 % |
| | Efficiency Range across the band | 69.0 % - 75.0 % |

Table 2 – Antenna Gain and Efficiency within the 2.4-2.5 GHz band. Measures made in the evaluation board and in the Satimo STARGATE 32 anechoic chamber.



3.4. CAPABILITIES AND MEASUREMENT SYSTEMS

Fractus specialises in designing and manufacturing optimised antennas for wireless applications and providing our clients with RF expertise. We offer turn-key antenna products and antenna integration support to minimise your time requirement and maximize your return on investment during your product development efforts. We also provide our clients with the opportunity to leverage our in-house testing and measurement facilities to obtain accurate results quickly and efficiently.



Agilent E5071B

VSWR
&
S Parameters

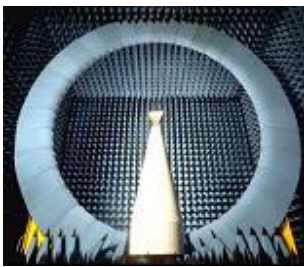
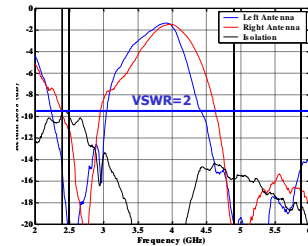

SATIMO's STARGATE 32

Radiation
Pattern
&
Efficiency

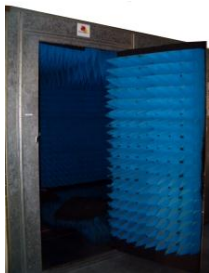
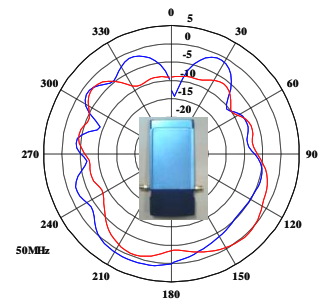

Anechoic and semi-anechoic chambers and full equipped in-house lab



4. MECHANICAL CHARACTERISTICS

4.1. DIMENSIONS, TOLERANCES & MATERIALS

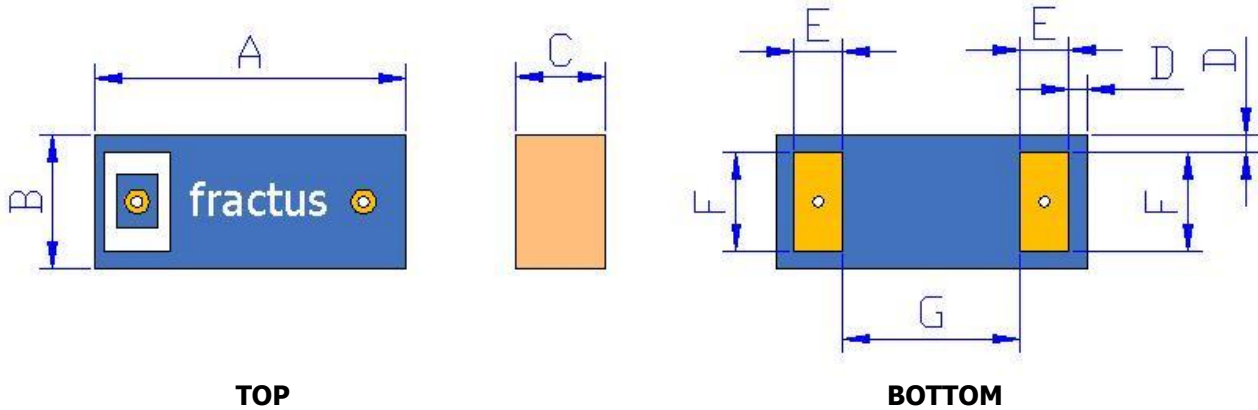

Figure 2 – Antenna Dimensions and Tolerances

| Measure | mm | Measure | mm |
|---------|----------------|---------|---------------|
| A | 7.0 ± 0.2 | E | 1.1 ± 0.1 |
| B | 3.0 ± 0.2 | F | 2.2 ± 0.1 |
| C | 2.0 ± 0.2 | G | 4.0 ± 0.2 |
| D | 0.4 ± 0.15 | | |

The white square located on the top side of the antenna indicates the feed pad.

Fractus Compact Reach Xtend chip antenna is compliant with the directive **2002/95/EC** on the restriction of the use of hazardous substances (**RoHS**).

The RoHS certificate can be downloaded from <http://www.fractus.com/index.php/fractus/documentation>

4.2. COLOUR RANGE FOR THE INK

The next figure shows the range of the colours in the antenna:

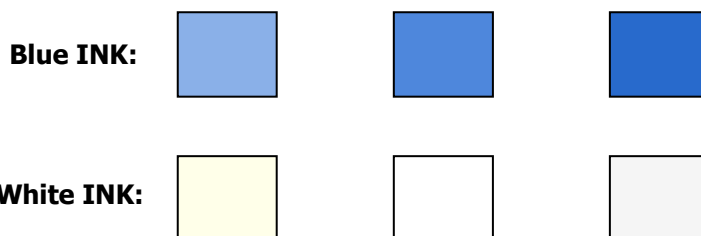

Acceptable colour range



4.3. ANTENNA FOOTPRINT (as used in the evaluation board)

This antenna footprint applies for the reference evaluation board described in page 4 of this User Manual. Feeding line dimensions over the clearance zone described in figure 3 applies for a 1 mm thickness FR4 PCB.

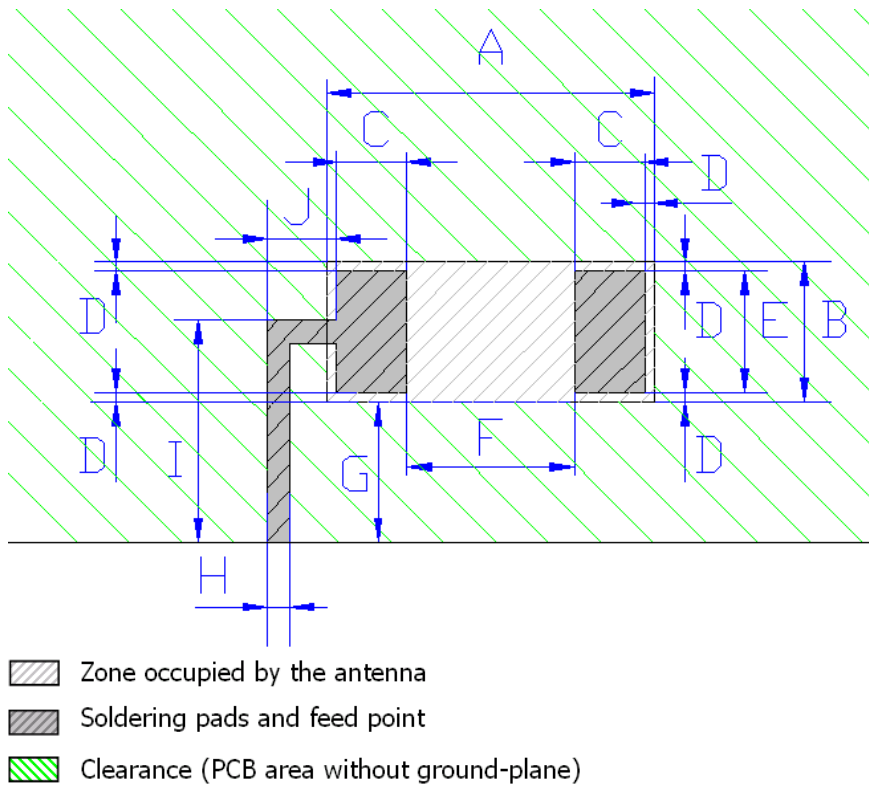

| Measure | mm |
|---------|-----|
| A | 7.0 |
| B | 3.0 |
| C | 1.5 |
| D | 0.2 |
| E | 2.6 |
| F | 3.6 |
| G | 3.0 |
| H | 0.5 |
| I | 4.7 |
| J | 1.5 |

Tolerance: ± 0.2 mm

Figure 3 – Antenna Footprint Details

Other PCB form factors and configurations may require a different feeding configuration, feeding line dimensions and clearance areas. If you require support for the integration of the antenna in your design, please contact info@fractus.com

5. MATCHING NETWORK

The specs of a Fractus standard antenna are measured in their evaluation board, which is an ideal case. In a real design, components nearby the antenna, LCD's, batteries, covers, connectors, etc affect the antenna performance. This is the reason why it is highly recommended to place 0402 pads for a PI matching network as close as possible to the antenna feeding point. Do it in the ground plane area, not in the clearance area. This is a degree of freedom to tune the antenna once the design is finished and taking into account all elements of the system (batteries, displays, covers, etc).



6. ASSEMBLY PROCESS

Figure 4 shows the back and front view of the Compact Reach Xtend chip antenna, which indicates the location of the feeding point and the mounting pad:

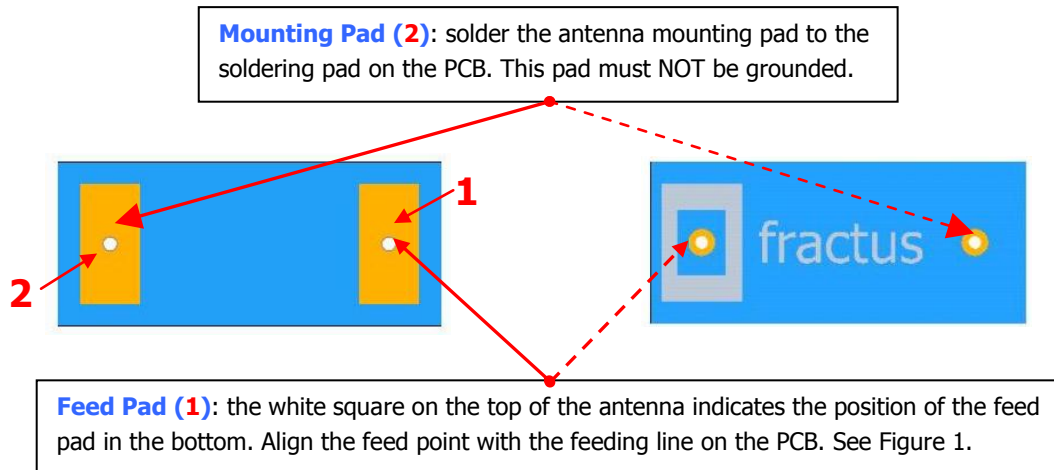

Figure 4 –Pads of the Compact Reach Xtend Chip Antenna.

As a surface mount device (SMD), this antenna is compatible with industry standard soldering processes. The basic assembly procedure for this antenna is as follows:

1. Apply a solder paste on the pads of the PCB. Place the antenna on the board.
2. Perform a reflow process according to the temperature profile detailed in table 3, figure 6 of page 10.
3. After soldering the antenna to the circuit board, perform a cleaning process to remove any residual flux. Fractus recommends conducting a visual inspection after the cleaning process to verify that all reflux has been removed.

The drawing below shows the soldering details obtained after a correct assembly process:

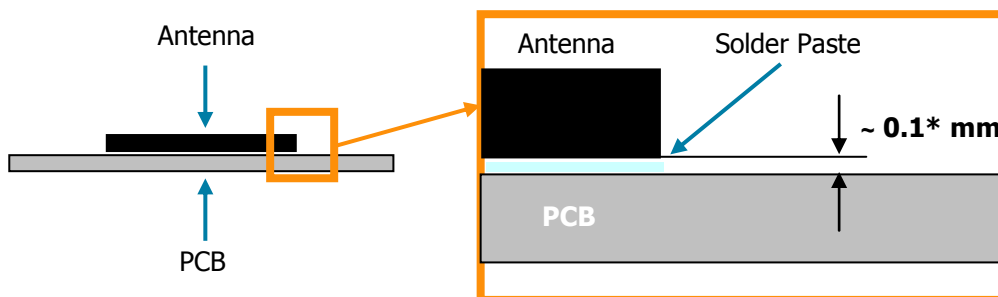

Figure 5 - Soldering Details

NOTE(*): Solder paste thickness after the assembly process will depend on the thickness of the soldering stencil mask. A stencil thickness equal or larger than **127 microns (5 mils)** is required.



Fractus Compact Reach Xtend chip antenna can be assembled following the Pb-free assembly process. According to the Standard **IPC/JEDEC J-STD-020C**, the temperature profile suggested is as follows:

| Phase | Profile features | Pb-Free Assembly (SnAgCu) |
|--|---|------------------------------------|
| RAMP-UP | Avg. Ramp-up Rate (T_{Smax} to T_p) | 3 °C / second (max.) |
| PREHEAT | <ul style="list-style-type: none"> - Temperature Min (T_{Smin}) - Temperature Max (T_{Smax}) - Time (t_{Smin} to t_{Smax}) | 150 °C 200 °C 60-180 seconds |
| REFLOW | <ul style="list-style-type: none"> - Temperature (T_L) - Total Time above T_L (t_L) | 217 °C 60-150 seconds |
| PEAK | <ul style="list-style-type: none"> - Temperature (T_p) - Time (t_p) | 260 °C 20-40 seconds |
| RAMP-DOWN | Rate | 6 °C/second max. |
| Time from 25 °C to Peak Temperature | | 8 minutes max. |

Table 3 – Recommended soldering temperatures

Next graphic shows temperature profile (grey zone) for the antenna assembly process in reflow ovens.

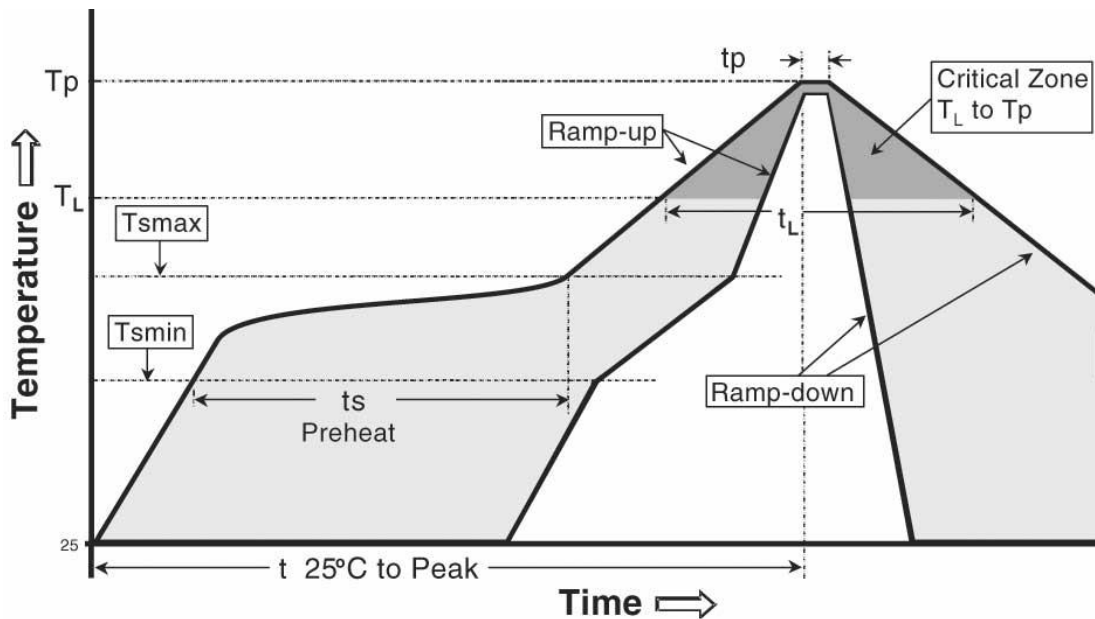

Figure 6 – Temperature profile



7. PACKAGING

The Compact Reach Xtend chip antenna is available in tape and reel packaging.

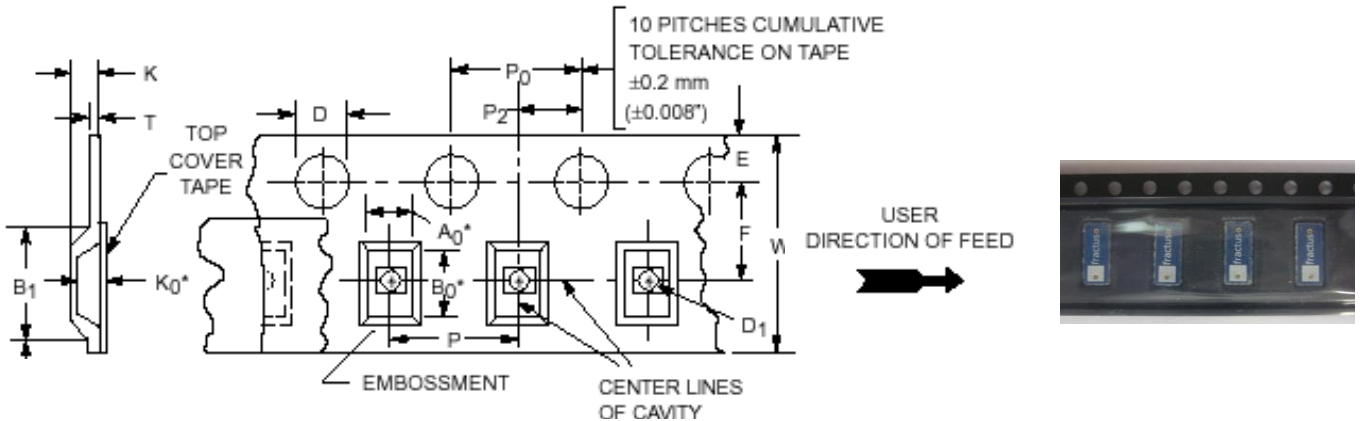
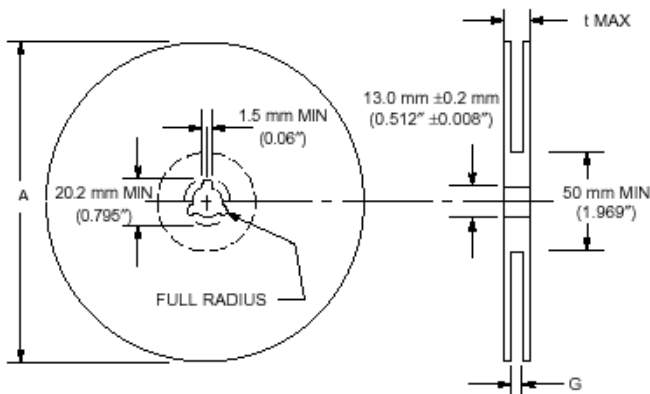
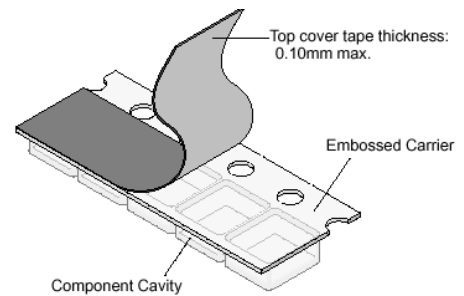

Figure 7 –Tape dimensions & real image including antennas

| Measure | mm | Measure | mm |
|-----------------------|-------------|-------------|-----------|
| TAPE WIDTH (W) | 16.0 ± 0.3 | Wmax | 16.3 |
| A0 | 3.6 ± 0.1 | E | 1.7 ± 0.1 |
| B0 | 7.5 ± 0.1 | F | 7.5 ± 0.1 |
| K0 | 2.5 ± 0.1 | K | 2.8 ± 0.1 |
| B1 | 8.1 ± 0.1 | P | 8.0 ± 0.1 |
| D | 1.55 ± 0.05 | P0 | 4.0 ± 0.1 |
| D1 | 1.55 ± 0.05 | P2 | 2.0 ± 0.1 |



| Measure | mm |
|--------------|------------|
| A | 330 ± 1 |
| G | 17.5 ± 0.2 |
| t max | 21.5 ± 0.2 |

Reel Capacity: 2500 antennas.

Figure 8 – Reel Dimensions and Capacity