



Neutron Engineering Inc.

FCC/IC Radio Test Report

FCC ID: O4GJOULE2

IC: 7666A-JOULE2

This report concerns (check one): Original Grant Class II Change

Issued Date : Nov. 01, 2011
Project No. : 1110C174
Equipment : GPS Bike Computer
Model Name : JOULE 2.0
Applicant : Dayton Industrial Co. Ltd.
Address : 2-12 Kwai Fat Road, 11-A Kwai Chung, New Territories, Hong Kong
Manufacturer : Kendy Electronics (Dongguan) Co. Ltd.
Address : Xingsi Huangtang Village, Hengli Town, Dongguan City, Guangdong Province, P.R. China

Tested by:
Neutron Engineering Inc. EMC Laboratory
Date of Receipt: Oct. 24, 2011
Date of Test:
Oct. 24, 2011 ~ Oct. 31, 2011

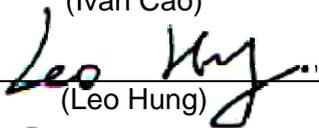
Testing Engineer : 
(Ivan Cao)
Technical Manager : 
(Leo Hung)
Authorized Signatory : 
(Steven Lu)

Neutron Engineering Inc.

**No.3, Jinshagang 1st Road, ShiXia, Dalang
Town, Dong Guan, China.
TEL : (0769) 8318-3000 FAX : (0769) 8319-6000**



Declaration

Neutron represents to the client that testing is done in accordance with standard procedures as applicable and that test instruments used has been calibrated with the standards traceable to National Measurement Laboratory (**NML**) of **R.O.C.**, or National Institute of Standards and Technology (**NIST**) of **U.S.A.**

Neutron's reports apply only to the specific samples tested under conditions. It is manufacture's responsibility to ensure that additional production units of this model are manufactured with the identical electrical and mechanical components. **Neutron** shall have no liability for any declarations, inferences or generalizations drawn by the client or others from **Neutron** issued reports.

Neutron's reports must not be used by the client to claim product endorsement by the authorities or any agency of the Government.

This report is the confidential property of the client. As a mutual protection to the clients, the public and **Neutron-self**, extracts from the test report shall not be reproduced except in full with **Neutron's** authorized written approval.

Neutron's laboratory quality assurance procedures are in compliance with the **ISO Guide 17025** requirements, and accredited by the conformity assessment authorities listed in this test report.

Limitation

For the use of the authority's logo is limited unless the Test Standard(s)/Scope(s)/Item(s) mentioned in this test report is (are) included in the conformity assessment authorities acceptance respective.



Table of Contents	Page
1 . CERTIFICATION	5
2 . SUMMARY OF TEST RESULTS	6
2.1 TEST FACILITY	7
2.2 MEASUREMENT UNCERTAINTY	7
3 . GENERAL INFORMATION	8
3.1 GENERAL DESCRIPTION OF EUT	8
3.2 DESCRIPTION OF TEST MODES	9
3.3 BLOCK DIGRAM SHOWING THE CONFIGURATION OF SYSTEM TESTED	10
3.4 DESCRIPTION OF SUPPORT UNITS	11
4 . EMC EMISSION TEST	12
4.1 CONDUCTED EMISSION MEASUREMENT	12
4.1.1 POWER LINE CONDUCTED EMISSION LIMITS	12
4.1.2 MEASUREMENT INSTRUMENTS LIST	12
4.1.3 TEST PROCEDURE	13
4.1.4 DEVIATION FROM TEST STANDARD	13
4.1.5 TEST SETUP	13
4.1.6 EUT OPERATING CONDITIONS	13
4.1.7 TEST RESULTS	14
4.2 RADIATED EMISSION MEASUREMENT	16
4.2.1 RADIATED EMISSION LIMITS	16
4.2.2 MEASUREMENT INSTRUMENTS LIST	17
4.2.3 TEST PROCEDURE	20
4.2.4 DEVIATION FROM TEST STANDARD	20
4.2.5 TEST SETUP	21
4.2.6 EUT OPERATING CONDITIONS	22
4.2.7 TEST RESULTS (BETWEEN 30 – 1000 MHz)	24
4.2.8 TEST RESULTS (ABOVE 1000 MHz)	30
4.2.9 TEST RESULTS (2400 – 2483.5 MHz)	38
5 . BANDWIDTH TEST	39
5.1 MEASUREMENT INSTRUMENTS LIST	39
5.2 TEST PROCEDURE	39
5.3 DEVIATION FROM STANDARD	39
5.4 TEST SETUP	39
5.5 EUT OPERATION CONDITIONS	39
5.6 TEST RESULTS	40
6 . ANTENNA CONDUCTED SPURIOUS EMISSION	41



Table of Contents	Page
6.1 APPLIED PROCEDURES / LIMIT	41
6.1.1 MEASUREMENT INSTRUMENTS LIST	41
6.1.2 TEST PROCEDURE	41
6.1.3 DEVIATION FROM STANDARD	41
6.1.4 TEST SETUP	41
6.1.5 EUT OPERATION CONDITIONS	41
6.1.6 TEST RESULTS	42
7 . EUT TEST PHOTO	45



1. CERTIFICATION

Equipment: GPS Bike Computer

Brand Name : N/A

Model Name. : JOULE 2.0

Applicant: Dayton Industrial Co. Ltd.

Date of Test: Oct. 24, 2011 ~ Oct. 31, 2011

Test Item: ENGINEERING SAMPLE

Standards: FCC Part15, Subpart C(15.249)/ ANSI C63.4 : 2003; Canada RSS-210:2010

The above equipment has been tested and found compliance with the requirement of the relative standards by Neutron Engineering Inc. EMC Laboratory.

The test data, data evaluation, and equipment configuration contained in our test report (Ref No. NEI-FICP-1-1110C174) were obtained utilizing the test procedures, test instruments, test sites that has been accredited by the Authority of NVLAP and TAF according to the ISO-17025 quality assessment standard and technical standard(s).



2. SUMMARY OF TEST RESULTS

Test procedures according to the technical standards:

FCC Part15, Subpart C (15.249) Canada RSS-210:2010				
StandardSection		Test Item	Judgment	Remark
FCC	RSS-210			
15.207		Conducted Emission	PASS	
15.209		Radiated Emission	PASS	
15.249	A2.9(a)	Radiated Spurious Emission	PASS	

NOTE:

(1) "N/A" denotes test is not applicable in this Test Report



2.1 TEST FACILITY

The test facilities used to collect the test data in this report is **DG-C02/DG-CB03** at the location of No.3, Jinshagang 1st Road, ShiXia, Dalang Town, Dong Guan, China.523792

Neutron's test firm number for FCC 319330

Neutron's test firm number for IC 4428B-1

2.2 MEASUREMENT UNCERTAINTY

Where relevant, the following measurement uncertainty levels have been estimated for tests performed on the EUT as specified in CISPR 16-4-2:

The reported uncertainty of measurement $y \pm U$, where expanded uncertainty U is based on a standard uncertainty multiplied by a coverage factor of $k=2$, providing a level of confidence of approximately **95 %**.

A. Conducted Measurement :

Test Site	Method	Measurement Frequency Range	U , (dB)	NOTE
DG-C02	CISPR	150 KHz ~ 30MHz	1.94	

B. Radiated Measurement :

Test Site	Method	Measurement Frequency Range	Ant. H / V	U , (dB)	NOTE
DG-CB03	CISPR	30MHz ~ 200MHz	V	2.48	
		30MHz ~ 200MHz	H	2.16	
		200MHz ~ 1,000MHz	V	2.50	
		200MHz ~ 1,000MHz	H	2.66	



3. GENERAL INFORMATION

3.1 GENERAL DESCRIPTION OF EUT

Equipment	GPS Bike Computer	
Brand Name	N/A	
Model Name.	JOULE 2.0	
OEM Brand/Model Name	N/A	
Model Difference	N/A	
Product Description	The EUT is a GPS Bike Computer.	
	Product Type	Low Power Communication Device
	Operation Frequency:	2457 MHz
	Modulation Type:	GFSK
	Date rate:	1Mbps
	Number Of Channel	1CH .Please see note 2.
	Antenna Designation:	Intergral antenna
	Antenna Gain(Peak)	0dBi
	Output Power:	39.41 dBuV/m (AV Max.)
	More details of EUT technical specification. Please refer to the User's Manual.	
Power Source	#1 DC Voltage supplied from Li-ion battery. #2 DC Voltage supplied from USB port.	
Power Rating	#1 DC 3.7V 750mAh #2 I/P AC 120V/60Hz O/P DC 5.0V	
Connecting I/O Port(s)	Please refer to the User's Manual	

Note:

1. For a more detailed features description, please refer to the manufacturer's specifications or the User's Manual.
- 2.

Channel No.	Frequency
1	2457MHz

3. Table for Filed Antenna

Ant.	Brand	Model Name	Antenna Type	Connector	Gain (dBi)
1	N/A	N/A	Intergral Antenna	N/A	0



3.2 DESCRIPTION OF TEST MODES

To investigate the maximum EMI emission characteristics generated from EUT, the test system was pre-scanning tested based on the consideration of following EUT operation mode or test configuration mode which possible have effect on EMI emission level. Each of these EUT operation mode(s) or test configuration mode(s) mentioned above was evaluated respectively.

Pretest Mode	Description
Mode 1	CH - 2457MHz
Mode 2	USB Read
Mode 3	RX Mode
Mode 4	GPS Mode

For Conducted Test	
Final Test Mode	Description
Mode 2	USB Read

For Radiated Test	
Final Test Mode	Description
Mode 1	CH - 2457MHz
Mode 3	RX Mode
Mode 4	GPS Mode

Note:

- (1) The EUT function is Transceiver.
- (2) The EUT is considered a portable unit; it was pre-tested on the positioned of each 3 axis. The worst case was found positioned on X-plane (TX Sample). Therefore only the test data of this X-plane (TX Sample) wae used for radiated emission measurement test.

3.3 BLOCK DIGRAM SHOWING THE CONFIGURATION OF SYSTEM TESTED

Conduction :

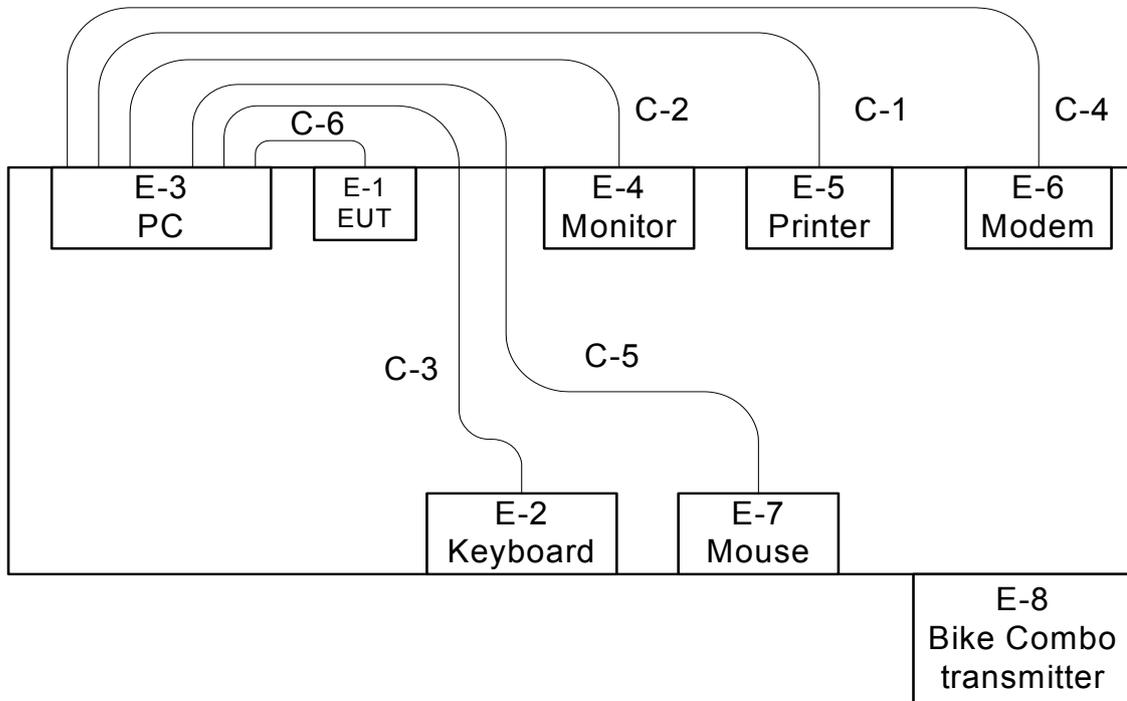

Radiation :

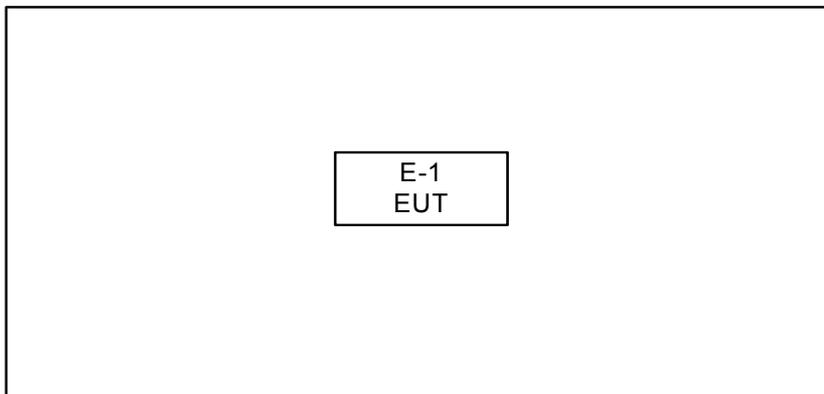

- C-1: Parallel Cable
- C-2: D-Sub Cable
- C-3: USB Cable
- C-4: RS232 Cable
- C-5: USB Cable
- C-6: USB Cable



3.4 DESCRIPTION OF SUPPORT UNITS

The EUT has been tested as an independent unit together with other necessary accessories or support units. The following support units or accessories were used to form a representative test configuration during the tests.

Item	Equipment	Mfr/Brand	Model/Type No.	FCC ID / IC ID	Series No.	Note
E-1	GPS Bike Computer	N/A	JOULE 2.0	O4GJoule2 7666A-JOULE2	N/A	EUT
E-2	USB Keyboard	Dell	L100	DOC	CNORH6596589085C00U7	
E-3	PC	Dell 745	DCSM	DOC	G7K832X	
E-4	LCD monitor	Dell	E177FPc	DOC	CNOFJ179-64180-6AG-1WNS	
E-5	Printer	SII	DPU-414	DOC	3018507 B	
E-6	Modem	ACEEX	DM-1414V	IFAXDm1414	0603002131	
E-7	USB Mouse	Dell	MO56UOA	DOC	FQJ000BS	
E-8	Bike Combo transmitter	N/A	Interchange Combo	N/A	N/A	

Item	Shielded Type	Ferrite Core	Length	Note
C-1	YES	NO	1.8M	
C-2	YES	YES	1.8M	
C-3	YES	YES	1.8M	
C-4	NO	NO	1.8M	
C-5	YES	YES	1.5M	
C-6	NO	NO	0.8M	

Note:

- (1) The support equipment was authorized by Declaration of Confirmation.
- (2) For detachable type I/O cable should be specified the length in m in 『Length』 column.



4. EMC EMISSION TEST

4.1 CONDUCTED EMISSION MEASUREMENT

4.1.1 POWER LINE CONDUCTED EMISSION LIMITS (Frequency Range 150KHz-30MHz)

FREQUENCY (MHz)	Class A (dBuV)		Class B (dBuV)		Standard
	Quasi-peak	Average	Quasi-peak	Average	
0.15 -0.5	79.00	66.00	66 - 56 *	56 - 46 *	CISPR
0.50 -5.0	73.00	60.00	56.00	46.00	CISPR
5.0 -30.0	73.00	60.00	60.00	50.00	CISPR

0.15 -0.5	79.00	66.00	66 - 56 *	56 - 46 *	FCC
0.50 -5.0	73.00	60.00	56.00	46.00	FCC
5.0 -30.0	73.00	60.00	60.00	50.00	FCC

Note:

- (1) The tighter limit applies at the band edges.
- (2) The limit of " * " marked band means the limitation decreases linearly with the logarithm of the frequency in the range.

4.1.2 MEASUREMENT INSTRUMENTS LIST

Item	Kind of Equipment	Manufacturer	Type No.	Serial No.	Calibrated until
1	LISN	EMCO	3816/2	00052765	May.26.2012
2	LISN	R&S	ENV216	100087	May.26.2012
3	Test Cable	N/A	C_17	N/A	Mar.30.2012
4	EMI TEST RECEIVER	R&S	ESCS30	826547/022	May.26.2012
5	50Ω Terminator	SHX	TF2-3G-A	08122902	May.26.2012

Remark: " N/A" denotes No Model Name. , Serial No. or No Calibration specified.

The following table is the setting of the receiver

Receiver Parameters	Setting
Attenuation	10 dB
Start Frequency	0.15 MHz
Stop Frequency	30 MHz
IF Bandwidth	9 kHz

4.1.3 TEST PROCEDURE

- a. The EUT was placed 0.8 meters from the horizontal ground plane with EUT being connected to the power mains through a line impedance stabilization network (LISN). All other support equipments powered from additional LISN(s). The LISN provide 50 Ohm/ 50uH of coupling impedance for the measuring instrument.
- b. Interconnecting cables that hang closer than 40 cm to the ground plane shall be folded back and forth in the center forming a bundle 30 to 40 cm long.
- c. I/O cables that are not connected to a peripheral shall be bundled in the center. The end of the cable may be terminated, if required, using the correct terminating impedance. The overall length shall not exceed 1 m.
- d. LISN at least 80 cm from nearest part of EUT chassis.
- e. For the actual test configuration, please refer to the related Item –EUT Test Photos.

4.1.4 DEVIATION FROM TEST STANDARD

No deviation

4.1.5 TEST SETUP

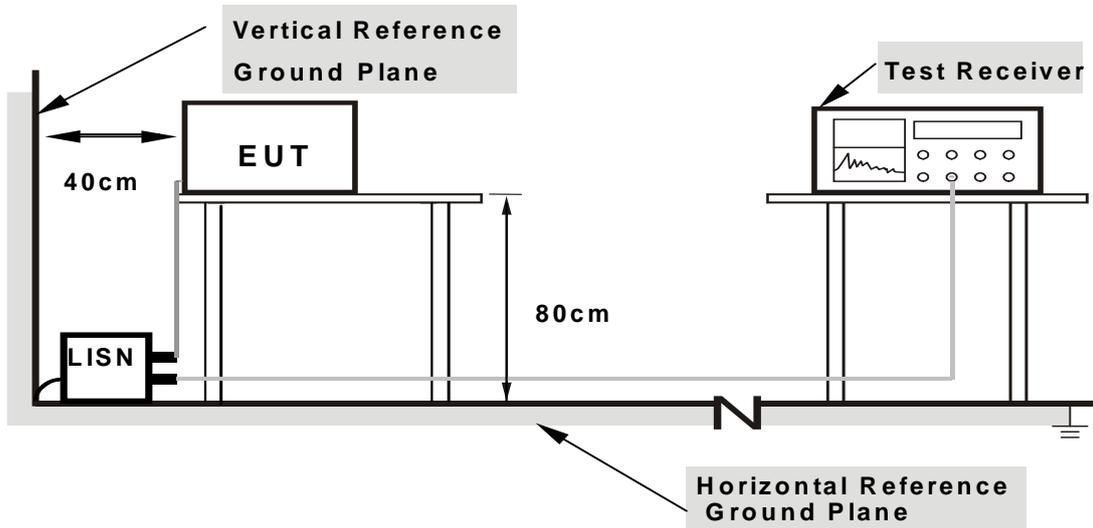

- Note: 1. Support units were connected to second LISN.**
2. Both of LISNs (AMN) are 80 cm from EUT and at least 80 cm from other units and other metal planes

4.1.6 EUT OPERATING CONDITIONS

The EUT was configured for testing in a typical fashion (as a customer would normally use it). The EUT has been programmed to continuously transmit during test. This operating condition was tested and used to collect the included data.
 The EUT was programmed to be in continuously transmitting mode.



4.1.7 TEST RESULTS

EUT :	GPS Bike Computer	Model Name. :	JOULE 2.0
Temperature :	25 °C	Relative Humidity :	58%
Pressure :	1010hPa	Test Power :	AC 120V/60Hz
Test Mode :	USB Read		

Freq. (MHz)	Terminal L/N	Measured(dBuV)		Limits(dBuV)		Margin (dB)	Note
		QP-Mode	AV-Mode	QP-Mode	AV-Mode		
0.20	Line	45.01	*	63.45	53.45	-18.44	(QP)
0.34	Line	35.19	*	59.27	49.27	-24.08	(QP)
0.54	Line	32.72	*	56.00	46.00	-23.28	(QP)
1.35	Line	34.22	*	56.00	46.00	-21.78	(QP)
2.28	Line	33.73	*	56.00	46.00	-22.27	(QP)
3.90	Line	33.36	*	56.00	46.00	-22.64	(QP)

Remark

- (1) All readings are QP Mode value unless otherwise stated AVG in column of 'Note'. If the QP Mode Measured value compliance with the QP Limits and lower than AVG Limits, the EUT shall be deemed to meet both QP & AVG Limits and then only QP Mode was measured, but AVG Mode didn't perform. In this case, a "*" marked in AVG Mode column of Interference Voltage Measured.
- (2) Measuring frequency range from 150KHz to 30MHz.

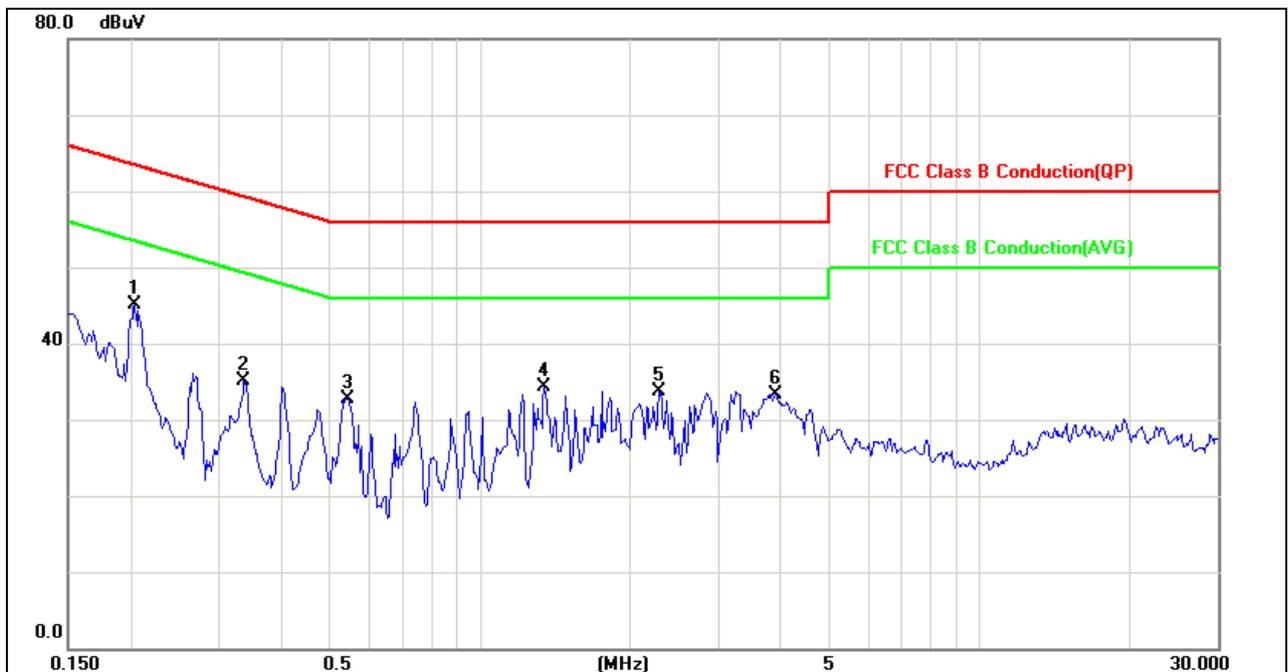



EUT :	GPS Bike Computer	Model Name. :	JOULE 2.0
Temperature :	25 °C	Relative Humidity :	58%
Pressure :	1010hPa	Test Power :	AC 120V/60Hz
Test Mode :	USB Read		

Freq. (MHz)	Terminal L/N	Measured(dBuV)		Limits(dBuV)		Margin (dB)	Note
		QP-Mode	AV-Mode	QP-Mode	AV-Mode		
0.20	Neutral	46.09	*	63.50	53.50	-17.41	(QP)
0.34	Neutral	36.03	*	59.27	49.27	-23.24	(QP)
0.67	Neutral	33.38	*	56.00	46.00	-22.62	(QP)
1.28	Neutral	34.44	*	56.00	46.00	-21.56	(QP)
2.28	Neutral	33.13	*	56.00	46.00	-22.87	(QP)
13.34	Neutral	30.78	*	60.00	50.00	-29.22	(QP)

Remark

- (1) All readings are QP Mode value unless otherwise stated AVG in column of 'Note'. If the QP Mode Measured value compliance with the QP Limits and lower than AVG Limits, the EUT shall be deemed to meet both QP & AVG Limits and then only QP Mode was measured, but AVG Mode didn't perform. In this case, a "*" marked in AVG Mode column of Interference Voltage Measured.
- (2) Measuring frequency range from 150KHz to 30MHz.

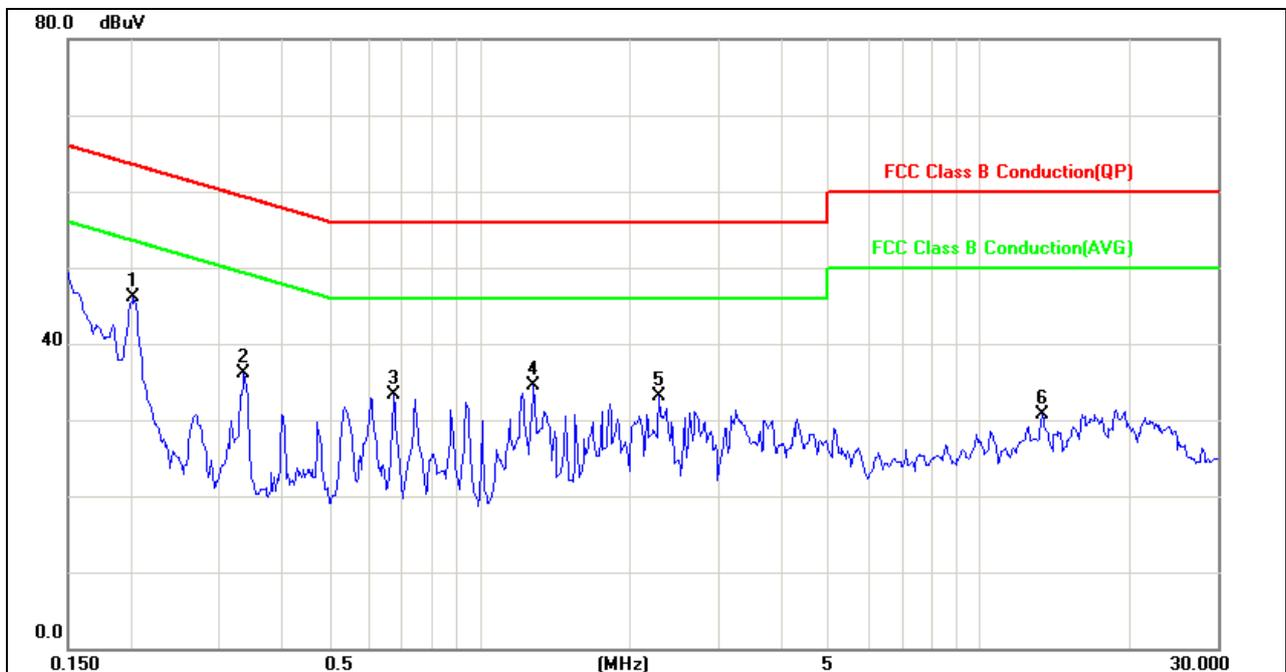



4.2 RADIATED EMISSION MEASUREMENT

4.2.1 RADIATED EMISSION LIMITS (FCC 15.209)

Frequencies (MHz)	Field Strength (micorvolts/meter)	Measurement Distance (meters)
0.009~0.490	2400/F(KHz)	300
0.490~1.705	24000/F(KHz)	30
1.705~30.0	30	30
30~88	100	3
88~216	150	3
216~960	200	3
Above 960	500	3

Harmonic emissions limits comply with below 54 dBuV/m at 3m. Other emissions radiated outside of the specified frequency bands, except for harmonics, shall be attenuated by at least 50 dB below the level of the fundamental or comply with the radiated emissions limits specified in section 15.209(a) limit in the table below has to be followed.

Note:

- (1) The tighter limit applies at the band edges.
- (2) Emission level (dBuV/m)=20log Emission level (uV/m).

LIMITS OF RADIATED EMISSION MEASUREMENT (FCC 15.209)

FREQUENCY (MHz)	(dBuV/m) (at 3m)	
	PEAK	AVERAge
Above 1000	74	54

Notes:

- (1) The limit for radiated test was performed according to FCC PART 15C.
- (2) The tighter limit applies at the band edges.
- (3) Emission level (dBuV/m)=20log Emission level (uV/m).

LIMITS OF RADIATED EMISSION MEASUREMENT (FCC Part 15.249)

FCC Part15 (15.249) , Subpart C	
Limit	Frequency Range (MHz)
Field strength of fundamental 50000 μV/m (94 dBμV/m) @ 3 m	2400-2483.5
Field strength of harmonics 500 μV/m (54 dBμV/m) @ 3 m	Above 2483.5



4.2.2 MEASUREMENT INSTRUMENTS LIST

Item	Kind of Equipment	Manufacturer	Type No.	Serial No.	Calibrated until
1	Horn Antenna	ETS	3115	00075789	May.11.2012
2	Amplifier	Agilent	8449B	3008A02274	May.25.2012
3	Spectrum	Agilent	E4408B	US39240143	Nov.15.2011
4	Test Cable	HUBER+SUHNER	CB03 High Fre	N/A	May.02.2012
5	Bi-log Antenna	Schwarbeck	VULB9160	9160-3232	May.25.2012
6	Amplifier	HP	8447D	2944A09673	May.25.2012
7	Test Receiver	R&S	ESCI	100895	May.25.2012
8	Test Cable	N/A	C-01_CB03	N/A	Jul.04.2012
9	Controller	CT	SC100	N/A	N/A
10	Triple Loop Antenna	R&S	HFH2-Z2	830749/020	May.26.2012
11	Broad-Band Horn Antenna	Schwarzbeck	BBHA 9170	9170319	May.11.2012

Remark: " N/A" denotes No Model Name. / Serial No. and No Calibration specified.

Spectrum Parameter	Setting
Attenuation	Auto
Start Frequency	1000 MHz
Stop Frequency	10th carrier harmonic
RB / VB (emission in restricted band)	1 MHz / 1 MHz for Peak, Average=PK-dycty cycle

Receiver Parameter	Setting
Attenuation	Auto
Start ~ Stop Frequency	9kHz~150kHz / RB 200Hz for QP
Start ~ Stop Frequency	150kHz~30MHz / RB 9kHz for QP
Start ~ Stop Frequency	30MHz~1000MHz / RB 120kHz for QP



DUTY CYCLE: TX 2457MHz

Dwell time=ON/ON+OFF

ON: 0.28msec

ON+OFF: (total time):98msec

Dwell time: 0.286%

AV=PK+20 log(Dwell time)

AV=PK-50.88

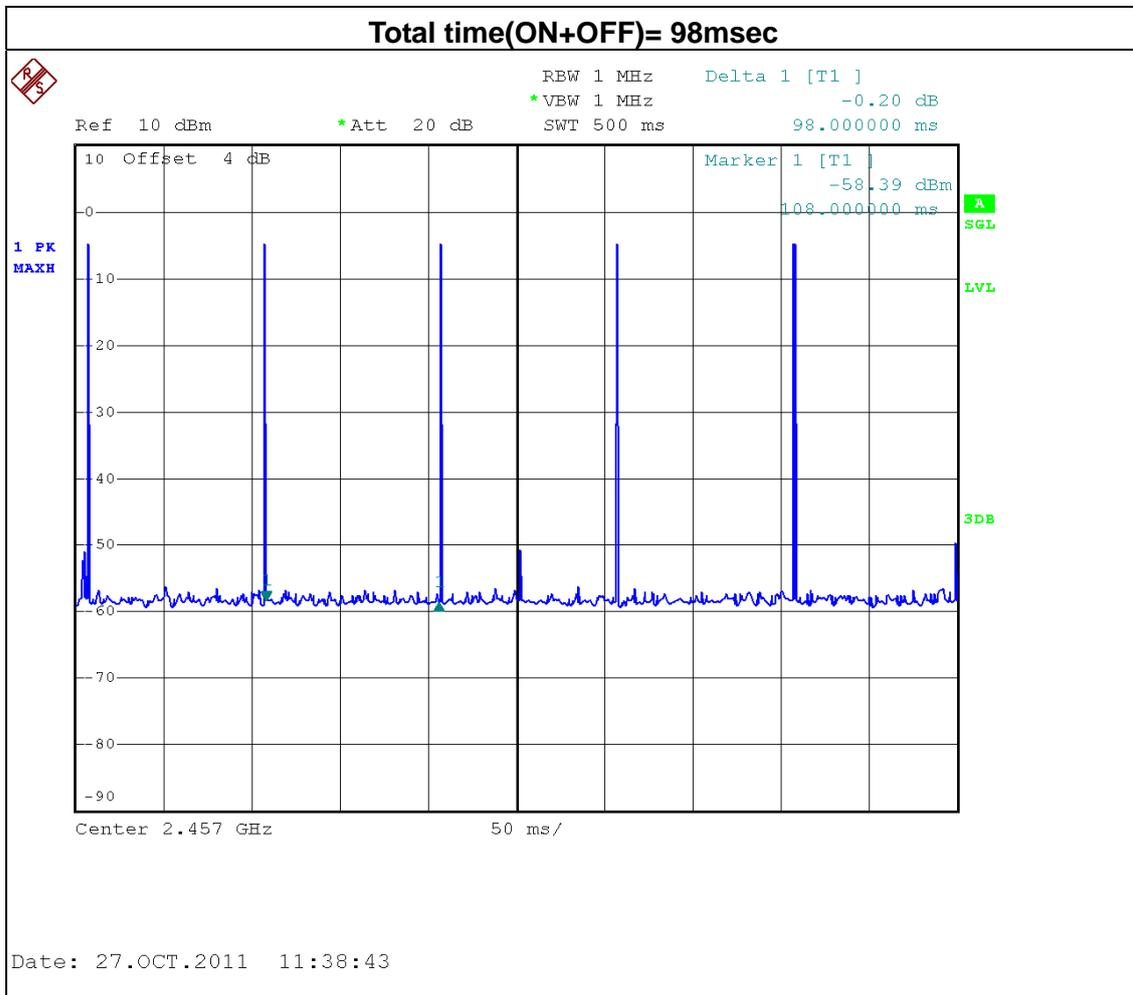

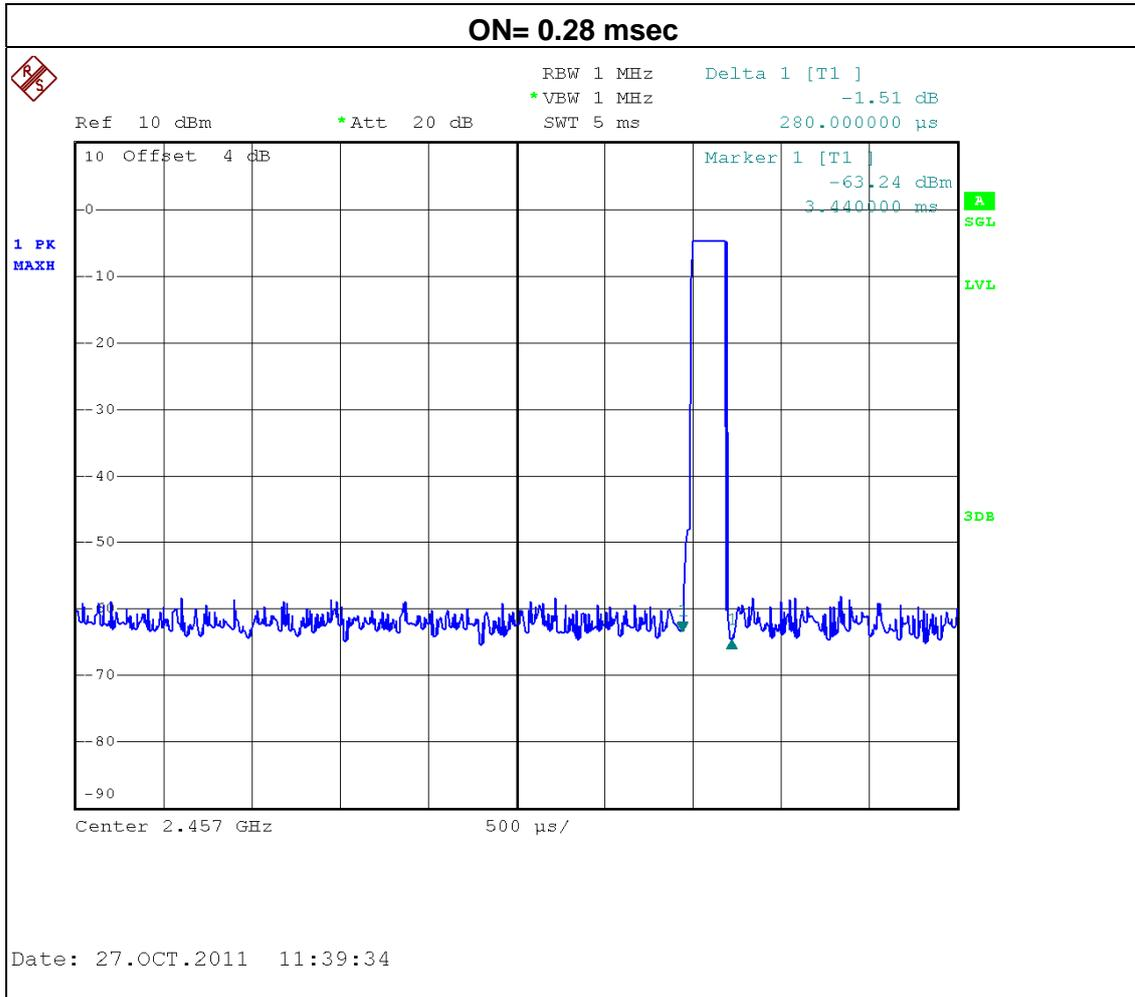



4.2.3 TEST PROCEDURE

- a. The measuring distance of at 3 m shall be used for measurements at frequency up to 1GHz. For frequencies above 1GHz, any suitable measuring distance may be used.
- b. The EUT was placed on the top of a rotating table 0.8 meters above the ground at a 3m meter semi-anechoic chamber. The table was rotated 360 degrees to determine the position of the highest radiation.
- c. The height of the equipment or of the substitution antenna shall be 0.8 m; the height of the test antenna shall vary between 1 m to 4 m. Both horizontal and vertical polarizations of the antenna are set to make the measurement.
- d. The initial step in collecting conducted emission data is a spectrum analyzer peak detector mode pre-scanning the measurement frequency range. Significant peaks are then marked and then Quasi Peak detector mode re-measured.
- e. If the Peak Mode measured value compliance with and lower than Quasi Peak Mode Limit, the EUT shall be deemed to meet QP Limits and then no additional QP Mode measurement performed.
- f. For the actual test configuration, please refer to the related Item –EUT Test Photos.

4.2.4 DEVIATION FROM TEST STANDARD

No deviation

4.2.5 TEST SETUP

(A) For radiated emissions below 30MHz

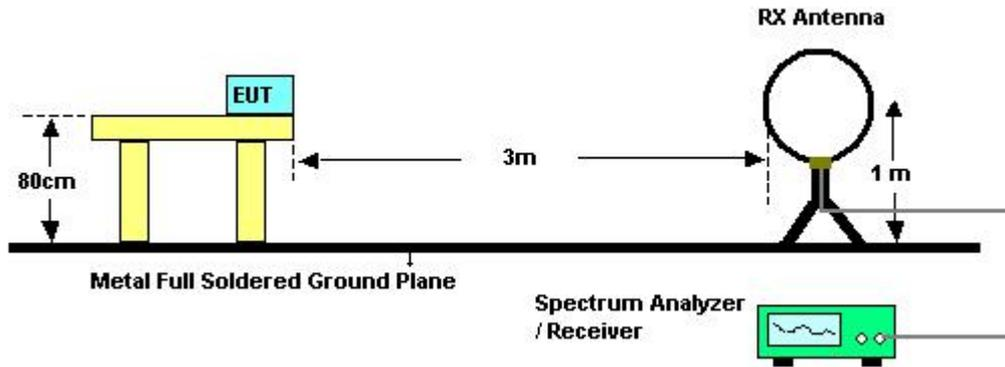

B) Radiated Emission Test Set-Up Frequency Below 1 GHz

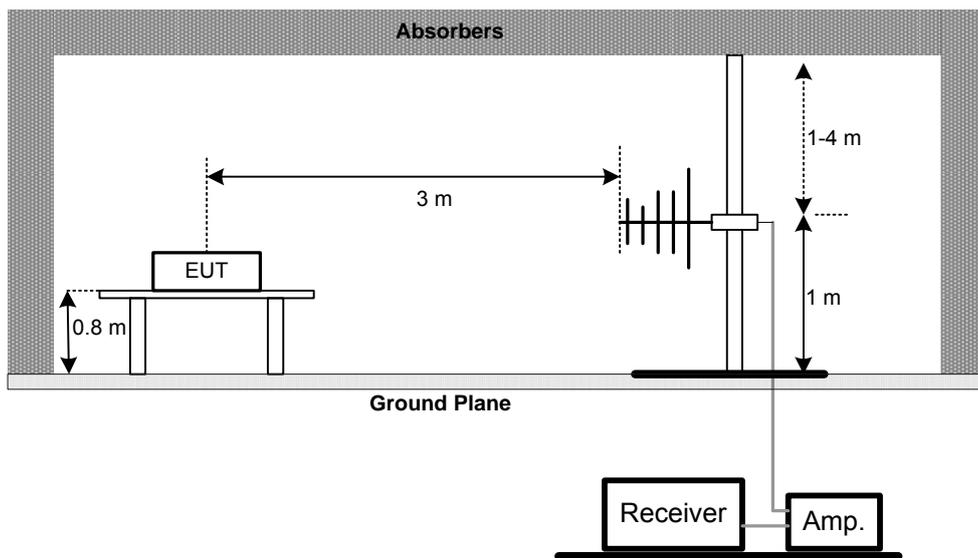

(C) Radiated Emission Test Set-Up Frequency Above 1 GHz

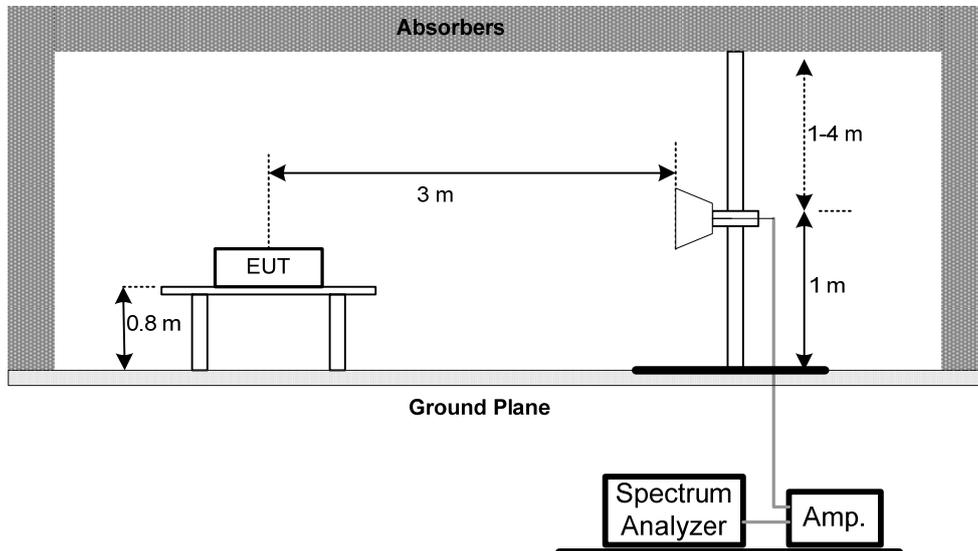

4.2.6 EUT OPERATING CONDITIONS

The EUT tested system was configured as the statements of 4.1.6 Unless otherwise a special operating condition is specified in the follows during the testing.



4.2.7 TEST RESULTS (BELOW 30MHz)

EUT :	GPS Bike Computer	Model Name. :	JOULE 2.0
Temperature :	25°C	Relative Humidity :	46 %
Pressure :	1008 hPa	Test Power :	DC 3.7V
Test Mode :	TX Mode		

Freq. (MHz)	Ant. 0°/90°	Reading(RA) (dBuV)	Corr.Factor(CF) (dB)	Measured(FS) (dBuV/m)	Limits(QP) (dBuV/m)	Margin (dB)	Note
0.04	0°	58.03	22.90	80.93	115.12	-34.19	PK
0.49	0°	27.05	19.82	46.87	73.78	-26.91	PK
1.68	0°	27.18	19.53	46.71	63.09	-16.38	PK
4.22	0°	25.33	18.82	44.15	69.54	-25.39	PK
9.22	0°	35.87	17.86	53.73	69.54	-15.81	PK
15.54	0°	42.16	18.02	60.18	69.54	-9.36	PK

Freq. (MHz)	Ant. 0°/90°	Reading(RA) (dBuV)	Corr.Factor(CF) (dB)	Measured(FS) (dBuV/m)	Limits(QP) (dBuV/m)	Margin (dB)	Note
0.29	90°	55.84	20.30	76.14	98.30	-22.16	PK
0.79	90°	37.97	20.43	58.40	69.63	-11.23	PK
3.35	90°	25.13	18.94	44.07	69.54	-25.47	PK
9.52	90°	29.08	17.84	46.92	69.54	-22.62	PK
14.47	90°	34.17	18.07	52.24	69.54	-17.30	PK
25.72	90°	41.06	16.11	57.17	69.54	-12.37	PK

Remark :

- (1) The amplitude of spurious emissions which are attenuated by more than 20 dB below the permissible value has no need to be reported ◦
- (2) Distance extrapolation factor = 40 log (specific distance / test distance) (dB); ◦
- (3) Limit line = specific limits (dBuV) + distance extrapolation factor. ◦



4.2.8 TEST RESULTS (BETWEEN 30 – 1000 MHz)

EUT :	GPS Bike Computer	Model Name. :	JOULE 2.0
Temperature :	23°C	Relative Humidity :	51 %
Pressure :	1008 hPa	Test Power :	DC 3.7V
Test Mode :	TX 2457MHz		

Freq. (MHz)	Ant. H/V	Reading(RA) (dBuV)	Corr.Factor(CF) (dB)	Measured(FS) (dBuV/m)	Limits(QP) (dBuV/m)	Margin (dB)	Note
54.25	V	41.98	-17.52	24.46	40.00	- 15.54	
110.03	V	41.13	-18.36	22.77	43.50	- 20.73	
330.70	V	35.43	-11.32	24.11	46.00	- 21.89	
461.65	V	37.47	-7.93	29.54	46.00	- 16.46	
573.20	V	33.58	-4.93	28.65	46.00	- 17.35	
820.55	V	33.80	-1.47	32.33	46.00	- 13.67	

Remark :

- (1) All readings are Peak unless otherwise stated QP in column of 『Note』 . Peak denotes that the Peak reading compliance with the QP Limits and then QP Mode measurement didn't perform ◦
- (2) Measuring frequency range from 30MHz to 1000MHz or the 10th harmonic of highest fundamental frequency ◦ “F” denotes fundamental frequency; “ H” denotes spurious frequency. “E” denotes band edge frequency.
- (3) Radiated emissions measured in frequency range from 30 MHz to 1000 MHz were made with an instrument using Peak detector mode or QP detector mode of the emission ◦
- (4) Data of measurement within this frequency range shown “ - ” in the table above means the reading of emissions are attenuated more than 20dB below the permissible limits or the field strength is too small to be measured.

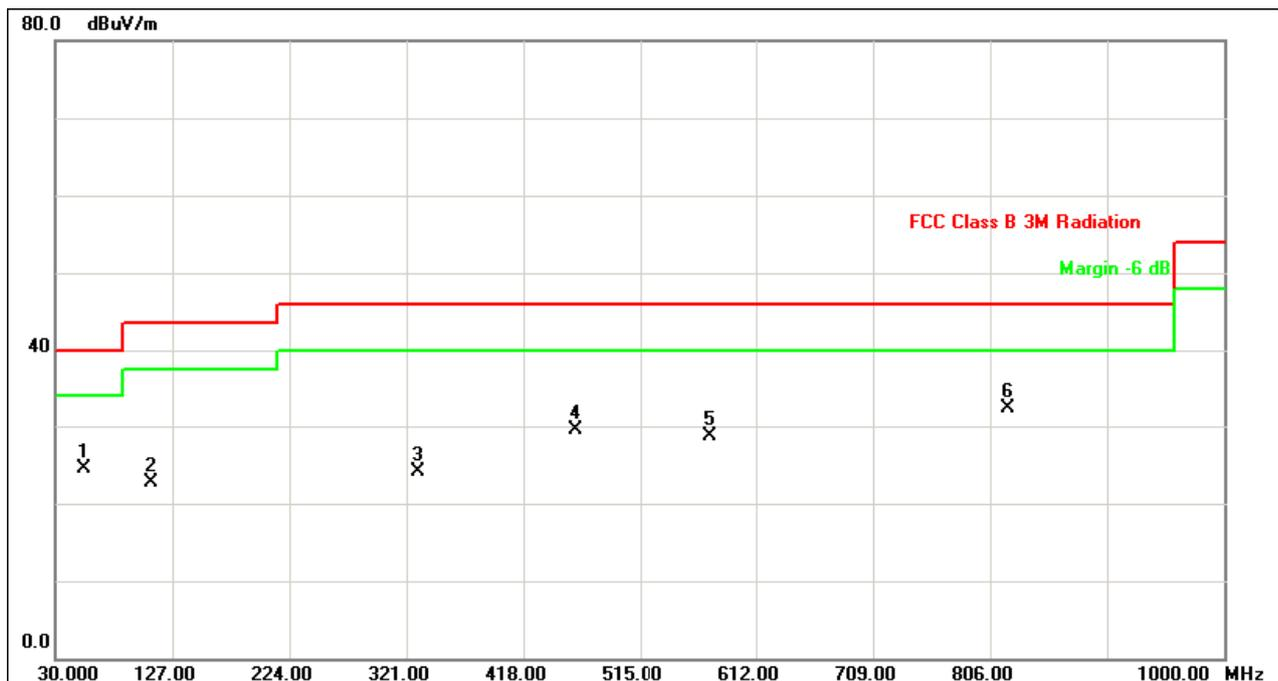



EUT :	GPS Bike Computer	Model Name. :	JOULE 2.0
Temperature :	23°C	Relative Humidity :	51 %
Pressure :	1008 hPa	Test Power :	DC 3.7V
Test Mode :	TX 2457MHz		

Freq. (MHz)	Ant. H/V	Reading(RA) (dBUV)	Corr.Factor(CF) (dB)	Measured(FS) (dBUV/m)	Limits(QP) (dBUV/m)	Margin (dB)	Note
100.33	H	39.39	-18.41	20.98	43.50	- 22.52	
224.00	H	34.79	-15.76	19.03	46.00	- 26.97	
318.58	H	33.37	-11.61	21.76	46.00	- 24.24	
449.53	H	34.92	-8.13	26.79	46.00	- 19.21	
621.70	H	35.94	-3.86	32.08	46.00	- 13.92	
798.73	H	35.11	-1.90	33.21	46.00	- 12.79	

Remark :

- (1) All readings are Peak unless otherwise stated QP in column of 『Note』 . Peak denotes that the Peak reading compliance with the QP Limits and then QP Mode measurement didn't perform ◦
- (2) Measuring frequency range from 30MHz to 1000MHz or the 10th harmonic of highest fundamental frequency ◦ “F” denotes fundamental frequency; “ H” denotes spurious frequency. “E” denotes band edge frequency.
- (3) Radiated emissions measured in frequency range from 30 MHz to 1000 MHz were made with an instrument using Peak detector mode or QP detector mode of the emission ◦
- (4) Data of measurement within this frequency range shown “ - ” in the table above means the reading of emissions are attenuated more than 20dB below the permissible limits or the field strength is too small to be measured.

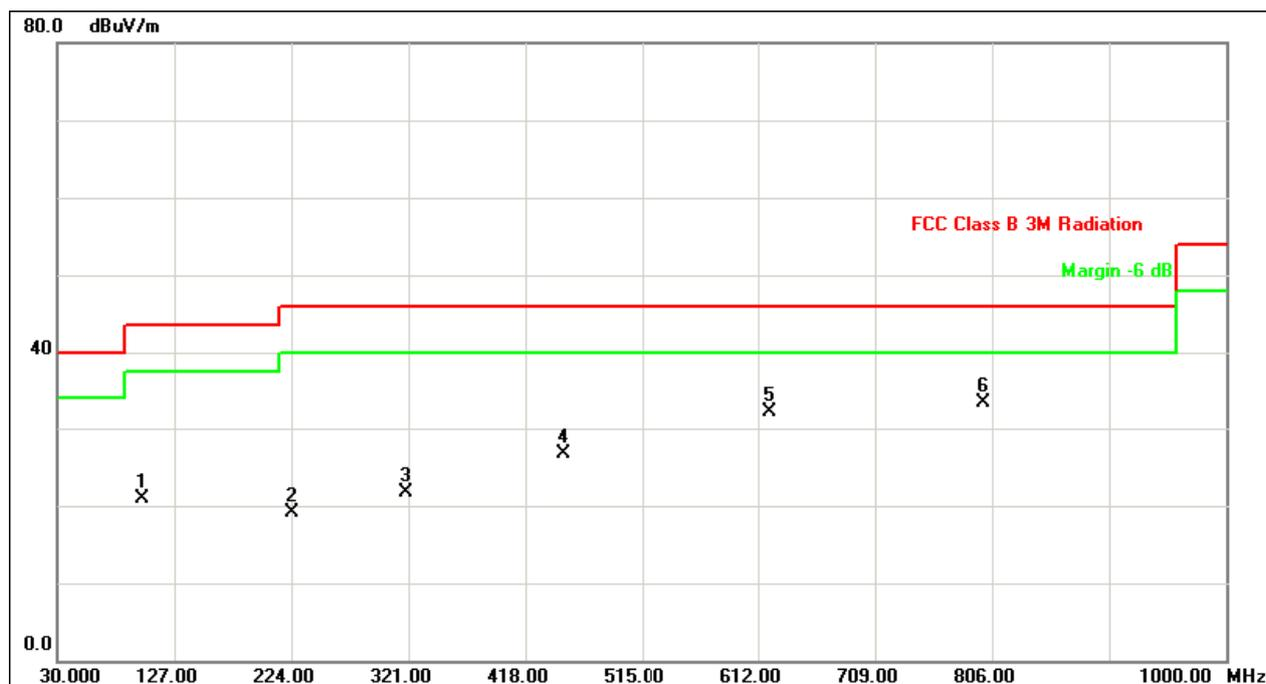



EUT :	GPS Bike Computer	Model Name. :	JOULE 2.0
Temperature :	23°C	Relative Humidity :	51 %
Pressure :	1008 hPa	Test Power :	DC 3.7V
Test Mode :	RX Mode		

Freq. (MHz)	Ant. H/V	Reading(RA) (dBuV)	Corr.Factor(CF) (dB)	Measured(FS) (dBuV/m)	Limits(QP) (dBuV/m)	Margin (dB)	Note
61.53	V	43.03	-17.51	25.52	40.00	- 14.48	
110.03	V	40.13	-18.36	21.77	43.50	- 21.73	
342.83	V	36.36	-11.01	25.35	46.00	- 20.65	
502.88	V	36.14	-7.25	28.89	46.00	- 17.11	
597.45	V	34.10	-4.33	29.77	46.00	- 16.23	
658.08	V	34.67	-3.30	31.37	46.00	- 14.63	

Remark :

- (1) All readings are Peak unless otherwise stated QP in column of 『Note』 . Peak denotes that the Peak reading compliance with the QP Limits and then QP Mode measurement didn't perform ◦
- (2) Measuring frequency range from 30MHz to 1000MHz or the 10th harmonic of highest fundamental frequency ◦ “F” denotes fundamental frequency; “ H” denotes spurious frequency. “E” denotes band edge frequency.
- (3) Radiated emissions measured in frequency range from 30 MHz to 1000 MHz were made with an instrument using Peak detector mode or QP detector mode of the emission ◦
- (4) Data of measurement within this frequency range shown “ - ” in the table above means the reading of emissions are attenuated more than 20dB below the permissible limits or the field strength is too small to be measured.

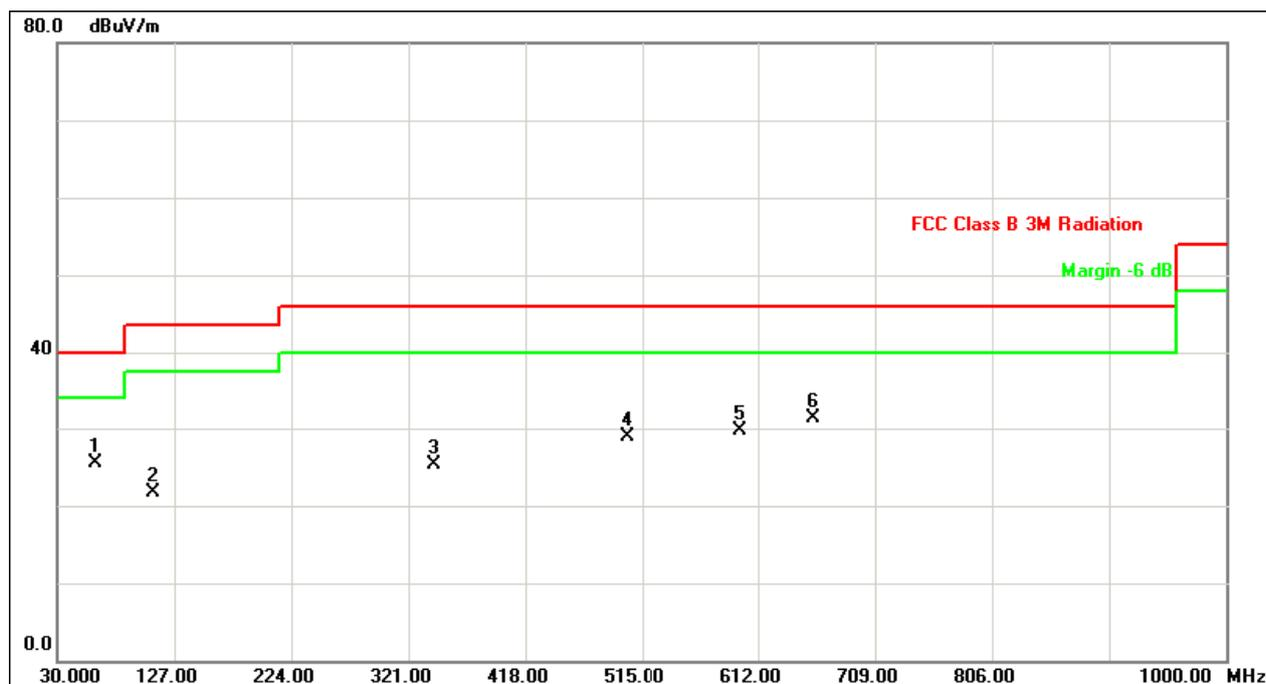



EUT :	GPS Bike Computer	Model Name. :	JOULE 2.0
Temperature :	23°C	Relative Humidity :	51 %
Pressure :	1008 hPa	Test Power :	DC 3.7V
Test Mode :	RX Mode		

Freq. (MHz)	Ant. H/V	Reading(RA) (dBuV)	Corr.Factor(CF) (dB)	Measured(FS) (dBuV/m)	Limits(QP) (dBuV/m)	Margin (dB)	Note
100.33	H	39.89	-18.41	21.48	43.50	- 22.02	
257.95	H	37.98	-14.00	23.98	46.00	- 22.02	
430.13	H	34.76	-8.48	26.28	46.00	- 19.72	
531.98	H	33.21	-6.16	27.05	46.00	- 18.95	
573.20	H	34.95	-4.93	30.02	46.00	- 15.98	
626.55	H	33.69	-3.77	29.92	46.00	- 16.08	

Remark :

- (1) All readings are Peak unless otherwise stated QP in column of 『Note』 . Peak denotes that the Peak reading compliance with the QP Limits and then QP Mode measurement didn't perform ◦
- (2) Measuring frequency range from 30MHz to 1000MHz or the 10th harmonic of highest fundamental frequency ◦ “F” denotes fundamental frequency; “ H” denotes spurious frequency. “E” denotes band edge frequency.
- (3) Radiated emissions measured in frequency range from 30 MHz to 1000 MHz were made with an instrument using Peak detector mode or QP detector mode of the emission ◦
- (4) Data of measurement within this frequency range shown “ - ” in the table above means the reading of emissions are attenuated more than 20dB below the permissible limits or the field strength is too small to be measured.

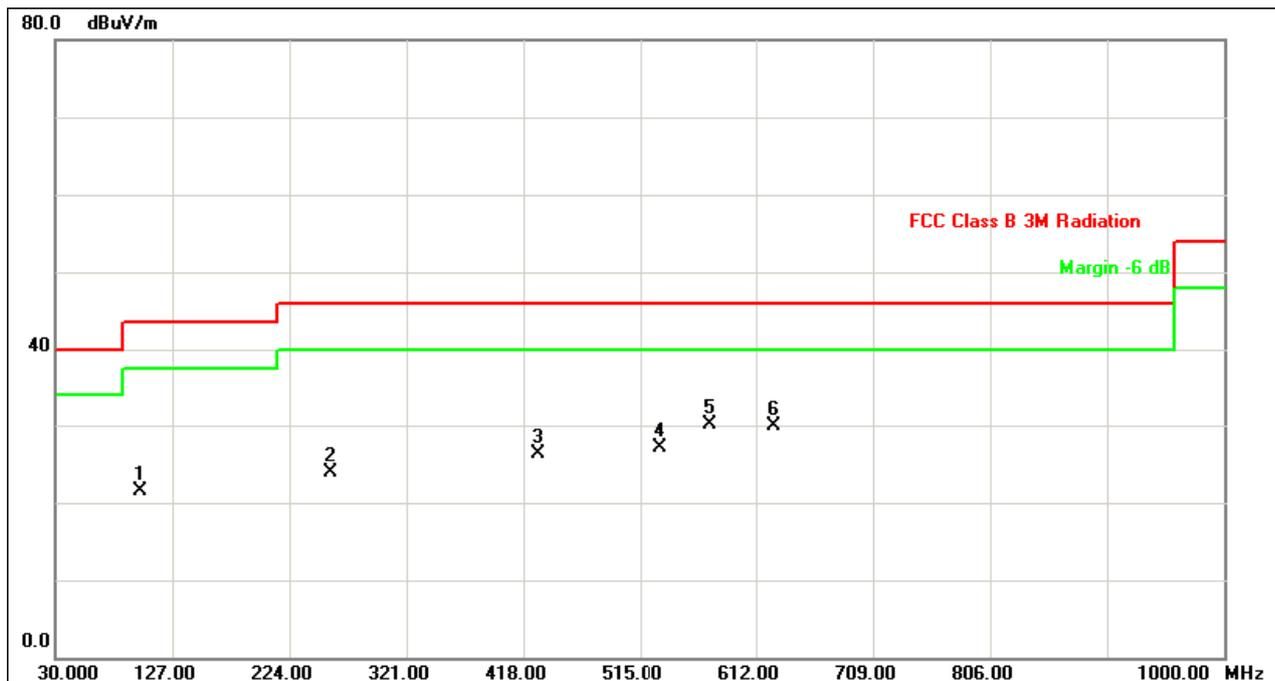



EUT :	GPS Bike Computer	Model Name. :	JOULE 2.0
Temperature :	23°C	Relative Humidity :	51 %
Pressure :	1008 hPa	Test Power :	DC 3.7V
Test Mode :	GPS Mode		

Freq. (MHz)	Ant. H/V	Reading(RA) (dBuV)	Corr.Factor(CF) (dB)	Measured(FS) (dBuV/m)	Limits(QP) (dBuV/m)	Margin (dB)	Note
63.95	V	39.00	-17.58	21.42	40.00	- 18.58	
185.20	V	36.56	-16.81	19.75	43.50	- 23.75	
296.75	V	32.33	-12.07	20.26	46.00	- 25.74	
396.18	V	32.96	-9.16	23.80	46.00	- 22.20	
524.70	V	31.81	-6.44	25.37	46.00	- 20.63	
628.98	V	32.04	-3.73	28.31	46.00	- 17.69	

Remark :

- (1) All readings are Peak unless otherwise stated QP in column of 『Note』 . Peak denotes that the Peak reading compliance with the QP Limits and then QP Mode measurement didn't perform ◦
- (2) Measuring frequency range from 30MHz to 1000MHz or the 10th harmonic of highest fundamental frequency ◦ “F” denotes fundamental frequency; “ H” denotes spurious frequency. “E” denotes band edge frequency.
- (3) Radiated emissions measured in frequency range from 30 MHz to 1000 MHz were made with an instrument using Peak detector mode or QP detector mode of the emission ◦
- (4) Data of measurement within this frequency range shown “ - ” in the table above means the reading of emissions are attenuated more than 20dB below the permissible limits or the field strength is too small to be measured.

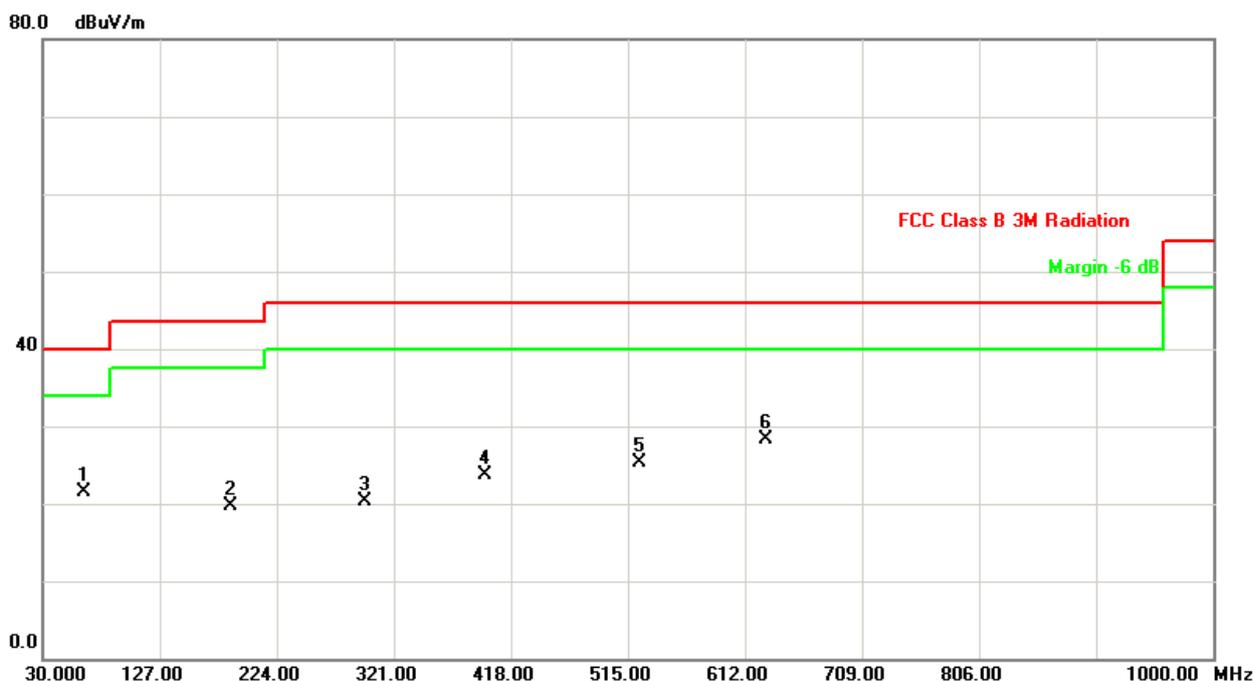



EUT :	GPS Bike Computer	Model Name. :	JOULE 2.0
Temperature :	23°C	Relative Humidity :	51 %
Pressure :	1008 hPa	Test Power :	DC 3.7V
Test Mode :	GPS Mode		

Freq. (MHz)	Ant. H/V	Reading(RA) (dBuV)	Corr.Factor(CF) (dB)	Measured(FS) (dBuV/m)	Limits(QP) (dBuV/m)	Margin (dB)	Note
66.38	H	35.49	-17.81	17.68	40.00	- 22.32	
134.28	H	34.31	-17.95	16.36	43.50	- 27.14	
238.55	H	34.11	-15.23	18.88	46.00	- 27.12	
342.83	H	32.08	-11.01	21.07	46.00	- 24.93	
449.53	H	32.92	-8.13	24.79	46.00	- 21.21	
582.90	H	32.26	-4.69	27.57	46.00	- 18.43	

Remark :

- (1) All readings are Peak unless otherwise stated QP in column of 『Note』 . Peak denotes that the Peak reading compliance with the QP Limits and then QP Mode measurement didn't perform ◦
- (2) Measuring frequency range from 30MHz to 1000MHz or the 10th harmonic of highest fundamental frequency ◦ “F” denotes fundamental frequency; “ H” denotes spurious frequency. “E” denotes band edge frequency.
- (3) Radiated emissions measured in frequency range from 30 MHz to 1000 MHz were made with an instrument using Peak detector mode or QP detector mode of the emission ◦
- (4) Data of measurement within this frequency range shown “ - ” in the table above means the reading of emissions are attenuated more than 20dB below the permissible limits or the field strength is too small to be measured.

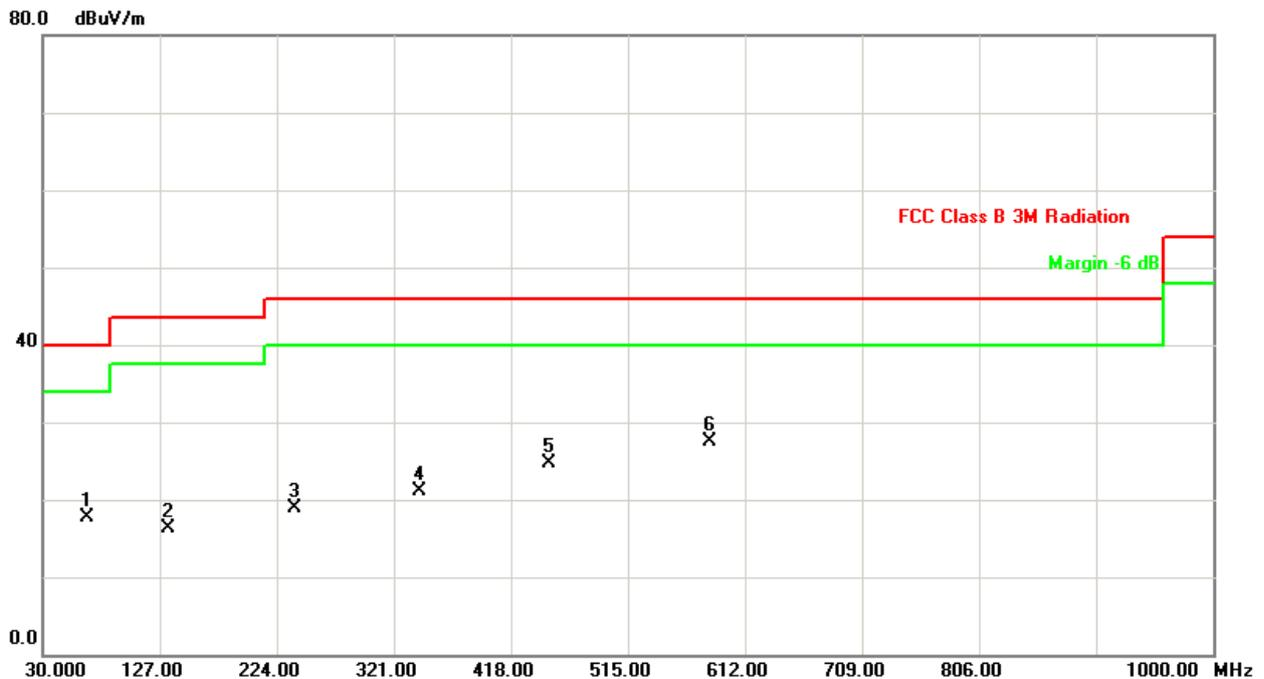



4.2.9 TEST RESULTS (ABOVE 1000 MHz)

EUT :	GPS Bike Computer	Model Name. :	JOULE 2.0
Temperature :	25°C	Relative Humidity :	58 %
Pressure :	1008 hPa	Test Power :	DC 3.7V
Test Mode :	TX 2457MHz		

Freq. (MHz)	Ant.Pol. H/V	Reading		Ant./CF CF (dB)	Act.		Limit		Note
		Peak (dBuV)	AV (dBuV)		Peak (dBuV/m)	AV (dBuV/m)	Peak (dBuV/m)	AV (dBuV/m)	
2456.75	V	58.45	7.57	31.84	90.29	39.41	114.00	94.00	X/F
2483.50	V	24.02	-26.18	31.80	55.82	5.62	74.00	54.00	X/E
4914.63	V	43.59	-7.29	5.62	49.21	-1.67	74.00	54.00	X/H

Remark :

- (1) All readings are Peak unless otherwise stated QP in column of 『Note』 . Peak denotes that the Peak reading compliance with the QP Limits and then QP Mode measurement didn't perform ◦
- (2) Measuring frequency range from 30MHz to 1000MHz or the 10th harmonic of highest fundamental frequency ◦ "F" denotes fundamental frequency; "H" denotes spurious frequency. "E" denotes band edge frequency. (This judgment method includes the Band Edge Requirement.)
- (3) Radiated emissions measured in frequency range above 1000MHz were made with an instrument using Peak detector mode and AV detector mode of the emission ◦
- (4) Data of measurement within this frequency range shown " * " in the table above means the reading of emissions are attenuated more than 20dB below the permissible limits or the field strength is too small to be measured.
- (5) A preamp and high pass filter were used for this test in order to provide sufficient measurement sensitivity.
- (6) EUT Orthogonal Axis :
"X" - denotes Laid on Table ; "Y" - denotes Vertical Stand ; "Z" - denotes Side Stand
- (7) During the measurements above 1 GHz it is taken care of that the EUT is always within the 3 dB cone of radiation BW of the used antenna
- (8) The average value of fundamental frequency is:
Average = Peak value + 20log(Duty cycle) ◦ Final AV=PK-50.88



Orthogonal Axis : X
TX 2457MHz (Above 1000 MHz, Vertical)

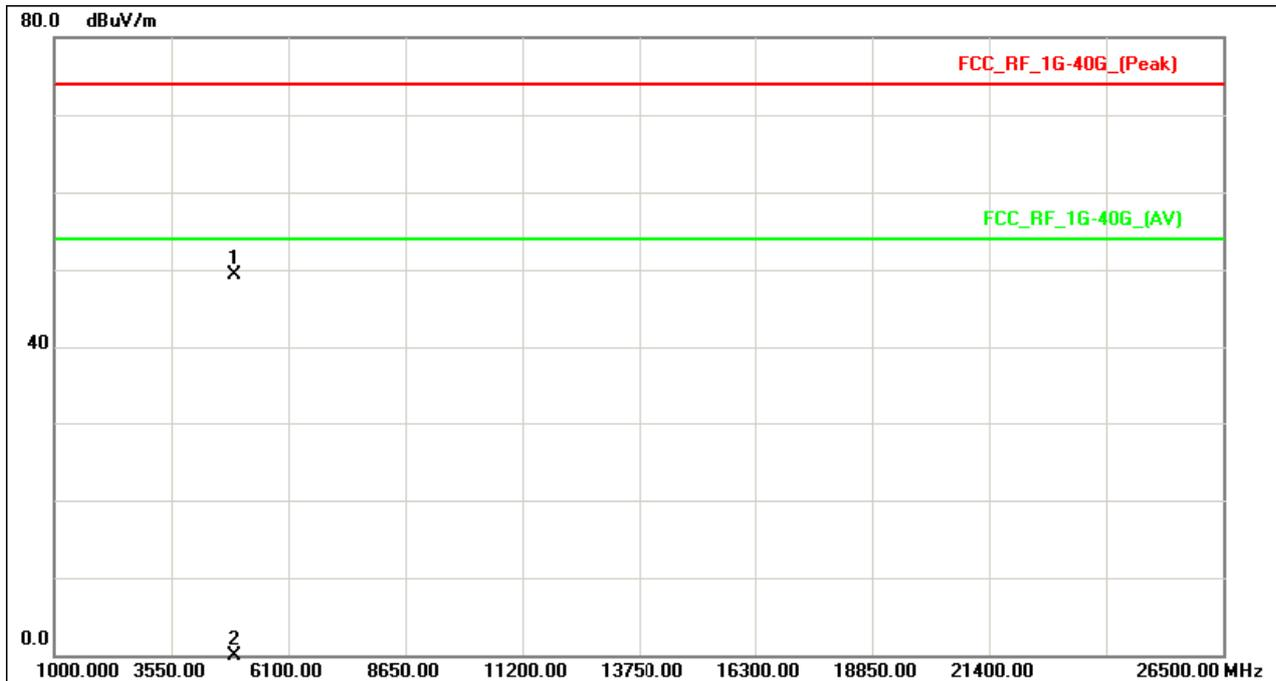
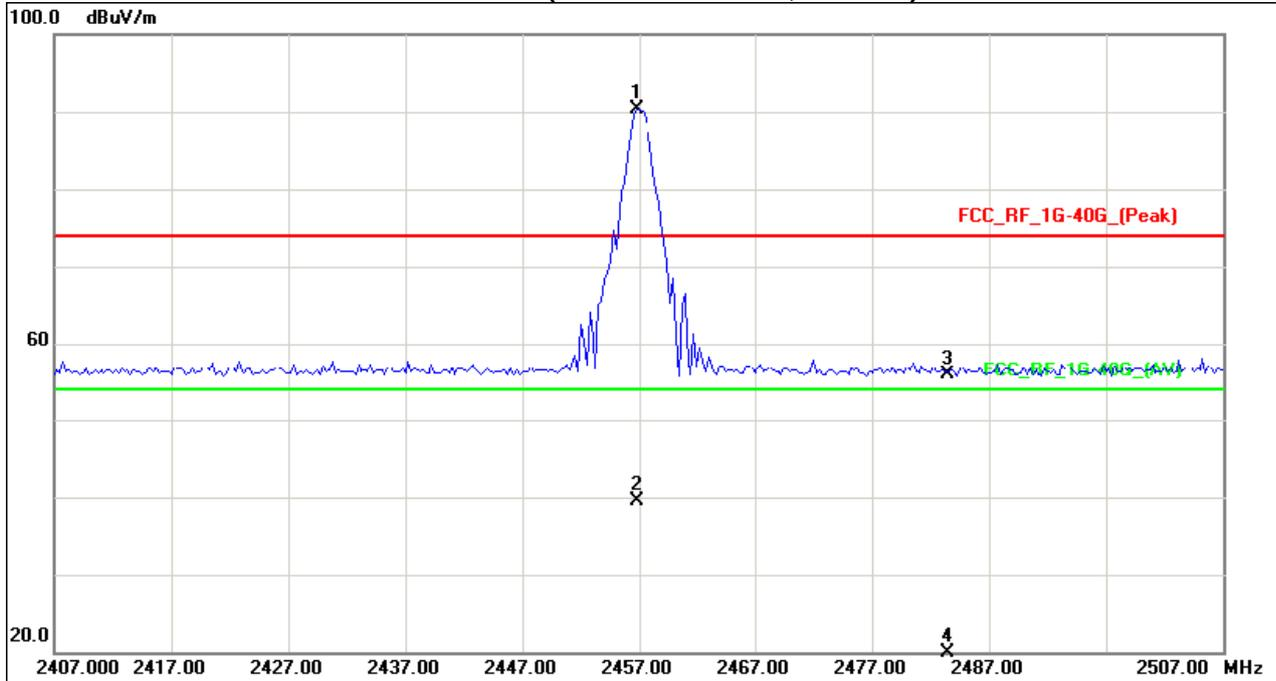



EUT :	GPS Bike Computer	Model Name. :	JOULE 2.0
Temperature :	25°C	Relative Humidity :	58 %
Pressure :	1008 hPa	Test Power :	DC 3.7V
Test Mode :	TX 2457MHz		

Freq. (MHz)	Ant.Pol. H/V	Reading		Ant./CF CF(dB)	Act.		Limit		Note
		Peak (dBuV)	AV (dBuV)		Peak (dBuV/m)	AV (dBuV/m)	Peak (dBuV/m)	AV (dBuV/m)	
2456.75	H	57.95	7.07	31.84	89.79	38.91	114.00	94.00	X/F
2483.50	H	24.48	-26.84	31.80	56.28	4.96	74.00	54.00	X/E
4913.93	H	42.30	-7.52	5.61	47.91	-1.91	74.00	54.00	X/H

Remark :

- (1) All readings are Peak unless otherwise stated QP in column of 『Note』 . Peak denotes that the Peak reading compliance with the QP Limits and then QP Mode measurement didn't perform ◦
- (2) Measuring frequency range from 30MHz to 1000MHz or the 10th harmonic of highest fundamental frequency ◦ "F" denotes fundamental frequency; "H" denotes spurious frequency. "E" denotes band edge frequency. (This judgment method includes the Band Edge Requirement.)
- (3) Radiated emissions measured in frequency range above 1000MHz were made with an instrument using Peak detector mode and AV detector mode of the emission ◦
- (4) Data of measurement within this frequency range shown " * " in the table above means the reading of emissions are attenuated more than 20dB below the permissible limits or the field strength is too small to be measured.
- (5) A preamp and high pass filter were used for this test in order to provide sufficient measurement sensitivity.
- (6) EUT Orthogonal Axis :
"X" - denotes Laid on Table ; "Y" - denotes Vertical Stand ; "Z" - denotes Side Stand
- (7) During the measurements above 1 GHz it is taken care of that the EUT is always within the 3 dB cone of radiation BW of the used antenna
- (8) The average value of fundamental frequency is:
Average = Peak value + 20log(Duty cycle) ◦ Final AV=PK-50.88



Orthogonal Axis : X
TX 2457MHz (Above 1000 MHz, Horizontal)

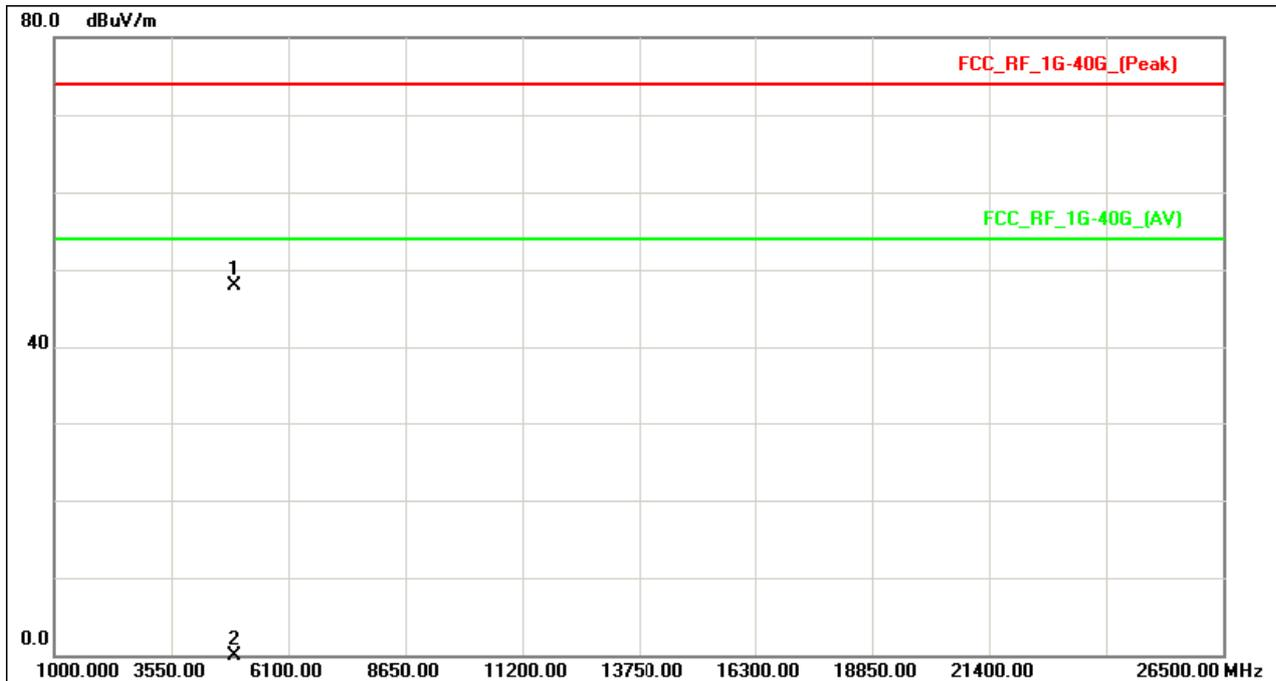
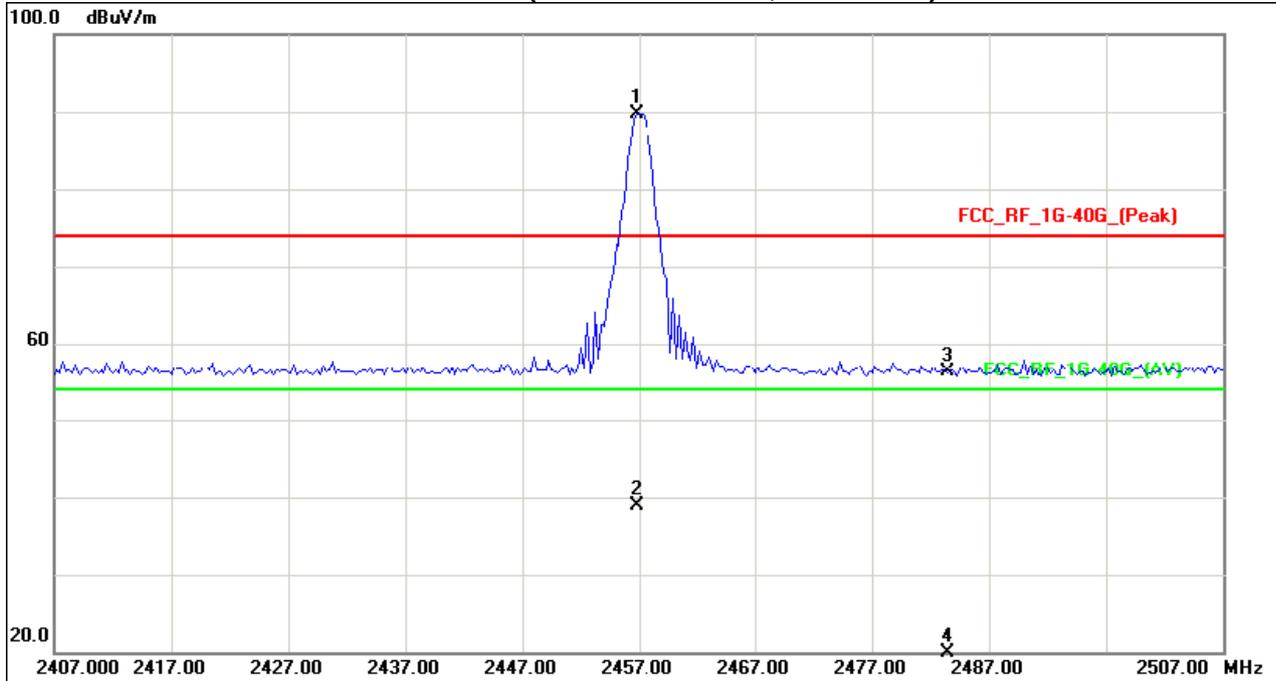



EUT :	GPS Bike Computer	Model Name. :	JOULE 2.0
Temperature :	25°C	Relative Humidity :	58 %
Pressure :	1009 hPa	Test Power :	DC 3.7V
Test Mode :	RX Mode		

Freq. (MHz)	Ant.Pol. H/V	Reading		Ant./CF CF(dB)	Act.		Limit		Note
		Peak (dBuV)	AV (dBuV)		Peak (dBuV/m)	AV (dBuV/m)	Peak (dBuV/m)	AV (dBuV/m)	
2451.36	V	51.36	42.05	-1.57	49.79	40.48	74.00	54.00	X/E

Remark :

- (1) All readings are Peak unless otherwise stated QP in column of 『Note』 . Peak denotes that the Peak reading compliance with the QP Limits and then QP Mode measurement didn't perform ◦
- (2) Measuring frequency range from 1000MHz to 6000MHz or the 10th harmonic of highest fundamental frequency ◦ "F" denotes fundamental frequency; "H" denotes spurious frequency. "E" denotes band edge frequency. (This judgment method includes the Band Edge Requirement.)
- (3) Radiated emissions measured in frequency range above 1000MHz were made with an instrument using Peak detector mode and AV detector mode of the emission ◦
- (4) Data of measurement within this frequency range shown " * " in the table above means the reading of emissions are attenuated more than 20dB below the permissible limits or the field strength is too small to be measured.
- (5) A preamp and high pass filter were used for this test in order to provide sufficient measurement sensitivity.
- (6) EUT Orthogonal Axis :
 "X" - denotes Laid on Table ; "Y" - denotes Vertical Stand ; "Z" - denotes Side Stand

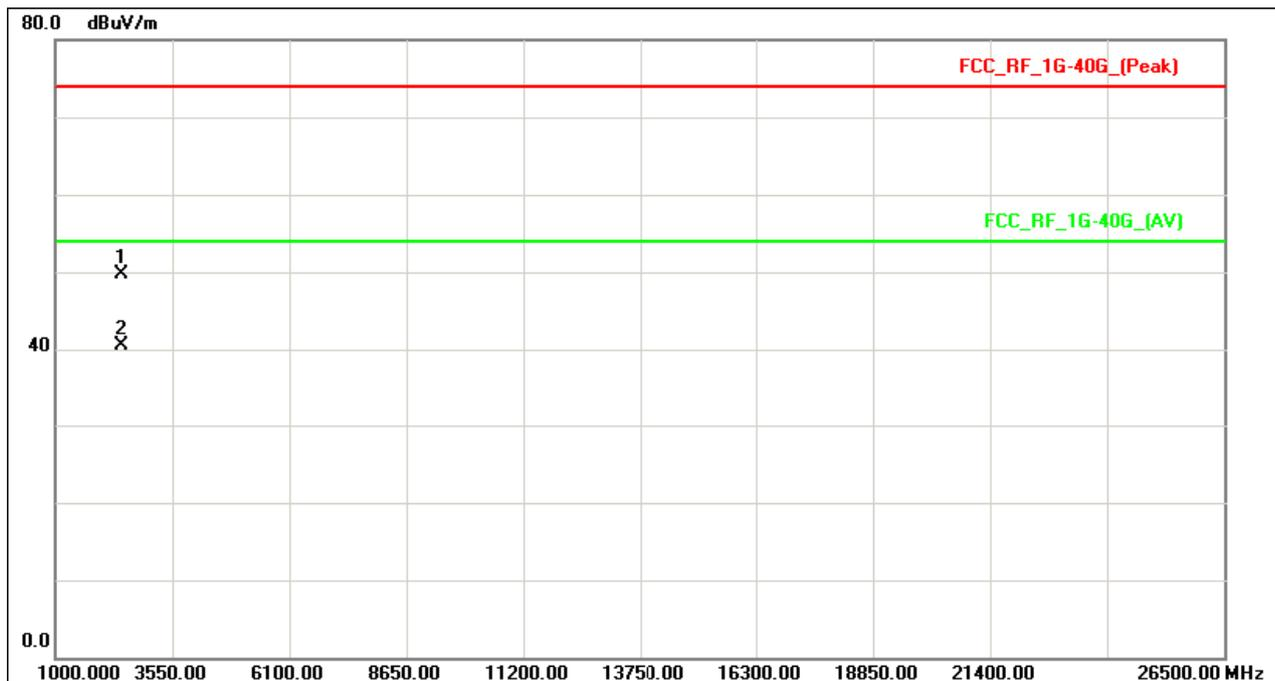



EUT :	GPS Bike Computer	Model Name. :	JOULE 2.0
Temperature :	25°C	Relative Humidity :	58 %
Pressure :	1009 hPa	Test Power :	DC 3.7V
Test Mode :	RX Mode		

Freq. (MHz)	Ant.Pol. H/V	Reading		Ant./CF CF(dB)	Act.		Limit		Note
		Peak (dBuV)	AV (dBuV)		Peak (dBuV/m)	AV (dBuV/m)	Peak (dBuV/m)	AV (dBuV/m)	
2451.36	H	52.36	41.99	-1.57	50.79	40.42	74.00	54.00	X/E

Remark :

- (1) All readings are Peak unless otherwise stated QP in column of 『Note』 . Peak denotes that the Peak reading compliance with the QP Limits and then QP Mode measurement didn't perform ◦
- (2) Measuring frequency range from 1000MHz to 6000MHz or the 10th harmonic of highest fundamental frequency ◦ "F" denotes fundamental frequency; "H" denotes spurious frequency. "E" denotes band edge frequency. (This judgment method includes the Band Edge Requirement.)
- (3) Radiated emissions measured in frequency range above 1000MHz were made with an instrument using Peak detector mode and AV detector mode of the emission ◦
- (4) Data of measurement within this frequency range shown " * " in the table above means the reading of emissions are attenuated more than 20dB below the permissible limits or the field strength is too small to be measured.
- (5) A preamp and high pass filter were used for this test in order to provide sufficient measurement sensitivity.
- (6) EUT Orthogonal Axis :
 "X" - denotes Laid on Table ; "Y" - denotes Vertical Stand ; "Z" - denotes Side Stand

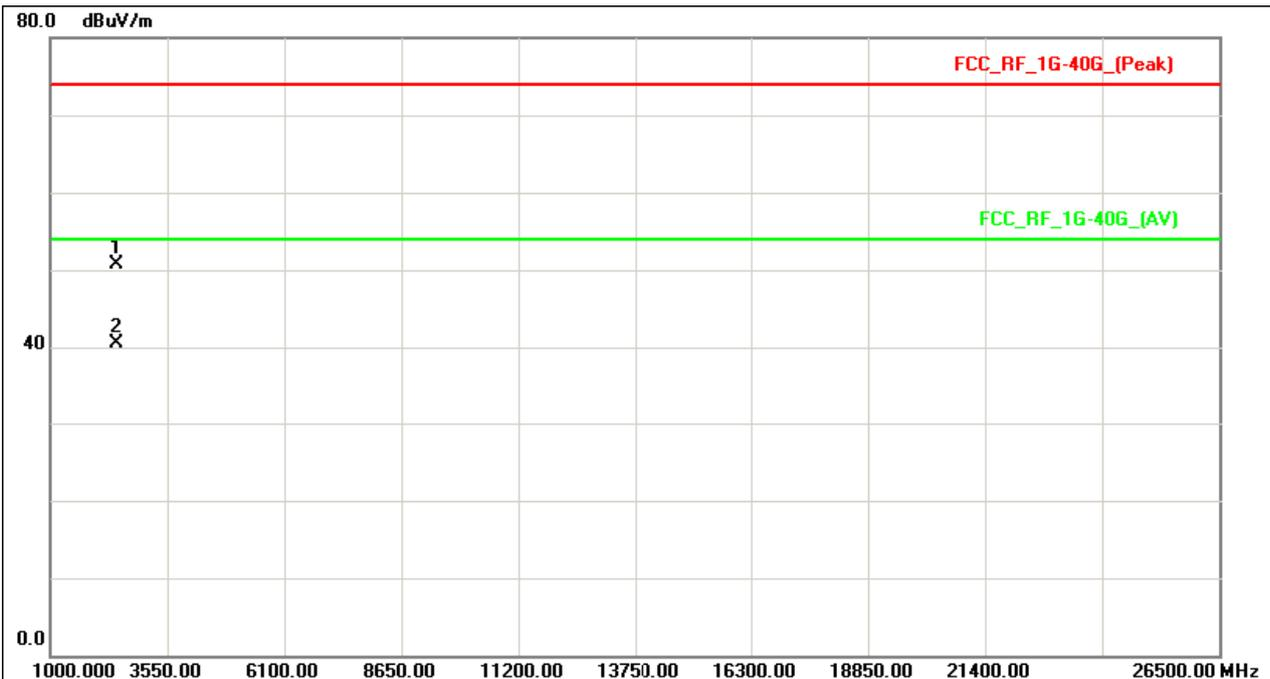



EUT :	GPS Bike Computer	Model Name. :	JOULE 2.0
Temperature :	25°C	Relative Humidity :	58 %
Pressure :	1009 hPa	Test Power :	DC 3.7V
Test Mode :	GPS Mode		

Freq. (MHz)	Ant.Pol. H/V	Reading		Ant./CF CF(dB)	Act.		Limit		Note
		Peak (dBuV)	AV (dBuV)		Peak (dBuV/m)	AV (dBuV/m)	Peak (dBuV/m)	AV (dBuV/m)	
2450.37	V	53.51	40.62	-1.57	51.94	39.05	74.00	54.00	X/E

Remark :

- (1) All readings are Peak unless otherwise stated QP in column of 『Note』 . Peak denotes that the Peak reading compliance with the QP Limits and then QP Mode measurement didn't perform ◦
- (2) Measuring frequency range from 1000MHz to 6000MHz or the 10th harmonic of highest fundamental frequency ◦ "F" denotes fundamental frequency; "H" denotes spurious frequency. "E" denotes band edge frequency. (This judgment method includes the Band Edge Requirement.)
- (3) Radiated emissions measured in frequency range above 1000MHz were made with an instrument using Peak detector mode and AV detector mode of the emission ◦
- (4) Data of measurement within this frequency range shown " * " in the table above means the reading of emissions are attenuated more than 20dB below the permissible limits or the field strength is too small to be measured.
- (5) A preamp and high pass filter were used for this test in order to provide sufficient measurement sensitivity.
- (6) EUT Orthogonal Axis :
 "X" - denotes Laid on Table ; "Y" - denotes Vertical Stand ; "Z" - denotes Side Stand

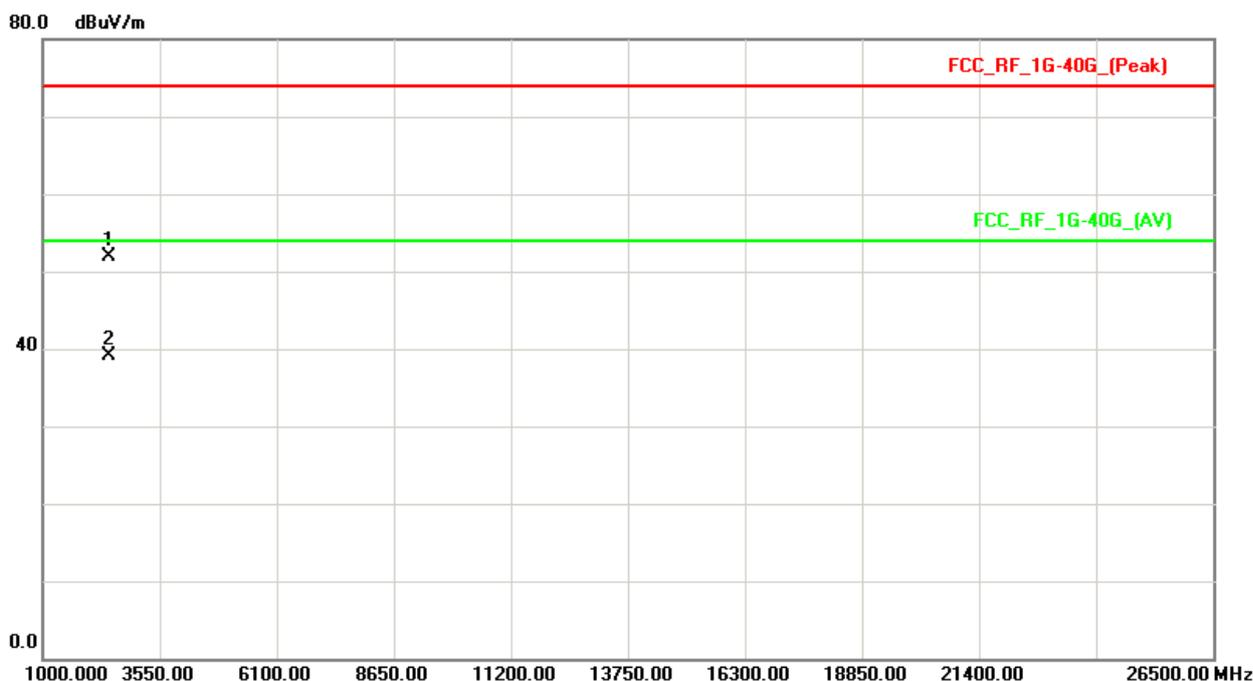



EUT :	GPS Bike Computer	Model Name. :	JOULE 2.0
Temperature :	25°C	Relative Humidity :	58 %
Pressure :	1009 hPa	Test Power :	DC 3.7V
Test Mode :	GPS Mode		

Freq. (MHz)	Ant.Pol. H/V	Reading		Ant./CF CF(dB)	Act.		Limit		Note
		Peak (dBuV)	AV (dBuV)		Peak (dBuV/m)	AV (dBuV/m)	Peak (dBuV/m)	AV (dBuV/m)	
2450.23	H	52.62	42.80	-1.57	51.05	41.23	74.00	54.00	X/E

Remark :

- (1) All readings are Peak unless otherwise stated QP in column of 『Note』 . Peak denotes that the Peak reading compliance with the QP Limits and then QP Mode measurement didn't perform ◦
- (2) Measuring frequency range from 1000MHz to 6000MHz or the 10th harmonic of highest fundamental frequency ◦ "F" denotes fundamental frequency; "H" denotes spurious frequency. "E" denotes band edge frequency. (This judgment method includes the Band Edge Requirement.)
- (3) Radiated emissions measured in frequency range above 1000MHz were made with an instrument using Peak detector mode and AV detector mode of the emission ◦
- (4) Data of measurement within this frequency range shown " * " in the table above means the reading of emissions are attenuated more than 20dB below the permissible limits or the field strength is too small to be measured.
- (5) A preamp and high pass filter were used for this test in order to provide sufficient measurement sensitivity.
- (6) EUT Orthogonal Axis :
 "X" - denotes Laid on Table ; "Y" - denotes Vertical Stand ; "Z" - denotes Side Stand

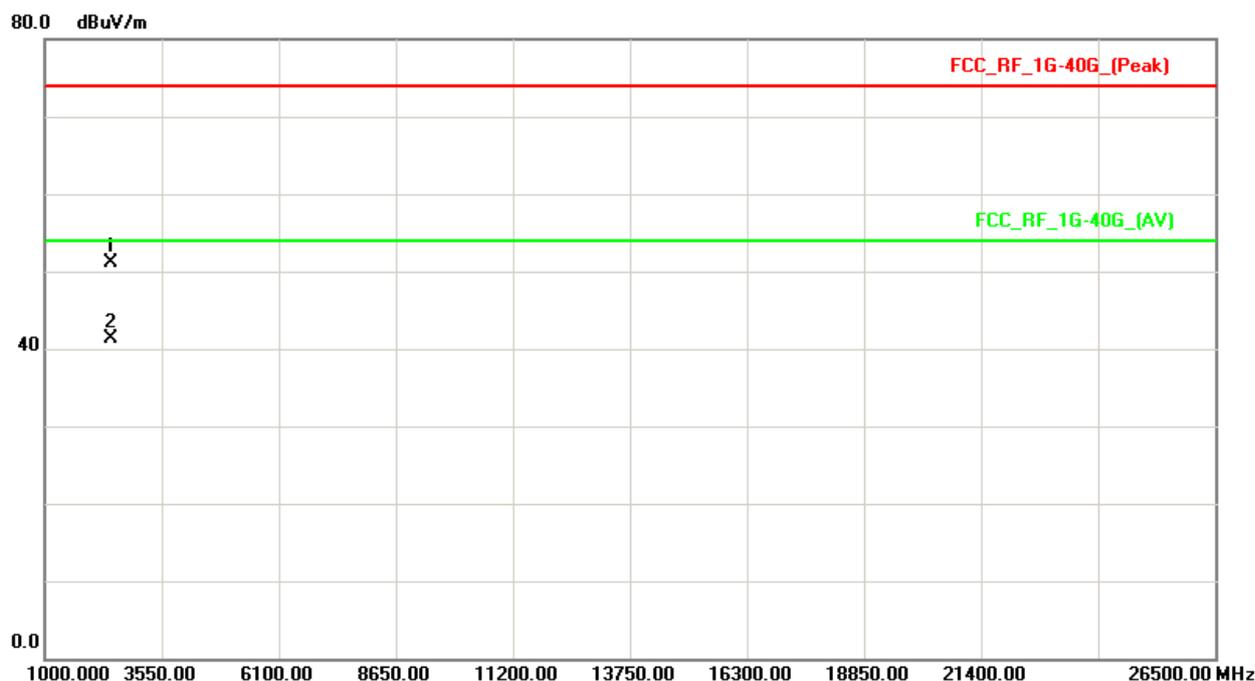



4.2.10 TEST RESULTS (2400 – 2483.5 MHz)

EUT :	GPS Bike Computer	Model Name. :	JOULE 2.0
Temperature :	25°C	Relative Humidity :	58 %
Pressure :	1008 hPa	Test Power :	DC 3.7V
Test Mode :	TX CH 2457MHz		

		Peak	AV		Peak	AV	Peak	AV	
Freq.	Ant. Pol.	Reading		Ant./CL/	Actual FS		Limit3m		
(MHz)	(H/V)	(dBuV)	(dBuV)	CF(dB)	(dBuV/m)	(dBuV/m)	(dBuV/m)	(dBuV/m)	NOTE
2456.75	V	58.45	7.57	31.84	90.29	39.41	114.00	94.00	CH01
2456.75	H	57.95	7.07	31.84	89.79	38.91	114.00	94.00	CH01

Remark :

- (1) All readings are Peak unless otherwise stated QP in column of 『Note』 . Peak denotes that the Peak reading compliance with the QP Limits and then QP Mode measurement didn't perform ◦
- (2) Radiated emissions measured in frequency range above 1000MHz were made with an instrument using Peak detector mode and AV detector mode of the emission ◦
- (3) Data of measurement within this frequency range shown “ * ” in the table above means the reading of emissions are attenuated more than 20dB below the permissible limits or the field strength is too small to be measured.
- (4) EUT Orthogonal Axis :
 “X” - denotes Laid on Table ; ”Y” - denotes Vertical Stand ; ”Z” - denotes Side Stand
- (5) The average value of fundamental frequency is:
 Average = Peak value + 20log(Duty cycle) ◦ Final AV=PK-50.88



5. BANDWIDTH TEST

5.1 MEASUREMENT INSTRUMENTS LIST

Item	Kind of Equipment	Manufacturer	Type No.	Serial No.	Calibrated until
1	Spectrum Analyzer	R&S	FSP 40	100185	Nov.26.2011

Remark: " N/A" denotes No Model Name. , Serial No. or No Calibration specified.

5.2 TEST PROCEDURE

- The EUT was directly connected to the spectrum analyzer and antenna output port as show in the block diagram below,
- Spectrum Setting : RBW= 100KHz, VBW=100KHz, Sweep time = 100 ms.

5.3 DEVIATION FROM STANDARD

No deviation.

5.4 TEST SETUP

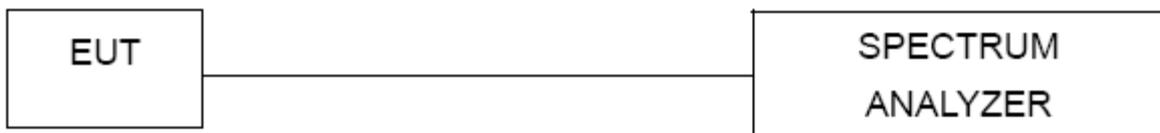

5.5 EUT OPERATION CONDITIONS

The EUT tested system was configured as the statements of 4.1.6 Unless otherwise a special operating condition is specified in the follows during the testing.



5.6 TEST RESULTS

EUT :	GPS Bike Computer	Model Name. :	JOULE 2.0
Temperature :	23°C	Relative Humidity :	51 %
Pressure :	1008 hPa	Test Power :	DC 3.7V
Test Mode :	TX CH01		

Test Channel	Frequency (MHz)	20 dBc Bandwidth (MHz)	99% Occupied BW (MHz)
CH01	2457	1.08	0.98

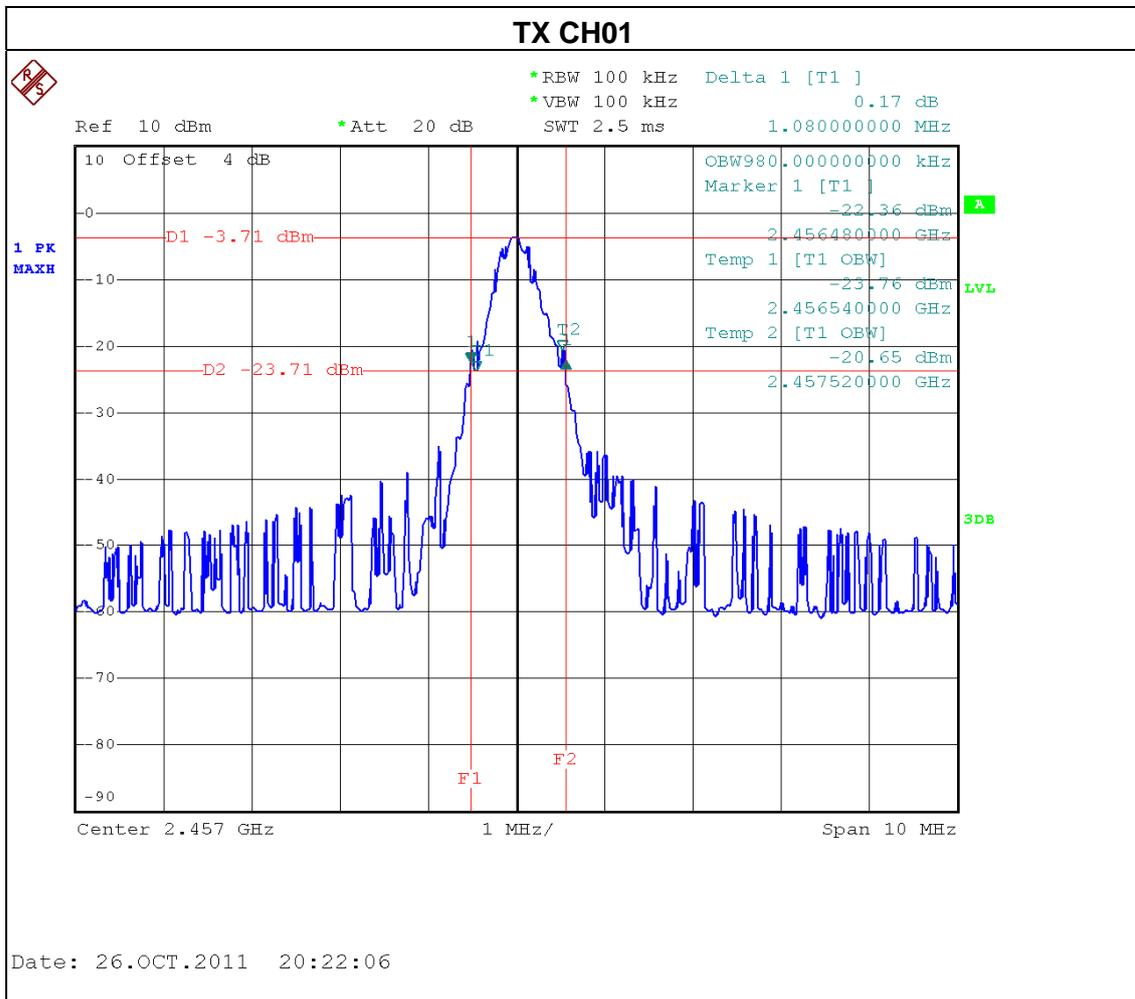



6. ANTENNA CONDUCTED SPURIOUS EMISSION

6.1 APPLIED PROCEDURES / LIMIT

20dBc in any 100 kHz bandwidth outside the operating frequency band. In case the emission fall within the restricted band specified on 15.205(a), then the 15.209(a) limit in the table below has to be followed.

Frequencies (MHz)	Field Strength (micorvolts/meter)	Measurement Distance (meters)
0.009~0.490	2400/F(KHz)	300
0.490~1.705	24000/F(KHz)	30
1.705~30.0	30	30
30~88	100	3
88~216	150	3
216~960	200	3
Above 960	500	3

6.1.1 MEASUREMENT INSTRUMENTS LIST

Item	Kind of Equipment	Manufacturer	Type No.	Serial No.	Calibrated until
1	Spectrum Analyzer	R&S	FSP 40	100185	Nov.26.2011

Remark: " N/A" denotes No Model Name. , Serial No. or No Calibration specified.

6.1.2 TEST PROCEDURE

- a. The EUT was directly connected to the spectrum analyzer and antenna output port as show in the block diagram below,
- b. Spectrum Setting : RBW= 100KHz, VBW=100KHz, Sweep time = 10 ms.

6.1.3 DEVIATION FROM STANDARD

No deviation.

6.1.4 TEST SETUP

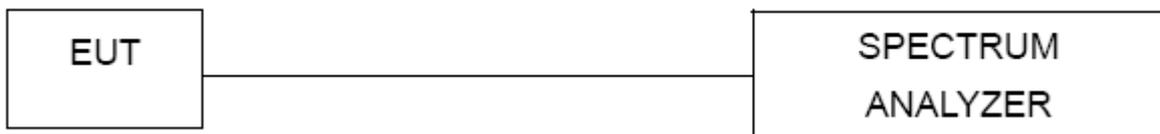

6.1.5 EUT OPERATION CONDITIONS

The EUT tested system was configured as the statements of 4.1.6 Unless otherwise a special operating condition is specified in the follows during the testing.



6.1.6 TEST RESULTS

EUT :	GPS Bike Computer	Model Name. :	JOULE 2.0
Temperature :	23°C	Relative Humidity :	51 %
Pressure :	1008 hPa	Test Power :	DC 3.7V
Test Mode :	TX CH01		

Channel of Worst Data: CH01			
The max. radio frequency power in any 100kHz bandwidth outside the frequency band		The max. radio frequency power in any 100 kHz bandwidth within the frequency band.	
FREQUENCY(MHz)	POWER(dBm)	FREQUENCY(MHz)	POWER(dBm)
2372.6	-57.13	2487.2	-56.07

Result

In any 100kHz bandwidth outside the frequency band, the radio frequency power is at least 50dB below that in the 100kHz bandwidth within the band that contains the highest level of the desired power.

Band-edge test results –apply marker delta method

Peak fundamental frequency measured	86.79dBuV/m
Delta	56.07dBm-4.03dBm=52.04dB
Peak field strength at 2483.5MHz	86.79dBuV/m-52.04dB=34.75dBuV/m
Result	PASS < Limits 74 dBuV/m



TX CH01 for bandedge

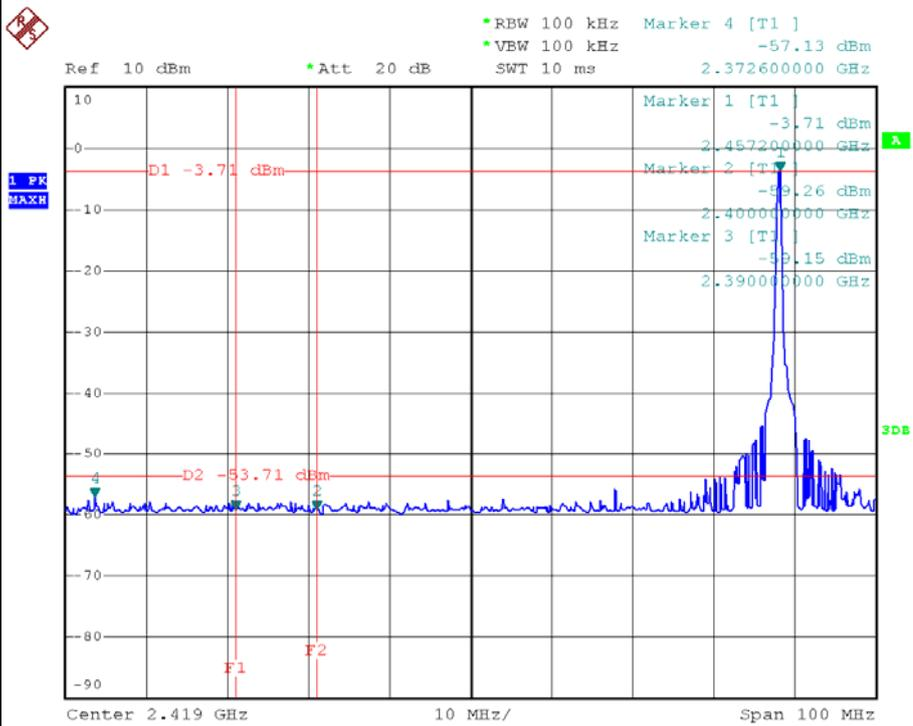

Date: 1.NOV.2011 17:57:43

TX CH01 for bandedge

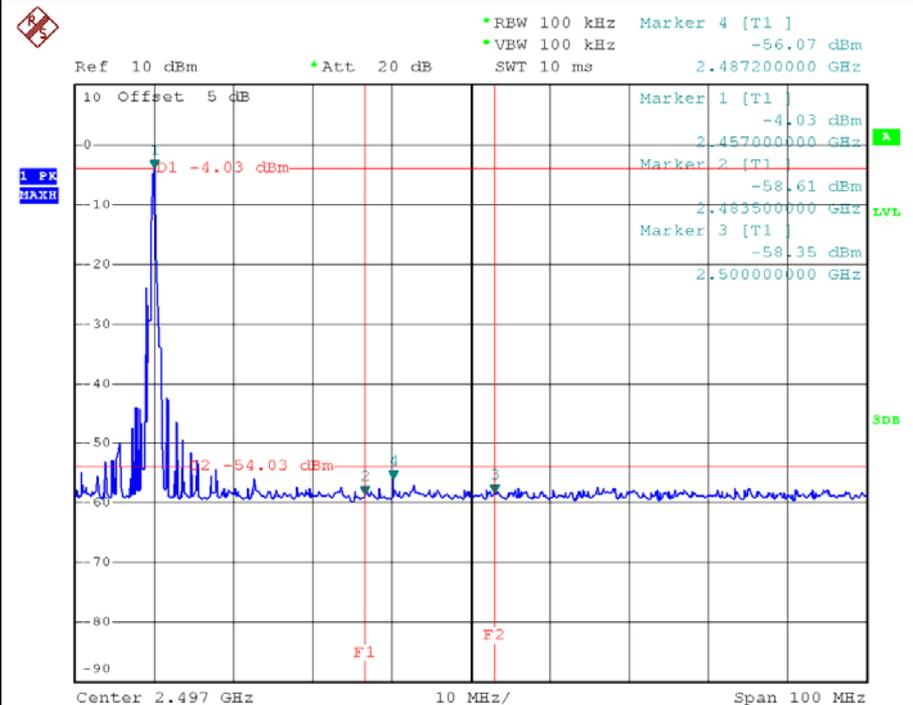

Date: 31.OCT.2011 15:52:25

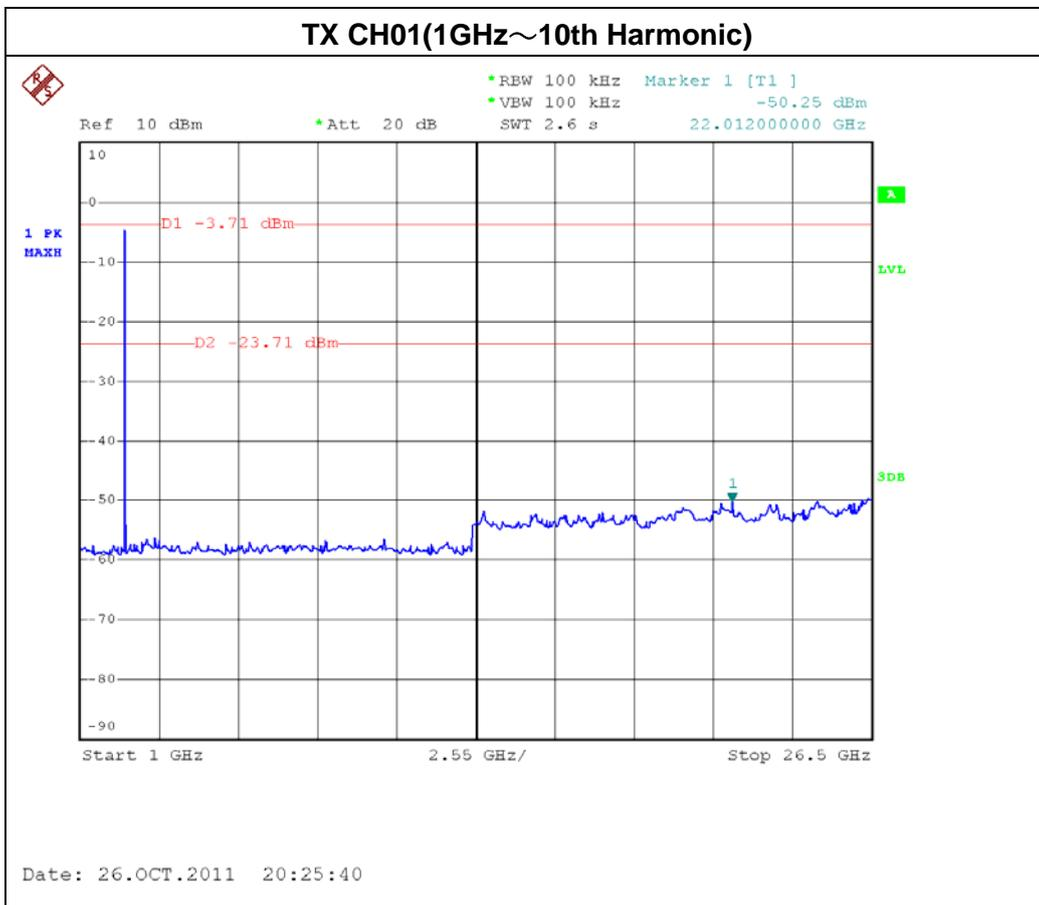
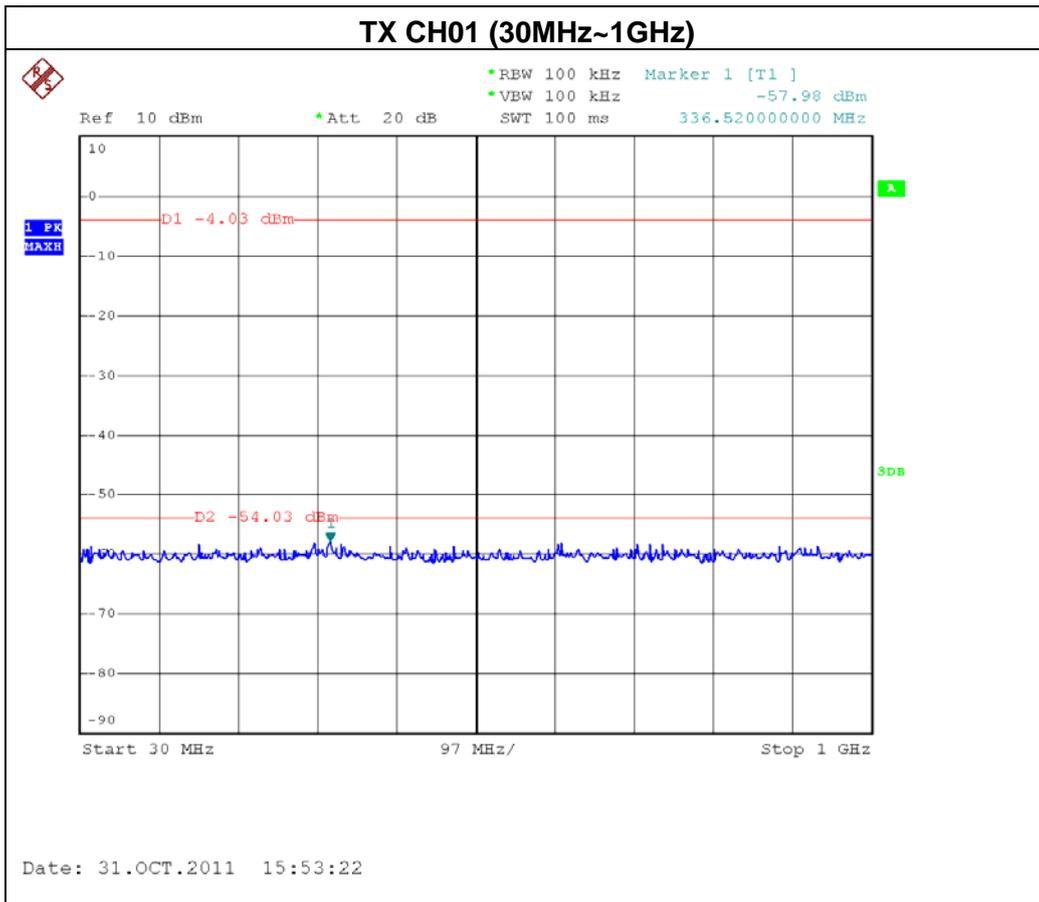



7. EUT TEST PHOTO

Conducted Measurement Photos





**Radiated Measurement Photos
9K~30MHz**

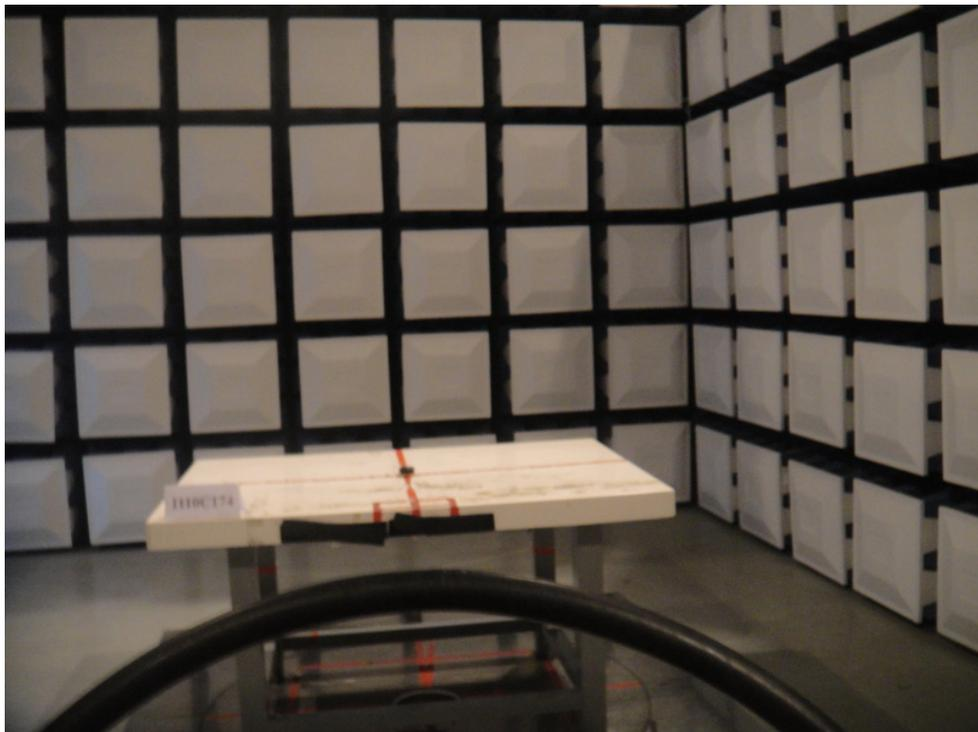
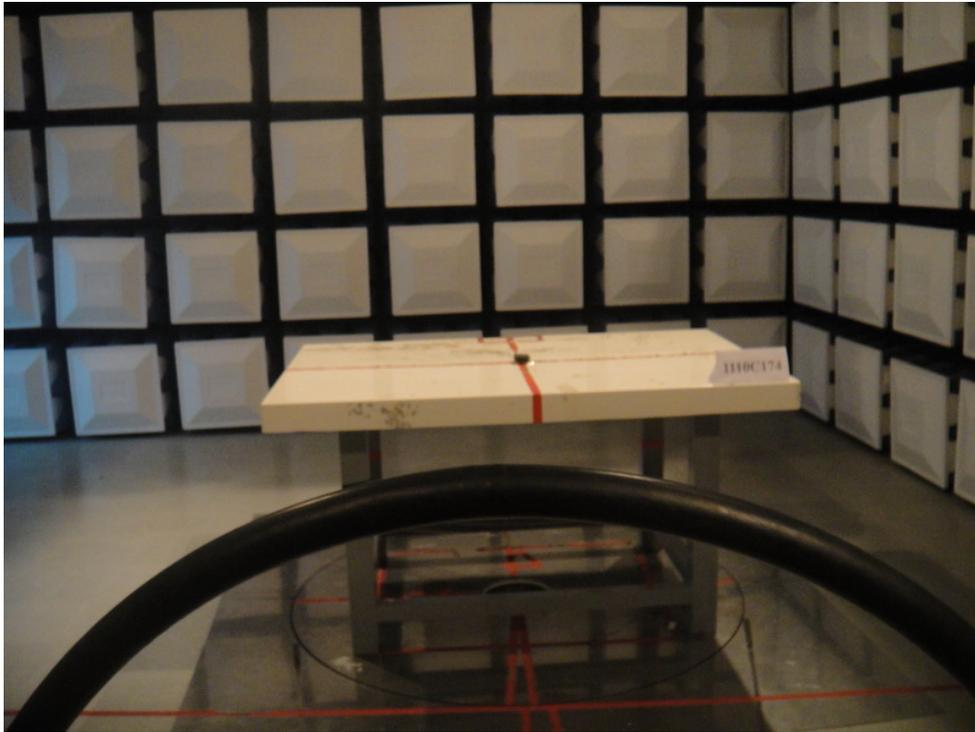



**Radiated Measurement Photos
30M~1000MHz**

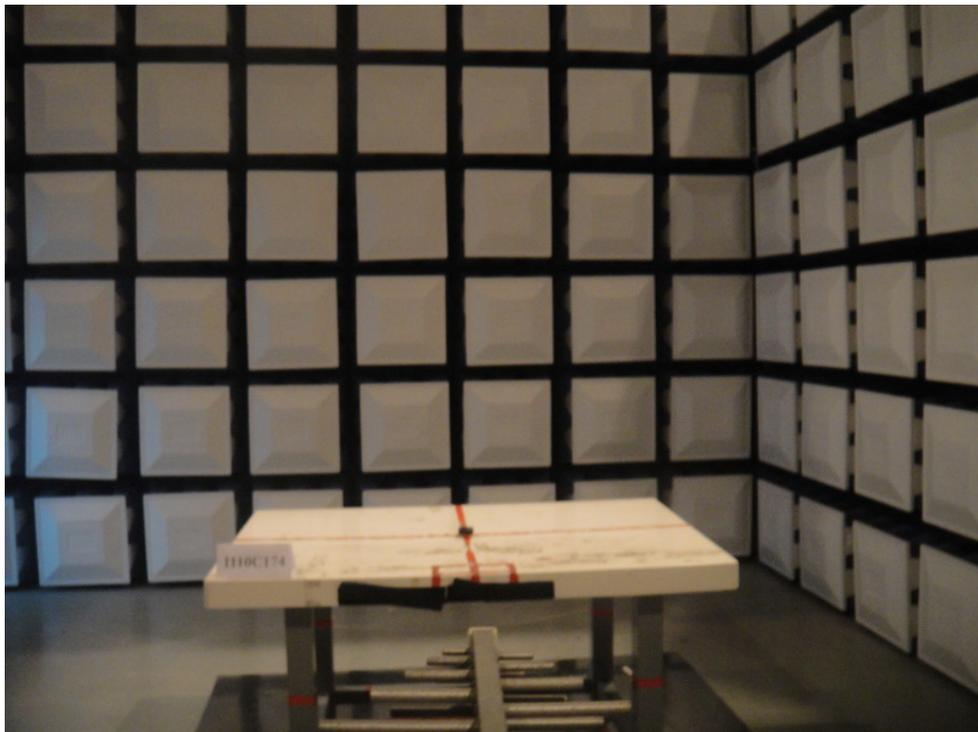
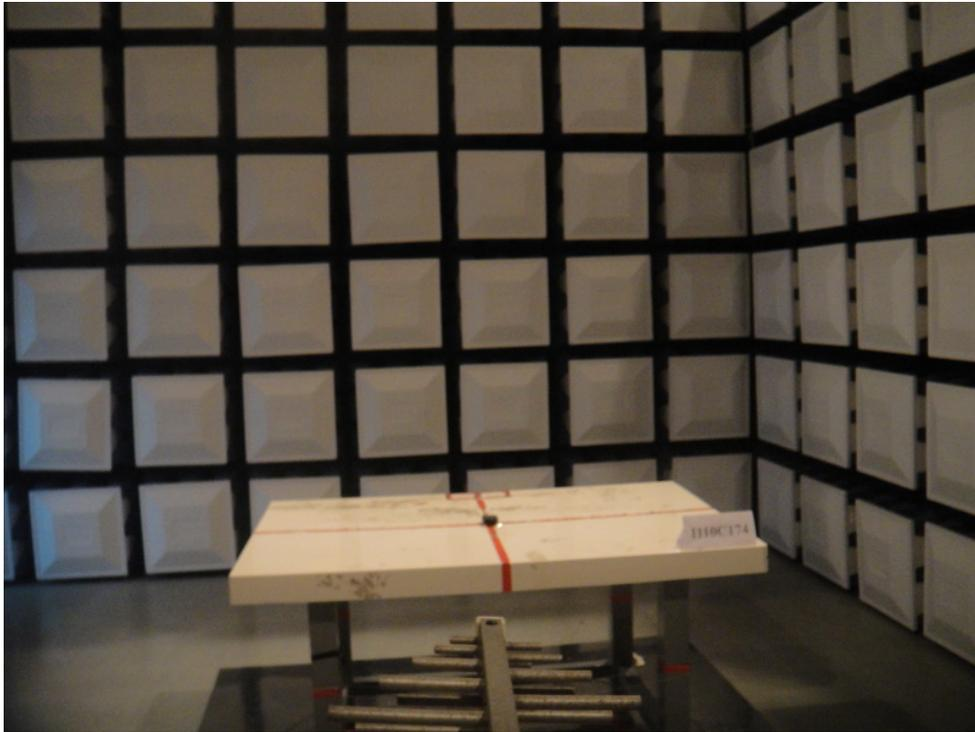



**Radiated Measurement Photos
Above 1000MHz**

