

A

B

C

D

E

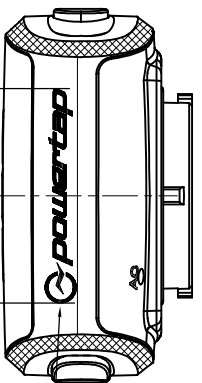

Top case assy A0-4300G303  
High gloss black ▲

Top case assy A1-4304L06  
High gloss Orange 165C ▲



L-Side button black  
A2-4301002BK  
Button pin: 48-14834T(x1)  
O-ring: 38-0160BK(x1)  
Click sw: 44-R060NN(x2)  
E-ring: 87-0057T(x1)  
由Tomvic船上 (供應商: 利達實業)

Top case assy A0-4300G303  
High gloss black ▲

Top case assy A1-4304L06  
High gloss Orange 165C ▲

Bottom case assy A1-4304L06  
High gloss Orange 165C ▲

Bluetooth SMART  
FCC ID: Q0CJ28LE  
IC: 7686-X28LE  
MODEL: J0ULE GPS PLUS  
MADE IN CHINA  
Lithium Polymer 3.7V  
5.0V 500mA  
N300045  
R018-150034

Dayton's Date code

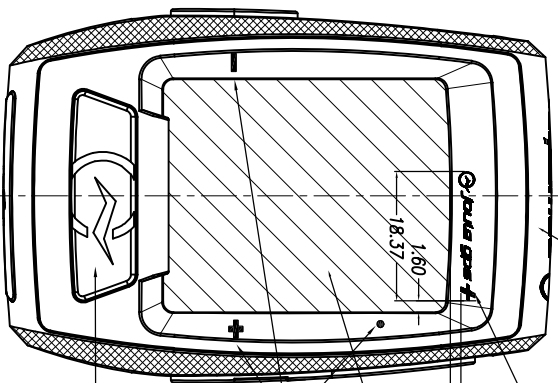
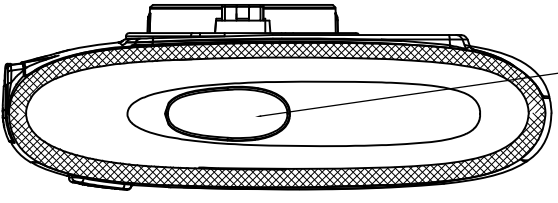
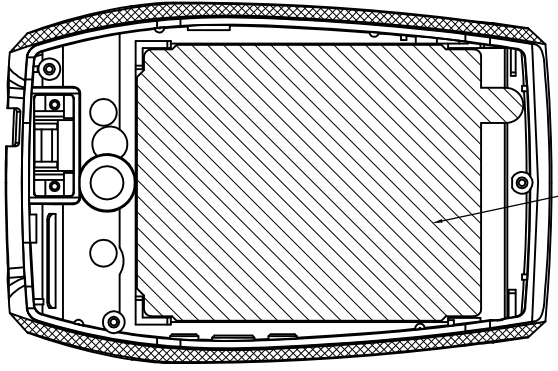

Orange 1665C  
on back of top lens  
A6-4299A02

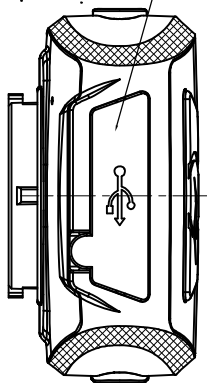
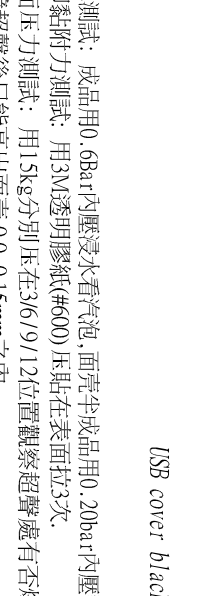
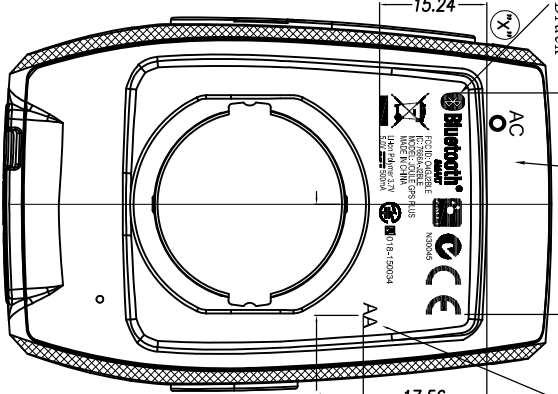
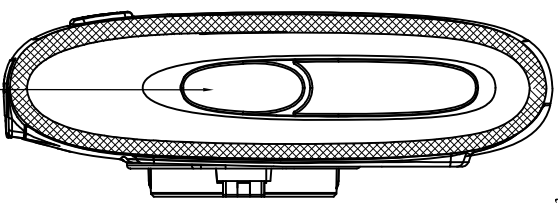

Orange 1665C  
on back of top lens  
A6-4299A02

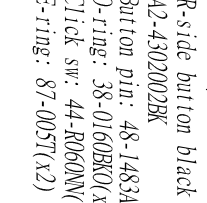

- Note:
1. 防水測試: 成品用0.6bar內壓浸水看汽泡, 面壳半成品用0.20bar內壓試水.
  2. 絲印柔附力測試: 用3M透明膠紙(#600) 壓貼在表面拉3次.
  3. 鏡面壓力測試: 用15kg分別壓在3/6/9/12位置觀察超聲處有否爆裂.
  4. 面鏡超聲後只能高出面壳 0.0~0.15mm之內.
  5. 用偏光鏡測試面鏡應力紋即黑影, 不能走進斜線範圍內.

DAYTON INDUSTRIAL CO. LTD.  
KENDY ENTERPRISE LTD.

3rd angle projection  
Super Joule

LINEAR ±0.1  
ANGULAR ±1°  
UNSPECIFIED TOLERANCE

VERSION NO: 1.4

1.4	changed top case and front key	17/2/2015	TITLE: Cosmetic	MODEL NAME: Super Joule	DATE: 17-2-2015
1.3	Add Japan code	21/1/15	PART NO: B9-GR5570000	MODEL NO: GR55700	SHEET 1 of 1
1.2	Revise bottom case color	2/12/14	MAT'L: ABS	DOC CONTROL NO: 005-2527	APPD
1.1	Revise bottom case printing	9/10/14	SCALE: 1:1	CHKD	
REV.	REVISIONS	DATE	FINISH:	QTY: 1	DWN

4

3

2

1

4

3

2

1

A

B

C

D

E