



FCC / ISED – TEST REPORT

Report Number : **60.790.24.017.01R02** Date of Issue: April 9, 2024

Model/HVIN : **SBC-D10**

Product Type : **MasterMind H3**

Applicant : **Dayton Industrial Co., Ltd**

Address : **2-12 Kwai Fat Road, 11-A Kwai Chung, New Territories, Hong Kong.**

Production Facility : **KENDY ELECRTONICS (DONGGUAN) CO., LTD.**

Address : **XIN SI HUANG TANG VILLAGE HENG LI TOWN, DONGGUAN CITY, GUANGDONG, CHINA.**

Test Result : **Positive** Negative

Total pages including Appendices : **27**

Any use for advertising purposes must be granted in writing. This technical report may only be quoted in full. This report is the result of a single examination of the object in question and is not generally applicable evaluation of the quality of other products in regular production. For further details, please see testing and certification regulation, chapter A-3.4.



1 Table of Contents

1	Table of Contents	2
2	Details about the Test Laboratory	3
3	Description of the Equipment Under Test.....	4
4	Summary of Test Standards	5
5	Summary of Test Results.....	6
6	General Remarks	7
7	Test Setups	8
8	Systems Test Configuration	10
9	Technical Requirement.....	11
9.1	Conducted Emission	11
9.2	20 dB Bandwidth.....	14
9.3	99% bandwidth	16
9.4	Radiated Emissions	18
10	Test Equipment List.....	26
11	System Measurement Uncertainty.....	27



2 Details about the Test Laboratory

Details about the Test Laboratory

Test Site 1

Company name: TÜV SÜD Certification and Testing (China) Co., Ltd. Shenzhen Branch
Building 12 & 13, Zhiheng Wisdomland Business Park, Guankou Erlu, Nantou, Nanshan District
Shenzhen 518052
P.R. China

Telephone: 86 755 8828 6998

Fax: 86 755 8828 5299

FCC Registration No.: 514049

FCC Deignation No.: CN5009

IC Registration No.: 10320A

ISED CAB Identifier: CN0077



3 Description of the Equipment Under Test

Product:	MasterMind H3
Model no.:	SBC-D10
Hardware Version Identification No. (HVIN)	SBC-D10
Product Marketing Name (PMN)	MasterMind H3
Brand name:	N/A
FCC ID:	O4GH3A
IC:	7666A-H3
Rating:	12.0 VDC (Powered by Bike Battery) Or 5.0 VDC (Powered by USB Port)
RF Transmission Frequency:	2457MHz
No. of Operated Channel:	1
Modulation:	GFSK
Antenna Type:	PCB Antenna
Antenna	Gain: 0 dBi
Description of the EUT:	The Equipment Under Test (EUT) is a MasterMind H3 which support Bluetooth (BLE) function and Ant+ function. Only ANT+ Function included in this report.

NOTE:

1. The above EUT's information is declared by manufacturer. Please refer to the specifications or user's manual for more detailed description.



4 Summary of Test Standards

Test Standards	
FCC Part 15 Subpart C 10-1-2021 Edition	PART 15 - RADIO FREQUENCY DEVICES Subpart C - Intentional Radiators
RSS-Gen Issue 5 April 2018 + Amendment 1 March 2019 + Amendment 2 February 2021	General Requirements for Compliance of Radio Apparatus
RSS-210 Issue 10 December 2019 + Amendment April 2020	Licence-exempt Radio Apparatus (All Frequency Bands): Category I Equipment

All the test methods were according to ANSI C63.10-2013.



5 Summary of Test Results

Technical Requirements						
FCC Part 15 Subpart C/ RSS-210 Issue 10 + AMD / RSS-Gen Issue 5 + A1 + A2						
Test Condition	Test Site	Test Result			Test Environment	
		Pass	Fail	N/A		
§15.207 & RSS-GEN 8.8	Conducted emission AC power port	Site 1	<input checked="" type="checkbox"/>	<input type="checkbox"/>	<input type="checkbox"/>	T: 24.8°C H: 53.7%
§15.215 & RSS-GEN 6.7	20dB bandwidth and 99% Occupied Bandwidth	Site 1	<input checked="" type="checkbox"/>	<input type="checkbox"/>	<input type="checkbox"/>	T: 24.8°C H: 53.7%
§15.249 & §15.209 & §15.205 & RSS-210 B.10 & RSS-Gen 6.13	Radiated Emissions	Site 1	<input checked="" type="checkbox"/>	<input type="checkbox"/>	<input type="checkbox"/>	T: 24.7°C H: 49.3%
§15.203 & RSS-Gen 6.8	Antenna requirement	See note 2	<input checked="" type="checkbox"/>	<input type="checkbox"/>	<input type="checkbox"/>	--

Note 1: N/A=Not Applicable.

Note 2: The EUT uses a PCB antenna, which gain is 0 dBi. In accordance to §15.203 & RSS-Gen 6.8, it is considered sufficiently to comply with the provisions of this section.

Note 3: T :Temperature, H: Humidity



6 General Remarks

Remarks

This submittal(s) (test report) is intended for **FCC ID: O4GH3A**, **IC: 7666A-H3**, complies with Section 15.207, 15.209, 15.249 of the FCC Part 15, Subpart C rules and RSS-210, RSS-GEN.

SUMMARY:

All tests according to the regulations cited on page 5 were

n - Performed

o - **Not** Performed

The Equipment under Test

n - **Fulfills** the general approval requirements.

o - **Does not** fulfill the general approval requirements.

Sample Received Date: March 27, 2024

Testing Start Date: March 27, 2024

Testing End Date: April 9, 2024

- TÜV SÜD Certification and Testing (China) Co., Ltd. Shenzhen Branch -

Reviewed by:

Prepared by:

Tested by:

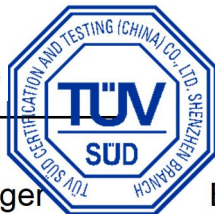

Eric LI
Section Manager

Kevin DU
EMC Project Engineer

Louise LIU
EMC Test Engineer

7 Test Setups

7.1 Radiated test setups

9kHz - 30MHz

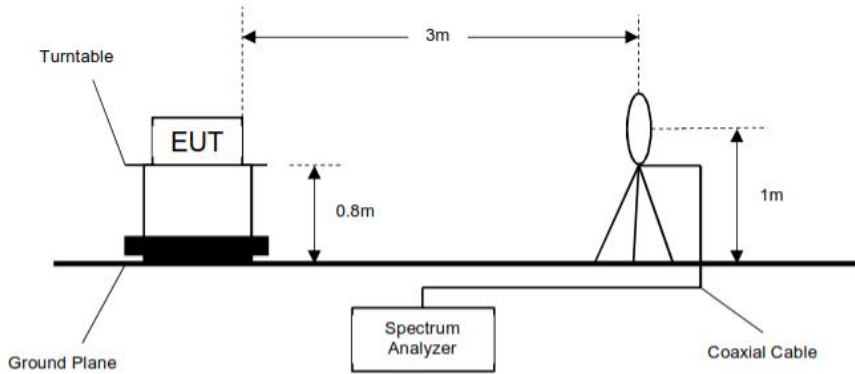

30MHz - 1GHz

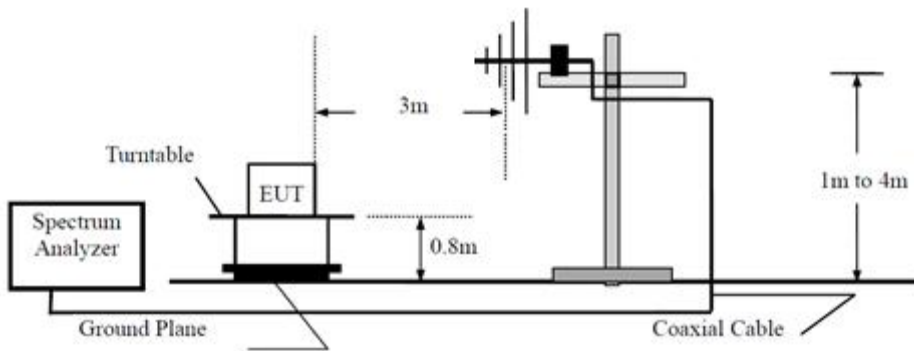

Above 1GHz

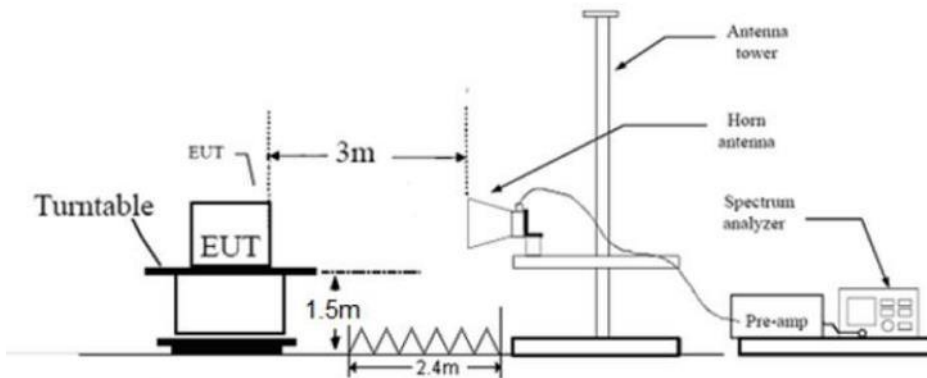

7.2 Conducted RF test setups

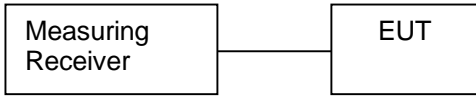

7.3 AC Power Line Conducted Emission test setups

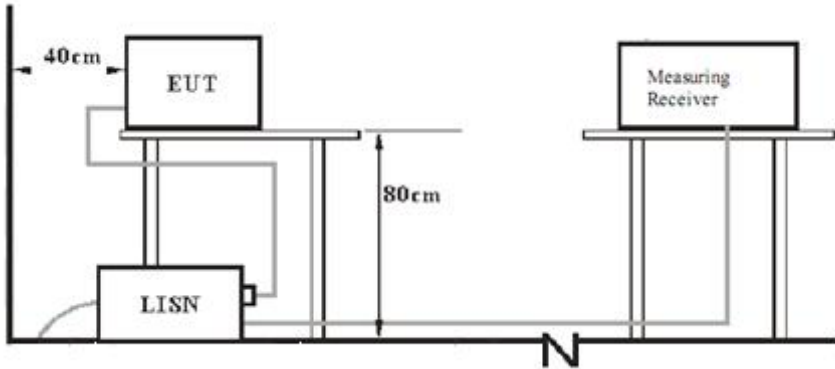

8 Systems Test Configuration

Auxiliary Equipment Used during Test:

Description	Manufacturer	Model NO.	Remark
Laptop	Lenovo	X220	0A72168
Adaptor	Apple	A1357	--
RF Test Mode Software	nRFgo	1.16	Provided by applicant

Cables Used During Test:

Cable	Length	Shielded/unshielded	With / without ferrite
---	---	---	---

The system was configured to non-hopping mode, testing with the Single Channel.

Non-hopping mode: The system was configured to operate at a signal channel transmitting. The test software allows the configuration and operation at the worst-case duty and the highest transmit power.

The transmitter rate 1Mbps and 2Mbps mode are tested, only the worst case transmitter rate data mode is recorded in the report.



9 Technical Requirement

9.1 Conducted Emission

Test Method

1. The EUT was placed 0.4 meter from the conducting wall of the shielding room was kept at least 80 centimeters from any other grounded conducting surface.
2. Connect EUT to the power mains through a line impedance stabilization network (LISN).
3. All the support units are connecting to the other LISN.
4. The LISN provides 50 ohm coupling impedance for the measuring instrument.
5. Both sides of AC line were checked for maximum conducted interference.
6. The frequency range from 150 kHz to 30 MHz was searched.
7. Set the test-receiver system to Peak Detect Function and specified bandwidth (IF Bandwidth = 9kHz) with Maximum Hold Mode. Then measurement is also conducted by Average Detector and Quasi-Peak Detector Function respectively.

Limit

According to §15.207 & RSS-GEN 8.8, conducted emissions limit as below:

Frequency MHz	QP Limit dBµV	AV Limit dBµV
0.150-0.500	66-56*	56-46*
0.500-5	56	46
5-30	60	50

*Decreasing linearly with logarithm of the frequency

Conducted Emission

Product Type : MasterMind H3
 M/N : SBC-D10
 Operating Condition : Normal Working
 Test Specification : Line
 Comment : AC 120V/60Hz

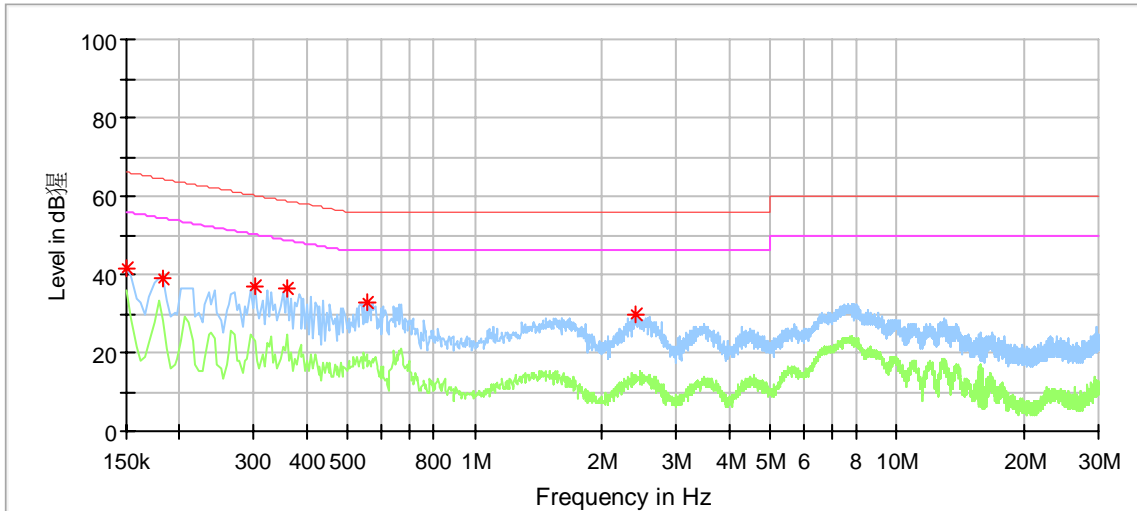

Critical_Freqs

Frequency (MHz)	MaxPeak (dBµV)	Average (dBµV)	Limit (dBµV)	Margin (dB)	Line	Corr. (dB)
0.150000	41.39	---	66.00	24.61	L1	9.52
0.182000	38.97	---	64.39	25.42	L1	9.54
0.302000	36.98	---	60.19	23.21	L1	9.57
0.358000	36.22	---	58.78	22.56	L1	9.57
0.554000	32.57	---	56.00	23.43	L1	9.60
2.418000	29.49	---	56.00	26.51	L1	9.63

Remark:

Max Peak= Read level + Corrector factor

Correct factor=cable loss + LISN factor

(The Reading Level is recorded by software which is not shown in the sheet)

Conducted Emission

Product Type : MasterMind H3
 M/N : SBC-D10
 Operating Condition : Normal Working
 Test Specification : Neutral
 Comment : AC 120V/60Hz

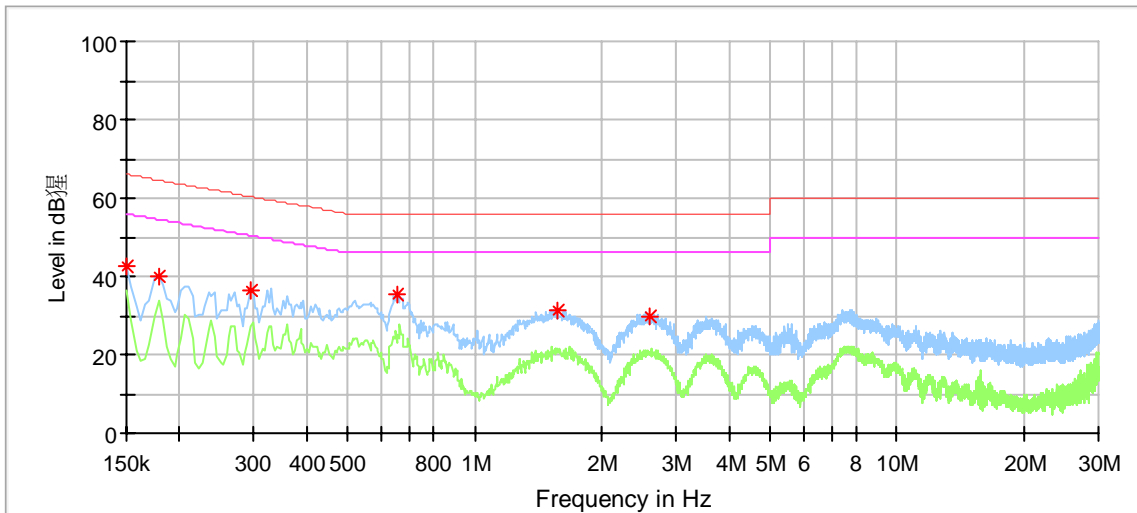

Critical_Freqs

Frequency (MHz)	MaxPeak (dBµV)	Average (dBµV)	Limit (dBµV)	Margin (dB)	Line	Corr. (dB)
0.150000	42.76	---	66.00	23.24	N	9.55
0.178000	40.01	---	64.58	24.57	N	9.57
0.294000	36.57	---	60.41	23.84	N	9.60
0.654000	35.22	---	56.00	20.78	N	9.63
1.574000	31.28	---	56.00	24.72	N	9.64
2.598000	29.86	---	56.00	26.14	N	9.67

Remark:

Max Peak= Read level + Corrector factor

Correct factor=cable loss + LISN factor

(The Reading Level is recorded by software which is not shown in the sheet)



9.2 20 dB Bandwidth

Test Method

1. The RF output of EUT was connected to the spectrum analyzer. The path loss was compensated to the results for each measurement.
2. Set to the maximum power setting, the instrument center frequency is set to the nominal EUT channel center frequency enable the EUT transmit continuously.
3. Use the following spectrum analyzer settings:
RBW=100KHz, VBW≥3RBW, Sweep = auto, Detector function = peak, Trace = max hold
4. Use the automatic bandwidth measurement capability of an instrument, use the X dB bandwidth mode with X set to 20 dB.
5. Allow the trace to stabilize, record the 6 dB Bandwidth value.

Limit

Limit [kHz]

Test result

Frequency MHz	Mode	20dB bandwidth MHz	Result
2457 MHz	1M bps	1.119	Pass
2457 MHz	2M bps	2.094	Pass

Test Graphs as below:

1M ANT+_Ant0_2457

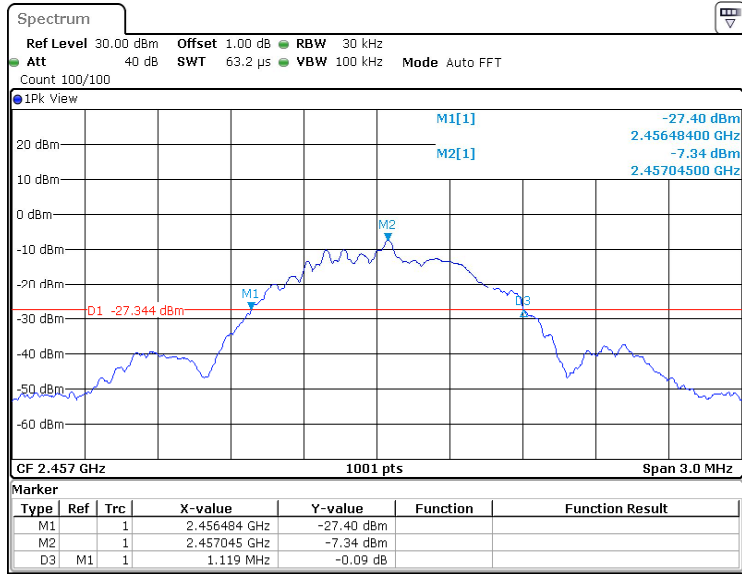

2M ANT+_Ant0_2457

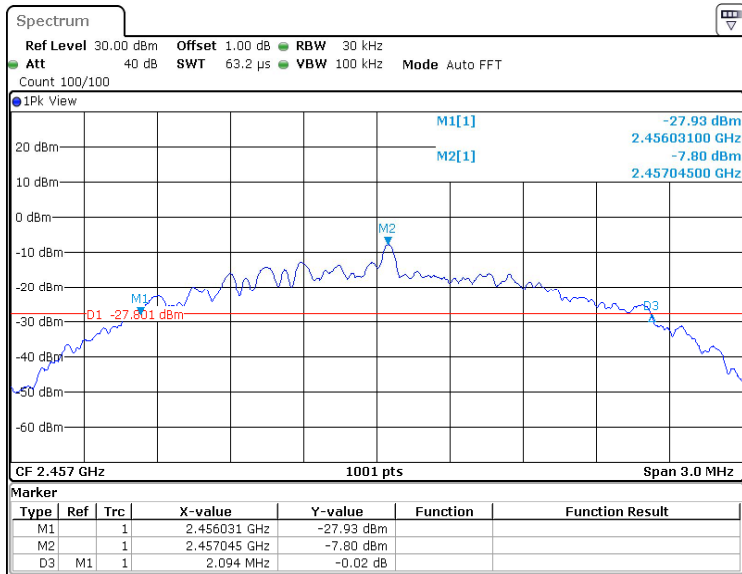



9.3 99% bandwidth

Test Method of 99% Bandwidth

1. Set center frequency to the nominal EUT channel center frequency
2. Set span = 1.5 times to 5.0 times the OBW. Set RBW = 1 % to 5 % of the OBW
Set VBW ≥ 3 RBW Trace mode = max hold. Sweep = auto couple.
Allow the trace to stabilize.
3. Use the 99 % power bandwidth function of the instrument.
4. Record the results in the test report.

Limit

Limit [kHz]

--

Test result

Frequency MHz	Mode	99% bandwidth MHz	Result
2457 MHz	1 Mbps	1.056	Pass
2457 MHz	2 Mbps	2.106	Pass

Test Graphs as below:

1M ANT+_Ant0_2457

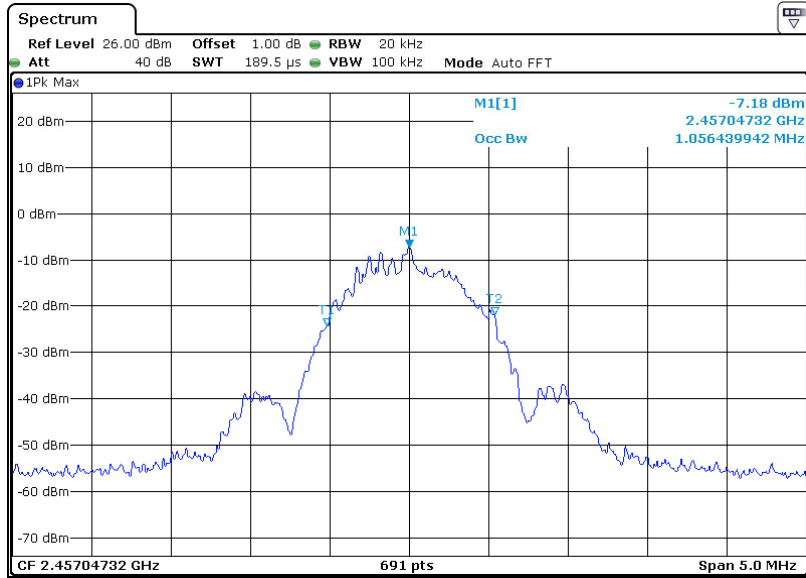

2M ANT+_Ant0_2457

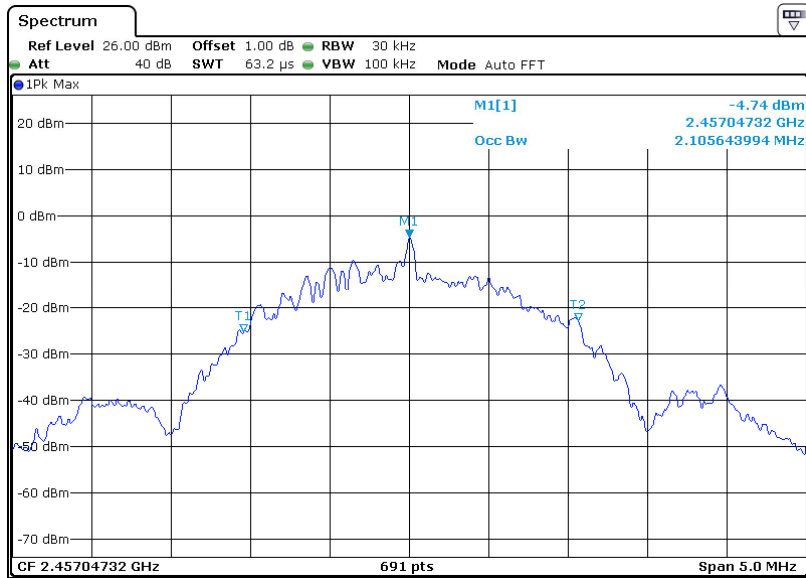

9.4 Radiated Emissions

Test Method

1. The EUT was placed on a turn table which is 1.5m above ground plane for above 1GHz and 0.8m above ground for below 1GHz at 3 meter chamber room for test. The table was rotated 360 degrees to determine the position of the highest radiation.
2. The EUT was set 3 meters away from the interference – receiving antenna, which was mounted on the top of a variable – height antenna tower.
3. The height of antenna is varied from one meter to four meters above the ground to determine the maximum value of the field strength. Both horizontal and vertical polarizations of the antenna are set to make the measurement.
4. For each suspected emission, the EUT was arranged to its worst case and then the antenna was tuned to heights from 1 meter to 4 meters and the rotatable table was turned from 0 degrees to 360 degrees to find the maximum reading.
5. Use the following spectrum analyzer settings According to C63.10:

Procedure for Unwanted Emissions Measurements Below 1000 MHz

Span = wide enough to capture the peak level of the in-band emission and all spurious
 RBW = 100 KHz to 120KHz, VBW ≥ RBW for peak measurement, Sweep = auto, Detector function = peak, Trace = max hold.

For Peak unwanted emissions Above 1GHz:

Span = wide enough to capture the peak level of the in-band emission and all spurious
 RBW = 1MHz, VBW ≥ RBW for peak measurement, Sweep = auto, Detector function = peak, Trace = max hold.

Procedures for average unwanted emissions measurements above 1000 MHz

- a) RBW = 1MHz.
- b) VBW \ [3 × RBW].
- c) Detector = RMS (power averaging), if [span / (# of points in sweep)] \ RBW / 2. Satisfying this condition can require increasing the number of points in the sweep or reducing the span. If the condition is not satisfied, then the detector mode shall be set to peak.
- d) Averaging type = power (i.e., rms) (As an alternative, the detector and averaging type may be set for linear voltage averaging. Some instruments require linear display mode to use linear voltage averaging. Log or dB averaging shall not be used.)
- e) Sweep time = auto.
- f) Perform a trace average of at least 100 traces if the transmission is continuous. If the transmission is not continuous, then the number of traces shall be increased by a factor of 1 / D, where D is the duty cycle. For example, with 50% duty cycle, at least 200 traces shall be averaged. (If a specific emission is demonstrated to be continuous—i.e., 100% duty cycle—then rather than turning ON and OFF with the transmit cycle, at least 100 traces shall be averaged.)
- g) If tests are performed with the EUT transmitting at a duty cycle less than 98%, then a correction factor shall be added to the measurement results prior to comparing with the emission limit, to compute the emission level that would have been measured had the test been performed at 100% duty cycle. The correction factor is computed as follows:



- 1) If power averaging (rms) mode was used in the preceding step e), then the correction factor is $[10 \log (1 / D)]$, where D is the duty cycle. For example, if the transmit duty cycle was 50%, then 3 dB shall be added to the measured emission levels.
- 2) If linear voltage averaging mode was used in the preceding step e), then the correction factor is $[20 \log (1 / D)]$, where D is the duty cycle. For example, if the transmit duty cycle was 50%, then 6 dB shall be added to the measured emission levels.
- 3) If a specific emission is demonstrated to be continuous (100% duty cycle) rather than turning ON and OFF with the transmit cycle, then no duty cycle correction is required for that emission(AV) at frequency above 1GHz.

Limit

According to §15.249 (a) & RSS-210 B.10, the field strength of emissions from intentional radiators operated within these frequency bands shall comply with the following:

Fundamental frequency	Field strength of fundamental (millivolts/meter)	Field strength of harmonics (microvolts/meter)
902–928 MHz	50	500
2400–2483.5 MHz	50	500
5725–5875 MHz	50	500
24.0–24.25 GHz	250	2500

According to §15.249 (c) & RSS-GEN 8.9, Field strength limits are specified at 3 meters distance. According to §15.249 (d) & RSS-GEN, Emissions radiated outside of the specified frequency bands, except for harmonics, shall be attenuated by at least 50 dB below the level of the fundamental or to the general radiated emission limits in §15.209 & RSS-GEN 8.9, whichever is the lesser attenuation.

According to §15.205 Unwanted emissions falling into restricted bands in §15.205 (a) & RSS-GEN 8.10 shall comply with the limits specified in §15.209 & RSS-GEN 8.9.

Frequency MHz	Field Strength uV/m	Field Strength dBµV/m	Detector
30-88	100	40	QP
88-216	150	43.5	QP
216-960	200	46	QP
960-1000	500	54	QP
Above 1000	500	54	AV
Above 1000	5000	74	PK

Spurious radiated emissions for transmitter

According to C63.10, if the peak (or quasi-peak) measured value complies with the average limit, it is unnecessary to perform an average measurement, so AV emission value did not show in below table if the peak value complies with average limit.

The only worse case (1 Mbps) test result is listed in the report.

Transmitting spurious emission test result as below:

Test data_30MHz to 1000MHz
ANT+ 1 Mbps

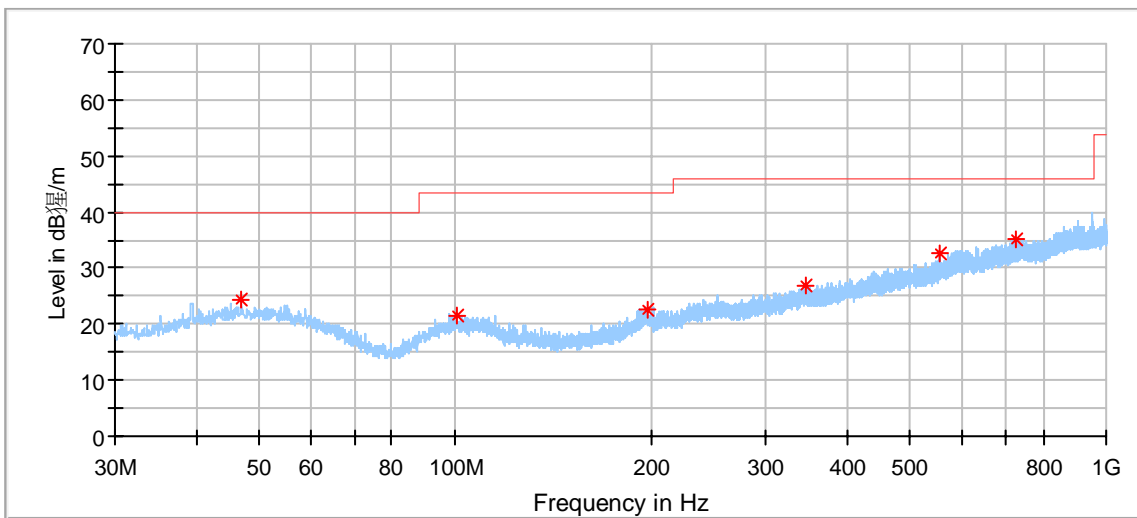

Critical_Freqs

Frequency (MHz)	MaxPeak (dBµV/m)	Limit (dBµV/m)	Margin (dB)	Height (cm)	Pol	Azimuth (deg)	Corr. (dB/m)
46.975000	24.37	40.00	15.63	100.0	H	296.0	18.35
100.540556	21.56	43.50	21.94	200.0	H	174.0	15.87
196.786111	22.64	43.50	20.86	100.0	H	37.0	16.14
344.872778	26.92	46.00	19.08	200.0	H	1.0	19.74
556.440556	32.68	46.00	13.32	200.0	H	0.0	23.71
726.513889	35.30	46.00	10.70	100.0	H	0.0	26.52

Test data_30MHz to 1000MHz
ANT+ 1 Mbps

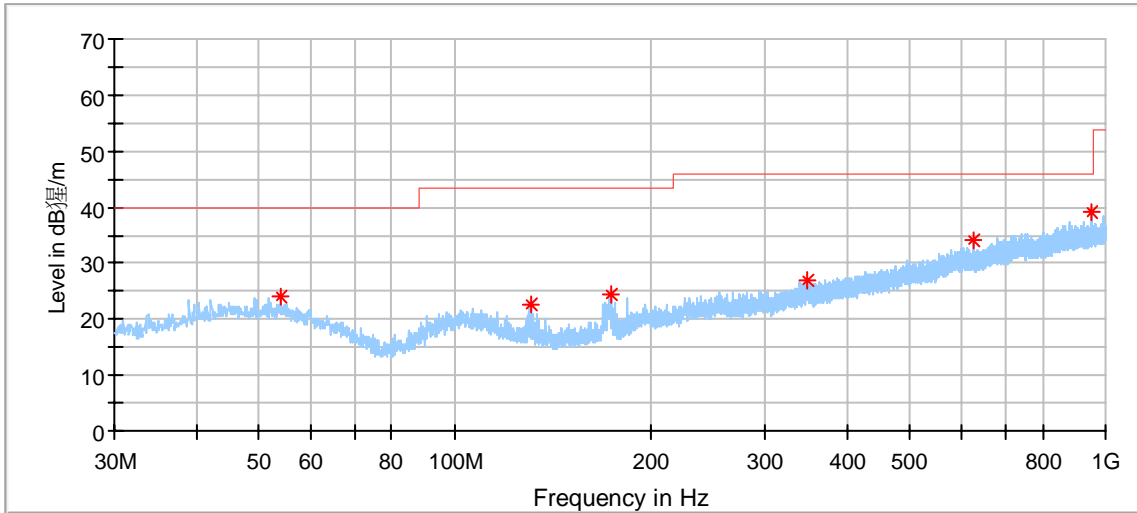

Critical_Freqs

Frequency (MHz)	MaxPeak (dBµV/m)	Limit (dBµV/m)	Margin (dB)	Height (cm)	Pol	Azimuth (deg)	Corr. (dB/m)
53.926667	24.14	40.00	15.86	100.0	V	65.0	17.91
130.502778	22.71	43.50	20.79	100.0	V	297.0	12.99
173.290556	24.45	43.50	19.05	100.0	V	340.0	13.44
349.237778	26.97	46.00	19.03	100.0	V	271.0	19.85
626.603889	34.02	46.00	11.98	100.0	V	252.0	24.92
953.978889	39.19	46.00	6.81	100.0	V	314.0	29.11

Test data 1GHz to 18GHz:
ANT+ 1 Mbps

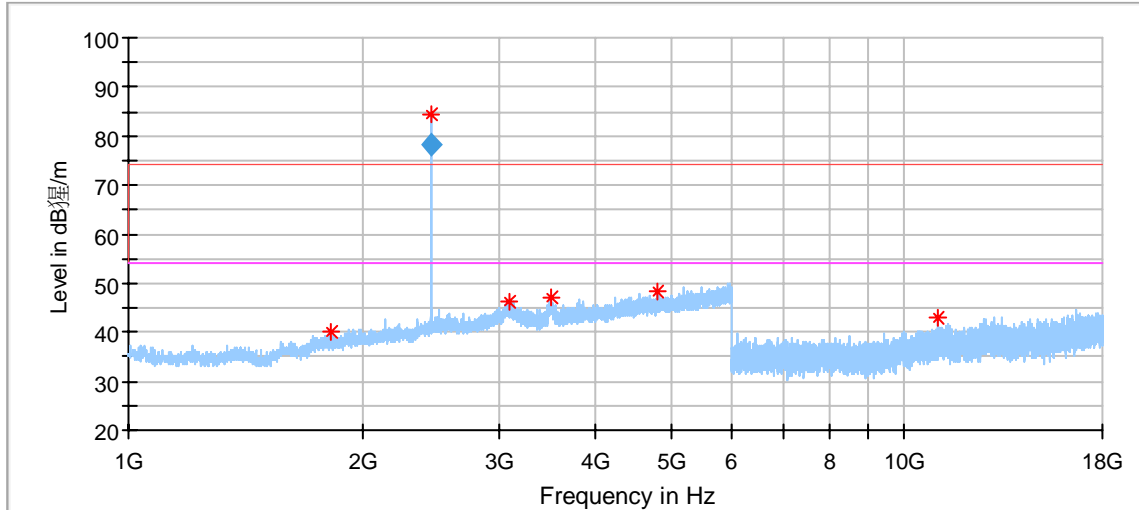

Frequency MHz	Result dBμV/m	Limit dBμV/m	Margin dB	Detector PK/QP/AV	Corr. (dB)	Pol	RSE. or Fund.
1820.500000	40.23	74.00	33.77	Peak	-5.96	H	Spurious emission
2457.000000	84.61	114.00	29.39	Peak	-2.79	H	Fundamental
2457.000000	78.19	94.00	15.81	AV	-2.79	H	Fundamental
3093.500000	46.43	74.00	27.57	Peak	0.64	H	Spurious emission
3506.500000	47.15	74.00	26.85	Peak	2.56	H	Spurious emission
4809.500000	48.47	74.00	25.53	Peak	2.96	H	Spurious emission
11068.500000	42.88	74.00	31.12	Peak	10.21	H	Spurious emission

Test data 1GHz to 18GHz:
ANT+ 1 Mbps

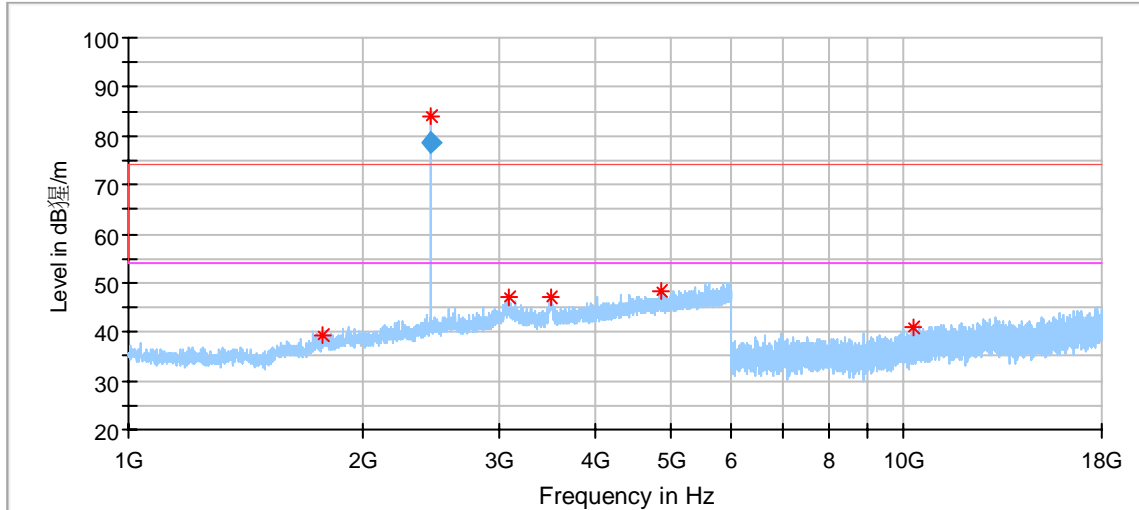

Frequency MHz	Result dBµV/m	Limit dBµV/m	Margin dB	Detector PK/QP/AV	Corr. (dB)	Pol	RSE. or Fund.
1782.000000	39.27	74.00	34.73	Peak	-6.02	V	Spurious emission
2457.000000	83.84	114.00	30.16	Peak	-2.79	V	Fundamental
2457.000000	78.77	94.00	15.23	AV	-2.79	V	Fundamental
3103.500000	46.97	74.00	27.03	Peak	0.64	V	Spurious emission
3504.000000	47.16	74.00	26.84	Peak	2.71	V	Spurious emission
4860.000000	48.18	74.00	25.82	Peak	3.11	V	Spurious emission
10292.500000	40.92	74.00	33.08	Peak	8.92	V	Spurious emission

Test data 1GHz to 18GHz:
ANT+ 2 Mbps

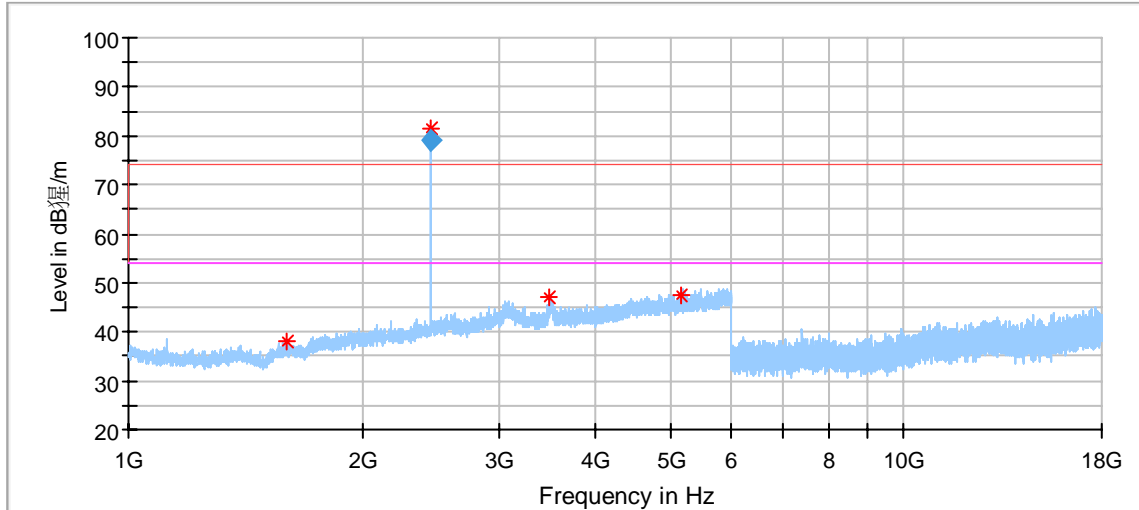

Frequency MHz	Result dBµV/m	Limit dBµV/m	Margin dB	Detector PK/QP/AV	Corr. (dB)	Pol	RSE. or Fund.
1596.000000	38.17	74.00	35.83	Peak	-7.74	H	Spurious emission
2457.000000	81.74	114.00	32.26	Peak	-2.79	H	Fundamental
2457.000000	79.13	94.00	14.87	AV	-2.79	H	Fundamental
3496.000000	47.17	74.00	26.83	Peak	2.63	H	Spurious emission
5162.500000	47.60	74.00	26.40	Peak	3.78	H	Spurious emission

Test data 1GHz to 18GHz:
ANT+ 2 Mbps

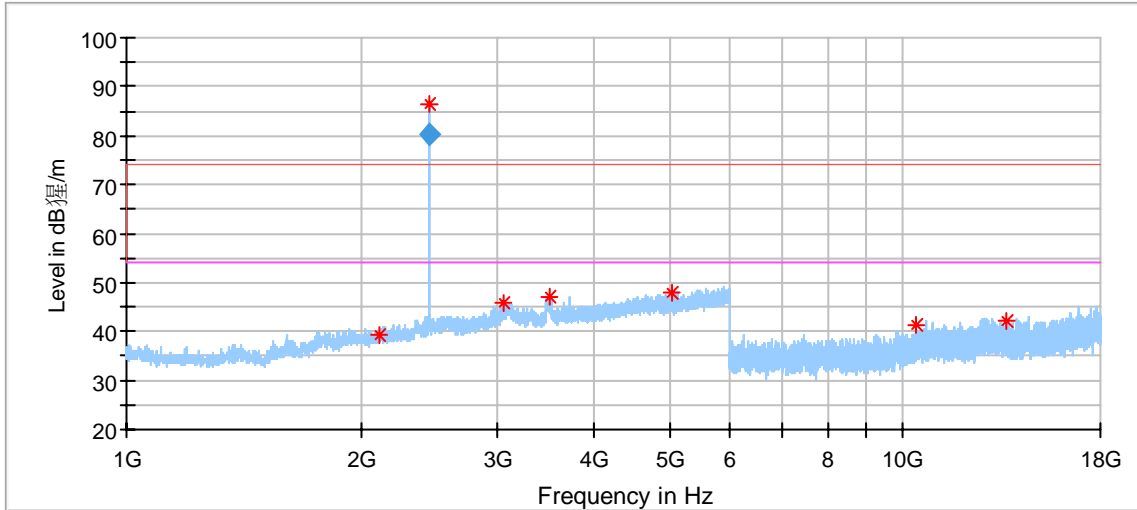

Frequency MHz	Result dBµV/m	Limit dBµV/m	Margin dB	Detector PK/QP/AV	Corr. (dB)	Pol	RSE. or Fund.
1764.500000	39.69	74.00	34.31	Peak	-6.34	V	Spurious emission
2457.000000	79.24	114.00	34.76	Peak	-2.79	V	Fundamental
2457.000000	75.07	94.00	18.93	AV	-2.79	V	Fundamental
3047.500000	45.29	74.00	28.71	Peak	0.49	V	Spurious emission
3490.500000	46.63	74.00	27.37	Peak	2.24	V	Spurious emission
4484.500000	47.03	74.00	26.97	Peak	2.27	V	Spurious emission

Remark:

- (1) Data of measurement within frequency range 9kHz-30MHz, 18-26GHz are the noise floor or attenuated more than 20dB below the permissible limits or the field strength is too small to be measured, so test data does not present in this report.
- (2) We test the operated channel only and the worst case recorded in this report.
- (3) Corrected Amplitude = Read level + Corrector factor
 Above 1GHz: Corrector factor = Antenna Factor + Cable Loss- Amplifier Gain
 Below 1GHz: Corrector factor = Antenna Factor + Cable Loss
 (The Reading Level is recorded by software which is not shown in the sheet)



10 Test Equipment List

Radiated Emission Test 1# (9kHz – 1GHz)

DESCRIPTION	MANUFACTURER	MODEL NO.	EQUIPMENT ID	SERIAL NO.	CAL. DUE DATE
EMI Test Receiver	Rohde & Schwarz	ESR 26	68-4-74-14-002	101269	2024-5-20
Trilog Super Broadband Test Antenna	Schwarzbeck	VULB 9162	68-4-80-19-003	284	2024-3-5
Loop Antenna	Rohde & Schwarz	HFH2-Z2	68-4-80-14-006	100398	2024-8-7
Pre-amplifier	Rohde & Schwarz	SCU 18F	68-4-29-19-001	100745	2024-5-19
Sideband Horn Antenna	Q-PAR	QWH-SL-18-40-K-SG	68-4-80-14-008	12827	2024-7-11
Pre-amplifier	Rohde & Schwarz	SCU 40A	68-4-29-14-002	100432	2024-8-1
Attenuator	Mini-circuits	UNAT-6+	68-4-81-21-002	15542	2024-5-19
3m Semi-anechoic chamber	TDK	SAC-3 #2	68-4-90-19-006	----	2024-5-28
Test software	Rohde & Schwarz	EMC32	68-4-90-19-006-A01	Version10.35.02	N/A

Radiated Emission 2# Test (1GHz – 40GHz)

DESCRIPTION	MANUFACTURER	MODEL NO.	EQUIPMENT ID	SERIAL NO.	CAL. DUE DATE
EMI Test Receiver	Rohde & Schwarz	ESR 26	68-4-74-14-002	101269	2024-5-20
Wave Guide Antenna	ETS	3117	68-4-80-19-001	00218954	2024-4-26
Pre-amplifier	Rohde & Schwarz	SCU 18F	68-4-29-19-002	100746	2024-5-19
Sideband Horn Antenna	Q-PAR	QWH-SL-18-40-K-SG	68-4-80-14-008	12827	2024-7-11
Pre-amplifier	Rohde & Schwarz	SCU 40A	68-4-29-14-002	100432	2024-8-1
Attenuator	Mini-circuits	UNAT-6+	68-4-81-21-002	15542	2024-5-19
3m Semi-anechoic chamber	TDK	SAC-3 #2	68-4-90-19-006	----	2024-5-28
Test software	Rohde & Schwarz	EMC32	68-4-90-19-006-A01	Version10.35.02	N/A

Conducted RF Test System

DESCRIPTION	MANUFACTURER	MODEL NO.	EQUIPMENT ID	SERIAL NO.	CAL. DUE DATE
Signal Analyzer	Rohde & Schwarz	FSV40	68-4-74-14-004	101030	2024-5-19
RF Switch Module	Rohde & Schwarz	OSP120/OSP-B157W	68-4-93-14-003	101226/100929	2024-5-20
Power Splitter	Weinschel	1580	68-4-85-14-001	SC319	2024-5-20
10dB Attenuator	Weinschel	4M-10	68-4-81-14-003	43152	2024-5-19
10dB Attenuator	R&S	DNF	68-4-81-14-004	DNF-001	2024-5-19
10dB Attenuator	R&S	DNF	68-4-81-14-005	DNF-002	2024-5-19
10dB Attenuator	R&S	DNF	68-4-81-14-006	DNF-003	2024-5-19
10dB Attenuator	R&S	DNF	68-4-81-14-007	DNF-004	2024-5-19
Test software	Tonscend	System for BT/WIFI	68-4-74-14-006-A13	Version 2.6.77.0518	N/A
Shielding Room	TDK	TS8997	68-4-90-19-003	----	2025-10-15

Conducted Emission Test

DESCRIPTION	MANUFACTURER	MODEL NO.	EQUIPMENT ID	SERIAL NO.	CAL. DUE DATE
EMI Test Receiver	Rohde & Schwarz	ESR 3	68-4-74-14-001	101782	2024-5-20
LISN	Rohde & Schwarz	ENV432	68-4-87-16-001	101318	2024-5-20
Test software	Rohde & Schwarz	EMC32	68-4-90-14-003-A10	Version9.15.00	N/A
Shielding Room	TDK	CSR #1	68-4-90-19-004	----	2025-10-15



11 System Measurement Uncertainty

For a 95% confidence level, the measurement expanded uncertainties for defined systems, in accordance with the recommendations of ISO 17025 were:

System Measurement Uncertainty	
Test Items	Extended Uncertainty
Uncertainty for Conducted Emission 150kHz-30MHz (for test using AMN ENV432 or ENV4200)	3.57dB
Uncertainty for Radiated Emission in 3m chamber 9kHz-30MHz	4.70dB
Uncertainty for Radiated Emission in new 3m chamber 30MHz-1000MHz	Horizontal: 4.59dB; Vertical: 4.75dB
Uncertainty for Radiated Emission in new 3m 1000MHz-18000MHz	Horizontal: 5.08dB; Vertical: 5.09dB;
Uncertainty for Radiated Emission 18000MHz-40000MHz	Horizontal: 4.52dB; Vertical: 4.51dB
Uncertainty for Conducted RF test	RF Power Conducted: 1.31dB Frequency test involved: 0.6×10 ⁻⁸ or 1%

Measurement Uncertainty Decision Rule:

Determination of conformity with the specification limits is based on the decision rule according to IEC Guide 115: 2023, clause 4.3.3 and 4.3.4.

---THE END OF REPORT---