



FCC / ISED – TEST REPORT

Report Number : **60.790.24.017.01R01** Date of Issue: April 9, 2024

Model/HVIN : **SBC-D10**

Product Type : **MasterMind H3**

Applicant : **Dayton Industrial Co., Ltd**

Address : **2-12 Kwai Fat Road, 11-A Kwai Chung, New Territories, Hong Kong.**

Production Facility : **KENDY ELECRTONICS (DONGGUAN) CO., LTD.**

Address : **XIN SI HUANG TANG VILLAGE HENG LI TOWN, DONGGUAN CITY, GUANGDONG, CHINA.**

Test Result : **Positive** Negative

Total pages including Appendices : **48**

Any use for advertising purposes must be granted in writing. This technical report may only be quoted in full. This report is the result of a single examination of the object in question and is not generally applicable evaluation of the quality of other products in regular production. For further details, please see testing and certification regulation, chapter A-3.4.



1 Table of Contents

1	Table of Contents	2
2	Details about the Test Laboratory	3
3	Description of the Equipment Under Test.....	4
4	Summary of Test Standards	5
5	Summary of Test Results.....	6
6	General Remarks	7
7	Test Setups	8
8	Systems Test Configuration	10
9	Technical Requirement.....	11
9.1	Conducted Emission	11
9.2	Conducted Peak Output Power & EIRP.....	14
9.3	Power Spectral Density	18
9.4	6 dB Bandwidth.....	21
9.5	99% bandwidth	24
9.6	Spurious RF Conducted Emissions	27
9.7	Band Edge.....	34
9.8	Spurious Radiated Emissions for Transmitter	37
10	Test Equipment List.....	47
11	System Measurement Uncertainty.....	48



2 Details about the Test Laboratory

Details about the Test Laboratory

Test Site 1

Company name: TÜV SÜD Certification and Testing (China) Co., Ltd. Shenzhen Branch
Building 12 & 13, Zhiheng Wisdomland Business Park, Guankou Erlu, Nantou, Nanshan District
Shenzhen 518052
P.R. China

Telephone: 86 755 8828 6998

Fax: 86 755 8828 5299

FCC Registration No.: 514049

FCC Deignation No.: CN5009

IC Registration No.: 10320A

ISED CAB Identifier: CN0077



3 Description of the Equipment Under Test

Product:	MasterMind H3
Model no.:	SBC-D10
Hardware Version Identification No. (HVIN)	SBC-D10
Product Marketing Name (PMN)	MasterMind H3
Brand name:	N/A
FCC ID:	O4GH3A
IC:	7666A-H3
Rating:	12.0 VDC (Powered by Bike Battery) Or 5.0 VDC (Powered by USB Port)
RF Transmission Frequency:	2402MHz-2480MHz
No. of Operated Channel:	40
Modulation:	GFSK
Antenna Type:	PCB Antenna
Antenna	Gain: 0 dBi
Description of the EUT:	The Equipment Under Test (EUT) is a MasterMind H3 which support Bluetooth (BLE) function and Ant+ function. Only Bluetooth Low Energy included in this report.

NOTE:

1. The above EUT's information is declared by manufacturer. Please refer to the specifications or user's manual for more detailed description.

4 Summary of Test Standards

Test Standards	
FCC Part 15 Subpart C 10-1-2021 Edition	PART 15 - RADIO FREQUENCY DEVICES Subpart C - Intentional Radiators
RSS-Gen Issue 5 April 2018 + Amendment 1 March 2019 + Amendment 2 February 2021	General Requirements for Compliance of Radio Apparatus
RSS-247 Issue 3 August 2023	Digital Transmission Systems (DTSS), Frequency Hopping Systems (FHSS) and License-Exempt Local Area Network (LE- LAN) Devices

All the test methods were according to KDB 558074 D01 15.247 Meas Guidance v05r02 Measurement Guidance and ANSI C63.10-2013.



5 Summary of Test Results

Technical Requirements						
FCC Part 15 Subpart C/ RSS-247 Issue 3 / RSS-Gen Issue 5 + A1 + A2						
Test Condition	Test Site	Test Result			Test Environment	
		Pass	Fail	N/A		
§15.207 & RSS-GEN 8.8	Conducted emission AC power port	Site 1	<input checked="" type="checkbox"/>	<input type="checkbox"/>	<input type="checkbox"/>	T: 24.8°C H: 53.7%
§15.247 (b) (3) & RSS-247 5.4(d)	Conducted peak output power	Site 1	<input checked="" type="checkbox"/>	<input type="checkbox"/>	<input type="checkbox"/>	T: 24.8°C H: 53.7%
RSS-247 5.4(d)	Equivalent Isotropic Radiated Power	Site 1	<input checked="" type="checkbox"/>	<input type="checkbox"/>	<input type="checkbox"/>	T: 24.8°C H: 53.7%
§15.247(a)(2) & RSS-247 5.2(a) & RSS-GEN 6.7	6dB bandwidth and 99% Occupied Bandwidth	Site 1	<input checked="" type="checkbox"/>	<input type="checkbox"/>	<input type="checkbox"/>	T: 24.8°C H: 53.7%
§15.247(e) & RSS-247 5.2(b)	Power spectral density	Site 1	<input checked="" type="checkbox"/>	<input type="checkbox"/>	<input type="checkbox"/>	T: 24.8°C H: 53.7%
§15.247(d) & RSS-247 5.5	Spurious RF conducted emissions	Site 1	<input checked="" type="checkbox"/>	<input type="checkbox"/>	<input type="checkbox"/>	T: 24.8°C H: 53.7%
§15.247(d) & RSS-247 5.5	Band edge	Site 1	<input checked="" type="checkbox"/>	<input type="checkbox"/>	<input type="checkbox"/>	T: 24.8°C H: 53.7%
§15.247(d) & §15.209 & §15.205 & RSS-247 5.5 & RSS-Gen 6.13	Spurious radiated emissions for transmitter	Site 1	<input checked="" type="checkbox"/>	<input type="checkbox"/>	<input type="checkbox"/>	T: 24.7°C H: 49.3%
§15.203 & RSS-Gen 6.8	Antenna requirement	See note 2	<input checked="" type="checkbox"/>	<input type="checkbox"/>	<input type="checkbox"/>	--

Note 1: N/A=Not Applicable.

Note 2: The EUT uses a PCB antenna, which gain is 0 dBi. In accordance to §15.203 & RSS-Gen 6.8, it is considered sufficiently to comply with the provisions of this section.

Note 3: T :Temperature, H: Humidity



6 General Remarks

Remarks

This submittal(s) (test report) is intended for **FCC ID: O4GH3A**, **IC: 7666A-H3**, complies with Section 15.207, 15.209, 15.247 of the FCC Part 15, Subpart C rules and RSS-247, RSS-GEN.

SUMMARY:

All tests according to the regulations cited on page 5 were

n - Performed

o - **Not** Performed

The Equipment under Test

n - **Fulfills** the general approval requirements.

o - **Does not** fulfill the general approval requirements.

Sample Received Date: March 27, 2024

Testing Start Date: March 27, 2024

Testing End Date: April 9, 2024

- TÜV SÜD Certification and Testing (China) Co., Ltd. Shenzhen Branch -

Reviewed by:

Prepared by:

Tested by:

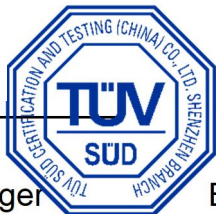

Eric LI
Section Manager

Kevin DU
EMC Project Engineer

Louise LIU
EMC Test Engineer

7 Test Setups

7.1 Radiated test setups

9kHz - 30MHz

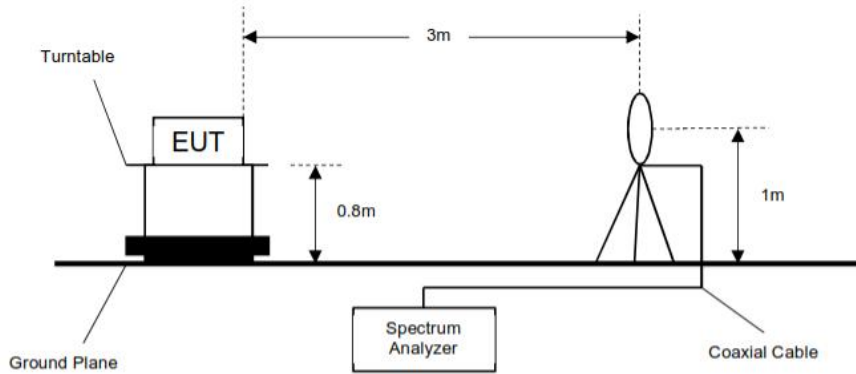

30MHz - 1GHz

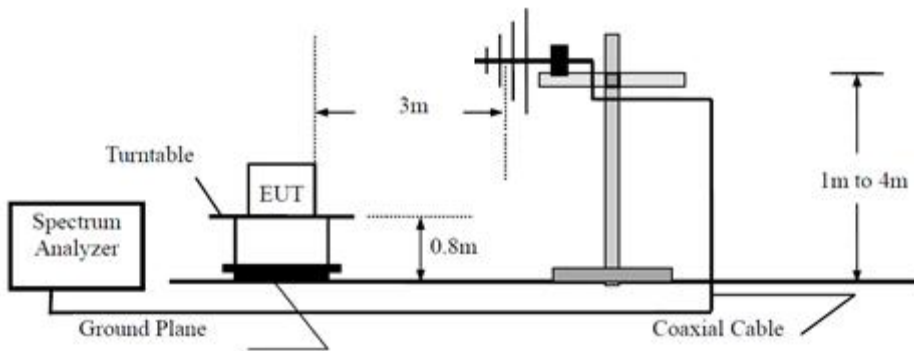

Above 1GHz

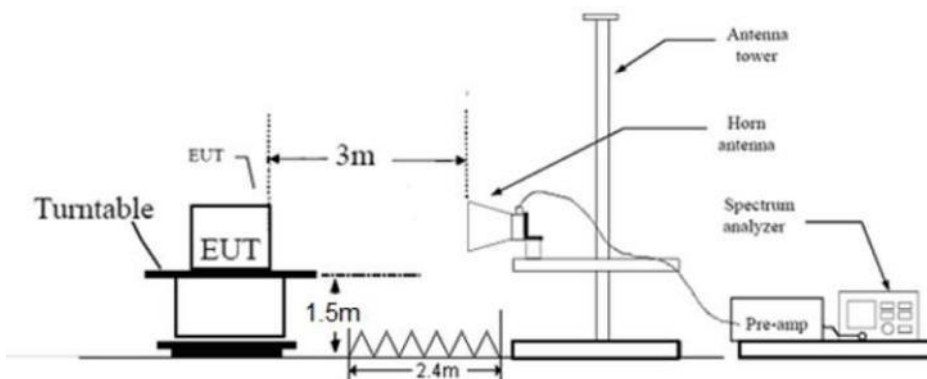

7.2 Conducted RF test setups

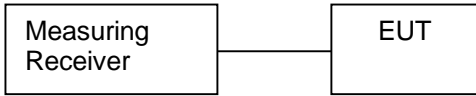

7.3 AC Power Line Conducted Emission test setups

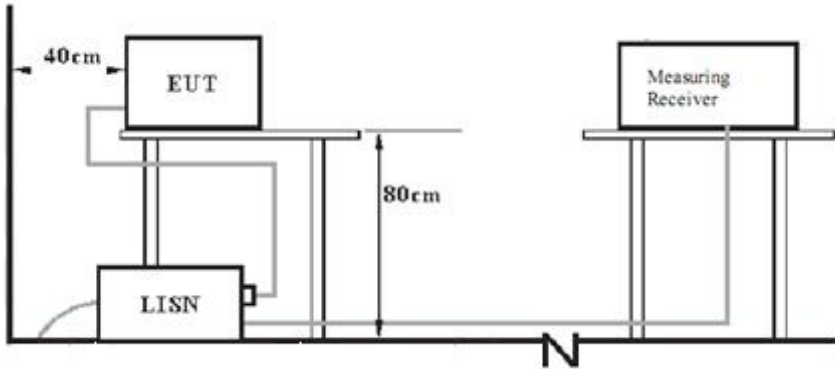

8 Systems Test Configuration

Auxiliary Equipment Used during Test:

Description	Manufacturer	Model NO.	Remark
Laptop	Lenovo	X220	0A72168
Adaptor	Apple	A1357	--
RF Test Mode Software	nRFgo	1.16	Provided by applicant

Cables Used During Test:

Cable	Length	Shielded/unshielded	With / without ferrite
---	---	---	---

The system was configured to non-hopping mode, testing channel 0, 19, 39.

Non-hopping mode: The system was configured to operate at a signal channel transmitting. The test software allows the configuration and operation at the worst-case duty and the highest transmit power.

The transmitter rate 1Mbps and 2Mbps mode are tested, only the worst case transmitter rate data mode is recorded in the report.



9 Technical Requirement

9.1 Conducted Emission

Test Method

1. The EUT was placed 0.4 meter from the conducting wall of the shielding room was kept at least 80 centimeters from any other grounded conducting surface.
2. Connect EUT to the power mains through a line impedance stabilization network (LISN).
3. All the support units are connecting to the other LISN.
4. The LISN provides 50 ohm coupling impedance for the measuring instrument.
5. Both sides of AC line were checked for maximum conducted interference.
6. The frequency range from 150 kHz to 30 MHz was searched.
7. Set the test-receiver system to Peak Detect Function and specified bandwidth (IF Bandwidth = 9kHz) with Maximum Hold Mode. Then measurement is also conducted by Average Detector and Quasi-Peak Detector Function respectively.

Limit

According to §15.207 & RSS-GEN 8.8, conducted emissions limit as below:

Frequency MHz	QP Limit dBµV	AV Limit dBµV
0.150-0.500	66-56*	56-46*
0.500-5	56	46
5-30	60	50

*Decreasing linearly with logarithm of the frequency

Conducted Emission

Product Type : MasterMind H3
 M/N : SBC-D10
 Operating Condition : Normal Working
 Test Specification : Line
 Comment : AC 120V/60Hz

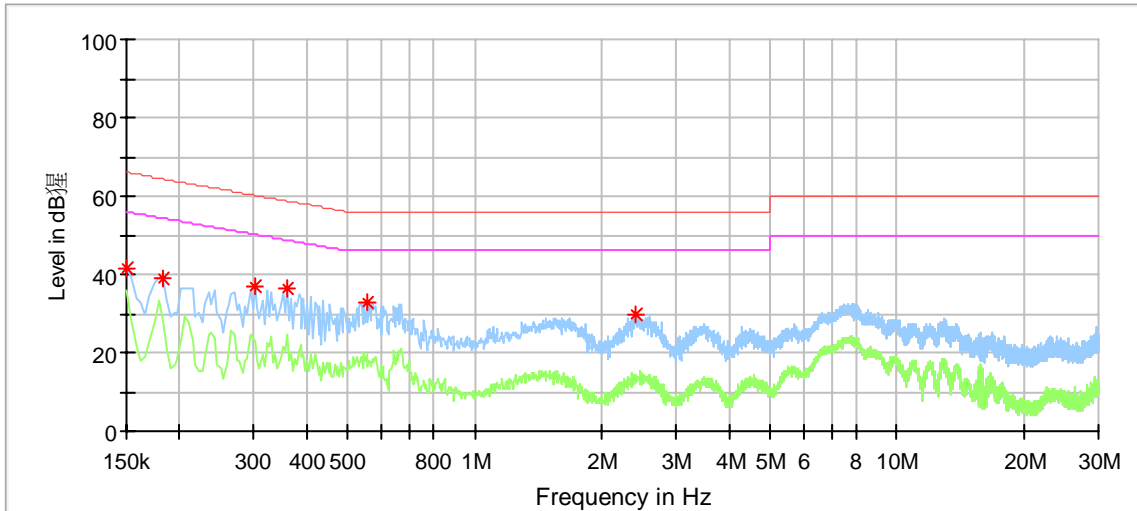

Critical_Freqs

Frequency (MHz)	MaxPeak (dBµV)	Average (dBµV)	Limit (dBµV)	Margin (dB)	Line	Corr. (dB)
0.150000	41.39	---	66.00	24.61	L1	9.52
0.182000	38.97	---	64.39	25.42	L1	9.54
0.302000	36.98	---	60.19	23.21	L1	9.57
0.358000	36.22	---	58.78	22.56	L1	9.57
0.554000	32.57	---	56.00	23.43	L1	9.60
2.418000	29.49	---	56.00	26.51	L1	9.63

Remark:

Max Peak= Read level + Corrector factor

Correct factor=cable loss + LISN factor

(The Reading Level is recorded by software which is not shown in the sheet)

Conducted Emission

Product Type : MasterMind H3
 M/N : SBC-D10
 Operating Condition : Normal Working
 Test Specification : Neutral
 Comment : AC 120V/60Hz

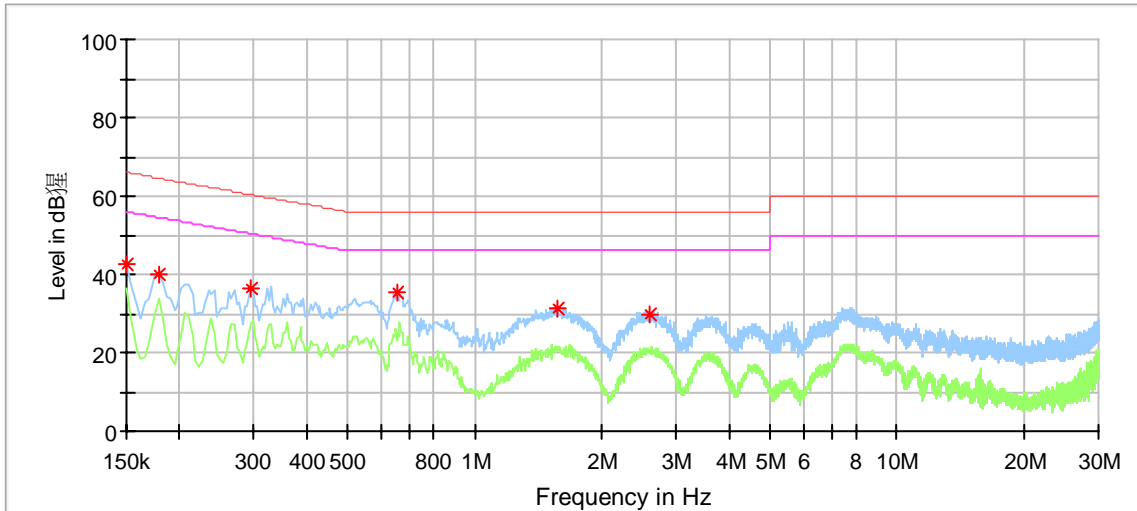

Critical_Freqs

Frequency (MHz)	MaxPeak (dBµV)	Average (dBµV)	Limit (dBµV)	Margin (dB)	Line	Corr. (dB)
0.150000	42.76	---	66.00	23.24	N	9.55
0.178000	40.01	---	64.58	24.57	N	9.57
0.294000	36.57	---	60.41	23.84	N	9.60
0.654000	35.22	---	56.00	20.78	N	9.63
1.574000	31.28	---	56.00	24.72	N	9.64
2.598000	29.86	---	56.00	26.14	N	9.67

Remark:

Max Peak= Read level + Corrector factor

Correct factor=cable loss + LISN factor

(The Reading Level is recorded by software which is not shown in the sheet)



9.2 Conducted Peak Output Power & EIRP

Test Method

1. The RF output of EUT was connected to the spectrum analyzer by RF cable. The path loss was compensated to the results for each measurement.
2. Set to the maximum power setting and enable the EUT transmit continuously.
3. Use the following test receiver settings:
Span = approximately 5 times the 6dB bandwidth, centered on a channel need to test,
RBW > the 6dB bandwidth of the emission being measured, VBW≥3RBW,
Sweep = auto, Detector function = peak, Trace = max hold
4. Allow the trace to stabilize. Use the marker-to-peak function to set the marker to the peak of the emission. The indicated level is the peak output power and record the results in the test report.
5. Repeat above procedures until all frequencies measured were complete.

Limits

According to §15.247 (b) (3) & RSS-247 5.4(d), conducted peak output power limit as below:

Frequency Range MHz	Limit W	Limit dBm
2400-2483.5	≤1	≤30

According to & RSS-247 5.4(d), EIRP limit as below:

Frequency Range MHz	Limit W	Limit dBm
2400-2483.5	≤4	≤36

Conducted Peak Output Power & EIRP

Frequency MHz	Mode	Conducted Peak Output Power dBm	Antenna Gain dBi	EIRP dBm	Result
Bottom channel 2402MHz	LE 1M	6.32	0	6.32	Pass
Middle channel 2440MHz	LE 1M	6.34	0	6.34	Pass
Top channel 2480MHz	LE 1M	5.93	0	5.93	Pass
Bottom channel 2402MHz	LE 2M	6.29	0	6.29	Pass
Middle channel 2440MHz	LE 2M	6.33	0	6.33	Pass
Top channel 2480MHz	LE 2M	5.85	0	5.85	Pass

BLE_1M_Ant1_2402

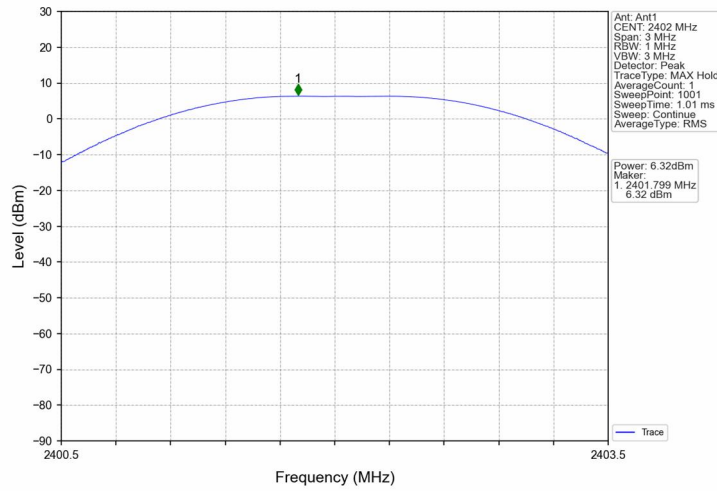

BLE_1M_Ant1_2440

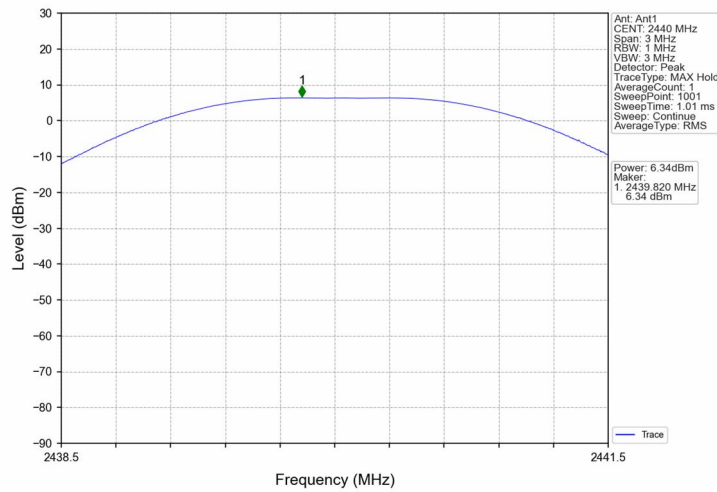

BLE_1M_Ant1_2480

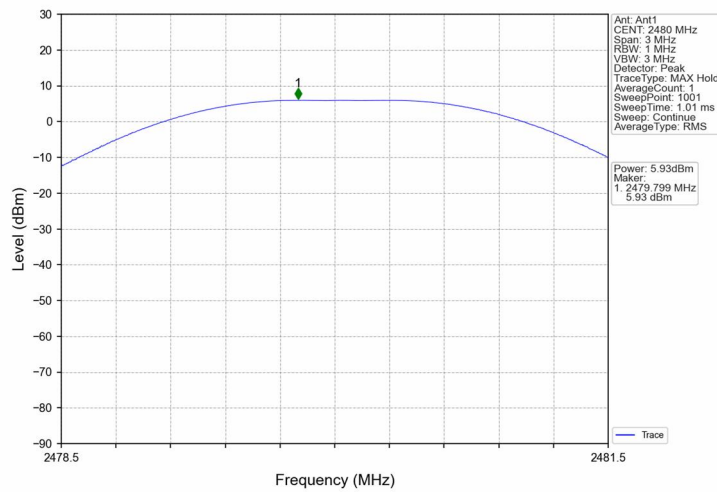

BLE_2M_Ant1_2402

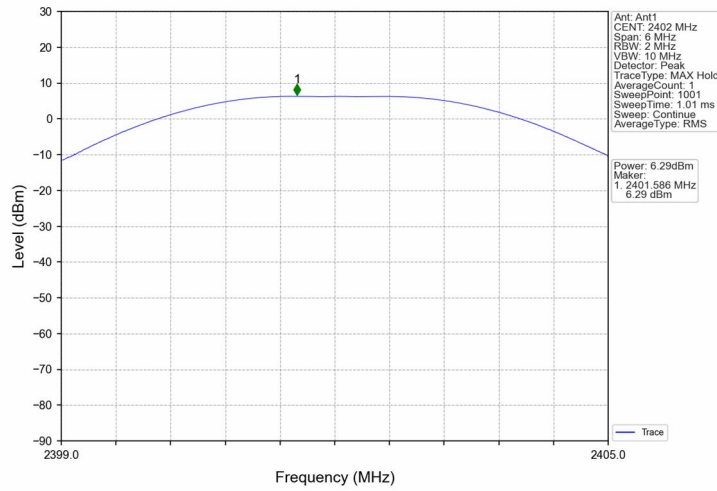

BLE_2M_Ant1_2440

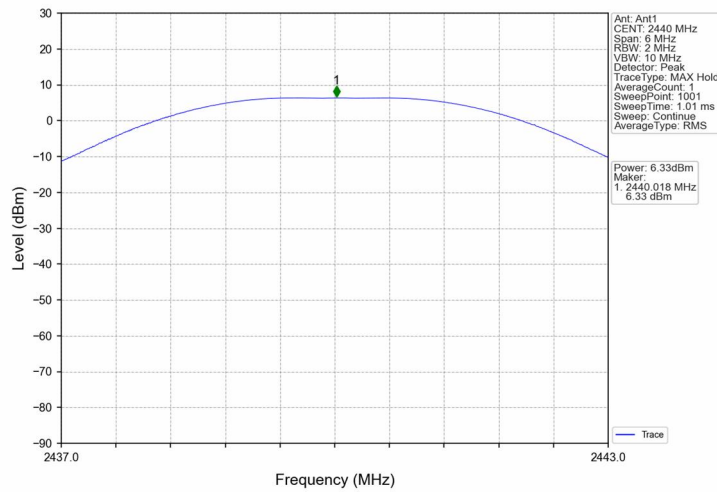

BLE_2M_Ant1_2480

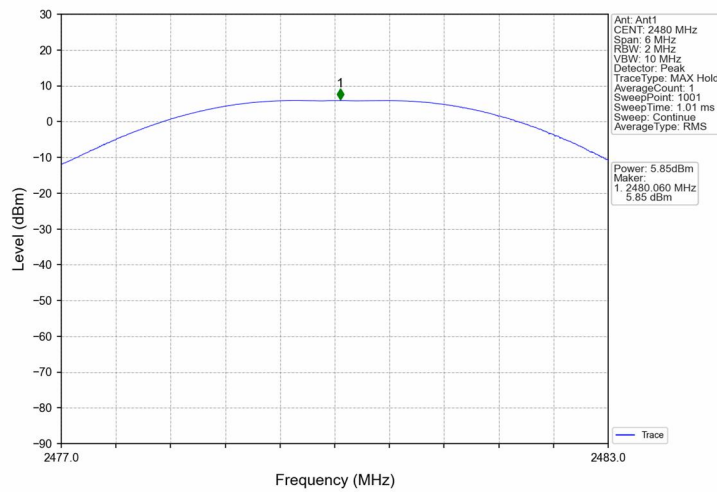



9.3 Power Spectral Density

Test Method

1. The RF output of EUT was connected to the spectrum analyzer. The path loss was compensated to the results for each measurement.
2. Set to the maximum power setting, the instrument center frequency is set to the nominal EUT channel center frequency enable the EUT transmit continuously.
3. Use the following spectrum analyzer settings:
4. Set analyzer center frequency to DTS channel center frequency. RBW=3kHz, VBW≥3RBW, Span=1.5 times DTS bandwidth, Detector=Peak, Sweep=auto, Trace= max hold.
5. Allow trace to fully stabilize, use the peak marker function to determine the maximum amplitude level within the RBW.
6. Repeat above procedures until other frequencies measured were completed.

Limit

Limit [dBm/3KHz]

≤8

Test result

Frequency MHz	Mode	Power spectral density dBm/3kHz	Result
Bottom channel 2402MHz	LE 1M	-8.86	Pass
Middle channel 2440MHz	LE 1M	-8.94	Pass
Top channel 2480MHz	LE 1M	-9.38	Pass
Bottom channel 2402MHz	LE 2M	-11.05	Pass
Middle channel 2440MHz	LE 2M	-10.89	Pass
Top channel 2480MHz	LE 2M	-11.76	Pass

Test Graphs as below:

BLE_1M_Ant0_2402

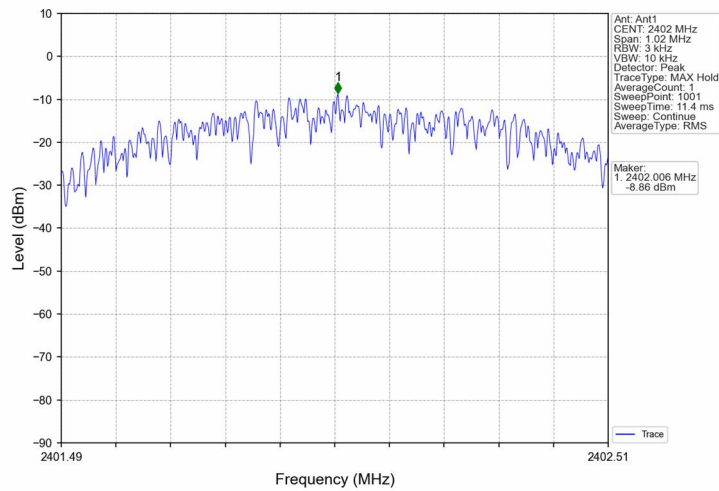

BLE_1M_Ant0_2440

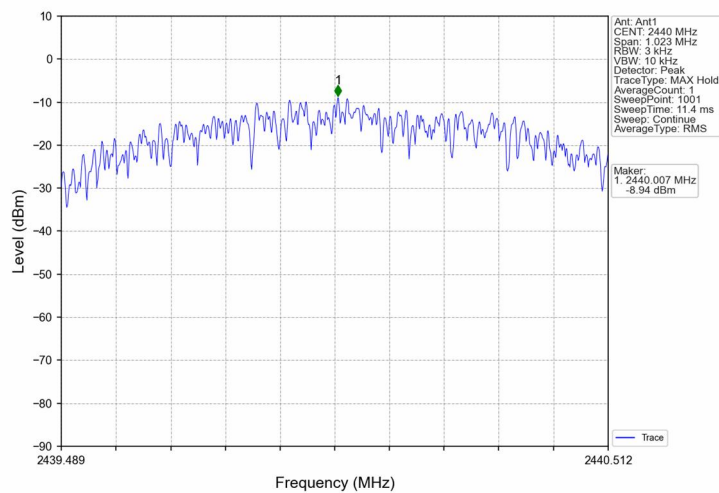

BLE_1M_Ant0_2480

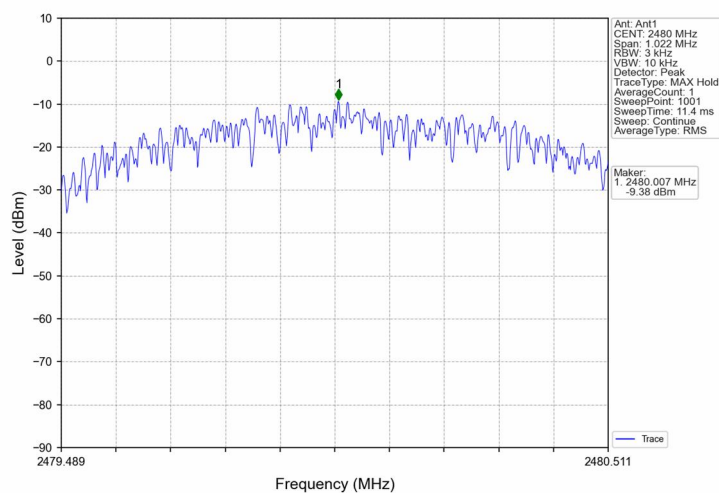

BLE_2M_Ant0_2402

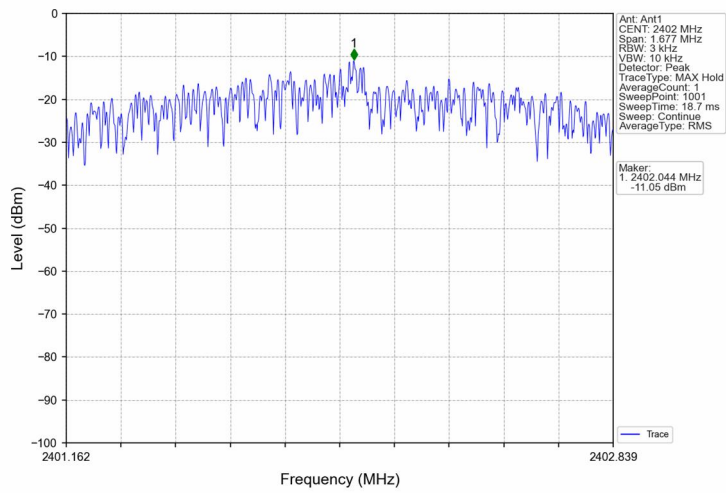

BLE_2M_Ant0_2440

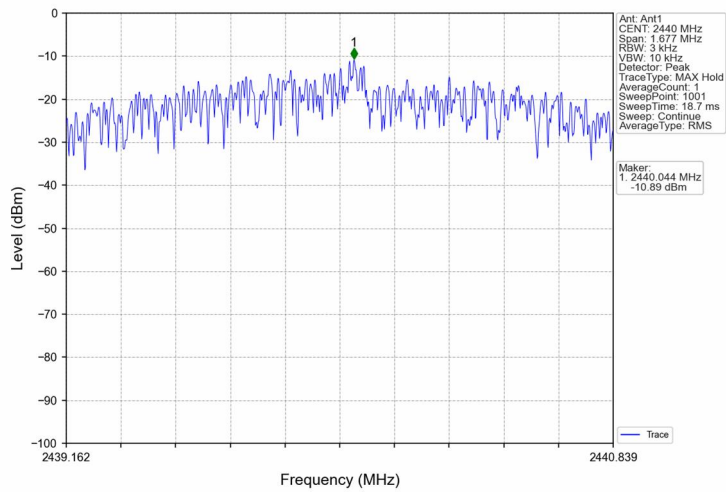

BLE_2M_Ant0_2480

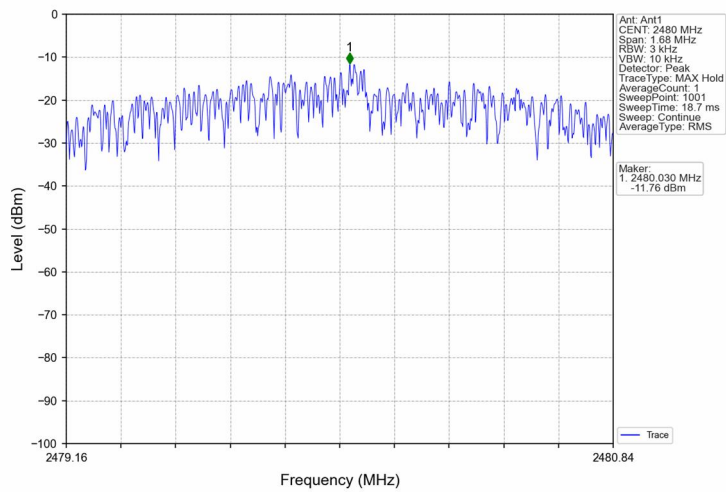



9.4 6 dB Bandwidth

Test Method

1. The RF output of EUT was connected to the spectrum analyzer. The path loss was compensated to the results for each measurement.
2. Set to the maximum power setting, the instrument center frequency is set to the nominal EUT channel center frequency enable the EUT transmit continuously.
3. Use the following spectrum analyzer settings:
RBW=100KHz, VBW≥3RBW, Sweep = auto, Detector function = peak, Trace = max hold
4. Use the automatic bandwidth measurement capability of an instrument, use the X dB bandwidth mode with X set to 6 dB.
5. Allow the trace to stabilize, record the 6 dB Bandwidth value.

Limit

Limit [kHz]

≥500

Test result

Frequency MHz	Mode	6dB bandwidth MHz	Result
Bottom channel 2402MHz	LE 1M	0.680	Pass
Middle channel 2440MHz	LE 1M	0.682	Pass
Top channel 2480MHz	LE 1M	0.681	Pass
Bottom channel 2402MHz	LE 2M	1.118	Pass
Middle channel 2440MHz	LE 2M	1.118	Pass
Top channel 2480MHz	LE 2M	1.120	Pass

Test Graphs as below:

BLE_1M_Ant0_2402

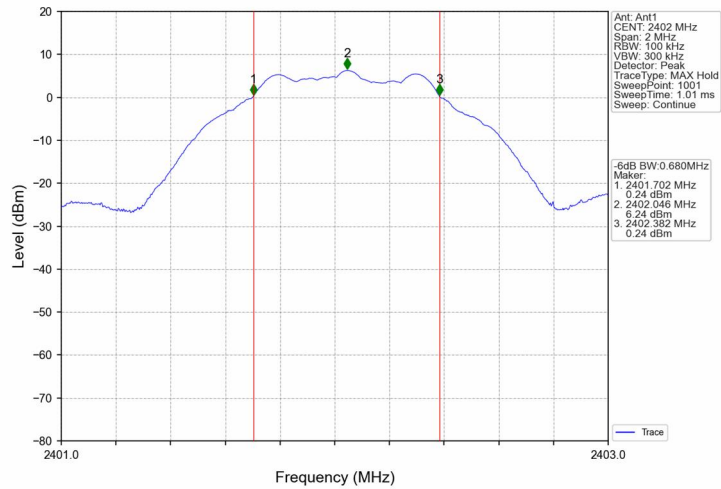

BLE_1M_Ant0_2440

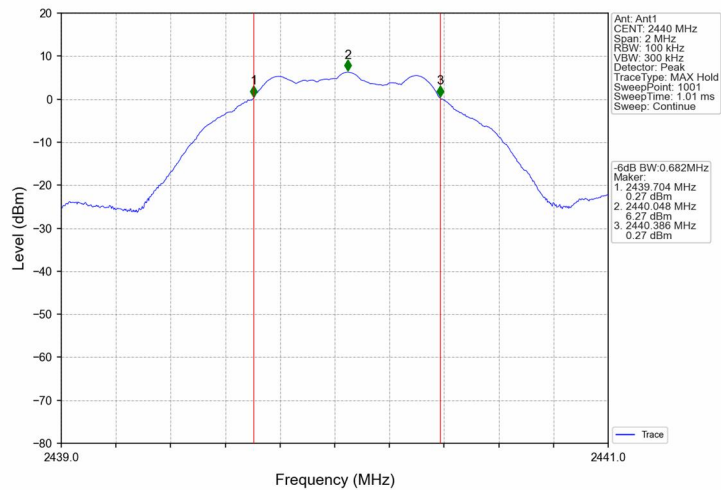

BLE_1M_Ant0_2480

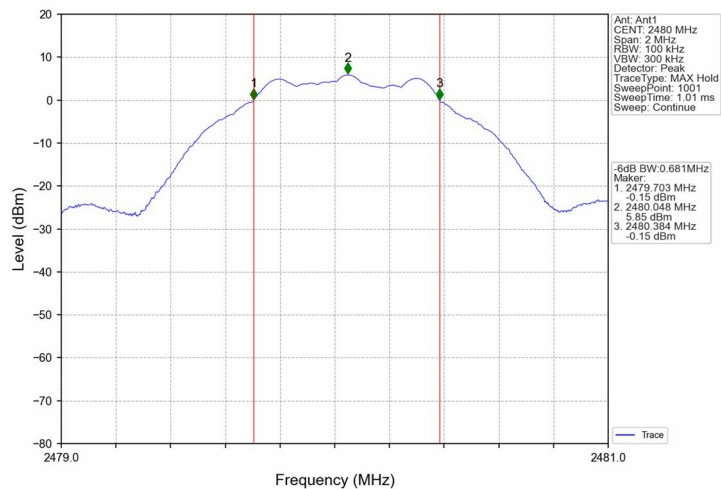

BLE_2M_Ant0_2402

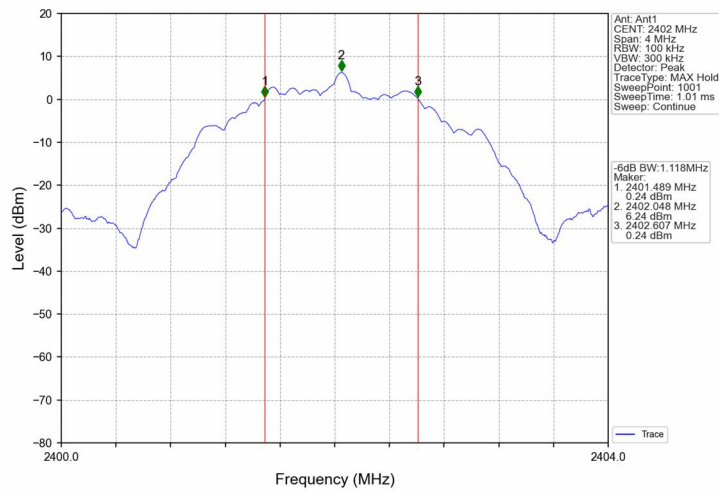

BLE_2M_Ant0_2440

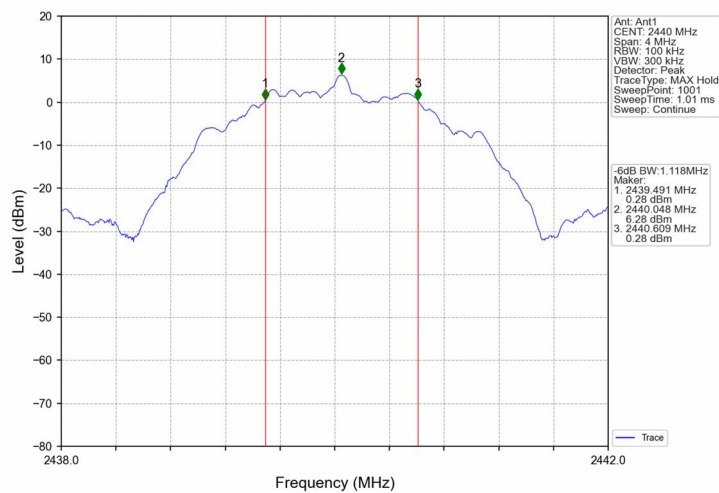

BLE_2M_Ant0_2480

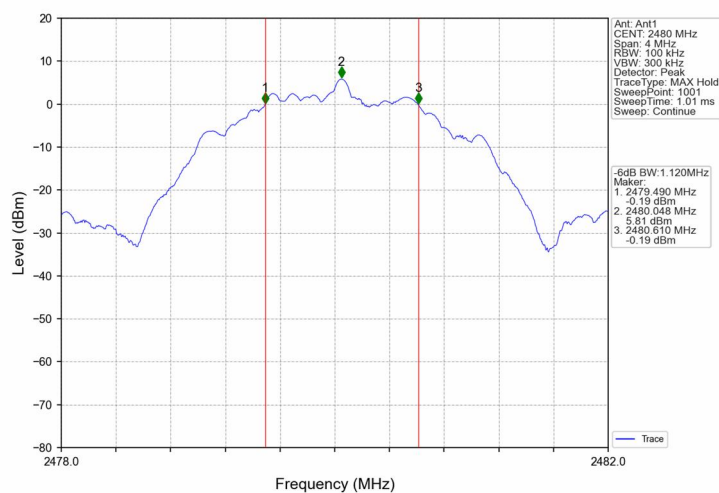



9.5 99% bandwidth

Test Method

1. Set center frequency to the nominal EUT channel center frequency
2. Set span = 1.5 times to 5.0 times the OBW. Set RBW = 1 % to 5 % of the OBW
Set VBW ≥ 3 RBW Trace mode = max hold. Sweep = auto couple.
Allow the trace to stabilize.
3. Use the 99 % power bandwidth function of the instrument.
4. Record the results in the test report.

Limit

Limit [kHz]

--

Test result

Frequency MHz	Mode	99% bandwidth MHz	Result
Bottom channel 2402MHz	LE 1M	1.041	Pass
Middle channel 2440MHz	LE 1M	1.045	Pass
Top channel 2480MHz	LE 1M	1.045	Pass
Bottom channel 2402MHz	LE 2M	2.078	Pass
Middle channel 2440MHz	LE 2M	2.087	Pass
Top channel 2480MHz	LE 2M	2.085	Pass

Test Graphs as below:

BLE_1M_Ant0_2402

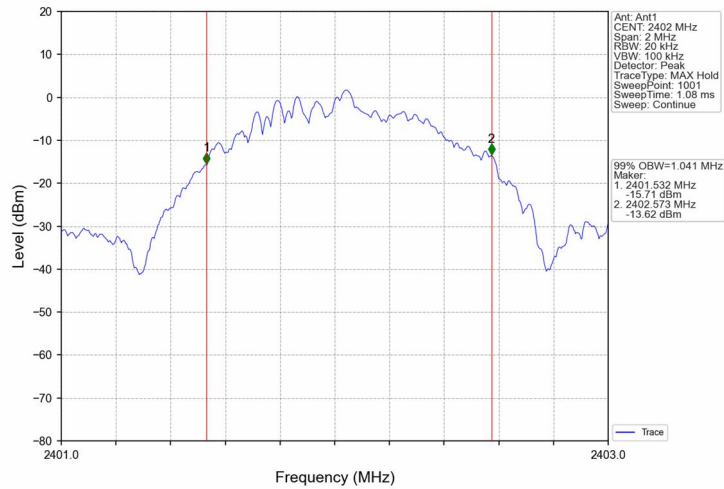

BLE_1M_Ant0_2440

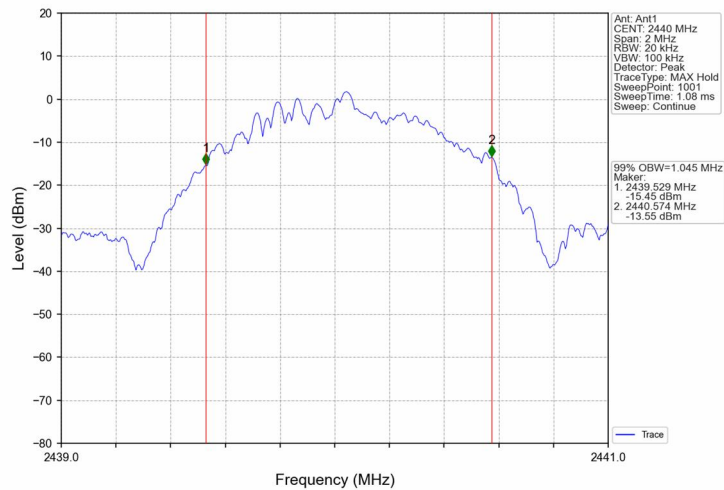

BLE_1M_Ant0_2480

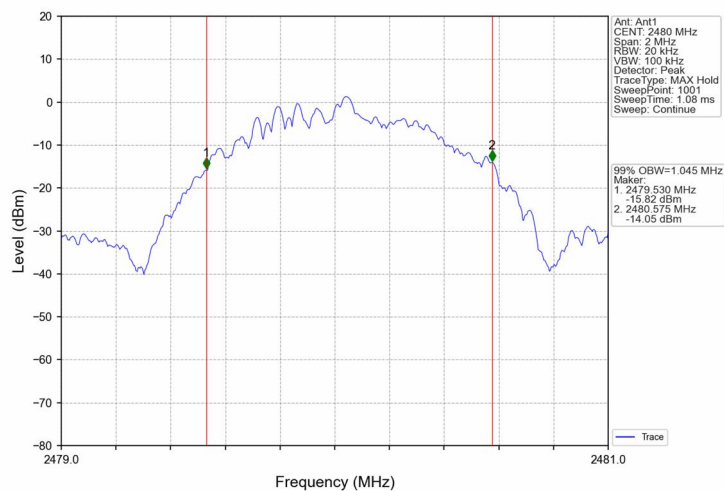

BLE_2M_Ant0_2402

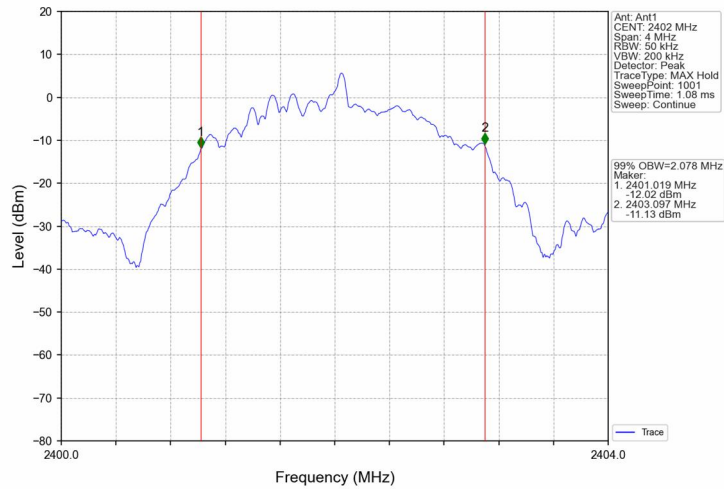

BLE_2M_Ant0_2440

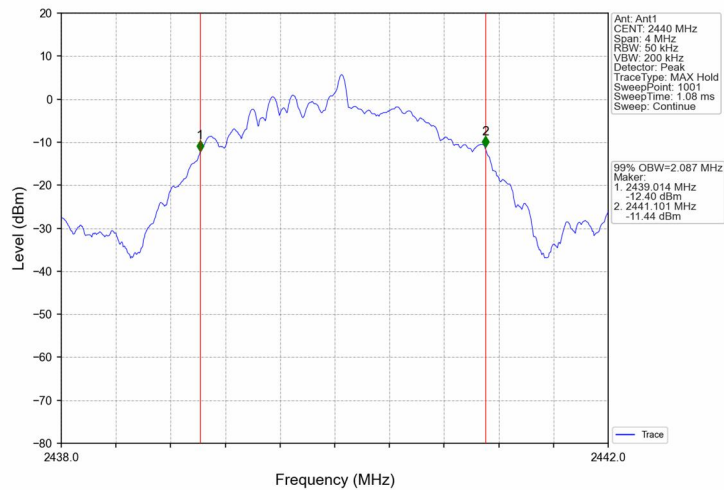

BLE_2M_Ant0_2480

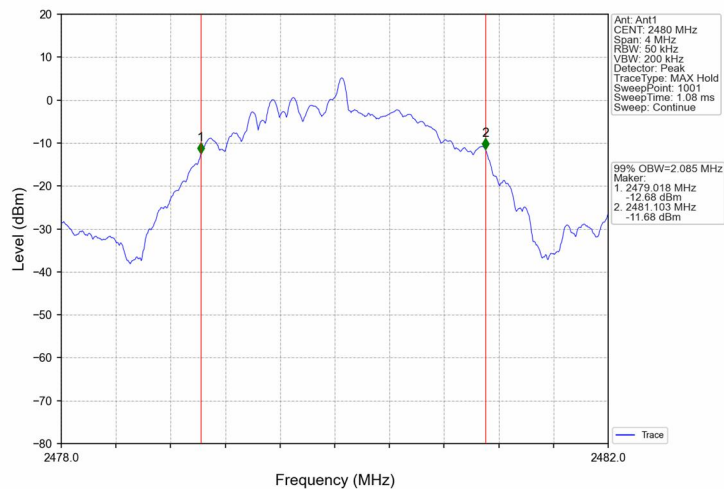



9.6 Spurious RF Conducted Emissions

Test Method

1. The RF output of EUT was connected to the spectrum analyzer by RF cable. The path loss was compensated to the results for each measurement.
2. Set to the maximum power setting, the instrument center frequency is set to the nominal EUT channel center frequency enable the EUT transmit continuously.
3. Use the following spectrum analyzer settings:
Span = wide enough to capture the peak level of the in-band emission and all spurious emissions (e.g., harmonics) from the lowest frequency generated in the EUT up through the 10th harmonic. Typically, several plots are required to cover this entire span.
RBW = 100 kHz, VBW≥3RBW, Sweep = auto, Detector function = peak, Trace = max hold
4. Allow the trace to stabilize. Set the marker on the peak of any spurious emission recorded.
5. The level displayed must comply with the limit specified in this Section. Submit these plots.
6. Repeat above procedures until all frequencies measured were complete.

Limit

Frequency Range MHz	Limit (dBc)
30-25000	-20

Test result

Test Mode	Antenna	Channel (MHz)	Frequency Range (MHz)	Reference Level (dBm)	Result (dBm)	Limit (dBm)	Verdict
BLE_1M	Ant0	2402	30~26500	6.24	-53.62	-13.76	PASS
		2440	30~26500	6.27	-54.17	-13.73	PASS
		2480	30~26500	5.86	-54.15	-14.14	PASS
BLE_2M	Ant0	2402	30~26500	6.21	-52.08	-13.79	PASS
		2440	30~26500	6.26	-50.39	-13.74	PASS
		2480	30~26500	5.78	-52.33	-14.22	PASS

Remark: - The emissions exceed limit is fundamental signal.

Test Graphs as below:

1M_LCH_2402MHz_Ant1_NTNV Reference

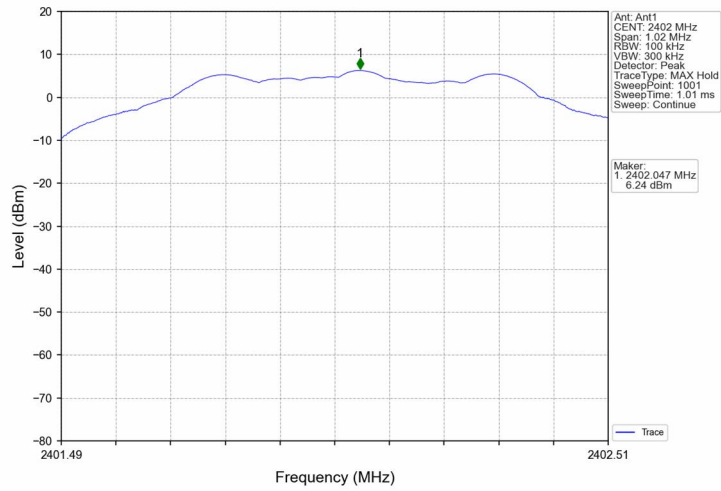

1M_LCH_2402MHz_Ant1_NTNV

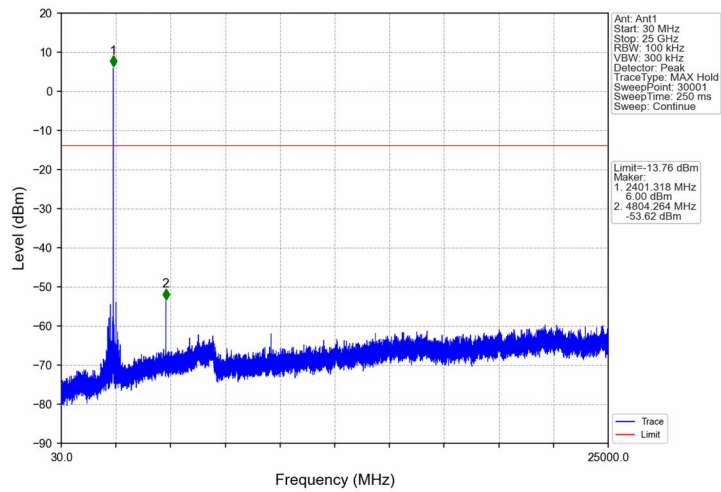

1M_MCH_2440MHz_Ant1_NTNV Reference

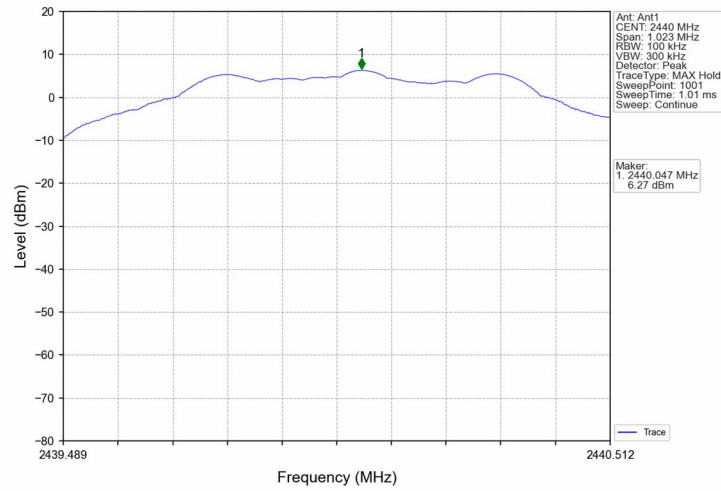

1M_MCH_2440MHz_Ant1_NTNV

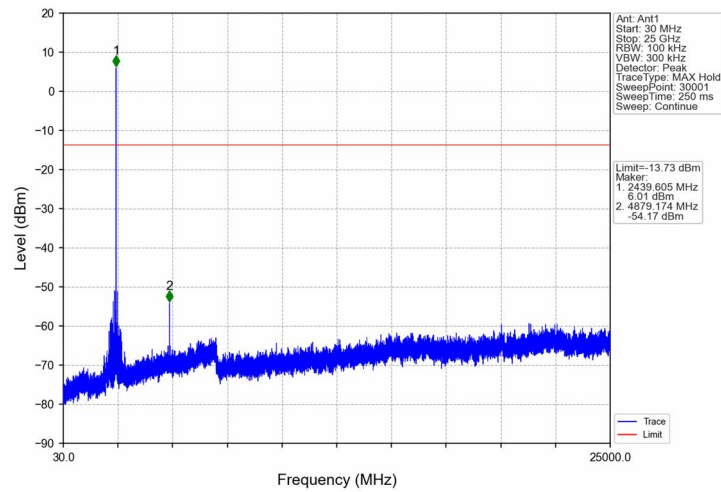

1M_HCH_2480MHz_Ant1_NTNV Reference

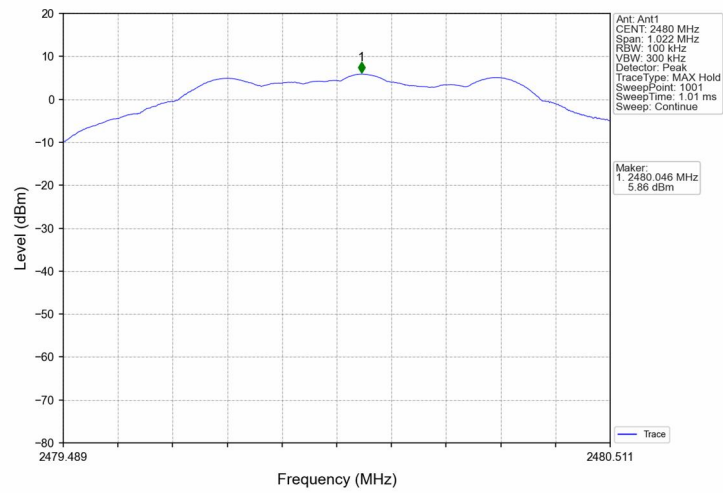

1M_HCH_2480MHz_Ant1_NTNV

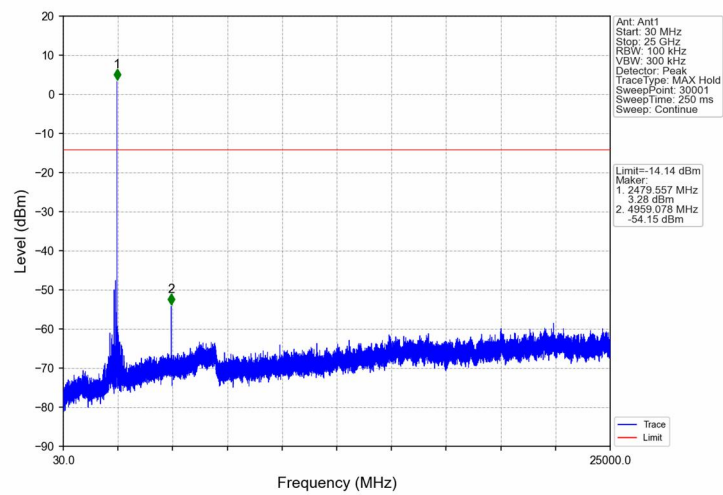

2M_LCH_2402MHz_Ant1_NTNV Reference

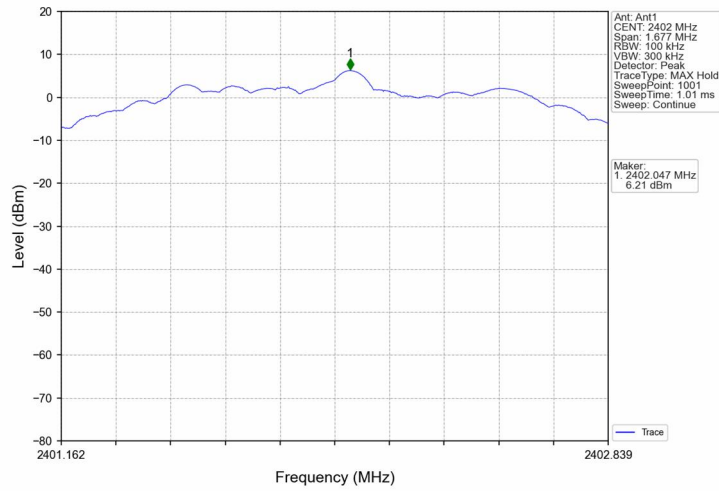

2M_LCH_2402MHz_Ant1_NTNV

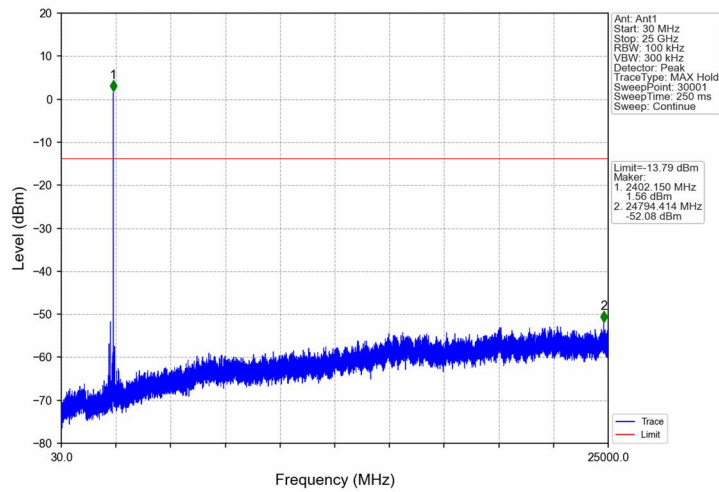

2M_MCH_2440MHz_Ant1_NTNV Reference

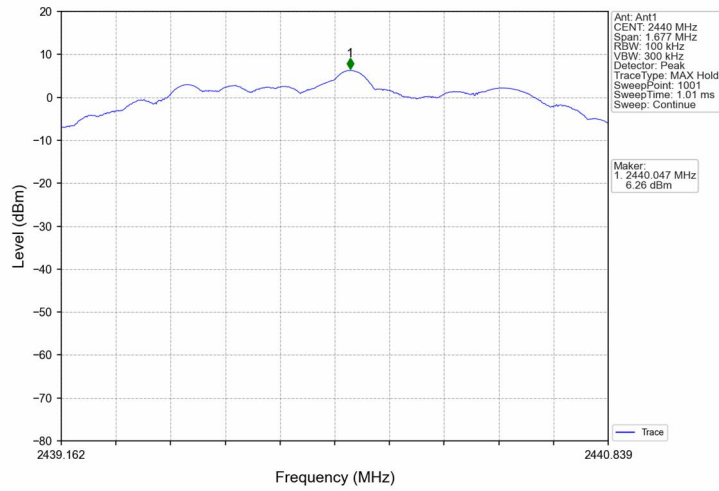

2M_MCH_2440MHz_Ant1_NTNV

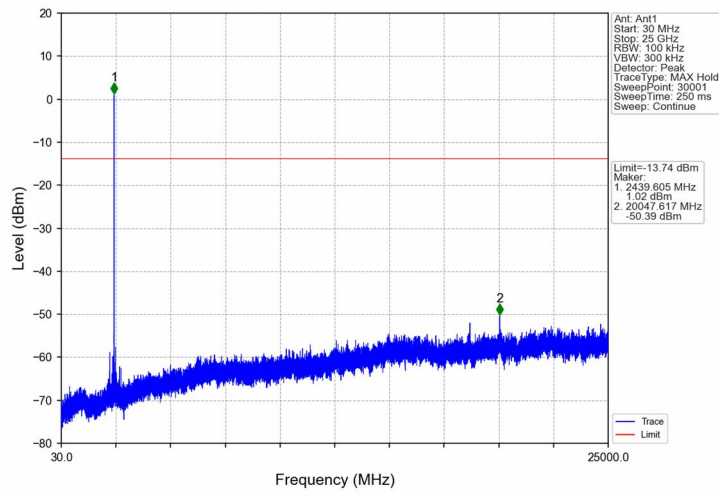

2M_HCH_2480MHz_Ant1_NTNV Reference

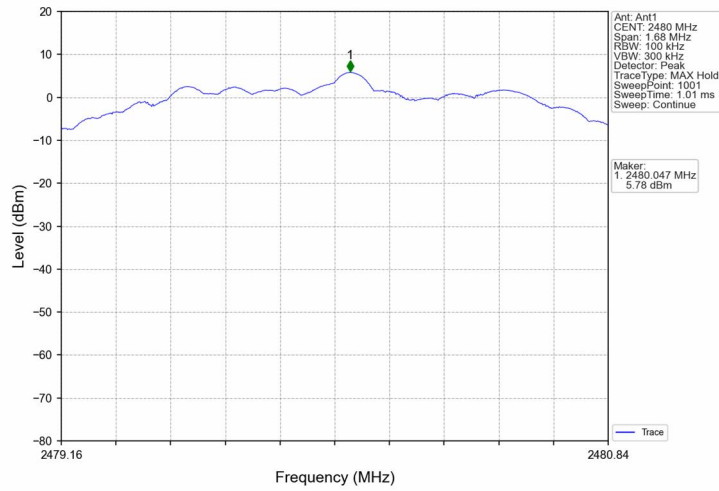

2M_HCH_2480MHz_Ant1_NTNV

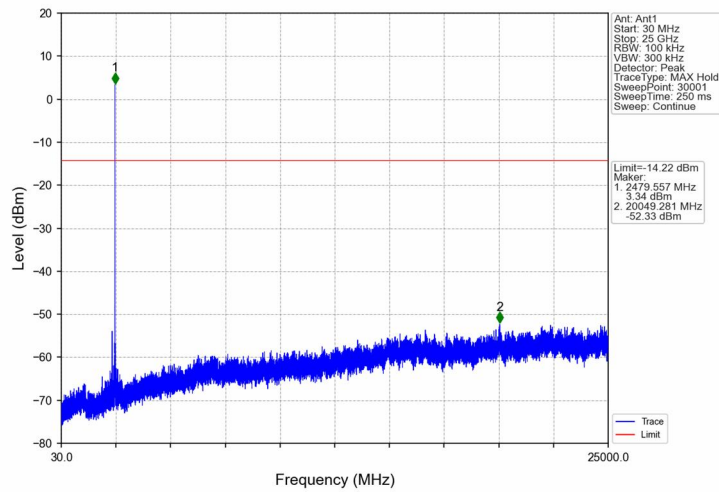



9.7 Band Edge

Test Method

1. The RF output of EUT was connected to the spectrum analyzer by RF cable. The path loss was compensated to the results for each measurement.
2. Set to the maximum power setting, the instrument center frequency is set to the nominal EUT channel center frequency enable the EUT transmit continuously.
3. Use the following spectrum analyzer settings:
Span = wide enough to capture the peak level of the in-band emission and all spurious
RBW = 100 kHz, VBW ≥ 3RBW, Sweep = auto, Detector function = peak, Trace = max hold
4. Allow the trace to stabilize, use the peak and delta measurement to record the result.
5. The level displayed must comply with the limit specified in this Section.
6. Repeat above procedures until all frequencies measured were complete and submit all the plots.

Limit:

In any 100 kHz bandwidth outside the frequency band in which the spread spectrum or digitally modulated device is operating, the RF power that is produced shall be at least 20 dB below that in the 100 kHz bandwidth within the band that contains the highest level of the desired power, based on either an RF conducted or a radiated measurement, provided that the transmitter demonstrates compliance with the peak conducted power limits. If the transmitter complies with the conducted power limits based on the use of RMS averaging over a time interval, as permitted under § 15.247(b)(3) and RSS-247 section 5.4(d), the attenuation required shall be 30 dB instead of 20 dB.

Frequency Range MHz	Limit (dBc)
30-25000	-20

Test result

Test Mode	Antenna	Channel	Channel (MHz)	Reference Level (dBm)	Result (dBm)	Limit (dBm)	Verdict
BLE_1M	Ant0	Low	2402	6.24	-48.94	≤ -13.76	PASS
		High	2480	5.86	-56.87	≤ -14.14	PASS
BLE_2M	Ant0	Low	2402	6.21	-27.52	≤ -13.79	PASS
		High	2480	5.78	-49.18	≤ -14.22	PASS

Test Graphs as below:

1M_LCH_2402MHz_Ant1_NTNV

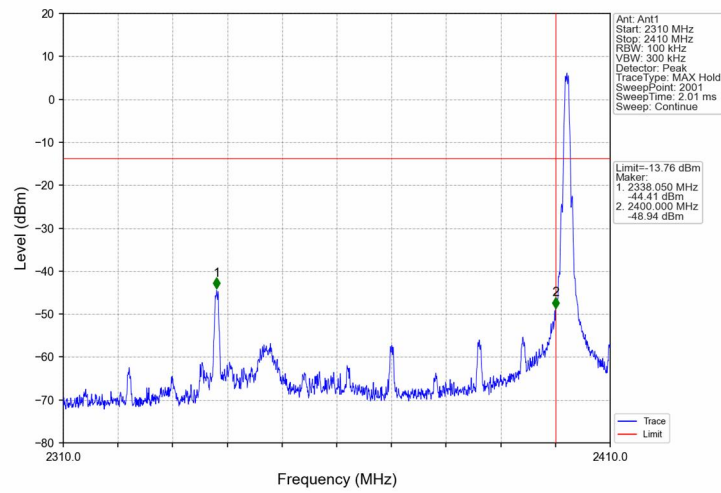

1M_HCH_2480MHz_Ant1_NTNV

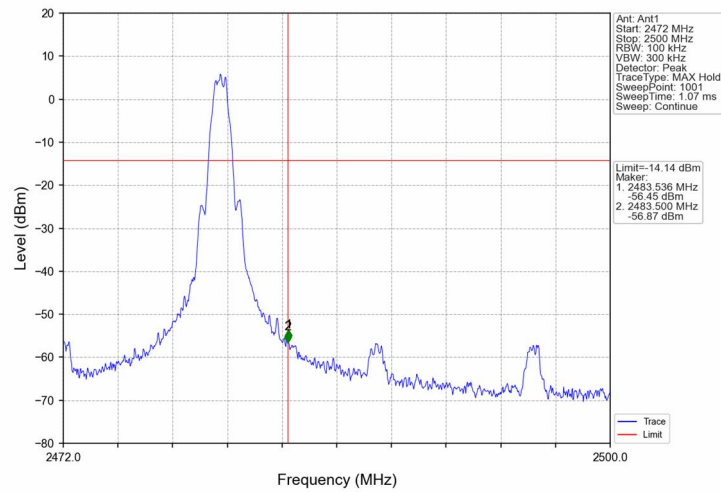

2M_LCH_2402MHz_Ant1_NTNV

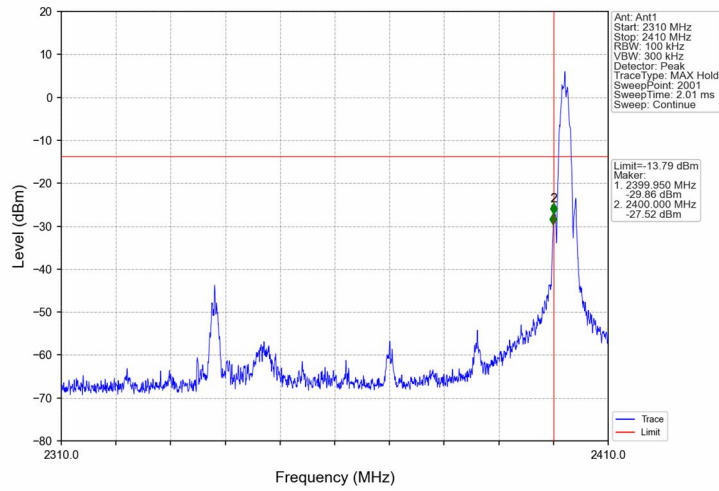

2M_HCH_2480MHz_Ant1_NTNV

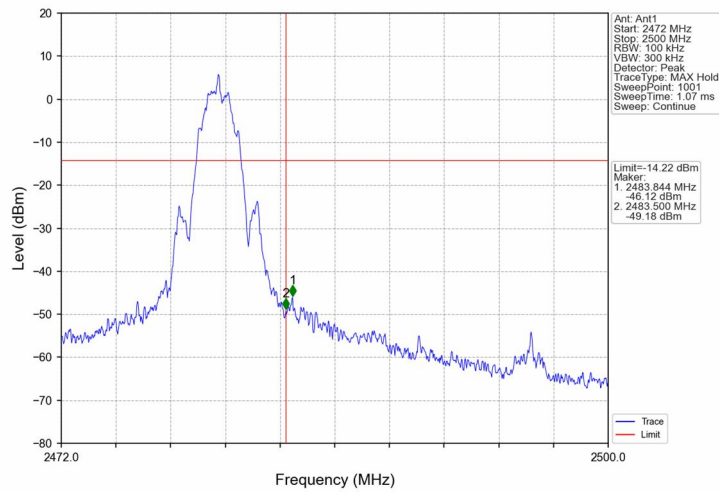

9.8 Spurious Radiated Emissions for Transmitter

Test Method

1. The EUT was placed on a turn table which is 1.5m above ground plane for above 1GHz and 0.8m above ground for below 1GHz at 3 meter chamber room for test. The table was rotated 360 degrees to determine the position of the highest radiation.
2. The EUT was set 3 meters away from the interference – receiving antenna, which was mounted on the top of a variable – height antenna tower.
3. The height of antenna is varied from one meter to four meters above the ground to determine the maximum value of the field strength. Both horizontal and vertical polarizations of the antenna are set to make the measurement.
4. For each suspected emission, the EUT was arranged to its worst case and then the antenna was tuned to heights from 1 meter to 4 meters and the rotatable table was turned from 0 degrees to 360 degrees to find the maximum reading.
5. Use the following spectrum analyzer settings According to C63.10:

Procedure for Unwanted Emissions Measurements Below 1000 MHz

Span = wide enough to capture the peak level of the in-band emission and all spurious
 RBW = 100 KHz to 120KHz, VBW ≥ RBW for peak measurement, Sweep = auto, Detector function = peak, Trace = max hold.

For Peak unwanted emissions Above 1GHz:

Span = wide enough to capture the peak level of the in-band emission and all spurious
 RBW = 1MHz, VBW ≥ RBW for peak measurement, Sweep = auto, Detector function = peak, Trace = max hold.

Procedures for average unwanted emissions measurements above 1000 MHz

- a) RBW = 1MHz.
- b) VBW \ [3 × RBW].
- c) Detector = RMS (power averaging), if [span / (# of points in sweep)] \ RBW / 2. Satisfying this condition can require increasing the number of points in the sweep or reducing the span. If the condition is not satisfied, then the detector mode shall be set to peak.
- d) Averaging type = power (i.e., rms) (As an alternative, the detector and averaging type may be set for linear voltage averaging. Some instruments require linear display mode to use linear voltage averaging. Log or dB averaging shall not be used.)
- e) Sweep time = auto.
- f) Perform a trace average of at least 100 traces if the transmission is continuous. If the transmission is not continuous, then the number of traces shall be increased by a factor of 1 / D, where D is the duty cycle. For example, with 50% duty cycle, at least 200 traces shall be averaged. (If a specific emission is demonstrated to be continuous—i.e., 100% duty cycle—then rather than turning ON and OFF with the transmit cycle, at least 100 traces shall be averaged.)
- g) If tests are performed with the EUT transmitting at a duty cycle less than 98%, then a correction factor shall be added to the measurement results prior to comparing with the emission limit, to compute the emission level that would have been measured had the test been performed at 100% duty cycle. The correction factor is computed as follows:



- 1) If power averaging (rms) mode was used in the preceding step e), then the correction factor is $[10 \log (1 / D)]$, where D is the duty cycle. For example, if the transmit duty cycle was 50%, then 3 dB shall be added to the measured emission levels.
- 2) If linear voltage averaging mode was used in the preceding step e), then the correction factor is $[20 \log (1 / D)]$, where D is the duty cycle. For example, if the transmit duty cycle was 50%, then 6 dB shall be added to the measured emission levels.
- 3) If a specific emission is demonstrated to be continuous (100% duty cycle) rather than turning ON and OFF with the transmit cycle, then no duty cycle correction is required for that emission(AV) at frequency above 1GHz.

Limit

In any 100 kHz bandwidth outside the frequency band in which the spread spectrum or digitally modulated device is operating, the RF power that is produced shall be at least 20 dB below that in the 100 kHz bandwidth within the band that contains the highest level of the desired power, based on either an RF conducted or a radiated measurement, provided that the transmitter demonstrates compliance with the peak conducted power limits. If the transmitter complies with the conducted power limits based on the use of RMS averaging over a time interval, as permitted under § 15.247(b)(3) and RSS 247 section 5.4(d), the attenuation required shall be 30 dB instead of 20 dB. Attenuation below the general field strength limits specified in § 15.209(a) and RSS-Gen is not required. In addition, radiated emissions which fall in the restricted bands, as defined in § 15.205(a) and RSS-Gen section 8.9, must also comply with the radiated emission limits specified in § 15.209(a) and RSS-Gen section 8.10.

Frequency MHz	Field Strength µV/m	Field Strength dBµV/m	Detector	Measurement distance meters
0.009-0.490	2400/F(kHz)	48.5-13.8	AV	300
0.490-1.705	24000/F(kHz)	33.8-23.0	QP	30
1.705-30	30	29.5	QP	30
30-88	100	40	QP	3
88-216	150	43.5	QP	3
216-960	200	46	QP	3
960-1000	500	54	QP	3
Above 1000	500	54	AV	3
Above 1000	5000	74	PK	3

Note 1: Limit 3m(dBµV/m)=Limit 300m(dBµV/m)+40Log(300m/3m) (Below 30MHz)

Note 2: Limit 3m(dBµV/m)=Limit 30m(dBµV/m)+40Log(30m/3m) (Below 30MHz)

Spurious radiated emissions for transmitter

According to C63.10, if the peak (or quasi-peak) measured value complies with the average limit, it is unnecessary to perform an average measurement, so AV emission value did not show in below table if the peak value complies with average limit.

The only worse case (1 Mbps) test result is listed in the report.

Transmitting spurious emission test result as below:

Test data_30MHz to 1000MHz
BLE_1Mbps:

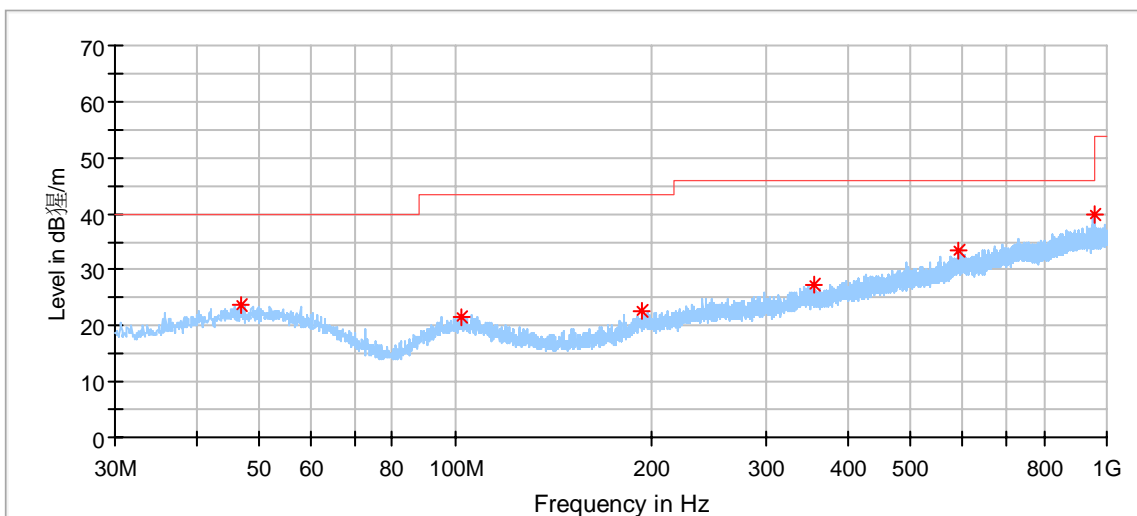

Critical_Freqs

Frequency (MHz)	MaxPeak (dBµV/m)	Limit (dBµV/m)	Margin (dB)	Height (cm)	Pol	Azimuth (deg)	Corr. (dB/m)
46.759444	23.72	40.00	16.28	200.0	H	76.0	18.33
101.887778	21.69	43.50	21.81	200.0	H	3.0	15.92
193.229444	22.64	43.50	20.86	200.0	H	149.0	15.85
355.596667	27.41	46.00	18.59	200.0	H	61.0	19.47
591.360556	33.29	46.00	12.71	100.0	H	141.0	24.59
958.343889	40.00	46.00	6.00	100.0	H	77.0	29.15

Test data_30MHz to 1000MHz
BLE_1Mbps:

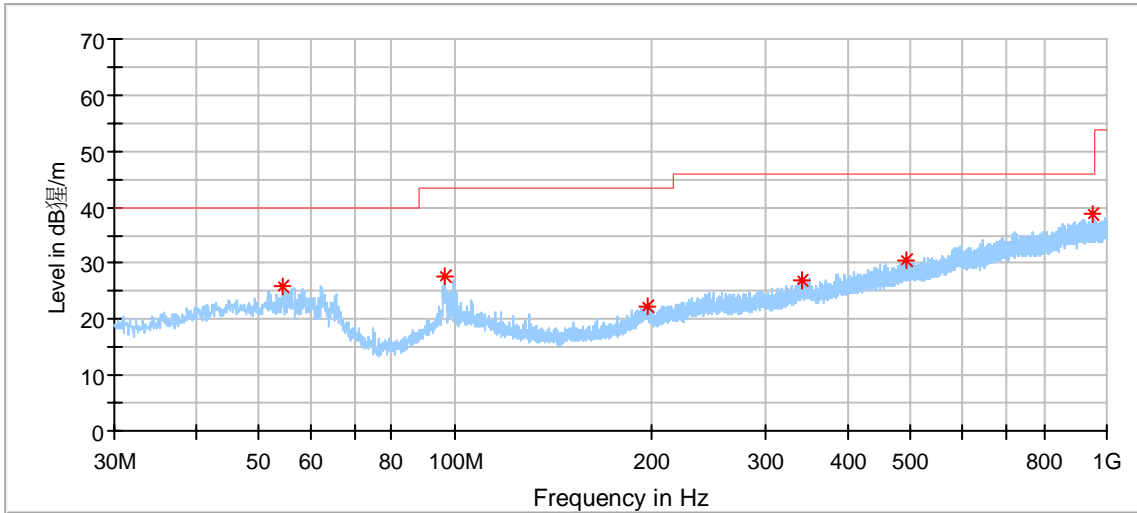

Critical_Freqs

Frequency (MHz)	MaxPeak (dBµV/m)	Limit (dBµV/m)	Margin (dB)	Height (cm)	Pol	Azimuth (deg)	Corr. (dB/m)
54.357778	25.92	40.00	14.08	100.0	V	262.0	17.87
96.768333	27.58	43.50	15.92	100.0	V	0.0	15.47
198.133333	22.08	43.50	21.42	100.0	V	262.0	15.92
341.585556	26.75	46.00	19.25	200.0	V	185.0	19.61
491.504444	30.37	46.00	15.63	200.0	V	71.0	22.59
953.709444	38.65	46.00	7.35	100.0	V	218.0	29.10

Test data 1GHz to 18GHz:
BLE_1Mbps_Low Channel:

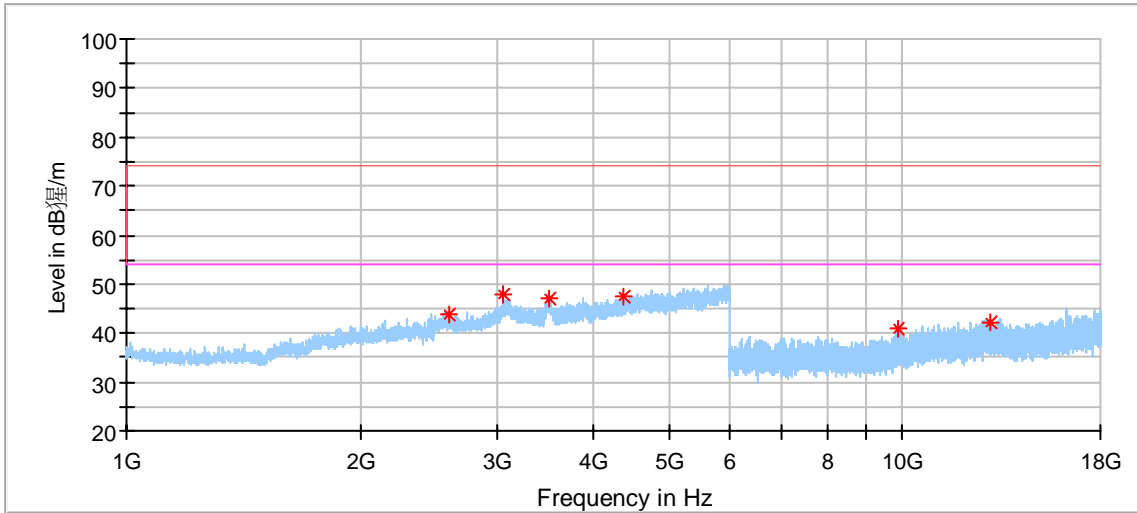

Critical_Freqs

Frequency (MHz)	MaxPeak (dBµV/m)	Limit (dBµV/m)	Margin (dB)	Height (cm)	Pol	Azimuth (deg)	Corr. (dB/m)
2601.000000	43.97	74.00	30.03	150.0	H	48.0	-1.35
3062.000000	47.82	74.00	26.18	150.0	H	34.0	1.35
3511.000000	47.23	74.00	26.77	150.0	H	0.0	3.14
4379.500000	47.48	74.00	26.52	150.0	H	280.0	2.86
9859.500000	40.87	74.00	33.13	150.0	H	325.0	8.35
12998.000000	42.09	74.00	31.91	150.0	H	192.0	11.83

Test data 1GHz to 18GHz:
BLE_1Mbps_Low Channel:

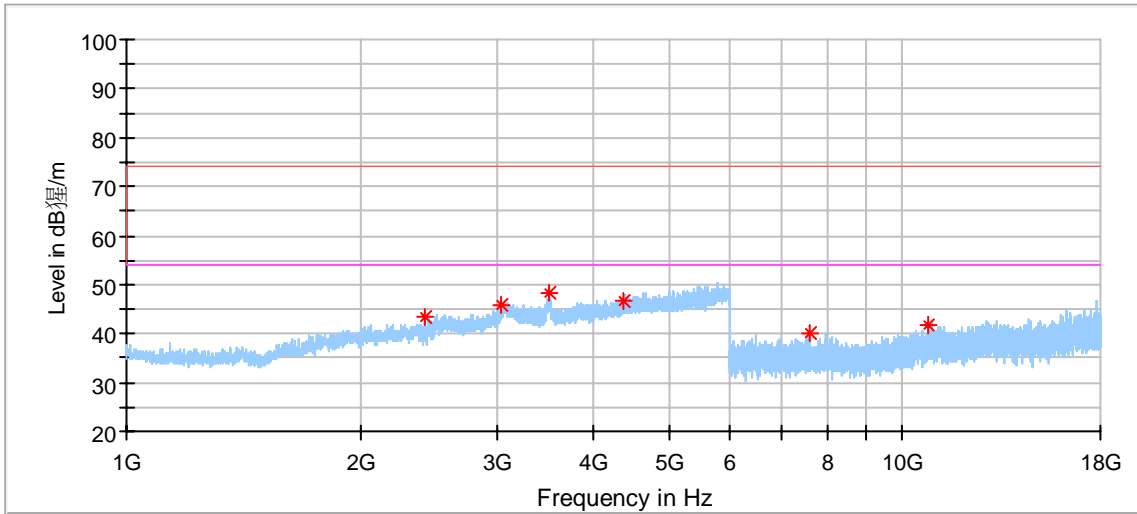

Critical_Freqs

Frequency (MHz)	MaxPeak (dBµV/m)	Limit (dBµV/m)	Margin (dB)	Height (cm)	Pol	Azimuth (deg)	Corr. (dB/m)
2420.500000	43.29	74.00	30.71	150.0	V	356.0	-2.44
3049.500000	45.94	74.00	28.06	150.0	V	34.0	1.34
3505.000000	48.17	74.00	25.83	150.0	V	3.0	3.49
4370.500000	46.83	74.00	27.17	150.0	V	212.0	2.80
7605.500000	39.99	74.00	34.01	150.0	V	30.0	6.17
10800.500000	41.56	74.00	32.44	150.0	V	144.0	9.72

Test data 1GHz to 18GHz:
BLE_1Mbps _Middle Channel:

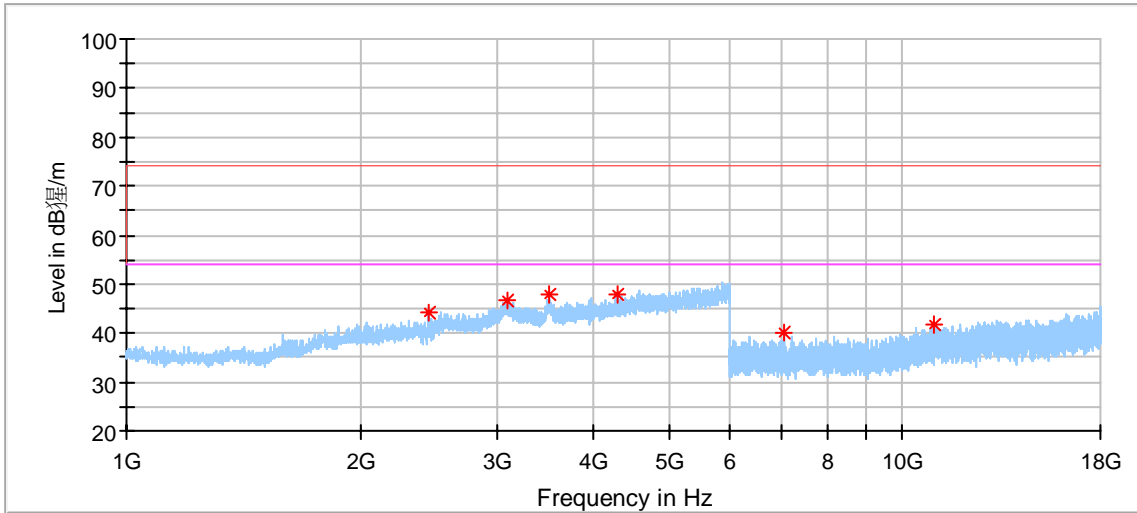

Critical_Freqs

Frequency (MHz)	MaxPeak (dBµV/m)	Limit (dBµV/m)	Margin (dB)	Height (cm)	Pol	Azimuth (deg)	Corr. (dB/m)
2454.000000	44.02	74.00	29.98	150.0	H	130.0	-2.11
3101.000000	46.83	74.00	27.17	150.0	H	144.0	1.49
3498.000000	47.70	74.00	26.30	150.0	H	116.0	3.62
4283.000000	47.76	74.00	26.24	150.0	H	0.0	2.37
7050.500000	40.09	74.00	33.91	150.0	H	30.0	5.68
10966.000000	41.75	74.00	32.25	150.0	H	116.0	9.98

Test data 1GHz to 18GHz:
BLE_1Mbps _Middle Channel:

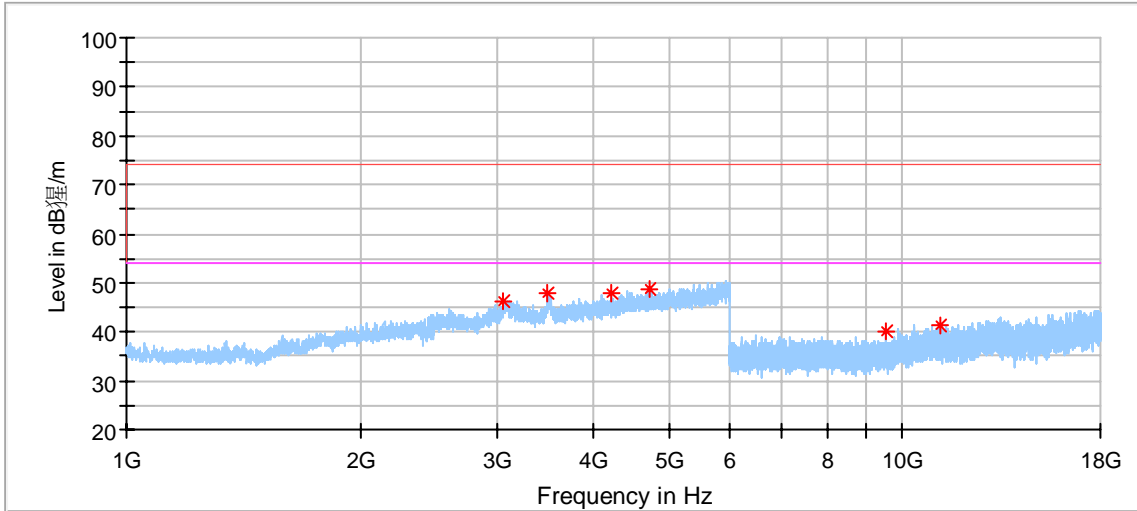

Critical_Freqs

Frequency (MHz)	MaxPeak (dBµV/m)	Limit (dBµV/m)	Margin (dB)	Height (cm)	Pol	Azimuth (deg)	Corr. (dB/m)
3065.500000	46.16	74.00	27.84	150.0	V	335.0	1.35
3496.000000	47.94	74.00	26.06	150.0	V	356.0	3.47
4212.000000	48.01	74.00	25.99	150.0	V	116.0	2.12
4729.000000	48.68	74.00	25.32	150.0	V	356.0	3.79
9498.500000	39.99	74.00	34.01	150.0	V	30.0	7.68
11161.500000	41.20	74.00	32.80	150.0	V	223.0	10.33

Test data 1GHz to 18GHz:
BLE_1Mbps_High Channel:

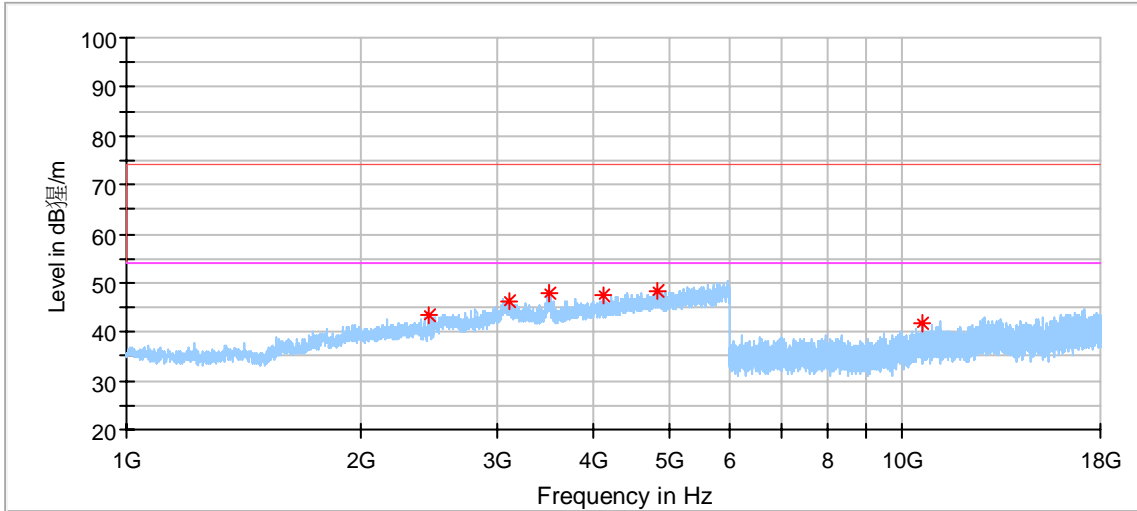

Critical_Freqs

Frequency (MHz)	MaxPeak (dBµV/m)	Limit (dBµV/m)	Margin (dB)	Height (cm)	Pol	Azimuth (deg)	Corr. (dB/m)
2455.500000	43.19	74.00	30.81	150.0	H	34.0	-2.10
3112.500000	46.24	74.00	27.76	150.0	H	75.0	1.32
3501.000000	48.10	74.00	25.90	150.0	H	157.0	3.71
4114.500000	47.48	74.00	26.52	150.0	H	116.0	1.98
4836.500000	48.28	74.00	25.72	150.0	H	198.0	4.05
10580.500000	41.60	74.00	32.40	150.0	H	196.0	9.30

Test data 1GHz to 18GHz:
BLE_1Mbps_High Channel:

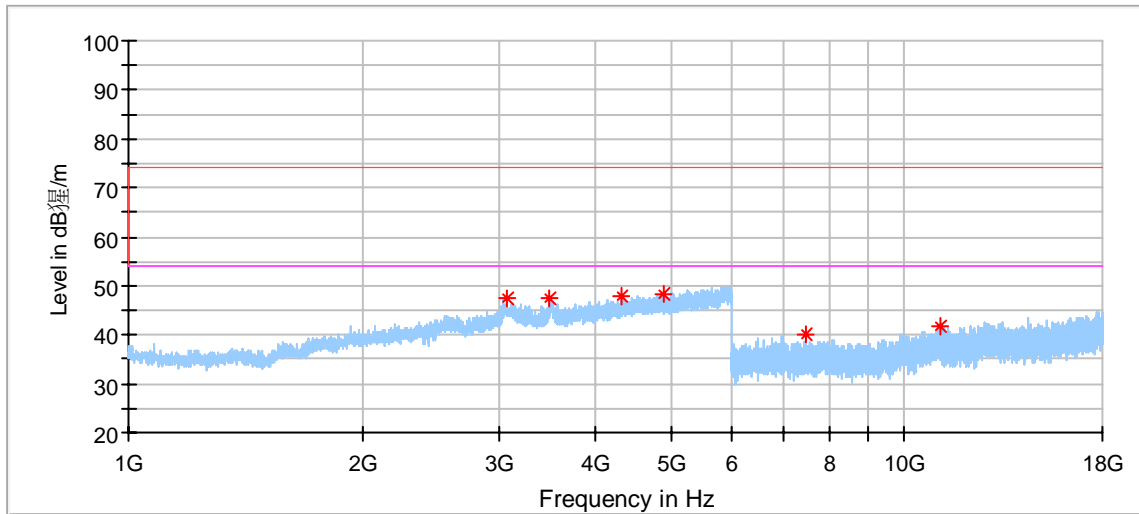

Critical_Freqs

Frequency (MHz)	MaxPeak (dBµV/m)	Limit (dBµV/m)	Margin (dB)	Height (cm)	Pol	Azimuth (deg)	Corr. (dB/m)
3075.500000	47.34	74.00	26.66	150.0	V	335.0	1.35
3488.000000	47.43	74.00	26.57	150.0	V	277.0	2.90
4329.500000	47.75	74.00	26.25	150.0	V	321.0	2.58
4894.500000	48.50	74.00	25.50	150.0	V	250.0	4.07
7462.000000	39.95	74.00	34.05	150.0	V	333.0	6.13
11130.500000	41.79	74.00	32.21	150.0	V	333.0	10.35

Remark:

- (1) Data of measurement within frequency range 9kHz-30MHz, 18-26GHz are the noise floor or attenuated more than 20dB below the permissible limits or the field strength is too small to be measured, so test data does not present in this report.
- (2) We test both rates for Low channel, Middle channel and High channel separately, only the worst case recorded in this report.
- (3) Corrected Amplitude = Read level + Corrector factor
 Above 1GHz: Corrector factor = Antenna Factor + Cable Loss- Amplifier Gain
 Below 1GHz: Corrector factor = Antenna Factor + Cable Loss
 (The Reading Level is recorded by software which is not shown in the sheet)



10 Test Equipment List

Radiated Emission Test 1# (9kHz – 1GHz)

DESCRIPTION	MANUFACTURER	MODEL NO.	EQUIPMENT ID	SERIAL NO.	CAL. DUE DATE
EMI Test Receiver	Rohde & Schwarz	ESR 26	68-4-74-14-002	101269	2024-5-20
Trilog Super Broadband Test Antenna	Schwarzbeck	VULB 9162	68-4-80-19-003	284	2024-3-5
Loop Antenna	Rohde & Schwarz	HFH2-Z2	68-4-80-14-006	100398	2024-8-7
Pre-amplifier	Rohde & Schwarz	SCU 18F	68-4-29-19-001	100745	2024-5-19
Sideband Horn Antenna	Q-PAR	QWH-SL-18-40-K-SG	68-4-80-14-008	12827	2024-7-11
Pre-amplifier	Rohde & Schwarz	SCU 40A	68-4-29-14-002	100432	2024-8-1
Attenuator	Mini-circuits	UNAT-6+	68-4-81-21-002	15542	2024-5-19
3m Semi-anechoic chamber	TDK	SAC-3 #2	68-4-90-19-006	----	2024-5-28
Test software	Rohde & Schwarz	EMC32	68-4-90-19-006-A01	Version10.35.02	N/A

Radiated Emission 2# Test (1GHz – 40GHz)

DESCRIPTION	MANUFACTURER	MODEL NO.	EQUIPMENT ID	SERIAL NO.	CAL. DUE DATE
EMI Test Receiver	Rohde & Schwarz	ESR 26	68-4-74-14-002	101269	2024-5-20
Wave Guide Antenna	ETS	3117	68-4-80-19-001	00218954	2024-4-26
Pre-amplifier	Rohde & Schwarz	SCU 18F	68-4-29-19-002	100746	2024-5-19
Sideband Horn Antenna	Q-PAR	QWH-SL-18-40-K-SG	68-4-80-14-008	12827	2024-7-11
Pre-amplifier	Rohde & Schwarz	SCU 40A	68-4-29-14-002	100432	2024-8-1
Attenuator	Mini-circuits	UNAT-6+	68-4-81-21-002	15542	2024-5-19
3m Semi-anechoic chamber	TDK	SAC-3 #2	68-4-90-19-006	----	2024-5-28
Test software	Rohde & Schwarz	EMC32	68-4-90-19-006-A01	Version10.35.02	N/A

Conducted RF Test System

DESCRIPTION	MANUFACTURER	MODEL NO.	EQUIPMENT ID	SERIAL NO.	CAL. DUE DATE
Signal Analyzer	Rohde & Schwarz	FSV40	68-4-74-14-004	101030	2024-5-19
RF Switch Module	Rohde & Schwarz	OSP120/OSP-B157W	68-4-93-14-003	101226/100929	2024-5-20
Power Splitter	Weinschel	1580	68-4-85-14-001	SC319	2024-5-20
10dB Attenuator	Weinschel	4M-10	68-4-81-14-003	43152	2024-5-19
10dB Attenuator	R&S	DNF	68-4-81-14-004	DNF-001	2024-5-19
10dB Attenuator	R&S	DNF	68-4-81-14-005	DNF-002	2024-5-19
10dB Attenuator	R&S	DNF	68-4-81-14-006	DNF-003	2024-5-19
10dB Attenuator	R&S	DNF	68-4-81-14-007	DNF-004	2024-5-19
Test software	Tonscend	System for BT/WIFI	68-4-74-14-006-A13	Version 2.6.77.0518	N/A
Shielding Room	TDK	TS8997	68-4-90-19-003	----	2025-10-15

Conducted Emission Test

DESCRIPTION	MANUFACTURER	MODEL NO.	EQUIPMENT ID	SERIAL NO.	CAL. DUE DATE
EMI Test Receiver	Rohde & Schwarz	ESR 3	68-4-74-14-001	101782	2024-5-20
LISN	Rohde & Schwarz	ENV432	68-4-87-16-001	101318	2024-5-20
Test software	Rohde & Schwarz	EMC32	68-4-90-14-003-A10	Version9.15.00	N/A
Shielding Room	TDK	CSR #1	68-4-90-19-004	----	2025-10-15

11 System Measurement Uncertainty

For a 95% confidence level, the measurement expanded uncertainties for defined systems, in accordance with the recommendations of ISO 17025 were:

System Measurement Uncertainty	
Test Items	Extended Uncertainty
Uncertainty for Conducted Emission 150kHz-30MHz (for test using AMN ENV432 or ENV4200)	3.57dB
Uncertainty for Radiated Emission in 3m chamber 9kHz-30MHz	4.70dB
Uncertainty for Radiated Emission in new 3m chamber 30MHz-1000MHz	Horizontal: 4.59dB; Vertical: 4.75dB
Uncertainty for Radiated Emission in new 3m 1000MHz-18000MHz	Horizontal: 5.08dB; Vertical: 5.09dB;
Uncertainty for Radiated Emission 18000MHz-40000MHz	Horizontal: 4.52dB; Vertical: 4.51dB
Uncertainty for Conducted RF test	RF Power Conducted: 1.31dB Frequency test involved: 0.6×10 ⁻⁸ or 1%

Measurement Uncertainty Decision Rule:

Determination of conformity with the specification limits is based on the decision rule according to IEC Guide 115: 2023, clause 4.3.3 and 4.3.4.

---THE END OF REPORT---