





# FCC Radio TEST Report

## FCC ID: O4G7270100

This report concerns (check one) :  Original Grant  Class II Change

**Issued Date** : Jan. 21, 2010  
**Project No.** : 1001C019  
**Equipment** : Indoor Bike Computer  
**Model Name** : 727-0100  
**Applicant** : Dayton Industrial Co. Ltd.  
**Address** : 2-12 Kwai Fat Road, 11-A Kwai Chung, N.T. Hong Kong  
**Manufacturer** : Kandy Enterprise Ltd.  
**Address** : 2-12 Kwai Fat Road, 11-A Kwai Chung, N.T. Hong Kong

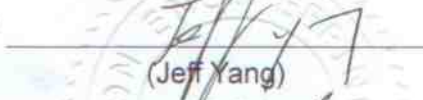
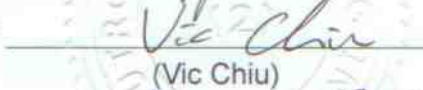
**Tested by:**  
Neutron Engineering Inc. EMC Laboratory  
**Date of Test:**  
Jan. 07, 2010 ~ Jan. 20, 2010

Testing Engineer :   
(Jeff Yang)  
Technical Manager :   
(Vic Chiu)  
Authorized Signatory :   
(James Chiu)

### NEUTRON ENGINEERING INC.

No. 132-1, Lane 329, Sec. 2, Palain Rd.,  
Shijr City, Taipei, Taiwan  
TEL : (02) 2646-5426 FAX : (02) 2646-6815





### **Declaration**

**Neutron** represents to the client that testing is done in accordance with standard procedures as applicable and that test instruments used has been calibrated with the standards traceable to National Measurement Laboratory (**NML**) of **R.O.C.**, or National Institute of Standards and Technology (**NIST**) of **U.S.A.**

**Neutron's** reports apply only to the specific samples tested under conditions. It is manufacture's responsibility to ensure that additional production units of this model are manufactured with the identical electrical and mechanical components. **Neutron** shall have no liability for any declarations, inferences or generalizations drawn by the client or others from **Neutron** issued reports.

**Neutron's** reports must not be used by the client to claim product endorsement by the authorities or any agency of the Government.

This report is the confidential property of the client. As a mutual protection to the clients, the public and **Neutron-self**, extracts from the test report shall not be reproduced except in full with **Neutron's** authorized written approval.

**Neutron's** laboratory quality assurance procedures are in compliance with the **ISO Guide 17025** requirements, and accredited by the conformity assessment authorities listed in this test report.

### **Limitation**

For the use of the authority's logo is limited unless the Test Standard(s)/Scope(s)/Item(s) mentioned in this test report is (are) included in the conformity assessment authorities acceptance respective.



<b>Table of Contents</b>	<b>Page</b>
1 . CERTIFICATION	5
2 . SUMMARY OF TEST RESULTS	6
2.1 TEST FACILITY	7
2.2 MEASUREMENT UNCERTAINTY	7
3 . GENERAL INFORMATION	8
3.1 GENERAL DESCRIPTION OF EUT	8
3.2 DESCRIPTION OF TEST MODES	10
3.3 BLOCK DIGRAM SHOWING THE CONFIGURATION OF SYSTEM TESTED	11
3.4 DESCRIPTION OF SUPPORT UNITS	12
4 . EMC EMISSION TEST	13
4.1 CONDUCTED EMISSION MEASUREMENT	13
4.1.1 POWER LINE CONDUCTED EMISSION LIMITS	13
4.1.2 MEASUREMENT INSTRUMENTS LIST	13
4.1.3 TEST PROCEDURE	14
4.1.4 DEVIATION FROM TEST STANDARD	14
4.1.5 TEST SETUP	14
4.1.6 EUT OPERATING CONDITIONS	14
4.1.7 TEST RESULTS	15
4.2 RADIATED EMISSION MEASUREMENT	16
4.2.1 RADIATED EMISSION LIMITS	16
4.2.2 MEASUREMENT INSTRUMENTS LIST	17
4.2.3 TEST PROCEDURE	19
4.2.4 DEVIATION FROM TEST STANDARD	19
4.2.5 TEST SETUP	20
4.2.6 EUT OPERATING CONDITIONS	21
4.2.7 TEST RESULTS (BETWEEN 30 – 1000 MHz)	22
4.2.8 TEST RESULTS (ABOVE 1000 MHz)	24
4.2.9 SUMMARY OF TEST RESULTS OF FUNDAMENTAL FREQUENCIES (2400 – 2483.5MHz)	28
4.2.10 TEST RESULTS (Restricted Bands Requirements)	29
5 . BANDWIDTH TEST	31
5.1 MEASUREMENT INSTRUMENTS LIST	31
5.2 TEST PROCEDURE	31
5.3 DEVIATION FROM STANDARD	31
5.4 TEST SETUP	31
5.5 EUT OPERATION CONDITIONS	31



<b>Table of Contents</b>	<b>Page</b>
5.6 TEST RESULTS	32
6 . ANTENNA CONDUCTED SPURIOUS EMISSION	33
6.1 APPLIED PROCEDURES / LIMIT	33
6.1.1 MEASUREMENT INSTRUMENTS LIST	33
6.1.2 TEST PROCEDURE	33
6.1.3 DEVIATION FROM STANDARD	33
6.1.4 TEST SETUP	33
6.1.5 EUT OPERATION CONDITIONS	34
6.1.6 TEST RESULTS	35
7 . EUT TEST PHOTO	37



## 1. CERTIFICATION

Equipment: Indoor Bike Computer

Trade Name : N/A

Model Name. : 727-0100

Applicant: Dayton Industrial Co. Ltd.

Date of Test: Jan. 07, 2010 ~ Jan. 20, 2010

Test Item: ENGINEERING SAMPLE

Standards: FCC Part15, Subpart C(15.249)/ ANSI C63.4 : 2003

The above equipment has been tested and found compliance with the requirement of the relative standards by Neutron Engineering Inc. EMC Laboratory.

The test data, data evaluation, and equipment configuration contained in our test report (Ref No. NEI-FCCP-1-1001C019) were obtained utilizing the test procedures, test instruments, test sites that has been accredited by the Authority of NVLAP and TAF according to the ISO-17025 quality assessment standard and technical standard(s).



## 2. SUMMARY OF TEST RESULTS

Test procedures according to the technical standards:

FCC Part15, Subpart C (15.249)			
Standard Section	Test Item	Judgment	Remark
15.207	Conducted Emission	-	N/A
15.209	Radiated emission	PASS	
15.249	Radiated Spurious Emission	PASS	

**NOTE:**

(1) "N/A" denotes test is not applicable in this Test Report



**2.1 TEST FACILITY**

The test facilities used to collect the test data in this report is **C01/OS02** at the location of No.132-1, Lane 329, Sec. 2, Palian Road, Shijr City, Taipei, Taiwan.

Neutron's test firm number is 95335

**2.2 MEASUREMENT UNCERTAINTY**

The reported uncertainty of measurement  $y \pm U$ , where expended uncertainty **U** is based on a standard uncertainty multiplied by a coverage factor of **k=2**, providing a level of confidence of approximately **95 %**.

**A. Conducted Measurement :**

Test Site	Method	Measurement Frequency Range	U , (dB)	NOTE
C01	ANSI	150 KHz ~ 30MHz	1.94	

**B. Radiated Measurement :**

Test Site	Method	Measurement Frequency Range	Ant. H / V	U , (dB)	NOTE
OS-01	ANSI	30MHz ~ 200MHz	V	3.82	
		30MHz ~ 200MHz	H	3.60	
		200MHz ~ 1,000MHz	V	3.86	
		200MHz ~ 1,000MHz	H	3.94	
OS-02	ANSI	30MHz ~ 200MHz	V	2.48	
		30MHz ~ 200MHz	H	2.16	
		200MHz ~ 1,000MHz	V	2.50	
		200MHz ~ 1,000MHz	H	2.66	



**3. GENERAL INFORMATION**

**3.1 GENERAL DESCRIPTION OF EUT**

Equipment	Indoor Bike Computer	
Trade Name	N/A	
Model Name.	727-0100	
OEM Brand/Model Name	N/A	
Model Difference	N/A	
Product Description	The EUT is a Indoor Bike Computer.	
	Product Type	Low Power Communication Device
	Operation Frequency:	2466 MHz
	Modulation Type:	GFSK
	Number Of Channel	1CH
	Antenna Designation:	Printed antenna
	Antenna Gain(Peak)	1.03 dBi
	Output Power:	82.85 dBuV/m (AV Max.)
Based on the application, features, or specification exhibited in User's Manual, the EUT is considered as an ITE/Computing Device. More details of EUT technical specification please refer to the User's Manual.		
Channel List	Please refer to the Note 2.	
Power Source	DC Voltage supplied from Battery	
Power Rating	DC 3.0V	
Connecting I/O Port(s)	Please refer to the User's Manual	
Products Covered	N/A	

**Note:**

1. For a more detailed features description, please refer to the manufacturer's specifications or the User's Manual.





2.

Channel	Frequency (MHz)
01	2466

3. Table for Filed Antenna

Ant.	Brand	Model Name	Antenna Type	Connector	Gain (dBi)
1	N/A	N/A	Printed Antenna	N/A	1.03



**3.2 DESCRIPTION OF TEST MODES**

To investigate the maximum EMI emission characteristics generated from EUT, the test system was pre-scanning tested based on the consideration of following EUT operation mode or test configuration mode which possible have effect on EMI emission level. Each of these EUT operation mode(s) or test configuration mode(s) mentioned above was evaluated respectively.

Pretest Mode	Description
Mode 1	CH 01 - 2466MHz

For Conducted Test	
Final Test Mode	Description
	" N/A" denotes test is not applicable in this Test Report

For Radiated Test	
Final Test Mode	Description
Mode 1	CH 01 - 2466MHz

Note:

- (1) The EUT used the new battery



3.3 BLOCK DIGRAM SHOWING THE CONFIGURATION OF SYSTEM TESTED

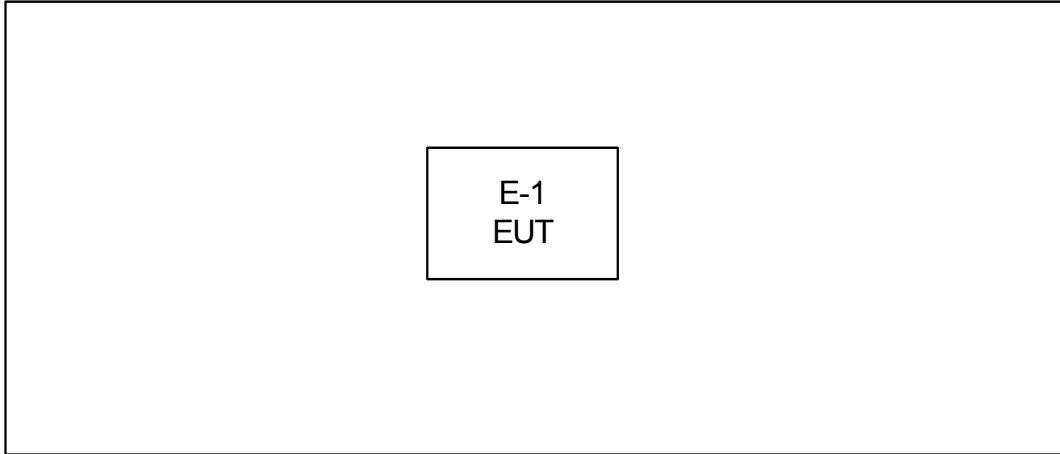



**3.4 DESCRIPTION OF SUPPORT UNITS**

The EUT has been tested as an independent unit together with other necessary accessories or support units. The following support units or accessories were used to form a representative test configuration during the tests.

Item	Equipment	Mfr/Brand	Model/Type No.	FCC ID	Series No.	Note
E-1	Indoor Bike Computer	N/A	727-0100	O4G7270100	N/A	EUT

Item	Shielded Type	Ferrite Core	Length	Note

**Note:**

- (1) The support equipment was authorized by Declaration of Confirmation.
- (2) For detachable type I/O cable should be specified the length in cm in 『Length』 column.



**4. EMC EMISSION TEST**

**4.1 CONDUCTED EMISSION MEASUREMENT**

**4.1.1 POWER LINE CONDUCTED EMISSION LIMITS (Frequency Range 150KHz-30MHz)**

FREQUENCY (MHz)	Class A (dBuV)		Class B (dBuV)		Standard
	Quasi-peak	Average	Quasi-peak	Average	
0.15 -0.5	79.00	66.00	66 - 56 *	56 - 46 *	CISPR
0.50 -5.0	73.00	60.00	56.00	46.00	CISPR
5.0 -30.0	73.00	60.00	60.00	50.00	CISPR

0.15 -0.5	79.00	66.00	66 - 56 *	56 - 46 *	FCC
0.50 -5.0	73.00	60.00	56.00	46.00	FCC
5.0 -30.0	73.00	60.00	60.00	50.00	FCC

Note:

- (1) The tighter limit applies at the band edges.
- (2) The limit of " \* " marked band means the limitation decreases linearly with the logarithm of the frequency in the range.

**4.1.2 MEASUREMENT INSTRUMENTS LIST**

Item	Kind of Equipment	Manufacturer	Type No.	Serial No.	Calibrated until
1	LISN	EMCO	3816/2	00042991	Jan. 23, 2010
2	LISN	EMCO	3816/2	00042990	Jan. 23, 2010
3	Pulse Limiter	Electro-Metrics	EM-7600	112644	Nov. 25, 2010
4	50Ω Terminator	N/A	N/A	N/A	May.12, 2010
5	Test Cable	N/A	C01	N/A	Nov. 25, 2010
6	EMI Test Receiver	R&S	ESCI	100082	Mar. 06, 2010

Remark: " N/A" denotes No Model Name. , Serial No. or No Calibration specified.

The following table is the setting of the receiver

Receiver Parameters	Setting
Attenuation	10 dB
Start Frequency	0.15 MHz
Stop Frequency	30 MHz
IF Bandwidth	9 kHz

#### 4.1.3 TEST PROCEDURE

- The EUT was placed 0.4 meters from the horizontal ground plane with EUT being connected to the power mains through a line impedance stabilization network (LISN). All other support equipments powered from additional LISN(s). The LISN provide 50 Ohm/ 50uH of coupling impedance for the measuring instrument.
- Interconnecting cables that hang closer than 40 cm to the ground plane shall be folded back and forth in the center forming a bundle 30 to 40 cm long.
- I/O cables that are not connected to a peripheral shall be bundled in the center. The end of the cable may be terminated, if required, using the correct terminating impedance. The overall length shall not exceed 1 m.
- LISN at least 80 cm from nearest part of EUT chassis.
- For the actual test configuration, please refer to the related Item –EUT Test Photos.

#### 4.1.4 DEVIATION FROM TEST STANDARD

No deviation

#### 4.1.5 TEST SETUP

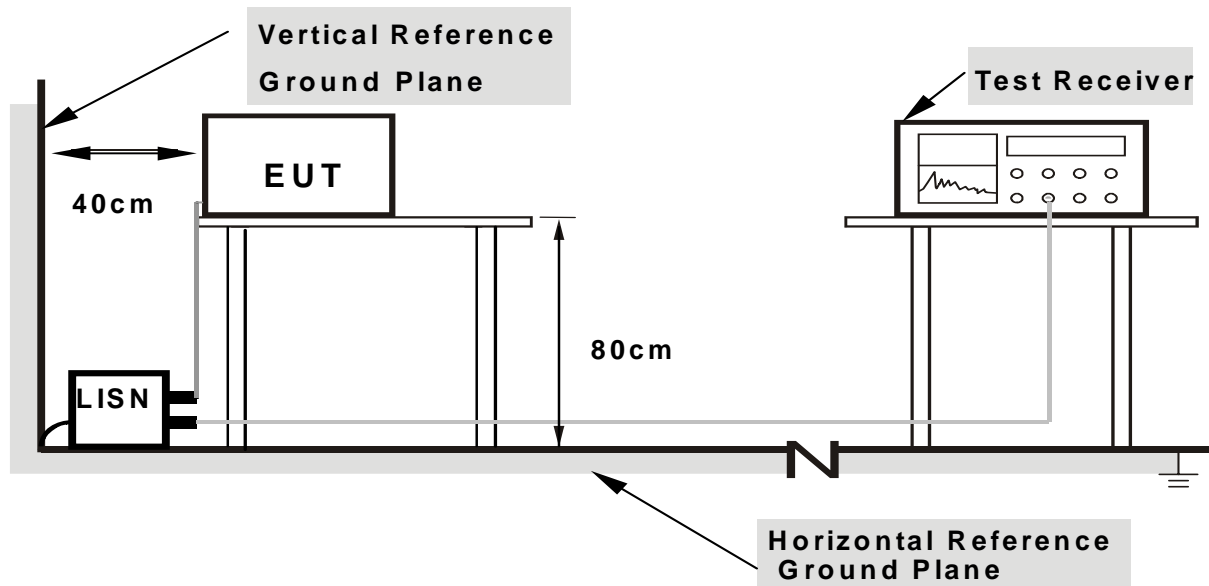

**Note: 1. Support units were connected to second LISN.**

**2. Both of LISNs (AMN) are 80 cm from EUT and at least 80 cm from other units and other metal planes**

#### 4.1.6 EUT OPERATING CONDITIONS

The EUT was configured for testing in a typical fashion (as a customer would normally use it). The EUT has been programmed to continuously transmit during test. This operating condition was tested and used to collect the included data.



#### 4.1.7 TEST RESULTS

EUT :	Indoor Bike Computer	Model Name. :	727-0100
Temperature :	29 °C	Relative Humidity :	50 %
Pressure :	1008 hPa	Test Power :	DC 3.0V
Test Mode :	" N/A" denotes test is not applicable in this Test Report		

#### Remark

- (1) All readings are QP Mode value unless otherwise stated AVG in column of 『Note 』. If the QP Mode Measured value compliance with the QP Limits and lower than AVG Limits, the EUT shall be deemed to meet both QP & AVG Limits and then only QP Mode was measured, but AVG Mode didn't perform. In this case, a " \* " marked in AVG Mode column of Interference Voltage Measured.
- (2) Measuring frequency range from 150KHz to 30MHz.
- (3) " N/A" denotes test is not applicable in this Test Report



**4.2 RADIATED EMISSION MEASUREMENT**

**4.2.1 RADIATED EMISSION LIMITS ( FCC 15.209 )**

<b>Frequencies (MHz)</b>	<b>Field Strength (micorvolts/meter)</b>	<b>Measurement Distance (meters)</b>
0.009~0.490	2400/F(KHz)	300
0.490~1.705	24000/F(KHz)	30
1.705~30.0	30	30
30~88	100	3
88~216	150	3
216~960	200	3
Above 960	500	3

Harmonic emissions limits comply with below 54 dBuV/m at 3m, Other emissions radiated outside of the specified frequency bands, except for harmonics, shall be attenuated by at least 50 dB below the level of the fundamental or comply with the radiated emissions limits specified in section 15.209(a) limit in the table above has to be followed.

Note:

- (1) The tighter limit applies at the band edges.
- (2) Emission level (dBuV/m)=20log Emission level (uV/m).

**LIMITS OF RADIATED EMISSION MEASUREMENT (FCC Part 15.249)**

<b>FCC Part15 (15.249) , Subpart C</b>	
<b>Limit</b>	<b>Frequency Range (MHz)</b>
Field strength of fundamental 50000 μV/m (94 dBμV/m) @ 3 m	2400-2483.5
Field strength of harmonics 500 μV/m (54 dBμV/m) @ 3 m	Above 2483.5





4.2.2 MEASUREMENT INSTRUMENTS LIST

Item	Kind of Equipment	Manufacturer	Type No.	Serial No.	Calibrated until
1	Log-Bicon Antenna	Schwarzbeck	VULB 9160	3058	Nov. 25, 2010
2	Test Cable	N/A	10M_OS02	N/A	Nov. 25, 2010
3	Test Cable	N/A	OS02-1/-2/-3	N/A	Nov. 25, 2010
4	Pre-Amplifier	Anritsu	MH648A	M09961	Nov. 25, 2010
5	EMI Test Receiver	R&S	ESCI	100082	Jan. 29, 2010
6	Antenna Mast	Chance Most	CMTB-1.5	N/A	N/A
7	Turn Table	Chance Most	CMTB-1.5	N/A	N/A
8	Spectrum Analyzer	R&S	FSP_40	100129	Jan. 05, 2011
9	Horn Antenna	Schwarzbeck	BBHA9120D	9120D-325	Oct. 22, 2010
10	Horn Antenna	Schwarzbeck	BBHA9170	9170187	Oct. 22, 2010
11	Microwave Pre_amplifier	Agilent	8449B	3008A01714	Mar. 08, 2010
12	Microflex Cable	United Microwave	57793	1m	Mar. 08, 2010
13	Microflex Cable	United Microwave	A30A30-5006	10M	Jul. 05, 2010
14	Triple Loop Antenna	R&S	HFH2-Z2	830749/020	Jul. 01, 2010

Remark: " N/A" denotes No Model Name. / Serial No. and No Calibration specified.

Spectrum Parameter	Setting
Attenuation	Auto
Start Frequency	1000 MHz
Stop Frequency	10th carrier harmonic
RB / VB (emission in restricted band)	1 MHz / 1 MHz for Peak, Average=PK-dycty cycle

Receiver Parameter	Setting
Attenuation	Auto
Start ~ Stop Frequency	9kHz~150kHz / RB 200Hz for QP
Start ~ Stop Frequency	150kHz~30MHz / RB 9kHz for QP
Start ~ Stop Frequency	30MHz~1000MHz / RB 120kHz for QP



DUTY CYCLE : TX 2466MHz

Dwell time=ON/ON+OFF

ON:32msec

ON+OFF:(total time):100msec

Dwell time:32%

AV=PK+20 log(Dwell time)

AV=PK-9.61

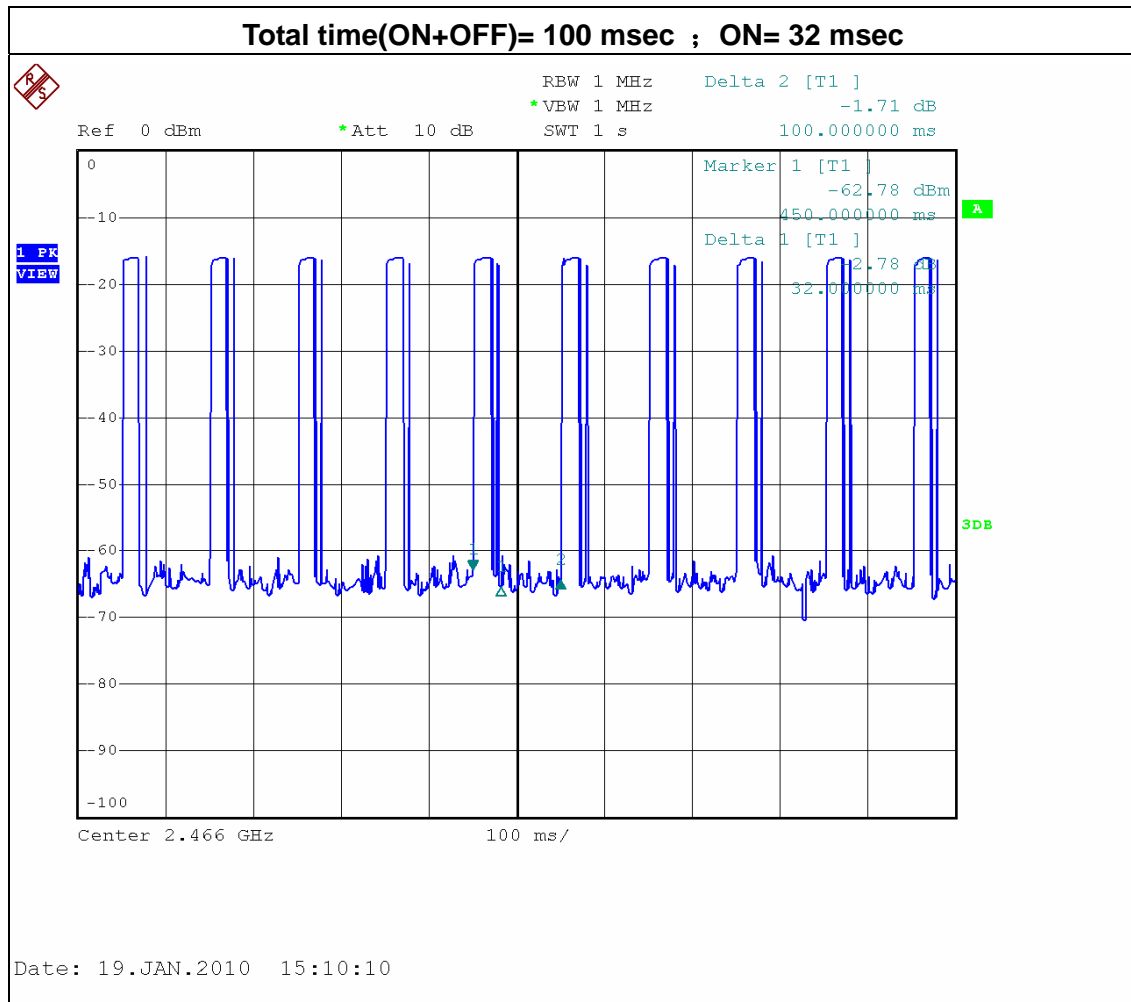



#### 4.2.3 TEST PROCEDURE

- a. The measuring distance of at 3 m shall be used for measurements at frequency up to 1GHz. For frequencies above 1GHz, any suitable measuring distance may be used.
  - b. The EUT was placed on the top of a rotating table 0.8 meters above the ground at a 3m meter open area test site. The table was rotated 360 degrees to determine the position of the highest radiation.
  - c. The height of the equipment or of the substitution antenna shall be 0.8 m; the height of the test antenna shall vary between 1 m to 4 m. Both horizontal and vertical polarizations of the antenna are set to make the measurement.
  - d. The initial step in collecting conducted emission data is a spectrum analyzer peak detector mode pre-scanning the measurement frequency range. Significant peaks are then marked and then Quasi Peak detector mode re-measured.
  - e. If the Peak Mode measured value compliance with and lower than Quasi Peak Mode Limit, the EUT shall be deemed to meet QP Limits and then no additional QP Mode measurement performed.
  - f. For the actual test configuration, please refer to the related Item –EUT Test Photos.
- 9 In case the emission is lower than 30MHz, loop antenna has to be used for measurement and the recorded data should be QP measured by receiver. High – Low scan is not required in this case.

#### 4.2.4 DEVIATION FROM TEST STANDARD

No deviation

4.2.5 TEST SETUP

(A) Radiated Emission Test Set-Up, Frequency Below 1000MHz

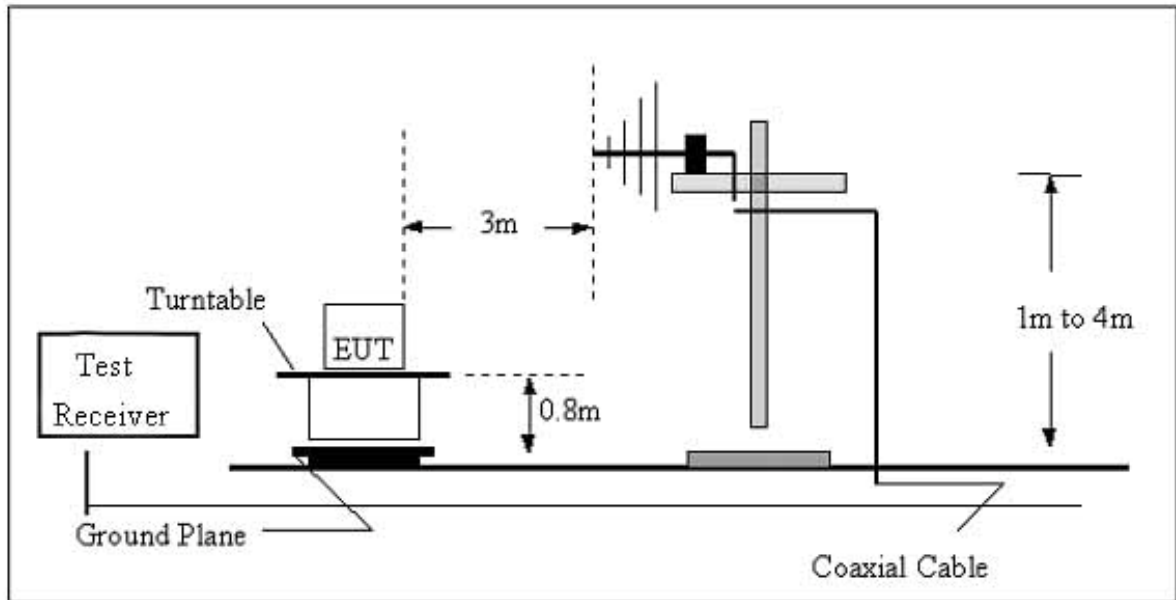

(B) Radiated Emission Test Set-UP Frequency Above 1 GHz

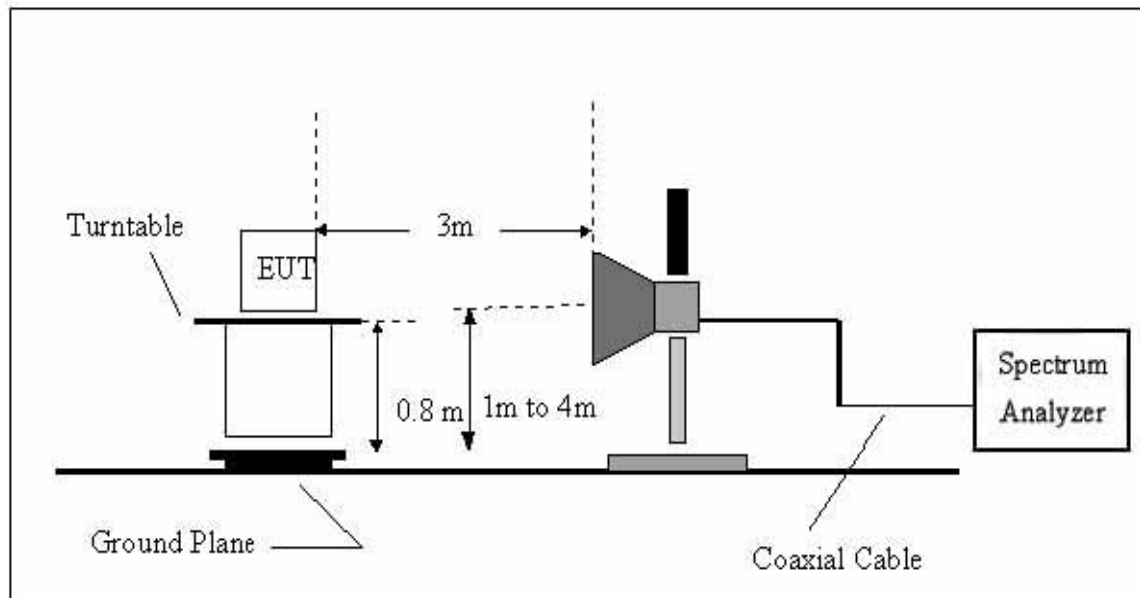

(C) For radiated emissions below 30MHz

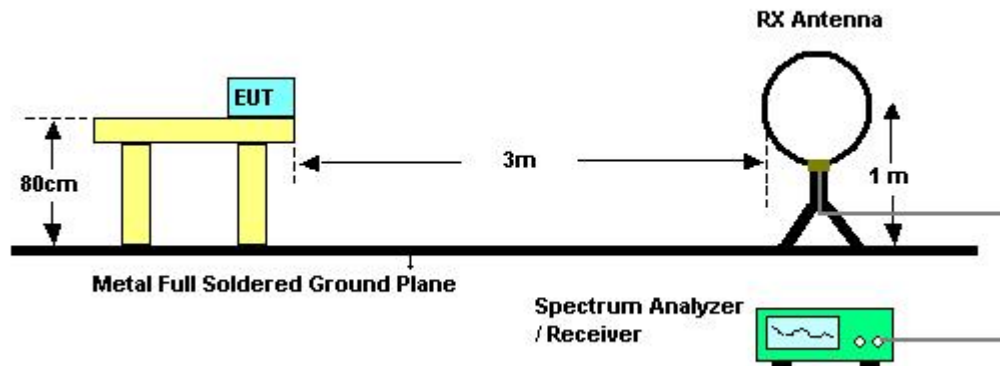

#### 4.2.6 EUT OPERATING CONDITIONS

The EUT tested system was configured as the statements of 4.1.6 Unless otherwise a special operating condition is specified in the follows during the testing.



4.2.7 TEST RESULTS (BETWEEN 30 – 1000 MHz)

EUT :	Indoor Bike Computer	Model Name. :	727-0100
Temperature :	22 °C	Relative Humidity :	45 %
Pressure :	1008 hPa	Test Power :	DC 3.0V
Test Mode :	TX Mode		

Freq. (MHz)	Ant. H/V	Reading(RA) (dBuV)	Corr.Factor(CF) (dB)	Measured(FS) (dBuV/m)	Limits(QP) (dBuV/m)	Margin (dB)	Note
102.75	V	51.49	-18.39	33.10	43.50	- 10.40	
186.17	V	42.65	-16.80	25.85	43.50	- 17.65	
358.83	V	45.50	-10.52	34.98	46.00	- 11.02	
463.59	V	37.66	-7.90	29.76	46.00	- 16.24	
541.19	V	38.41	-5.82	32.59	46.00	- 13.41	
579.99	V	41.15	-4.76	36.39	46.00	- 9.61	

Remark :

- (1) All readings are Peak unless otherwise stated QP in column of 『Note』 . Peak denotes that the Peak reading compliance with the QP Limits and then QP Mode measurement didn't perform ◦
- (2) Measuring frequency range from 30MHz to 1000MHz or the 10th harmonic of highest fundamental frequency ◦ “F” denotes fundamental frequency; “ H” denotes spurious frequency. “E” denotes band edge frequency.
- (3) Radiated emissions measured in frequency range from 30 MHz to 1000 MHz were made with an instrument using Peak detector mode or QP detector mode of the emission ◦
- (4) Data of measurement within this frequency range shown “ - ” in the table above means the reading of emissions are attenuated more than 20dB below the permissible limits or the field strength is too small to be measured.
- (5) All the lower, middle, highest frequencies were tested, and the highest frequency was found to be the worst case during the test. The test result of this worst case was used for the report.
- (6) Measure frequency range 9KHz~30MHz because The amplitude of spurious emissions which are attenuated by more than 20 dB below the permissible value has no need to be reported.

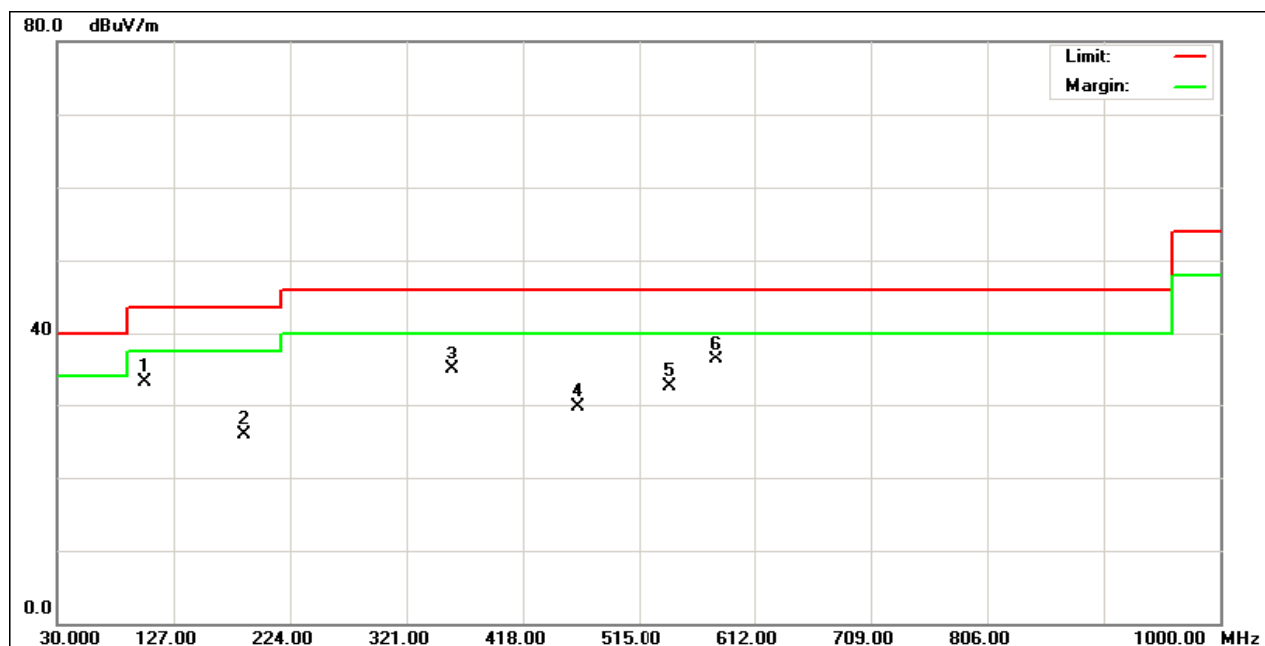



EUT :	Indoor Bike Computer	Model Name. :	727-0100
Temperature :	22 °C	Relative Humidity :	45 %
Pressure :	1008 hPa	Test Power :	DC 3.0V
Test Mode :	TX Mode		

Freq. (MHz)	Ant. H/V	Reading(RA) (dBuV)	Corr.Factor(CF) (dB)	Measured(FS) (dBuV/m)	Limits(QP) (dBuV/m)	Margin (dB)	Note
85.29	H	52.36	-19.12	33.24	40.00	- 6.76	
145.43	H	52.15	-17.64	34.51	43.50	- 8.99	
221.09	H	47.49	-15.83	31.66	46.00	- 14.34	
288.99	H	48.72	-12.12	36.60	46.00	- 9.40	
337.49	H	48.95	-11.15	37.80	46.00	- 8.20	
572.23	H	30.43	-4.95	25.48	46.00	- 20.52	

**Remark :**

- (1) All readings are Peak unless otherwise stated QP in column of 『Note』 . Peak denotes that the Peak reading compliance with the QP Limits and then QP Mode measurement didn't perform ◦
- (2) Measuring frequency range from 30MHz to 1000MHz or the 10th harmonic of highest fundamental frequency ◦ “F” denotes fundamental frequency; “ H” denotes spurious frequency. “E” denotes band edge frequency.
- (3) Radiated emissions measured in frequency range from 30 MHz to 1000 MHz were made with an instrument using Peak detector mode or QP detector mode of the emission ◦
- (4) Data of measurement within this frequency range shown “ - ” in the table above means the reading of emissions are attenuated more than 20dB below the permissible limits or the field strength is too small to be measured.
- (5) All the lower, middle, highest frequencies were tested, and the highest frequency was found to be the worst case during the test. The test result of this worst case was used for the report.
- (6) Measure frequency range 9KHz~30MHz because The amplitude of spurious emissions which are attenuated by more than 20 dB below the permissible value has no need to be reported.

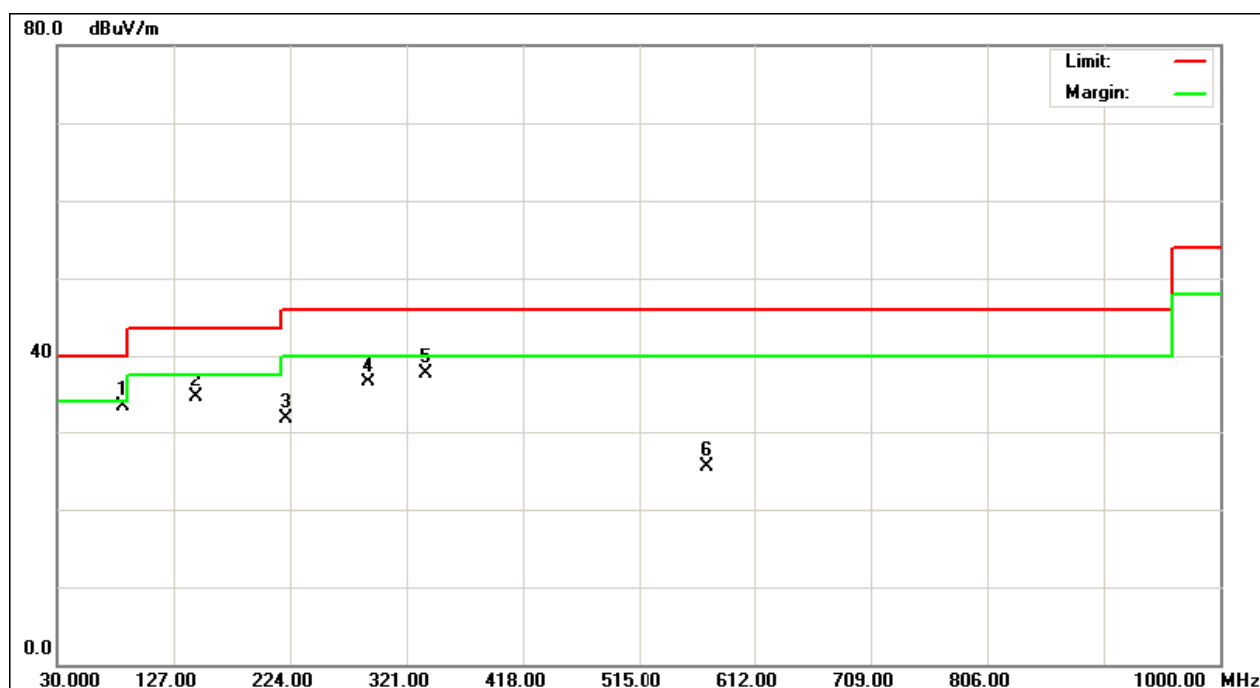



4.2.8 TEST RESULTS (ABOVE 1000 MHz)

EUT :	Indoor Bike Computer	Model Name. :	727-0100
Temperature :	22 °C	Relative Humidity :	45 %
Pressure :	1008 hPa	Test Power :	DC 3.0V
Test Mode :	TX 2466MHz		

Freq. (MHz)	Ant.Pol. H/V	Reading		Ant./CF CF(dB)	Act.		Limit		Note
		Peak (dBuV)	AV (dBuV)		Peak (dBuV/m)	AV (dBuV/m)	Peak (dBuV/m)	AV (dBuV/m)	
2465.90	V	60.91	51.03	31.82	92.73	82.85	114.00	94.00	X/F
2483.50	V	20.16	10.26	31.80	51.96	42.06	74.00	54.00	X/E
4932.04	V	45.23	35.33	5.68	50.91	41.01	74.00	54.00	X/H

Remark :

- (1) All readings are Peak unless otherwise stated QP in column of 『Note』 . Peak denotes that the Peak reading compliance with the QP Limits and then QP Mode measurement didn't perform ◦
- (2) Measuring frequency range from 30MHz to 1000MHz or the 10th harmonic of highest fundamental frequency ◦ "F" denotes fundamental frequency; "H" denotes spurious frequency. "E" denotes band edge frequency. (This judgment method includes the Band Edge Requirement.)
- (3) Radiated emissions measured in frequency range above 1000MHz were made with an instrument using Peak detector mode and AV detector mode of the emission ◦
- (4) Data of measurement within this frequency range shown " \* " in the table above means the reading of emissions are attenuated more than 20dB below the permissible limits or the field strength is too small to be measured.
- (5) A preamp and high pass filter were used for this test in order to provide sufficient measurement sensitivity.
- (6) EUT Orthogonal Axis :  
"X" - denotes Laid on Table ; "Y" - denotes Vertical Stand ; "Z" - denotes Side Stand
- (7) During the measurements above 1 GHz it is taken care of that the EUT is always within the 3 dB cone of radiation BW of the used antenna
- (8) The average value of fundamental frequency is:  
Average = Peak value + 20log(Duty cycle) ◦ Final AV=PK-9.61





Orthogonal Axis : X  
TX 2466MHz (Above 1000 MHz, Vertical)

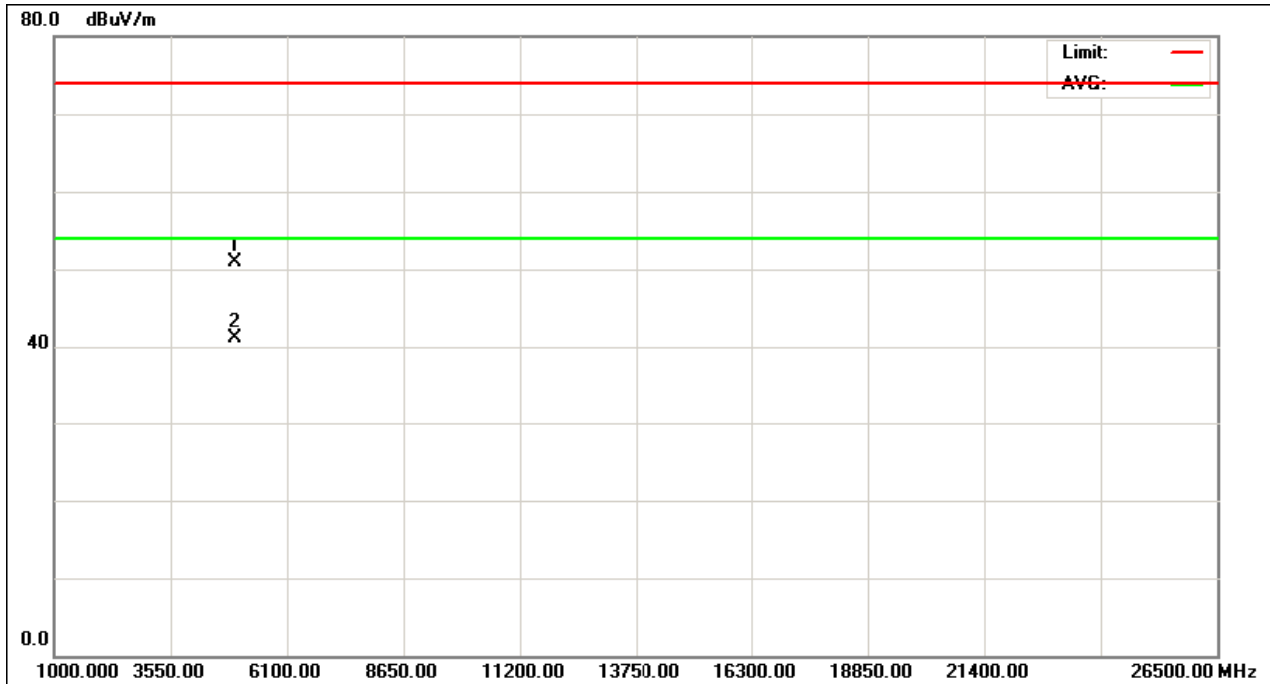
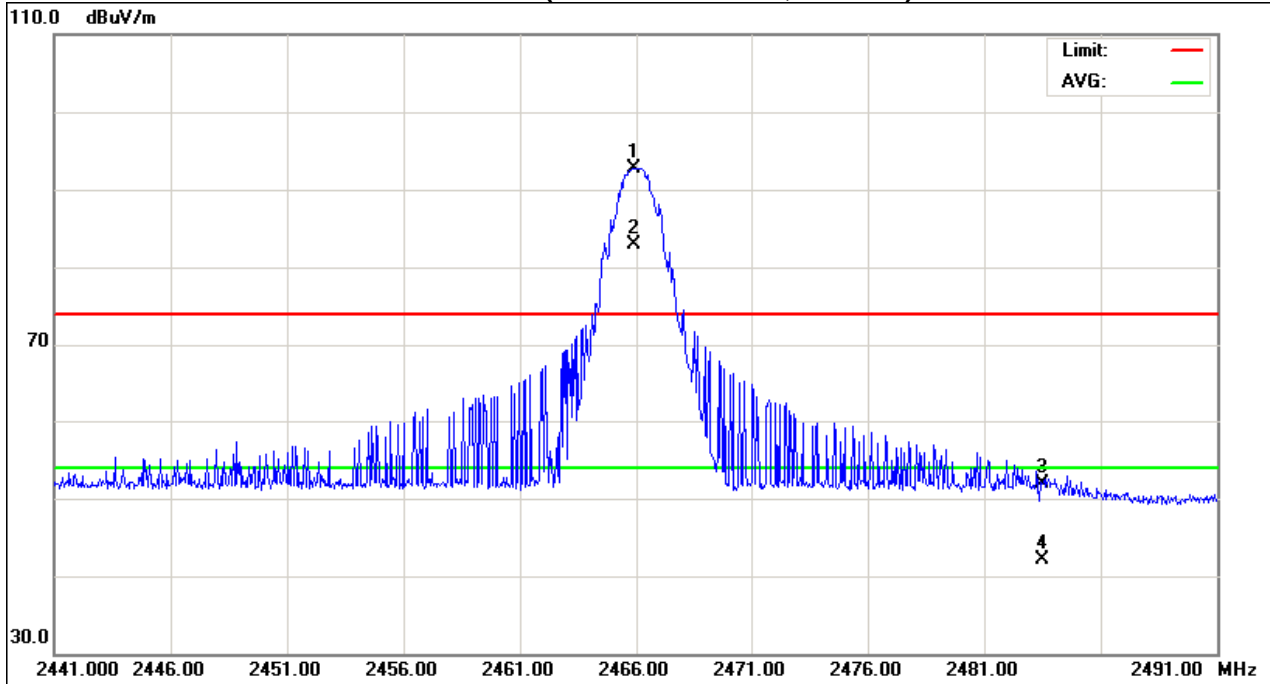



EUT :	Indoor Bike Computer	Model Name. :	727-0100
Temperature :	22 °C	Relative Humidity :	45 %
Pressure :	1008 hPa	Test Power :	DC 3.0V
Test Mode :	TX 2466MHz		

Freq. (MHz)	Ant.Pol. H/V	Reading		Ant./CF CF(dB)	Act.		Limit		Note
		Peak (dBuV)	AV (dBuV)		Peak (dBuV/m)	AV (dBuV/m)	Peak (dBuV/m)	AV (dBuV/m)	
<b>2466.00</b>	<b>H</b>	<b>56.39</b>	<b>46.49</b>	<b>31.82</b>	<b>88.21</b>	<b>78.31</b>	<b>114.00</b>	<b>94.00</b>	<b>X/F</b>
2483.50	H	19.70	9.80	31.80	51.50	41.60	74.00	54.00	X/E
4932.04	H	43.01	33.11	5.68	48.69	38.79	74.00	54.00	X/H

Remark :

- (1) All readings are Peak unless otherwise stated QP in column of 『Note』 . Peak denotes that the Peak reading compliance with the QP Limits and then QP Mode measurement didn't perform ◦
- (2) Measuring frequency range from 30MHz to 1000MHz or the 10th harmonic of highest fundamental frequency “F” denotes fundamental frequency; “H” denotes spurious frequency. “E” denotes band edge frequency. (This judgment method includes the Band Edge Requirement.)
- (3) Radiated emissions measured in frequency range above 1000MHz were made with an instrument using Peak detector mode and AV detector mode of the emission ◦
- (4) Data of measurement within this frequency range shown “ \* ” in the table above means the reading of emissions are attenuated more than 20dB below the permissible limits or the field strength is too small to be measured.
- (5) A preamp and high pass filter were used for this test in order to provide sufficient measurement sensitivity.
- (6) EUT Orthogonal Axis :  
“X” - denotes Laid on Table ; ”Y” - denotes Vertical Stand ; ”Z” - denotes Side Stand
- (7) During the measurements above 1 GHz it is taken care of that the EUT is always within the 3 dB cone of radiation BW of the used antenna
- (8) The average value of fundamental frequency is:  
Average = Peak value + 20log(Duty cycle) ◦ Final AV=PK-9.61



Orthogonal Axis : X  
TX 2466MHz (Above 1000 MHz, Horizontal)

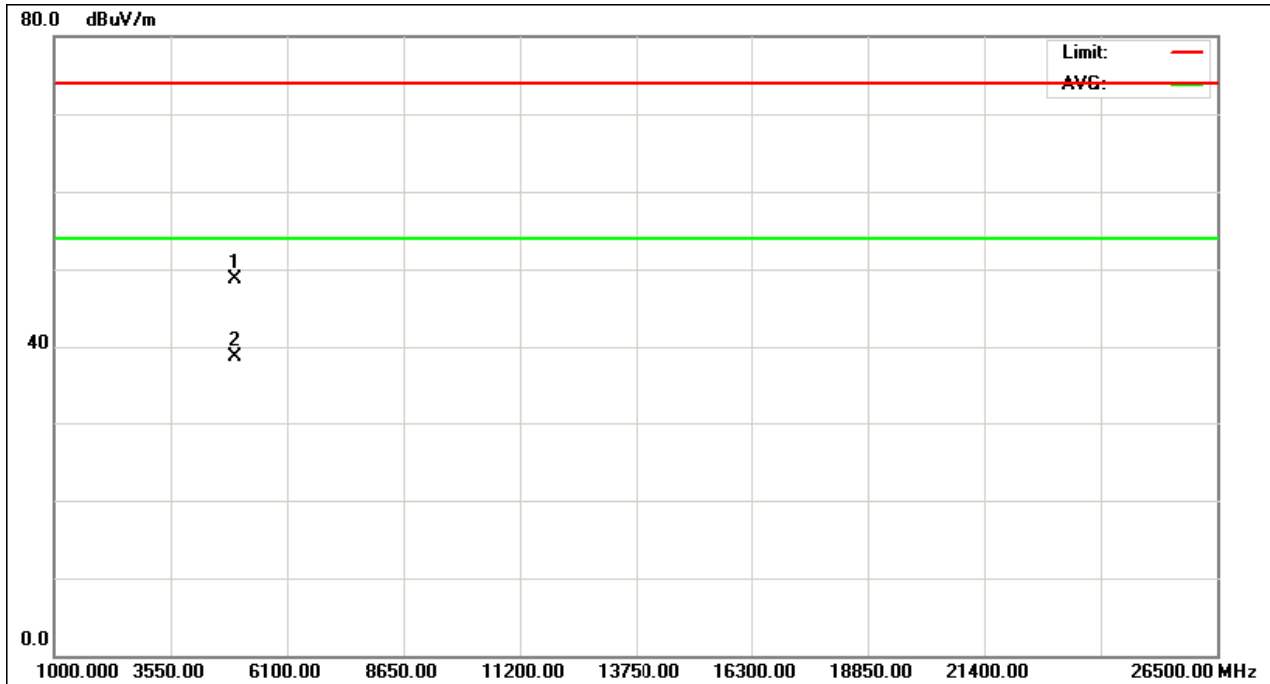
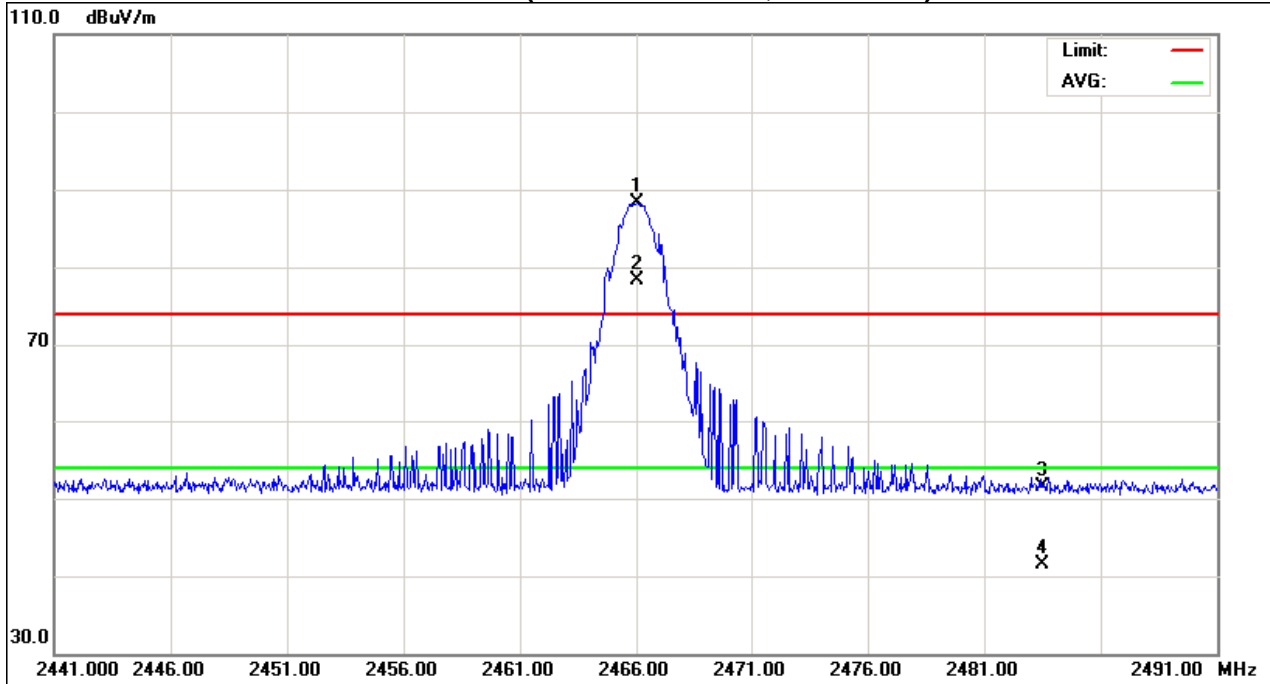



**4.2.9 SUMMARY OF TEST RESULTS OF FUNDAMENTAL FREQUENCIES (2400 – 2483.5MHz)**

EUT :	Indoor Bike Computer	Model Name. :	727-0100
Temperature :	29 °C	Relative Humidity :	51 %
Pressure :	1008 hPa	Test Power :	DC 3.0V
Test Mode :	TX CH 2466MHz		

		Peak	AV		Peak	AV	Peak	AV	
Freq.	Ant.Pol.	Reading		Ant./CL/	Actual FS		Limit3m		
(MHz)	(H/V)	(dBuV)	(dBuV)	CF(dB)	(dBuV/m)	(dBuV/m)	(dBuV/m)	(dBuV/m)	NOTE
2465.90	V	60.91	51.03	31.82	92.73	82.85	114.00	94.00	CH01
2466.00	H	56.39	46.49	31.82	88.21	78.31	114.00	94.00	CH01

**Remark :**

- (1) All readings are Peak unless otherwise stated QP in column of 『Note』 . Peak denotes that the Peak reading compliance with the QP Limits and then QP Mode measurement didn't perform ◦
- (2) Radiated emissions measured in frequency range above 1000MHz were made with an instrument using Peak detector mode and AV detector mode of the emission ◦
- (3) Data of measurement within this frequency range shown “ \* ” in the table above means the reading of emissions are attenuated more than 20dB below the permissible limits or the field strength is too small to be measured.
- (4) EUT Orthogonal Axis :  
 “X” - denotes Laid on Table ; ”Y” - denotes Vertical Stand ; ”Z” - denotes Side Stand
- (5) During the measurements above 1 GHz it is taken care of that the EUT is always within the 3 dB cone of radiation BW of the used antenna
- (6) The average value of fundamental frequency is:  
 Average = Peak value + 20log(Duty cycle) ◦ Final AV=PK-9.61



4.2.10 TEST RESULTS (Restricted Bands Requirements)

EUT :	Indoor Bike Computer	Model Name. :	727-0100
Temperature :	29 °C	Relative Humidity :	51 %
Pressure :	1008 hPa	Test Power :	DC 3.0V
Test Mode :	TX CH 2466MHz(Vertical)		
Note :	The emission of the carrier radiated field strength is measured for (Peak and AV) as following: 1. The transmitter was configured with the worst case antenna and setup to transmit at the highest channel (CH01). Then the field strength was measured at 2483.5-2500 MHz.		

Freq. (MHz)	Ant. Pol. H/V	Reading		Ant./CF CF(dB)	Act.		Limit		Note
		Peak (dBuV)	AV (dBuV)		Peak (dBuV/m)	AV (dBuV/m)	Peak (dBuV/m)	AV (dBuV/m)	
2483.50	V	20.16	10.26	31.80	51.96	42.06	74.00	54.00	CH01

Remark :

- (1) Radiated emissions measured in frequency range above 1000MHz were made with an instrument using Peak detector mode and AV detector mode of the emission ◦
- (2) EUT Orthogonal Axis :  
 "X" - denotes Laid on Table ; "Y" - denotes Vertical Stand ; "Z" - denotes Side Stand
- (3) During the measurements above 1 GHz it is taken care of that the EUT is always within the 3 dB cone of radiation BW of the used antenna
- (4) The average value of fundamental frequency is:  
 Average = Peak value + 20log(Duty cycle) ◦ Final AV=PK-9.61

**TX CH 01 (Restricted Bands Requirements, Vertical)**

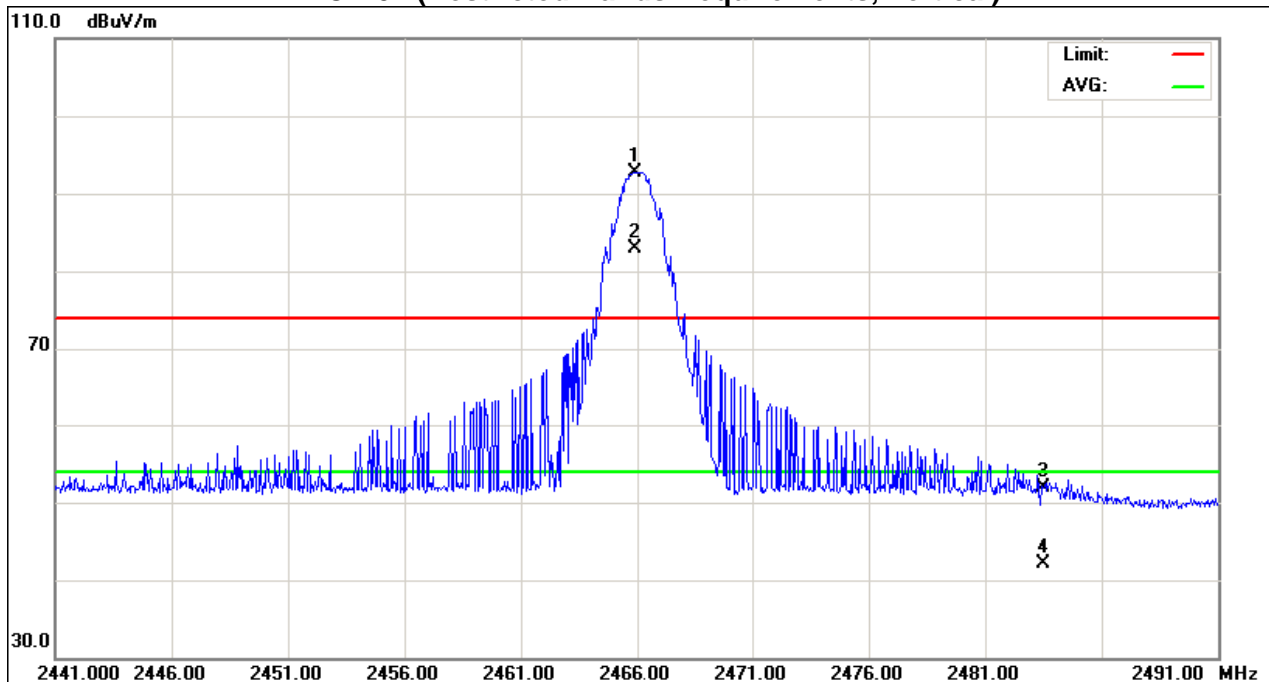



EUT :	Indoor Bike Computer	Model Name. :	727-0100
Temperature :	29 °C	Relative Humidity :	51 %
Pressure :	1008 hPa	Test Power :	DC 3.0V
Test Mode :	TX CH 2466MHz (Horizontal)		
Note :	<p>The emission of the carrier radiated field strength is measured for (Peak and AV) as following:</p> <p>1. The transmitter was configured with the worst case antenna and setup to transmit at the highest channel (CH01). Then the field strength was measured at 2483.5-2500 MHz.</p>		

Freq. (MHz)	Ant. Pol. H/V	Reading		Ant./CF CF(dB)	Act.		Limit		Note
		Peak (dBuV)	AV (dBuV)		Peak (dBuV/m)	AV (dBuV/m)	Peak (dBuV/m)	AV (dBuV/m)	
2483.50	H	19.70	9.80	31.80	51.50	41.60	74.00	54.00	CH01

**Remark :**

- (1) Radiated emissions measured in frequency range above 1000MHz were made with an instrument using Peak detector mode and AV detector mode of the emission ◦
- (2) EUT Orthogonal Axis :  
 "X" - denotes Laid on Table ; "Y" - denotes Vertical Stand ; "Z" - denotes Side Stand
- (3) During the measurements above 1 GHz it is taken care of that the EUT is always within the 3 dB cone of radiation BW of the used antenna
- (4) The average value of fundamental frequency is:  
 Average = Peak value + 20log(Duty cycle) ◦ Final AV=PK-9.61

**TX CH01 (Restricted Bands Requirements, Horizontal)**

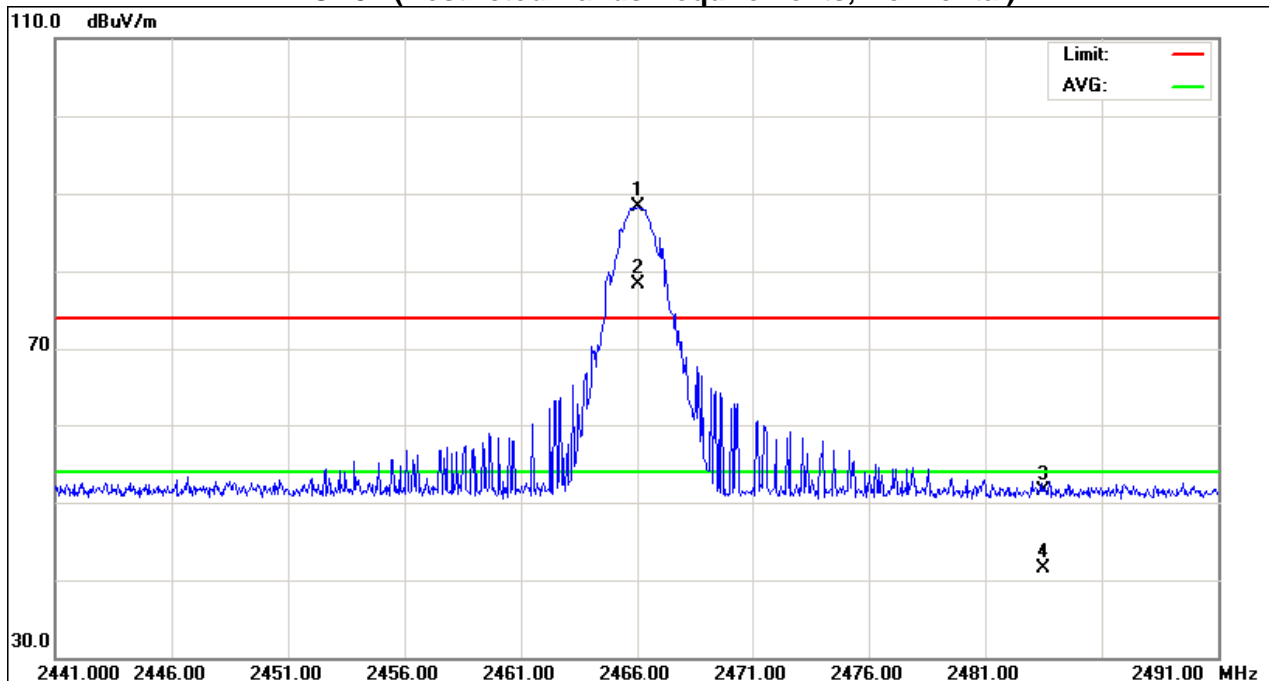



## 5. BANDWIDTH TEST

### 5.1 MEASUREMENT INSTRUMENTS LIST

Item	Kind of Equipment	Manufacturer	Type No.	Serial No.	Calibrated until
1	Spectrum Analyzer	R&S	FSP_40	100129	Jan. 05, 2011

Remark: " N/A" denotes No Model Name. , Serial No. or No Calibration specified.

### 5.2 TEST PROCEDURE

- a. The EUT was directly connected to the spectrum analyzer and antenna output port as show in the block diagram below,
- b. Spectrum Setting : RBW= 100KHz, VBW=100KHz, Sweep time = 2.5 ms.

### 5.3 DEVIATION FROM STANDARD

No deviation.

### 5.4 TEST SETUP



### 5.5 EUT OPERATION CONDITIONS

The EUT tested system was configured as the statements of 4.1.6 Unless otherwise a special operating condition is specified in the follows during the testing.



**5.6 TEST RESULTS**

EUT :	Indoor Bike Computer	Model Name. :	727-0100
Temperature :	29 °C	Relative Humidity :	50 %
Pressure :	1008 hPa	Test Power :	DC 3.0V
Test Mode :	TX CH 01		

Test Channel	Frequency (MHz)	20 dBc Bandwidth (MHz)	99% occupied Bandwidth(MHz)
CH01	2466	1.20	1.10

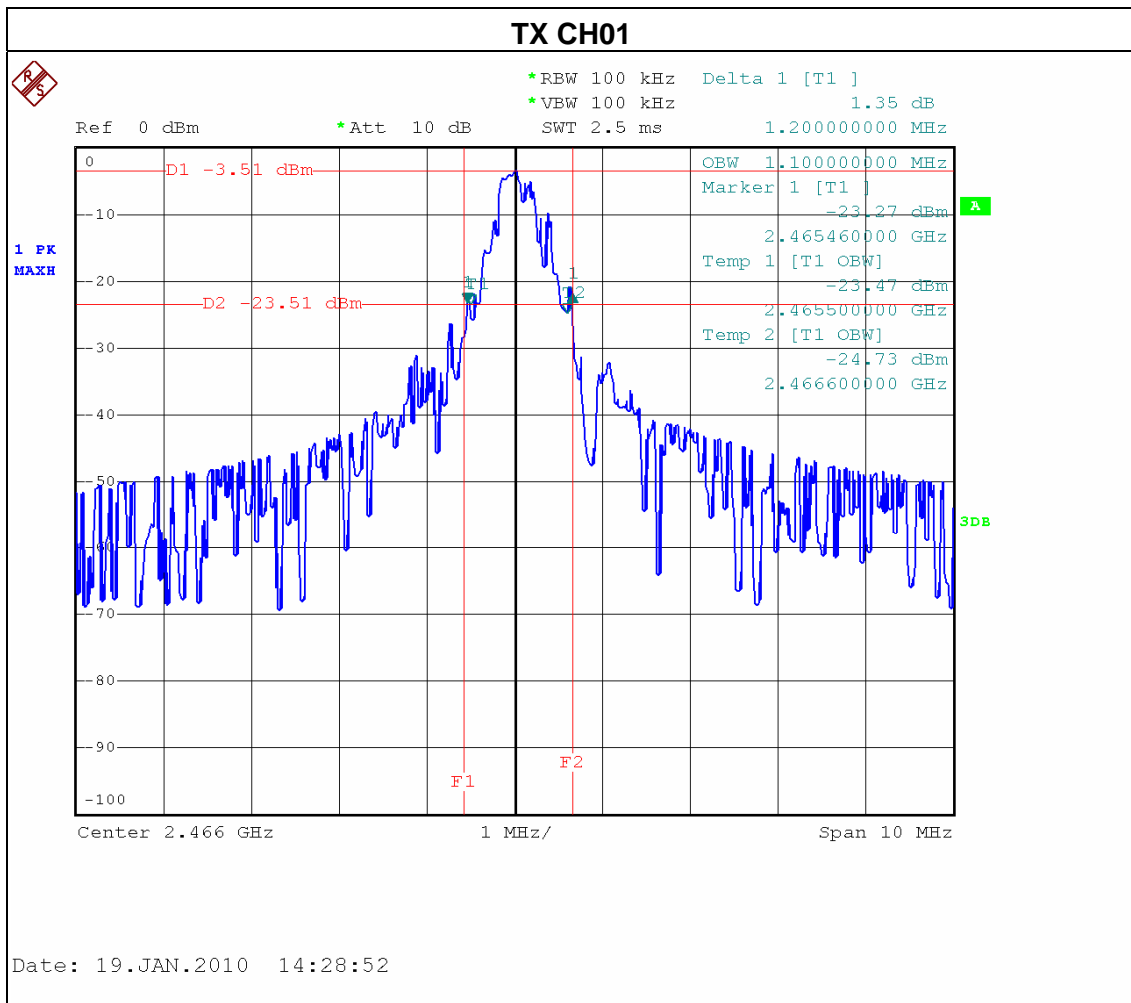





**6. ANTENNA CONDUCTED SPURIOUS EMISSION**

**6.1 APPLIED PROCEDURES / LIMIT**

20dBc in any 100 kHz bandwidth outside the operating frequency band, In case the emission fall within the restricted band specified on 15.205(a), then the 15.209(a) limit in the table below has to be followed.

<b>Frequencies (MHz)</b>	<b>Field Strength (micorvolts/meter)</b>	<b>Measurement Distance (meters)</b>
0.009~0.490	2400/F(KHz)	300
0.490~1.705	24000/F(KHz)	30
1.705~30.0	30	30
30~88	100	3
88~216	150	3
216~960	200	3
Above 960	500	3

**6.1.1 MEASUREMENT INSTRUMENTS LIST**

Item	Kind of Equipment	Manufacturer	Type No.	Serial No.	Calibrated until
8	Spectrum Analyzer	R&S	FSP_40	100129	Jan. 05, 2011

Remark: " N/A" denotes No Model Name. , Serial No. or No Calibration specified.

The following table is the setting of the spectrum analyzer.

<b>Spectrum Parameter</b>	<b>Setting</b>
Attenuation	Auto
Span Frequency	100 MHz
RB / VB (emission in restricted band)	1MHz / 1MHz for Peak, 1 MHz / 10Hz for Average
RB / VB (other emission)	100 KHz /100 KHz for Peak

**6.1.2 TEST PROCEDURE**

- a. The EUT was directly connected to the spectrum analyzer and antenna output port as show in the block diagram below,
- b. Spectrum Setting : RBW= 100KHz, VBW=100KHz, Sweep time = 10 ms.

**6.1.3 DEVIATION FROM STANDARD**

No deviation.

**6.1.4 TEST SETUP**





#### 6.1.5 EUT OPERATION CONDITIONS

The EUT tested system was configured as the statements of 4.1.6 Unless otherwise a special operating condition is specified in the follows during the testing.



6.1.6 TEST RESULTS

EUT :	Indoor Bike Computer	Model Name. :	727-0100
Temperature :	27°C	Relative Humidity :	50 %
Pressure :	1008 hPa	Test Power :	DC 3.0V
Test Mode :	TX CH01		

Channel of Worst Data: CH01			
The max. radio frequency power in any 100kHz bandwidth outside the frequency band		The max. radio frequency power in any 100 kHz bandwidth within the frequency band.	
FREQUENCY(MHz)	POWER(dBm)	FREQUENCY(MHz)	POWER(dBm)
2342.80	-55.82	2498.60	-56.99
Result			
In any 100kHz bandwidth outside the frequency band, the radio frequency power is at least 50dB below that in the 100kHz bandwidth within the band that contains the highest level of the desired power.			

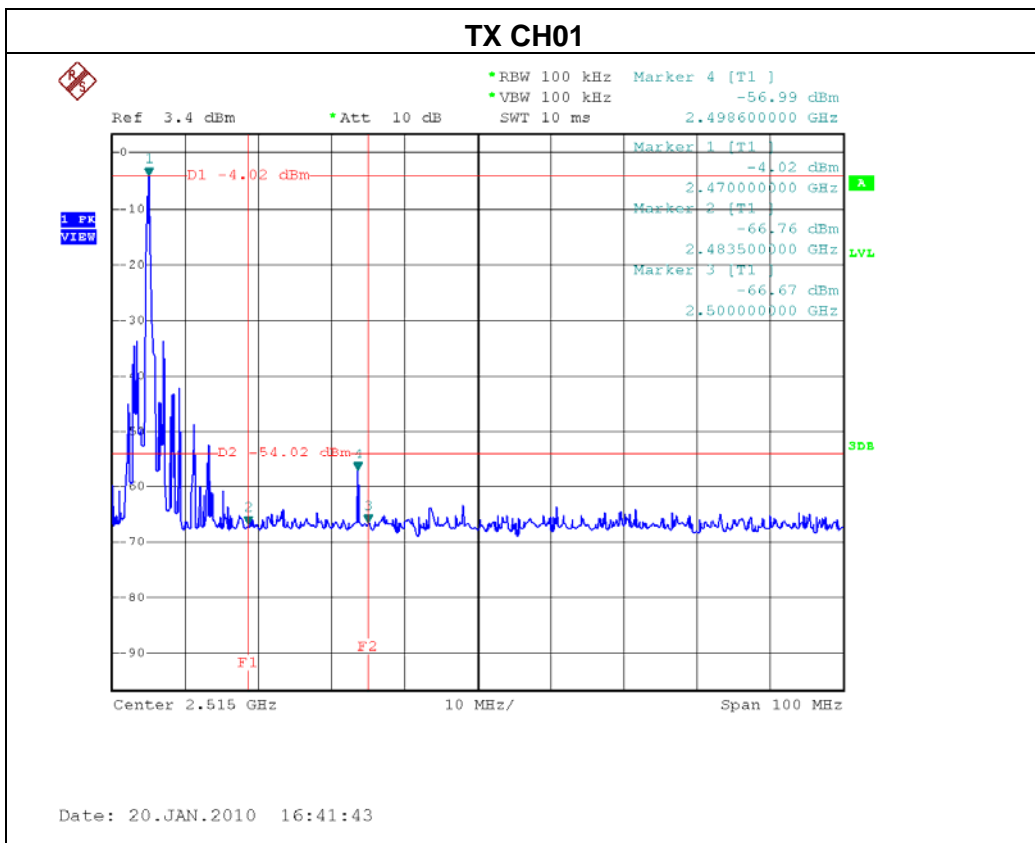
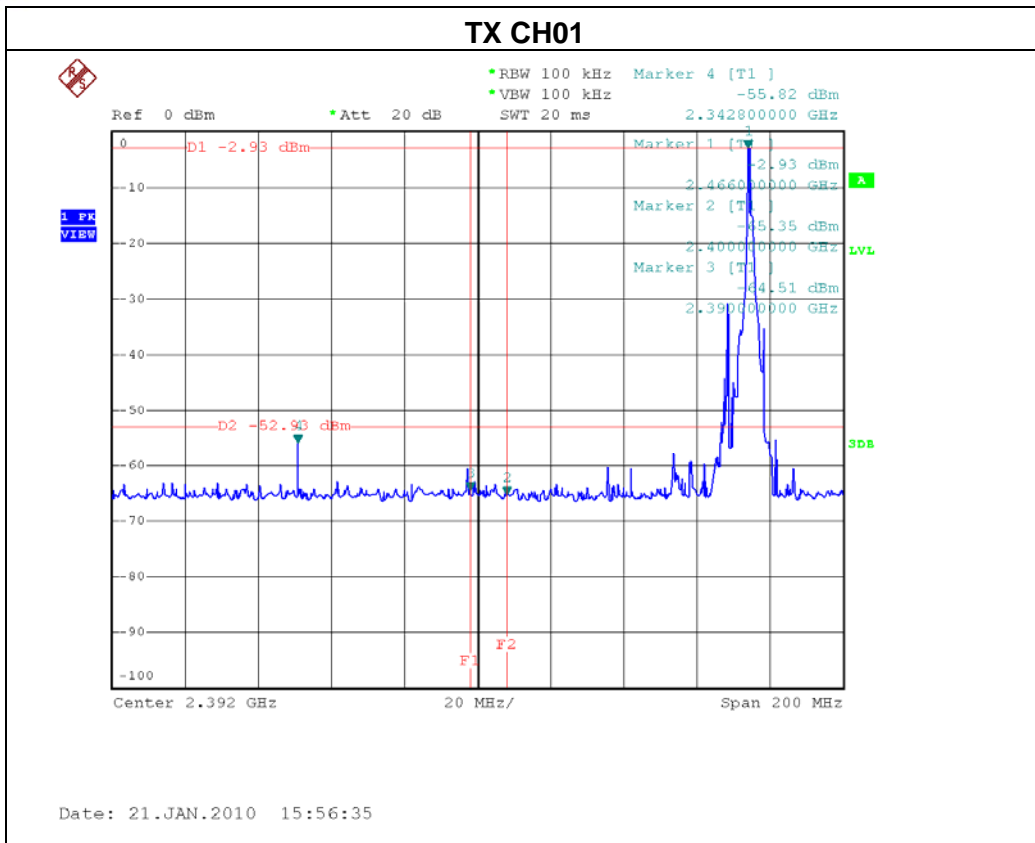



**7. EUT TEST PHOTO**

**Radiated Measurement Photos**

