



# **CONTROL UNIT CU458-2**

## **Installation Instructions**

**(Translation of the original installation instructions)**



# Foreword

## Document revision history

Version	Date	Modification, change
1.0	03/2020	First release

## Disclaimer and exclusion of liability

DewertOkin is not responsible for damage resulting from:

- failure to observe these instructions,
- changes made to this product which have not been approved by DewertOkin, or
- the use of replacement parts which have not been approved or manufactured by DewertOkin.

- ▶ We reserve the right to make unannounced technical changes in the course of our continual product improvement process!

## Creation of a complete operating instruction manual for the entire end product

These instructions are only intended to be used by the end-product manufacturer. They should not be given to the operator of the end product. The factual information contained within may be used as a basis when creating the end-product manual.

The warning and danger notices are best suited for use in the end product's manual. However, it is not sufficient to simply follow these notices. You should also carry out an internal risk assessment for your end product. This can then be used as the basis for the safety notices in your manual.

These installation instructions do not contain all information required to safely operate the end product. They only describe the installation and operation of the product as partially completed machinery.

The instructions are intended for the technicians responsible for manufacturing an end product and not for the operators of the end product.

# Table of Contents

<b>Foreword</b>	<b>3</b>
Document revision history	3
Disclaimer and exclusion of liability	3
Creation of a complete operating instruction manual for the entire end product	3
<b>Table of Contents</b>	<b>4</b>
<b>1. General Information</b>	<b>5</b>
1.1 Configurations	5
1.2 About these installation instructions	5
1.3 Conventions used	5
<b>2. Safety notices</b>	<b>6</b>
2.1 Proper and intended usage	6
2.2 Selection and qualification of personnel	7
2.3 Ratings plate	8
<b>3. Possible combinations</b>	<b>9</b>
<b>4. Description</b>	<b>10</b>
4.1 Components	10
<b>5. Technical specifications</b>	<b>11</b>
<b>6. Installation</b>	<b>13</b>
6.1 Safety notices to observe during installation	13
6.2 Installation procedure	13
<b>7. Information about creating your Operating Manual</b>	<b>16</b>
7.1 General information	16
7.2 Configuring the hand-held remote and app	17
<b>8. Troubleshooting</b>	<b>19</b>
<b>9. Maintenance</b>	<b>20</b>
9.1 Cleaning and care	20
<b>10. Disposal</b>	<b>21</b>
10.1 Packaging material	21
10.2 Components in the control unit	21
<b>Additional information</b>	<b>22</b>

# 1. General Information

## 1.1 Configurations

The designation CONTROL UNIT is used in these installation instructions to refer to the CONTROL UNIT CU458-2.

## 1.2 About these installation instructions

In order to install the CONTROL UNIT successfully and safely in the end product, these installation instructions must be observed. These instructions are not an operating manual for the end product.

These instructions will help you to minimize danger, repair costs and down times. They will also help you to increase the reliability and lifespan of the device.



### CAUTION

The notices in these instructions must be followed! Following the guidelines during installation and connection procedures will help to minimize:

- the risk of accident and injury, and
- damage to the CONTROL UNIT or the end product.

These installation instructions have been written with due care and attention. However, we cannot guarantee that the data, images and drawings are complete and correct nor do we accept any liability for the information contained therein, unless required by law.

## 1.3 Conventions used

Notices which do not relate to safety are indicated in these instructions with a symbol:

- ▶ Triangular notice symbol

### Explanations of warning notices



### CAUTION

CAUTION indicates a hazardous situation which, if not avoided, could result in minor or moderate injury.

### NOTICE

NOTICE is used to address practices which are not related to personal injury but may result in damage to the product or surroundings.

## 2. Safety notices

### 2.1 Proper and intended usage

The CONTROL UNIT is intended for use:

- as a control unit for suitable DewertOkin drive systems,
- for HOME applications (in beds, reclining chairs, etc.).



#### CAUTION

##### Risk of accident

This CONTROL UNIT should only be used for the applications described above. Any other use is forbidden. Improper usage can lead to accidents or destruction of the unit. Such non-approved applications will lead immediately to the expiration of all guarantee and warranty claims on the part of the end-product manufacturer against the manufacturer.

#### 2.1.1 Improper usage

Be sure to follow the notices below concerning improper usage. You should include them in your product manual in order to inform the users of your end product.

The CONTROL UNIT should not be used:

- in any environment where combustible or explosive gases or vapours (e.g., anaesthesiology) may be present,
- in the proximity of open fires or other heat sources (such as furnaces, ovens or direct sunlight),
- as a power source for toys or games,
- in any application that will be cleaned with an automated washing system,
- in a moist environment, or
- outdoors.

The CONTROL UNIT can be used by children of 8 years and older, persons with reduced physical, sensory or mental capabilities, or persons with lack of experience or knowledge when they are supervised or instructed concerning the safe use of the device and when they understand the resulting risks. Do not allow children to play with this device. The cleaning and user maintenance must not be carried out by children without supervision.

- ▶ You should only use spare parts which have been manufactured or approved by DewertOkin. Only these parts will guarantee a sufficient level of safety.

## 2.2 Selection and qualification of personnel

The installation of the CONTROL UNIT in the end product may only be performed by qualified personnel.

### 2.2.1 Electrical safety



#### CAUTION

##### Electric shock

Be careful; there is a risk of electrical shock! Before installing, make sure that you disconnect the external DewertOkin power supply for the CONTROL UNIT from the power outlet!

The CONTROL UNIT should not be used! You must properly dispose of malfunctioning or broken units.

### 2.2.2 Floor (under-bed) lighting

The CONTROL UNIT is equipped with two floor (under-bed) LEDs.



#### CAUTION

Do not look straight into the LED and do not aim the LED at persons.

### 2.3 Ratings plate

- ▶ The ratings plate shown is an example; The specifications for your CONTROL UNIT may differ from this illustration.

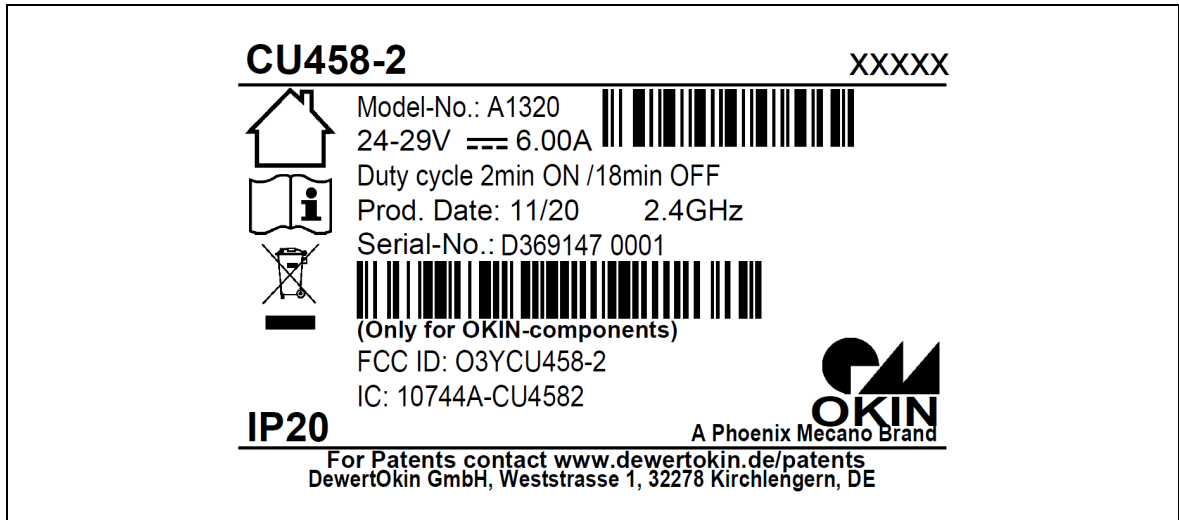





Figure 1 Ratings plate for the CONTROL UNIT (example)

CU458-2	Product name
xxxxx	Article number
Model No.	Model number
24 – 29 V ~ 6.00 A	Input voltage and current consumption
Duty cycle: 2 min ON / 18 min OFF	Intermittent operations: 2 minutes / 18 minutes
Prod. Date	Calendar week / year
2.4GHz	Radio frequency
Serial No.	Serial number
FCC ID: O3YCU458-2	Federal Communications Commission ID
IC:10744A-CU4582	Industry Canada identifier
IP20	Protection degree
	Use in dry rooms only!
	Always follow the instructions in the manual!
	Follow all special disposal instructions!



### 3. Possible combinations

The CONTROL UNIT can be used together with multiple drives, vibration motors and accessories that have been approved by DewertOkin.

A tailored system consists of the combination of control unit, drive, vibration motor, accessories, and hand-held remote.

DewertOkin has separate system instruction manuals containing the additional information and instructions needed for these systems.

- ▶ Detailed information on combination possibilities can be requested directly from DewertOkin.

## 4. Description

The CONTROL UNIT is a control unit and for one or more DewertOkin vibration motors. An external DewertOkin power supply unit is used to connect the CONTROL UNIT to the mains power.

### 4.1 Components

The housing of the CONTROL UNIT has a connection for an external DewertOkin drive system, as well as connections for vibration motors and various accessories. Multiple drives (e.g. the Delta drive and Alpha drive) and vibration motors can be connected to the CONTROL UNIT.

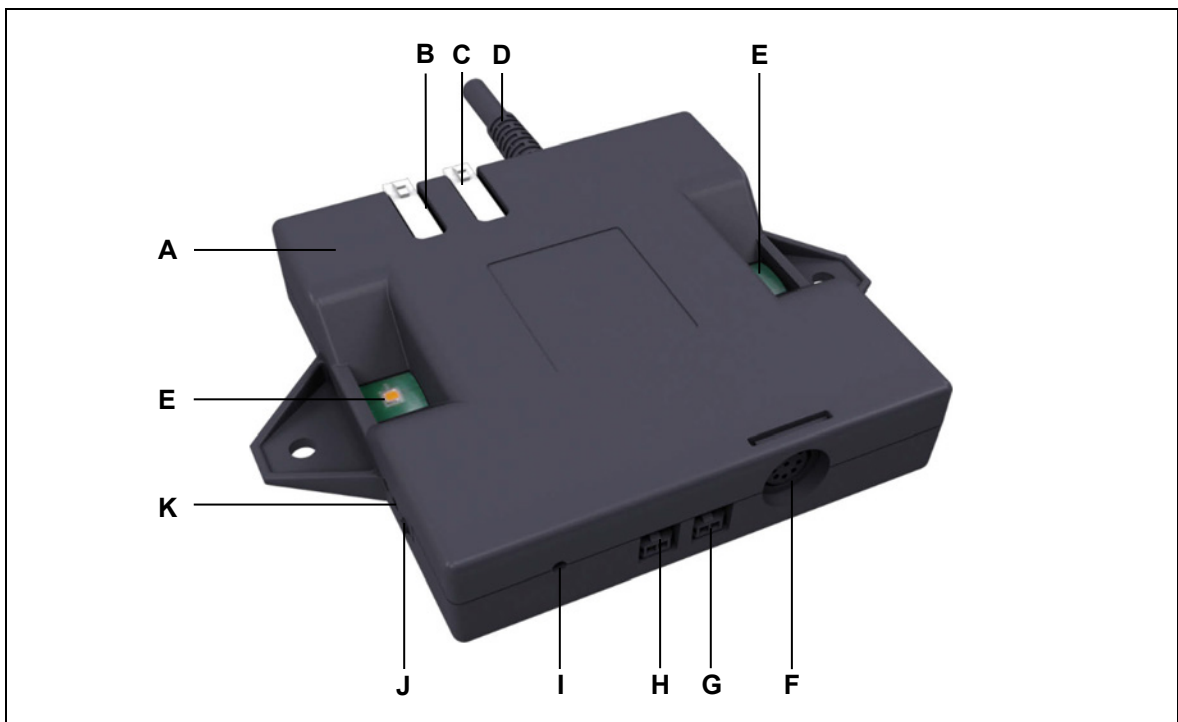

Figure 2 Connections and ports on the CONTROL UNIT CU458-2

- |  |  |
|--|--|
| <b>A</b> CONTROL UNIT CU458-2  | <b>B</b> Port for vibration motor          |
| <b>C</b> Port for vibration motor  | <b>D</b> Port for supply voltage to drives |
| <b>E</b> Floor (under-bed) lighting  | <b>F</b> Multi-functional port (MFP)       |
| <b>G</b> Port for accessories  | <b>H</b> Port for accessories              |
| <b>I</b> Power LED (lights up whenever the CONTROL UNIT is connected to power) | <b>J</b> Reset button / Pairing button     |
| <b>K</b> Pairing LED   |  |

## 5. Technical specifications

Input voltage	24 – 29 V DC
Current consumption at nominal operations	Max. 6 A in intermittent operations
Mode of operations <sup>1</sup>	Intermittent duty 2 min./18 min.
Protection class	III
Protection degree	IP20
<b>Dimensions and weight</b>	
Length x width x height	182 mm x 135 mm x 30 mm
Weight	Approx. 300 g
<b>Ambient conditions for operation, storage and transport</b>	
Transport / storage temperature	From -20 °C to +50 °C From -4 °F to +122 °F
Operating temperature	From +10 °C to +40 °C From +50 °F to +104 °F
Relative humidity	From 30% to 75%
Air pressure	From 800 hPa to 1060 hPa
Height	< 2000 m

- <sup>1)</sup> Mode of operation: intermittent duty 2 minutes/18 minutes. This means that after the unit is operated with its rated load for up to two minutes it must then be paused for 18 minutes. The system can malfunction if this pause is not observed!

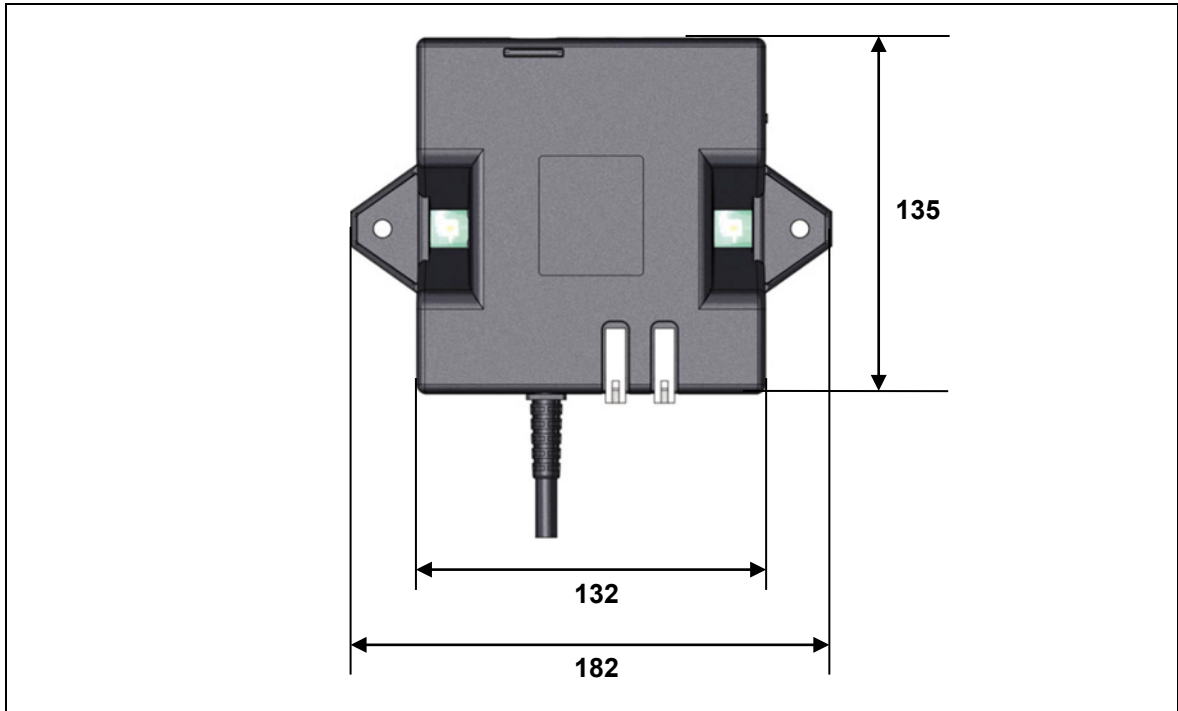

Figure 3 Dimensions of the CONTROL UNIT, top view (in mm)

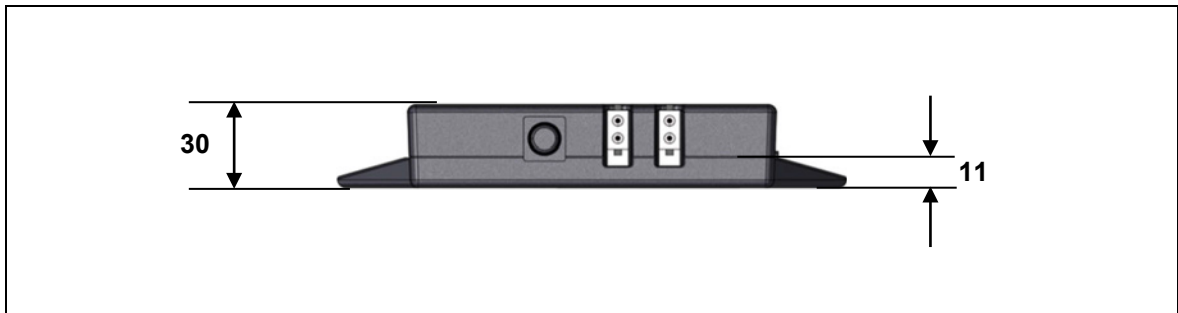

Figure 4 Dimensions of the CONTROL UNIT, side view (in mm)

## 6. Installation

### 6.1 Safety notices to observe during installation

Basic safety rules must be followed in order to ensure that the end product can be continually operated in a safe manner. These rules must be observed while using the end product and while installing the CONTROL UNIT in the end product.

#### 6.1.1 Ensuring operational reliability during installation

The safety and reliability of the end product containing DewertOkin components can be ensured by using the proper construction methods as described below.

### 6.2 Installation procedure

Before installing and connecting the CONTROL UNIT, make sure that you are observing all of the safety notices found in the "Safety notices to observe during installation" section.

#### 6.2.1 Mounting the CONTROL UNIT to the end product

Two screws should be used at the two mounting points to attach the CONTROL UNIT to the end product.

- ▶ The drilling dimensions shown in Figure 5 only illustrate an example and are not necessarily authoritative for all applications.

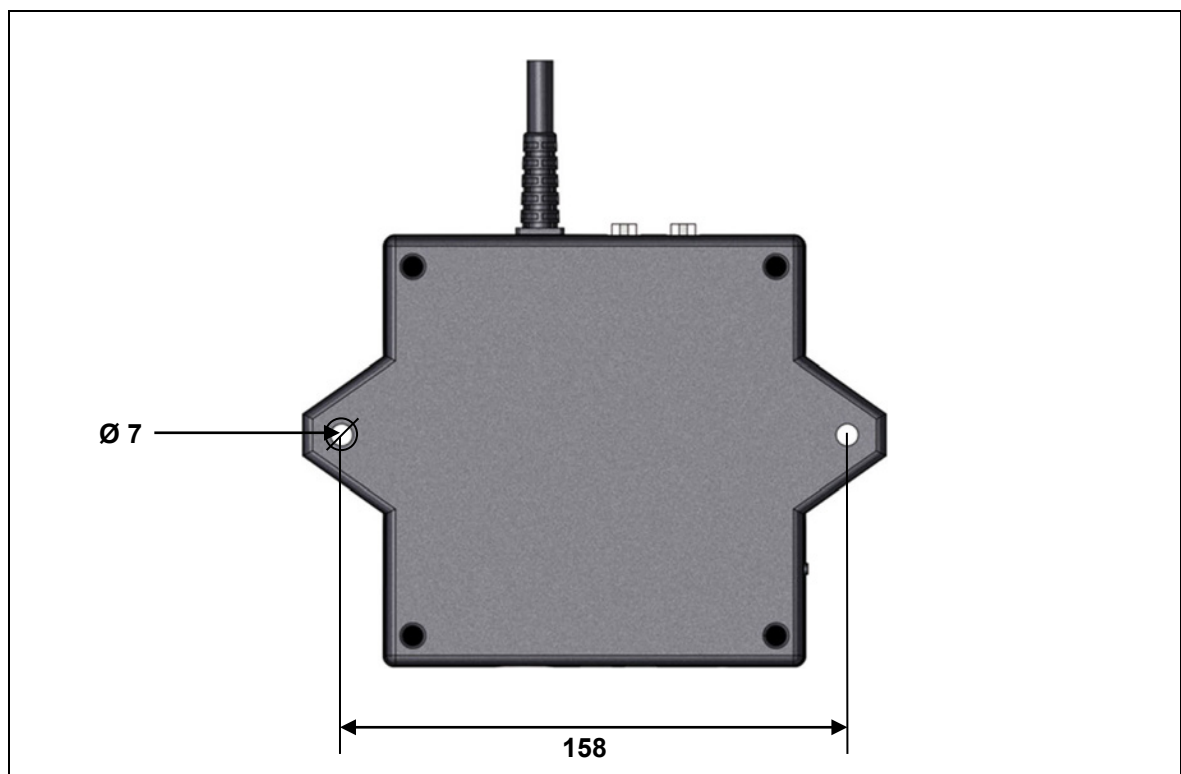

Figure 5 Drilling dimensions (example): Mounting points on the CONTROL UNIT (in mm)

**CAUTION**

You should only connect and disconnect the cables when they are completely disconnected from any live current!

Pull out the power supply plug from the plug socket.

Screw the control unit onto the end product (as shown in Figure 6). Use the mounting holes shown in Figure 5 located on the control unit. Use screws meeting the requirements of DIN 7049 with 4.8 mm diameter and of suitable length (5 mm plus the screw-in depth into the end product).

Proceed with the installation as follows:

- 1 Mark the drill holes.
- 2 Drill the two holes for the screws in the end product.
- 3 Screw in the two screws so the CONTROL UNIT is securely mounted to the end product.

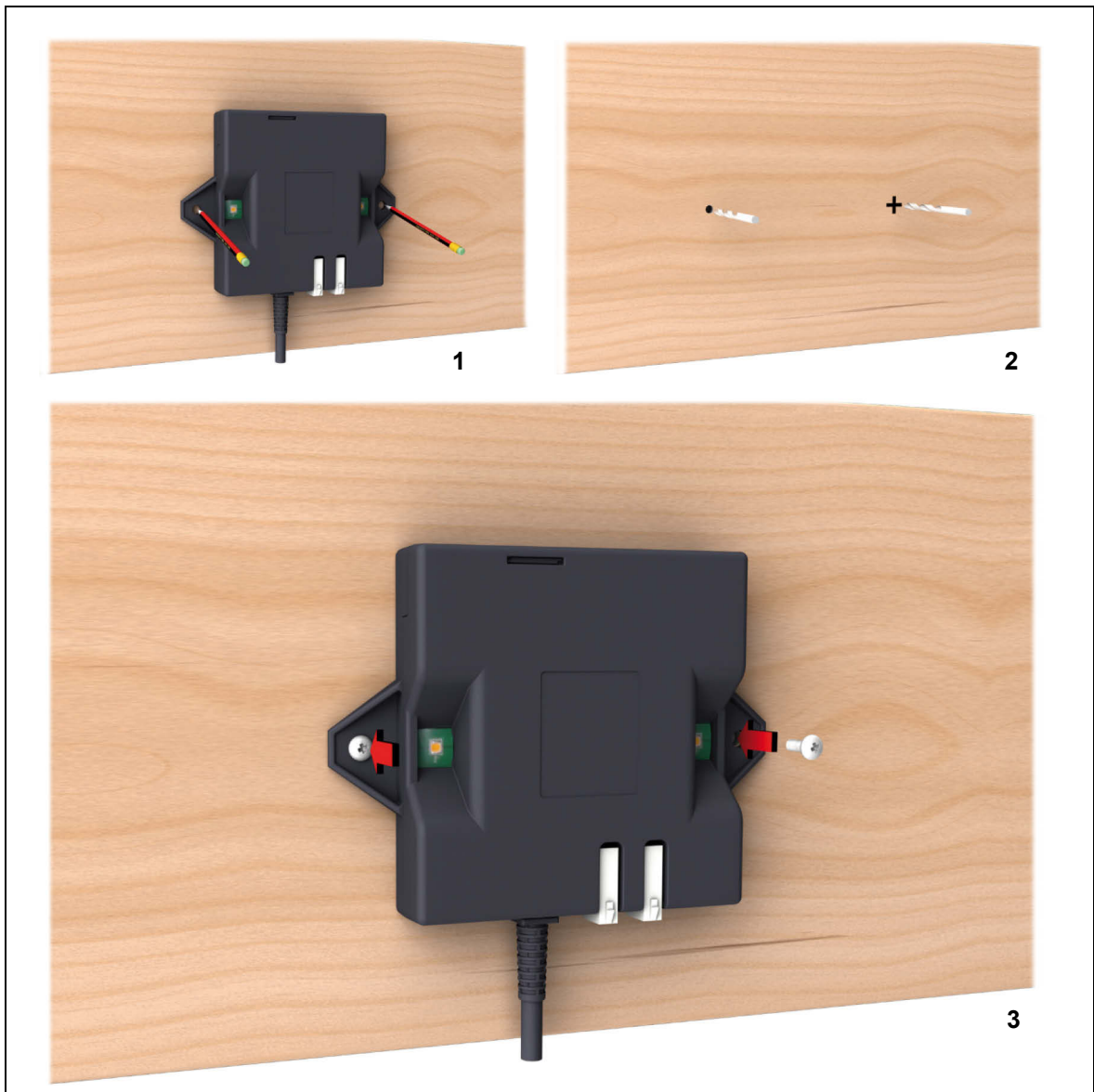

Figure 6 Installing the CONTROL UNIT

## 6.2.2 Electrical connection



### CAUTION

#### Electric shock

Electrical components should be connected or disconnected only when the power supply is unplugged.

- ▶ There is a delay after the supply voltage is applied before the device actually turns on. Wait at least 2 seconds before initial commissioning.

#### Routing the electrical cables

When routing the cables, be sure that:

- the cables cannot get jammed,
- no mechanical load (such as pulling, pushing or bending) will be put on the cables, and
- the cables cannot be damaged in any way.

Fasten all cables (especially the connecting cables) to the end product using sufficient kink prevention methods. Be sure that the design of the end product prevents the connecting cables from coming into contact with the floor during transport.

#### Connecting the vibration motors, the additional drives and the optional accessories

Make sure that you disconnect the components from all power sources before connecting them to the CONTROL UNIT (refer to Figure 2 for the proper connection for each component).



### CAUTION

#### Electric shock

You should only connect and disconnect the cables when they are completely disconnected from any live current!

Pull out the power supply plug from the plug socket.

## 7. Information about creating your Operating Manual

The factual information contained within may be used when you are creating the end-product manual. The installation instructions do not contain all information required for the safe operation of the end product. They only describe the assembly and operation of the CONTROL UNIT as a partially assembled piece of machinery.

- ▶ When creating the operating instructions, remember that the installation instructions are intended for qualified specialists and are not for typical users of the end product.

### 7.1 General information

- ▶ You should only connect drives, vibration motors and accessories from DewertOkin to the CONTROL UNIT. Only DewertOkin components have been verified to work when combined together.

#### Delayed start-up

Please note the following after plugging the power plug into the power outlet:

- ▶ There is a delay after the supply voltage is applied before the device actually turns on. Wait at least 2 seconds before initial commissioning.

#### Power-on time / intermittent operations

The CONTROL UNIT has been designed for intermittent operations. Intermittent operation is an operational mode where the drive must pause after a specified maximum period of operation (power-on time). This protects the drive from overheating. Extreme overheating can cause a malfunction.

- ▶ The ratings plate specifies the maximum power-on time and the required pause intervals.

#### Avoiding electrical risks

 <b>CAUTION</b>
<b>Electric shock</b> Make sure that no live (current-carrying) parts of the control system and power supply can be touched. In particular, be sure that unused power and control unit connections are covered adequately.

 <b>CAUTION</b>
<b>Risk of accident</b> Please follow these operating instructions carefully. You could be injured by fire or electrical shock if you do not follow these assembly instructions.



### Shutting down the CONTROL UNIT in the event of an emergency

In an emergency, disconnect the mains power plug from its socket in order to shut off the connected drive, the accessory, and the vibration motors. The power plug must always be accessible during operations so that it is possible to shut down the CONTROL UNIT.

### Avoiding cable damage

Be sure that your operating instructions inform the user about the possible cable risks.



#### CAUTION

##### Risk of accident



The cables (particularly the connecting cable) should not be run over. In order to prevent injuries or damage to the drive and CONTROL UNIT, no mechanical strain should be placed on the cables.

## 7.2 Configuring the hand-held remote and app

The hand-held remote and app can be paired automatically (see chapter 7.2.1, page 17) or manually (see chapter 7.2.2, page 18).

In order to use the hand-held remote RF1058 or a *Bluetooth*<sup>®</sup> device, establish the radio link with the CONTROL UNIT. **Requirement:** To operate your system with a *Bluetooth*<sup>®</sup> device (e.g.: smartphone/tablet), download the "OKIN" app from the appropriate platform and install it on your device.

### 7.2.1 Automatic configuration



- ▶ The floor lighting will flash twice to acknowledge successful completion of the process.
- 1 Insert the power plug into a power outlet.  
The CONTROL UNIT remains in pairing mode for 120 seconds. The pairing mode is split as follows:
    - A RF1058 hand-held remote can be paired in the first 60 seconds.
    - A *Bluetooth*<sup>®</sup> device can be paired in the second 60 seconds.
- ▶ During the RF1058 pairing phase, the floor (under-bed) LED and the pairing LED on the CONTROL UNIT light up.
- 2 Press the  +  buttons on the RF1058 hand-held remote simultaneously (see RF1058 hand-held remote instructions). A successful pairing will be acknowledged.
    - ▶ The floor lighting will switch off after the pairing process for the hand-held remote RF1058 is finished. The pairing LED for pairing a *Bluetooth*<sup>®</sup> device starts flashing.
    - ▶ The pairing LED switches off when the *Bluetooth*<sup>®</sup> pairing process has timed out or when the device has connected successfully. A successful pairing will be acknowledged.

- 3 If, during the RF1058 remote's pairing process, you press any button on an already paired RF1058 hand-held remote, then it switches to the *Bluetooth*<sup>®</sup> pairing mode.
  - ▶ If the RF1058 remote or a *Bluetooth*<sup>®</sup> device is discovered during the pairing phase, then this pairing mode is automatically ended. The floor lighting and the pairing LED switch off.
- 4 If automatic configuration must be repeated: Remove the plug from the power supply and wait 60 seconds. Then insert the plug back into the power supply. You can then start the new pairing process.

**NOTICE**

Only start **one** system at a time. Never configure multiple systems simultaneously.

### 7.2.2 Manual configuration

- ▶ The floor lighting will flash twice to acknowledge successful completion of the process.
- 1 Insert the power plug into a power outlet.
  - 2 Press the Reset button on the CONTROL UNIT twice in quick succession (see Figure 2, page 10). The floor lighting and the pairing LED light up. The CONTROL UNIT remains in pairing mode for 120 seconds. The pairing mode is split as follows:
    - A RF1058 hand-held remote can be paired in the first 60 seconds.
    - A *Bluetooth*<sup>®</sup> device can be paired in the second 60 seconds.
  - ▶ During the RF1058 pairing phase, the floor (under-bed) LED and the pairing LED on the CONTROL UNIT light up.
  - 3 Press the  +  buttons on the RF1058 hand-held remote simultaneously (see RF1058 hand-held remote instructions). A successful pairing will be acknowledged.
    - ▶ The floor lighting will switch off after the pairing process for the hand-held remote RF1058 is finished. The pairing LED for pairing a *Bluetooth*<sup>®</sup> device starts flashing.
    - ▶ The pairing LED switches off when the *Bluetooth*<sup>®</sup> pairing process has timed out or when the device has connected successfully. A successful pairing will be acknowledged.

**NOTICE**

Only start **one** system at a time. Never configure multiple systems simultaneously.

## 8. Troubleshooting

This chapter describes troubleshooting methods for fixing problems. If you experience an error that is not listed in this table, please contact your supplier.

- ▶ Only qualified specialists who have received electrician training should carry out troubleshooting and repairs.

Problem	Possible cause	Solution
The drive, accessory or vibration motor is not functioning.	There is no mains supply voltage.	Connect the mains power.
	The vibration motor or accessory is defective.	Please contact your supplier or sales agent.
	Hand-held remote not paired.	Pair the hand-held remote.
	The hand-held remote batteries are empty.	Replace the batteries.
The drive or vibration motors are suddenly not capable of movement.	The unit's fuse may have been triggered.	Please contact your supplier or sales agent.
	The hand-held remote batteries are empty.	Replace the batteries.
	Radio interference	Try to re-establish the wireless connection.
	There is no mains supply voltage.	Connect the mains power.
	A cable has been disconnected (to the mains power, vibration motors, drives or accessory).	Check the cables and reinsert them, if required.

## 9. Maintenance

- ▶ The CONTROL UNIT requires no maintenance.

### 9.1 Cleaning and care

The CONTROL UNIT was designed so that it would be easy to clean. Its smooth surfaces simplify the cleaning process.

- ▶ Clean the CONTROL UNIT as needed using a dry cloth.

<b>NOTICE</b>
<ul style="list-style-type: none"><li>• Always disconnect the power supply plug before you start to clean!</li><li>• Never clean the CONTROL UNIT in an automated washing system or with a high-pressure cleaner. Do not allow fluids to penetrate the lighting. Damage to the system could result.</li><li>• Do not use a cleanser that contains benzene, alcohol or similar solvents.</li><li>• Be sure that you do not damage the connecting cables during the cleaning.</li></ul>

## 10. Disposal

### 10.1 Packaging material

The packaging material should be sorted into recyclable components and then disposed of in accordance with the appropriate national environmental regulations (in Germany according to the recycling law KrWG from 01.06.2012; internationally according to the EU Directive 2008/98/EC (Waste Framework Directive WFD as of 12.12.2008)).

### 10.2 Components in the control unit

The CONTROL UNIT consists of electronic components, cables and metal and plastic parts. You should observe all corresponding national and regional environmental regulations when disposing of the system.

The disposal of the product is regulated in Germany by Elektro-G, internationally by the EU Directive 2012/19/EC (WEEE), or by any applicable national laws and regulations.



The CONTROL UNIT should not be disposed of with normal household waste!

## **Additional information**

### **CONTROL UNIT CU458-2**

- UL962
- CSA C22.2 No. 68-09

### **FCC Warning**

This device complies with Part 15 of the FCC rules. Operation is subject to the following two conditions:

- (1) this device may not cause harmful interference, and
- (2) this device must accept any interference received, including interference that may cause undesired operation.

### **IC Warning**

This device contains licence-exempt transmitter(s)/receiver(s) that comply with Innovation, Science and Economic Development Canada's licence-exempt RSS(s). Operation is subject to the following two conditions:

- (1) This device may not cause interference.
- (2) This device must accept any interference, including interference that may cause undesired operation of the device.

NOTE: This equipment has been tested and found to comply with the limits for a Class B digital device, pursuant to part 15 of the FCC Rules. These limits are designed to provide reasonable protection against harmful interference in a residential installation. This equipment generates uses and can radiate radio frequency energy and, if not installed and used in accordance with the instructions, may cause harmful interference to radio communications. However, there is no guarantee that interference will not occur in a particular installation. If this equipment does cause harmful interference to radio or television reception, which can be determined by turning the equipment off and on, the user is encouraged to try to correct the interference by one or more of the following measures:

- Reorient or relocate the receiving antenna.
- Increase the separation between the equipment and receiver.
- Connect the equipment into an outlet on a circuit different from that to which the receiver is connected.
- Consult the dealer or an experienced radio/TV technician for help

Changes or modifications not expressly approved by the party responsible for compliance could void the user's authority to operate the equipment.

L'émetteur/récepteur exempt de licence contenu dans le présent appareil est conforme aux CNR d'Innovation, Sciences et Développement économique Canada applicables aux appareils radio exempts de licence. L'exploitation est autorisée aux deux conditions suivantes :

- (1) L'appareil ne doit pas produire de brouillage;
- (2) L'appareil doit accepter tout brouillage radioélectrique subi, même si le brouillage est susceptible d'en compromettre le fonctionnement.



DewertOkin GmbH  
Weststrasse 1  
Kirchlengern 32278, Germany  
Tel: +49 (0)5223/979-0  
Fax.: +49 (0)5223/75182  
<http://www.dewertokin.de>  
[Info@dewertokin.de](mailto:Info@dewertokin.de)

ID No.: 93728