

ENGINEERING TEST REPORT

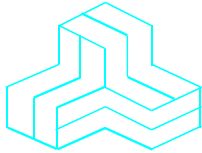

NBS55XX
Model No.: NBS55XXTXXX

Tested For

NBS Technologies Inc.
703 Evans Ave., Suite 400
Toronto, ON
Canada M9C 5E9

In Accordance With

**SAR (Specific Absorption Rate) Requirements
using guidelines established in IEEE C95.1-1991,
FCC OET Bulletin 65 (Supplement C),
Industry Canada RSS-102(Issue 2) and
ACA Radiocommunications (Electromagnetic Radiation – Human Exposure)
Amendment Standard 2000 (No. 1)**

UltraTech's File No.: MIS-053-SAR

This Test report is Issued under the Authority of
Tri M. Luu, Professional Engineer,
Vice President of Engineering
UltraTech Group of Labs



Date: March 27, 2006

Report Prepared by:
JaeWook Choi

Tested by:
Carolyn Luu

Issued Date:
March 27, 2006

Test Dates:
March 16 – March 17 & March 20 – March 21,
2006

The results in this Test Report apply only to the sample(s) tested, which has been randomly selected.

UltraTech

3000 Bristol Circle, Oakville, Ontario, Canada, L6H 6G4
Telephone (905) 829-1570 Facsimile (905) 829-8050
Website: www.ultratech-labs.com Email: vic@ultratech-labs.com

TABLE OF CONTENTS

EXHIBIT 1. INTRODUCTION	5
1.1. SCOPE	5
1.2. REFERENCES.....	5
EXHIBIT 2. PERFORMANCE ASSESSMENT	6
2.1. CLIENT AND MANUFACTURER INFORMATION	6
2.2. DEVICE UNDER TEST (D.U.T.) DESCRIPTION.....	6
2.3. LIST OF D.U.T.'S ACCESSORIES:.....	7
2.4. SPECIAL CHANGES ON THE D.U.T.'S HARDWARE/SOFTWARE FOR TESTING PURPOSES	7
2.5. ANCILLARY EQUIPMENT	7
2.6. GENERAL TEST CONFIGURATIONS	7
2.6.1. <i>Equipment Configuration</i>	7
2.6.2. <i>Exercising Equipment</i>	7
2.7. SPECIFIC OPERATING CONDITIONS.....	7
2.8. BLOCK DIAGRAM OF TEST SETUP	8
EXHIBIT 3. SUMMARY OF TEST RESULTS	9
3.1. LOCATION OF TESTS	9
3.2. APPLICABILITY & SUMMARY OF SAR RESULTS.....	9
EXHIBIT 4. MEASUREMENTS, EXAMINATIONS & TEST DATA	10
4.1. TEST SETUP	10
4.2. PHOTOGRAPH OF D.U.T. AND ALL ACCESORIES.....	11
4.3. PHOTOGRAPHS OF D.U.T. POSITION	14
4.3.1. <i>Body Configuration</i>	14
4.3.1.1. Right side of DUT in parallel to the phantom with spacing of 10 mm.....	14
4.3.1.2. Back side of DUT in parallel to the phantom with spacing of 10 mm	15
4.3.1.3. Top of DUT perpendicular to the phantom with spacing of 10 mm	16
4.4. MAXIMUM PEAK SPATIAL-AVERAGE SAR.....	17
4.4.1. <i>Maximum Peak Spatial-average SAR Data</i>	17
4.4.2. <i>Maximum Peak Spatial-Average SAR Location</i>	17
4.5. SAR MEASUREMENT DATA	18
4.5.1. <i>Body Configuration Result</i>	18
4.5.1.1. CDMA	18
4.5.1.2. PCS CDMA	19
4.5.2. <i>Power Measurement</i>	20
4.5.2.1. RF Conducted Power Measurement	20
4.5.2.2. Power Drift	20
EXHIBIT 5. SAR SYSTEM CONFIGURATION & TEST METHODOLOGY	21
5.1. MEASUREMENT SYSTEM SPECIFICATIONS.....	21
5.2. TEST PROCEDURES	21
5.3. PHANTOM	21
5.4. SIMULATED TISSUE	22
5.4.1. <i>Preparation</i>	23
5.5. MEASUREMENT OF ELECTRICAL CHARACTERISTICS OF SIMULATED TISSUE.....	23
5.5.1. <i>Slotted Coaxial Waveguide</i>	23

5.5.1.1.	Equipment set-up.....	23
5.5.1.2.	Measurement procedure.....	24
5.5.2.	<i>HP Dielectric Strength Probe System (open-ended coaxial transmission-line probe/sensor)</i>	24
5.5.2.1.	Equipment set-up.....	24
5.5.2.2.	Measurement procedure.....	25
5.6.	SYSTEM CALIBRATION.....	27
5.6.1.	<i>Probe linearity</i>	27
5.6.2.	<i>Free Space Calibration</i>	27
5.6.2.1.	Method.....	28
5.6.2.2.	Measurement procedure.....	28
5.6.2.3.	Definition of Amplifier Settings.....	29
5.6.3.	<i>Calculable Waveguide Calibration</i>	30
5.6.3.1.	Measurement Procedure.....	30
5.6.4.	<i>Thermal Transfer Calibration</i>	33
5.6.4.1.	Measurement procedure.....	33
5.6.4.2.	Determination of Conversion Factor (γ) in the simulated tissue.....	34
5.6.5.	<i>Data Acquisition Methodology</i>	36
5.6.5.1.	E-Field Measurement.....	36
5.6.5.2.	Sensitivity(ζ) of probe in the simulated tissue.....	36
5.6.5.3.	SAR Measurement.....	37
5.6.5.4.	Data Extrapolation and boundary effect.....	40
5.6.6.	<i>Determining the Heat Capacity of Simulated Tissue</i>	41
5.6.6.1.	Instruments and Materials.....	41
5.6.6.2.	Method.....	41
5.6.6.3.	Rationale.....	42
5.7.	SAR MEASUREMENT SYSTEM VERIFICATION.....	43
5.7.1.	<i>Standard Source</i>	43
5.7.2.	<i>Standard Source Input Power Measurement</i>	43
5.7.3.	<i>System Validation Procedure</i>	44
5.8.	POWER MEASUREMENT.....	45
5.9.	POSITIONING OF D.U.T.	46
5.10.	SAR MEASUREMENT UNCERTAINTY.....	48
5.10.1.	<i>Measurement Uncertainty</i>	49
5.10.1.1.	Measurement Uncertainty evaluation for handset SAR test.....	49
5.10.1.2.	Measurement Uncertainty for System Performance Check.....	50
EXHIBIT 6.	SAR PRESCANS	51
6.1.1.	<i>Body Configuration</i>	51
6.1.1.1.	Test configurations used.....	51
6.1.1.2.	Equipment permutation investigated for each orientation.....	51
6.1.1.3.	Comments on non-tested configurations.....	51
6.2.	RECOMMENDED CAUTION STATEMENTS TO BE INCLUDED IN USERS MANUAL.....	52
EXHIBIT 7.	SAR MEASUREMENT	53
7.1.	BODY CONFIGURATION.....	53
7.1.1.	<i>CDMA</i>	53
7.1.1.1.	Right Side of D.U.T. in parallel to the phantom with spacing of 10 mm, 824.70 MHz; #01.....	54
7.1.1.2.	Right Side of D.U.T. in parallel to the phantom with spacing of 10 mm, 836.52 MHz; #02.....	57
7.1.1.3.	Right Side of D.U.T. in parallel to the phantom with spacing of 10 mm, 848.97 MHz; #03.....	60
7.1.1.4.	Back Side of D.U.T. in parallel to the phantom with spacing of 10 mm, 836.52 MHz; #05.....	63
7.1.1.5.	Top of D.U.T. perpendicular to the phantom with spacing of 10 mm, 836.52 MHz; #08.....	66
7.1.2.	<i>PCS CDMA</i>	69
7.1.2.1.	Right Side of D.U.T. in parallel to the phantom with spacing of 10 mm, 1880.0 MHz; #11.....	70

ULTRATECH GROUP OF LABS

3000 Bristol Circle, Oakville, Ontario, Canada L6H 6G4
 Tel. #: 905-829-1570, Fax. #: 905-829-8050, Email: vic@ultratech-labs.com, Website: http://www.ultratech-labs.com

File #: MIS-053-SAR
March 27, 2006

- Assessed by ITI (UK) Competent Body, NVLAP (USA) Accreditation Body & ACA/AUSTEL (Australia), VCCI (Japan)
- Accredited by Industry Canada (Canada) under ACC-LAB (Europe/Canada MRA and APEC/Canada MRA)
- Recognized/Listed by FCC (USA)
- All test results contained in this engineering test report are traceable to National Institute of Standards and Technology (NIST)

7.1.2.2.	Back Side of D.U.T. in parallel to the phantom with spacing of 10 mm, 1880.00 MHz; #14.....	73
7.1.2.3.	Top of D.U.T. perpendicular to the phantom with spacing of 10 mm, 1880.00 MHz; #17.....	76
EXHIBIT 8.	TISSUE DIELECTRIC PARAMETER CALIBRATION	79
8.1.	SIMULATED TISSUE AT 835 MHZ.....	79
8.1.1.	835 MHz Brain Tissue.....	79
8.1.2.	835 MHz Muscle Tissue	79
8.2.	SIMULATED TISSUE AT 1900 MHZ.....	80
8.2.1.	1900 MHz Brain Tissue.....	80
8.2.2.	1900 MHz Brain Tissue.....	80
EXHIBIT 9.	SAR SYSTEM CALIBRATION	81
9.1.	GENERAL INFORMATION OF THE PROBE	81
9.2.	PROBE LINEARITY AND DYNAMIC RANGE	81
9.2.1.	Diode Compression Potential.....	81
9.2.2.	Channel 1	82
9.2.3.	Channel 2	83
9.2.4.	Channel 3	84
9.3.	PROBE ISOTROPY CALIBRATION.....	85
9.3.1.	Calibration Setup	85
9.3.1.1.	835 MHz Setup.....	85
9.3.1.2.	1900 MHz Setup.....	85
9.3.2.	Amplifier Settings	85
9.3.2.1.	Isotropy calibration at 835 MHz	85
9.3.2.2.	Isotropy calibration at 1900 MHz.....	86
9.3.3.	Isotropic response at 835 MHz.....	87
9.3.4.	Isotropic response at 1900 MHz.....	88
9.4.	PROBE THERMAL TRANSFER CALIBRATION	89
9.4.1.	Calibration Setup	89
9.4.1.1.	Setup for 835 MHz	89
9.4.2.	Simulated Tissue.....	90
9.4.2.1.	Brain Tissue at 835 MHz.....	90
9.4.2.2.	Muscle Tissue at 835 MHz.....	90
9.4.3.	Conversion Factor.....	91
9.4.3.1.	Thermal transfer calibration at 835 MHz for simulated brain tissue.....	91
9.4.3.2.	Thermal transfer calibration at 835 MHz for simulated muscle tissue.....	93
9.5.	CALCULABLE WAVEGUIDE CALIBRATION	95
9.5.1.	Calibration Setup	95
9.5.1.1.	Setup for 1900 MHz	95
9.5.2.	Simulated Tissue.....	96
9.5.2.1.	Brain Tissue at 1870 MHz	96
9.5.2.2.	Muscle Tissue at 1900 MHz	96
9.5.3.	Conversion Factor.....	97
9.5.3.1.	Calculable waveguide calibration at 1870 MHz for simulated brain tissue	97
9.5.3.2.	Calculable waveguide calibration at 1900 MHz for simulated muscle tissue	98
EXHIBIT 10.	SAR SYSTEM VERIFICATION USING DIPOLE REFERENCE	99
10.1.	VERIFICATION SETUP	99
10.1.1.	Test setup at 835 MHz using the dipole reference.....	99
10.1.2.	Test setup at 1900 MHz using the dipole reference.....	100
10.2.	SIMULATED TISSUE	101

ULTRATECH GROUP OF LABS

3000 Bristol Circle, Oakville, Ontario, Canada L6H 6G4
 Tel. #: 905-829-1570, Fax. #: 905-829-8050, Email: vic@ultratech-labs.com, Website: http://www.ultratech-labs.com

File #: MIS-053-SAR
March 27, 2006

- Assessed by ITI (UK) Competent Body, NVLAP (USA) Accreditation Body & ACA/AUSTEL (Australia), VCCI (Japan)
- Accredited by Industry Canada (Canada) under ACC-LAB (Europe/Canada MRA and APEC/Canada MRA)
- Recognized/Listed by FCC (USA)
- All test results contained in this engineering test report are traceable to National Institute of Standards and Technology (NIST)

10.2.1. *Simulated brain tissue at 835 MHz* 101

10.2.2. *Simulated brain tissue at 1900 MHz* 101

10.3. VERIFICATION RESULT..... 102

10.3.1. *Reference SAR values for simulated brain tissue at 835 MHz* 102

10.3.2. *Verification at 835 MHz*..... 102

10.3.3. *Reference SAR values for simulated brain tissue at 1900 MHz* 106

10.3.4. *Verification result at 1900 MHz*..... 106

EXHIBIT 11. SAR CALCULATION SUMMARY **110**

11.1. TERMINOLOGY 110

11.1.1. *Sensor factor (η_{pd} and η_{E2}) in the air ($Z_0 = 377[\Omega]$)* 110

11.1.2. *Diode Compensation (Linearity correction)* 110

11.1.3. *Amplifier settings (AS_i) and probe output*..... 110

11.1.4. *Conversion factor (γ) in the simulated tissue* 111

11.1.5. *Conversion factor (γ) Calculation #1 – Thermal Transfer Calibration (Below 1 GHz)*..... 111

11.1.6. *Conversion factor (γ) Calculation #2 – Calculable Waveguide Calibration (Above 1 GHz)*..... 112

11.1.7. *Sensitivity (ζ) in the simulated tissue* 112

11.1.8. *SAR calculation* 112

ULTRATECH GROUP OF LABS

3000 Bristol Circle, Oakville, Ontario, Canada L6H 6G4
Tel. #: 905-829-1570, Fax. #: 905-829-8050, Email: vic@ultratech-labs.com, Website: http://www.ultratech-labs.com

File #: MIS-053-SAR
March 27, 2006

- Assessed by ITI (UK) Competent Body, NVLAP (USA) Accreditation Body & ACA/AUSTEL (Australia), VCCI (Japan)
- Accredited by Industry Canada (Canada) under ACC-LAB (Europe/Canada MRA and APEC/Canada MRA)
- Recognized/Listed by FCC (USA)
- All test results contained in this engineering test report are traceable to National Institute of Standards and Technology (NIST)

EXHIBIT 1. INTRODUCTION

1.1. SCOPE

Reference:	SAR (Specific Absorption Rate) Requirements IEEE C95.1-1991, FCC OET Bulletin 65 (Supplement C Edition 01-01) Industry Canada RSS-102 (Issue 2). ACA Radiocommunications (Electromagnetic Radiation – Human Exposure), Amendment Standard 2000 (No. 1)
Title	Safety Levels with respect to human exposure to Radio Frequency Electromagnetic Fields Guideline for Evaluating the Environmental Effects of Radio Frequency Radiation
Purpose of Test:	To verify compliance with Federal regulated SAR requirements in Canada, Chatswood NSW 2067 and the US.
Method of Measurements:	IEEE C95.1-1991, FCC OET Bulletin 65 (Supplement C Edition 01-01) and Industry Canada RSS-102 (Issue 2)
Device Category	Portable
Exposure Category	General Population/Uncontrolled

1.2. REFERENCES

The methods and procedures used for the measurements contained in this report are details in the following reference standards:

Publications	Year	Title
IEEE Std. 1528/D1.2	2003	Draft Recommended practice for determining the Peak Spatial-Average Specific Absorption rate (SAR) in the Human Body Due to Wireless Communications Devices: Experimental Techniques.
Industry Canada RSS102	2005	"Evaluation Procedure for Mobile and Portable Radio Transmitters with respect to Health Canada's Safety Code 6 for Exposure of Humans to Radio Frequency Fields"
ACA	2000	ACA Radiocommunications (Electromagnetic Radiation – Human Exposure) Amendment Standard 2000 (No. 1)
NCRP Report No.86	1986	"Biological Effects and Exposure Criteria for radio Frequency Electromagnetic Fields"
FCC OET Bulletin 65	1997	"Evaluating Compliance with FCC Guidelines for Human Exposure to radio Frequency Fields"
ANSI/IEEE C95.3	2002	"Recommended Practice for the Measurement of Potentially Hazardous Electromagnetic Fields - RF and Microwave"
ANSI/IEEE C95.1	1992	"Safety Levels with Respect to Human Exposure to Radio Frequency Electromagnetic Fields, 3kHz to 300GHz"
AS/NZS 2722.1	1998	Interim Chatswood NSW 2067n/New Zealand Standard. "Radiofrequency fields, Part 1:Maximum exposure levels – 3kHz to 300GHz "

- Assessed by ITI (UK) Competent Body, NVLAP (USA) Accreditation Body & ACA/AUSTEL (Australia), VCCI (Japan)
- Accredited by Industry Canada (Canada) under ACC-LAB (Europe/Canada MRA and APEC/Canada MRA)
- Recognized/Listed by FCC (USA)
- All test results contained in this engineering test report are traceable to National Institute of Standards and Technology (NIST)

EXHIBIT 2. PERFORMANCE ASSESSMENT

2.1. CLIENT AND MANUFACTURER INFORMATION

APPLICANT:	
Name:	NBS Technologies Inc.
Address:	703 Evans Ave., Suite 400 Toronto, ON Canada M9C 5E9
Contact Person:	Mr. Dragoslav Jovanovic Phone #: +1 416 621 1911 Fax #: +1 416 621 8875 Email Address: djovanovic@nbstech.com

MANUFACTURER:	
Name:	SAGEM Monetel
Address:	1, Rue Claude Chappe – BP 346 Guilherand-Granges France 07503
Contact Person:	Mr. Clement Lormeau Phone #: +33 4 75 81 40 47 Fax #: +33 4 75 81 41 57 Email Address: clement.lormeau@sagem.com

2.2. DEVICE UNDER TEST (D.U.T.) DESCRIPTION

The following is the information provided by the applicant.

Trade Name	NBS Technologies Inc.
Type/Model Number	NBS55XXTXXX
Frequency of Operation	824.70 ~ 848.97 MHz (CDMA) 1851.25 ~ 1908.75 MHz (PCS-CDMA)
Rated RF Output Power	23.5 dBm (CDMA) 23.5 dBm (PCS-CDMA)
Modulation Employed	CDMA
Antenna	SAGEM Monetel Integrated Antenna (M/N: CDMA X930)
Power Supply	Rechargeable Ni-MH battery (3.6 V, 1.5 Ah)
Primary User Functions of D.U.T.	Wireless CDMA POS terminal

ULTRATECH GROUP OF LABS

3000 Bristol Circle, Oakville, Ontario, Canada L6H 6G4
Tel. #: 905-829-1570, Fax. #: 905-829-8050, Email: vic@ultratech-labs.com, Website: <http://www.ultratech-labs.com>

File #: MIS-053-SAR
March 27, 2006

- Assessed by ITI (UK) Competent Body, NVLAP (USA) Accreditation Body & ACA/AUSTEL (Australia), VCCI (Japan)
- Accredited by Industry Canada (Canada) under ACC-LAB (Europe/Canada MRA and APEC/Canada MRA)
- Recognized/Listed by FCC (USA)
- All test results contained in this engineering test report are traceable to National Institute of Standards and Technology (NIST)

2.3. LIST OF D.U.T.'S ACCESSORIES:

Rechargeable Ni-MH battery (3.6 V, 1.5 Ah)

2.4. SPECIAL CHANGES ON THE D.U.T.'S HARDWARE/SOFTWARE FOR TESTING PURPOSES

N/A

2.5. ANCILLARY EQUIPMENT

N/A

2.6. GENERAL TEST CONFIGURATIONS**2.6.1. Equipment Configuration**

Power and signal distribution, grounding, interconnecting cabling and physical placement of equipment of a test system shall simulate the typical application and usage in so far as is practicable, and shall be in accordance with the relevant product specifications of the manufacturer.

The configuration that tends to maximize the D.U.T.'s emission or minimize its immunity is not usually intuitively obvious and in most instances selection will involve some trial and error testing. For example, interface cables may be moved or equipment re-orientated during initial stages of testing and the effects on the results observed.

Only configurations within the range of positions likely to occur in normal use need to be considered.

The configuration selected shall be fully detailed and documented in the test report, together with the justification for selecting that particular configuration.

2.6.2. Exercising Equipment

The exercising equipment and other auxiliary equipment shall be sufficiently decoupled from the D.U.T. so that the performance of such equipment does not significantly influence the test results.

2.7. SPECIFIC OPERATING CONDITIONS

D.U.T. is not designed nor intended to be used in body-worn configuration but in hand-held (palm-top) configuration only under the D.U.T. normal usage condition and the manufacturer does not provide any kind of body-worn accessory. The body configuration was employed as to represent a worst case consideration for RF safety evaluation.

ULTRATECH GROUP OF LABS

3000 Bristol Circle, Oakville, Ontario, Canada L6H 6G4

Tel. #: 905-829-1570, Fax. #: 905-829-8050, Email: vic@ultratech-labs.com, Website: <http://www.ultratech-labs.com>

File #: MIS-053-SAR

March 27, 2006

- Assessed by ITI (UK) Competent Body, NVLAP (USA) Accreditation Body & ACA/AUSTEL (Australia), VCCI (Japan)
- Accredited by Industry Canada (Canada) under ACC-LAB (Europe/Canada MRA and APEC/Canada MRA)
- Recognized/Listed by FCC (USA)
- All test results contained in this engineering test report are traceable to National Institute of Standards and Technology (NIST)

2.8. BLOCK DIAGRAM OF TEST SETUP

The D.U.T. was configured as normal intended use. The following block diagram shows a representative equipment arrangement during tests:

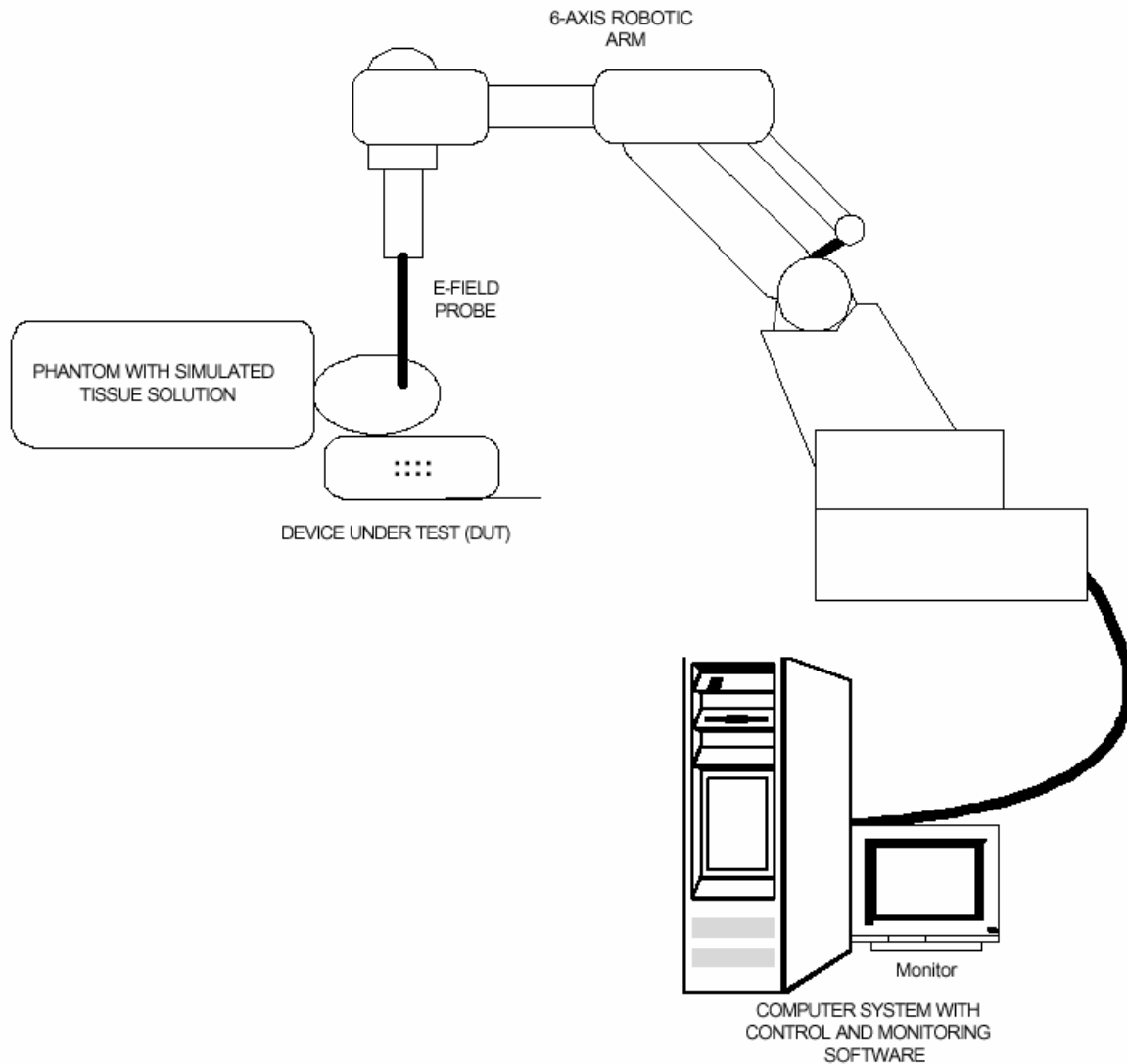

ULTRATECH GROUP OF LABS

3000 Bristol Circle, Oakville, Ontario, Canada L6H 6G4
Tel. #: 905-829-1570, Fax. #: 905-829-8050, Email: vic@ultratech-labs.com, Website: <http://www.ultratech-labs.com>

File #: MIS-053-SAR
March 27, 2006

- Assessed by ITI (UK) Competent Body, NVLAP (USA) Accreditation Body & ACA/AUSTEL (Australia), VCCI (Japan)
- Accredited by Industry Canada (Canada) under ACC-LAB (Europe/Canada MRA and APEC/Canada MRA)
- Recognized/Listed by FCC (USA)
- All test results contained in this engineering test report are traceable to National Institute of Standards and Technology (NIST)

EXHIBIT 3. SUMMARY OF TEST RESULTS

3.1. LOCATION OF TESTS

All of the measurements described in this report were performed at UltraTech Group of Labs located at:
3000 Bristol Circle, in the city of Oakville, Province of Ontario, Canada.

All measurements were performed in UltraTech’s shielded chamber, 24’ x 16’ x 8’.

3.2. APPLICABILITY & SUMMARY OF SAR RESULTS

The maximum peak spatial - average SAR measured was found to be 0.80 W/Kg.

Exposure Category and SAR Limits	Test Requirements	Compliance (Yes/No)
<p>General population/Uncontrolled exposure 0.08W/kg whole body average and spatial peak SAR of 1.6W/kg, averaged over 1gram of tissue Hands, wrist, feet and ankles have a peak SAR not to exceed 4 W/kg, averaged over 10 grams of tissue.</p>	<p>Requirements using guidelines established in IEEE C95.1-1991 FCC OET Bulletin 65 (Supplement C Edition 01-01) Industry Canada RSS-102 (Issue 2). ACA Radiocommunications (Electromagnetic Radiation – Human Exposure) Amendment Standard 2000 (No. 1)</p>	<p>YES</p>
<p>Occupational/Controlled Exposure 0.4W/kg whole body average and spatial peak SAR of 8W/kg, averaged over 1gram of tissue Hands, wrist, feet and ankles have a peak SAR not to exceed 20 W/kg, averaged over 10 grams of tissue.</p>	<p>Requirements using guidelines established in IEEE C95.1-1991 FCC OET Bulletin 65 (Supplement C Edition 01-01), Industry Canada RSS-102 (Issue 2) ACA Radiocommunications (Electromagnetic Radiation – Human Exposure) Amendment Standard 2000 (No. 1)</p>	<p>N/A</p>

ULTRATECH GROUP OF LABS

3000 Bristol Circle, Oakville, Ontario, Canada L6H 6G4
Tel. #: 905-829-1570, Fax. #: 905-829-8050, Email: vic@ultratech-labs.com, Website: http://www.ultratech-labs.com

File #: MIS-053-SAR
March 27, 2006

- Assessed by ITI (UK) Competent Body, NVLAP (USA) Accreditation Body & ACA/AUSTEL (Australia), VCCI (Japan)
- Accredited by Industry Canada (Canada) under ACC-LAB (Europe/Canada MRA and APEC/Canada MRA)
- Recognized/Listed by FCC (USA)
- All test results contained in this engineering test report are traceable to National Institute of Standards and Technology (NIST)

EXHIBIT 4. MEASUREMENTS, EXAMINATIONS & TEST DATA

4.1. TEST SETUP

D.U.T. Information		Condition	
Product Name	NBS55XX	Robot Type	6 Axis
Model Number	NBS55XXTXXX	Scan Type	SAR – Area/Zoom/Att Vs Depth
Serial Number	Preproduction	Measured Field	E
Operating Frequency [MHz]	824.70 ~ 848.97 (CDMA) 1851.25 ~ 1908.75 (PCS-CDMA)	Phantom Type	2 _{mm} base Flat Phantom
Frequency Tested [MHz]	824.70, 836.52, 848.97 (CDMA) 1880.00 (PCS-CDMA)	Phantom Position	Waist
RF Output Power [W]	23.5 (CDMA) 23.5 (PCS-CDMA)	Room Temperature [°C]	21.0 ± 1
Antenna Type	Integrated	Room Humidity [%]	40 ± 10
Modulation	CDMA	Tissue Temperature [°C]	21.0 ± 1
Worst Case Duty Cycle	100 %		
Duty Cycle Tested	100 %		
Source(or Usage)-based time-average	1.0		

Type of Tissue	Brain	Muscle	Brain	Muscle
Test Frequency [MHz]	835	835	1900	1900
Measured Dielectric Constant	41.8 (+0.8 %)	56.2 (+1.8 %)	40.2 (+0.5 %)	51.7 (-3.0 %)
Target Dielectric Constant	41.5	55.2	40.0	53.3
Measured Conductivity [S/m]	0.88 (-2.7 %)	0.98 (+1.0 %)	1.39 (-0.7 %)	1.61 (+5.0 %)
Target Conductivity [S/m]	0.90	0.97	1.40	1.52
Penetration Depth (Plane Wave Excitation) [mm]	40.1	41.3	24.5	24.0
Probe Model Number	ET20	ET20	ET20	ET20
Probe Serial Number	03JUN-0028	03JUN-0028	03JUN-0028	03JUN-0028
Probe Orientation	Isotropic	Isotropic	Isotropic	Isotropic
Probe Offset [mm]	2.00	2.00	2.00	2.00
Probe Tip Diameter [mm]	4.00	4.00	4.00	4.00
Sensor Factor (η_{pd}) [mV/(mW/cm ²)]	10.8	10.8	10.8	10.8
Conversion Factor (γ)	5.893	5.246	4.724	4.066
Sensitivity (ζ) [W/Kg/mV]	5.213E-02	6.521E-02	1.027E-01	1.382E-01

ULTRATECH GROUP OF LABS

3000 Bristol Circle, Oakville, Ontario, Canada L6H 6G4
 Tel. #: 905-829-1570, Fax. #: 905-829-8050, Email: vic@ultratech-labs.com, Website: http://www.ultratech-labs.com

File #: MIS-053-SAR
March 27, 2006

- Assessed by ITI (UK) Competent Body, NVLAP (USA) Accreditation Body & ACA/AUSTEL (Australia), VCCI (Japan)
- Accredited by Industry Canada (Canada) under ACC-LAB (Europe/Canada MRA and APEC/Canada MRA)
- Recognized/Listed by FCC (USA)
- All test results contained in this engineering test report are traceable to National Institute of Standards and Technology (NIST)

4.2. PHOTOGRAPH OF D.U.T. AND ALL ACCESORIES



< Front View >

ULTRATECH GROUP OF LABS

3000 Bristol Circle, Oakville, Ontario, Canada L6H 6G4
Tel. #: 905-829-1570, Fax. #: 905-829-8050, Email: vic@ultratech-labs.com, Website: http://www.ultratech-labs.com

File #: MIS-053-SAR
March 27, 2006

- Assessed by ITI (UK) Competent Body, NVLAP (USA) Accreditation Body & ACA/AUSTEL (Australia), VCCI (Japan)
- Accredited by Industry Canada (Canada) under ACC-LAB (Europe/Canada MRA and APEC/Canada MRA)
- Recognized/Listed by FCC (USA)
- All test results contained in this engineering test report are traceable to National Institute of Standards and Technology (NIST)

SPECIFIC ABSORPTION RATE (SAR)

IEEE C95.1-1991, FCC OET Bulletin 65 (Supplement C), Industry Canada RSS-102(Issue 2) and ACA Radiocommunications (Electromagnetic Radiation – Human Exposure) Amendment Standard 2000 (No. 1)

NBS55XX M/N: NBS55XXTXXX



< Rear View >

ULTRATECH GROUP OF LABS

3000 Bristol Circle, Oakville, Ontario, Canada L6H 6G4
Tel. #: 905-829-1570, Fax. #: 905-829-8050, Email: vic@ultratech-labs.com, Website: <http://www.ultratech-labs.com>

File #: MIS-053-SAR
March 27, 2006

- Assessed by ITI (UK) Competent Body, NVLAP (USA) Accreditation Body & ACA/AUSTEL (Australia), VCCI (Japan)
- Accredited by Industry Canada (Canada) under ACC-LAB (Europe/Canada MRA and APEC/Canada MRA)
- Recognized/Listed by FCC (USA)
- All test results contained in this engineering test report are traceable to National Institute of Standards and Technology (NIST)



< Rechargeable Ni-MH battery (3.6V, 1.5 Ah) >

ULTRATECH GROUP OF LABS

3000 Bristol Circle, Oakville, Ontario, Canada L6H 6G4
Tel. #: 905-829-1570, Fax. #: 905-829-8050, Email: vic@ultratech-labs.com, Website: <http://www.ultratech-labs.com>

File #: MIS-053-SAR
March 27, 2006

- Assessed by ITI (UK) Competent Body, NVLAP (USA) Accreditation Body & ACA/AUSTEL (Australia), VCCI (Japan)
- Accredited by Industry Canada (Canada) under ACC-LAB (Europe/Canada MRA and APEC/Canada MRA)
- Recognized/Listed by FCC (USA)
- All test results contained in this engineering test report are traceable to National Institute of Standards and Technology (NIST)

4.3. PHOTOGRAPHS OF D.U.T. POSITION

4.3.1. Body Configuration

4.3.1.1. Right side of DUT in parallel to the phantom with spacing of 10 mm



ULTRATECH GROUP OF LABS

3000 Bristol Circle, Oakville, Ontario, Canada L6H 6G4

Tel. #: 905-829-1570, Fax. #: 905-829-8050, Email: vic@ultratech-labs.com, Website: <http://www.ultratech-labs.com>

File #: MIS-053-SAR

March 27, 2006

- Assessed by ITI (UK) Competent Body, NVLAP (USA) Accreditation Body & ACA/AUSTEL (Australia), VCCI (Japan)
- Accredited by Industry Canada (Canada) under ACC-LAB (Europe/Canada MRA and APEC/Canada MRA)
- Recognized/Listed by FCC (USA)
- All test results contained in this engineering test report are traceable to National Institute of Standards and Technology (NIST)

4.3.1.2. Back side of DUT in parallel to the phantom with spacing of 10 mm



ULTRATECH GROUP OF LABS

3000 Bristol Circle, Oakville, Ontario, Canada L6H 6G4
Tel. #: 905-829-1570, Fax. #: 905-829-8050, Email: vic@ultratech-labs.com, Website: <http://www.ultratech-labs.com>

File #: MIS-053-SAR
March 27, 2006

- Assessed by ITI (UK) Competent Body, NVLAP (USA) Accreditation Body & ACA/AUSTEL (Australia), VCCI (Japan)
- Accredited by Industry Canada (Canada) under ACC-LAB (Europe/Canada MRA and APEC/Canada MRA)
- Recognized/Listed by FCC (USA)
- All test results contained in this engineering test report are traceable to National Institute of Standards and Technology (NIST)

4.3.1.3. Top of DUT perpendicular to the phantom with spacing of 10 mm



ULTRATECH GROUP OF LABS

3000 Bristol Circle, Oakville, Ontario, Canada L6H 6G4
Tel. #: 905-829-1570, Fax. #: 905-829-8050, Email: vic@ultratech-labs.com, Website: <http://www.ultratech-labs.com>

File #: MIS-053-SAR
March 27, 2006

- Assessed by ITI (UK) Competent Body, NVLAP (USA) Accreditation Body & ACA/AUSTEL (Australia), VCCI (Japan)
- Accredited by Industry Canada (Canada) under ACC-LAB (Europe/Canada MRA and APEC/Canada MRA)
- Recognized/Listed by FCC (USA)
- All test results contained in this engineering test report are traceable to National Institute of Standards and Technology (NIST)

4.4. MAXIMUM PEAK SPATIAL-AVERAGE SAR

4.4.1. Maximum Peak Spatial-average SAR Data

#	Configuration	Device Test Positions	Antenna Position	Freq. [MHz]	Channel	MAX. SAR [W/Kg]
*	General Population/Uncontrolled Exposure Category Limit					1.6
02	Ni-MH Rechargeable Battery Right side of DUT in parallel to the phantom with spacing of 10 mm	Body	Internal	836.52	0384	0.80

4.4.2. Maximum Peak Spatial-Average SAR Location

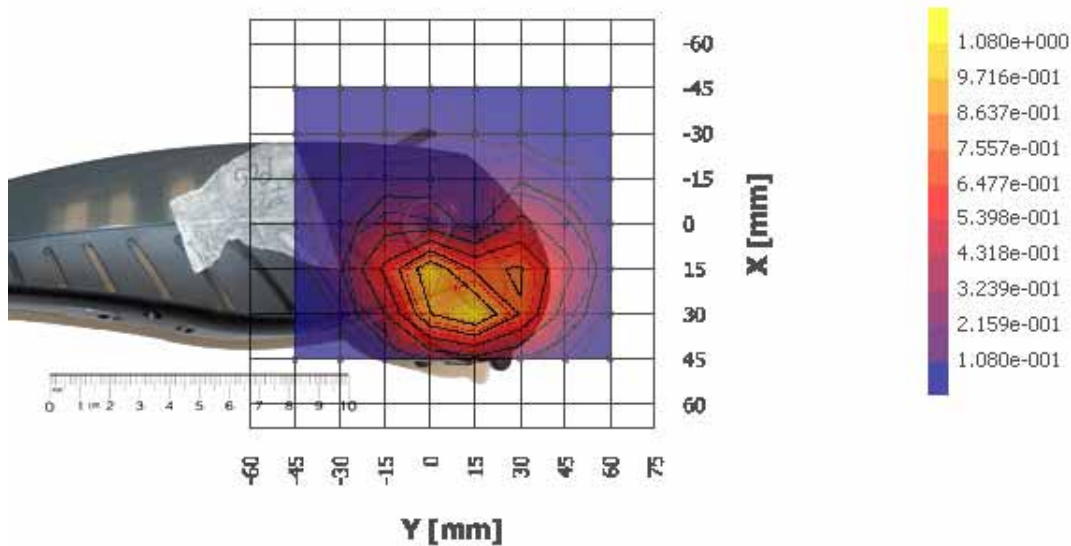

ULTRATECH GROUP OF LABS

3000 Bristol Circle, Oakville, Ontario, Canada L6H 6G4
 Tel. #: 905-829-1570, Fax. #: 905-829-8050, Email: vic@ultratech-labs.com, Website: http://www.ultratech-labs.com

File #: MIS-053-SAR
 March 27, 2006

- Assessed by ITI (UK) Competent Body, NVLAP (USA) Accreditation Body & ACA/AUSTEL (Australia), VCCI (Japan)
- Accredited by Industry Canada (Canada) under ACC-LAB (Europe/Canada MRA and APEC/Canada MRA)
- Recognized/Listed by FCC (USA)
- All test results contained in this engineering test report are traceable to National Institute of Standards and Technology (NIST)

4.5. SAR MEASUREMENT DATA

4.5.1. Body Configuration Result

4.5.1.1. CDMA*

#	Configuration	Antenna Position	Frequency [MHz]	Channel	SAR _{local} Before [W/Kg]	SAR _{local} After [W/Kg]	MAX SAR _{1g} [W/Kg]
* General Population/Uncontrolled Exposure Category Limit							1.6
01	Ni-MH Rechargeable Battery Right side of DUT in parallel to the phantom with spacing of 10 mm	Internal	824.70	1013	0.12	0.11	0.63
02		Internal	836.52	0384	0.26	0.25	0.80
03		Internal	848.97	0777	0.12	0.12	0.55
04	Ni-MH Rechargeable Battery Back side of DUT in parallel to the phantom with spacing of 10 mm	Internal	824.70	1013			-
05		Internal	836.52	0384	0.28	0.28	0.32
06		Internal	848.97	0777			-
07	Ni-MH Rechargeable Battery Top of DUT perpendicular to the phantom with spacing of 10 mm	Internal	824.70	1013			-
08		Internal	836.52	0384	0.00	0.00	0.05
09		Internal	848.97	0777			-

* If the SAR measured at the middle channel for each test configuration is at least 3.0 dB lower than the SAR limit, testing at the high and low channels is optional for such test configuration(s).

ULTRATECH GROUP OF LABS

3000 Bristol Circle, Oakville, Ontario, Canada L6H 6G4
 Tel. #: 905-829-1570, Fax. #: 905-829-8050, Email: vic@ultratech-labs.com, Website: http://www.ultratech-labs.com

File #: MIS-053-SAR
March 27, 2006

- Assessed by ITI (UK) Competent Body, NVLAP (USA) Accreditation Body & ACA/AUSTEL (Australia), VCCI (Japan)
- Accredited by Industry Canada (Canada) under ACC-LAB (Europe/Canada MRA and APEC/Canada MRA)
- Recognized/Listed by FCC (USA)
- All test results contained in this engineering test report are traceable to National Institute of Standards and Technology (NIST)

SPECIFIC ABSORPTION RATE (SAR)

IEEE C95.1-1991, FCC OET Bulletin 65 (Supplement C), Industry Canada RSS-102(Issue 2) and ACA Radiocommunications (Electromagnetic Radiation – Human Exposure) Amendment Standard 2000 (No. 1)

NBS55XX M/N: NBS55XXTXXX

FCC ID: O3JNBS55XXT

4.5.1.2. PCS CDMA*

#	Configuration	Antenna Position	Frequency [MHz]	Channel	SAR _{local} Before [W/Kg]	SAR _{local} After [W/Kg]	MAX SAR _{1g} [W/Kg]
* General Population/Uncontrolled Exposure Category Limit							1.6
10	Ni-MH Rechargeable Battery Right side of DUT in parallel to the phantom with spacing of 10 mm	Internal	1851.25	0025			
11		Internal	1880.00	0600	0.57	0.57	0.60
12		Internal	1908.75	1175			
13	Ni-MH Rechargeable Battery Back side of DUT in parallel to the phantom with spacing of 10 mm	Internal	1851.25	0025			-
14		Internal	1880.00	0600	0.11	0.11	0.17
15		Internal	1908.75	1175			-
16	Ni-MH Rechargeable Battery Top of DUT perpendicular to the phantom with spacing of 10 mm	Internal	1851.25	0025			-
17		Internal	1880.00	0600	0.39	0.38	0.22
18		Internal	1908.75	1175			-

* If the SAR measured at the middle channel for each test configuration is at least 3.0 dB lower than the SAR limit, testing at the high and low channels is optional for such test configuration(s).

ULTRATECH GROUP OF LABS

3000 Bristol Circle, Oakville, Ontario, Canada L6H 6G4
Tel. #: 905-829-1570, Fax. #: 905-829-8050, Email: vic@ultratech-labs.com, Website: http://www.ultratech-labs.com

File #: MIS-053-SAR
March 27, 2006

- Assessed by ITI (UK) Competent Body, NVLAP (USA) Accreditation Body & ACA/AUSTEL (Australia), VCCI (Japan)
- Accredited by Industry Canada (Canada) under ACC-LAB (Europe/Canada MRA and APEC/Canada MRA)
- Recognized/Listed by FCC (USA)
- All test results contained in this engineering test report are traceable to National Institute of Standards and Technology (NIST)

4.5.2. Power Measurement

4.5.2.1. RF Conducted Power Measurement

Mode	Frequency (MHz)	Measured Max. Conducted Peak Power (dBm)
CDMA	824.70	23.80
	836.52	23.80
	848.97	23.70
PCS CDMA	1851.25	23.10
	1880.00	23.30
	1908.75	23.60

4.5.2.2. Power Drift

The local SAR was measured at the arbitrary location in the vicinity of the antenna fed point in the simulated tissue at 836.52 MHz (CDMA) and 1880.0 MHz (PCS CDMA) during the period of 30 minute.

The power (SAR) drift after 30 minutes of the continuous exposure at the maximum power level was found to be less than $\pm 5\%$.

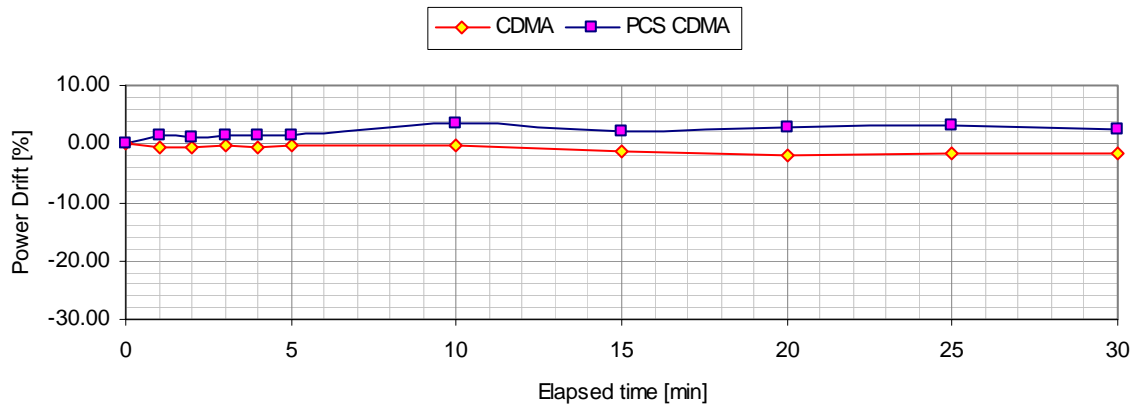

- Assessed by ITI (UK) Competent Body, NVLAP (USA) Accreditation Body & ACA/AUSTEL (Australia), VCCI (Japan)
- Accredited by Industry Canada (Canada) under ACC-LAB (Europe/Canada MRA and APEC/Canada MRA)
- Recognized/Listed by FCC (USA)
- All test results contained in this engineering test report are traceable to National Institute of Standards and Technology (NIST)

EXHIBIT 5. SAR SYSTEM CONFIGURATION & TEST METHODOLOGY

5.1. MEASUREMENT SYSTEM SPECIFICATIONS

Positioning Equipment	Probe
Type : 3D Near Field Scanner	Sensor : E-Field
Location Repeatability : 0.1 [mm]	Spatial Resolution : 1 [mm ³]
Speed 180 [°/sec]	Isotropic Response : ±0.25 [dB]
AC motors	Dynamic Range : 0.01 to 100 [W/Kg]
Computer	Phantom
Type : Pentium III 500MHz	Tissue : Simulated Tissue with electrical characteristics similar to those of the human at normal body temperature.
Memory : 256 MB RAM	Left/Right Head: IEEE P1528 Compliant SAM manufactured by Aprel
Operating System : Windows 2000 Pro	Body/Frontal Head: IEEE Flat Phantom 2 [mm] Base
Monitor : 19" SVGA	

5.2. TEST PROCEDURES

In the SAR measurement, the positioning of the probes must be performed with sufficient accuracy to obtain repeatable measurements in the presence of rapid spatial attenuation phenomena. The accurate positioning of the E-field probe is accomplished by using a high precision robot. The robot can be taught to position the probe sensor following a specific pattern of points. In a first sweep, the sensor is positioned as close as possible to the interface, with the sensor enclosure touching the inside of the phantom shell. The SAR is measured on a grid of points, which covers the curved surface of the phantom in an area larger than the size of the D.U.T. After the initial scan, a high-resolution volume grid is used to locate the absolute maximum measured energy point and to calculate the peak spatial-average SAR. At this location, attenuation versus depth scan will be accomplished by the measurement system in order to verify the peak spatial-average SAR measured.

5.3. PHANTOM

For Head mounted devices placed next to the ear, the phantom used in the evaluation of the RF exposure of the user of the wireless device is a IEEE P1528 compliant SAM phantom, shaped like a human head and filled with a mixture simulating the dielectric characteristics of the brain. A left sided head and a right sided head are evaluated to determine the worst case orientation for SAR. For body mounted and frontal held push-to-talk devices, a flat phantom of dimensions 70x42x20cm with a base plate thickness of 2mm is used.

5.4. SIMULATED TISSUE

Simulated Tissue: Suggested in a paper by George Hartsgrove and colleagues in University of Ottawa Ref.: Bioelectromagnetics 8:29-36 (1987)

Ingredient	Quantity
Water	40.4 %
Sugar	56.0 %
Salt	2.5 %
HEC	1.0 %
Bactericide	0.1 %

Table 5.4. Example of composition of simulated tissue

This simulated tissue is mainly composed of water, sugar and salt. At higher frequencies, in order to achieve the proper conductivity, the solution does not contain salt. Also, at these frequencies, D.I. water and alcohol is preferred.

Target Frequency (MHz)	Head		Body	
	ϵ_r	σ (S/m)	ϵ_r	σ (S/m)
150	52.3	0.76	61.9	0.80
300	45.3	0.87	58.2	0.92
450	43.5	0.87	56.7	0.94
835	41.5	0.90	55.2	0.97
900	41.5	0.97	55.0	1.05
915	41.5	0.98	55.0	1.06
1450	40.5	1.20	54.0	1.30
1610	40.3	1.29	53.8	1.40
1800 – 2000	40.0	1.40	53.3	1.52
2450	39.2	1.80	52.7	1.95
3000	38.5	2.40	52.0	2.73
5800	35.3	5.27	48.2	6.00

(ϵ_r = relative permittivity, σ = conductivity and $\rho = 1000 \text{ Kg/m}^3$ *)

* The actual mass density of the equivalent tissue vary based on the composition of the tissue from 990 Kg/m^3 to $1,300 \text{ Kg/m}^3$.

- Assessed by ITI (UK) Competent Body, NVLAP (USA) Accreditation Body & ACA/AUSTEL (Australia), VCCI (Japan)
- Accredited by Industry Canada (Canada) under ACC-LAB (Europe/Canada MRA and APEC/Canada MRA)
- Recognized/Listed by FCC (USA)
- All test results contained in this engineering test report are traceable to National Institute of Standards and Technology (NIST)

5.4.1. Preparation

The weight requirements is determined and measured carefully for all the components. A clean container is used where the ingredients will be mixed. A stirring paddle mounted to a drill press is used to stir the mixture. First the heat is applied to the DI water to approximately 40 °C to help the ingredients dissolve well and then the salt and the bactericide are added. It is stirred until all the ingredients are completely dissolved. It is continuously stirred slowly while adding the sugar. Rotation of stirring paddle at a high RPM is avoided to prevent air bubbles in the mixture. Later on, the HEC is added to maintain the solution homogeneous. Mixing time is approximately 2 hours.

5.5. MEASUREMENT OF ELECTRICAL CHARACTERISTICS OF SIMULATED TISSUE

- 1) Slotted Coaxial Waveguide
- 2) HP Dielectric Strength Probe System

5.5.1. Slotted Coaxial Waveguide

5.5.1.1. Equipment set-up

The test equipment consists of a slotted coaxial transmission line with a probe connected to a vector network analyzer, as shown in Figure 5.5.1.1 The log-magnitude and phase of S_{21} should be displayed simultaneously. Source power should be set to a level high enough to provide good signal-to-noise ratio. Periodically (annually or whenever the measuring scale along the line length is changed) a measurement is made on a reference liquid to validate the system. Since the measured quantities are magnitude and phase changes versus distance, the accuracy of the scale is very critical.

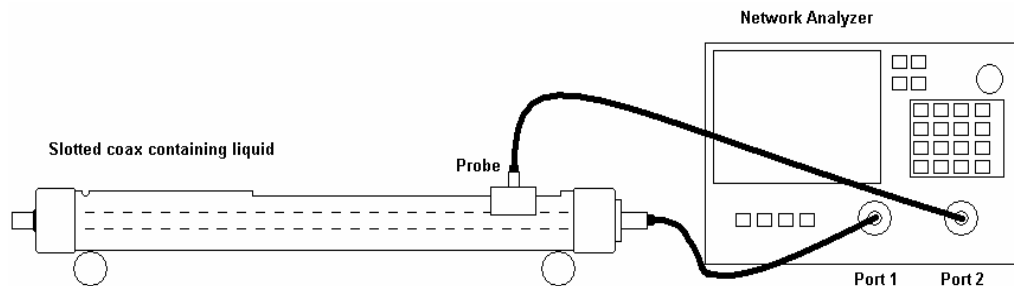

Figure 5.5.1.11 Slotted line set-up

The network analyzer injects a signal into one end of the slotted coaxial transmission line. The probe inserted through the slot into the tissue-equivalent material detects the RF amplitude and phase for each measurement position along the length of the line. A full two-port calibration of the network analyzer should be carried out prior to connecting the sample holder, and the following precautions should be observed:

- a) Fill the slotted line carefully to avoid trapping air bubbles. This operation should be performed while the slotted line is horizontal.

- b) The probe should be inserted into the slot at the end nearest to the input connector of the slotted line, ensuring that the tissue-equivalent liquid is flush with the inside surface of the line, and aligned with a well-defined position on the distance scale of the slotted line.
- c) The probe should be inserted perpendicular to the slotted-line longitudinal axis until a stable and adequate amplitude response is achieved. Do not insert the probe too deeply into the coaxial line, because it can overly perturb the field distribution.

5.5.1.2. Measurement procedure.

- a) Configure and calibrate the network analyzer.
- b) Measure 10 to 20 log-magnitude and phase data points along the slotted line corresponding to about a 30 dB change in magnitude.
- c) Plot S_{21} log-magnitude and phase vs. measurement distance.
- d) Determine if the graphed points closely follow a straight-line approximation, based on the correlation coefficient or a similar statistical measure. The data should produce a good linear curve fit (expected correlation coefficient $r^2 > 0.99$ for lossy materials). If not, re-measure the liquid by increasing the sample points to extend the magnitude change from 30 to 40 dB. Note: for low loss materials, ensure that the slotted line is long enough to avoid reflections from the load-terminated end.
- e) Calculate the conductivity and relative permittivity of the tissue-equivalent material using Equations (5.5.1.21) derived from

$$\begin{aligned} \bar{\alpha} &= \frac{m_m \ln(10)}{20} && \text{Np/cm} \\ \bar{\beta} &= \frac{m_p \pi}{180} && \text{rad/cm} \\ \epsilon'_r &= \frac{(\bar{\beta})^2 - (\bar{\alpha})^2}{\omega^2 \mu_0 \epsilon_0} && \text{(Eq 5.5.1.21)} \\ \sigma &= \frac{2\bar{\alpha}\bar{\beta}}{\omega\epsilon_0} \left(\frac{100 \text{ cm}}{\text{m}} \right) && \text{S/m} \end{aligned}$$

where, m_m and m_p are the slopes of the least-squares linear fits of the log-magnitude and phase plots, respectively, and $\bar{\alpha}$ and $\bar{\beta}$ are the average attenuation and propagation coefficients along the line.

5.5.2. HP Dielectric Strength Probe System (open-ended coaxial transmission-line probe/sensor)

5.5.2.1. Equipment set-up

The equipment consists of a probe connected to one port of a vector network analyzer. The probe is an open-ended coaxial line, as shown in Figure 5.5.2.11. Cylindrical coordinates (ρ, ϕ, z) are used where ρ is the radial distance from the axis, ϕ is the angular displacement around the axis, z is the displacement along the axis, a is the inner conductor radius, and b is the outer conductor inner radius.

The sample holder is a non-metallic container that is large compared with the size of the probe immersed in it. A probe with an outer diameter b of 2 to 4 mm is suitable for the measurement of tissue-equivalent materials in the 300 MHz to 3 GHz frequency range. This probe size is commensurate with sample volumes of 50 cc or higher. Larger probes of up to 7 mm outer diameter b may be used with larger sample volumes. A flange is typically included to better represent the infinite ground-plane assumption used in admittance calculations.

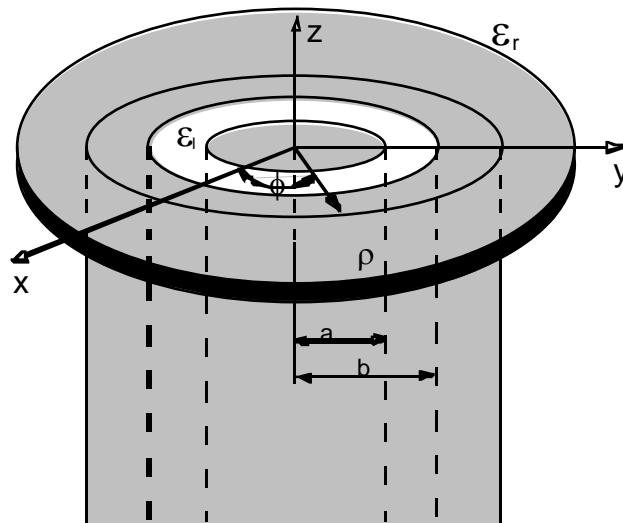

Figure 5.5.2.1 An open-ended coaxial probe with inner and outer radii a and b , respectively

The accuracy of the short-circuit measurement should be verified for each calibration at a number of frequencies. A short circuit can be achieved by gently pressing a piece of aluminum foil against the open end. For best electrical contact, the probe end should be flat and free of oxidation. Larger the sensors generally have better foil short-circuit repeatability. It is possible to obtain good contact with some commercial 4.6 mm probes using the metal-disk short-circuit supplied with the kit. For best repeatability, it may be necessary to press the disk by hand.

The network analyzer is configured to measure the magnitude and phase of the admittance. A one-port reflection calibration is performed at the plane of the probe by placing materials for which the reflection coefficient can be calculated in contact with the probe. Three standards are needed for the calibration, typically a short circuit, air, and de-ionized water at a well-defined temperature (other reference liquids such as methanol or ethanol may be used for calibration). The calibration is a key part of the measurement procedure, and it is therefore important to ensure that it has been performed correctly. It can be checked by re-measuring the short circuit to ensure that a reflection coefficient of $\Gamma = -1.0$ (linear units) is obtained consistently.

5.5.2.2. Measurement procedure

- a) Configure and calibrate the network analyzer and probe system.

ULTRATECH GROUP OF LABS

3000 Bristol Circle, Oakville, Ontario, Canada L6H 6G4
 Tel. #: 905-829-1570, Fax. #: 905-829-8050, Email: vic@ultratech-labs.com, Website: http://www.ultratech-labs.com

File #: MIS-053-SAR
March 27, 2006

- Assessed by ITI (UK) Competent Body, NVLAP (USA) Accreditation Body & ACA/AUSTEL (Australia), VCCI (Japan)
- Accredited by Industry Canada (Canada) under ACC-LAB (Europe/Canada MRA and APEC/Canada MRA)
- Recognized/Listed by FCC (USA)
- All test results contained in this engineering test report are traceable to National Institute of Standards and Technology (NIST)

-
- b) Place the sample in a non-metallic container and immerse the probe. A fixture or clamp is recommended to stabilize the probe, mounted such that the probe face is at an angle with respect to the liquid surface to minimize trapped air bubbles beneath the flange.
- c) Measure the complex admittance with respect to the probe aperture.
- d) Compute the complex relative permittivity $\epsilon_r = \epsilon_r' - j\sigma/\omega\epsilon_0$.

ULTRATECH GROUP OF LABS

3000 Bristol Circle, Oakville, Ontario, Canada L6H 6G4

Tel. #: 905-829-1570, Fax. #: 905-829-8050, Email: vic@ultratech-labs.com, Website: <http://www.ultratech-labs.com>**File #: MIS-053-SAR****March 27, 2006**

- Assessed by ITI (UK) Competent Body, NVLAP (USA) Accreditation Body & ACA/AUSTEL (Australia), VCCI (Japan)
- Accredited by Industry Canada (Canada) under ACC-LAB (Europe/Canada MRA and APEC/Canada MRA)
- Recognized/Listed by FCC (USA)
- *All test results contained in this engineering test report are traceable to National Institute of Standards and Technology (NIST)*

5.6. SYSTEM CALIBRATION

The SAR measurement system has two main components:

- a) the probe, which is connected to the inputs of
- b) the instrumentation amplifier whose outputs are connected through the optical transmission line to
- c) the computer.

The system is calibrated as one unit not as individual components. If any components is modified or replaced, the system must be re-calibrated.

The system calibration is performed by three steps:

- 1) determination of the diode compression potential for each channel by introducing the probe into the well-defined RF field and and record the probe output while increasing the RF field intensity,
- 2) determination of the sensitivity of the probe in the air by introducing it into the well-defined RF field, and
- 3) correlation of the measured E-field in the dielectric medium to the temperature rise in a dielectric medium.

5.6.1. Probe linearity

Detector diodes at the dipole feed-point are used to rectify the sensor voltage output. The rectified signal is transmitted through resistive (RF-transparent) lines to the sensor amplifier. At low field strength levels the output voltage is proportional to the square of the amplitude of the incident field; at higher signal levels, the output voltage is not linearly proportional to $|E|^2$, but becomes proportional to E. The compensation for diode compression is carried out for the each detector diode using the following algorithm before any further evaluation.

$$U_{L,i} = U_{O,i} + \frac{U_{O,i}^2}{DCP_i}$$

Where,

- $U_{O,i}$ Probe raw output for channel i
- $U_{L,i}$ Linearized probe output for channel i
- DCP_i Diode specific compression potential for channel i

5.6.2. Free Space Calibration

- RF Signal Generator - frequency range to at least 6 GHz,
- RF Amplifier – if needed to generate the required power density in the test cell,
- Test Cell - TEM (Crawford) cell, waveguide, or other device capable of maintaining a uniform field,
- RF Power Meter - capable of measuring at least 5 Watts (current calibration is mandatory!) if possible traceable to the National Institute of Standards and Technology (NIST).
- E-Field Probe (under calibration)
- Probe Support Fixture
- Instrumentation Amplifier

ULTRATECH GROUP OF LABS

3000 Bristol Circle, Oakville, Ontario, Canada L6H 6G4
 Tel. #: 905-829-1570, Fax. #: 905-829-8050, Email: vic@ultratech-labs.com, Website: http://www.ultratech-labs.com

File #: MIS-053-SAR
March 27, 2006

- Assessed by ITI (UK) Competent Body, NVLAP (USA) Accreditation Body & ACA/AUSTEL (Australia), VCCI (Japan)
- Accredited by Industry Canada (Canada) under ACC-LAB (Europe/Canada MRA and APEC/Canada MRA)
- Recognized/Listed by FCC (USA)
- All test results contained in this engineering test report are traceable to National Institute of Standards and Technology (NIST)

- Transmission Line
- Computer Program with the Automated Calibration System Program

5.6.2.1. Method

Due to impedance variations in the diodes and the transmission line, and slight differences in gain among the channels of the instrumentation amplifier, a normalization method had been designed. The calibration method actually used is to determine the factors necessary adjust each channel of the system so it's indicated output can then be equated to the well-defined RF field. These factors are referred to as "Amplifier Settings".

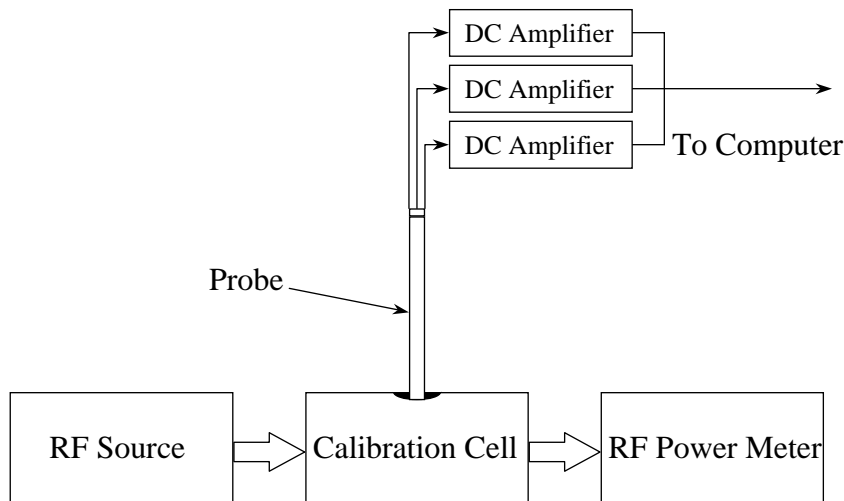

Figure 5.6.2.1 Free Space Calibration Setup for Amplifier Setting

5.6.2.2. Measurement procedure

Free Space Calibration of E-field probes can be performed using a TEM cell manufactured by IFI (Instrumentation for Industry, Farmingdale, NY 11735) with operating frequency at or below 1 GHz. Above 1 GHz, waveguides are used to calibrate the probes in free space.

- Connect the equipments as shown in Figure 5.6.2.1;

- Assessed by ITI (UK) Competent Body, NVLAP (USA) Accreditation Body & ACA/AUSTEL (Australia), VCCI (Japan)
- Accredited by Industry Canada (Canada) under ACC-LAB (Europe/Canada MRA and APEC/Canada MRA)
- Recognized/Listed by FCC (USA)
- All test results contained in this engineering test report are traceable to National Institute of Standards and Technology (NIST)

- Adjust the RF generator output so that the power density at the calibration point inside the TEM cell is well-defined. (For the IFI model CC-110 cell, the uniform power density of 1.0 [mW/cm²] requires the power level of 271.0 [mW]);
- Mount the probe of the system to calibrate in the support fixture. Insert the probe through the aperture of the TEM cell. The probe handle should be at the geometric center of the aperture, i.e. midway between the septum and the upper surface, and orthogonal to the side of the cell. The sensing portion of the probe should be located at a point halfway across the depth of the cell (volumetric center).
- Once the prescribed position is obtained, it must be maintained during the rest of the measurement. The only movement of the probe allowed is rotation on its axis to position the dipole in the plane of the E-field and, for channel 3 only, parallel to the vertical uniform field (max./min. output).
- Verify that the RF power level remains constant throughout the measurement. While the probe is being rotated through 360 degrees, software indicators will show the maximum measured on each channel.

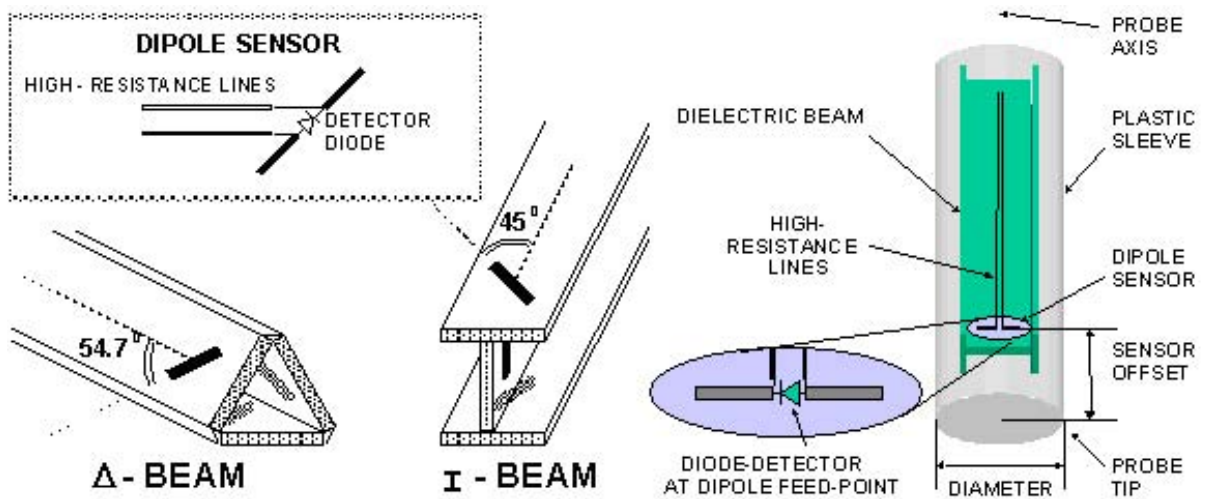

Figure 5.6.2.2 E-field probe construction

5.6.2.3. Definition of Amplifier Settings

The initial sequence of probe calibrations steps performed with SAR determinations produces the factors used in scaling probe output voltage to RF power density. For historical reasons all probes factors are compared to a factor 10.8 [mV] per [mW/cm²] that was typical of a prototype probe, but is in fact an arbitrary number used as an intermediately constant. The factor of 10.8 [mV/(mW/cm²)] is known as the sensor factor to the uniform power density (η_{pd}), but does not change. Also we can derive 10.8/3,770 [mV/(V/m)²] of the sensor factor to the $|E|^2$ (η_{E2}), providing 377 [Ω] as free space impedance.

$$\eta_{pd} = 10.8 [mV / (mW / cm^2)] \equiv \eta_{E2} = \frac{10.8}{3770} [mV / (V / m)^2]$$

- Assessed by ITI (UK) Competent Body, NVLAP (USA) Accreditation Body & ACA/AUSTEL (Australia), VCCI (Japan)
- Accredited by Industry Canada (Canada) under ACC-LAB (Europe/Canada MRA and APEC/Canada MRA)
- Recognized/Listed by FCC (USA)
- All test results contained in this engineering test report are traceable to National Institute of Standards and Technology (NIST)

$$Pd[mW / cm^2] = \frac{PO_{tot}}{\eta_{Pd}}, |E|^2[(V / m)^2] = \frac{PO_{tot}}{\eta_{E2}} \text{ and } SAR = \frac{\sigma \times \frac{PO_{tot}}{\rho}}{\eta_{E2}}$$

To calibrate a probe, each channel is assigned an amplifier setting. This factor is obtained from the sum of the probe output voltage measured during probe calibration. This probe output voltage is corrected for any DC offset of the instrumentation amplifier, usually a very small amount.

During calibration, the sensitivity for the E-field tangential to the dipole axis caused by the geometry of the probe construction is carefully considered to obtain the correct amplifier setting for each channel. Thus, the amplifier settings for each channel are as follows:

$$R_{ISO,i,1} = \frac{\sum_{\theta}^{360^{\circ}} U_{L,1}(\theta)}{\sum_{\theta} U_{L,i}(\theta)}$$

$$AS_i = \eta_{Pd} [mV / (mW / cm^2)] \times Pd[mW / cm^2] \times \cos^2(\varphi - \phi_i) \times \frac{R_{ISO,i,1}}{U_{L,1,peak}}$$

Where,

- R_{ISO,i,1} The isotropic correction factor normalized to channel 1
- AS_i Amplifier Setting for channel i
- η_{pd} Sensor Factor to the uniform power density, an arbitrary value 10.8 [mV/(mW/cm²)]
- η_{E2} Sensor Factor to the uniform |E|², an arbitrary value 10.8/3,770 [mV/(V/m)²]
- U_{L,1,peak} The peak linearized probe output recorded for channel 1 by a rotation about the probe axis with the probe in a test cell
- φ Smaller angle between the probe axis and the direction of the E-field (i.e. 90° when the probe axis is parallel to the plane of the septum inside TEM cell)
- φ_i Smaller angle between the probe axis and the dipole sensor axis of the channel i (φ₁ = φ₂ = 45°, φ₃ = 90° for I-beam probe, and φ₁ = φ₂ = φ₃ = 54.7° for triangular-beam probe)
- Pd Well-defined power density [mW/cm²] at the calibration point in a test cell

5.6.3. Calculable Waveguide Calibration

5.6.3.1. Measurement Procedure

This method utilizes a setup in which the field can be calculated analytically based on measurements of other physical parameters, e.g., input power. While this method corresponds to the standard field method for probe calibration in air, there is no standard method defined for field generation in lossy liquids.

- Assessed by ITI (UK) Competent Body, NVLAP (USA) Accreditation Body & ACA/AUSTEL (Australia), VCCI (Japan)
- Accredited by Industry Canada (Canada) under ACC-LAB (Europe/Canada MRA and APEC/Canada MRA)
- Recognized/Listed by FCC (USA)
- All test results contained in this engineering test report are traceable to National Institute of Standards and Technology (NIST)

When this method is used for calibrating probes in lossy liquids, the following points must be considered in the uncertainty assessment:

1. The net RF power dissipated in the waveguide must be measured accurately. This requirement implies precise measurements of two out of the following three quantities: incident power, reflected power, reflection coefficient at the waveguide input port.
2. The accuracy of the calculated field strength will depend on the assessment of the dielectric parameters of the liquid.
3. Because of the short wavelength in liquids with high permittivity, higher order modes may be excitable even in small waveguides. Consequently, stringent electrical and mechanical tolerances are required in the construction of calibration fixtures. The actual field distribution in the calibration setup must be carefully checked for conformity with the theoretical field distribution.

Waveguides can be utilized to generate an analytically known field inside tissue-equivalent liquids, e.g., using the setup presented in Figure 5.6.3.1. In this setup, a portion of an upright-standing open waveguide is filled with a tissue-equivalent liquid. A dielectric slab at a distance greater than one free-space wavelength from the input coupler provides an impedance match between air and the liquid with a return loss typically greater than 10 dB. Proper fabrication symmetry and the high losses in the liquid ensure that the field distribution inside the tissue-equivalent liquid follows the TE₁₀ mode pattern, although it is theoretically possible that higher order modes could be excited. The field distribution was carefully validated by means of a complete volume scan in the liquid, which showed a deviation from the theoretical TE₁₀ pattern of less than 2%.

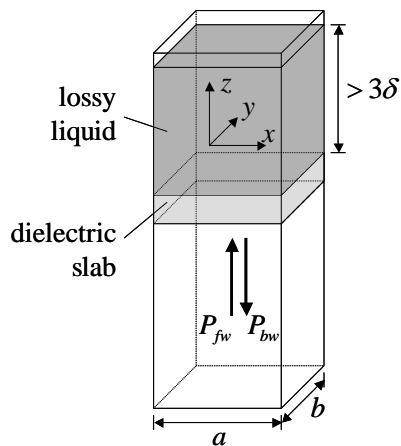

Figure 5.6.3.1 – Vertical rectangular waveguide calibration setup

Because of the low cutoff frequency, the field inside the liquid nearly propagates as a TEM wave. The depth of the medium (greater than three penetration depths) ensures that reflections at the upper surface of the liquid are negligible. The power absorbed in the liquid is determined by measuring the waveguide forward and reflected power. Equation (5.6.3.11) shows the relationship between the SAR at the cross-sectional center ($x = y = 0$) of the lossy waveguide and the longitudinal distance (z) from the dielectric separator

$$SAR(z) = \frac{4(P_f - P_r)}{\rho \delta ab} e^{-2z/\delta}, \tag{Eq. 5.6.3.11}$$

where the density ρ is conventionally assumed to be 1000 kg/m³, ab is the cross-sectional area of the waveguide, P_f and P_r are the forward and reflected power inside the lossless section of the waveguide, respectively. The penetration depth δ , which is the reciprocal of the waveguide-mode attenuation coefficient α , is determined from a scan along the z -axis and compared with the theoretical value determined from Equation (5.6.3.12) using the measured dielectric properties of the lossy liquid.

$$\delta = \alpha^{-1} = \left\{ \text{Re} \left[\sqrt{(\pi/a)^2 + j\omega\mu_0(\sigma + j\omega\varepsilon_0\varepsilon'_r)} \right] \right\}^{-1}. \tag{Eq. 5.6.3.12}$$

Table A.1 can be used for designing calibration waveguides with a return loss greater than 30 dB at the most important frequencies used for personal wireless communications. Values for the penetration depth for these specific fixtures and tissue-simulating mixtures are also listed in Table 5.6.3.11.

This calibration technique provides excellent accuracy, with standard uncertainty reported to be less than 3.6% depending on the frequency and medium. The calibration itself is reduced to power measurements traceable to a standard calibration procedure.

The waveguide method described here has the additional benefit of providing an alternative method to determine the electrical conductivity of the tissue-equivalent liquid. For a known relative permittivity, the conductivity is obtained using the equation

$$\sigma = \frac{2\alpha}{\omega\mu_0} \sqrt{\alpha^2 + \omega^2\mu_0\varepsilon_0\varepsilon'_r - \left(\frac{\pi}{a}\right)^2}. \tag{Eq. 5.6.3.13}$$

Table 5.6.3.11 – Guidelines for designing calibration waveguides

Frequency (MHz)	Head Tissue Simulant		Waveguide Dimension	Penetration Depth	Dielectric Separator	
	ε'_r	σ (S/m)	a (mm)	δ (mm)	ε'_r	Thickness (mm)
1800-2000	40	1.40	109.2	24.15	4.8	19.4
2450	39	1.80	109.2	18.59	5.7	12.6
5200	36	4.70	40.0	6.60	6.0	5.3
5800	35.3	5.30	40.0	6.00	6.0	4.4

NOTES — (1) Permittivity and thickness of the dielectric separator may vary from the values shown to accommodate commercially available materials. Changes of the order of $\pm 10\%$ should not produce substantial performance degradation.

(2) By convention, the length of the cross-section short edge is one-half that of the long edge, i.e., $b = a/2$.

5.6.4. Thermal Transfer Calibration

5.6.4.1. Measurement procedure

An RF transparent thermistor-based temperature probe and a isotropic E-field probe are placed side-by-side in a planar phantom while both are exposed to RF energy from a half wave dipole antenna located below the phantom. The E-field probe and amplifiers were previously calibrated.

First, the location of the maximum E-field close to the phantom’s bottom is determined as a function of power into the dipole.

Then, the E-field probe is moved sideways so that the temperature probe, while affixed to the E-field probe is placed at the previous location of the E-field probe.

Finally, temperature changes for a certain amount of time (generally 10 to 30 seconds) exposures at the same RF power levels used for the E-field are recorded. Care is taken to allow cooling down to the original temperature and temperature stabilization between tests.

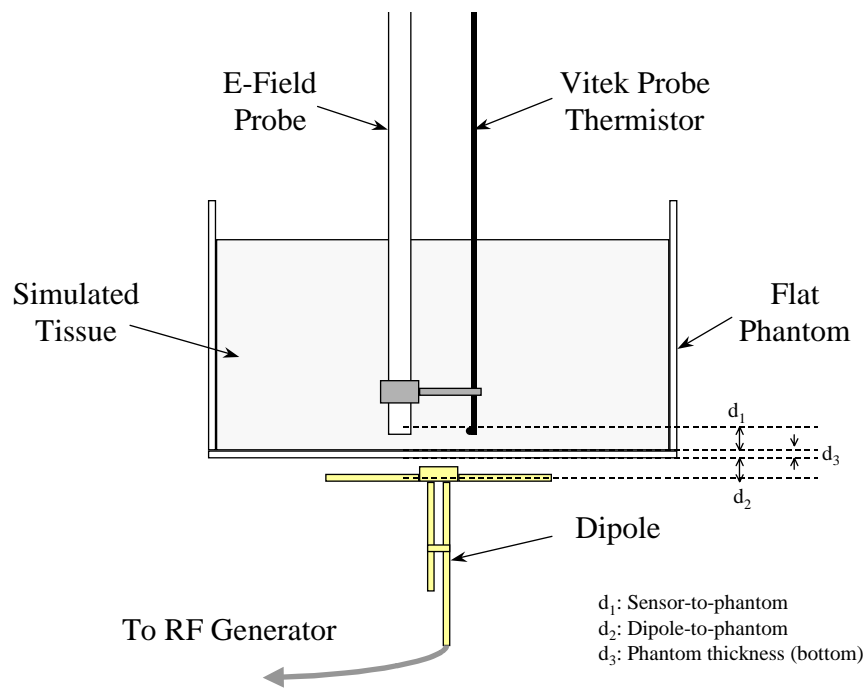

Figure 5.6.4.11 Flat Phantom, Thermistor and E-Field Probe

The following simple equation relates SAR to the initial temperature slope:

$$SAR_t = \frac{c \cdot \Delta T}{\Delta t} \tag{Eq. 5.6.4.11}$$

In (Eq. 5.6.4.11) Δt is the exposure time [sec], c is the specific heat capacity of the simulated tissue [J/Kg/°C] and ΔT is the temperature increase [°C] due to the RF exposure. SAR is proportional to $\Delta T/\Delta t$, the initial rate of tissue heating, before thermal diffusion takes place.

From (Eq. 5.6.4.11) it is possible to quantify the electric field in the simulated tissue by equating the thermally-derived SAR to the E-field:

$$SAR = \frac{|E|^2 \cdot \sigma}{\rho} \tag{Eq. 5.6.4.12}$$

where σ is the simulated tissue conductivity [S/m] and ρ its mass density [Kg/m³]; The actual mass density of the simulated tissue is required during the thermal transfer calibration, while mass density of 1,000 [Kg/m³] is conventionally chosen during the SAR measurements.

5.6.4.2. Determination of Conversion Factor (γ) in the simulated tissue

The sensitivity of the probe in the dielectric media compared to its sensitivity in the air, is different. Conversion Factor (γ) is defined to determine the degree of the enhancement of sensitivity in the different dielectric media and relate it to its sensitivity in the air.

$$PO_{tot_tissue} \equiv PO_{tot_air} \times \gamma$$

Thus,

$$|E_{tissue}|^2 = \frac{PO_{tot_tissue}}{\eta_{E2}} \times \frac{1}{\gamma} \quad , \text{and} \quad SAR_{tissue} = \frac{\sigma \times \frac{PO_{tot_tissue}}{\eta_{E2}} \times \frac{1}{\gamma}}{\rho}$$

where,

$ E_{tissue} ^2$	RMS E-field level [(V/m) ²] induced within the exposed tissue
PO_{tot_tissue}	Probe voltage output measured in the simulated tissue [mV]
PO_{tot_air}	Probe voltage output measured in the air ($Z_{air} = 377[\Omega]$) [mV]
η_{E2}	Sensor Factor to the $ E ^2$, an arbitrary value 10.8/3,770 [mV/(V/m) ²]
γ	Conversion factor; ratio of sensor response in air to response in the dielectric media

The conversion factor (γ) can be used to scale the E-field in terms of the thermally-derived SAR. It is the quotient of SAR_t , the SAR determined from temperature measurements in the flat phantom, and PO_{tot_tissue} , the E-field probe output voltage obtained at the same location in the phantom

- Assessed by ITI (UK) Competent Body, NVLAP (USA) Accreditation Body & ACA/AUSTEL (Australia), VCCI (Japan)
- Accredited by Industry Canada (Canada) under ACC-LAB (Europe/Canada MRA and APEC/Canada MRA)
- Recognized/Listed by FCC (USA)
- All test results contained in this engineering test report are traceable to National Institute of Standards and Technology (NIST)

$$\begin{aligned}
 SAR_t &= SAR_{tissue} \\
 \frac{c \cdot \Delta T}{\Delta t} &= \frac{\sigma_{@cal} \times |E_{tissue}|^2}{\rho} \\
 &= \frac{\sigma_{@cal} \times \frac{PO_{tot_tissue}}{\eta_{E2}} \times \frac{1}{\gamma}}{\rho}
 \end{aligned}$$

Thus,

$$\gamma = \frac{\sigma_{@cal}}{\eta_{E2} \times \rho} \times \frac{PO_{tot_tissue}}{SAR_t} = \frac{\sigma_{@cal} \times 3,770}{10.8 \times c \times \rho} \times \frac{PO_{tot_tissue}}{\Delta T / \Delta t} \tag{Eq. 5.6.4.21}$$

where,

γ	Conversion factor; ratio of sensor response in air to response in the dielectric media
SAR_t	Thermally-derived SAR [W/Kg] (Eq. 1)
$ E_{tissue} ^2$	RMS E-field level [(V/m) ²] induced within the exposed tissue
PO_{tot_tissue}	Probe voltage output measured in the simulated tissue [mV]
η_{E2}	Sensor Factor to the $ E ^2$, an intermediately constant, 10.8/3,770 [mV/(V/m) ²]
c	Specific heat capacity of the simulated tissue [J/Kg/°C]
$\sigma_{@cal}$	Conductivity of the simulated tissue during the calibration procedure [S/m]
ρ	Actual mass density of the simulated tissue [Kg/m ³]
$\Delta T / \Delta t$	Initial rate of tissue heating, before thermal diffusion takes place [°C /sec]

The temperature E-field correlation is illustrated below (for simulated brain tissue) for an example in which the thermal quantities were,

- RF power input = 0.5 [W]
- $\Delta T = 0.0163$ [°C] (from thermistor-base temperature probe)
- $\sigma_{@cal} = 0.97$ [S/m]
- $\rho = 1,200$ [Kg/m³]
- $c = 2,700$ [J/Kg/°C]
- $\Delta t = 30$ [sec]

The resulting SAR_t was (Eq. 5.6.4.11)

$$SAR_t = \frac{2,700 \times 0.0163}{30} = 1.467 \text{ [W/Kg]}$$

In this case the output of the E-field probe when at the same position as the thermistor probe was

$$PO_{tot_tissue} = 28.5 \text{ [mV]}$$

- Assessed by ITI (UK) Competent Body, NVLAP (USA) Accreditation Body & ACA/AUSTEL (Australia), VCCI (Japan)
- Accredited by Industry Canada (Canada) under ACC-LAB (Europe/Canada MRA and APEC/Canada MRA)
- Recognized/Listed by FCC (USA)
- All test results contained in this engineering test report are traceable to National Institute of Standards and Technology (NIST)

The calculation of conversion factor (γ) from (Eq. 5.6.4.21) follows:

$$\gamma = \frac{0.97}{\frac{10.8}{3,770} \times 1,200} \times \frac{28.5}{1.467} = 5.482$$

5.6.5. Data Acquisition Methodology

5.6.5.1. E-Field Measurement

The probe calibration must be current before starting measurements. Instrumentation amplifier batteries must be charged. This can be monitored by observing DC offset voltages. A daily log of the DC offset voltages should be kept for this purpose.

Measurements in the phantom are automatically calculated for each location by summation of the three dipole outputs. Because each dipole produces an output voltage proportional to the square of the electric field component along the dipole, the sum of dipole voltages represents the RMS values for the total electric field. Thus, taking into consideration the amplifier settings and the DC offset voltages, the total electric field strength at a measurement location is as follows. See Appendix C. PO_{tot} is labeled by the software as measure of values (volts). The SAR for calculations that are derived from the measure of values are discussed below.

At each measurement point, the program records the output of the three channels:

$$|E_i|^2 [(V/m)^2] = \frac{PO_i [mV]}{\eta_{E2} [mV/(V/m)^2]} = \frac{U_{L,i} \times AS_i}{\eta_{E2} [mV/(V/m)^2]}$$

$$|E|^2 [(V/m)^2] = \sum_i |E_i|^2 = \frac{1}{\eta_{E2}} \times \sum_i PO_i = \frac{PO_{tot}}{\eta_{E2}} = \frac{1}{\eta_{E2}} \times \sum_i (U_{L,i} \times AS_i)$$

Where,

$U_{L,i}$	Linearized probe output for channel i
AS_i	Amplifier Setting for channel i
η_{E2}	Sensor Factor to the uniform $ E ^2$, an arbitrary value 10.8/3,770 [mV/(V/m) ²]
PO_i	Probe output [mV] of channel i at a measurement point
PO_{tot}	Total Probe output [mV] at a measurement point

5.6.5.2. Sensitivity(ζ) of probe in the simulated tissue

The sensitivity(ζ) of the probe in the simulated tissue is rendered in terms of Sensor Enhancement Factor in the simulated tissue.

$$\zeta = \frac{\sigma_{@meas}}{\eta_{E2} \times \rho \times \gamma} = \frac{\sigma_{@meas}}{\frac{10.8}{3,770} \times 1,000 \times \gamma} = \frac{3,770 \times \sigma_{@meas}}{10,800 \times \gamma} \tag{Eq. 5.6.5.21}$$

Where,

ULTRATECH GROUP OF LABS

3000 Bristol Circle, Oakville, Ontario, Canada L6H 6G4
 Tel. #: 905-829-1570, Fax. #: 905-829-8050, Email: vic@ultratech-labs.com, Website: http://www.ultratech-labs.com

File #: MIS-053-SAR
March 27, 2006

- Assessed by ITI (UK) Competent Body, NVLAP (USA) Accreditation Body & ACA/AUSTEL (Australia), VCCI (Japan)
- Accredited by Industry Canada (Canada) under ACC-LAB (Europe/Canada MRA and APEC/Canada MRA)
- Recognized/Listed by FCC (USA)
- All test results contained in this engineering test report are traceable to National Institute of Standards and Technology (NIST)

ζ	Sensitivity of the probe in the simulated tissue [W/Kg/mV]
γ	Conversion factor; ratio of sensor response in air to response in the dielectric media
η_{E2}	Sensor Factor to the $ E ^2$, an arbitrary value 10.8/3,770 [mV/(V/m) ²]
$\sigma_{@meas}$	Conductivity of the simulated tissue during the measurement [S/m]
ρ	Mass density of the simulated tissue [Kg/m ³]; 1,000 [Kg/m3] is conventionally chosen.

Therefore, SAR can be yielded from

$$SAR = \zeta \times PO_{tot_tissue} \tag{Eq. 5.6.5.22}$$

Where,

ζ	Sensitivity of the probe in the simulated tissue [W/Kg/mV]
PO_{tot_tissue}	Probe voltage output measured in the simulated tissue [mV]

To continue the example illustrated above,

$$\begin{aligned} \sigma_{@meas} &= 0.99 \text{ [S/m]} \\ PO_{tot_tissue} &= 11.5 \text{ [mV]} \end{aligned}$$

$$\zeta = \frac{3,770 \times \sigma_{@meas}}{10,800 \times \eta} = \frac{3,770 \times 0.99}{10,800 \times 5.482} = 0.063 \text{ [W/Kg/mV]}$$

$$SAR = \zeta \times PO_{tot_tissue} = 0.063 \times 11.5 = 0.725 \text{ [W/Kg]}$$

5.6.5.3. SAR Measurement

The goal of the measurement process is to scan the phantom over a selected area in order to find the region of highest levels of RF energy and then to obtain a single value for the peak spatial-average of SAR over a volume that would contain one gram (in the shape of a cube) of biological tissue. The test procedure, of course, measures SAR in the simulated tissue.

- Assessed by ITI (UK) Competent Body, NVLAP (USA) Accreditation Body & ACA/AUSTEL (Australia), VCCI (Japan)
- Accredited by Industry Canada (Canada) under ACC-LAB (Europe/Canada MRA and APEC/Canada MRA)
- Recognized/Listed by FCC (USA)
- All test results contained in this engineering test report are traceable to National Institute of Standards and Technology (NIST)

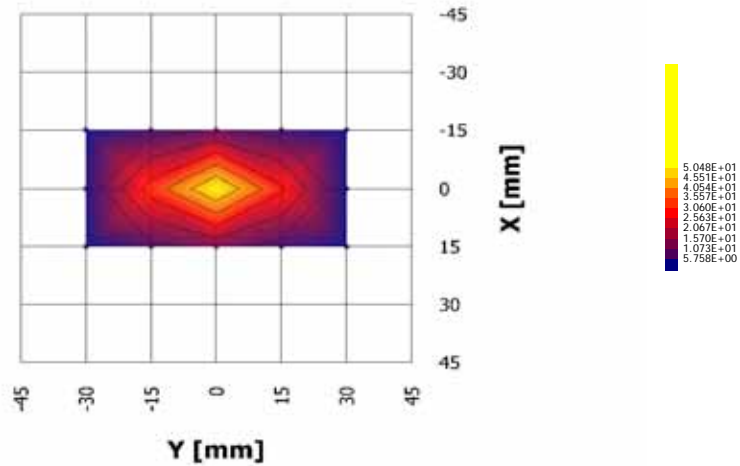

Figure 5.6.5.3 Area scan

The software request the user to move the probe to locations at two extreme corners of a rectangle that encloses the area to be scanned. An arbitrary origin and the spatial resolution for the scan are also specified. Under program control, the scan is performed automatically by the robot-guided probe.

- Assessed by ITI (UK) Competent Body, NVLAP (USA) Accreditation Body & ACA/AUSTEL (Australia), VCCI (Japan)
- Accredited by Industry Canada (Canada) under ACC-LAB (Europe/Canada MRA and APEC/Canada MRA)
- Recognized/Listed by FCC (USA)
- All test results contained in this engineering test report are traceable to National Institute of Standards and Technology (NIST)

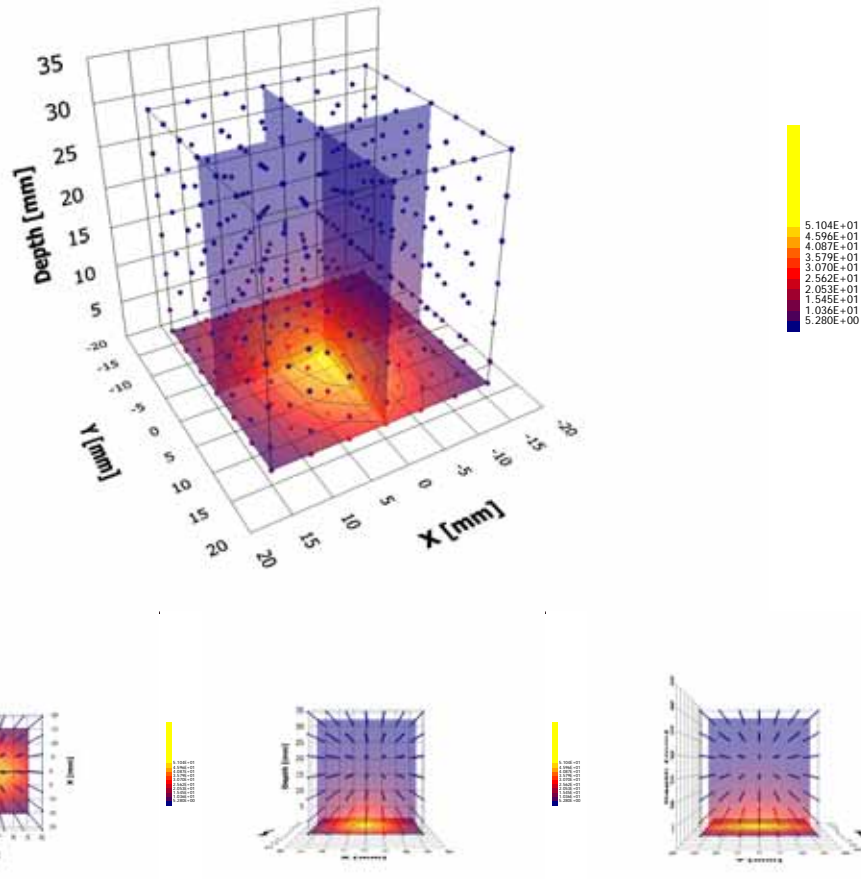

Figure 5.6.5.3 Zoom Scan

The fine resolution volume scan region is centered at the peak SAR locations determined by the interpolated (cubic spline) data from the area scan measurements. The number of measurement point required in a zoom scan is defined to provide an accurate one-gram averaged SAR in terms of both the number of points ($PT_x \times PT_y \times PT_z$) and the size ($SZ_x[\text{mm}] \times SZ_y[\text{mm}] \times SZ_z[\text{mm}]$) of the cubic. For one-gram SAR, $(5 \times 5 \times 7)$ and $(28[\text{mm}] \times 28[\text{mm}] \times 30[\text{mm}])$ is preferred to select below 1 GHz. The zoom scan region extends in each direction for at least 1.5 times the linear dimensions of 1- or 10-gram cube of tissue from each peak. The zoom scan spatial resolution is interpolated down to SAR values on a 1mm grid by using the tri-linear interpolation algorithm.

The peak field values near the surface of a homogeneous phantom are usually not measurable because the sensors in a field probe are located at 2-4 mm behind the tip of the probe and the measurement point is defined at the geometric center of the sensors where the calibration is defined. These SAR values are computed by extrapolating the closest measured points to the surface of the phantom to determine the highest one-gram averaged SAR. The extrapolation

ULTRATECH GROUP OF LABS

3000 Bristol Circle, Oakville, Ontario, Canada L6H 6G4
 Tel. #: 905-829-1570, Fax. #: 905-829-8050, Email: vic@ultratech-labs.com, Website: http://www.ultratech-labs.com

File #: MIS-053-SAR
March 27, 2006

- Assessed by ITI (UK) Competent Body, NVLAP (USA) Accreditation Body & ACA/AUSTEL (Australia), VCCI (Japan)
- Accredited by Industry Canada (Canada) under ACC-LAB (Europe/Canada MRA and APEC/Canada MRA)
- Recognized/Listed by FCC (USA)
- All test results contained in this engineering test report are traceable to National Institute of Standards and Technology (NIST)

coefficients are determined with a multi-order curve-fitting algorithm. Generally the 4-th order polynomial least-square fit is sufficient to extrapolate to the surface if the number of the valid measurements, that are non-zero, along the probe axis is greater than 4.

The interpolated and extrapolated SAR values from the zoom scan measurements are integrated in the shape of 1- or 10-gram cube then traversed to determine the highest peak spatial-average SAR in the zoom scan region.

This peak spatial-averaged SAR is reported as SAR [W/kg] for compliance.

5.6.5.4. Data Extrapolation and boundary effect

The distance from the center of the sensor (diode) to the end of the protective tube is called the ‘probe offset’ or ‘sensor offset’. To compensate we use a multi-order polynomial least-square curve fitting to obtain the peak surface value from the voltages measured at the distance from the inner surface of the phantom. The field is measured as close as possible to the phantom’s surface and every pre-defined separation distance (1 [mm] to 5 [mm]) along the probe axis (z) for a distance of at least 50 mm until they are not measurable. The appropriate curve is obtained from all the points measured and used to define an exponential decay of the energy density versus depth.

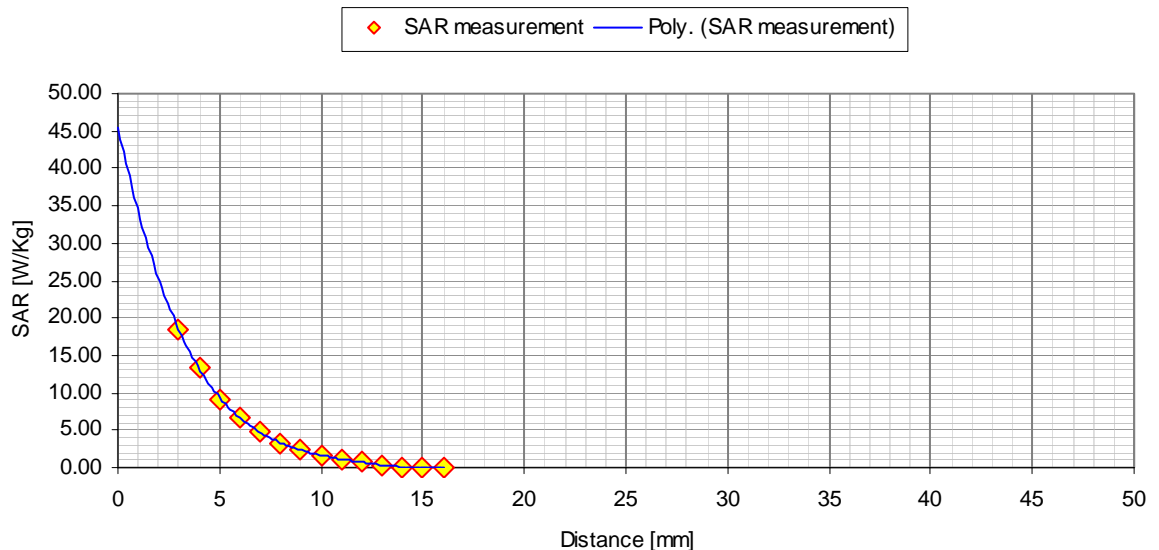

Figure 5.6.5.4 Exponential decay of the energy density versus depth

In general, 4-th order polynomial curve fitting will be applied for extrapolation to the surface, but whenever the 4-th order polynomial is not application from the lack of the input data the lower order polynomial curve fitting will be applied instead.

Boundary effects arise when the tip of an electric field probe approaches the interface between two dielectric media. Under these conditions, the external field is strongly perturbed by the superposition of a scattered field from the probe. The effect of the boundary on the peak spatial-average SAR values strongly depends on the probe dimensions, especially

- Assessed by ITI (UK) Competent Body, NVLAP (USA) Accreditation Body & ACA/AUSTEL (Australia), VCCI (Japan)
- Accredited by Industry Canada (Canada) under ACC-LAB (Europe/Canada MRA and APEC/Canada MRA)
- Recognized/Listed by FCC (USA)
- All test results contained in this engineering test report are traceable to National Institute of Standards and Technology (NIST)

the diameter of the tip of the probe. It is known that the error due to boundary effects is very small if the distance between the probe tip and the surface is greater than half the probe diameter. Therefore the first one or two measurements at the vicinity to the phantom surface are excluded for evaluating the exponential decay curve in order to compensate for the boundary effect.

5.6.6. Determining the Heat Capacity of Simulated Tissue

5.6.6.1. Instruments and Materials

- Calibrated differential thermometer (Vitek or BAT-8 or equivalent)
- Two identical 500 ml containers
- A thermally insulated vessel (thick styrofoam, with a form fitting hole for one container)
- Hot and cold tap water
- Solution under test
- Hot plate
- Temperature vs. time (chart recorder, or data logger)

5.6.6.2. Method

Heat can be propagated by conduction, convection and radiation. In the case of liquids heated from below, gravity convection is the main and predominant heating mechanism of the fluid mass.

Obtain two containers that can be rapidly heated (e.g. glass or suitable plastic). Fill one container with 250 ml of water, the other with the same mass of simulated tissue. The initial temperature of the water should be the same as that of the simulated tissue ($\pm 1^\circ\text{C}$). Since we are dealing with heating by electromagnetic sources at ambient temperature, it is essential that we eliminate the chance of any direct infrared heating of the temperature sensor. To ensure this, position the tip of the sensor 2 mm from the bottom of the center of the container. Turn on the heat source and wait at least 5 minutes for its temperature to stabilize. Record the initial temperature of the water. Place the container of water 5 mm above the center of the hot plate and monitor the temperature increase.

After 30 seconds of heating, the water temperature should have increased by at least 5°C . Record the time and temperature. Remove the container from the heat source and place it in the thermally insulated vessel. Stir the liquid thoroughly and record the steady state temperature 1-2 minutes after stirring.

Repeat the above procedure using the container of simulated tissue. Ensure that the container is placed on the same area of the hot plate, is heated for the identical length of time, and the steady state temperature is recorded after the identical time interval.

Since the heat capacity of water is $C_w = 1,000$ [cal/Kg/ $^\circ\text{C}$] or $4,189$ [J/Kg/ $^\circ\text{C}$] with excellent approximation ($\sim 1\%$) in the temperature range of interest, the heat capacity (C_s) of the solution is given by:

$$C_s = C_w \cdot \frac{\Delta T_w}{\Delta T_s}$$

where ΔT_w is the temperature increase of water and ΔT_s the temperature increase of the solution. The ration of the values, $\Delta T_w / \Delta T_s$, should be the same (within the sensitivity of the thermometer) at the end of the heating and stirring. This ensures that the liquids have been uniformly heated.

ULTRATECH GROUP OF LABS

3000 Bristol Circle, Oakville, Ontario, Canada L6H 6G4

Tel. #: 905-829-1570, Fax. #: 905-829-8050, Email: vic@ultratech-labs.com, Website: <http://www.ultratech-labs.com>

File #: MIS-053-SAR

March 27, 2006

- Assessed by ITI (UK) Competent Body, NVLAP (USA) Accreditation Body & ACA/AUSTEL (Australia), VCCI (Japan)
- Accredited by Industry Canada (Canada) under ACC-LAB (Europe/Canada MRA and APEC/Canada MRA)
- Recognized/Listed by FCC (USA)
- All test results contained in this engineering test report are traceable to National Institute of Standards and Technology (NIST)

5.6.6.3. Rationale

$$C \cdot \Delta T = \text{Heat_Flow} \cdot \text{Time} = \text{Total_Heating_Energy}$$

If the heat flow, sample mass, and absorption (heat transfer) are the same for both liquids, then:

$$C_w \cdot \Delta T_w = C_s \cdot \Delta T_s$$

The heat flow and total heating are kept constant by using the same source for the same amount of time. If the heat transfer mechanisms for the two liquids are about the same, with insignificant differences in convective and conductive characteristics, then any differences in temperature increase are a direct measure of the specific heat capacity, C .

ULTRATECH GROUP OF LABS

3000 Bristol Circle, Oakville, Ontario, Canada L6H 6G4
Tel. #: 905-829-1570, Fax. #: 905-829-8050, Email: vic@ultratech-labs.com, Website: <http://www.ultratech-labs.com>

File #: MIS-053-SAR
March 27, 2006

- Assessed by ITI (UK) Competent Body, NVLAP (USA) Accreditation Body & ACA/AUSTEL (Australia), VCCI (Japan)
- Accredited by Industry Canada (Canada) under ACC-LAB (Europe/Canada MRA and APEC/Canada MRA)
- Recognized/Listed by FCC (USA)
- All test results contained in this engineering test report are traceable to National Institute of Standards and Technology (NIST)

5.7. SAR MEASUREMENT SYSTEM VERIFICATION

5.7.1. Standard Source

A half-wave dipole is positioned below the bottom of the phantom and centered with its axis parallel to the longest side of the phantom. The distance between the liquid filled phantom bottom surface and the center of the dipole axis, s , is chosen as specified IEEE 1528 at the specific test frequency (i.e. 15 mm at 835 MHz). A low loss and low dielectric constant spacer is used to establish the correct distance between the top surface of the dipole and the bottom surface of the phantom.

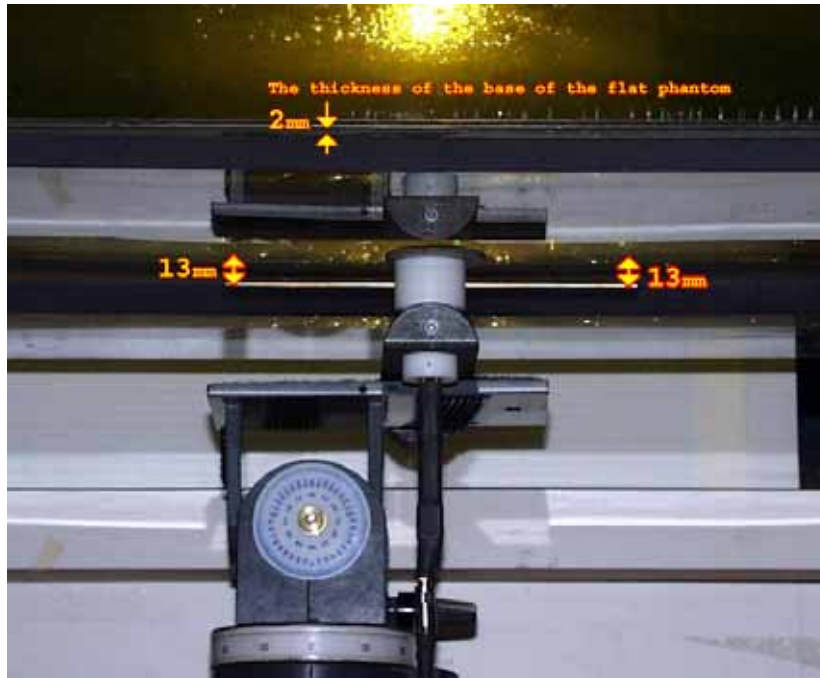

5.7.2. Standard Source Input Power Measurement

The system validation is performed as shown below or in Figure 7.1 in IEEE 1528.

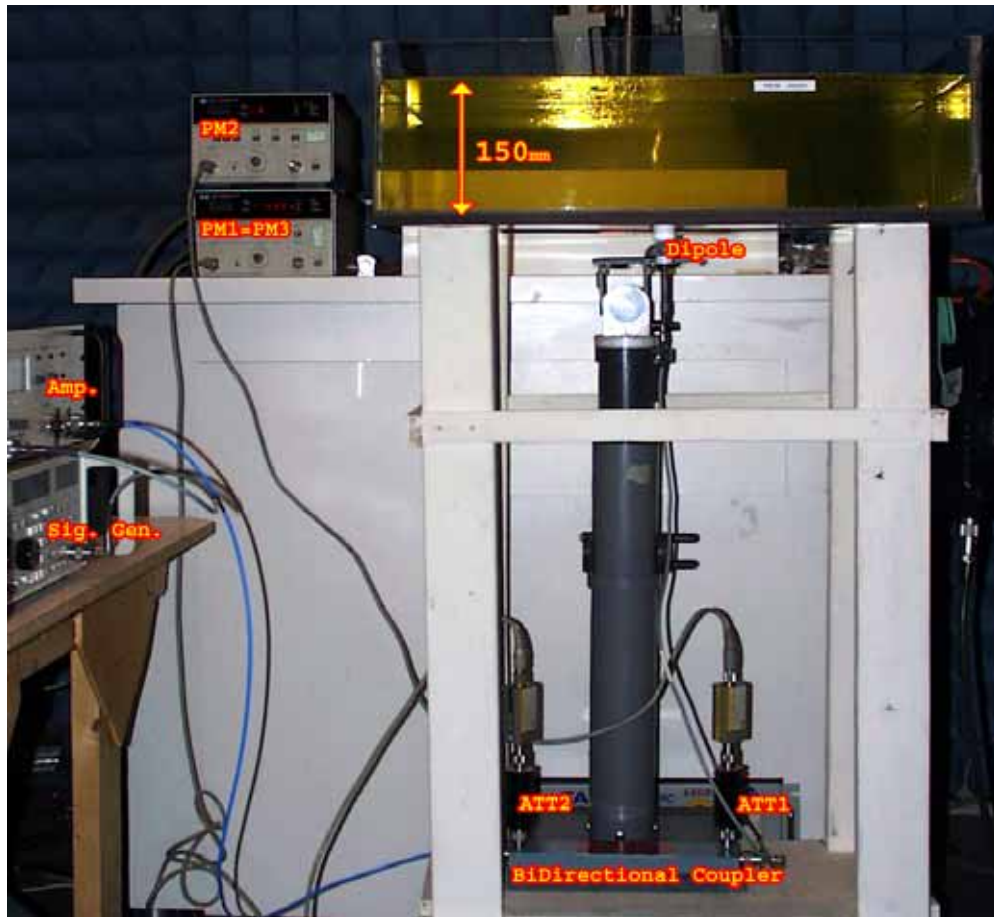

First the power meter PM1 (including attenuator Att1) is connected to the cable to measure the forward power at the location of the dipole connector (X). The signal generator is adjusted for the desired forward power at the dipole connector (taking into account the attenuation of Att1) as read by power meter PM2. After connecting the cable to the dipole, the signal generator is readjusted for the same reading at power meter PM2. If the signal generator does not allow adjustment in 0.01dB steps, the remaining difference at PM2 must be taken into consideration. PM3 records the reflected power from the dipole to ensure that the value is not changed from the previous value. The reflected power was verified to be at least 20dB below the forward power.

5.7.3. System Validation Procedure

A complete 1g-averaged SAR measurement is performed. The measured 1g-averaged SAR value is normalized to a forward power of 1W to a half-wave dipole and compared with the reference SAR value for the reference dipole and flat phantom shown in columns 2 and 3 of Table 7.1 in IEEE 1528.

ULTRATECH GROUP OF LABS

3000 Bristol Circle, Oakville, Ontario, Canada L6H 6G4
 Tel. #: 905-829-1570, Fax. #: 905-829-8050, Email: vic@ultratech-labs.com, Website: http://www.ultratech-labs.com

File #: MIS-053-SAR
March 27, 2006

- Assessed by ITI (UK) Competent Body, NVLAP (USA) Accreditation Body & ACA/AUSTEL (Australia), VCCI (Japan)
- Accredited by Industry Canada (Canada) under ACC-LAB (Europe/Canada MRA and APEC/Canada MRA)
- Recognized/Listed by FCC (USA)
- All test results contained in this engineering test report are traceable to National Institute of Standards and Technology (NIST)

5.8. POWER MEASUREMENT

Whenever possible, a conducted power measurement is performed. To accomplish this, we utilize a fully charged battery, a calibrated power meter and a cable adapter provided by the manufacturer. The data of the cable and related circuit losses are also provided by the manufacturer. The power measurement is then performed across the operational band and the channel with the highest output power is recorded.

Power measurement is performed before and after the SAR to verify if the battery was delivering full power at the time of testing. A difference in output power would determine a need for battery replacement and to repeat the SAR test.

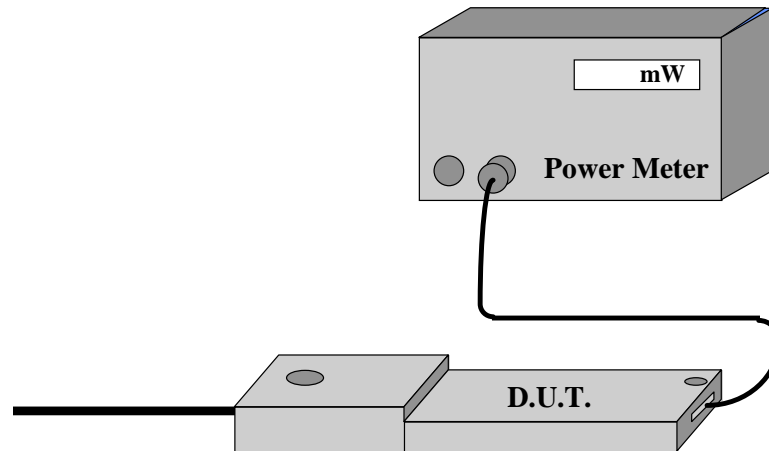

Figure 5.8. 1.Measured Power + Cable and Switching Mechanism Loss

ULTRATECH GROUP OF LABS

3000 Bristol Circle, Oakville, Ontario, Canada L6H 6G4

Tel. #: 905-829-1570, Fax. #: 905-829-8050, Email: vic@ultratech-labs.com, Website: <http://www.ultratech-labs.com>

File #: MIS-053-SAR

March 27, 2006

- Assessed by ITI (UK) Competent Body, NVLAP (USA) Accreditation Body & ACA/AUSTEL (Australia), VCCI (Japan)
- Accredited by Industry Canada (Canada) under ACC-LAB (Europe/Canada MRA and APEC/Canada MRA)
- Recognized/Listed by FCC (USA)
- All test results contained in this engineering test report are traceable to National Institute of Standards and Technology (NIST)

5.9. POSITIONING OF D.U.T.

The clear SAM phantom shell have been previously marked with a highly visible grid with a defined centre line, so it can easily be seen through the liquid simulated tissue. In the case of testing a cellular phone, this line is connecting the ear channel with the corner of the lips. The D.U.T. is then placed by centering the speaker with the ear channel and the center of the radio width with the corner of the mouth.

For HAND HELD devices (push-to-talk), or any other type of wireless transmitters positioned in front of the face, the D.U.T. will be positioned 2.5cm distance from a flat phantom to simulate the frontal facial position in use. All body-worn operating configurations are tested using a flat phantom. The length and width of the phantom is at least twice the corresponding dimensions of the test device, including its antenna.

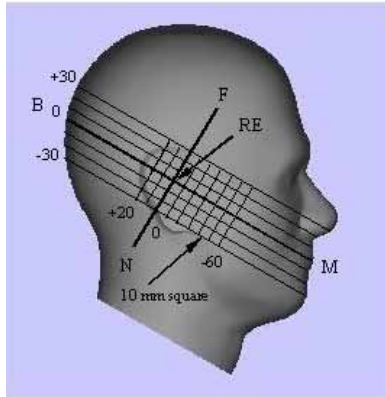

Figure 5.9. 1. Side view of the phantom showing relevant marking

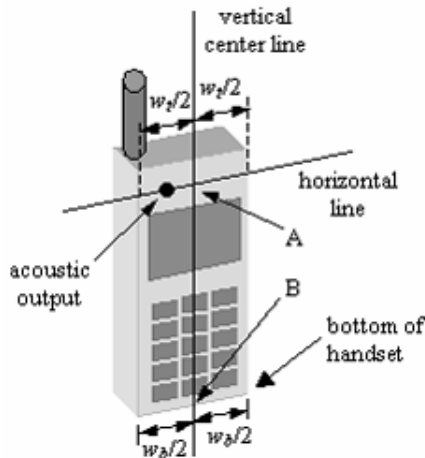

Figure 5.9. 2. Handset vertical and horizontal reference lines – fixed case

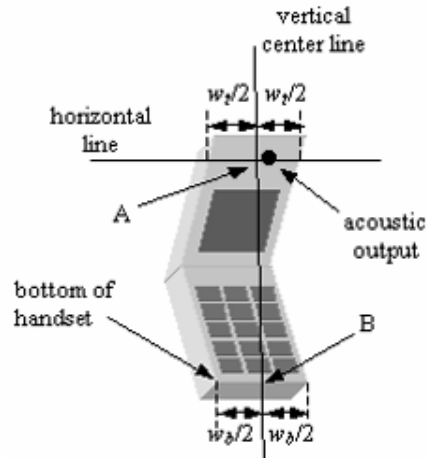

Figure 5.9. . Handset vertical and horizontal reference lines – “clam-shell”

- Assessed by ITI (UK) Competent Body, NVLAP (USA) Accreditation Body & ACA/AUSTEL (Australia), VCCI (Japan)
- Accredited by Industry Canada (Canada) under ACC-LAB (Europe/Canada MRA and APEC/Canada MRA)
- Recognized/Listed by FCC (USA)
- All test results contained in this engineering test report are traceable to National Institute of Standards and Technology (NIST)

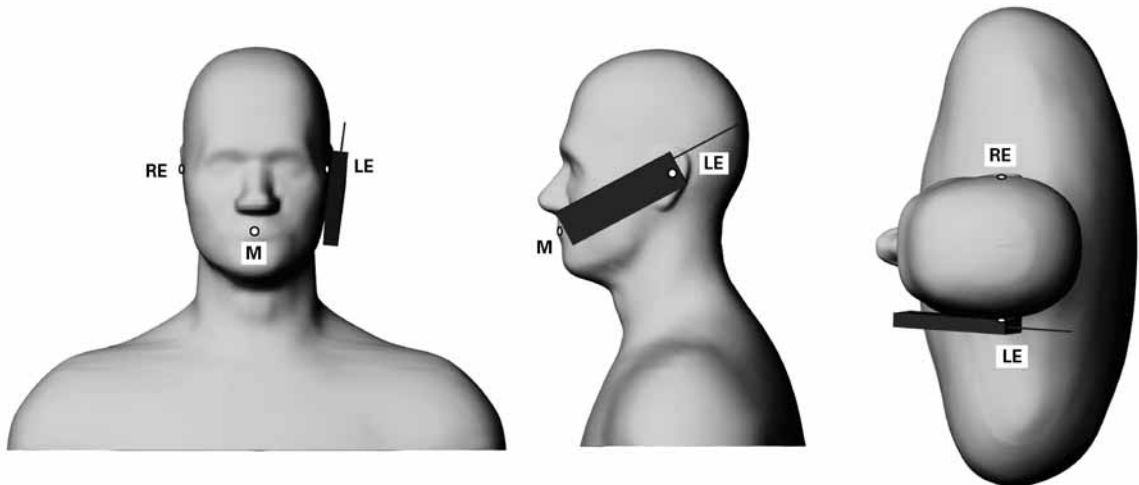

Figure 5.9. 4. Phone position 1, “cheek” or “touch” position. The reference points for the right ear (RE), left ear (LE) and mouth (M), which define the reference plane for phone positioning, are indicated. The shoulders are shown for illustration purposes only.

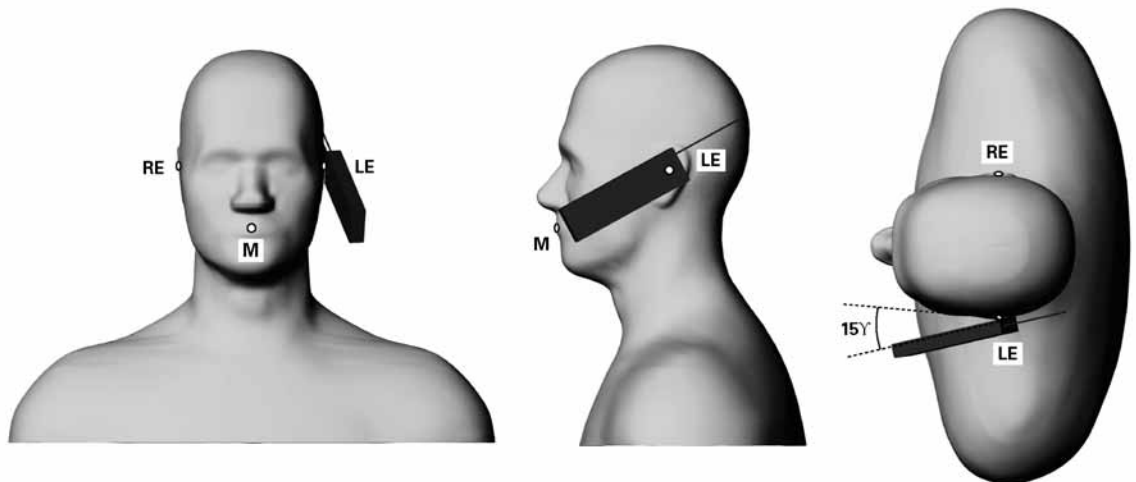

Figure 5.9. 5. Phone position 2, “tilted position.” The reference points for the right ear (RE), left ear (LE) and mouth (M), which define the reference plane for phone positioning, are indicated. The shoulders are shown for illustration purposes only.

The handset holder is mainly made of PVC and contains no metallic component at all in order to minimize field perturbation. Velcro and elastic band were used to attach the D.U.T. on the plate of handset holder.

ULTRATECH GROUP OF LABS

3000 Bristol Circle, Oakville, Ontario, Canada L6H 6G4
 Tel. #: 905-829-1570, Fax. #: 905-829-8050, Email: vic@ultratech-labs.com, Website: http://www.ultratech-labs.com

File #: MIS-053-SAR
March 27, 2006

- Assessed by ITI (UK) Competent Body, NVLAP (USA) Accreditation Body & ACA/AUSTEL (Australia), VCCI (Japan)
- Accredited by Industry Canada (Canada) under ACC-LAB (Europe/Canada MRA and APEC/Canada MRA)
- Recognized/Listed by FCC (USA)
- All test results contained in this engineering test report are traceable to National Institute of Standards and Technology (NIST)

5.10. SAR MEASUREMENT UNCERTAINTY

This uncertainty analysis covers the 3D-EMC Laboratory test procedure for Specific Absorption Rate (SAR) associated with wireless telephones and similar devices.

Standards Covered Are:

WGMTE 96/4 - Secretary SC211/B

FCC 96-326, ET Docket No. 93-62

Industry Canada RSS 102

ACA Radiocommunications (Electromagnetic Radiation – Human Exposure) Amendment Standard 2000 (No. 1)

The laboratory test procedure, and this uncertainty analysis, may be used to cover all standards above. It is based on test equipment and procedures specified by 3D-EMC Laboratories, Inc. located in Ft. Lauderdale, Florida.

ULTRATECH GROUP OF LABS

3000 Bristol Circle, Oakville, Ontario, Canada L6H 6G4

Tel. #: 905-829-1570, Fax. #: 905-829-8050, Email: vic@ultratech-labs.com, Website: <http://www.ultratech-labs.com>

File #: MIS-053-SAR

March 27, 2006

- Assessed by ITI (UK) Competent Body, NVLAP (USA) Accreditation Body & ACA/AUSTEL (Australia), VCCI (Japan)
- Accredited by Industry Canada (Canada) under ACC-LAB (Europe/Canada MRA and APEC/Canada MRA)
- Recognized/Listed by FCC (USA)
- *All test results contained in this engineering test report are traceable to National Institute of Standards and Technology (NIST)*

5.10.1. Measurement Uncertainty

5.10.1.1. Measurement Uncertainty evaluation for handset SAR test

<i>a</i>	<i>b</i>	<i>c</i>	<i>d</i>	<i>e = f(d,k)</i>	<i>F</i>	<i>g</i>	<i>h = c x f / e</i>	<i>i = c x g / e</i>	<i>k</i>
Uncertainty Component	Sec.	Tol. (± %)	Prob. Dist.	Div.	<i>c_i</i> (1-g)	<i>c_i</i> (10-g)	1-g <i>u_i</i> (±%)	10-g <i>u_i</i> (±%)	<i>v_i</i>
Measurement System									
Probe Calibration	E1.1	3.0	N	1	1	1	3.0	3.0	∞
Axial Isotropy	E1.2	5.0	R	√3	0.7	0.7	2.0	2.0	∞
Hemispherical Isotropy	E1.2	8.0	R	√3	1	1	4.6	4.6	∞
Boundary Effect	E1.3	10.0	R	√3	1	1	5.8	5.8	∞
Linearity	E1.4	4.2	R	√3	1	1	2.4	2.4	∞
System Detection Limits	E1.5	2.0	R	√3	1	1	1.2	1.2	∞
Readout Electronics	E1.6	1.0	N	1	1	1	1.0	1.0	∞
Response Time	E1.7	1.5	R	√3	1	1	0.9	0.9	∞
Integration Time	E1.8	2.0	R	√3	1	1	1.2	1.2	∞
RF Ambient Conditions	E5.1	3.0	R	√3	1	1	1.7	1.7	∞
Probe Positioner Mechanical Tolerance	E5.2	^{1.0}	R	√3	1	1	0.6	0.6	∞
Probe Positioning with respect to Phantom Shell	E5.3	3.0	R	√3	1	1	1.7	1.7	∞
Extrapolation, interpolation and Integration Algorithms for Max. SAR Evaluation	E4.2	^{3.5}	R	√3	1	1	2.0	2.0	∞
Test sample Related									
Test Sample Positioning	E3.2.1	7.5	N	1	1	1	7.5	7.5	11
Device Holder Uncertainty	E3.1.1	6.5	N	1	1	1	6.5	6.5	8
Output Power Variation - SAR drift measurement	5.6.2	5.0	R	√3	1	1	2.9	2.9	∞
Phantom and Tissue Parameters									
Phantom Uncertainty (shape and thickness tolerances)	E2.1	4.0	R	√3	1	1	2.3	2.3	∞
Liquid Conductivity Target - tolerance	E2.2	5.0	R	√3	0.7	0.5	2.0	1.4	∞
Liquid Conductivity - measurement uncertainty	E2.2	4.0	R	√3	0.7	0.5	1.6	1.2	∞
Liquid Permittivity Target tolerance	E2.2	5.0	R	√3	0.6	0.5	1.7	1.4	∞
Liquid Permittivity - measurement uncertainty	E2.2	4.0	R	√3	0.6	0.5	1.4	1.2	∞
Combined Standard Uncertainty			RSS				14.3	14.2	
Expanded Uncertainty (95% confidence interval)							28.5	28.3	

- Assessed by ITI (UK) Competent Body, NVLAP (USA) Accreditation Body & ACA/AUSTEL (Australia), VCCI (Japan)
- Accredited by Industry Canada (Canada) under ACC-LAB (Europe/Canada MRA and APEC/Canada MRA)
- Recognized/Listed by FCC (USA)
- All test results contained in this engineering test report are traceable to National Institute of Standards and Technology (NIST)

5.10.1.2. Measurement Uncertainty for System Performance Check

<i>a</i>	<i>b</i>	<i>c</i>	<i>d</i>	<i>e = f(d,k)</i>	<i>f</i>	<i>g</i>	<i>h = c x f / e</i>	<i>i = c x g / e</i>	<i>k</i>
Uncertainty Component	Sec.	Tol. (± %)	Prob. Dist.	Div.	<i>c_i (1-g)</i>	<i>c_i (10-g)</i>	1-g <i>u_i</i> (±%)	10-g <i>u_i</i> (±%)	<i>v_i or v_{eff}</i>
Measurement System									
Probe Calibration	E1.1	3.0	N	1	1	1	3.0	3.0	∞
Axial Isotropy	E1.2	5.0	R	√3	0.7	0.7	2.0	2.0	∞
Hemispherical Isotropy	E1.2	8.0	R	√3	1	1	4.6	4.6	∞
Boundary Effect	E1.3	10.0	R	√3	1	1	5.8	5.8	∞
Linearity	E1.4	4.2	R	√3	1	1	2.4	2.4	∞
System Detection Limits	E1.5	2.0	R	√3	1	1	1.2	1.2	∞
Readout Electronics	E1.6	1.0	N	1	1	1	1.0	1.0	∞
Response Time	E1.7	1.5	R	√3	1	1	0.9	0.9	∞
Integration Time	E1.8	2.0	R	√3	1	1	1.2	1.2	∞
RF Ambient Conditions	E5.1	3.0	R	√3	1	1	1.7	1.7	∞
Probe Positioner Mechanical Tolerance	E5.2	0.4	R	√3	1	1	0.2	0.2	∞
Probe Positioning with respect to Phantom Shell	E5.3	3.0	R	√3	1	1	1.7	1.7	∞
Extrapolation, interpolation and Integration Algorithms for Max. SAR Evaluation	E4.2	3.5	R	√3	1	1	2.0	2.0	∞
Dipole									
Dipole Axis to Liquid Distance	7, X3.2	2.0	R	√3	1	1	1.2	1.2	∞
Input Power and SAR Drift Measurement	7, 5.6.2	3.0	R	√3	1	1	1.7	1.7	∞
Phantom and Tissue Parameters									
Phantom Uncertainty - shell thickness tolerance	E2.1	4.0	R	√3	1	1	2.3	2.3	∞
Liquid Conductivity – deviation from target values	E2.2	5.0	R	√3	0.7	0.5	2.0	1.4	∞
Liquid Conductivity - measurement uncertainty	E2.2	4.0	R	√3	0.7	0.5	1.6	1.2	∞
Liquid Permittivity – deviation from target values	E2.2	5.0	R	√3	0.6	0.5	1.7	1.4	∞
Liquid Permittivity - measurement uncertainty	E2.2	4.0	R	√3	0.6	0.5	1.4	1.2	∞
Combined Standard Uncertainty			RSS				10.0	9.9	
Expanded Uncertainty (95% confidence interval)							20.1	19.8	

ULTRATECH GROUP OF LABS

3000 Bristol Circle, Oakville, Ontario, Canada L6H 6G4
 Tel. #: 905-829-1570, Fax. #: 905-829-8050, Email: vic@ultratech-labs.com, Website: http://www.ultratech-labs.com

**File #: MIS-053-SAR
 March 27, 2006**

- Assessed by ITI (UK) Competent Body, NVLAP (USA) Accreditation Body & ACA/AUSTEL (Australia), VCCI (Japan)
- Accredited by Industry Canada (Canada) under ACC-LAB (Europe/Canada MRA and APEC/Canada MRA)
- Recognized/Listed by FCC (USA)
- All test results contained in this engineering test report are traceable to National Institute of Standards and Technology (NIST)

EXHIBIT 6. SAR PRESCANS

6.1.1. Body Configuration

6.1.1.1. Test configurations used

Body-worn operating configurations should be tested with the belt-clips and holsters attached to the device and positioned against a flat phantom in normal use configurations. Devices with a headset output should be tested with a headset connected to the device. The D.U.T. was placed against the phantom and tested in its appropriate holster as would normally be used by the end user. If the SAR measured at the middle channel for each test is at least 3.0 dB lower than the SAR limit, testing at the high and low channels is optional for such test configuration(s).

If the transmission band of the test device is less than 10 MHz, testing at the high and low frequency channels is optional.

When multiple accessories that do not contain metallic components are supplied with the device, the device may be tested with only the accessory that dictates the closest spacing to the body. When multiple accessories that contain metallic components are supplied with the device, the device must be tested with each accessory that contains a unique metallic component. If multiple accessories share an identical metallic component (e.g., the same metallic belt-clip used with different holsters with no other metallic components), only the accessory that dictates the closest spacing to the body must be tested.

Body-worn accessories may not always be supplied or available as options for some devices that are intended to be authorized for body-worn use. A separation distance of 1.5 cm between the back of the device and a flat phantom is recommended for testing body-worn SAR compliance under such circumstances. Other separation distances may be used, but they should not exceed 2.5 cm. In these cases, the device may use body-worn accessories that provide a separation distance greater than that tested for the device provided however that the accessory contains no metallic components..

6.1.1.2. Equipment permutation investigated for each orientation

N/A

6.1.1.3. Comments on non-tested configurations

N/A

6.2. RECOMMENDED CAUTION STATEMENTS TO BE INCLUDED IN USERS MANUAL

In order for users to be aware of the body-worn operating requirements for meeting RF exposure compliance, operating instructions and caution statements should be included in the manual. The information should allow users to make informed decisions on the type of body-worn accessories and operating configurations that are appropriate for the device. The following are *examples* of typical statements that provide end-users with the necessary information about body-worn accessories:

Example 1. For a product that has the potential to be used in a body worn configuration and has been tested and certified with a specific accessory device(s):

“For body worn operation, this phone has been tested and meets the FCC RF exposure guidelines when used with the (*manufacturer name*) accessories supplied or designated for this product. Use of other accessories may not ensure compliance with FCC RF exposure guidelines.”

Example 2. For a product that has the potential to be used in a body worn configuration and has not been certified with a specific accessory device(s):

“For body worn operation, this phone has been tested and meets FCC RF exposure guidelines when used with an accessory that contains no metal and that positions the handset a minimum of (specified distance) from the body. Use of other accessories may not ensure compliance with FCC RF exposure guidelines.”

Example 3. For a product that has the potential to be used in a body worn configuration with future manufacturer designed accessories:

“For body worn operation, this phone has been tested and meets the FCC RF exposure guidelines when used with a (*manufacturer name*) accessory designated for this product or when used with an accessory that contains no metal and that positions the handset a minimum of (specified distance) from the body.”

ULTRATECH GROUP OF LABS

3000 Bristol Circle, Oakville, Ontario, Canada L6H 6G4

Tel. #: 905-829-1570, Fax. #: 905-829-8050, Email: vic@ultratech-labs.com, Website: <http://www.ultratech-labs.com>

File #: MIS-053-SAR

March 27, 2006

- Assessed by ITI (UK) Competent Body, NVLAP (USA) Accreditation Body & ACA/AUSTEL (Australia), VCCI (Japan)
- Accredited by Industry Canada (Canada) under ACC-LAB (Europe/Canada MRA and APEC/Canada MRA)
- Recognized/Listed by FCC (USA)
- All test results contained in this engineering test report are traceable to National Institute of Standards and Technology (NIST)

EXHIBIT 7. SAR MEASUREMENT

7.1. BODY CONFIGURATION

7.1.1. CDMA*

#	Configuration	Antenna Position	Frequency [MHz]	Channel	SAR _{local} Before [W/Kg]	SAR _{local} After [W/Kg]	MAX SAR _{1g} [W/Kg]
* General Population/Uncontrolled Exposure Category Limit							1.6
01	Ni-MH Rechargeable Battery Right side of DUT in parallel to the phantom with spacing of 10 mm	Internal	824.70	1013	0.12	0.11	0.63
02		Internal	836.52	0384	0.26	0.25	0.80
03		Internal	848.97	0777	0.12	0.12	0.55
04	Ni-MH Rechargeable Battery Back side of DUT in parallel to the phantom with spacing of 10 mm	Internal	824.70	1013			-
05		Internal	836.52	0384	0.28	0.28	0.32
06		Internal	848.97	0777			-
07	Ni-MH Rechargeable Battery Top of DUT perpendicular to the phantom with spacing of 10 mm	Internal	824.70	1013			-
08		Internal	836.52	0384	0.00	0.00	0.05
09		Internal	848.97	0777			-

* If the SAR measured at the middle channel for each test configuration is at least 3.0 dB lower than the SAR limit, testing at the high and low channels is optional for such test configuration(s).

ULTRATECH GROUP OF LABS

3000 Bristol Circle, Oakville, Ontario, Canada L6H 6G4
 Tel. #: 905-829-1570, Fax. #: 905-829-8050, Email: vic@ultratech-labs.com, Website: http://www.ultratech-labs.com

File #: MIS-053-SAR
March 27, 2006

- Assessed by ITI (UK) Competent Body, NVLAP (USA) Accreditation Body & ACA/AUSTEL (Australia), VCCI (Japan)
- Accredited by Industry Canada (Canada) under ACC-LAB (Europe/Canada MRA and APEC/Canada MRA)
- Recognized/Listed by FCC (USA)
- All test results contained in this engineering test report are traceable to National Institute of Standards and Technology (NIST)

SPECIFIC ABSORPTION RATE (SAR)

IEEE C95.1-1991, FCC OET Bulletin 65 (Supplement C), Industry Canada RSS-102(Issue 2) and ACA Radiocommunications (Electromagnetic Radiation – Human Exposure) Amendment Standard 2000 (No. 1)

NBS55XX M/N: NBS55XXTXXX

FCC ID: O3JNBS55XXT

7.1.1.1. Right Side of D.U.T. in parallel to the phantom with spacing of 10 mm, 824.70 MHz; #01

Test date [MM/DD/YYYY]	03/16/2006
Test by	Carolyn Luu
Room temperature [°C]	21
Room humidity [%]	40
Simulated tissue temperature [°C]	21
Separation distance, d [mm]	10
Test frequency [MHz]	824.70
E-field Probe	M/N: ET20, S/N:03JUN-0028, Sensor Offset: 2.0 mm
Sensor Factor (η_{Pd}) [mV/(mW/cm ²)]	10.8
Amplifier Settings (AS ₁ , AS ₂ , AS ₃)	0.0070744200, 0.0065975307, 0.0065990632
Tissue Type	Muscle
Measured conductivity [S/m]	0.98 (+1.0 %)
Measured dielectric constant	56.2 (+1.8 %)
Conversion Factor (γ)	5.246
Sensitivity (ζ) [W/Kg/mV]	6.521E-02
Source-(or Usage-)Based Time-Average Factor	1.0
Measurement Area Specification (X × Y)	105 mm × 75 mm; Resolution: 15 mm × 15 mm
Measurement Volume Specification (X × Y × Z)	7 pts × 5 pts × 5 pts, 30 mm × 28 mm × 28 mm; Resolution: 5 mm × 7 mm × 7 mm
SAR _{1g} [W/Kg]	0.63

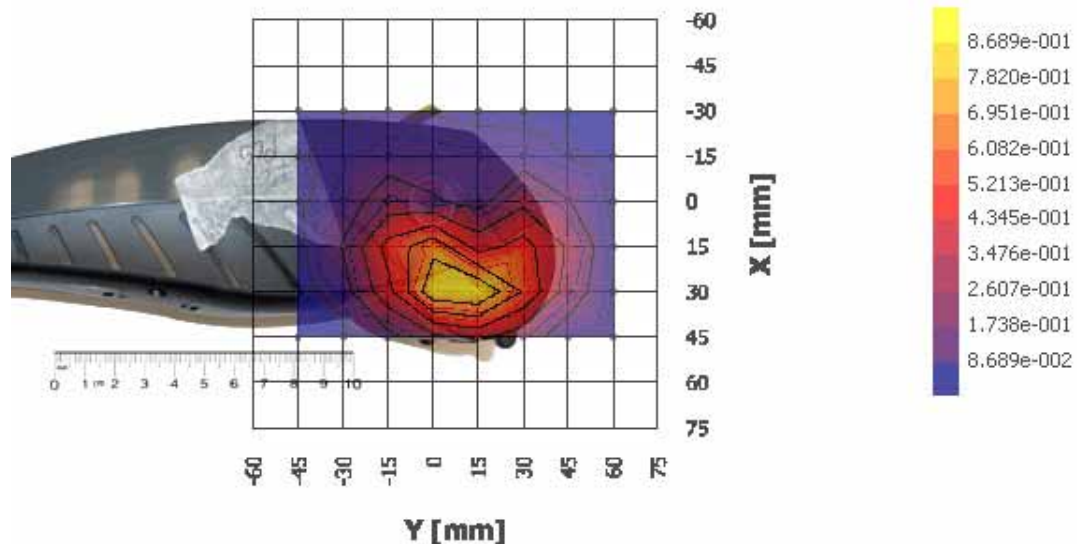
**ULTRATECH GROUP OF LABS**

3000 Bristol Circle, Oakville, Ontario, Canada L6H 6G4

Tel. #: 905-829-1570, Fax. #: 905-829-8050, Email: vic@ultratech-labs.com, Website: http://www.ultratech-labs.com

File #: MIS-053-SAR

March 27, 2006

- Assessed by ITI (UK) Competent Body, NVLAP (USA) Accreditation Body & ACA/AUSTEL (Australia), VCCI (Japan)
- Accredited by Industry Canada (Canada) under ACC-LAB (Europe/Canada MRA and APEC/Canada MRA)
- Recognized/Listed by FCC (USA)
- All test results contained in this engineering test report are traceable to National Institute of Standards and Technology (NIST)

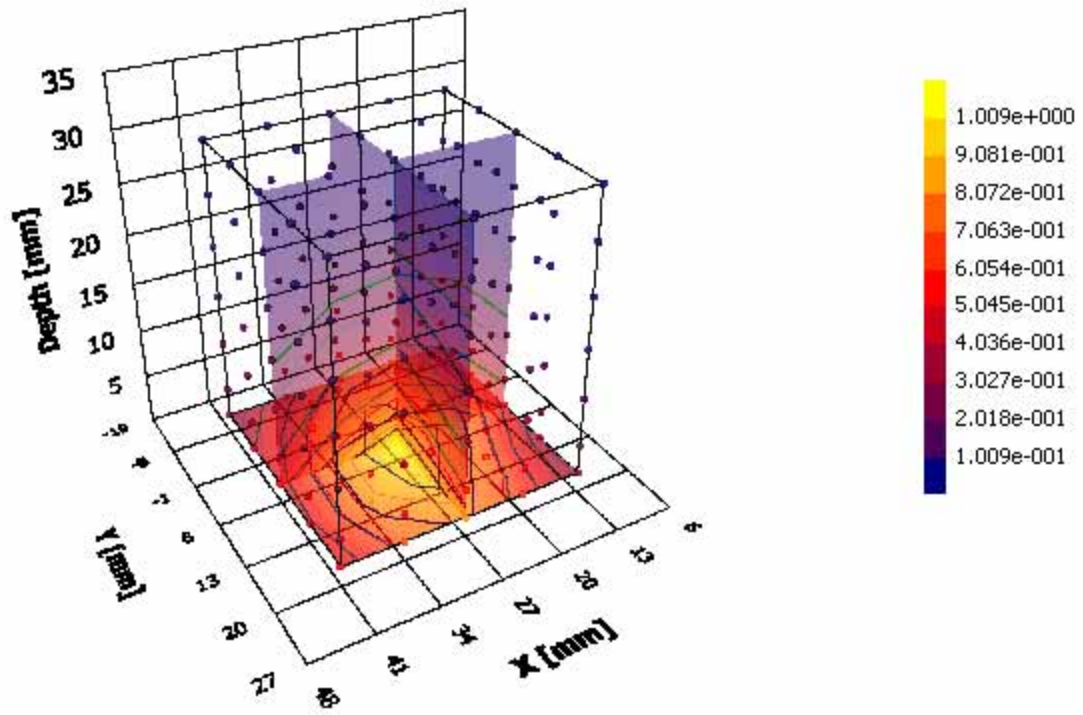

ULTRATECH GROUP OF LABS

3000 Bristol Circle, Oakville, Ontario, Canada L6H 6G4
Tel. #: 905-829-1570, Fax. #: 905-829-8050, Email: vic@ultratech-labs.com, Website: http://www.ultratech-labs.com

File #: MIS-053-SAR
March 27, 2006

- Assessed by ITI (UK) Competent Body, NVLAP (USA) Accreditation Body & ACA/AUSTEL (Australia), VCCI (Japan)
- Accredited by Industry Canada (Canada) under ACC-LAB (Europe/Canada MRA and APEC/Canada MRA)
- Recognized/Listed by FCC (USA)
- All test results contained in this engineering test report are traceable to National Institute of Standards and Technology (NIST)

SPECIFIC ABSORPTION RATE (SAR)

IEEE C95.1-1991, FCC OET Bulletin 65 (Supplement C), Industry Canada RSS-102(Issue 2) and ACA Radiocommunications (Electromagnetic Radiation – Human Exposure) Amendment Standard 2000 (No. 1)

NBS55XX M/N: NBS55XXTXXX

FCC ID: O3JNBS55XXT

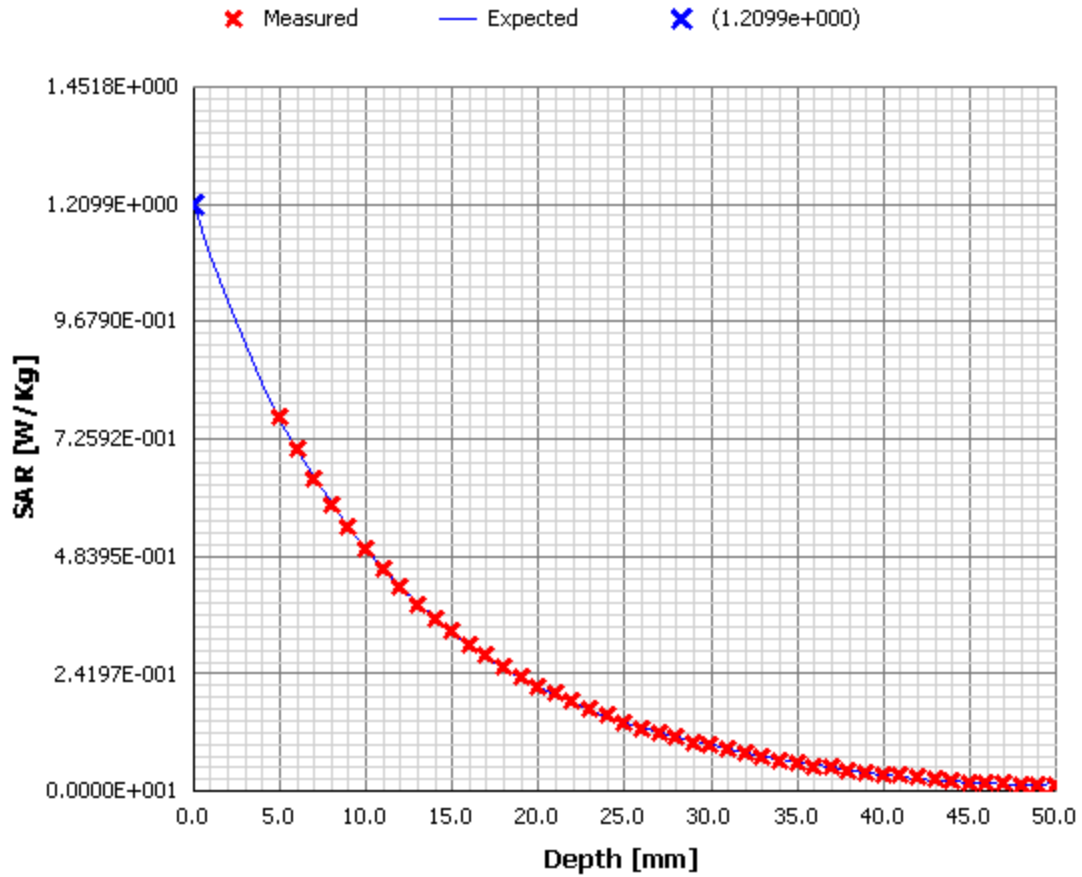

ULTRATECH GROUP OF LABS

3000 Bristol Circle, Oakville, Ontario, Canada L6H 6G4
Tel. #: 905-829-1570, Fax. #: 905-829-8050, Email: vic@ultratech-labs.com, Website: http://www.ultratech-labs.com

File #: MIS-053-SAR
March 27, 2006

- Assessed by ITI (UK) Competent Body, NVLAP (USA) Accreditation Body & ACA/AUSTEL (Australia), VCCI (Japan)
- Accredited by Industry Canada (Canada) under ACC-LAB (Europe/Canada MRA and APEC/Canada MRA)
- Recognized/Listed by FCC (USA)
- All test results contained in this engineering test report are traceable to National Institute of Standards and Technology (NIST)

SPECIFIC ABSORPTION RATE (SAR)

IEEE C95.1-1991, FCC OET Bulletin 65 (Supplement C), Industry Canada RSS-102(Issue 2) and ACA Radiocommunications (Electromagnetic Radiation – Human Exposure) Amendment Standard 2000 (No. 1)

NBS55XX M/N: NBS55XXTXXX

FCC ID: O3JNBS55XXT

7.1.1.2. Right Side of D.U.T. in parallel to the phantom with spacing of 10 mm, 836.52 MHz; #02

Test date [MM/DD/YYYY]	03/16/2006
Test by	Carolyn Luu
Room temperature [°C]	21
Room humidity [%]	40
Simulated tissue temperature [°C]	21
Separation distance, d [mm]	10
Test frequency [MHz]	836.52
E-field Probe	M/N: ET20, S/N:03JUN-0028, Sensor Offset: 2.0 mm
Sensor Factor (η_{Pd}) [mV/(mW/cm ²)]	10.8
Amplifier Settings (AS ₁ , AS ₂ , AS ₃)	0.0070744200, 0.0065975307, 0.0065990632
Tissue Type	Muscle
Measured conductivity [S/m]	0.98 (+1.0 %)
Measured dielectric constant	56.2 (+1.8 %)
Conversion Factor (γ)	5.246
Sensitivity (ζ) [W/Kg/mV]	6.521E-02
Source-(or Usage-)Based Time-Average Factor	1.0
Measurement Area Specification (X × Y)	105 mm × 90 mm; Resolution: 15 mm × 15 mm
Measurement Volume Specification (X × Y × Z)	7 pts × 5 pts × 5 pts, 30 mm × 28 mm × 28 mm; Resolution: 5 mm × 7 mm × 7 mm
SAR _{1g} [W/Kg]	0.80

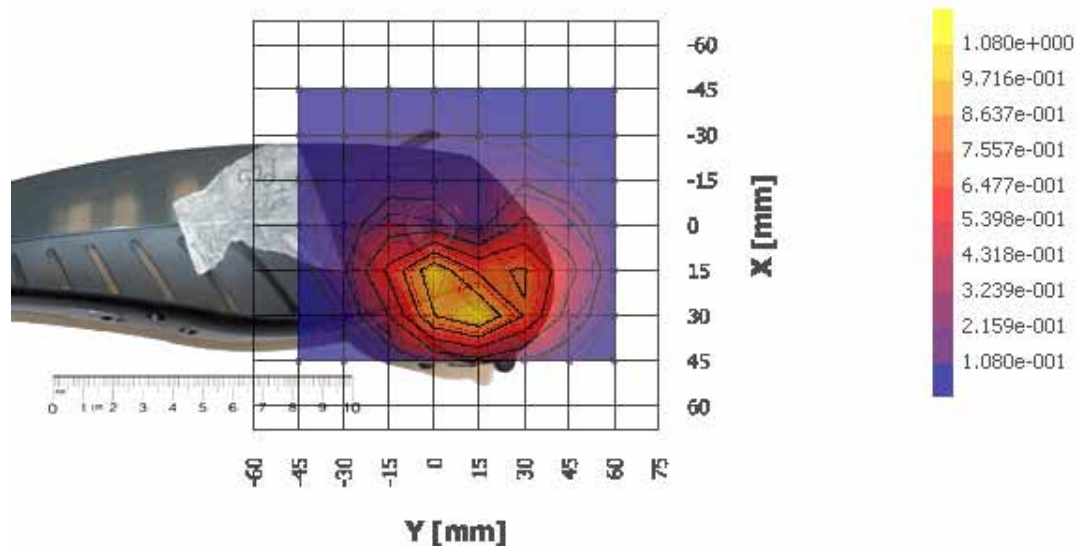
**ULTRATECH GROUP OF LABS**

3000 Bristol Circle, Oakville, Ontario, Canada L6H 6G4

Tel. #: 905-829-1570, Fax. #: 905-829-8050, Email: vic@ultratech-labs.com, Website: http://www.ultratech-labs.com

File #: MIS-053-SAR

March 27, 2006

- Assessed by ITI (UK) Competent Body, NVLAP (USA) Accreditation Body & ACA/AUSTEL (Australia), VCCI (Japan)
- Accredited by Industry Canada (Canada) under ACC-LAB (Europe/Canada MRA and APEC/Canada MRA)
- Recognized/Listed by FCC (USA)
- All test results contained in this engineering test report are traceable to National Institute of Standards and Technology (NIST)

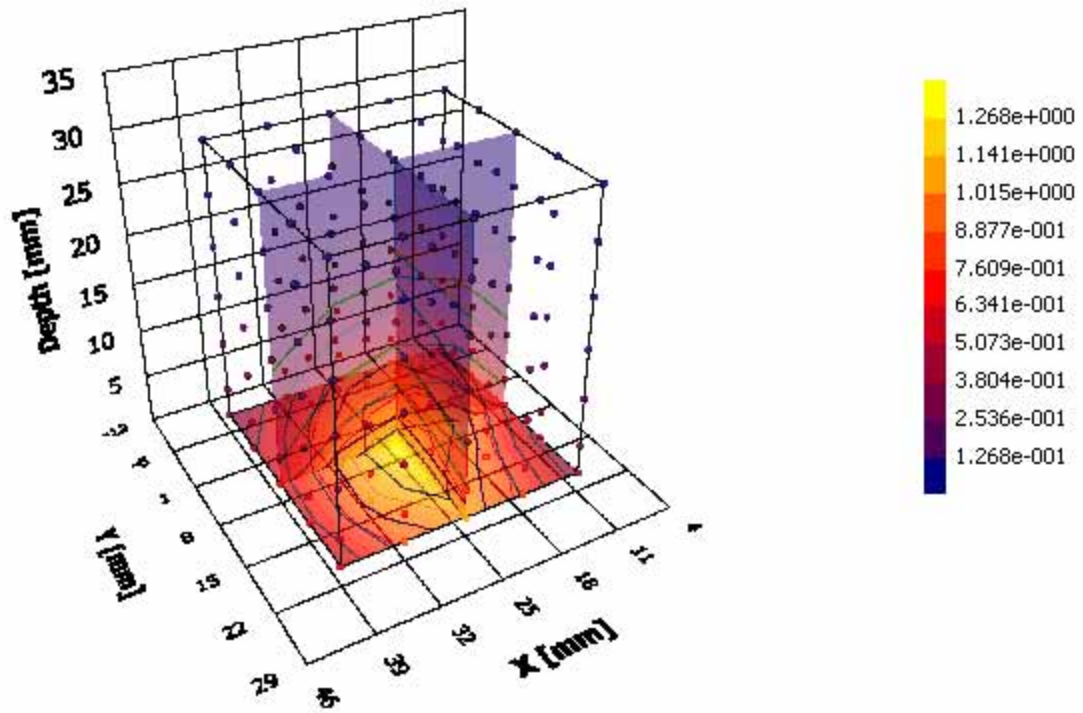

ULTRATECH GROUP OF LABS

3000 Bristol Circle, Oakville, Ontario, Canada L6H 6G4
Tel. #: 905-829-1570, Fax. #: 905-829-8050, Email: vic@ultratech-labs.com, Website: http://www.ultratech-labs.com

File #: MIS-053-SAR
March 27, 2006

- Assessed by ITI (UK) Competent Body, NVLAP (USA) Accreditation Body & ACA/AUSTEL (Australia), VCCI (Japan)
- Accredited by Industry Canada (Canada) under ACC-LAB (Europe/Canada MRA and APEC/Canada MRA)
- Recognized/Listed by FCC (USA)
- All test results contained in this engineering test report are traceable to National Institute of Standards and Technology (NIST)

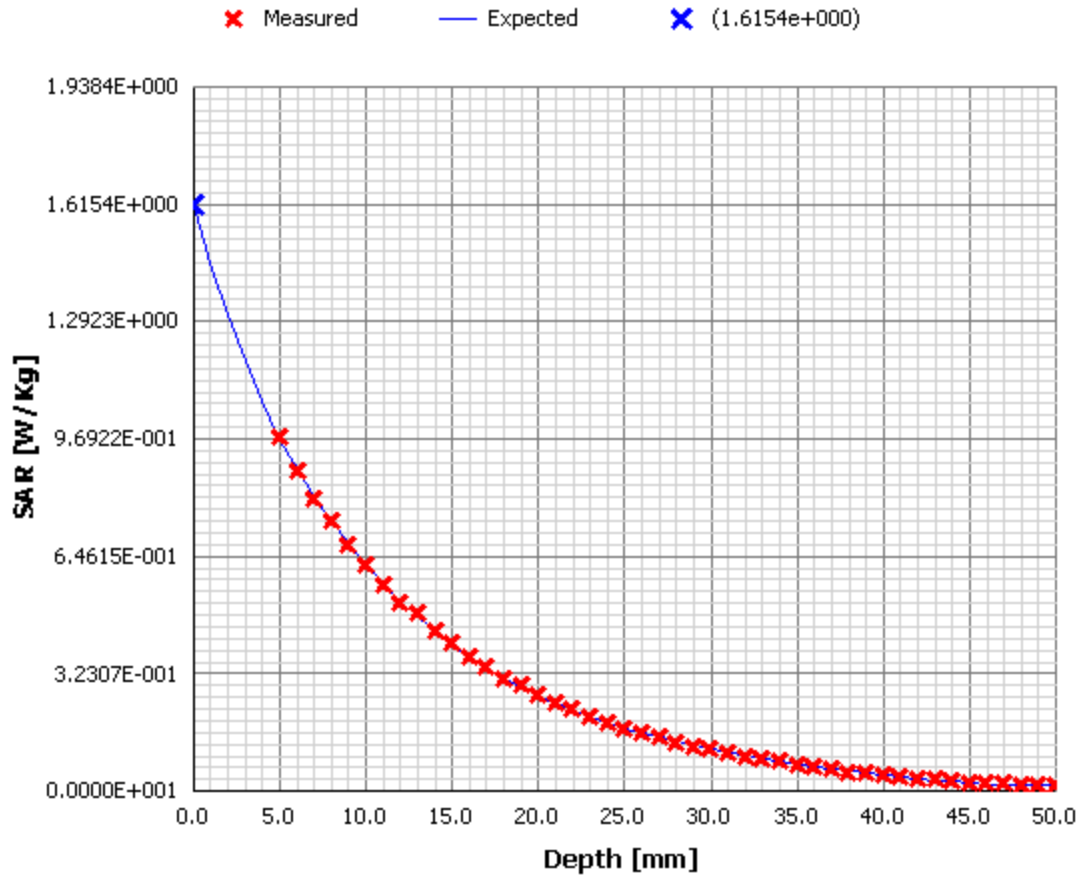

ULTRATECH GROUP OF LABS

3000 Bristol Circle, Oakville, Ontario, Canada L6H 6G4
Tel. #: 905-829-1570, Fax. #: 905-829-8050, Email: vic@ultratech-labs.com, Website: http://www.ultratech-labs.com

File #: MIS-053-SAR
March 27, 2006

- Assessed by ITI (UK) Competent Body, NVLAP (USA) Accreditation Body & ACA/AUSTEL (Australia), VCCI (Japan)
- Accredited by Industry Canada (Canada) under ACC-LAB (Europe/Canada MRA and APEC/Canada MRA)
- Recognized/Listed by FCC (USA)
- All test results contained in this engineering test report are traceable to National Institute of Standards and Technology (NIST)

SPECIFIC ABSORPTION RATE (SAR)

IEEE C95.1-1991, FCC OET Bulletin 65 (Supplement C), Industry Canada RSS-102(Issue 2) and ACA Radiocommunications (Electromagnetic Radiation – Human Exposure) Amendment Standard 2000 (No. 1)

NBS55XX M/N: NBS55XXTXXX

FCC ID: O3JNBS55XXT

7.1.1.3. Right Side of D.U.T. in parallel to the phantom with spacing of 10 mm, 848.97 MHz; #03

Test date [MM/DD/YYYY]	03/16/2006
Test by	Carolyn Luu
Room temperature [°C]	21
Room humidity [%]	40
Simulated tissue temperature [°C]	21
Separation distance, d [mm]	10
Test frequency [MHz]	848.97
E-field Probe	M/N: ET20, S/N:03JUN-0028, Sensor Offset: 2.0 mm
Sensor Factor (η_{Pd}) [mV/(mW/cm ²)]	10.8
Amplifier Settings (AS ₁ , AS ₂ , AS ₃)	0.0070744200, 0.0065975307, 0.0065990632
Tissue Type	Muscle
Measured conductivity [S/m]	0.98 (+1.0 %)
Measured dielectric constant	56.2 (+1.8 %)
Conversion Factor (γ)	5.246
Sensitivity (ζ) [W/Kg/mV]	6.521E-02
Source-(or Usage-)Based Time-Average Factor	1.0
Measurement Area Specification (X × Y)	90 mm × 75 mm; Resolution: 15 mm × 15 mm
Measurement Volume Specification (X × Y × Z)	7 pts × 5 pts × 5 pts, 30 mm × 28 mm × 28 mm; Resolution: 5 mm × 7 mm × 7 mm
SAR _{1g} [W/Kg]	0.55

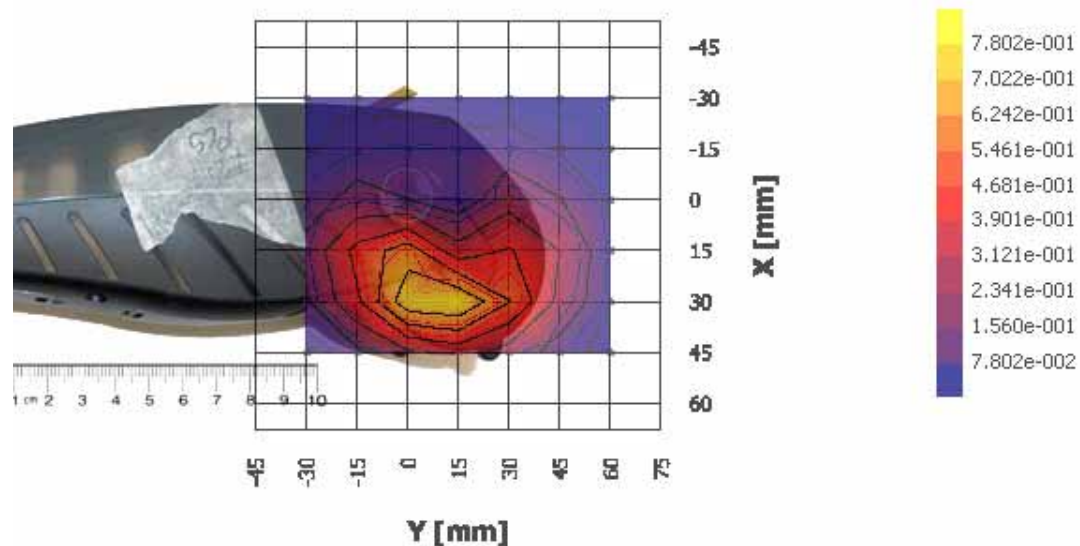
**ULTRATECH GROUP OF LABS**

3000 Bristol Circle, Oakville, Ontario, Canada L6H 6G4

Tel. #: 905-829-1570, Fax. #: 905-829-8050, Email: vic@ultratech-labs.com, Website: http://www.ultratech-labs.com

File #: MIS-053-SAR

March 27, 2006

- Assessed by ITI (UK) Competent Body, NVLAP (USA) Accreditation Body & ACA/AUSTEL (Australia), VCCI (Japan)
- Accredited by Industry Canada (Canada) under ACC-LAB (Europe/Canada MRA and APEC/Canada MRA)
- Recognized/Listed by FCC (USA)
- All test results contained in this engineering test report are traceable to National Institute of Standards and Technology (NIST)

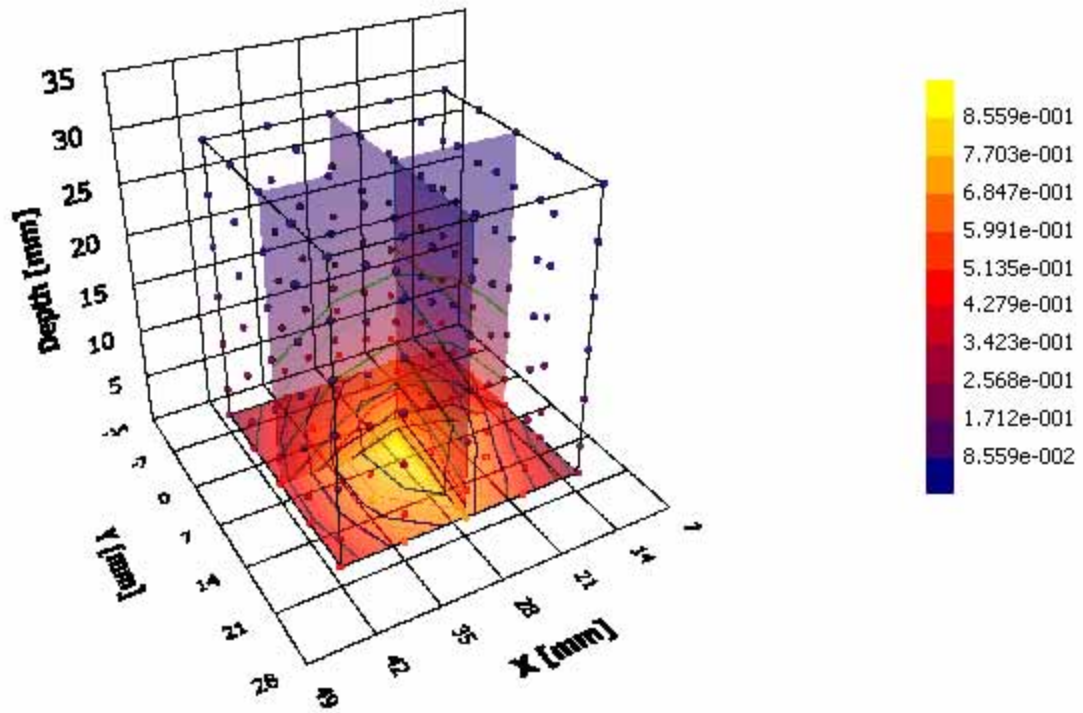

ULTRATECH GROUP OF LABS

3000 Bristol Circle, Oakville, Ontario, Canada L6H 6G4
Tel. #: 905-829-1570, Fax. #: 905-829-8050, Email: vic@ultratech-labs.com, Website: http://www.ultratech-labs.com

File #: MIS-053-SAR
March 27, 2006

- Assessed by ITI (UK) Competent Body, NVLAP (USA) Accreditation Body & ACA/AUSTEL (Australia), VCCI (Japan)
- Accredited by Industry Canada (Canada) under ACC-LAB (Europe/Canada MRA and APEC/Canada MRA)
- Recognized/Listed by FCC (USA)
- All test results contained in this engineering test report are traceable to National Institute of Standards and Technology (NIST)

SPECIFIC ABSORPTION RATE (SAR)

IEEE C95.1-1991, FCC OET Bulletin 65 (Supplement C), Industry Canada RSS-102(Issue 2) and ACA Radiocommunications (Electromagnetic Radiation – Human Exposure) Amendment Standard 2000 (No. 1)

NBS55XX M/N: NBS55XXTXXX

FCC ID: O3JNBS55XXT

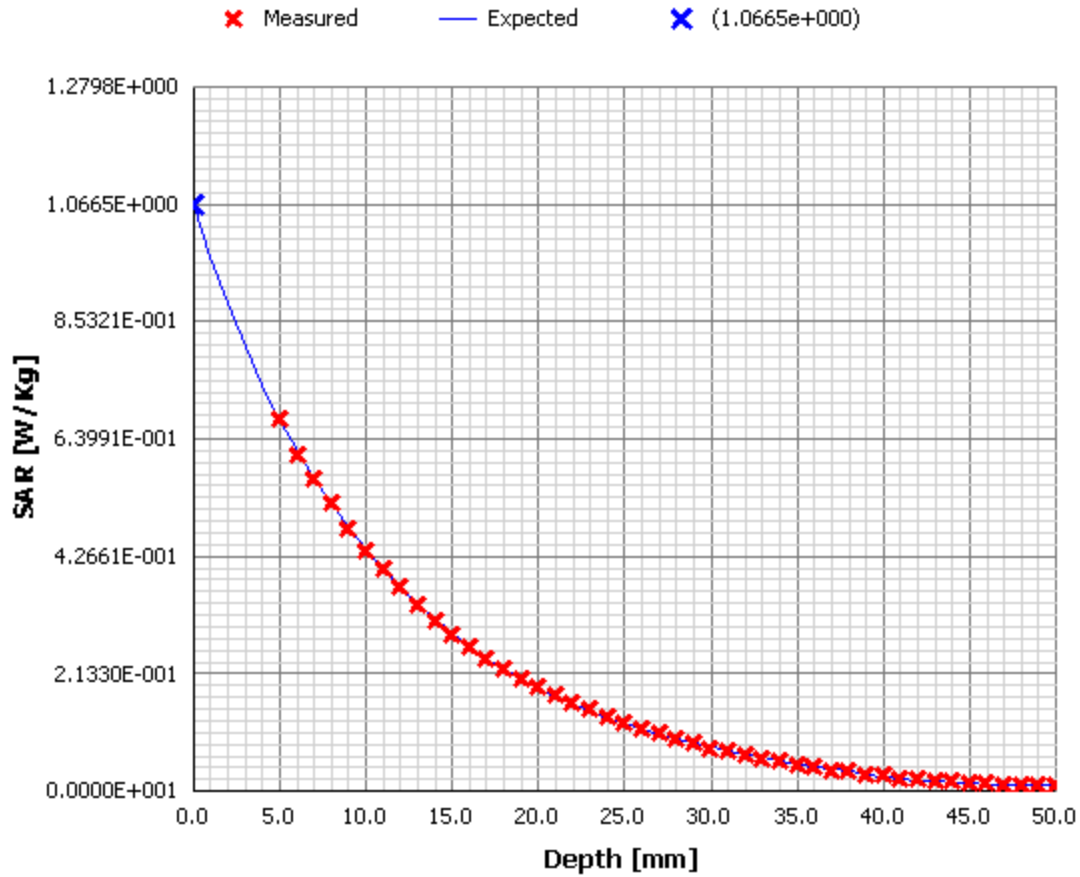

ULTRATECH GROUP OF LABS

3000 Bristol Circle, Oakville, Ontario, Canada L6H 6G4
Tel. #: 905-829-1570, Fax. #: 905-829-8050, Email: vic@ultratech-labs.com, Website: http://www.ultratech-labs.com

File #: MIS-053-SAR
March 27, 2006

- Assessed by ITI (UK) Competent Body, NVLAP (USA) Accreditation Body & ACA/AUSTEL (Australia), VCCI (Japan)
- Accredited by Industry Canada (Canada) under ACC-LAB (Europe/Canada MRA and APEC/Canada MRA)
- Recognized/Listed by FCC (USA)
- All test results contained in this engineering test report are traceable to National Institute of Standards and Technology (NIST)

SPECIFIC ABSORPTION RATE (SAR)

IEEE C95.1-1991, FCC OET Bulletin 65 (Supplement C), Industry Canada RSS-102(Issue 2) and ACA Radiocommunications (Electromagnetic Radiation – Human Exposure) Amendment Standard 2000 (No. 1)

NBS55XX M/N: NBS55XXTXXX

FCC ID: O3JNBS55XXT

7.1.1.4. Back Side of D.U.T. in parallel to the phantom with spacing of 10 mm, 836.52 MHz; #05

Test date [MM/DD/YYYY]	03/16/2006
Test by	Carolyn Luu
Room temperature [°C]	21
Room humidity [%]	40
Simulated tissue temperature [°C]	21
Separation distance, d [mm]	10
Test frequency [MHz]	836.52
E-field Probe	M/N: ET20, S/N:03JUN-0028, Sensor Offset: 2.0 mm
Sensor Factor (η_{Pd}) [mV/(mW/cm ²)]	10.8
Amplifier Settings (AS ₁ , AS ₂ , AS ₃)	0.0070744200, 0.0065975307, 0.0065990632
Tissue Type	Muscle
Measured conductivity [S/m]	0.98 (+1.0 %)
Measured dielectric constant	56.2 (+1.8 %)
Conversion Factor (γ)	5.246
Sensitivity (ζ) [W/Kg/mV]	6.521E-02
Source-(or Usage-)Based Time-Average Factor	1.0
Measurement Area Specification (X × Y)	90 mm × 90 mm; Resolution: 15 mm × 15 mm
Measurement Volume Specification (X × Y × Z)	7 pts × 5 pts × 5 pts, 30 mm × 28 mm × 28 mm; Resolution: 5 mm × 7 mm × 7 mm
SAR _{1g} [W/Kg]	0.32

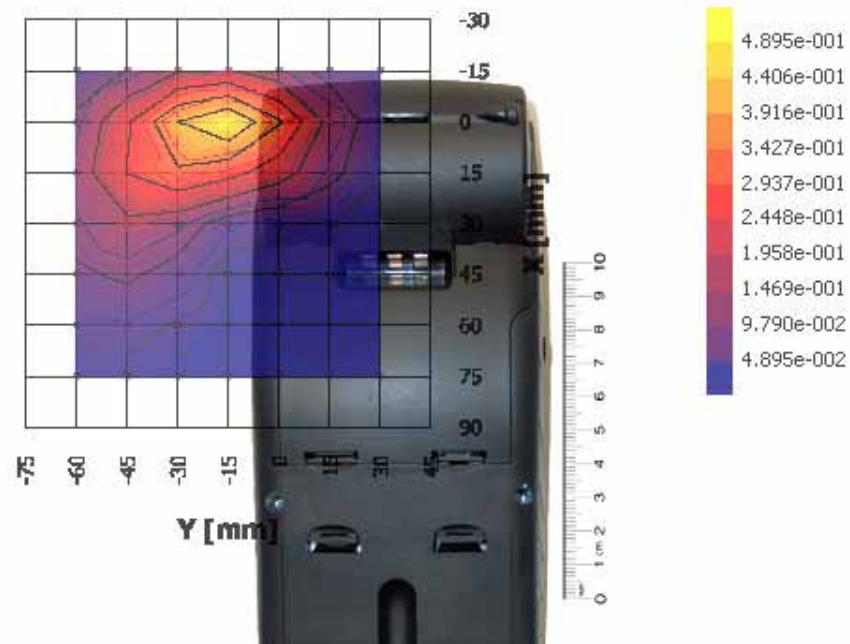
**ULTRATECH GROUP OF LABS**

3000 Bristol Circle, Oakville, Ontario, Canada L6H 6G4

Tel. #: 905-829-1570, Fax. #: 905-829-8050, Email: vic@ultratech-labs.com, Website: http://www.ultratech-labs.com

File #: MIS-053-SAR

March 27, 2006

- Assessed by ITI (UK) Competent Body, NVLAP (USA) Accreditation Body & ACA/AUSTEL (Australia), VCCI (Japan)
- Accredited by Industry Canada (Canada) under ACC-LAB (Europe/Canada MRA and APEC/Canada MRA)
- Recognized/Listed by FCC (USA)
- All test results contained in this engineering test report are traceable to National Institute of Standards and Technology (NIST)

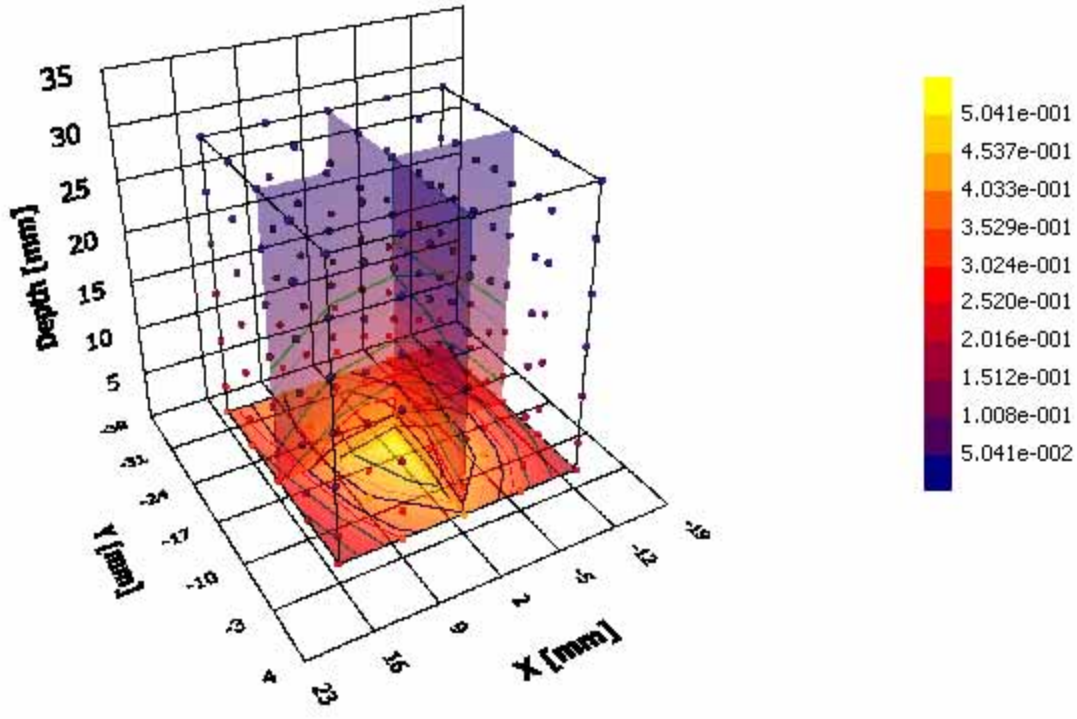

ULTRATECH GROUP OF LABS

3000 Bristol Circle, Oakville, Ontario, Canada L6H 6G4
Tel. #: 905-829-1570, Fax. #: 905-829-8050, Email: vic@ultratech-labs.com, Website: http://www.ultratech-labs.com

File #: MIS-053-SAR
March 27, 2006

- Assessed by ITI (UK) Competent Body, NVLAP (USA) Accreditation Body & ACA/AUSTEL (Australia), VCCI (Japan)
- Accredited by Industry Canada (Canada) under ACC-LAB (Europe/Canada MRA and APEC/Canada MRA)
- Recognized/Listed by FCC (USA)
- All test results contained in this engineering test report are traceable to National Institute of Standards and Technology (NIST)

SPECIFIC ABSORPTION RATE (SAR)

IEEE C95.1-1991, FCC OET Bulletin 65 (Supplement C), Industry Canada RSS-102(Issue 2) and ACA Radiocommunications (Electromagnetic Radiation – Human Exposure) Amendment Standard 2000 (No. 1)

NBS55XX M/N: NBS55XXTXXX

FCC ID: O3JNBS55XXT

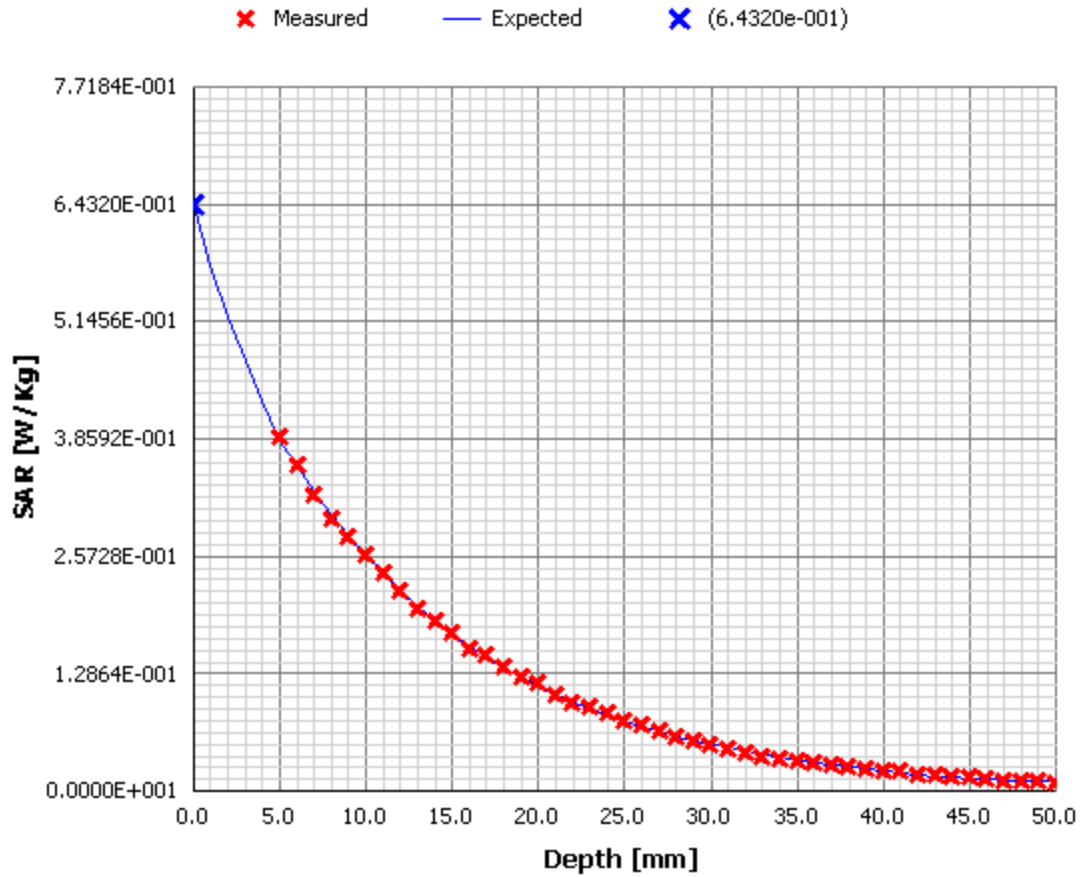

ULTRATECH GROUP OF LABS

3000 Bristol Circle, Oakville, Ontario, Canada L6H 6G4
Tel. #: 905-829-1570, Fax. #: 905-829-8050, Email: vic@ultratech-labs.com, Website: http://www.ultratech-labs.com

File #: MIS-053-SAR
March 27, 2006

- Assessed by ITI (UK) Competent Body, NVLAP (USA) Accreditation Body & ACA/AUSTEL (Australia), VCCI (Japan)
- Accredited by Industry Canada (Canada) under ACC-LAB (Europe/Canada MRA and APEC/Canada MRA)
- Recognized/Listed by FCC (USA)
- All test results contained in this engineering test report are traceable to National Institute of Standards and Technology (NIST)

SPECIFIC ABSORPTION RATE (SAR)

IEEE C95.1-1991, FCC OET Bulletin 65 (Supplement C), Industry Canada RSS-102(Issue 2) and ACA Radiocommunications (Electromagnetic Radiation – Human Exposure) Amendment Standard 2000 (No. 1)

NBS55XX M/N: NBS55XXTXXX

FCC ID: O3JNBS55XXT

7.1.1.5. Top of D.U.T. perpendicular to the phantom with spacing of 10 mm, 836.52 MHz; #08

Test date [MM/DD/YYYY]	03/16/2006
Test by	Carolyn Luu
Room temperature [°C]	21
Room humidity [%]	40
Simulated tissue temperature [°C]	21
Separation distance, d [mm]	10
Test frequency [MHz]	836.52
E-field Probe	M/N: ET20, S/N:03JUN-0028, Sensor Offset: 2.0 mm
Sensor Factor (η_{Pd}) [mV/(mW/cm ²)]	10.8
Amplifier Settings (AS ₁ , AS ₂ , AS ₃)	0.0070744200, 0.0065975307, 0.0065990632
Tissue Type	Muscle
Measured conductivity [S/m]	0.98 (+1.0 %)
Measured dielectric constant	56.2 (+1.8 %)
Conversion Factor (γ)	5.246
Sensitivity (ζ) [W/Kg/mV]	6.521E-02
Source-(or Usage-)Based Time-Average Factor	1.0
Measurement Area Specification (X × Y)	90 mm × 105 mm; Resolution: 15 mm × 15 mm
Measurement Volume Specification (X × Y × Z)	7 pts × 5 pts × 5 pts, 30 mm × 28 mm × 28 mm; Resolution: 5 mm × 7 mm × 7 mm
SAR _{1g} [W/Kg]	0.05

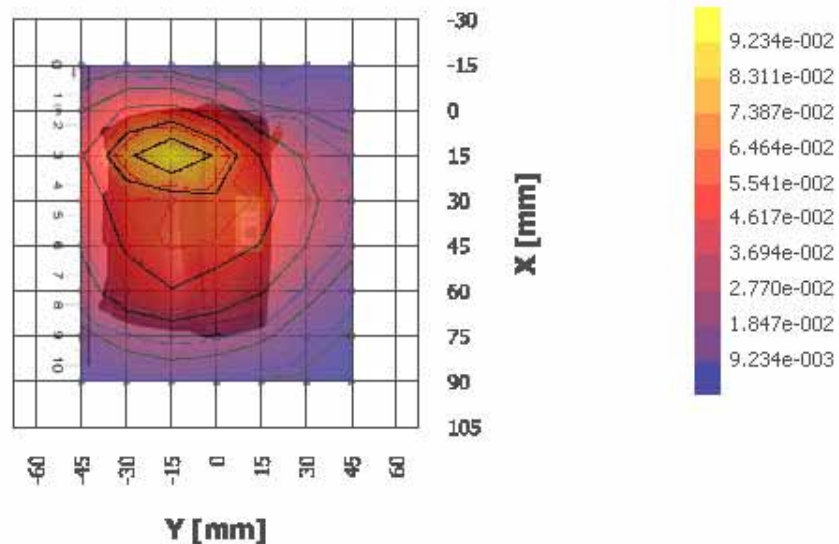
**ULTRATECH GROUP OF LABS**

3000 Bristol Circle, Oakville, Ontario, Canada L6H 6G4

Tel. #: 905-829-1570, Fax. #: 905-829-8050, Email: vic@ultratech-labs.com, Website: http://www.ultratech-labs.com

File #: MIS-053-SAR

March 27, 2006

- Assessed by ITI (UK) Competent Body, NVLAP (USA) Accreditation Body & ACA/AUSTEL (Australia), VCCI (Japan)
- Accredited by Industry Canada (Canada) under ACC-LAB (Europe/Canada MRA and APEC/Canada MRA)
- Recognized/Listed by FCC (USA)
- All test results contained in this engineering test report are traceable to National Institute of Standards and Technology (NIST)

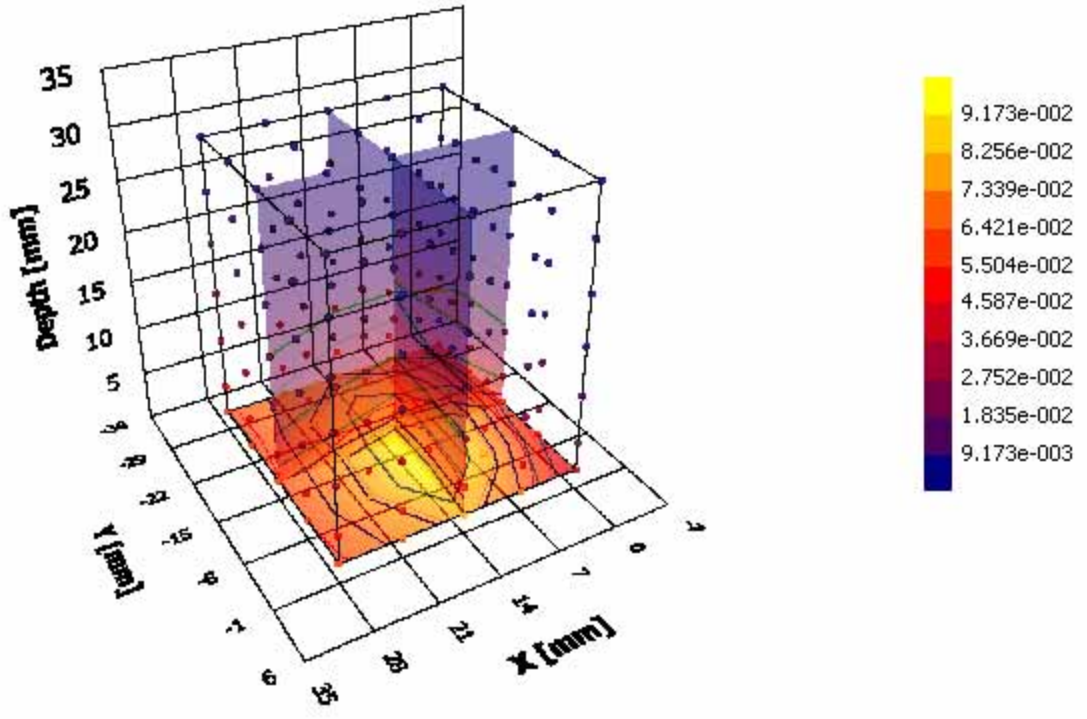

ULTRATECH GROUP OF LABS

3000 Bristol Circle, Oakville, Ontario, Canada L6H 6G4
Tel. #: 905-829-1570, Fax. #: 905-829-8050, Email: vic@ultratech-labs.com, Website: http://www.ultratech-labs.com

File #: MIS-053-SAR
March 27, 2006

- Assessed by ITI (UK) Competent Body, NVLAP (USA) Accreditation Body & ACA/AUSTEL (Australia), VCCI (Japan)
- Accredited by Industry Canada (Canada) under ACC-LAB (Europe/Canada MRA and APEC/Canada MRA)
- Recognized/Listed by FCC (USA)
- All test results contained in this engineering test report are traceable to National Institute of Standards and Technology (NIST)

SPECIFIC ABSORPTION RATE (SAR)

IEEE C95.1-1991, FCC OET Bulletin 65 (Supplement C), Industry Canada RSS-102(Issue 2) and ACA Radiocommunications (Electromagnetic Radiation – Human Exposure) Amendment Standard 2000 (No. 1)

NBS55XX M/N: NBS55XXTXXX

FCC ID: O3JNBS55XXT

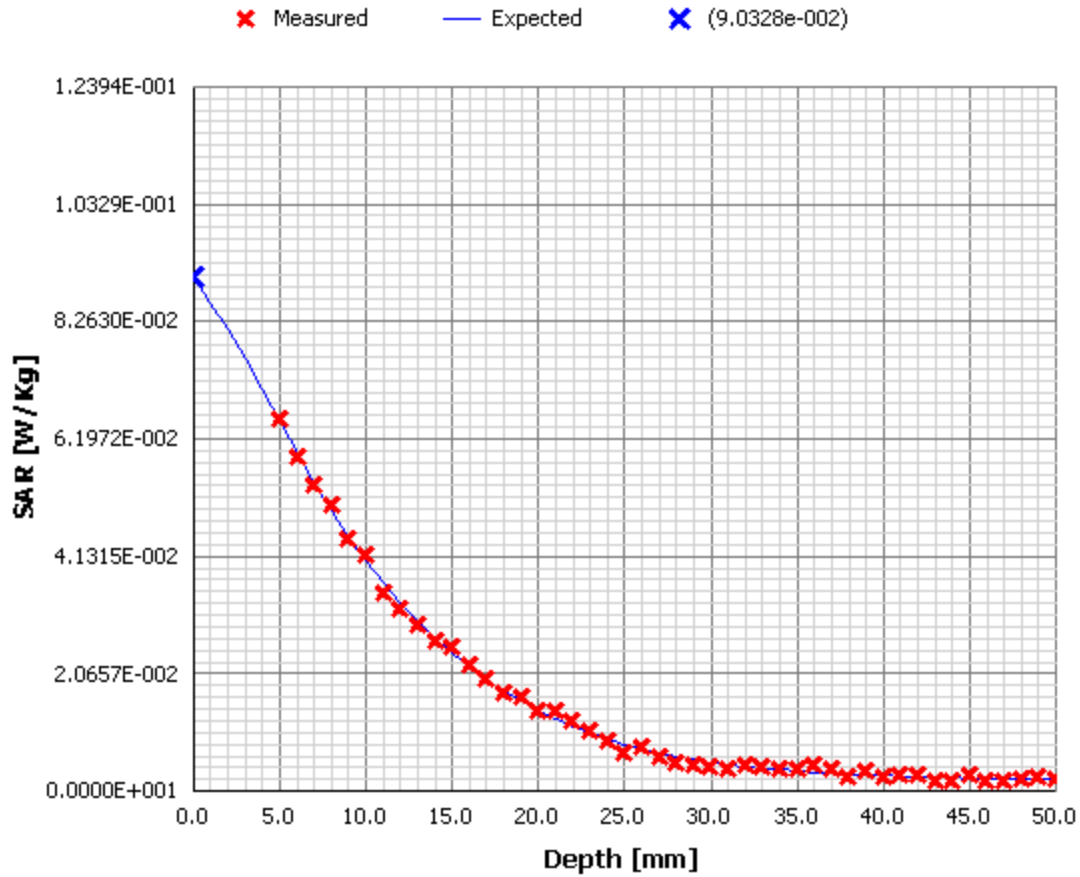

ULTRATECH GROUP OF LABS

3000 Bristol Circle, Oakville, Ontario, Canada L6H 6G4
Tel. #: 905-829-1570, Fax. #: 905-829-8050, Email: vic@ultratech-labs.com, Website: http://www.ultratech-labs.com

File #: MIS-053-SAR
March 27, 2006

- Assessed by ITI (UK) Competent Body, NVLAP (USA) Accreditation Body & ACA/AUSTEL (Australia), VCCI (Japan)
- Accredited by Industry Canada (Canada) under ACC-LAB (Europe/Canada MRA and APEC/Canada MRA)
- Recognized/Listed by FCC (USA)
- All test results contained in this engineering test report are traceable to National Institute of Standards and Technology (NIST)

SPECIFIC ABSORPTION RATE (SAR)

IEEE C95.1-1991, FCC OET Bulletin 65 (Supplement C), Industry Canada RSS-102(Issue 2) and ACA Radiocommunications (Electromagnetic Radiation – Human Exposure) Amendment Standard 2000 (No. 1)

NBS55XX M/N: NBS55XXTXXX

FCC ID: O3JNBS55XXT

7.1.2. PCS CDMA*

#	Configuration	Antenna Position	Frequency [MHz]	Channel	SAR _{local} Before [W/Kg]	SAR _{local} After [W/Kg]	MAX SAR _{1g} [W/Kg]
*	General Population/Uncontrolled Exposure Category Limit						1.6
10	Ni-MH Rechargeable Battery Right side of DUT in parallel to the phantom with spacing of 10 mm	Internal	1851.25	0025			
11		Internal	1880.00	0600	0.57	0.57	0.60
12		Internal	1908.75	1175			
13	Ni-MH Rechargeable Battery Back side of DUT in parallel to the phantom with spacing of 10 mm	Internal	1851.25	0025			-
14		Internal	1880.00	0600	0.11	0.11	0.17
15		Internal	1908.75	1175			-
16	Ni-MH Rechargeable Battery Top of DUT perpendicular to the phantom with spacing of 10 mm	Internal	1851.25	0025			-
17		Internal	1880.00	0600	0.39	0.38	0.22
18		Internal	1908.75	1175			-

* If the SAR measured at the middle channel for each test configuration is at least 3.0 dB lower than the SAR limit, testing at the high and low channels is optional for such test configuration(s).

ULTRATECH GROUP OF LABS

3000 Bristol Circle, Oakville, Ontario, Canada L6H 6G4
 Tel. #: 905-829-1570, Fax. #: 905-829-8050, Email: vic@ultratech-labs.com, Website: http://www.ultratech-labs.com

File #: MIS-053-SAR
 March 27, 2006

- Assessed by ITI (UK) Competent Body, NVLAP (USA) Accreditation Body & ACA/AUSTEL (Australia), VCCI (Japan)
- Accredited by Industry Canada (Canada) under ACC-LAB (Europe/Canada MRA and APEC/Canada MRA)
- Recognized/Listed by FCC (USA)
- All test results contained in this engineering test report are traceable to National Institute of Standards and Technology (NIST)

SPECIFIC ABSORPTION RATE (SAR)

IEEE C95.1-1991, FCC OET Bulletin 65 (Supplement C), Industry Canada RSS-102(Issue 2) and ACA Radiocommunications (Electromagnetic Radiation – Human Exposure) Amendment Standard 2000 (No. 1)

NBS55XX M/N: NBS55XXTXXX

FCC ID: O3JNBS55XXT

7.1.2.1. Right Side of D.U.T. in parallel to the phantom with spacing of 10 mm, 1880.0 MHz; #11

Test date [MM/DD/YYYY]	03/20/2006
Test by	Carolyn Luu
Room temperature [°C]	21
Room humidity [%]	40
Simulated tissue temperature [°C]	21
Separation distance, d [mm]	10
Test frequency [MHz]	1880.00
E-field Probe	M/N: ET20, S/N:03JUN-0028, Sensor Offset: 2.0 mm
Sensor Factor (η_{Pd}) [mV/(mW/cm ²)]	10.8
Amplifier Settings (AS ₁ , AS ₂ , AS ₃)	0.0062748828, 0.0066157645, 0.0060267983
Tissue Type	Muscle
Measured conductivity [S/m]	1.61 (+5.0 %)
Measured dielectric constant	51.7 (-3.0 %)
Conversion Factor (γ)	4.066
Sensitivity (ζ) [W/Kg/mV]	1.382E-01
Source-(or Usage-)Based Time-Average Factor	1.0
Measurement Area Specification (X × Y)	105 mm × 75 mm; Resolution: 15 mm × 15 mm
Measurement Volume Specification (X × Y × Z)	7 pts × 7 pts × 7 pts, 30 mm × 30 mm × 30 mm; Resolution: 5 mm × 5 mm × 5 mm
SAR _{1g} [W/Kg]	0.60

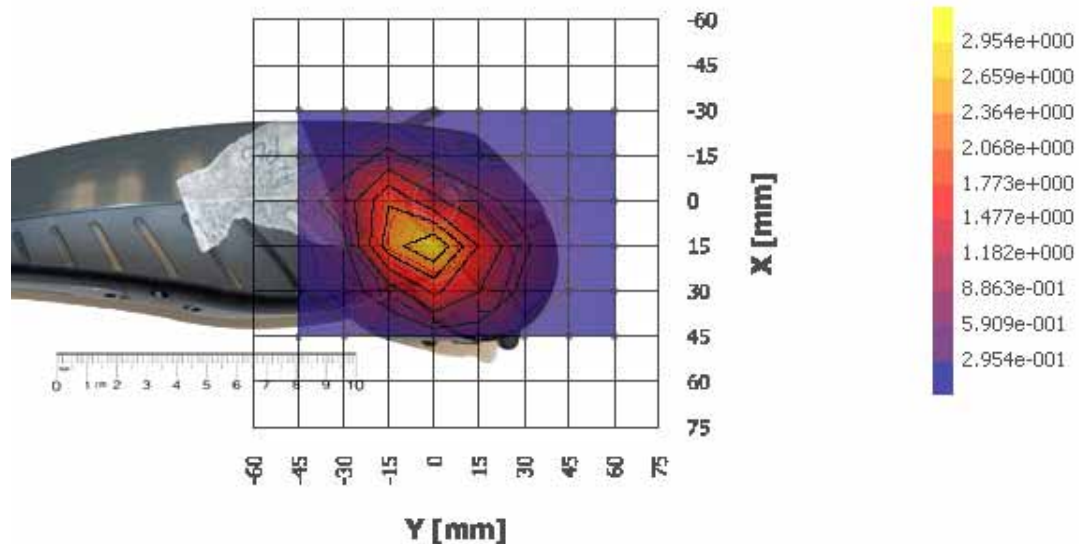
**ULTRATECH GROUP OF LABS**

3000 Bristol Circle, Oakville, Ontario, Canada L6H 6G4

Tel. #: 905-829-1570, Fax. #: 905-829-8050, Email: vic@ultratech-labs.com, Website: http://www.ultratech-labs.com

File #: MIS-053-SAR

March 27, 2006

- Assessed by ITI (UK) Competent Body, NVLAP (USA) Accreditation Body & ACA/AUSTEL (Australia), VCCI (Japan)
- Accredited by Industry Canada (Canada) under ACC-LAB (Europe/Canada MRA and APEC/Canada MRA)
- Recognized/Listed by FCC (USA)
- All test results contained in this engineering test report are traceable to National Institute of Standards and Technology (NIST)

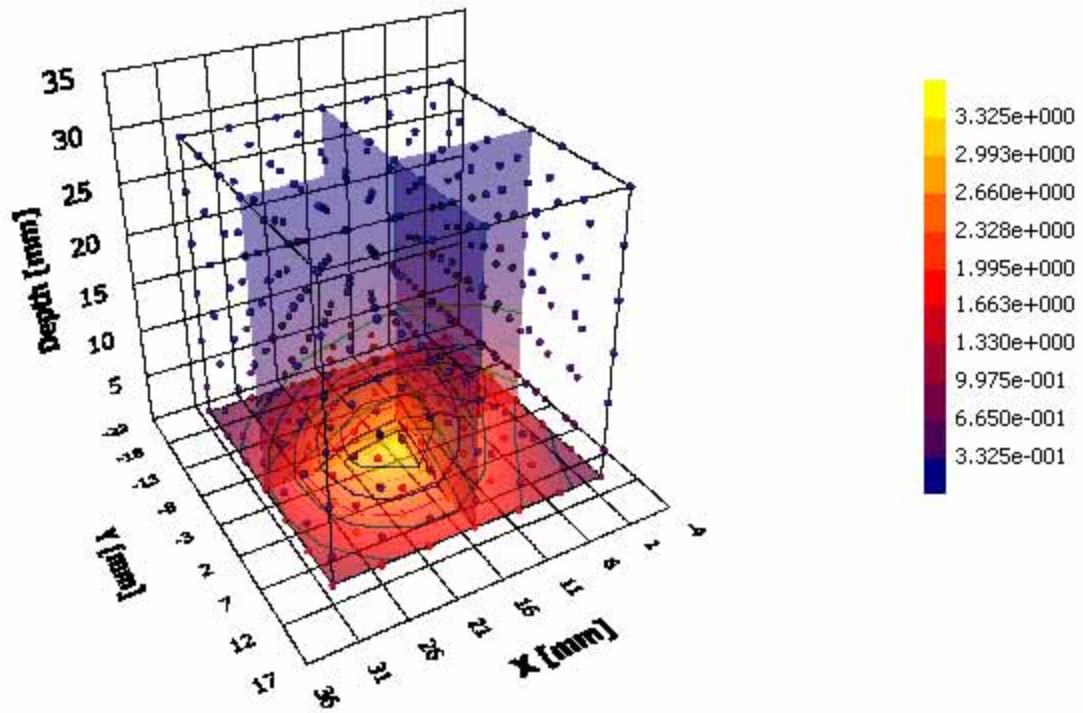

ULTRATECH GROUP OF LABS

3000 Bristol Circle, Oakville, Ontario, Canada L6H 6G4
Tel. #: 905-829-1570, Fax. #: 905-829-8050, Email: vic@ultratech-labs.com, Website: http://www.ultratech-labs.com

File #: MIS-053-SAR
March 27, 2006

- Assessed by ITI (UK) Competent Body, NVLAP (USA) Accreditation Body & ACA/AUSTEL (Australia), VCCI (Japan)
- Accredited by Industry Canada (Canada) under ACC-LAB (Europe/Canada MRA and APEC/Canada MRA)
- Recognized/Listed by FCC (USA)
- All test results contained in this engineering test report are traceable to National Institute of Standards and Technology (NIST)

SPECIFIC ABSORPTION RATE (SAR)

IEEE C95.1-1991, FCC OET Bulletin 65 (Supplement C), Industry Canada RSS-102(Issue 2) and ACA Radiocommunications (Electromagnetic Radiation – Human Exposure) Amendment Standard 2000 (No. 1)

NBS55XX M/N: NBS55XXTXXX

FCC ID: O3JNBS55XXT

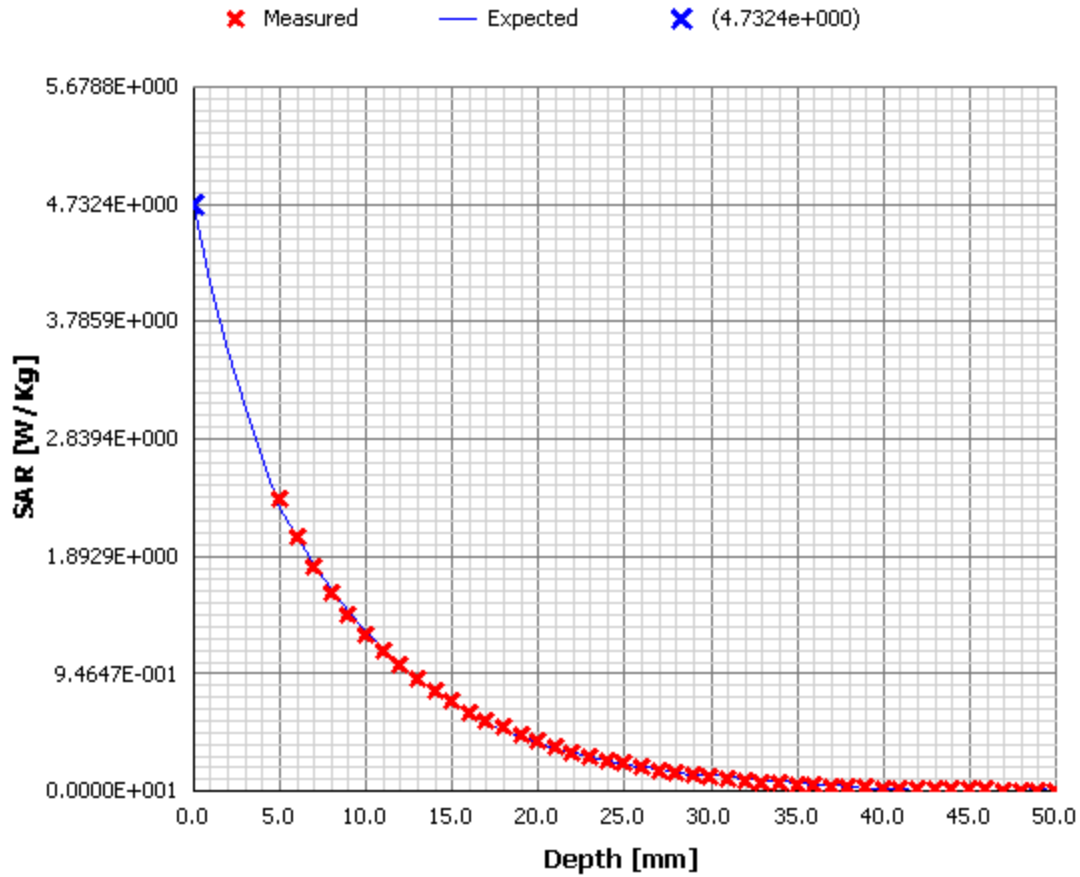

ULTRATECH GROUP OF LABS

3000 Bristol Circle, Oakville, Ontario, Canada L6H 6G4
Tel. #: 905-829-1570, Fax. #: 905-829-8050, Email: vic@ultratech-labs.com, Website: http://www.ultratech-labs.com

File #: MIS-053-SAR
March 27, 2006

- Assessed by ITI (UK) Competent Body, NVLAP (USA) Accreditation Body & ACA/AUSTEL (Australia), VCCI (Japan)
- Accredited by Industry Canada (Canada) under ACC-LAB (Europe/Canada MRA and APEC/Canada MRA)
- Recognized/Listed by FCC (USA)
- All test results contained in this engineering test report are traceable to National Institute of Standards and Technology (NIST)

SPECIFIC ABSORPTION RATE (SAR)

IEEE C95.1-1991, FCC OET Bulletin 65 (Supplement C), Industry Canada RSS-102(Issue 2) and ACA Radiocommunications (Electromagnetic Radiation – Human Exposure) Amendment Standard 2000 (No. 1)

NBS55XX M/N: NBS55XXTXXX

FCC ID: O3JNBS55XXT

7.1.2.2. Back Side of D.U.T. in parallel to the phantom with spacing of 10 mm, 1880.00 MHz; #14

Test date [MM/DD/YYYY]	03/20/2006
Test by	Carolyn Luu
Room temperature [°C]	21
Room humidity [%]	40
Simulated tissue temperature [°C]	21
Separation distance, d [mm]	10
Test frequency [MHz]	1880.00
E-field Probe	M/N: ET20, S/N:03JUN-0028, Sensor Offset: 2.0 mm
Sensor Factor (η_{Pd}) [mV/(mW/cm ²)]	10.8
Amplifier Settings (AS ₁ , AS ₂ , AS ₃)	0.0062748828, 0.0066157645, 0.0060267983
Tissue Type	Muscle
Measured conductivity [S/m]	1.61 (+5.0 %)
Measured dielectric constant	51.7 (-3.0 %)
Conversion Factor (γ)	4.066
Sensitivity (ζ) [W/Kg/mV]	1.382E-01
Source-(or Usage-)Based Time-Average Factor	1.0
Measurement Area Specification (X × Y)	105 mm × 90 mm; Resolution: 15 mm × 15 mm
Measurement Volume Specification (X × Y × Z)	7 pts × 7 pts × 7 pts, 30 mm × 30 mm × 30 mm; Resolution: 5 mm × 5 mm × 5 mm
SAR _{1g} [W/Kg]	0.17

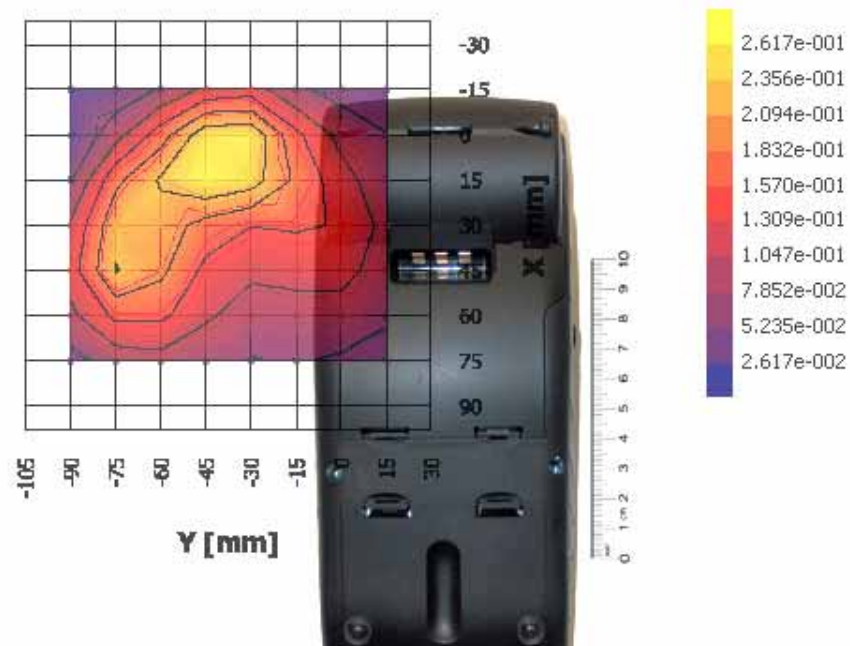
**ULTRATECH GROUP OF LABS**

3000 Bristol Circle, Oakville, Ontario, Canada L6H 6G4

Tel. #: 905-829-1570, Fax. #: 905-829-8050, Email: vic@ultratech-labs.com, Website: http://www.ultratech-labs.com

File #: MIS-053-SAR

March 27, 2006

- Assessed by ITI (UK) Competent Body, NVLAP (USA) Accreditation Body & ACA/AUSTEL (Australia), VCCI (Japan)
- Accredited by Industry Canada (Canada) under ACC-LAB (Europe/Canada MRA and APEC/Canada MRA)
- Recognized/Listed by FCC (USA)
- All test results contained in this engineering test report are traceable to National Institute of Standards and Technology (NIST)

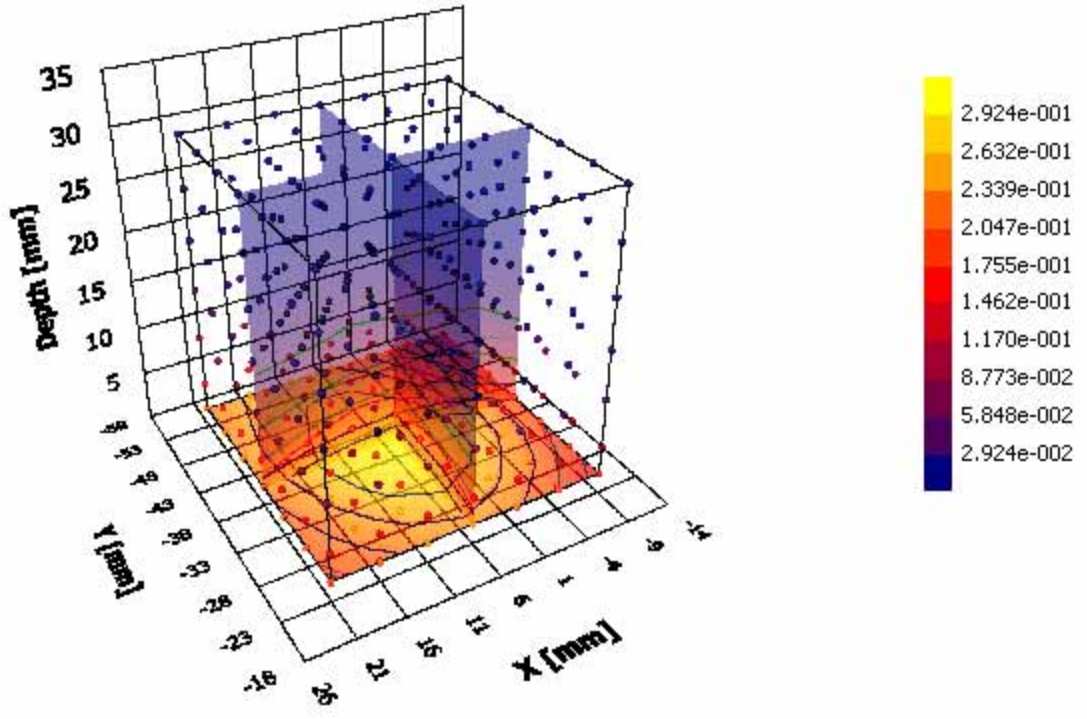

ULTRATECH GROUP OF LABS

3000 Bristol Circle, Oakville, Ontario, Canada L6H 6G4
Tel. #: 905-829-1570, Fax. #: 905-829-8050, Email: vic@ultratech-labs.com, Website: http://www.ultratech-labs.com

File #: MIS-053-SAR
March 27, 2006

- Assessed by ITI (UK) Competent Body, NVLAP (USA) Accreditation Body & ACA/AUSTEL (Australia), VCCI (Japan)
- Accredited by Industry Canada (Canada) under ACC-LAB (Europe/Canada MRA and APEC/Canada MRA)
- Recognized/Listed by FCC (USA)
- All test results contained in this engineering test report are traceable to National Institute of Standards and Technology (NIST)

SPECIFIC ABSORPTION RATE (SAR)

IEEE C95.1-1991, FCC OET Bulletin 65 (Supplement C), Industry Canada RSS-102(Issue 2) and ACA Radiocommunications (Electromagnetic Radiation – Human Exposure) Amendment Standard 2000 (No. 1)

NBS55XX M/N: NBS55XXTXXX

FCC ID: O3JNBS55XXT

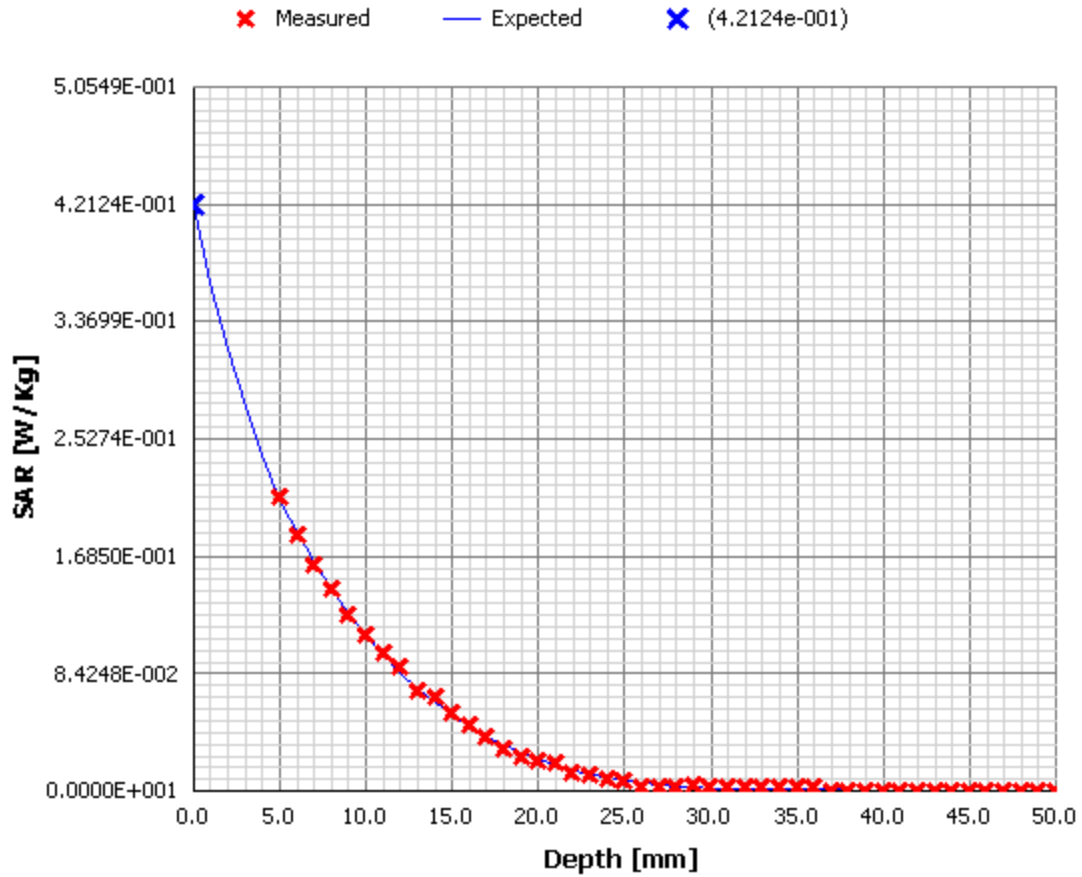

ULTRATECH GROUP OF LABS

3000 Bristol Circle, Oakville, Ontario, Canada L6H 6G4
Tel. #: 905-829-1570, Fax. #: 905-829-8050, Email: vic@ultratech-labs.com, Website: http://www.ultratech-labs.com

File #: MIS-053-SAR
March 27, 2006

- Assessed by ITI (UK) Competent Body, NVLAP (USA) Accreditation Body & ACA/AUSTEL (Australia), VCCI (Japan)
- Accredited by Industry Canada (Canada) under ACC-LAB (Europe/Canada MRA and APEC/Canada MRA)
- Recognized/Listed by FCC (USA)
- All test results contained in this engineering test report are traceable to National Institute of Standards and Technology (NIST)

SPECIFIC ABSORPTION RATE (SAR)

IEEE C95.1-1991, FCC OET Bulletin 65 (Supplement C), Industry Canada RSS-102(Issue 2) and ACA Radiocommunications (Electromagnetic Radiation – Human Exposure) Amendment Standard 2000 (No. 1)

NBS55XX M/N: NBS55XXTXXX

FCC ID: O3JNBS55XXT

7.1.2.3. Top of D.U.T. perpendicular to the phantom with spacing of 10 mm, 1880.00 MHz; #17

Test date [MM/DD/YYYY]	03/20/2006
Test by	Carolyn Luu
Room temperature [°C]	21
Room humidity [%]	40
Simulated tissue temperature [°C]	21
Separation distance, d [mm]	10
Test frequency [MHz]	1880.00
E-field Probe	M/N: ET20, S/N:03JUN-0028, Sensor Offset: 2.0 mm
Sensor Factor (η_{Pd}) [mV/(mW/cm ²)]	10.8
Amplifier Settings (AS ₁ , AS ₂ , AS ₃)	0.0062748828, 0.0066157645, 0.0060267983
Tissue Type	Muscle
Measured conductivity [S/m]	1.61 (+5.0 %)
Measured dielectric constant	51.7 (-3.0 %)
Conversion Factor (γ)	4.066
Sensitivity (ζ) [W/Kg/mV]	1.382E-01
Source-(or Usage-)Based Time-Average Factor	1.0
Measurement Area Specification (X × Y)	75 mm × 105 mm; Resolution: 15 mm × 15 mm
Measurement Volume Specification (X × Y × Z)	7 pts × 7 pts × 7 pts, 30 mm × 30 mm × 30 mm; Resolution: 5 mm × 5 mm × 5 mm
SAR _{1g} [W/Kg]	0.22

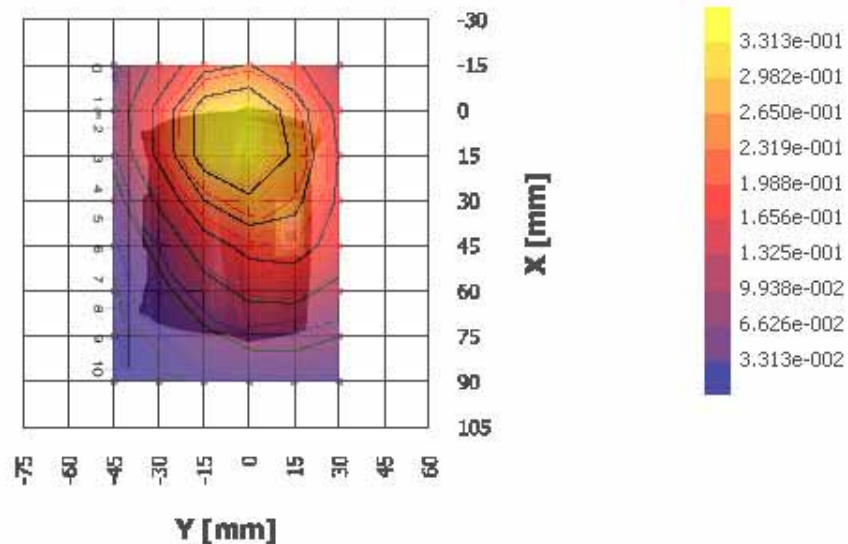
**ULTRATECH GROUP OF LABS**

3000 Bristol Circle, Oakville, Ontario, Canada L6H 6G4

Tel. #: 905-829-1570, Fax. #: 905-829-8050, Email: vic@ultratech-labs.com, Website: http://www.ultratech-labs.com

File #: MIS-053-SAR

March 27, 2006

- Assessed by ITI (UK) Competent Body, NVLAP (USA) Accreditation Body & ACA/AUSTEL (Australia), VCCI (Japan)
- Accredited by Industry Canada (Canada) under ACC-LAB (Europe/Canada MRA and APEC/Canada MRA)
- Recognized/Listed by FCC (USA)
- All test results contained in this engineering test report are traceable to National Institute of Standards and Technology (NIST)

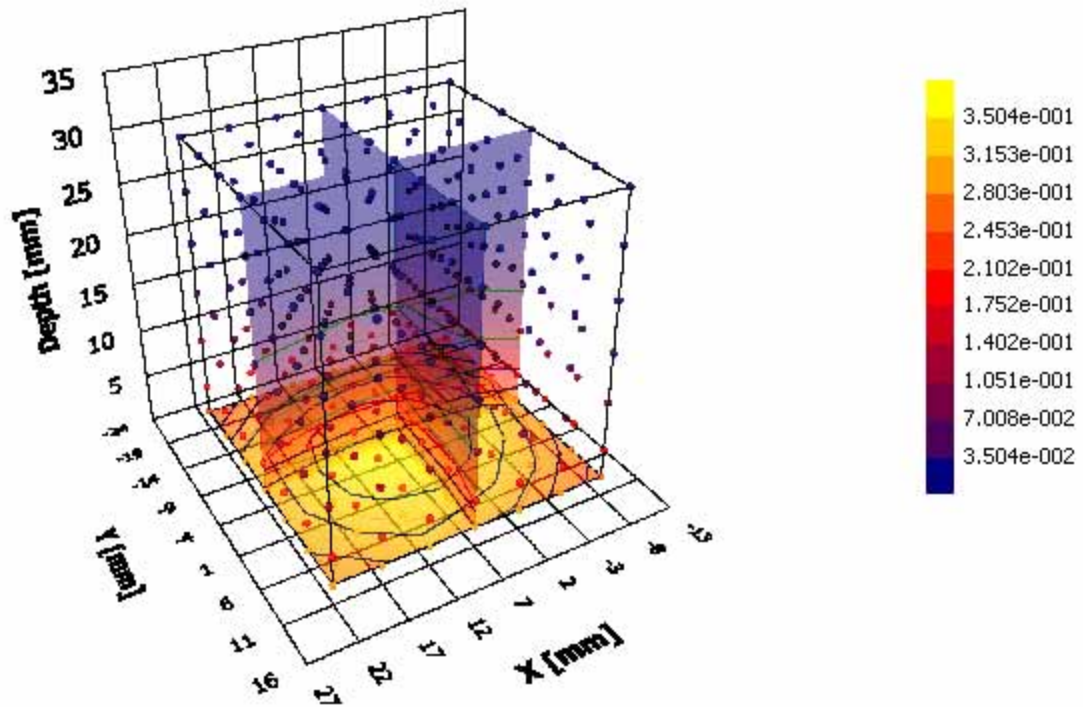

ULTRATECH GROUP OF LABS

3000 Bristol Circle, Oakville, Ontario, Canada L6H 6G4
Tel. #: 905-829-1570, Fax. #: 905-829-8050, Email: vic@ultratech-labs.com, Website: http://www.ultratech-labs.com

File #: MIS-053-SAR
March 27, 2006

- Assessed by ITI (UK) Competent Body, NVLAP (USA) Accreditation Body & ACA/AUSTEL (Australia), VCCI (Japan)
- Accredited by Industry Canada (Canada) under ACC-LAB (Europe/Canada MRA and APEC/Canada MRA)
- Recognized/Listed by FCC (USA)
- All test results contained in this engineering test report are traceable to National Institute of Standards and Technology (NIST)

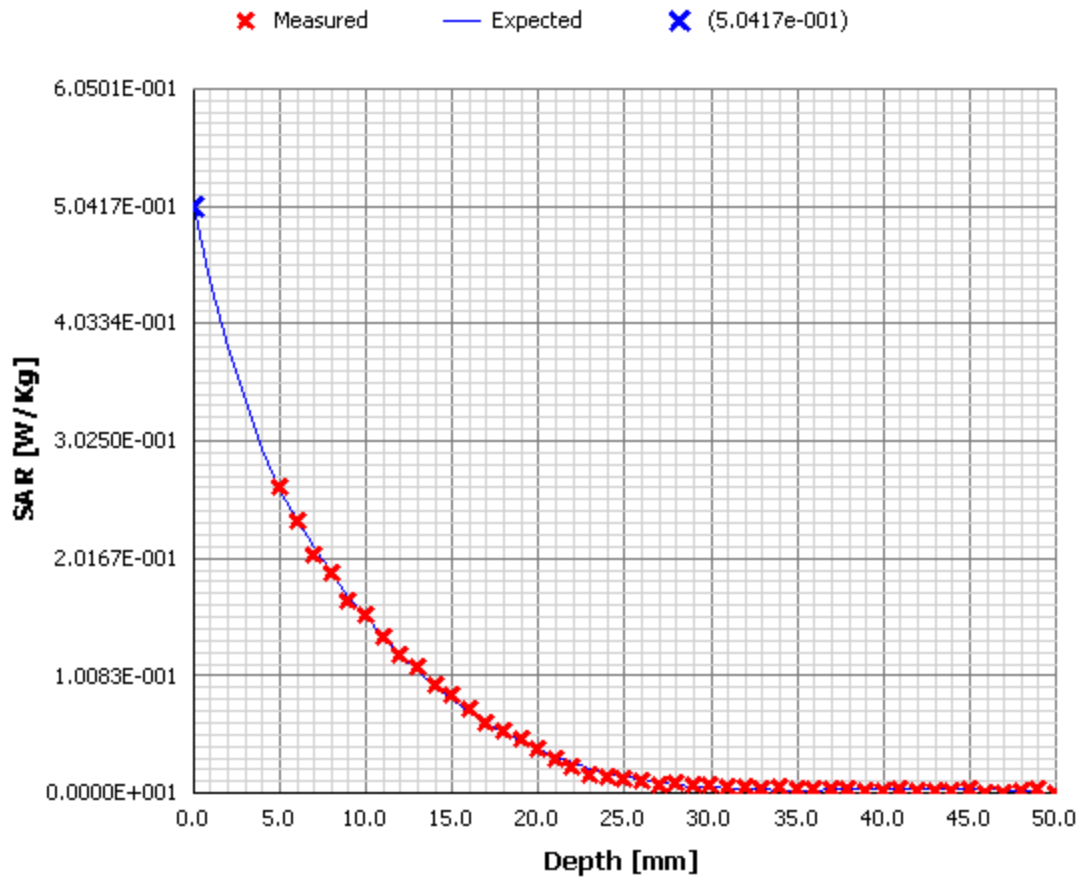

ULTRATECH GROUP OF LABS

3000 Bristol Circle, Oakville, Ontario, Canada L6H 6G4
Tel. #: 905-829-1570, Fax. #: 905-829-8050, Email: vic@ultratech-labs.com, Website: http://www.ultratech-labs.com

File #: MIS-053-SAR
March 27, 2006

- Assessed by ITI (UK) Competent Body, NVLAP (USA) Accreditation Body & ACA/AUSTEL (Australia), VCCI (Japan)
- Accredited by Industry Canada (Canada) under ACC-LAB (Europe/Canada MRA and APEC/Canada MRA)
- Recognized/Listed by FCC (USA)
- All test results contained in this engineering test report are traceable to National Institute of Standards and Technology (NIST)

EXHIBIT 8. TISSUE DIELECTRIC PARAMETER CALIBRATION

8.1. SIMULATED TISSUE AT 835 MHZ

Tissue calibration type	HP Dielectric Strength Probe System (M/N: 85070C)	
Tissue calibration date [MM/DD/YYYY]	03/16/2006	03/16/2006
Tissue calibrated by	Carolyn Luu	Carolyn Luu
Room temperature [°C]	21	21
Room humidity [%]	40	40
Simulated tissue temperature [°C]	21	21
Tissue calibration frequency [MHz]	835	835
Tissue Type	Brain	Muscle
Target conductivity [S/m]	0.90	0.97
Target dielectric constant	41.5	55.2
Composition (by weight) [%]	DI Water (40.15 %) Sugar (54.53 %) Salt (4.2 %) HEC (0.25 %) Bactericide (0.87 %)	DI Water (54.00 %) Sugar (44.51 %) Salt (0.9 %) HEC (0.13 %) Bactericide (0.46 %)
Measured conductivity [S/m]	0.88 (-2.7 %)	0.98 (+1.0 %)
Measured dielectric constant	41.8 (+0.8 %)	56.2 (+1.8 %)
Penetration depth (plane wave excitation) [mm]	40.1	41.3

8.1.1. 835 MHz Brain Tissue

Frequency [MHz]	Meas. after 5min			DI Water at 20°C			Init. Meas.		
	ϵ'	ϵ''	σ [S/m]	ϵ'	ϵ''	σ [S/m]	ϵ'	ϵ''	σ [S/m]
830.000	41.8422	18.8641	0.87	80.1083	3.8248	0.18	41.8123	18.8514	0.87
835.000	41.7967	18.8658	0.88	80.0846	3.8289	0.18	41.7037	18.8503	0.88
840.000	41.7368	18.8507	0.88	80.0854	3.8618	0.18	41.7037	18.8444	0.88

8.1.2. 835 MHz Muscle Tissue

Frequency [MHz]	Meas. after 5min			DI Water at 20°C			Init. Meas.		
	ϵ'	ϵ''	σ [S/m]	ϵ'	ϵ''	σ [S/m]	ϵ'	ϵ''	σ [S/m]
830.000	56.2411	20.9903	0.97	80.2399	3.8474	0.18	55.9652	20.9388	0.97
835.000	56.1875	20.9829	0.98	80.2155	3.8790	0.18	55.8960	20.9607	0.97
840.000	56.1383	20.9408	0.98	80.2248	3.8891	0.18	55.8638	20.9022	0.98

ULTRATECH GROUP OF LABS

3000 Bristol Circle, Oakville, Ontario, Canada L6H 6G4
 Tel. #: 905-829-1570, Fax. #: 905-829-8050, Email: vic@ultratech-labs.com, Website: http://www.ultratech-labs.com

File #: MIS-053-SAR
 March 27, 2006

- Assessed by ITI (UK) Competent Body, NVLAP (USA) Accreditation Body & ACA/AUSTEL (Australia), VCCI (Japan)
- Accredited by Industry Canada (Canada) under ACC-LAB (Europe/Canada MRA and APEC/Canada MRA)
- Recognized/Listed by FCC (USA)
- All test results contained in this engineering test report are traceable to National Institute of Standards and Technology (NIST)

8.2. SIMULATED TISSUE AT 1900 MHZ

Tissue calibration type	HP Dielectric Strength Probe System (M/N: 85070C)	
Tissue calibration date [MM/DD/YYYY]	03/20/2006	03/20/2006
Tissue calibrated by	Carolyn Luu	Carolyn Luu
Room temperature [°C]	21	21
Room humidity [%]	40	40
Simulated tissue temperature [°C]	21	21
Tissue calibration frequency [MHz]	1900	1900
Tissue Type	Brain	Muscle
Target conductivity [S/m]	1.40	1.52
Target dielectric constant	40.0	53.3
Composition (by weight) [%]	DI Water (54.90 %) DGBE (44.92 %) Salt (0.18 %)	DI Water (70.42 %) DGBE (29.34 %) Salt (0.24 %)
Measured conductivity [S/m]	1.39 (-0.7 %)	1.61 (+5.0 %)
Measured dielectric constant	40.2 (+0.5 %)	51.7 (-3.0 %)
Penetration depth (plane wave excitation) [mm]	24.5	24.0

8.2.1. 1900 MHz Brain Tissue

Frequency [MHz]	Meas. after 5min			DI Water at 20°C			Init. Meas.		
	ϵ'	ϵ''	σ [S/m]	ϵ'	ϵ''	σ [S/m]	ϵ'	ϵ''	σ [S/m]
1890.000	40.2665	13.1437	1.38	79.2401	8.4967	0.89	40.2072	13.1493	1.38
1900.000	40.2187	13.1850	1.39	79.2246	8.5290	0.90	40.1526	13.1983	1.40
1910.000	40.1796	13.2327	1.41	79.2109	8.5594	0.91	40.1089	13.2433	1.41

8.2.2. 1900 MHz Brain Tissue

Frequency [MHz]	Meas. after 5min			DI Water at 20°C			Init. Meas.		
	ϵ'	ϵ''	σ [S/m]	ϵ'	ϵ''	σ [S/m]	ϵ'	ϵ''	σ [S/m]
1890.000	51.7386	15.2406	1.61	79.1903	8.4611	0.89	50.6191	15.1690	1.60
1900.000	51.7157	15.2607	1.61	79.1863	8.5028	0.90	50.5874	15.2239	1.61
1910.000	51.6775	15.2981	1.63	79.1779	8.5488	0.91	50.5604	15.2573	1.62

ULTRATECH GROUP OF LABS

3000 Bristol Circle, Oakville, Ontario, Canada L6H 6G4
 Tel. #: 905-829-1570, Fax. #: 905-829-8050, Email: vic@ultratech-labs.com, Website: http://www.ultratech-labs.com

File #: MIS-053-SAR
 March 27, 2006

- Assessed by ITI (UK) Competent Body, NVLAP (USA) Accreditation Body & ACA/AUSTEL (Australia), VCCI (Japan)
- Accredited by Industry Canada (Canada) under ACC-LAB (Europe/Canada MRA and APEC/Canada MRA)
- Recognized/Listed by FCC (USA)
- All test results contained in this engineering test report are traceable to National Institute of Standards and Technology (NIST)

EXHIBIT 9. SAR SYSTEM CALIBRATION

9.1. GENERAL INFORMATION OF THE PROBE

Probe Type	E-Field Triangle, Isotropic
Model Number	ET20
Serial Number	03JUN-0028
Manufacturer	EMF Safety
Manufactured Date	June 2003
Probe Length [mm]	270
Probe offset [mm]	2.0
Probe Tip diameter [mm]	4.0
Sensor Factor (η_{Pd}) [mV/(mW/cm ²)]	10.8
Sensor Factor (η_{E2}) [mV/(V/m) ²]	10.8 / 3770

9.2. PROBE LINEARITY AND DYNAMIC RANGE

9.2.1. Diode Compression Potential

DCP₁	66459
DCP₂	67796
DCP₃	69561

- Assessed by ITI (UK) Competent Body, NVLAP (USA) Accreditation Body & ACA/AUSTEL (Australia), VCCI (Japan)
- Accredited by Industry Canada (Canada) under ACC-LAB (Europe/Canada MRA and APEC/Canada MRA)
- Recognized/Listed by FCC (USA)
- All test results contained in this engineering test report are traceable to National Institute of Standards and Technology (NIST)

9.2.2. Channel 1

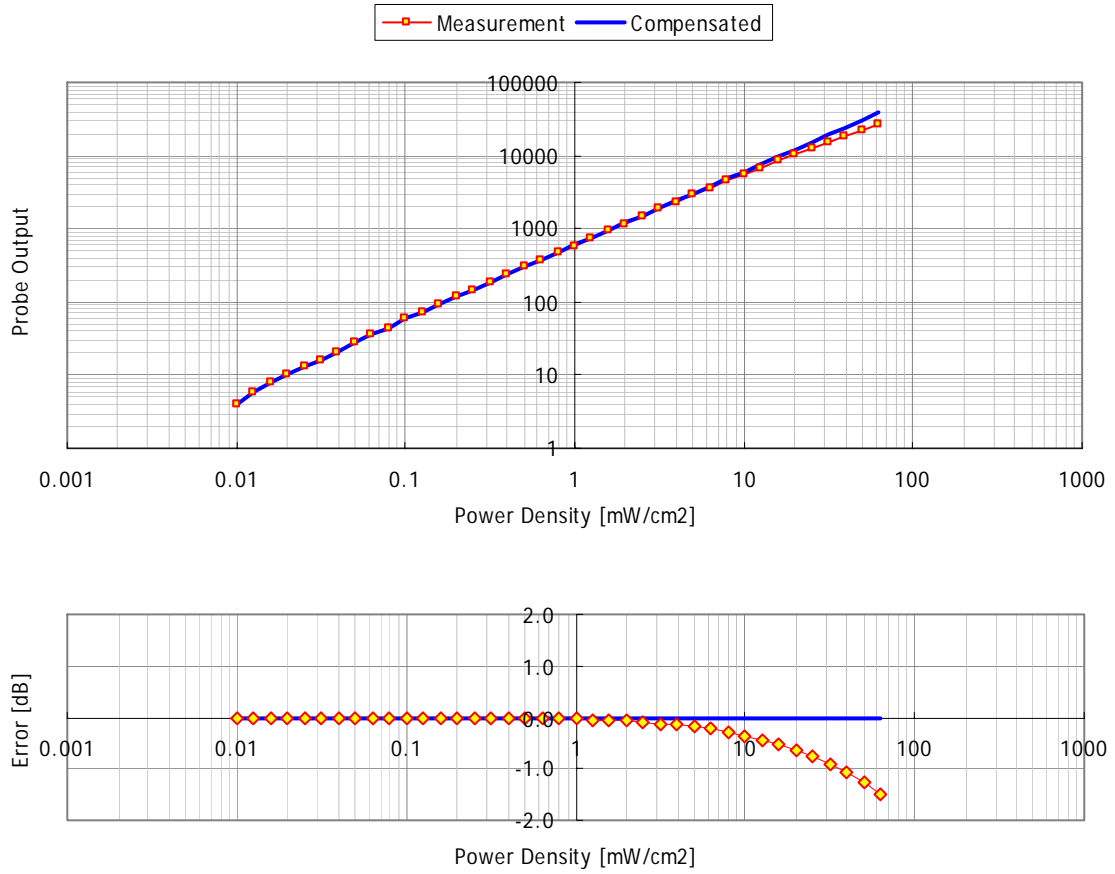

ULTRATECH GROUP OF LABS

3000 Bristol Circle, Oakville, Ontario, Canada L6H 6G4
Tel. #: 905-829-1570, Fax. #: 905-829-8050, Email: vic@ultratech-labs.com, Website: http://www.ultratech-labs.com

File #: MIS-053-SAR
March 27, 2006

- Assessed by ITI (UK) Competent Body, NVLAP (USA) Accreditation Body & ACA/AUSTEL (Australia), VCCI (Japan)
- Accredited by Industry Canada (Canada) under ACC-LAB (Europe/Canada MRA and APEC/Canada MRA)
- Recognized/Listed by FCC (USA)
- All test results contained in this engineering test report are traceable to National Institute of Standards and Technology (NIST)

9.2.3. Channel 2

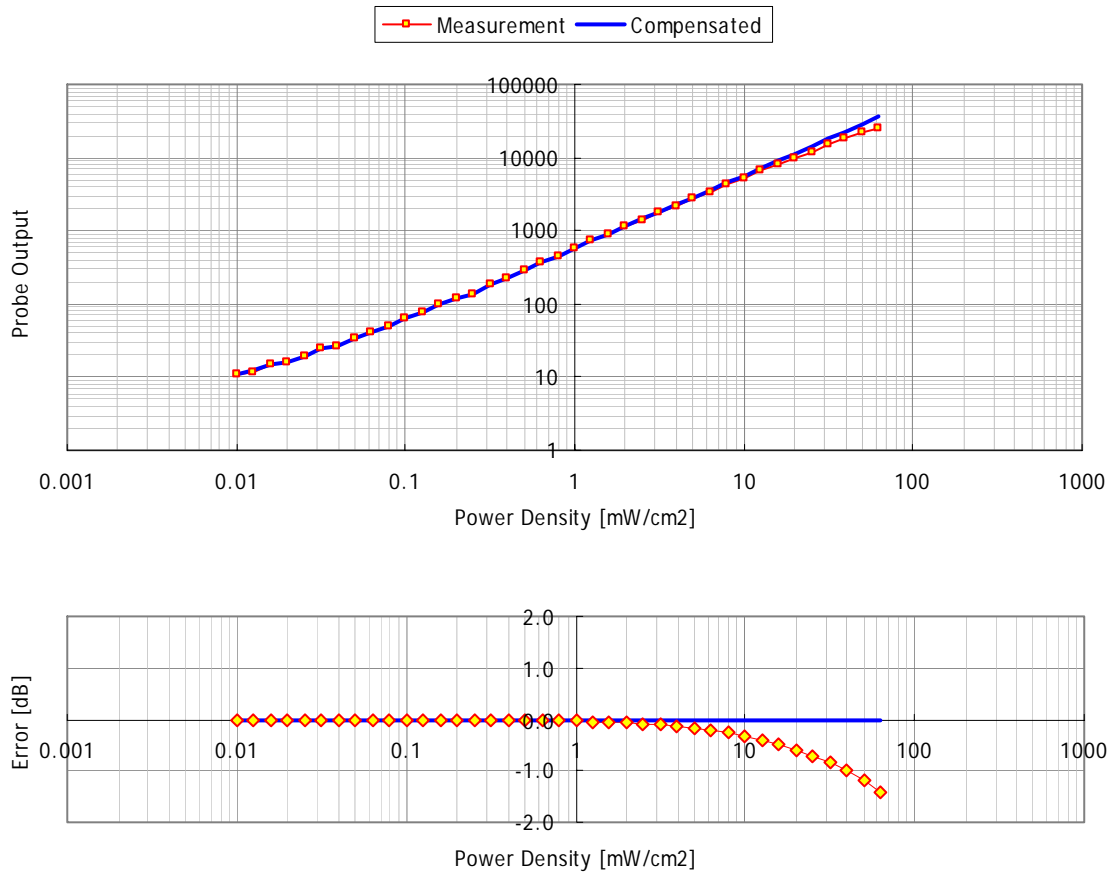

ULTRATECH GROUP OF LABS

3000 Bristol Circle, Oakville, Ontario, Canada L6H 6G4
Tel. #: 905-829-1570, Fax. #: 905-829-8050, Email: vic@ultratech-labs.com, Website: http://www.ultratech-labs.com

File #: MIS-053-SAR
March 27, 2006

- Assessed by ITI (UK) Competent Body, NVLAP (USA) Accreditation Body & ACA/AUSTEL (Australia), VCCI (Japan)
- Accredited by Industry Canada (Canada) under ACC-LAB (Europe/Canada MRA and APEC/Canada MRA)
- Recognized/Listed by FCC (USA)
- All test results contained in this engineering test report are traceable to National Institute of Standards and Technology (NIST)

9.2.4. Channel 3

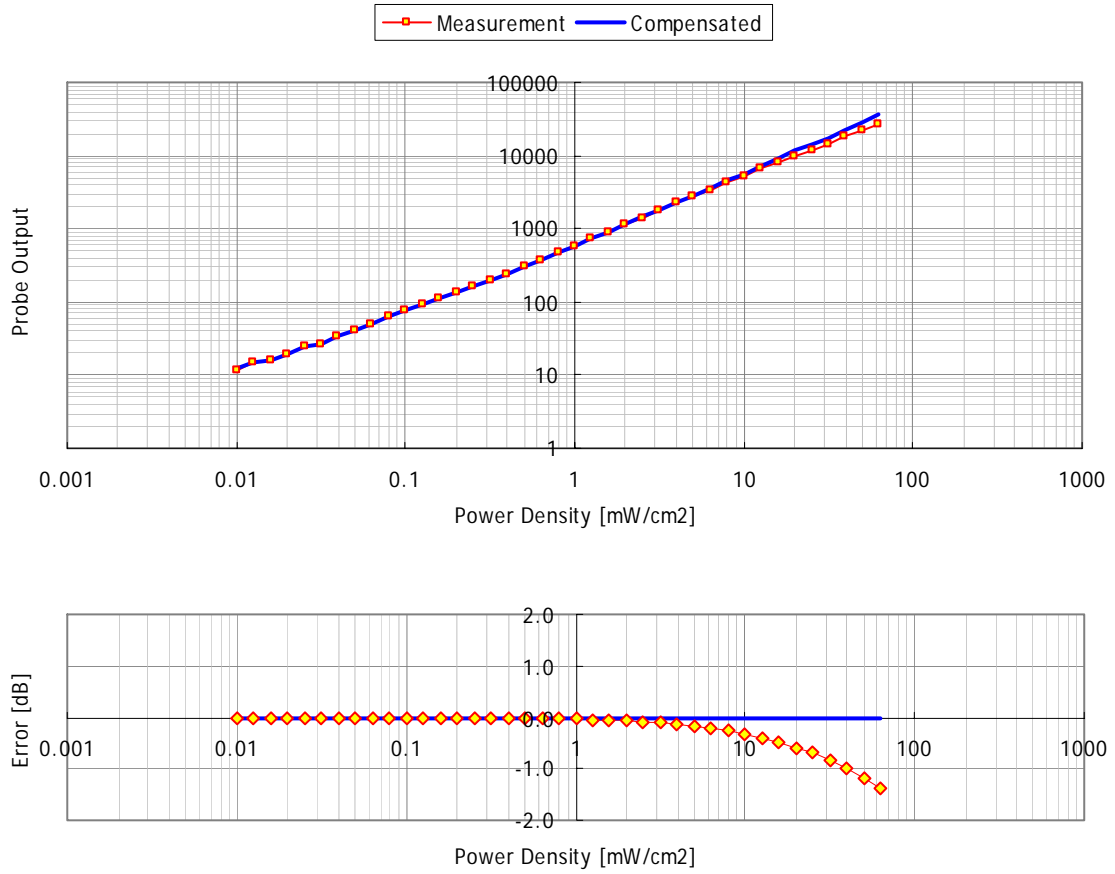

ULTRATECH GROUP OF LABS

3000 Bristol Circle, Oakville, Ontario, Canada L6H 6G4
Tel. #: 905-829-1570, Fax. #: 905-829-8050, Email: vic@ultratech-labs.com, Website: http://www.ultratech-labs.com

File #: MIS-053-SAR
March 27, 2006

- Assessed by ITI (UK) Competent Body, NVLAP (USA) Accreditation Body & ACA/AUSTEL (Australia), VCCI (Japan)
- Accredited by Industry Canada (Canada) under ACC-LAB (Europe/Canada MRA and APEC/Canada MRA)
- Recognized/Listed by FCC (USA)
- All test results contained in this engineering test report are traceable to National Institute of Standards and Technology (NIST)

9.3. PROBE ISOTROPY CALIBRATION

9.3.1. Calibration Setup

9.3.1.1. 835 MHz Setup

Calibration cell type	TEM cell
Model Number	CC-110
Serial Number	162
Manufacturer	IFI Inc.
Input Power / Power Density [mW/(mW/cm ²)] @ 450 MHz	271

9.3.1.2. 1900 MHz Setup

Calibration cell type	Waveguide
Model Number	13492
Serial Number	12463-1, 12463-2
Manufacturer	APOLLO
Input Power / Power Density [mW/(mW/cm ²)]	20.6

9.3.2. Amplifier Settings

9.3.2.1. Isotropy calibration at 835 MHz

Calibration Date [MM/DD/YYYY]	02/14/2006
Calibrated by	JaeWook Choi
Calibration Frequency [MHz]	835
Room Temperature [°C]	21
Room Humidity [%]	40
φ [°]	90
Φ ₁ , Φ ₂ , Φ ₃ [°]	54.7, 54.7, 54.7
Pd [mW/cm ²]	2.0
SUM(U _{L,1} (0°), ... ,U _{L,1} (360°))	24,033
SUM(U _{L,2} (0°), ... ,U _{L,2} (360°))	25,770
SUM(U _{L,3} (0°), ... ,U _{L,3} (360°))	25,764
R _{ISO,1,1}	1.0000000000
R _{ISO,2,1}	0.9325896301
R _{ISO,3,1}	0.9328062482
AS ₁	0.0070744200
AS ₂	0.0065975307
AS ₃	0.0065990632

ULTRATECH GROUP OF LABS

3000 Bristol Circle, Oakville, Ontario, Canada L6H 6G4
 Tel. #: 905-829-1570, Fax. #: 905-829-8050, Email: vic@ultratech-labs.com, Website: http://www.ultratech-labs.com

File #: MIS-053-SAR
 March 27, 2006

- Assessed by ITI (UK) Competent Body, NVLAP (USA) Accreditation Body & ACA/AUSTEL (Australia), VCCI (Japan)
- Accredited by Industry Canada (Canada) under ACC-LAB (Europe/Canada MRA and APEC/Canada MRA)
- Recognized/Listed by FCC (USA)
- All test results contained in this engineering test report are traceable to National Institute of Standards and Technology (NIST)

SPECIFIC ABSORPTION RATE (SAR)

IEEE C95.1-1991, FCC OET Bulletin 65 (Supplement C), Industry Canada RSS-102(Issue 2) and ACA Radiocommunications (Electromagnetic Radiation – Human Exposure) Amendment Standard 2000 (No. 1)

NBS55XX M/N: NBS55XXTXXX

FCC ID: O3JNBS55XXT

9.3.2.2. Isotropy calibration at 1900 MHz

Calibration Date [MM/DD/YYYY]	02/14/2006
Calibrated by	JaeWook Choi
Calibration Frequency [MHz]	1900
Room Temperature [°C]	21
Room Humidity [%]	40
Φ [°]	90
Φ_1, Φ_2, Φ_3 [°]	54.7, 54.7, 54.7
Pd [mW/cm ²]	2.0
SUM ($U_{L,1}(0^\circ), \dots, U_{L,1}(360^\circ)$)	27,464
SUM ($U_{L,2}(0^\circ), \dots, U_{L,2}(360^\circ)$)	26,049
SUM ($U_{L,3}(0^\circ), \dots, U_{L,3}(360^\circ)$)	28,594
R _{ISO.1.1}	1.0000000000
R _{ISO.2.1}	1.0543247925
R _{ISO.3.1}	0.9604638942
AS ₁	0.0062748828
AS ₂	0.0066157645
AS ₃	0.0060267983

ULTRATECH GROUP OF LABS

3000 Bristol Circle, Oakville, Ontario, Canada L6H 6G4

Tel. #: 905-829-1570, Fax. #: 905-829-8050, Email: vic@ultratech-labs.com, Website: http://www.ultratech-labs.com

File #: MIS-053-SAR

March 27, 2006

- Assessed by ITI (UK) Competent Body, NVLAP (USA) Accreditation Body & ACA/AUSTEL (Australia), VCCI (Japan)
- Accredited by Industry Canada (Canada) under ACC-LAB (Europe/Canada MRA and APEC/Canada MRA)
- Recognized/Listed by FCC (USA)
- All test results contained in this engineering test report are traceable to National Institute of Standards and Technology (NIST)

9.3.3. Isotropic response at 835 MHz

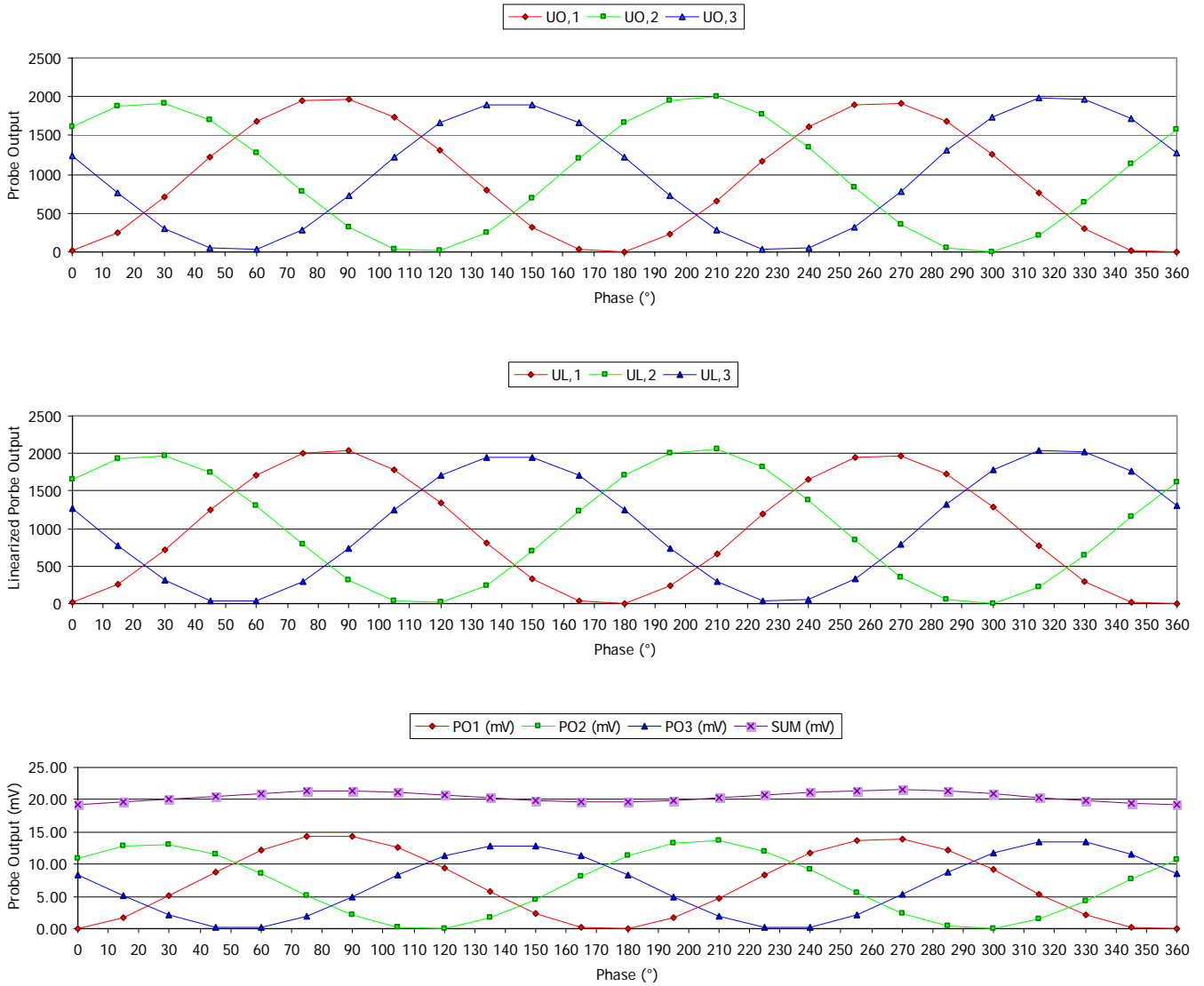

Isotropy at 835 MHz: ± 0.14 dB

ULTRATECH GROUP OF LABS

3000 Bristol Circle, Oakville, Ontario, Canada L6H 6G4
 Tel. #: 905-829-1570, Fax. #: 905-829-8050, Email: vic@ultratech-labs.com, Website: http://www.ultratech-labs.com

File #: MIS-053-SAR
March 27, 2006

- Assessed by ITI (UK) Competent Body, NVLAP (USA) Accreditation Body & ACA/AUSTEL (Australia), VCCI (Japan)
- Accredited by Industry Canada (Canada) under ACC-LAB (Europe/Canada MRA and APEC/Canada MRA)
- Recognized/Listed by FCC (USA)
- All test results contained in this engineering test report are traceable to National Institute of Standards and Technology (NIST)

9.3.4. Isotropic response at 1900 MHz

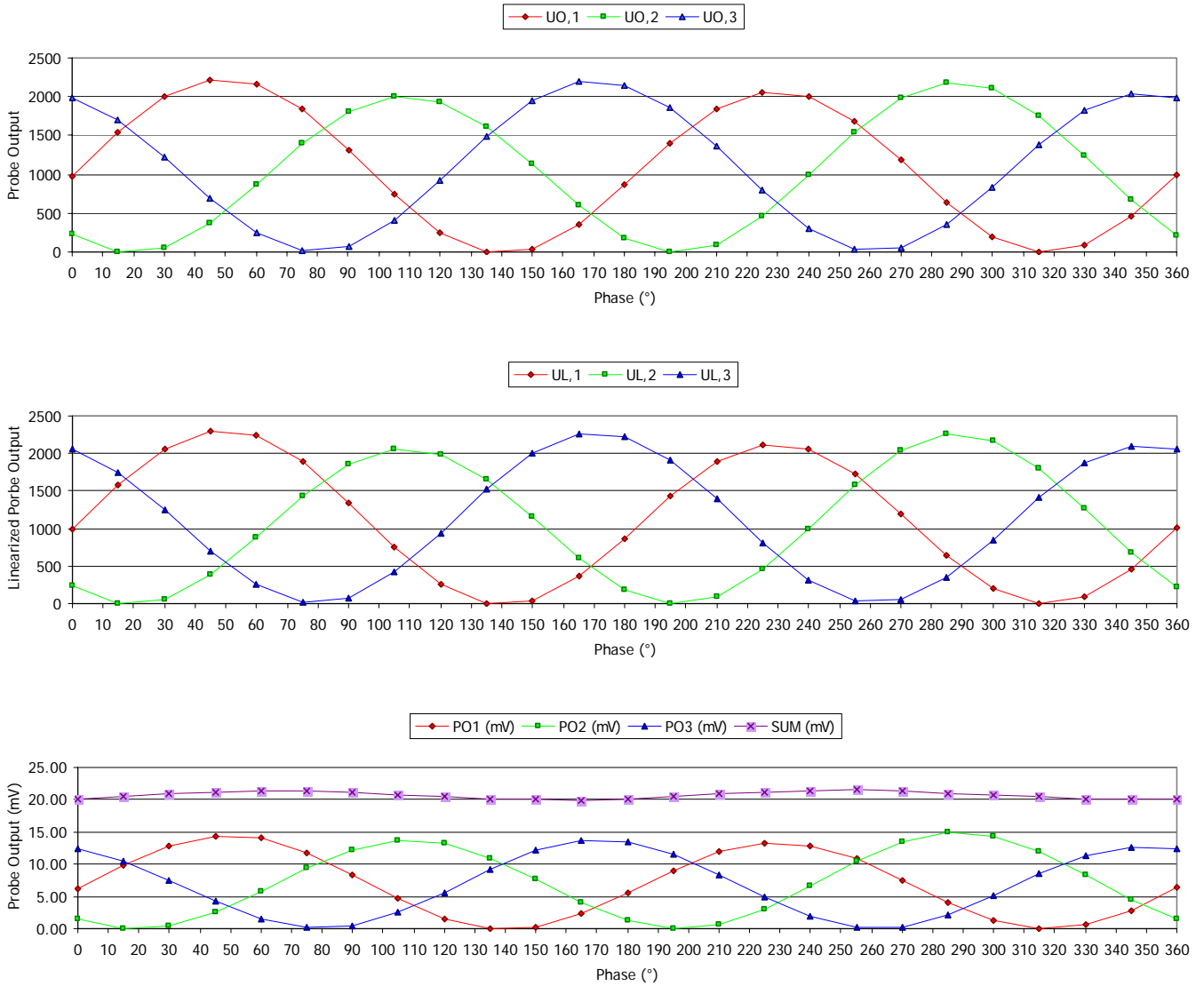

Isotropy at 1900 MHz: ±0.10 dB

ULTRATECH GROUP OF LABS

3000 Bristol Circle, Oakville, Ontario, Canada L6H 6G4
Tel. #: 905-829-1570, Fax. #: 905-829-8050, Email: vic@ultratech-labs.com, Website: http://www.ultratech-labs.com

File #: MIS-053-SAR
March 27, 2006

- Assessed by ITI (UK) Competent Body, NVLAP (USA) Accreditation Body & ACA/AUSTEL (Australia), VCCI (Japan)
- Accredited by Industry Canada (Canada) under ACC-LAB (Europe/Canada MRA and APEC/Canada MRA)
- Recognized/Listed by FCC (USA)
- All test results contained in this engineering test report are traceable to National Institute of Standards and Technology (NIST)

9.4. PROBE THERMAL TRANSFER CALIBRATION

9.4.1. Calibration Setup

9.4.1.1. Setup for 835 MHz

Calibration type	Thermal transfer calibration
Flat phantom dimension (W × L × H) [mm]	420 × 700 × 200
Flat phantom shell thickness (d₃) [mm]	2.0
Flat phantom shell permittivity	2.98
Calibration dipole dimension (L × h × d) [mm]	305.5 × 169.2 × 3.6
Sensor-to-Phantom (d₁) [mm]	7.0
Dipole-to-Phantom (d₂) [mm]	13.0
Sensor-to-Dipole (d₁ + d₂ + d₃) [mm]	20.0 (7.0 + 13.0 + 2.0)
Return Loss (at test frequency) [dB]	-20.0

ULTRATECH GROUP OF LABS

3000 Bristol Circle, Oakville, Ontario, Canada L6H 6G4
 Tel. #: 905-829-1570, Fax. #: 905-829-8050, Email: vic@ultratech-labs.com, Website: http://www.ultratech-labs.com

File #: MIS-053-SAR
March 27, 2006

- Assessed by ITI (UK) Competent Body, NVLAP (USA) Accreditation Body & ACA/AUSTEL (Australia), VCCI (Japan)
- Accredited by Industry Canada (Canada) under ACC-LAB (Europe/Canada MRA and APEC/Canada MRA)
- Recognized/Listed by FCC (USA)
- All test results contained in this engineering test report are traceable to National Institute of Standards and Technology (NIST)

9.4.2. Simulated Tissue

9.4.2.1. Brain Tissue at 835 MHz

Tissue calibration type	HP Dielectric Strength Probe System
Tissue calibration date [MM/DD/YYYY]	02/15/2006
Tissue calibrated by	Carolyn Luu
Room temperature [°C]	21
Room humidity [%]	40
Simulated tissue temperature [°C]	21
Tissue calibration frequency [MHz]	835
Tissue Type	Brain
Target conductivity [S/m]	0.90
Target dielectric constant	41.5
Specific Heat Capacity [J/Kg/°C]	2,840
Mass Density [Kg/m ³]	1,280
Measured conductivity [S/m]	0.89 (-1.2 %)
Measured dielectric constant	41.5 (+0.0 %)
Penetration depth (plane wave excitation) [mm]	39.4

9.4.2.2. Muscle Tissue at 835 MHz

Tissue calibration type	HP Dielectric Strength Probe System
Tissue calibration date [MM/DD/YYYY]	02/15/2006
Tissue calibrated by	Carolyn Luu
Room temperature [°C]	21
Room humidity [%]	40
Simulated tissue temperature [°C]	21
Tissue calibration frequency [MHz]	835
Tissue Type	Muscle
Target conductivity [S/m]	0.97
Target dielectric constant	55.2
Specific Heat Capacity [J/Kg/°C]	3,110
Mass Density [Kg/m ³]	1,210
Measured conductivity [S/m]	0.96 (-1.5 %)
Measured dielectric constant	56.0 (+1.4 %)
Penetration depth (plane wave excitation) [mm]	42.3

ULTRATECH GROUP OF LABS

3000 Bristol Circle, Oakville, Ontario, Canada L6H 6G4
 Tel. #: 905-829-1570, Fax. #: 905-829-8050, Email: vic@ultratech-labs.com, Website: http://www.ultratech-labs.com

File #: MIS-053-SAR
 March 27, 2006

- Assessed by ITI (UK) Competent Body, NVLAP (USA) Accreditation Body & ACA/AUSTEL (Australia), VCCI (Japan)
- Accredited by Industry Canada (Canada) under ACC-LAB (Europe/Canada MRA and APEC/Canada MRA)
- Recognized/Listed by FCC (USA)
- All test results contained in this engineering test report are traceable to National Institute of Standards and Technology (NIST)

9.4.3. Conversion Factor

9.4.3.1. Thermal transfer calibration at 835 MHz for simulated brain tissue

Calibration Date [MM/DD/YYYY]	02/15/2006
Calibration by	JaeWook Choi
Calibration Frequency [MHz]	835
Room Temperature [°C]	21
Room Humidity [%]	40
Simulated Tissue Temperature [°C]	21
$\delta(PO_{tot\ tissue})/\delta P$ [mV/W]	3.822135E+01
$\delta(\Delta T/\Delta t)/\delta P$ [°C/sec/W]	4.905857E-04
Conversion Factor (γ)	5.893

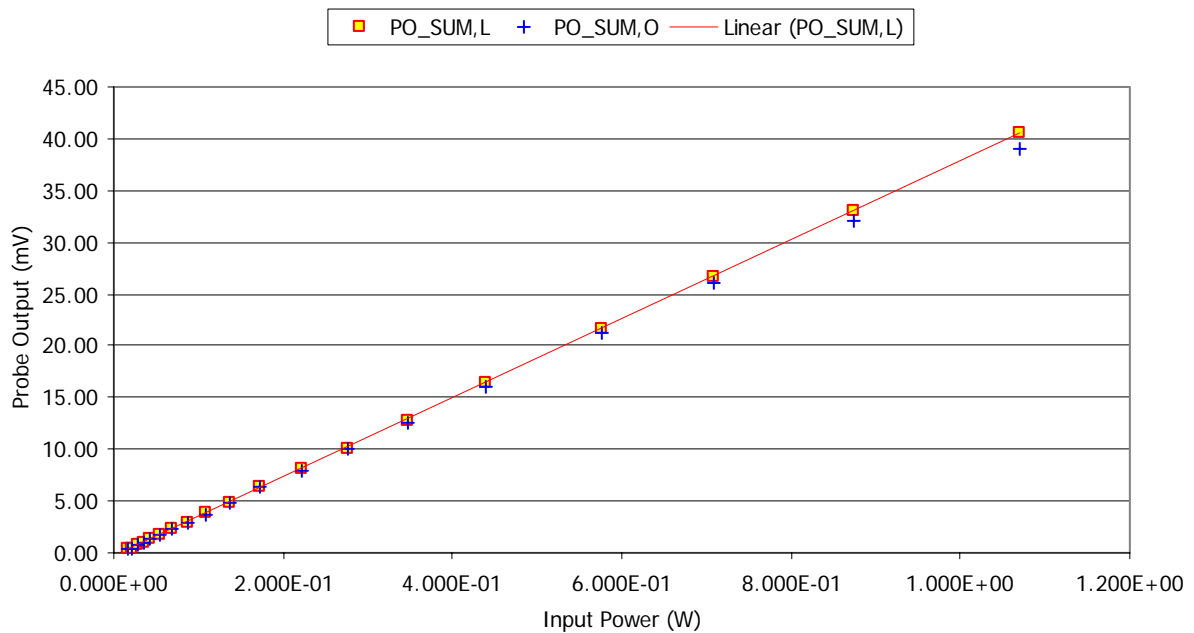

ULTRATECH GROUP OF LABS

3000 Bristol Circle, Oakville, Ontario, Canada L6H 6G4
 Tel. #: 905-829-1570, Fax. #: 905-829-8050, Email: vic@ultratech-labs.com, Website: http://www.ultratech-labs.com

File #: MIS-053-SAR
March 27, 2006

- Assessed by ITI (UK) Competent Body, NVLAP (USA) Accreditation Body & ACA/AUSTEL (Australia), VCCI (Japan)
- Accredited by Industry Canada (Canada) under ACC-LAB (Europe/Canada MRA and APEC/Canada MRA)
- Recognized/Listed by FCC (USA)
- All test results contained in this engineering test report are traceable to National Institute of Standards and Technology (NIST)

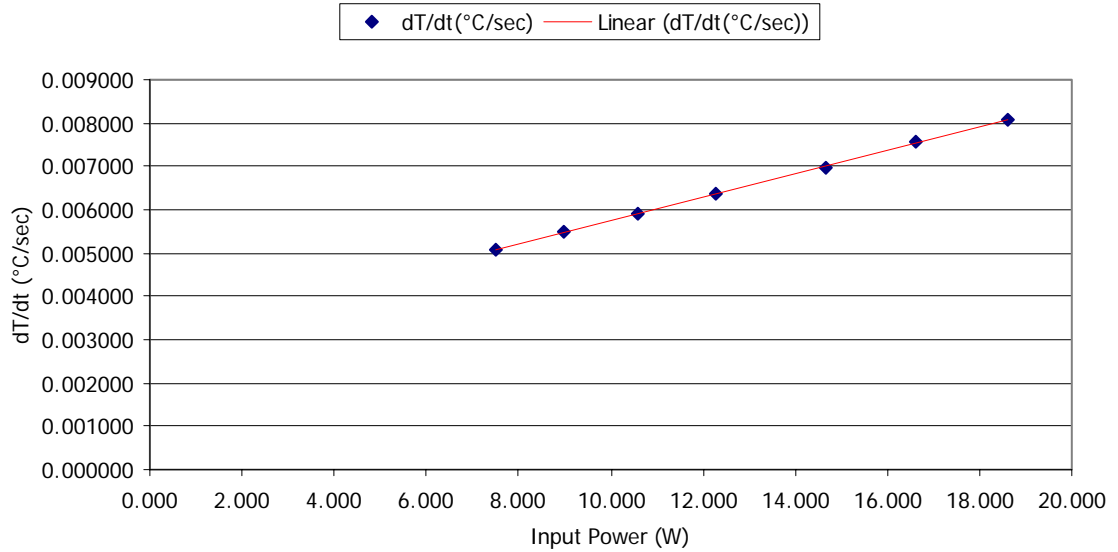

ULTRATECH GROUP OF LABS

3000 Bristol Circle, Oakville, Ontario, Canada L6H 6G4
Tel. #: 905-829-1570, Fax. #: 905-829-8050, Email: vic@ultratech-labs.com, Website: <http://www.ultratech-labs.com>

File #: MIS-053-SAR
March 27, 2006

- Assessed by ITI (UK) Competent Body, NVLAP (USA) Accreditation Body & ACA/AUSTEL (Australia), VCCI (Japan)
- Accredited by Industry Canada (Canada) under ACC-LAB (Europe/Canada MRA and APEC/Canada MRA)
- Recognized/Listed by FCC (USA)
- All test results contained in this engineering test report are traceable to National Institute of Standards and Technology (NIST)

9.4.3.2. Thermal transfer calibration at 835 MHz for simulated muscle tissue

Calibration Date [MM/DD/YYYY]	02/15/2006
Calibration by	JaeWook Choi
Calibration Frequency [MHz]	835
Room Temperature [°C]	21
Room Humidity [%]	40
Simulated Tissue Temperature [°C]	21
$\delta(\text{PO}_{\text{tot tissue}})/\delta P$ [mV/W]	2.908121E+01
$\delta(\Delta T/\Delta t)/\delta P$ [°C/sec/W]	4.936271E-04
Conversion Factor (γ)	5.246

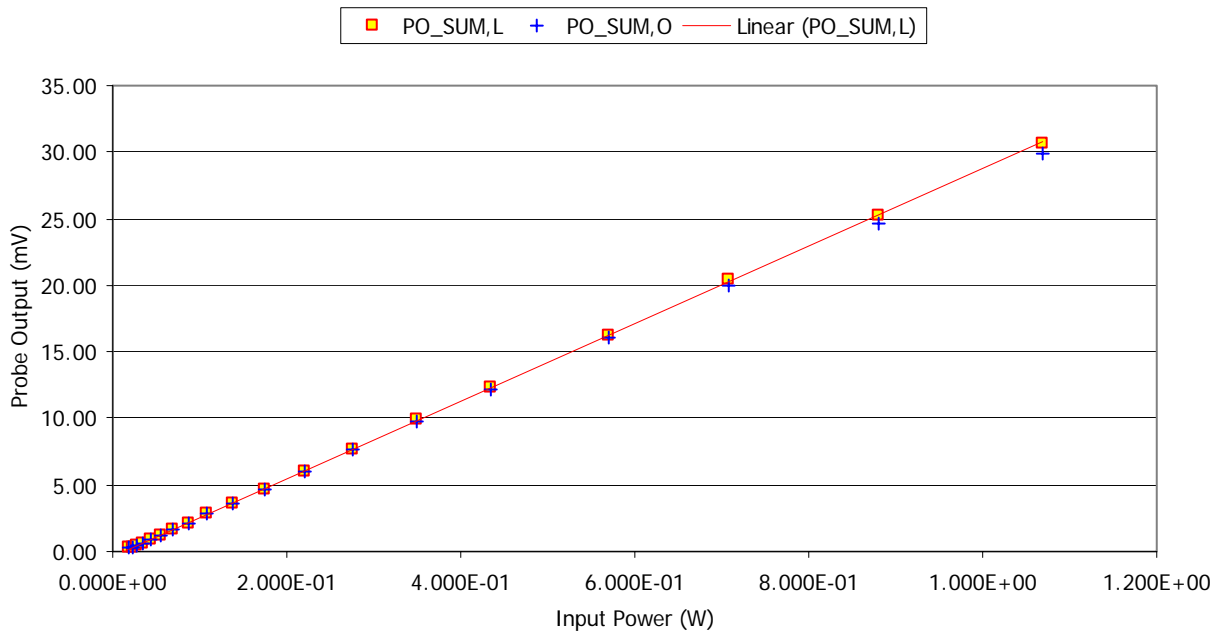

ULTRATECH GROUP OF LABS

3000 Bristol Circle, Oakville, Ontario, Canada L6H 6G4
 Tel. #: 905-829-1570, Fax. #: 905-829-8050, Email: vic@ultratech-labs.com, Website: http://www.ultratech-labs.com

File #: MIS-053-SAR
March 27, 2006

- Assessed by ITI (UK) Competent Body, NVLAP (USA) Accreditation Body & ACA/AUSTEL (Australia), VCCI (Japan)
- Accredited by Industry Canada (Canada) under ACC-LAB (Europe/Canada MRA and APEC/Canada MRA)
- Recognized/Listed by FCC (USA)
- All test results contained in this engineering test report are traceable to National Institute of Standards and Technology (NIST)

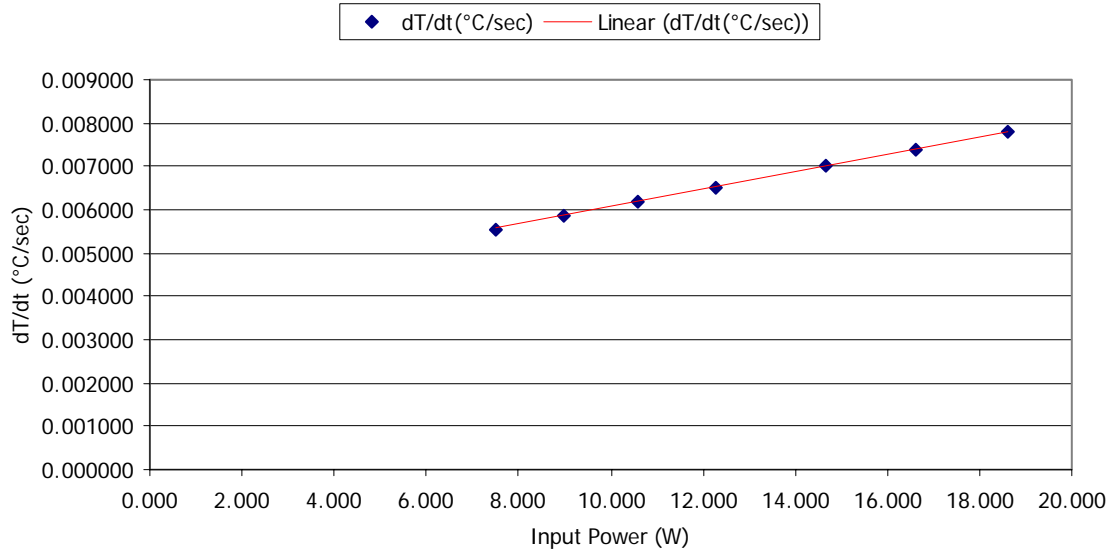

ULTRATECH GROUP OF LABS

3000 Bristol Circle, Oakville, Ontario, Canada L6H 6G4
Tel. #: 905-829-1570, Fax. #: 905-829-8050, Email: vic@ultratech-labs.com, Website: http://www.ultratech-labs.com

File #: MIS-053-SAR
March 27, 2006

- Assessed by ITI (UK) Competent Body, NVLAP (USA) Accreditation Body & ACA/AUSTEL (Australia), VCCI (Japan)
- Accredited by Industry Canada (Canada) under ACC-LAB (Europe/Canada MRA and APEC/Canada MRA)
- Recognized/Listed by FCC (USA)
- All test results contained in this engineering test report are traceable to National Institute of Standards and Technology (NIST)

9.5. CALCULABLE WAVEGUIDE CALIBRATION

9.5.1. Calibration Setup

9.5.1.1. Setup for 1900 MHz

Calibration type	Calculable waveguide calibration
Waveguide Manufacturer	APOLLO
Waveguide dimension (a x b) [mm]	109.2 x 54.7
Dielectric Separator thickness [mm]	12.6
Dielectric Separator permittivity	5.0
Return Loss (at test frequency) [dB]	Better than -20



ULTRATECH GROUP OF LABS

3000 Bristol Circle, Oakville, Ontario, Canada L6H 6G4
Tel. #: 905-829-1570, Fax. #: 905-829-8050, Email: vic@ultratech-labs.com, Website: http://www.ultratech-labs.com

File #: MIS-053-SAR
March 27, 2006

- Assessed by ITI (UK) Competent Body, NVLAP (USA) Accreditation Body & ACA/AUSTEL (Australia), VCCI (Japan)
- Accredited by Industry Canada (Canada) under ACC-LAB (Europe/Canada MRA and APEC/Canada MRA)
- Recognized/Listed by FCC (USA)
- All test results contained in this engineering test report are traceable to National Institute of Standards and Technology (NIST)

SPECIFIC ABSORPTION RATE (SAR)

IEEE C95.1-1991, FCC OET Bulletin 65 (Supplement C), Industry Canada RSS-102(Issue 2) and ACA Radiocommunications (Electromagnetic Radiation – Human Exposure) Amendment Standard 2000 (No. 1)

NBS55XX M/N: NBS55XXTXXX

FCC ID: O3JNBS55XXT

9.5.2. Simulated Tissue**9.5.2.1. Brain Tissue at 1870 MHz**

Tissue calibration type	HP Dielectric Strength Probe System
Tissue calibration date [MM/DD/YYYY]	02/16/2006
Tissue calibrated by	Carolyn Luu
Room temperature [°C]	21
Room humidity [%]	40
Simulated tissue temperature [°C]	21
Tissue calibration frequency [MHz]	1900
Tissue Type	Brain
Target conductivity [S/m]	1.40
Target dielectric constant	40.0
Measured conductivity [S/m]	1.44 (+2.9 %)
Measured dielectric constant	39.7 (-0.7 %)
Penetration depth (plane wave excitation) [mm]	23.6

9.5.2.2. Muscle Tissue at 1900 MHz

Tissue calibration type	HP Dielectric Strength Probe System
Tissue calibration date [MM/DD/YYYY]	02/16/2006
Tissue calibrated by	Carolyn Luu
Room temperature [°C]	21
Room humidity [%]	40
Simulated tissue temperature [°C]	21
Tissue calibration frequency [MHz]	1900
Tissue Type	Muscle
Target conductivity [S/m]	1.52
Target dielectric constant	53.3
Measured conductivity [S/m]	1.59 (+4.2 %)
Measured dielectric constant	51.9 (-2.7 %)
Penetration depth (plane wave excitation) [mm]	24.2

ULTRATECH GROUP OF LABS

3000 Bristol Circle, Oakville, Ontario, Canada L6H 6G4

Tel. #: 905-829-1570, Fax. #: 905-829-8050, Email: vic@ultratech-labs.com, Website: http://www.ultratech-labs.com

File #: MIS-053-SAR

March 27, 2006

- Assessed by ITI (UK) Competent Body, NVLAP (USA) Accreditation Body & ACA/AUSTEL (Australia), VCCI (Japan)
- Accredited by Industry Canada (Canada) under ACC-LAB (Europe/Canada MRA and APEC/Canada MRA)
- Recognized/Listed by FCC (USA)
- All test results contained in this engineering test report are traceable to National Institute of Standards and Technology (NIST)

9.5.3. Conversion Factor

9.5.3.1. Calculable waveguide calibration at 1870 MHz for simulated brain tissue

Calibration Date [MM/DD/YYYY]	02/16/2006
Calibration by	JaeWook Choi
Calibration Frequency [MHz]	1870
Room Temperature [°C]	21
Room Humidity [%]	40
Simulated Tissue Temperature [°C]	21
Input Power [mW]	90.25
Waveguide dimension (a × b) [mm]	0.1092 × 0.0547
Penetration Depth δ [m]	0.0239
Conversion Factor (γ)	4.724

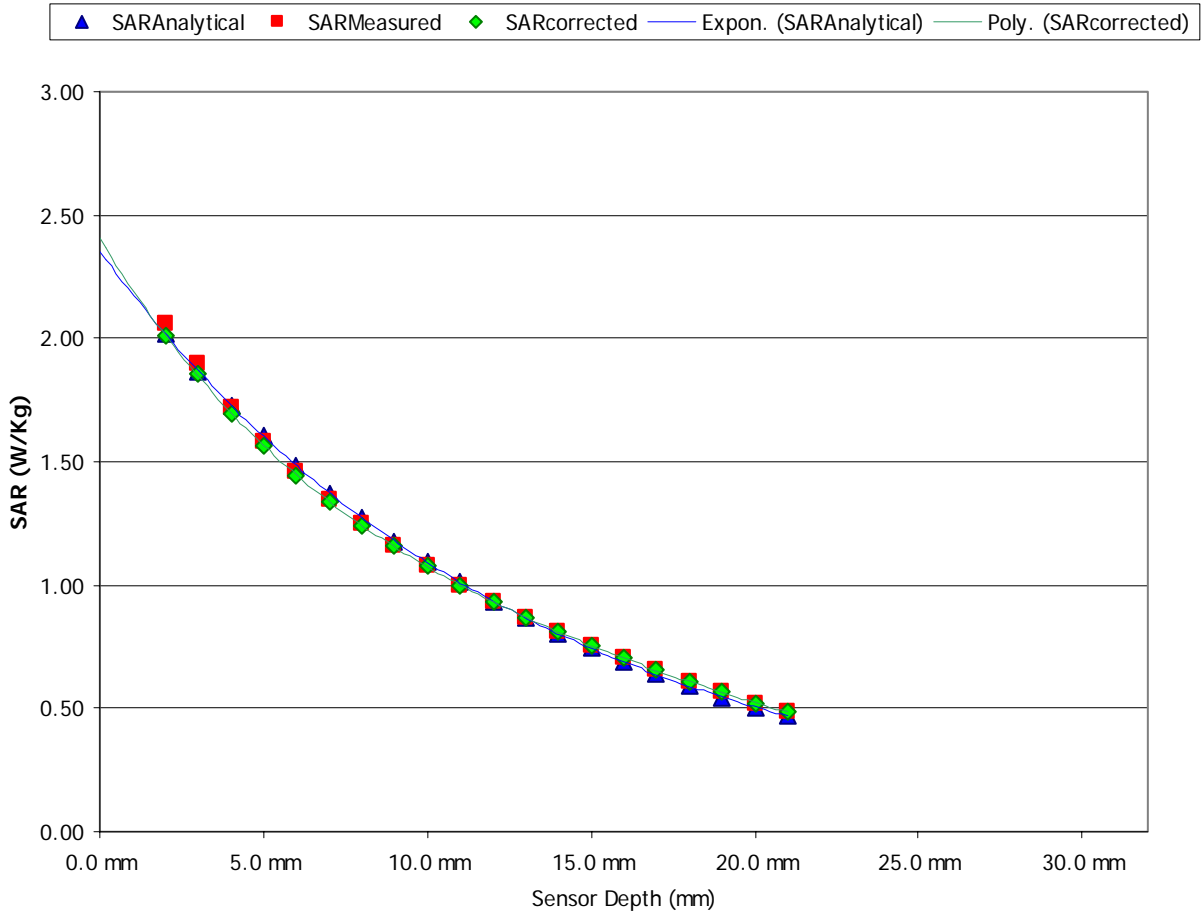

ULTRATECH GROUP OF LABS

3000 Bristol Circle, Oakville, Ontario, Canada L6H 6G4
 Tel. #: 905-829-1570, Fax. #: 905-829-8050, Email: vic@ultratech-labs.com, Website: http://www.ultratech-labs.com

File #: MIS-053-SAR
 March 27, 2006

- Assessed by ITI (UK) Competent Body, NVLAP (USA) Accreditation Body & ACA/AUSTEL (Australia), VCCI (Japan)
- Accredited by Industry Canada (Canada) under ACC-LAB (Europe/Canada MRA and APEC/Canada MRA)
- Recognized/Listed by FCC (USA)
- All test results contained in this engineering test report are traceable to National Institute of Standards and Technology (NIST)

9.5.3.2. Calculable waveguide calibration at 1900 MHz for simulated muscle tissue

Calibration Date [MM/DD/YYYY]	02/16/2006
Calibration by	JaeWook Choi
Calibration Frequency [MHz]	1900
Room Temperature [°C]	21
Room Humidity [%]	40
Simulated Tissue Temperature [°C]	21
Input Power [mW]	107.99
Waveguide dimension (a × b) [mm]	0.1092 × 0.0547
Penetration Depth δ [m]	0.0243
Conversion Factor (γ)	4.066

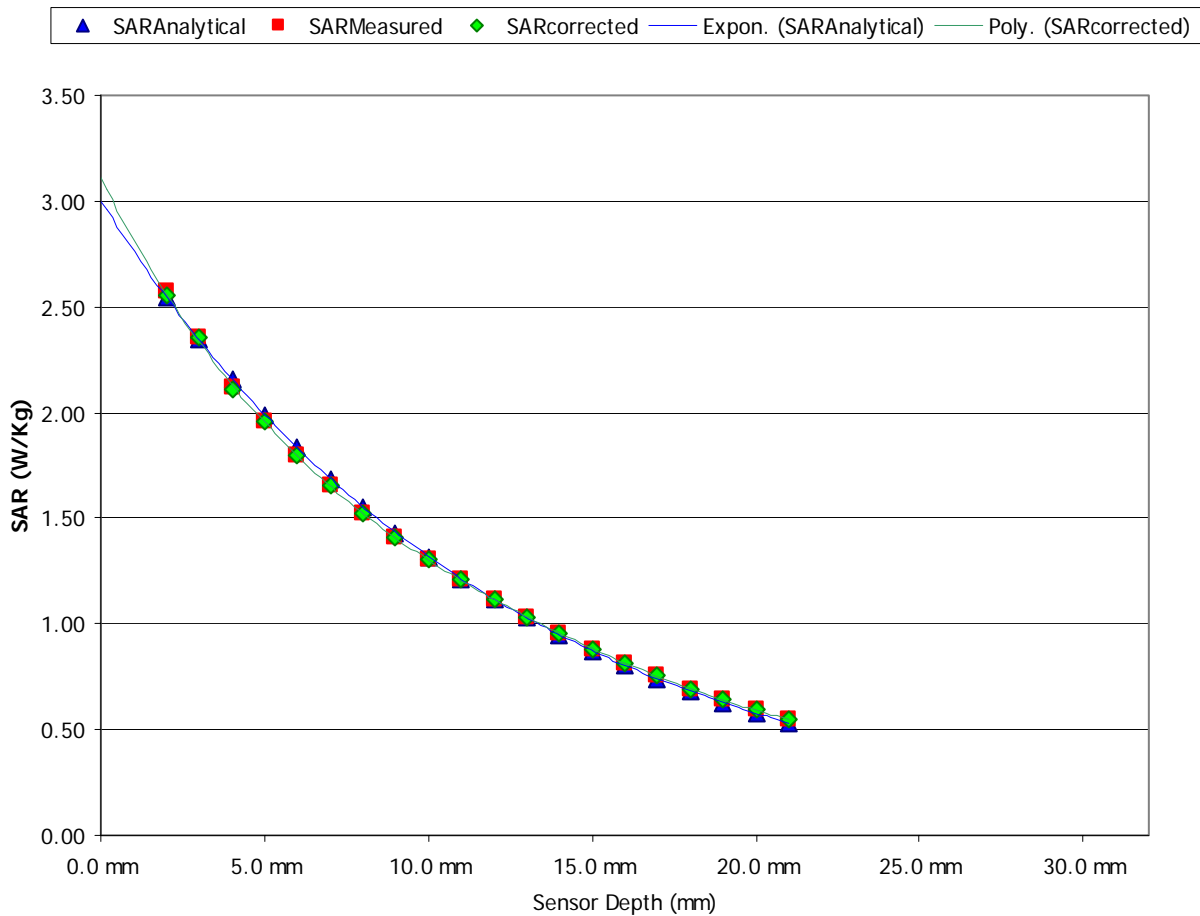

ULTRATECH GROUP OF LABS

3000 Bristol Circle, Oakville, Ontario, Canada L6H 6G4
 Tel. #: 905-829-1570, Fax. #: 905-829-8050, Email: vic@ultratech-labs.com, Website: http://www.ultratech-labs.com

File #: MIS-053-SAR
March 27, 2006

- Assessed by ITI (UK) Competent Body, NVLAP (USA) Accreditation Body & ACA/AUSTEL (Australia), VCCI (Japan)
- Accredited by Industry Canada (Canada) under ACC-LAB (Europe/Canada MRA and APEC/Canada MRA)
- Recognized/Listed by FCC (USA)
- All test results contained in this engineering test report are traceable to National Institute of Standards and Technology (NIST)

EXHIBIT 10. SAR SYSTEM VERIFICATION USING DIPOLE REFERENCE

10.1. VERIFICATION SETUP

10.1.1. Test setup at 835 MHz using the dipole reference

Flat phantom dimension (W × L × H) [mm]	420 × 700 × 200
Flat phantom shell thickness (d₃) [mm]	2.0
Flat phantom shell permittivity	2.98
Reference dipole dimension (L × h × d) [mm]	165 × 90 × 3.6
Dipole-to-Phantom (d₂) [mm]	13.0
Dipole-to-Liquid (d₂ + d₃) [mm]	15.0 (13.0 + 2.0)
Return Loss (at test frequency) [dB]	-20.0

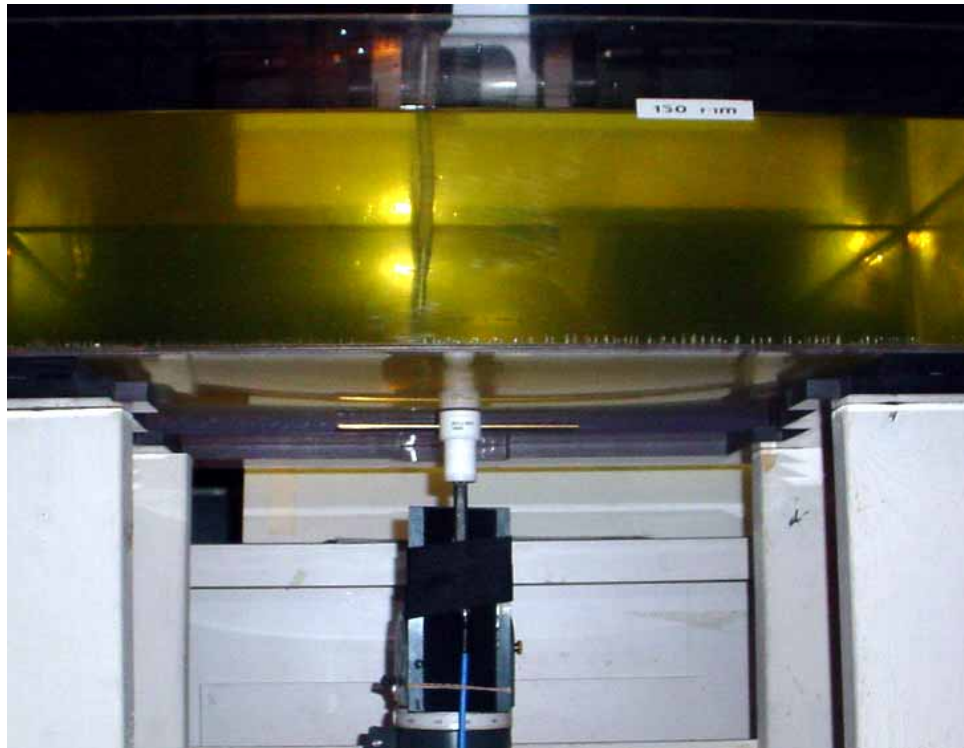

ULTRATECH GROUP OF LABS

3000 Bristol Circle, Oakville, Ontario, Canada L6H 6G4
 Tel. #: 905-829-1570, Fax. #: 905-829-8050, Email: vic@ultratech-labs.com, Website: http://www.ultratech-labs.com

File #: MIS-053-SAR
March 27, 2006

- Assessed by ITI (UK) Competent Body, NVLAP (USA) Accreditation Body & ACA/AUSTEL (Australia), VCCI (Japan)
- Accredited by Industry Canada (Canada) under ACC-LAB (Europe/Canada MRA and APEC/Canada MRA)
- Recognized/Listed by FCC (USA)
- All test results contained in this engineering test report are traceable to National Institute of Standards and Technology (NIST)

10.1.2. Test setup at 1900 MHz using the dipole reference

Flat phantom dimension ($W \times L \times H$) [mm]	420 × 700 × 200
Flat phantom shell thickness (d_3) [mm]	2.0
Flat phantom shell permittivity	2.98
Reference dipole dimension ($L \times h \times d$) [mm]	69.7 × 39.8 × 3.6
Dipole-to-Phantom (d_2) [mm]	8.0
Dipole-to-Liquid ($d_2 + d_3$) [mm]	10.0 (8.0 + 2.0)
Return Loss (at test frequency) [dB]	-24.0

**ULTRATECH GROUP OF LABS**

3000 Bristol Circle, Oakville, Ontario, Canada L6H 6G4

Tel. #: 905-829-1570, Fax. #: 905-829-8050, Email: vic@ultratech-labs.com, Website: <http://www.ultratech-labs.com>**File #: MIS-053-SAR****March 27, 2006**

- Assessed by ITI (UK) Competent Body, NVLAP (USA) Accreditation Body & ACA/AUSTEL (Australia), VCCI (Japan)
- Accredited by Industry Canada (Canada) under ACC-LAB (Europe/Canada MRA and APEC/Canada MRA)
- Recognized/Listed by FCC (USA)
- All test results contained in this engineering test report are traceable to National Institute of Standards and Technology (NIST)

10.2. SIMULATED TISSUE

10.2.1. Simulated brain tissue at 835 MHz

Tissue calibration type	HP Dielectric Strength Probe System
Tissue calibration date [MM/DD/YYYY]	03/16/2006
Tissue calibrated by	JaeWook Choi
Room temperature [°C]	21
Room humidity [%]	40
Simulated tissue temperature [°C]	21
Tissue calibration frequency [MHz]	835
Tissue Type	Brain
Target conductivity [S/m]	0.90
Target dielectric constant	41.5
Measured conductivity [S/m]	0.88 (-2.7 %)
Measured dielectric constant	41.8 (+0.8 %)
Penetration depth (plane wave excitation) [mm]	40.1

10.2.2. Simulated brain tissue at 1900 MHz

Tissue calibration type	HP Dielectric Strength Probe System
Tissue calibration date [MM/DD/YYYY]	03/20/2006
Tissue calibrated by	JaeWook Choi
Room temperature [°C]	21
Room humidity [%]	40
Simulated tissue temperature [°C]	21
Tissue calibration frequency [MHz]	1900
Tissue Type	Brain
Target conductivity [S/m]	1.40
Target dielectric constant	40.0
Measured conductivity [S/m]	1.39 (-0.7 %)
Measured dielectric constant	40.2 (+0.5 %)
Penetration depth (plane wave excitation) [mm]	24.5

ULTRATECH GROUP OF LABS

3000 Bristol Circle, Oakville, Ontario, Canada L6H 6G4
 Tel. #: 905-829-1570, Fax. #: 905-829-8050, Email: vic@ultratech-labs.com, Website: http://www.ultratech-labs.com

File #: MIS-053-SAR
March 27, 2006

- Assessed by ITI (UK) Competent Body, NVLAP (USA) Accreditation Body & ACA/AUSTEL (Australia), VCCI (Japan)
- Accredited by Industry Canada (Canada) under ACC-LAB (Europe/Canada MRA and APEC/Canada MRA)
- Recognized/Listed by FCC (USA)
- All test results contained in this engineering test report are traceable to National Institute of Standards and Technology (NIST)

10.3. VERIFICATION RESULT

10.3.1. Reference SAR values for simulated brain tissue at 835 MHz*

Reference SAR _{Ig} [W/Kg]	9.5
Reference SAR _s [W/Kg]	14.1
Measured SAR _{Ig} [W/Kg]	9.1
Measured SAR _s [W/Kg]	14.9

10.3.2. Verification at 835 MHz

Test date [MM/DD/YYYY]	03/16/2006
Test by	JaeWook Choi
Room temperature [°C]	21
Room humidity [%]	40
Simulated tissue temperature [°C]	21
Test frequency [MHz]	835
E-field Probe	M/N: ET20, S/N: 03JUN-0028, Sensor Offset: 2.0 mm
Sensor Factor (η_{pd}) [mV/(mW/cm ²)]	10.8
Amplifier Settings (AS ₁ , AS ₂ , AS ₃)	0.0070744200, 0.0065975307, 0.0065990632
Tissue Type	Brain
Measured conductivity [S/m]	0.88 (-2.7 %)
Measured dielectric constant	41.8 (+0.8 %)
Conversion Factor (γ)	5.893
Sensitivity (ζ) [W/Kg/mV]	5.213E-02
Power [mW]	500 (forward power)
Measurement Volume Specification (X × Y × Z)	5 _{pts} × 5 _{pts} × 7 _{pts} , 28 mm × 28 mm × 30 mm; Resolution: 7 mm × 7 mm × 5 mm
SAR _{Ig} [W/Kg]	4.54
SAR _s [W/Kg]	7.43

* All SAR values in 10.3.1 are normalized to a forward power of 1 W.

ULTRATECH GROUP OF LABS

3000 Bristol Circle, Oakville, Ontario, Canada L6H 6G4
 Tel. #: 905-829-1570, Fax. #: 905-829-8050, Email: vic@ultratech-labs.com, Website: http://www.ultratech-labs.com

File #: MIS-053-SAR
March 27, 2006

- Assessed by ITI (UK) Competent Body, NVLAP (USA) Accreditation Body & ACA/AUSTEL (Australia), VCCI (Japan)
- Accredited by Industry Canada (Canada) under ACC-LAB (Europe/Canada MRA and APEC/Canada MRA)
- Recognized/Listed by FCC (USA)
- All test results contained in this engineering test report are traceable to National Institute of Standards and Technology (NIST)

SPECIFIC ABSORPTION RATE (SAR)

IEEE C95.1-1991, FCC OET Bulletin 65 (Supplement C), Industry Canada RSS-102(Issue 2) and ACA Radiocommunications (Electromagnetic Radiation – Human Exposure) Amendment Standard 2000 (No. 1)

NBS55XX M/N: NBS55XXTXXX

FCC ID: O3JNBS55XXT

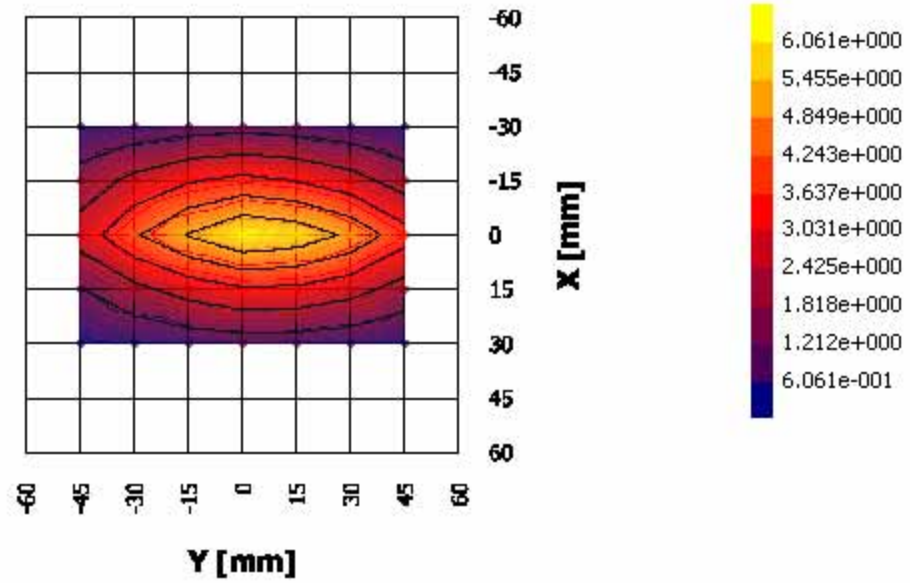

ULTRATECH GROUP OF LABS

3000 Bristol Circle, Oakville, Ontario, Canada L6H 6G4
Tel. #: 905-829-1570, Fax. #: 905-829-8050, Email: vic@ultratech-labs.com, Website: http://www.ultratech-labs.com

File #: MIS-053-SAR
March 27, 2006

- Assessed by ITI (UK) Competent Body, NVLAP (USA) Accreditation Body & ACA/AUSTEL (Australia), VCCI (Japan)
- Accredited by Industry Canada (Canada) under ACC-LAB (Europe/Canada MRA and APEC/Canada MRA)
- Recognized/Listed by FCC (USA)
- All test results contained in this engineering test report are traceable to National Institute of Standards and Technology (NIST)

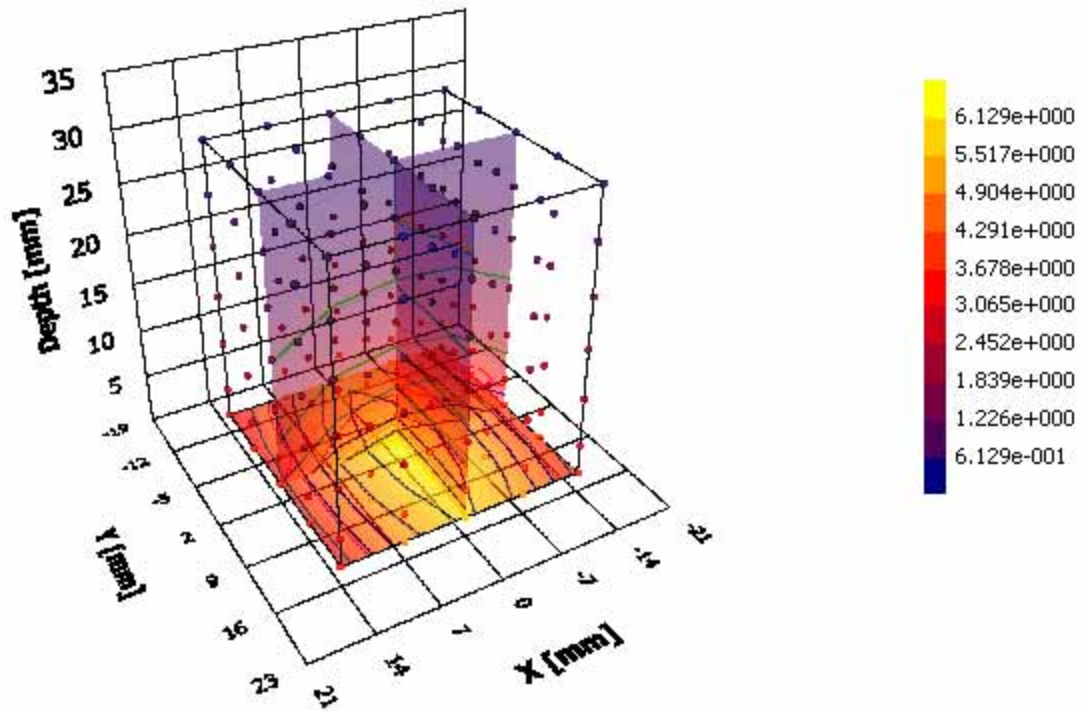

ULTRATECH GROUP OF LABS

3000 Bristol Circle, Oakville, Ontario, Canada L6H 6G4
Tel. #: 905-829-1570, Fax. #: 905-829-8050, Email: vic@ultratech-labs.com, Website: http://www.ultratech-labs.com

File #: MIS-053-SAR
March 27, 2006

- Assessed by ITI (UK) Competent Body, NVLAP (USA) Accreditation Body & ACA/AUSTEL (Australia), VCCI (Japan)
- Accredited by Industry Canada (Canada) under ACC-LAB (Europe/Canada MRA and APEC/Canada MRA)
- Recognized/Listed by FCC (USA)
- All test results contained in this engineering test report are traceable to National Institute of Standards and Technology (NIST)

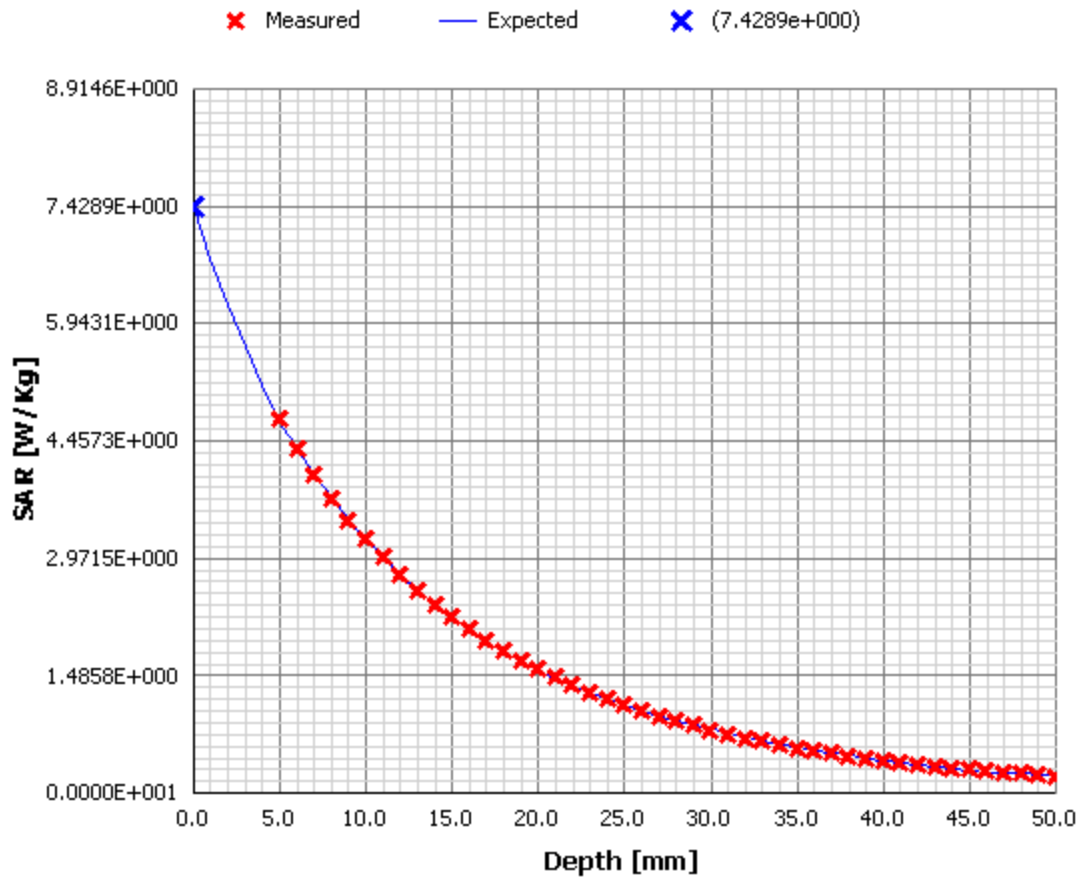

ULTRATECH GROUP OF LABS

3000 Bristol Circle, Oakville, Ontario, Canada L6H 6G4
Tel. #: 905-829-1570, Fax. #: 905-829-8050, Email: vic@ultratech-labs.com, Website: http://www.ultratech-labs.com

File #: MIS-053-SAR
March 27, 2006

- Assessed by ITI (UK) Competent Body, NVLAP (USA) Accreditation Body & ACA/AUSTEL (Australia), VCCI (Japan)
- Accredited by Industry Canada (Canada) under ACC-LAB (Europe/Canada MRA and APEC/Canada MRA)
- Recognized/Listed by FCC (USA)
- All test results contained in this engineering test report are traceable to National Institute of Standards and Technology (NIST)

10.3.3. Reference SAR values for simulated brain tissue at 1900 MHz*

Reference SAR _{Ig} [W/Kg]	39.7
Reference SAR _s [W/Kg]	72.1
Measured SAR _{Ig} [W/Kg]	38.1
Measured SAR _s [W/Kg]	68.8

10.3.4. Verification result at 1900 MHz

Test date [MM/DD/YYYY]	03/20/2006
Test by	JaeWook Choi
Room temperature [°C]	21
Room humidity [%]	40
Simulated tissue temperature [°C]	21
Test frequency [MHz]	1900
E-field Probe	M/N: ET20, S/N: 03JUN-0028, Sensor Offset: 2.0 mm
Sensor Factor (η_{pd}) [mV/(mW/cm ²)]	10.8
Amplifier Settings (AS ₁ , AS ₂ , AS ₃)	0.0062748828, 0.0066157645, 0.0060267983
Tissue Type	Brain
Measured conductivity [S/m]	1.39 (-0.7 %)
Measured dielectric constant	40.2 (+0.5 %)
Conversion Factor (γ)	4.724
Sensitivity (ζ) [W/Kg/mV]	1.027E-01
Power [mW]	500 (forward power)
Measurement Volume Specification (X × Y × Z)	7 _{pts} × 7 _{pts} × 7 _{pts} , 30 _{mm} × 30 _{mm} × 30 _{mm} ; Resolution: 5 _{mm} × 5 _{mm} × 5 _{mm}
SAR _{Ig} [W/Kg]	19.05
SAR _s [W/Kg]	34.38

* All SAR values in 10.3.3 are normalized to a forward power of 1 W.

ULTRATECH GROUP OF LABS

3000 Bristol Circle, Oakville, Ontario, Canada L6H 6G4
 Tel. #: 905-829-1570, Fax. #: 905-829-8050, Email: vic@ultratech-labs.com, Website: http://www.ultratech-labs.com

File #: MIS-053-SAR
 March 27, 2006

- Assessed by ITI (UK) Competent Body, NVLAP (USA) Accreditation Body & ACA/AUSTEL (Australia), VCCI (Japan)
- Accredited by Industry Canada (Canada) under ACC-LAB (Europe/Canada MRA and APEC/Canada MRA)
- Recognized/Listed by FCC (USA)
- All test results contained in this engineering test report are traceable to National Institute of Standards and Technology (NIST)

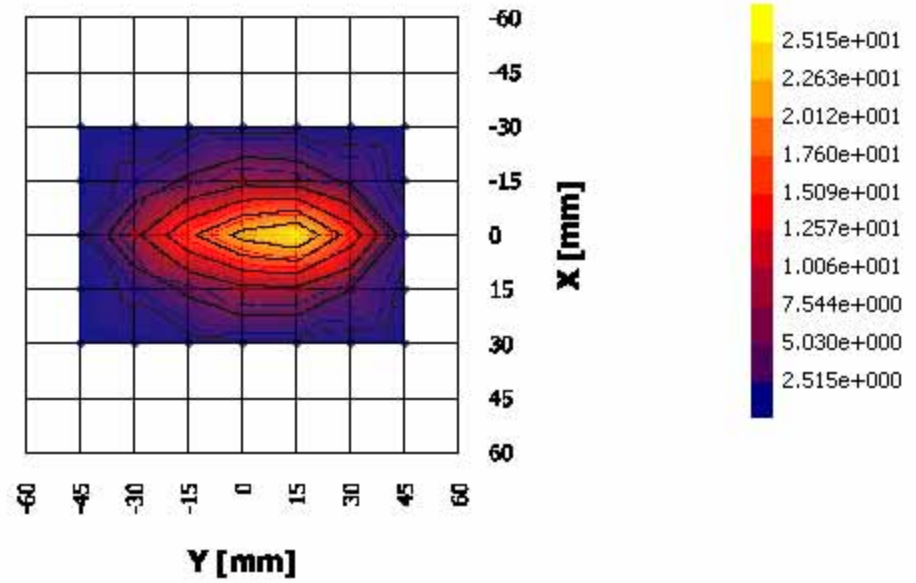

ULTRATECH GROUP OF LABS

3000 Bristol Circle, Oakville, Ontario, Canada L6H 6G4
Tel. #: 905-829-1570, Fax. #: 905-829-8050, Email: vic@ultratech-labs.com, Website: http://www.ultratech-labs.com

File #: MIS-053-SAR
March 27, 2006

- Assessed by ITI (UK) Competent Body, NVLAP (USA) Accreditation Body & ACA/AUSTEL (Australia), VCCI (Japan)
- Accredited by Industry Canada (Canada) under ACC-LAB (Europe/Canada MRA and APEC/Canada MRA)
- Recognized/Listed by FCC (USA)
- All test results contained in this engineering test report are traceable to National Institute of Standards and Technology (NIST)

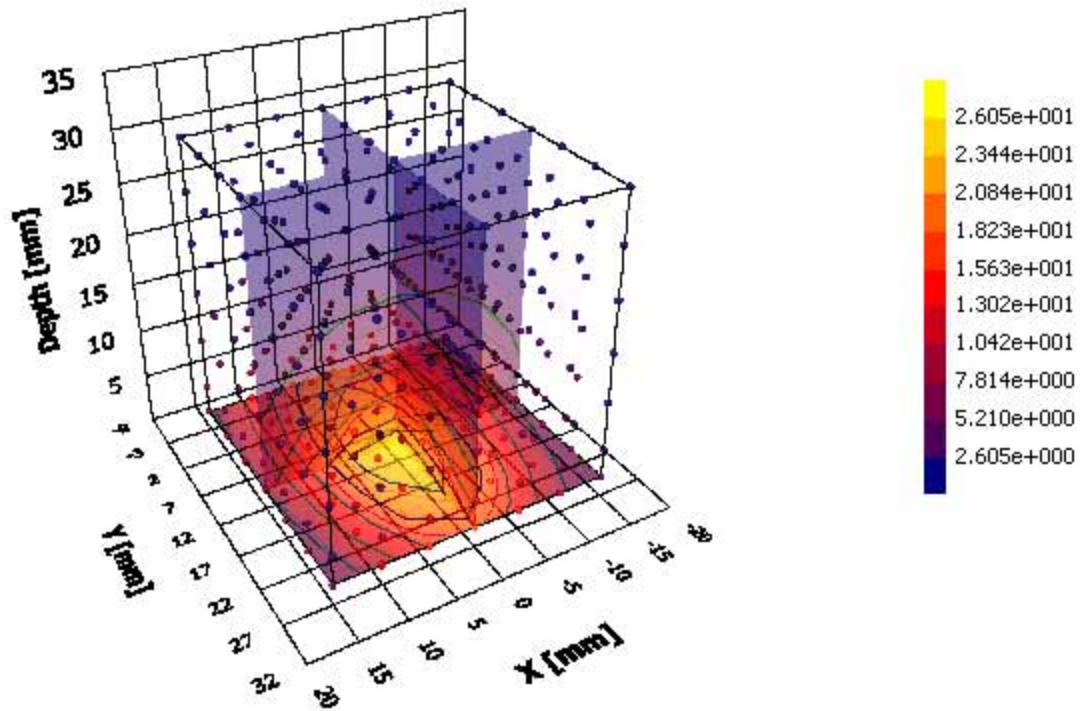

ULTRATECH GROUP OF LABS

3000 Bristol Circle, Oakville, Ontario, Canada L6H 6G4
Tel. #: 905-829-1570, Fax. #: 905-829-8050, Email: vic@ultratech-labs.com, Website: http://www.ultratech-labs.com

File #: MIS-053-SAR
March 27, 2006

- Assessed by ITI (UK) Competent Body, NVLAP (USA) Accreditation Body & ACA/AUSTEL (Australia), VCCI (Japan)
- Accredited by Industry Canada (Canada) under ACC-LAB (Europe/Canada MRA and APEC/Canada MRA)
- Recognized/Listed by FCC (USA)
- All test results contained in this engineering test report are traceable to National Institute of Standards and Technology (NIST)

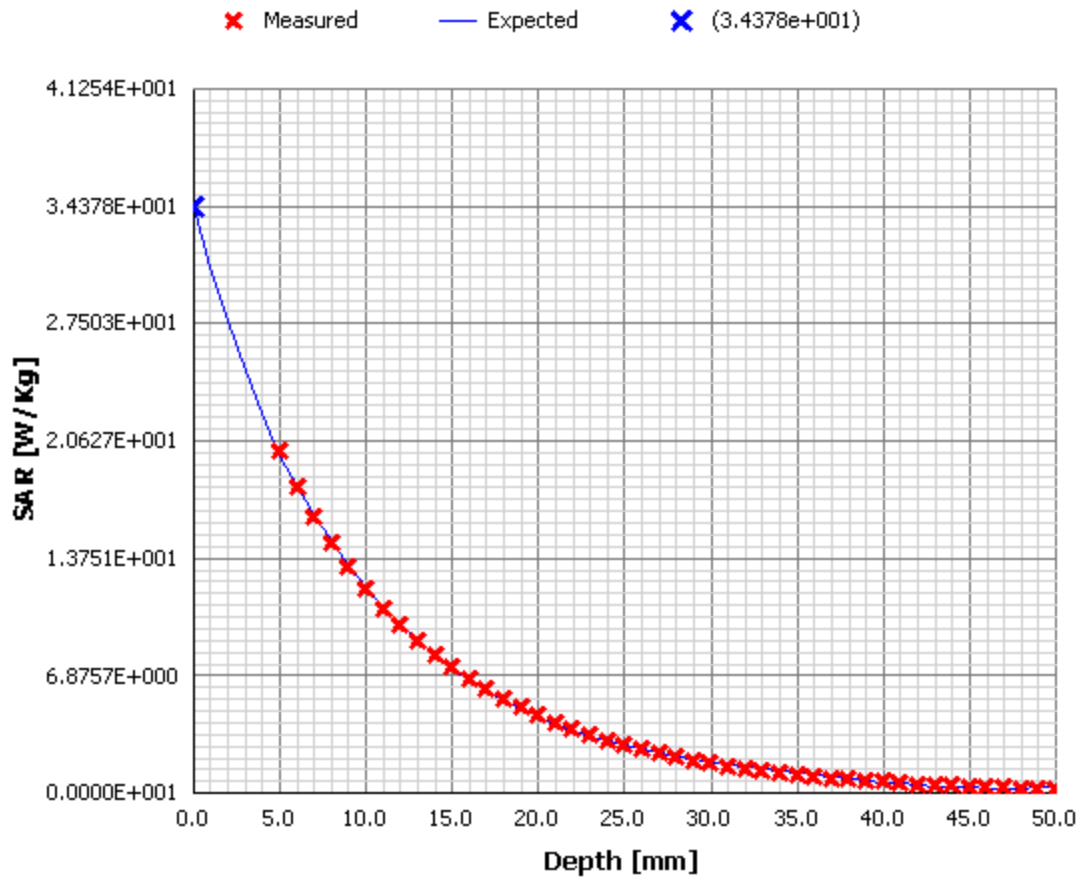

ULTRATECH GROUP OF LABS

3000 Bristol Circle, Oakville, Ontario, Canada L6H 6G4
Tel. #: 905-829-1570, Fax. #: 905-829-8050, Email: vic@ultratech-labs.com, Website: http://www.ultratech-labs.com

File #: MIS-053-SAR
March 27, 2006

- Assessed by ITI (UK) Competent Body, NVLAP (USA) Accreditation Body & ACA/AUSTEL (Australia), VCCI (Japan)
- Accredited by Industry Canada (Canada) under ACC-LAB (Europe/Canada MRA and APEC/Canada MRA)
- Recognized/Listed by FCC (USA)
- All test results contained in this engineering test report are traceable to National Institute of Standards and Technology (NIST)

EXHIBIT 11. SAR CALCULATION SUMMARY

11.1. TERMINOLOGY

$U_{O,i}$	Probe raw output for channel i
$U_{L,i}$	Linearized probe output for channel i
DCP_i	Diode Compression Potential; Diode specific compression factor for channel i
$R_{ISO,i,1}$	Isotropic correction factor normalized to channel 1
AS_i	Amplifier Setting for channel i
η_{pd}	Sensor Factor to the uniform power density, an arbitrary value 10.8 [mV/(mW/cm ²)]
η_{E2}	Sensor Factor to the uniform $ E ^2$, an arbitrary value 10.8/3,770 [mV/(V/m) ²]
$U_{L,1,peak}$	Peak linearized probe output recorded for channel 1 by a rotation about the probe axis with the probe in a test cell
φ	Smaller angle between the probe axis and the direction of the E-field (i.e. 90° when the probe axis is parallel to the plane of the septum inside TEM cell)
ϕ_i	Smaller angle between the probe axis and the dipole sensor axis of the channel i ($\phi_1 = \phi_2 = 45^\circ, \phi_3 = 90^\circ$ for I-beam probe, and $\phi_1 = \phi_2 = \phi_3 = 54.7^\circ$ for triangular-beam probe)
Pd	Well-defined power density [mW/cm ²] at the calibration point in a test cell
$PO_{tot_solution}$	Probe output [mV] in the simulated tissue
PO_{tot_air}	Probe output [mV] in the air ($Z_{air} = 377[\Omega]$)
S.B.T.A.F.	Source-based Time-average Factor

11.1.1. Sensor factor(η_{pd} and η_{E2}) in the air ($Z_0 = 377[\Omega]$)

$$\eta_{Pd} = 10.8 [mV / (mW / cm^2)^2] \equiv \eta_{E2} = \frac{10.8}{3,770} [mV / (V / m)^2]$$

$$Pd [mW / cm^2] = \frac{PO_{tot}}{\eta_{Pd}}, |E|^2 [(V / m)^2] = \frac{PO_{tot}}{\eta_{E2}} \text{ and } SAR [W / Kg] = \frac{\sigma \times PO_{tot}}{\rho}$$

11.1.2. Diode Compensation (Linearity correction)

$$U_{L,i} = U_{O,i} + \frac{U_{O,i}^2}{DCP_i}$$

11.1.3. Amplifier settings(AS_i) and probe output

$$R_{ISO,i,1} = \frac{\sum_{\theta}^{360^\circ} U_{L,1}(\theta)}{\sum_{\theta} U_{L,i}(\theta)}$$

- Assessed by ITI (UK) Competent Body, NVLAP (USA) Accreditation Body & ACA/AUSTEL (Australia), VCCI (Japan)
- Accredited by Industry Canada (Canada) under ACC-LAB (Europe/Canada MRA and APEC/Canada MRA)
- Recognized/Listed by FCC (USA)
- All test results contained in this engineering test report are traceable to National Institute of Standards and Technology (NIST)

$$AS_i = \eta_{Pd} [mV / (mW / cm^2)] \times Pd [mW / cm^2] \times \cos^2(\varphi - \phi_i) \times \frac{R_{ISO,i,1}}{U_{L,1,peak}}$$

$$PO_i [mV] = U_{L,i} \times AS_i$$

$$|E_i|^2 [(V/m)^2] = \frac{PO_i [mV]}{\eta_{E2} [mV / (V/m)^2]} = \frac{U_{L,i} \times AS_i}{\eta_{E2} [mV / (V/m)^2]}$$

$$|E|^2 [(V/m)^2] = \sum_i^3 |E_i|^2 = \frac{1}{\eta_{E2}} \times \sum_i^3 PO_i = \frac{PO_{tot}}{\eta_{E2}} = \frac{1}{\eta_{E2}} \times \sum_i^3 (U_{L,i} \times AS_i)$$

$$|E|^2 [(V/m)^2] = \frac{PO_{tot} [mV]}{\eta_{E2} [mV / (V/m)^2]}, \text{ and } Pd [mW / cm^2] = \frac{PO_{tot} [mV]}{\eta_{Pd} [mV / (mW / m^2)]}$$

11.1.4. Conversion factor (γ) in the simulated tissue

$$|E_{solution}|^2 [(V/m)^2] = \frac{PO_{tot_solution} [mV]}{\eta_{E2} [mV / (V/m)^2]} \times \frac{1}{\gamma}$$

11.1.5. Conversion factor (γ) Calculation #1 – Thermal Transfer Calibration (Below 1 GHz)

$$SAR_t = SAR_{solution} = \frac{\sigma_{@cal} \times |E_{solution}|^2}{\rho_{solution}}$$

$$\text{,thus } |E_{solution}|^2 = \frac{SAR_t \times \rho_{solution}}{\sigma_{@cal}} = \frac{PO_{tot_solution}}{\eta_{E2}} \times \frac{1}{\gamma}$$

$$\gamma = \frac{PO_{tot_solution}}{\eta_{E2}} \times \frac{\sigma_{@cal}}{SAR_t \times \rho_{solution}} = \frac{PO_{tot_solution}}{\eta_{E2}} \times \frac{\sigma_{@cal}}{\left(c \times \frac{\Delta T}{\Delta t}\right) \times \rho_{solution}}$$

$$= \frac{\sigma_{@cal}}{\eta_{E2} \times c \times \rho_{solution}} \times \frac{PO_{tot_solution}}{\left(\frac{\Delta T}{\Delta t}\right)} = \frac{\sigma_{@cal}}{\eta_{E2} \times c \times \rho_{solution}} \times \frac{\frac{\delta}{\delta P} PO_{tot_solution}}{\frac{\delta}{\delta P} \left(\frac{\Delta T}{\Delta t}\right)}$$

- Assessed by ITI (UK) Competent Body, NVLAP (USA) Accreditation Body & ACA/AUSTEL (Australia), VCCI (Japan)
- Accredited by Industry Canada (Canada) under ACC-LAB (Europe/Canada MRA and APEC/Canada MRA)
- Recognized/Listed by FCC (USA)
- All test results contained in this engineering test report are traceable to National Institute of Standards and Technology (NIST)

11.1.6. Conversion factor (γ) Calculation #2 – Calculable Waveguide Calibration (Above 1 GHz)

$$SAR(z) = SAR_{solution} = \frac{\sigma_{@cal} \times |E_{solution}|^2}{\rho_{solution}}$$

$$\text{,thus } |E_{solution}|^2 = \frac{SAR(z) \times \rho_{solution}}{\sigma_{@cal}} = \frac{PO_{tot_solution}}{\eta_{E2}} \times \frac{1}{\gamma}$$

$$\gamma = \frac{PO_{tot_solution}}{\eta_{E2}} \times \frac{\sigma_{@cal}}{SAR(z) \times \rho_{solution}} = \frac{PO_{tot_solution}}{\eta_{E2}} \times \frac{\sigma_{@cal}}{\frac{4(P_f - P_b)}{\rho_{solution} ab \delta_{measured}} e^{-2z/\delta_{measured}} \times \rho_{solution}}$$

$$= \frac{PO_{tot_solution} \times \sigma_{@cal} \times a \times b \times \delta_{measured}}{\eta_{E2} \times 4(P_f - P_b) \times e^{-2z/\delta_{measured}}}$$

11.1.7. Sensitivity (ζ) in the simulated tissue

$$\zeta[W / Kg / mV] = \frac{\sigma_{@meas} [S / m]}{\rho_{head} [Kg / m^3]} \times \frac{1}{\eta_{E2} [mV / (V / m)^2] \times \gamma}$$

11.1.8. SAR calculation

$$SAR[W / Kg] = \zeta[W / Kg / mV] \times PO_{tot_solution} [mV] \times S.B.T.A.F.$$

- Assessed by ITI (UK) Competent Body, NVLAP (USA) Accreditation Body & ACA/AUSTEL (Australia), VCCI (Japan)
- Accredited by Industry Canada (Canada) under ACC-LAB (Europe/Canada MRA and APEC/Canada MRA)
- Recognized/Listed by FCC (USA)
- All test results contained in this engineering test report are traceable to National Institute of Standards and Technology (NIST)