

**FCC PART 22 TYPE APPROVAL
EMI MEASUREMENT AND TEST REPORT**

For

INGENICO CANADA LTD

79 Torbarrie Road, Toronto
Ontario M3L 1G5, Canada

FCC ID: O34E790CDMA

This Report Concerns: <input checked="" type="checkbox"/> Class II Permissive Change	Equipment Type: Wireless Point of Sale Terminal
Test Engineer: <u>Ling Zhang</u>	
Report No.: <u>R0402233</u>	
Report Date: <u>2004-04-08</u>	
Reviewed By: <u>Hans Mellberg</u>	
Prepared By: Bay Area Compliance Laboratory Corporation (BACL) 230 Commercial Street Sunnyvale, CA 94085 Tel: (408) 732-9162 Fax: (408) 732 9164	

Note: This test report is specially limited to the above client company and the product model only. It may not be duplicated without prior written consent of Bay Area Compliance Laboratory Corporation. This report **must not** be used by the client to claim product endorsement by NVLAP or any agency of the U.S. Government.

TABLE OF CONTENTS

GENERAL INFORMATION.....4

 PRODUCT DESCRIPTION FOR EQUIPMENT UNDER TEST (EUT)4

 OBJECTIVE4

 RELATED SUBMITTAL(S)/GRANT(S).....4

 TEST METHODOLOGY4

 TEST FACILITY5

SYSTEM TEST CONFIGURATION.....6

 JUSTIFICATION6

 BLOCK DIAGRAM.....6

 EQUIPMENT MODIFICATIONS6

 LOCAL SUPPORT EQUIPMENT LIST AND DETAILS6

 POWER SUPPLY INFORMATION.....6

 CONFIGURATION OF TEST SYSTEM7

 TEST SETUP BLOCK DIAGRAM.....7

SUMMARY OF TEST RESULTS8

§2.1047 - MODULATION CHARACTERISTIC9

 APPLICABLE STANDARD9

 TEST PROCEDURE9

 TEST EQUIPMENT LIST AND DETAILS.....9

 ENVIRONMENTAL CONDITIONS9

 TEST RESULTS9

§2.1053 - SPURIOUS RADIATED EMISSIONS.....11

 APPLICABLE STANDARD11

 TEST PROCEDURE11

 TEST EQUIPMENT LIST AND DETAILS.....11

 ENVIRONMENTAL CONDITIONS11

 TEST RESULT12

§2.1046, §22.913(A) - RF POWER OUTPUT.....13

 APPLICABLE STANDARD13

 TEST PROCEDURE13

 TEST EQUIPMENT LIST AND DETAILS.....14

 ENVIRONMENTAL CONDITIONS14

 TEST RESULTS14

§2.1046, §22.913(A) – CONDUCTED OUTPUT POWER.....15

 APPLICABLE STANDARD15

 TEST PROCEDURE15

 TEST EQUIPMENT LIST AND DETAILS.....15

 ENVIRONMENTAL CONDITIONS15

 TEST RESULTS15

§2.1049, §22.917(D) - OCCUPIED BANDWIDTH.....17

 APPLICABLE STANDARD17

 TEST PROCEDURE17

 TEST EQUIPMENT LIST AND DETAILS.....17

 ENVIRONMENTAL CONDITIONS17

 TEST RESULTS17

§2.1051, §22.917 - SPURIOUS EMISSIONS AT ANTENNA TERMINALS.....20

 APPLICABLE STANDARD20

 TEST PROCEDURE20

 TEST EQUIPMENT LIST AND DETAILS.....20

 ENVIRONMENTAL CONDITIONS20

 TEST RESULTS20

§2.1055 (A), §2.1055 (D), §22.355 - FREQUENCY STABILITY	24
APPLICABLE STANDARD	24
TEST PROCEDURE	24
TEST EQUIPMENT LIST AND DETAILS.....	24
ENVIRONMENTAL CONDITIONS	25
TEST RESULTS	25
§22.917 – BAND EDGE.....	26
APPLICABLE STANDARD	26
TEST PROCEDURE	26
TEST EQUIPMENT LIST AND DETAILS.....	26
ENVIRONMENTAL CONDITIONS	26
TEST RESULTS	26

GENERAL INFORMATION

Product Description for Equipment Under Test (EUT)

The *Ingenico Canada Ltd.* 's product, FCC ID:O34E790CDMA, model: *Elite 790 CDMA* or the "EUT" as referred to in this report is a Wireless Point of Sale Terminal, which is measured approximately 8.25'L x 3.5'W x 3'H. The ELITE 790 is a portable payment terminal for a radio transmission module (voice + data) using the CDMA standard.

** The test data gathered are from typical production sample, serial number: 34600341-00300013, provided by the manufacturer.*

Objective

This type approval report is prepared on behalf of *INGENICO CANADA LTD* in accordance with Part 2, Subpart J, Part 22 Subpart H of the Federal Communication Commissions rules.

This is a C2PC application. The original application was granted on 2004-02-25. The device has been previously certified with the PCS band 1851.25 - 1908.752MHz. Now the manufacturer would like to enable the CDMA cellular band 824.73 – 848.19MHz. There is no hardware change on the device.

The objective is to determine compliance with FCC rules for output power, modulation characteristic, occupied bandwidth, spurious emission at antenna terminal, field strength of spurious radiation, frequency stability, and conducted and radiated margin.

Related Submittal(s)/Grant(s)

The original application was originally granted on 2004-02-25. Please refer to BACL report R0312229 for the details of the original application.

Test Methodology

All tests and measurements indicated in this document were performed in accordance with the Code of Federal Regulations Title 47 Part 2, Sub-part J as well as the following parts:

Part 15 Subpart B – Unintentional Radiators
Part 22 Subpart H - Public Mobile Services

Applicable Standards: TIA EIA 137-A, TIA EIA 98-C, ANSI 63.4-1992, American National Standard for Methods of Measurement of Radio-Noise Emissions from Low-Voltage Electrical and Electronic Equipment in the range of 9 kHz to 40 GHz.

All radiated and conducted emissions measurement was performed at Bay Area Compliance Laboratory, Corp. The radiated testing was performed at an antenna-to-EUT distance of 3 meters.

Test Facility

The Open Area Test site used by BAACL Corp. to collect radiated and conducted emission measurement data is located in the back parking lot of the building at 230 Commercial Street, Sunnyvale, California, USA.

Test site at BAACL Corp. has been fully described in reports submitted to the Federal Communication Commission (FCC) and Voluntary Control Council for Interference (VCCI). The details of these reports has been found to be in compliance with the requirements of Section 2.948 of the FCC Rules on February 11 and December 10, 1997 and Article 8 of the VCCI regulations on December 25, 1997. The facility also complies with the radiated and AC line conducted test site criteria set forth in ANSI C63.4-1992.

The Federal Communications Commission and Voluntary Control Council for Interference has the reports on file and is listed under FCC file 31040/SIT 1300F2 and VCCI Registration No.: C-1298 and R-1234. The test site has been approved by the FCC and VCCI for public use and is listed in the FCC Public Access Link (PAL) database.

Additionally, BAACL is a National Institute of Standards and Technology (NIST) accredited laboratory, under the National Voluntary Laboratory Accredited Program (Lab Code 200167-0). The scope of the accreditation covers the FCC Method - 47 CFR Part 15 - Digital Devices, CISPR 22: 1997, Electromagnetic Interference - Limits and Methods of Measurement of Information Technology Equipment test methods.

SYSTEM TEST CONFIGURATION

Justification

The EUT was configured for testing according to ANSI C63.4-2001.

The final qualification test was performed with the EUT operating at normal mode.

Block Diagram

Please refer to Exhibit D.

Equipment Modifications

No modifications were made to the EUT.

Local Support Equipment List and Details

Manufacturer	Description	Model	Serial Number	FCC ID
Anritsu	Base Simulator	MT8802A	None	None

Power Supply Information

Manufacturer	Description	Model	Serial Number	FCC ID
INGENICO CANADA LTD	AC Adapter	SA120A-1216U-S	ALI0102	N/A

Configuration of Test System

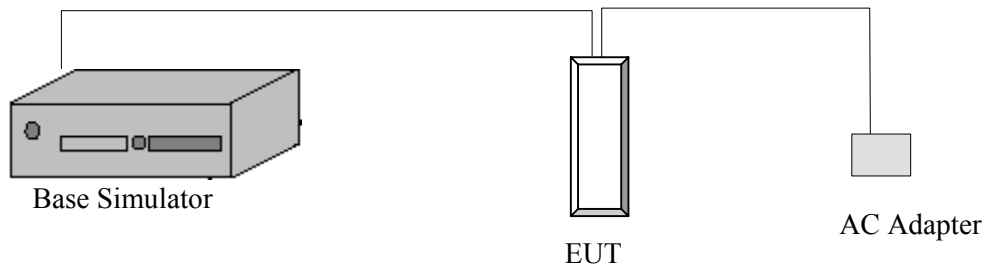

Test Setup Block Diagram

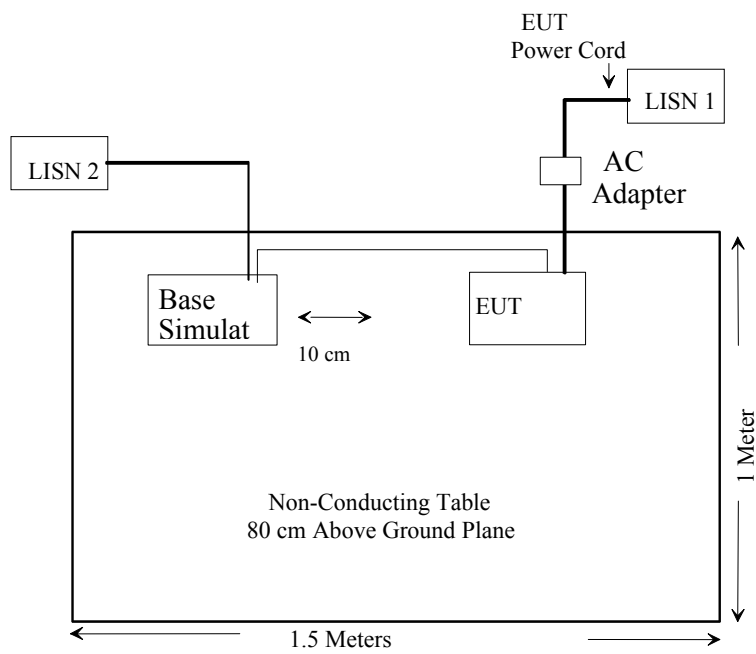

SUMMARY OF TEST RESULTS

Results reported relate only to the product tested, serial number: 34600341-00300013.

FCC RULE	DESCRIPTION OF TEST	RESULT
§ 2.1047	Modulation Characteristics	Compliant
§ 2.1053	Field Strength of Spurious Radiation	Compliant
§2.1093	RF Exposure	Compliant
§ 15.107	Conducted Emissions	N/A
§ 2.1046, § 22.913 (a)	RF Output Power	Compliant
§ 2.1046	Conducted Output Power	Compliant
§ 2.1049 § 22.917 § 22.905	Out of Band Emission, Occupied Bandwidth	Compliant
§ 2.1051, § 22.917	Spurious Emissions at Antenna Terminals	Compliant
§ 2.1055 (a) § 2.1055 (d) § 22.355	Frequency stability vs. temperature Frequency stability vs. voltage	Compliant
§ 22.917	Band Edge	Compliant

§2.1047 - MODULATION CHARACTERISTIC

Applicable Standard

Requirement: FCC § 2.1047.

Test Procedure

CDMA digital mode is used by EUT.

Test Equipment List and Details

Manufacturer	Description	Model	Serial Number	Cal. Date
HP	Spectrum Analyzer	HP8564E	3943A01781	2003-08-01
HP	Plotter	HP7470A	2541A49659	Not Required

* **Statement of Traceability: BACL Corp.** certifies that all calibrations have been performed in accordance to NVLAP requirements, traceable to the NIST.

Environmental Conditions

Temperature:	24° C
Relative Humidity:	44%
ATM Pressure:	1016 mbar

The testing was performed by Ling Zhang on 2004-03-19.

Test Results

Please refer to the hereinafter plots.

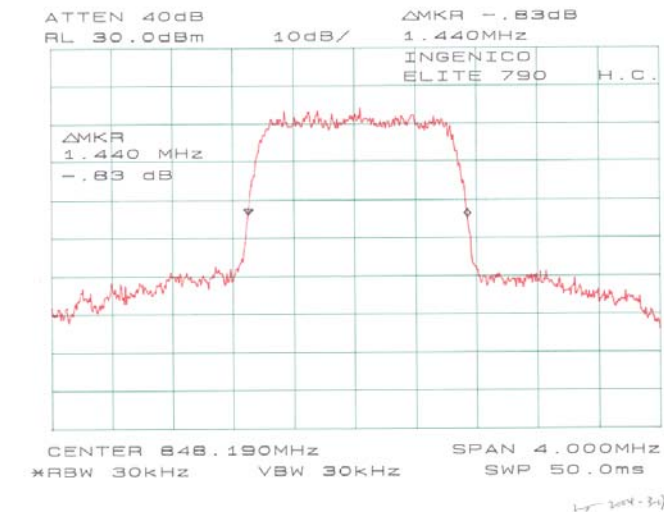
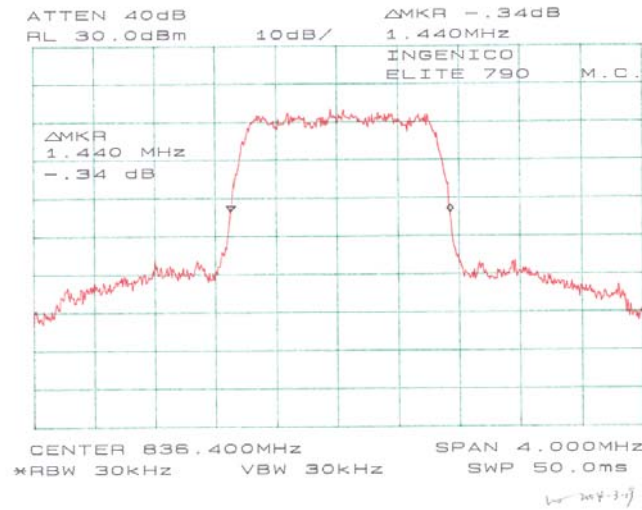
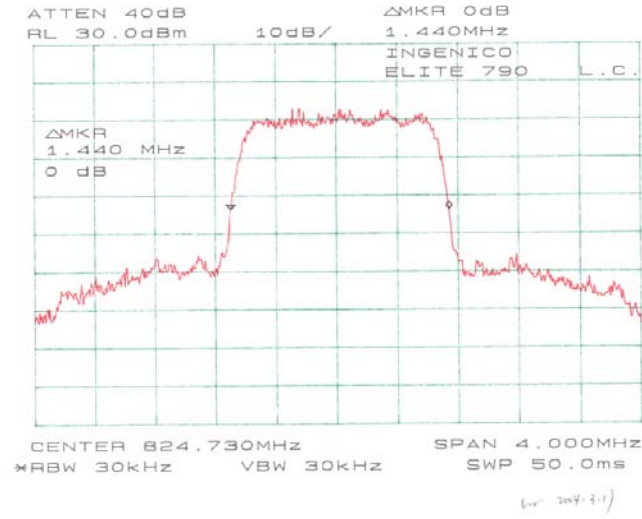

§2.1053 - SPURIOUS RADIATED EMISSIONS

Applicable Standard

Requirements: CFR 47, § 2.1053.

Test Procedure

The transmitter was placed on a wooden turntable, and it was transmitting into a non-radiating load which was also placed on the turntable.

The measurement antenna was placed at a distance of 3 meters from the EUT. During the tests, the antenna height and polarization as well as EUT azimuth were varied in order to identify the maximum level of emissions from the EUT. The test was performed by placing the EUT on 3-orthogonal axis.

The frequency range up to tenth harmonic of the fundamental frequency was investigated.

Remove the EUT and replace it with substitution antenna. A signal generator was connected to the substitution antenna by a non-radiating cable. The absolute levels of the spurious emissions were measured by the substitution.

Spurious emissions in dB = $10 \lg(\text{TXpwr in Watts}/0.001)$ – the absolute level

Spurious attenuation limit in dB = $43 + 10 \text{Log}_{10}(\text{power out in Watts})$

Test Equipment List and Details

Manufacturer	Description	Model	Serial Number	Cal. Date
HP	Amplifier, Microwave	8449B	3147A00400	2003-03-14
HP	Analyzer, Spectrum	8565EC	3946A00131	2003-06-30
A. H. Systems	Antenna, Horn, DRG	SAS-200/571	2455-261	2003-01-08
HP	Amplifier, Pre	8447E	1937A01046	2003-08-02
HP	Amplifier, Pre	8447E	1937A01057	2003-08-04
A.R.A.	Antenna, Horn, DRG	DRG-118/A	1132	2003-09-30
ETS	Antenna, logperiodic	3148	0004-1155	2003-10-11
ETS	Antenna, Biconical	3110B	9603-2315	2003-10-11

* **Statement of Traceability: BACL Corp.** certifies that all calibrations have been performed in accordance to NVLAP requirements, traceable to the NIST.

Environmental Conditions

Temperature:	24° C
Relative Humidity:	44%
ATM Pressure:	1016 mbar

The testing was performed by Ling Zhang on 2004-03-19.

Test Result

Low Frequency: -16.6 dBm at 2474.19 MHz
 Middle Frequency: -15.5 dBm at 2509.2 MHz
 High Frequency: -15.9 dBm at 2544.57 MHz

Indicated		EUT			Substitution		Generator			Standard	
Frequency	Ampl.	Table	Test Antenna		Frequency	Level	Antenna	Cable	Absolute	FCC	FCC
MHz	dBuV/m	Angle	Height	Polar	MHz	dBm	Gain	Loss	Level	Limit	Margin
		Degree	Meter	H/V			Corrected	dB	dBm	dBm	dB
Low Channel											
824.73	120.1	180	1.6	v	824.73	22	0	0.1	21.9		
824.73	118.67	120	1.5	h	824.73	20.7	0	0.1	20.6		
2474.19	39.5	180	1.6	v	2474.19	-36.5	7.6	0.7	-29.6	-13	-16.6
2474.19	38.83	100	1.5	h	2474.19	-37.2	7.6	0.7	-30.3	-13	-17.3
1649.46	36.33	150	1.8	v	1649.46	-38.4	6.8	0.5	-32.1	-13	-19.1
1649.46	36.83	90	1.6	h	1649.46	-38.8	6.8	0.5	-32.5	-13	-19.5
MIDDLE CHANNEL											
836.4	120.83	150	1.5	v	836.4	22.6	0	0.1	22.5		
836.4	119.5	90	1.5	h	836.4	21.4	0	0.1	21.3		
2509.2	40.83	90	1.8	v	2509.2	-35.4	7.6	0.7	-28.5	-13	-15.5
2509.2	39.15	150	1.8	h	2509.2	-36.8	7.6	0.7	-29.9	-13	-16.9
1672.8	37.5	60	1.7	h	1672.8	-37.3	6.8	0.5	-31	-13	-18.0
1672.8	36.17	180	1.6	v	1672.8	-38.5	6.8	0.5	-32.2	-13	-19.2
HIGH CHANNEL											
848.19	120.33	150	1.6	v	848.19	22.2	0	0.1	22.1		
848.19	119.67	180	1.5	h	848.19	21.5	0	0.1	21.4		
2544.57	40.1	200	1.6	v	2544.57	-35.8	7.6	0.7	-28.9	-13	-15.9
2544.57	39.33	60	1.8	h	2544.57	-36.5	7.6	0.7	-29.6	-13	-16.6
1696.38	36.67	90	1.8	v	1696.38	-38.2	6.8	0.5	-31.9	-13	-18.9
1696.38	36.33	180	1.4	h	1696.38	-38.4	6.8	0.5	-32.1	-13	-19.1

§2.1046, §22.913(a) - RF POWER OUTPUT

Applicable Standard

According to FCC §2.1046 & §22.913(a), the ERP of mobile transmitters must not exceed 7 watts.

Test Procedure

1. On a test site, the EUT shall be placed at 1.5m height on a turn table, and in the position closest to normal use as declared by the applicant.
2. The test antenna shall be oriented initially for vertical polarization located 3m from EUT to correspond to the frequency of the transmitter.
3. The output of the test antenna shall be connected to the measuring receiver and the quasi-peak detector is used for the measurement.
4. The transmitter shall be switched on, if possible, without modulation and the measuring receiver shall be tuned to the frequency of the transmitter under test.
5. The test antenna shall be raised and lowered through the specified range of height until a maximum signal level is detected by the measuring receiver.
6. The transmitter shall then be rotated through 360° in the horizontal plane, until the maximum signal level is detected by the measuring receiver.
7. The test antenna shall be raised and lowered again through the specified range of height until a maximum signal level is detected by the measuring receiver.
8. The maximum signal level detected by the measuring receiver shall be noted.
9. The transmitter shall be replaced by a horn (substitution antenna).
10. The substitution antenna shall be orientated for vertical polarization and the length of the substitution antenna shall be adjusted to correspond to the frequency of the transmitter.
11. The substitution antenna shall be connected to a calibrated signal generator.
12. In necessary, the input attenuator setting of the measuring receiver shall be adjusted in order to increase the sensitivity of the measuring receiver.
13. The test antenna shall be raised and lowered through the specified range of height to ensure that the maximum signal is received.
14. The input signal to the substitution antenna shall be adjusted to the level that produces a level detected by the measuring receiver, which is equal to the level noted while the transmitter radiated power was measured, corrected for the change of input attenuator setting of the measuring receiver.
15. The input level to the substitution antenna shall be recorded as power level in dBm, corrected for any change of input attenuator setting of the measuring receiver.
16. The measurement shall be repeated with the test antenna and the substitution antenna orientated for horizontal polarization.
17. The measure of the effective radiated power is the large of the two levels recorded, at the input to the substitution antenna, corrected for gain of the substitution antenna if necessary.

Test Equipment List and Details

Manufacturer	Description	Model	Serial Number	Cal. Date
HP	Amplifier, Microwave	8449B	3147A00400	2003-03-14
HP	Analyzer, Spectrum	8565EC	3946A00131	2003-06-30
A. H. Systems	Antenna, Horn, DRG	SAS-200/571	2455-261	2003-01-08
HP	Amplifier, Pre	8447E	1937A01046	2003-08-02
HP	Amplifier, Pre	8447E	1937A01057	2003-08-04
A.R.A.	Antenna, Horn, DRG	DRG-118/A	1132	2003-09-30
APREL	Antenna Dipole	D900V2	122	2003-03-10
ETS	Antenna, logperiodic	3148	0004-1155	2003-10-11
ETS	Antenna, Biconical	3110B	9603-2315	2003-10-11

* **Statement of Traceability:** **BACL Corp.** certifies that all calibrations have been performed in accordance to NVLAP requirements, traceable to the NIST.

Environmental Conditions

Temperature:	24° C
Relative Humidity:	44%
ATM Pressure:	1016 mbar

The testing was performed by Ling Zhang on 2004-03-19.

Test Results

FREQUENCY (MHZ)	POLAR	SUBSTITUTION READING (dBm)	SUBSTITUTION ANTENNA GAIN	SUBSTITUTION CABLE LOSS (dBm)	ERP (dBm)
824.73	V	22.0	0	0.1	21.9
824.73	H	20.7	0	0.1	20.6
836.4	V	22.6	0	0.1	22.5
836.4	H	21.4	0	0.1	21.3
848.19	V	22.2	0	0.1	22.1
848.19	H	21.5	0	0.1	21.4

Sample calculation:

Absolute level = substitution reading + antenna gain - cable loss

For example:

$$23.5 = 23.6 + 0 - 0.1$$

§2.1046, §22.913(a) – CONDUCTED OUTPUT POWER

Applicable Standard

According to FCC §2.1046 and §22.913 (a), the ERP of mobile transmitters and auxiliary test transmitters must not exceed 7 watts.

Test Procedure

The RF output of the transmitter was connected to the input of the spectrum analyzer through sufficient attenuation.

Test Equipment List and Details

Manufacturer	Description	Model	Serial Number	Cal. Date
HP	Analyzer, Spectrum	8565EC	3946A00131	2003-06-30

* **Statement of Traceability:** **BACL Corp.** certifies that all calibrations have been performed in accordance to NVLAP requirements, traceable to the NIST.

Environmental Conditions

Temperature:	24° C
Relative Humidity:	44%
ATM Pressure:	1016 mbar

The testing was performed by Ling Zhang on 2004-03-19.

Test Results

Channel	Frequency (MHz)	Output Power in dBm	Output Power in W	Limit in W
LOW	824.73	23.50	0.224	7
MIDDLE	836.40	23.67	0.233	7
HIGH	848.19	23.33	0.215	7

Plots of Conducted Output Power for Part 22

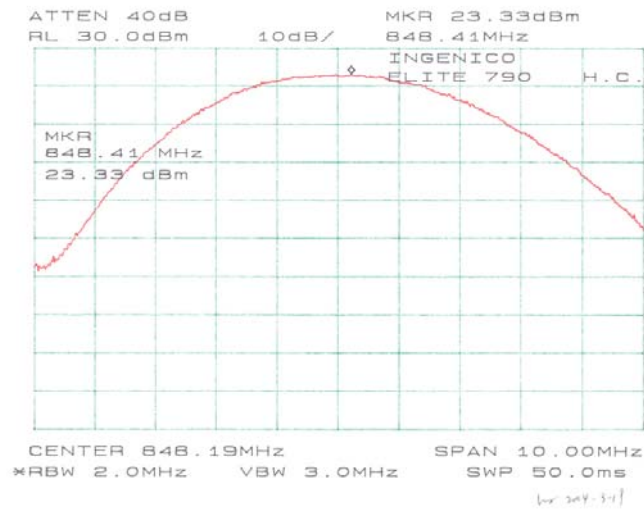
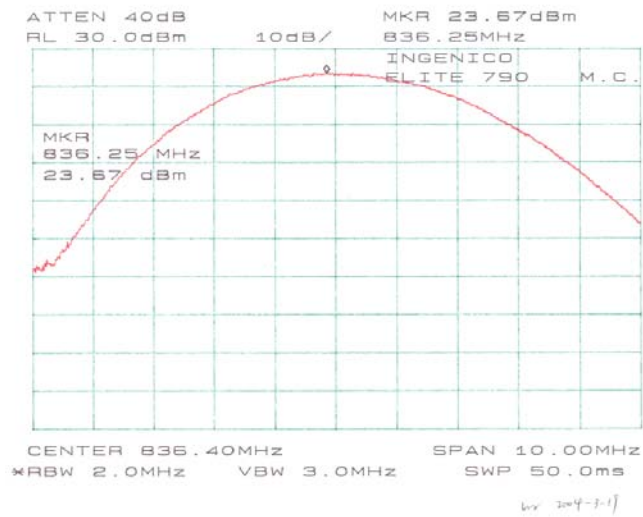
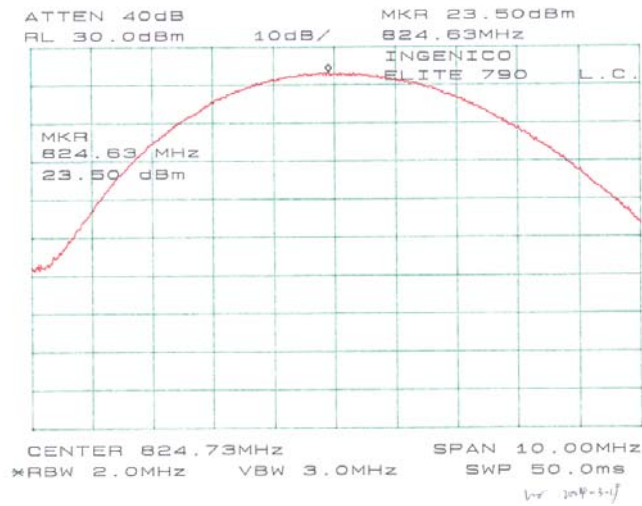

§2.1049, §22.917(d) - OCCUPIED BANDWIDTH

Applicable Standard

Requirements: CFR 47, Section 2.1049 and 22.917(d).

Test Procedure

The RF output of the transmitter was connected to the input of the spectrum analyzer through sufficient attenuation.

The resolution bandwidth of the spectrum analyzer was set at 30 KHz and the 26 dB bandwidth was recorded.

Test Equipment List and Details

Manufacturer	Description	Model	Serial Number	Cal. Date
HP	Spectrum Analyzer	HP8564E	3943A01781	2003-08-01
HP	Plotter	HP7470A	2541A49659	Not Required

* **Statement of Traceability: BACL Corp.** certifies that all calibrations have been performed in accordance to NVLAP requirements, traceable to the NIST.

Environmental Conditions

Temperature:	24° C
Relative Humidity:	44%
ATM Pressure:	1016 mbar

The testing was performed by Ling Zhang on 2004-03-19.

Test Results

26dB Bandwidth:

Channel	Frequency (MHz)	Measurement (MHz)	Result
LOW	824.73	1.440	Compliant
MIDDLE	836.40	1.440	Compliant
HIGH	848.19	1.440	Compliant

Please refer to the following plots.

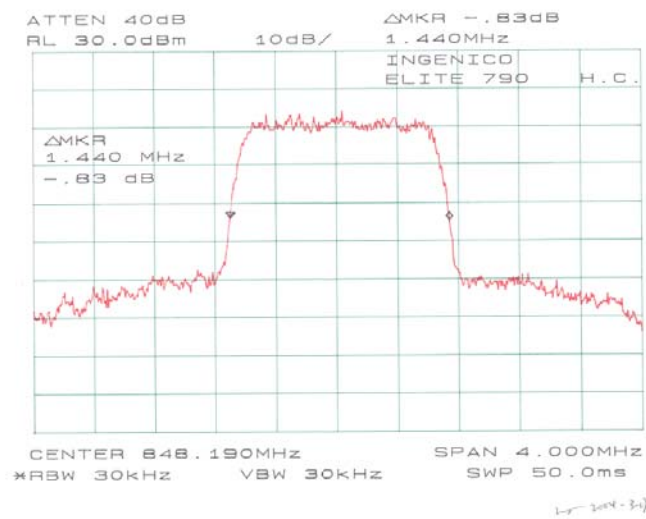

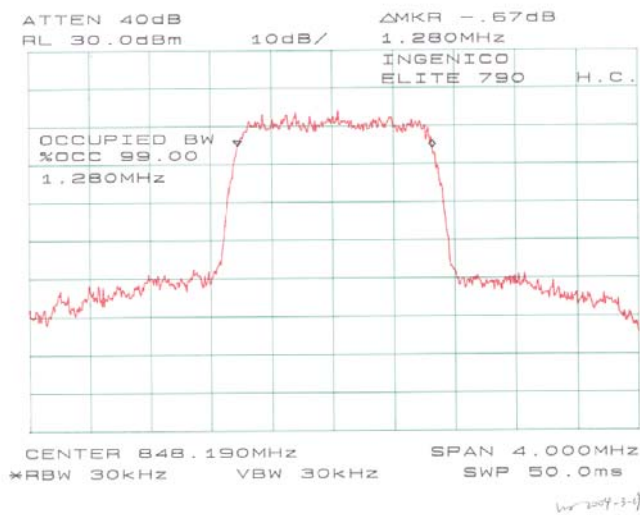
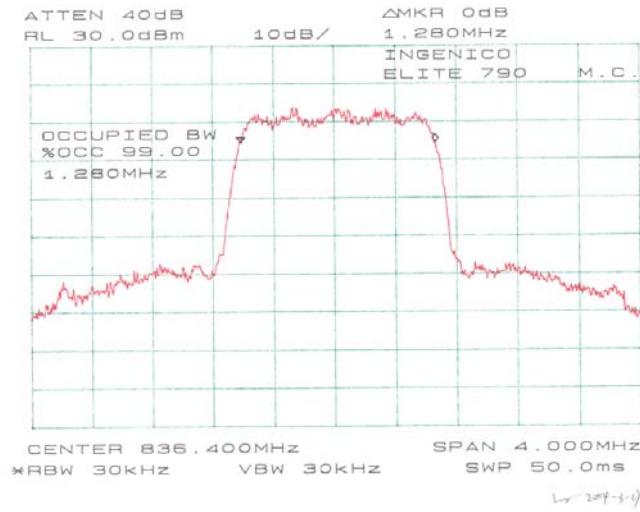
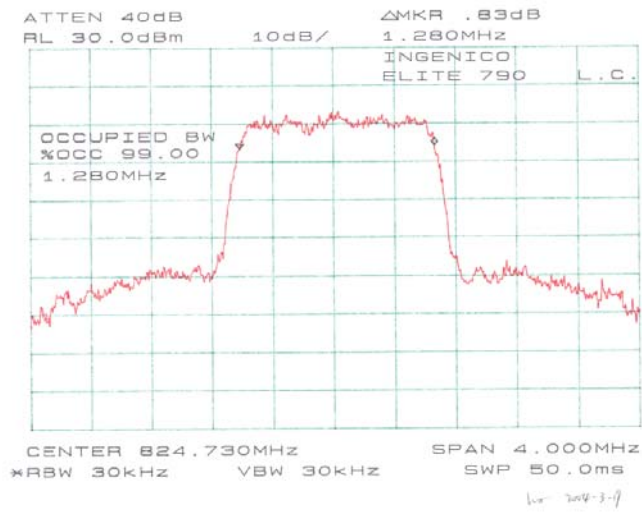

§2.1051, §22.917 - SPURIOUS EMISSIONS AT ANTENNA TERMINALS

Applicable Standard

Requirements: CFR 47, § 2.1051, § 22.917.

The spectrum was to be investigated to the tenth harmonics of the highest fundamental frequency as specified in § 2.1057.

Test Procedure

The RF output of the transceiver was connected to a spectrum analyzer through appropriate attenuation. The resolution bandwidth of the spectrum analyzer was set at 100 kHz. Sufficient scans were taken to show any out of band emissions up to 10th harmonic.

Test Equipment List and Details

Manufacturer	Description	Model	Serial Number	Cal. Date
HP	Spectrum Analyzer	HP8564E	3943A01781	2003-08-01
HP	Plotter	HP7470A	2541A49659	Not Required

* **Statement of Traceability: BACL Corp.** certifies that all calibrations have been performed in accordance to NVLAP requirements, traceable to the NIST.

Environmental Conditions

Temperature:	24° C
Relative Humidity:	44%
ATM Pressure:	1016 mbar

The testing was performed by Ling Zhang on 2004-03-19.

Test Results

Please refer to the hereinafter plots.

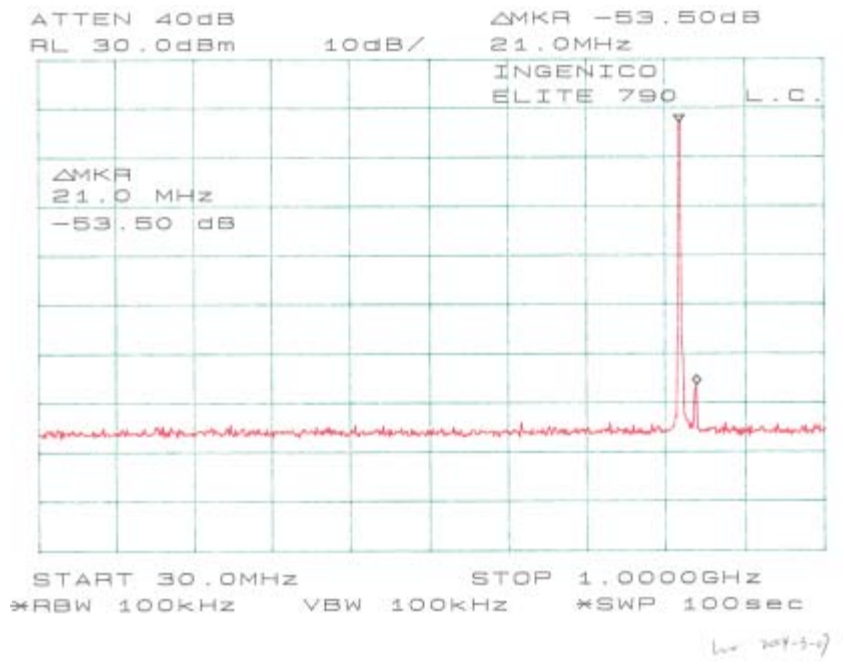
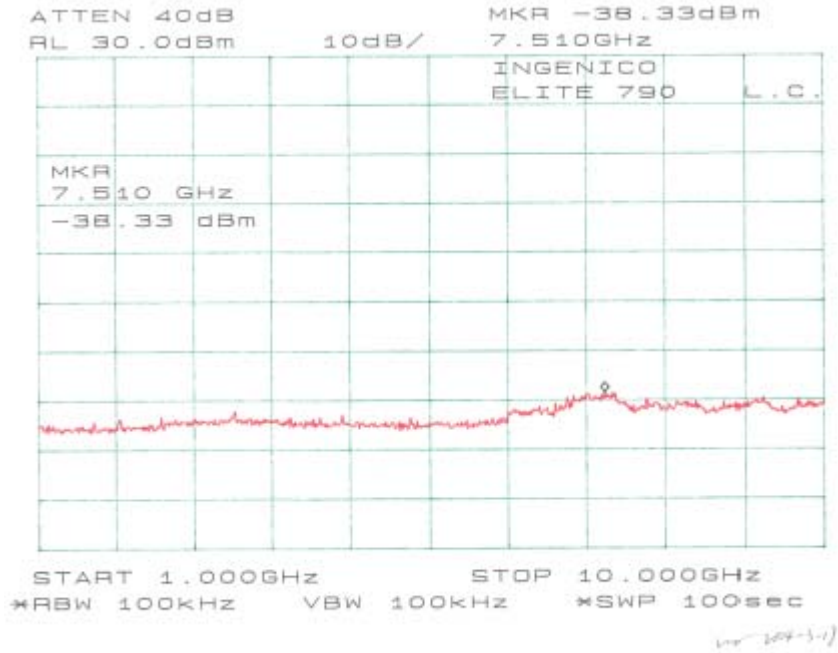

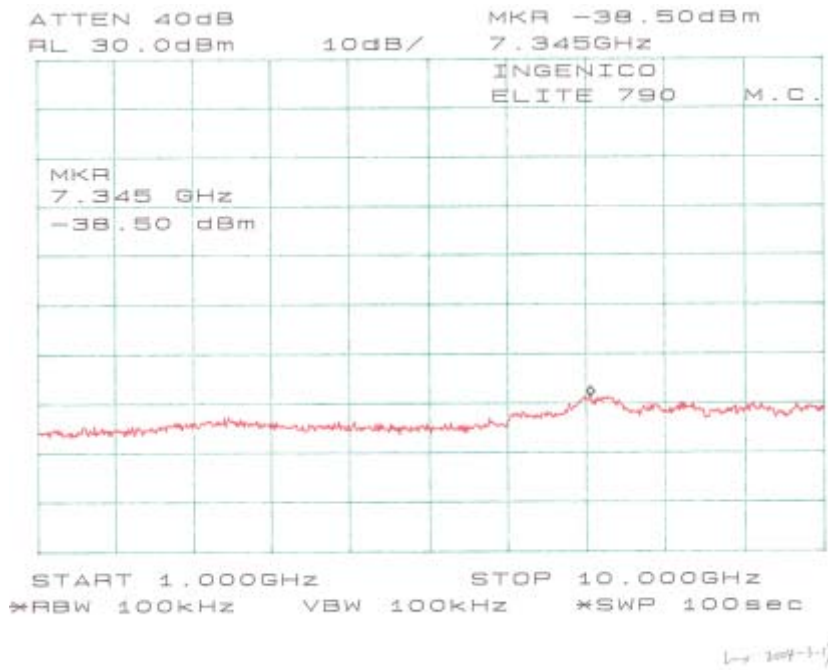
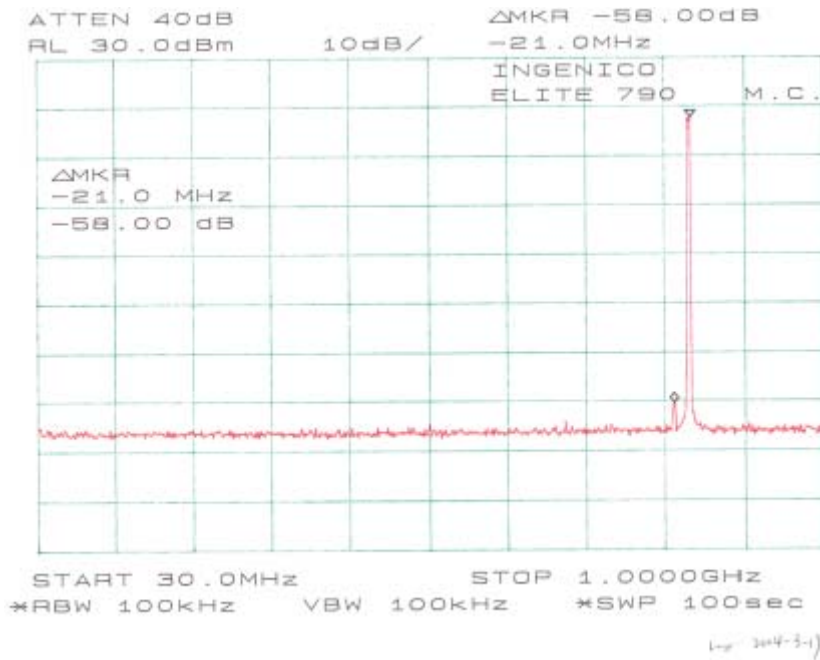

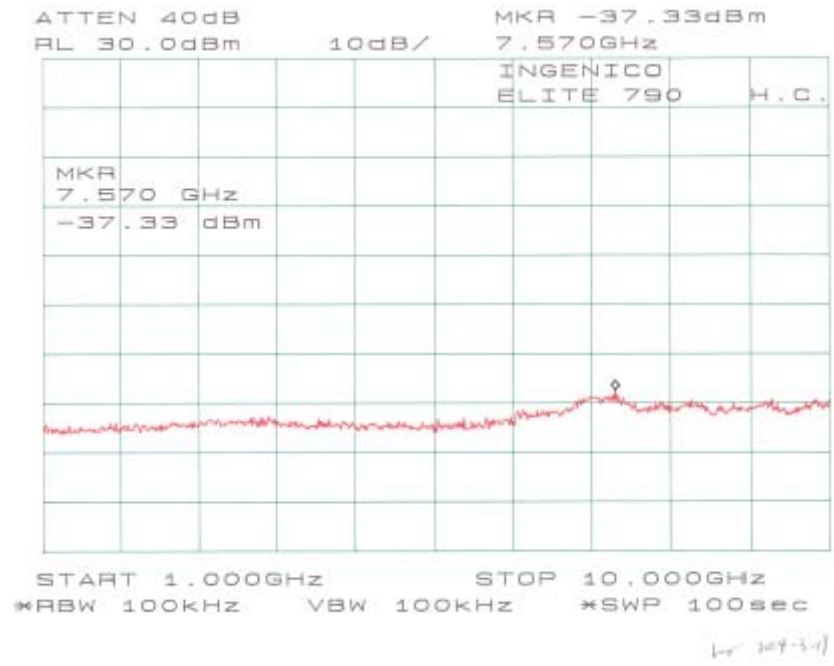
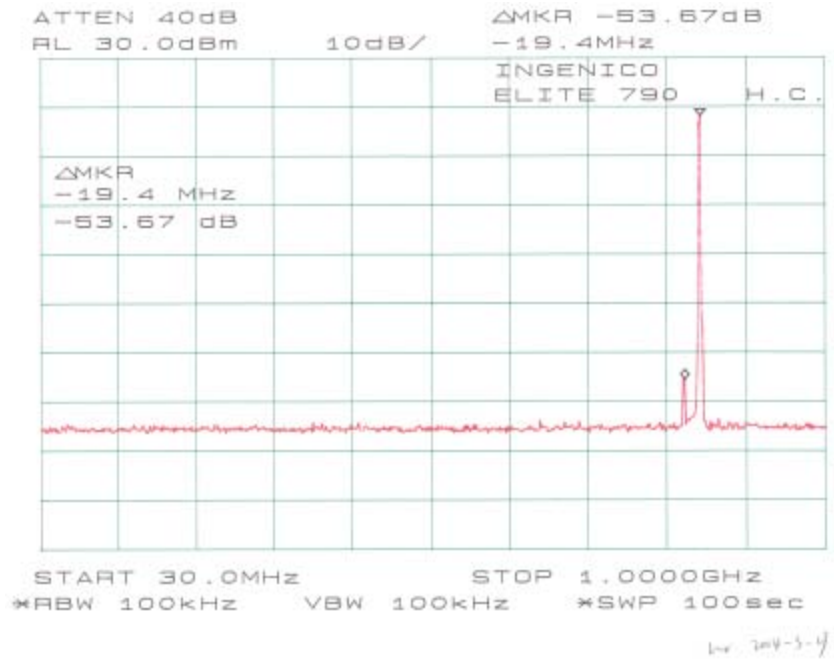

§2.1055 (a), §2.1055 (d), §22.355 - FREQUENCY STABILITY

Applicable Standard

Requirements: FCC § 2.1055 (a), § 2.1055 (d) & following:

According to §22.355, the carrier frequency of each transmitter in the Public Mobile Services must be maintained within the tolerances given in Table C-1 of this section.

Table C-1_Frequency Tolerance for Transmitters in the Public Mobile Services

Frequency range (MHz)	Mobile Base, fixed (ppm)	[SU][le]/ (ppm)	Mobile SU]3 watts [le]3 watts (ppm)
25 to 50.....	20.0	20.0	50.0
50 to 450.....	5.0	5.0	50.0
450 to 512.....	2.5	5.0	5.0
821 to 896.....	1.5	2.5	2.5
928 to 929.....	5.0	n/a	n/a
929 to 960.....	1.5	n/a	n/a
2110 to 2220.....	10.0	n/a	n/a

According to §24.235, The frequency stability shall be sufficient to ensure that the fundamental emission stays within the authorized frequency block.

Test Procedure

Frequency Stability vs. Temperature: The equipment under test was connected to an external DC power supply and the RF output was connected to a frequency counter via feed-through attenuators. The EUT was placed inside the temperature chamber. The DC leads and RF output cable exited the chamber through an opening made for the purpose.

After the temperature stabilized for approximately 20 minutes, the frequency output was recorded from the counter.

Frequency Stability vs. Voltage: An external variable DC power supply was connected to the battery terminals of the equipment under test. The voltage was set to 115% of the nominal value and was then decreased until the transmitter light no longer illuminated; i.e., the battery end point. The output frequency was recorded for each battery voltage.

Test Equipment List and Details

Manufacturer	Description	Model	Serial Number	Cal. Due Date
HP	Spectrum Analyzer	HP8564E	3943A01781	2003-08-01
HP	Plotter	HP7470A	2541A49659	Not Required

* **Statement of Traceability: BACL Corp.** certifies that all calibrations have been performed in accordance to NVLAP requirements, traceable to the NIST.

Environmental Conditions

Temperature:	24° C
Relative Humidity:	44%
ATM Pressure:	1016 mbar

The testing was performed by Ling Zhang on 2004-03-19.

Test Results*Frequency Stability Versus Temperature*

Reference Frequency: 836.4 MHz, Limit: 2.5ppm			
Environment Temperature (°C)	Power Supplied (Vdc)	Frequency Measure with Time Elapsed	
		MHz	PPM Error
50	7.2	836.40026	0.31
40	7.2	836.40019	0.23
30	7.2	836.40013	0.16
20	7.2	836.40001	0.01
10	7.2	836.40006	0.07
0	7.2	836.40005	0.06
-10	7.2	836.39995	-0.06
-20	7.2	836.39983	-0.20
-30	7.2	836.39967	-0.39

Frequency Stability Versus Battery Voltage

Reference Frequency: 836.4MHz, Limit: 2.5ppm			
Power Supplied (VDC)	Environment Temperature (°C)	MHz	ppm
6	20	836.40025	0.30

Battery End Point: 6V

§22.917 – BAND EDGE

Applicable Standard

According to § 22.917, the power of any emission outside of the authorized operating frequency ranges must be attenuated below the transmitting power (P) by a factor of at least $43 + 10 \log(P)$ dB.

Test Procedure

The RF output of the transmitter was connected to the input of the spectrum analyzer through sufficient attenuation.

The center of the spectrum analyzer was set to block edge frequency, RBW set to 30KHz.

Test Equipment List and Details

Manufacturer	Description	Model	Serial Number	Cal. Date
HP	Spectrum Analyzer	HP8564E	3943A01781	2003-08-01
HP	Plotter	HP7470A	2541A49659	Not Required

* **Statement of Traceability:** **BACL Corp.** certifies that all calibrations have been performed in accordance to NVLAP requirements, traceable to the NIST.

Environmental Conditions

Temperature:	24° C
Relative Humidity:	44%
ATM Pressure:	1016 mbar

The testing was performed by Ling Zhang on 2004-03-19.

Test Results

Please refer to the following plots.

