

# ENGINEERING TEST REPORT

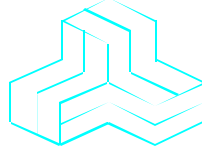

## **Elite 770 Intelligent Base** **Model No.: Elite 770 Intelligent Base**

**FCC ID: O34-Elite770IB**

*Applicant:*     **IVI CHECKMATE INC.**  
79 Torbarrie Road  
Toronto, Ontario  
Canada, M3L 1G5

*In Accordance With*

**FCC PART 15, SUBPART C, PARA. 15.249**  
**LOW POWER TRANSMITTERS**  
**OPERATING WITHIN THE FREQUENCY BAND FROM 911.4 - 918.6 MHz**

**UltraTech's File No.: IVI73-FTX**

This Test report is Issued under the Authority of  
Tri M. Luu, Professional Engineer,  
Vice President of Engineering  
UltraTech Group of Labs

Date: .....

Report Prepared by: Dan Huynh

Tested by: Hung Trinh, EMI/RFI Technician

Issued Date: June 20, 2000

Test Dates: May 30, June 5, 2000

*The results in this Test Report apply only to the sample(s) tested, and the sample tested is randomly selected.*

## **UltraTech**

3000 Bristol Circle, Oakville, Ontario, Canada, L6H 6G4  
Telephone (905) 829-1570     Facsimile (905) 829-8050  
Website: [www.ultrat4ech-labs.com](http://www.ultrat4ech-labs.com)     Email: [vhk.ultratech@sympatico.ca](mailto:vhk.ultratech@sympatico.ca)

## TABLE OF CONTENTS

<b>EXHIBIT 1.</b>	<b>SUBMITTAL CHECK LIST.....</b>	<b>1</b>
<b>EXHIBIT 2.</b>	<b>INTRODUCTION .....</b>	<b>3</b>
2.1.	SCOPE.....	3
2.2.	RELATED SUBMITAL(S)/GRANT(S).....	3
2.3.	NORMATIVE REFERENCES .....	3
<b>EXHIBIT 3.</b>	<b>PERFORMANCE ASSESSMENT .....</b>	<b>4</b>
3.1.	CLIENT INFORMATION.....	4
3.2.	EQUIPMENT UNDER TEST (EUT) INFORMATION .....	4
3.3.	EUT’S TECHNICAL SPECIFICATIONS .....	5
3.4.	LIST OF EUT’S PORTS.....	5
3.5.	GENERAL TEST SETUP.....	6
<b>EXHIBIT 4.</b>	<b>EUT OPERATING CONDITIONS AND CONFIGURATIONS DURING TESTS .....</b>	<b>7</b>
4.1.	CLIMATE TEST CONDITIONS.....	7
4.2.	OPERATIONAL TEST CONDITIONS & ARRANGEMENT FOR TEST S.....	7
<b>EXHIBIT 5.</b>	<b>SUMMARY OF TEST RESULTS.....</b>	<b>8</b>
5.1.	LOCATION OF TESTS.....	8
5.2.	APPLICABILITY & SUMMARY OF EMC EMISSION TEST RESULTS.....	8
5.3.	MODIFICATIONS INCORPORATED IN THE EUT FOR COMPLIANCE PURPOSES.....	8
<b>EXHIBIT 6.</b>	<b>MEASUREMENTS, EXAMINATIONS &amp; TEST DATA FOR EMC EMISSIONS .....</b>	<b>9</b>
6.1.	TEST PROCEDURES.....	9
6.2.	MEASUREMENT UNCERTAINTIES.....	9
6.3.	MEASUREMENT EQUIPMENT USED:.....	9
6.4.	ESSENTIAL/PRIMARY FUNCTIONS AS DECLARED BY THE MANUFACTURER:.....	9
6.5.	AC POWERLINE CONDUCTED EMISSIONS @ FCC PART 15, SUBPART B, PARA.15.107(A).....	10
6.5.1.	<i>Limits</i> .....	10
6.5.2.	<i>Method of Measurements</i> .....	10
6.5.3.	<i>Test Equipment List</i> .....	10
6.5.4.	<i>Test Data</i> .....	11
6.5.5.	<i>Plots</i> .....	11
6.5.6.	<i>Photographs of Test Setup</i> .....	12
6.6.	RF EXPOSURE LIMIT FCC 1.1310.....	13
6.6.1.	<i>Limits</i> .....	13
6.6.2.	<i>Method of Measurements</i> .....	13
6.6.3.	<i>Test Arrangement</i> .....	13
6.6.4.	<i>Test Equipment List</i> .....	13
6.6.5.	<i>Test Data</i> .....	14
6.7.	TRANSMITTER FUNDAMENTAL & HARMONIC RADIATED EMISSIONS @ FCC CFR 47, PARA 15.249 (A).....	15
6.7.1.	<i>Limits</i> .....	15
6.7.2.	<i>Method of Measurements</i> .....	16
6.7.3.	<i>Test Arrangement</i> .....	16
6.7.4.	<i>Test Equipment List</i> .....	16

---

### ULTRATECH GROUP OF LABS

3000 Bristol Circle, Oakville, Ontario, Canada L6H 6G4  
Tel. #: 905-829-1570, Fax. #: 905-829-8050, Email: [vhk.ultratech@sympatico.ca](mailto:vhk.ultratech@sympatico.ca), Website: <http://www.ultratech-labs.com>

File #: IVI73-FTX  
June 20, 2000

- Assessed by ITI (UK) Competent Body, NVLAP (USA) Accreditation Body & ACA/AUSTEL (Australia)
- Accredited by Industry Canada (Canada) under ACC-LAB (Europe/Canada MRA)
- Recognized/Listed by FCC (USA)

All test results contained in this engineering test report are traceable to National Institute of Standards and Technology (NIST)

6.7.5.	Test Data.....	17
6.7.6.	Photographs of Test Setup .....	20
<b>EXHIBIT 7.</b>	<b>MEASUREMENT UNCERTAINTY.....</b>	<b>21</b>
7.1.	LINE CONDUCTED EMISSION MEASUREMENT UNCERTAINTY.....	21
7.2.	RADIATED EMISSION MEASUREMENT UNCERTAINTY.....	22
<b>EXHIBIT 8.</b>	<b>MEASUREMENT METHODS.....</b>	<b>23</b>
8.1.	GENERAL TEST CONDITIONS .....	23
8.1.1.	Normal temperature and humidity .....	23
8.1.2.	Normal power source .....	23
8.1.3.	Operating Condition of Equipment under Test.....	23
8.2.	METHOD OF MEASUREMENTS - AC MAINS CONDUCTED EMISSIONS.....	24
8.3.	EFFECTIVE RADIATED POWER .....	25
8.4.	SPURIOUS EMISSIONS (RADIATED).....	27
8.4.1.	Spurious Emissions (Radiated).....	27
<b>EXHIBIT 9.</b>	<b>MEASUREMENT DATA PLOTS.....</b>	<b>29</b>
<b>EXHIBIT 10.</b>	<b>TEST SETUP PHOTOS.....</b>	<b>30</b>
<b>EXHIBIT 11.</b>	<b>EXTERNAL EUT PHOTOS .....</b>	<b>31</b>
<b>EXHIBIT 12.</b>	<b>INTERNAL EUT PHOTOS .....</b>	<b>32</b>
<b>EXHIBIT 13.</b>	<b>COVER LETTERS.....</b>	<b>33</b>
<b>EXHIBIT 14.</b>	<b>ATTESTATION STATEMENTS.....</b>	<b>34</b>
<b>EXHIBIT 15.</b>	<b>APPLICATION FORMS .....</b>	<b>35</b>
<b>EXHIBIT 16.</b>	<b>FCC LABEL/LOCATION INFORMATION.....</b>	<b>36</b>
<b>EXHIBIT 17.</b>	<b>BLOCK DIAGRAMS .....</b>	<b>37</b>
<b>EXHIBIT 18.</b>	<b>SCHEMATIC DIAGRAMS .....</b>	<b>38</b>
<b>EXHIBIT 19.</b>	<b>PARTS LIST / TUNE UP INFORMATION.....</b>	<b>39</b>
<b>EXHIBIT 20.</b>	<b>OPERATIONAL DESCRIPTION.....</b>	<b>40</b>
<b>EXHIBIT 21.</b>	<b>RF EXPOSURE INFORMATION .....</b>	<b>41</b>
<b>EXHIBIT 22.</b>	<b>USER'S MANUAL.....</b>	<b>42</b>

**ULTRATECH GROUP OF LABS**

3000 Bristol Circle, Oakville, Ontario, Canada L6H 6G4  
Tel. #: 905-829-1570, Fax. #: 905-829-8050, Email: [vhk.ultratech@sympatico.ca](mailto:vhk.ultratech@sympatico.ca), Website: <http://www.ultratech-labs.com>

File #: IVI73-FTX  
June 20, 2000

- Assessed by ITI (UK) Competent Body, NVLAP (USA) Accreditation Body & ACA/AUSTEL (Australia)
- Accredited by Industry Canada (Canada) under ACC-LAB (Europe/Canada MRA)
- Recognized/Listed by FCC (USA)
- All test results contained in this engineering test report are traceable to National Institute of Standards and Technology (NIST)

## EXHIBIT 1. SUBMITTAL CHECK LIST

Exhibit No.	Exhibit Type	Description of Contents	Quality Check (OK)
1 through 8	Test Report	-Exhibit 1: Submittal check lists -Exhibit 2: Introduction -Exhibit 3: Performance Assessment -Exhibit 4: EUT Operation and Configuration during Tests -Exhibit 5: Summary of test Results -Exhibit 6: Measurement Data -Exhibit 7: Measurement Uncertainty -Exhibit 8: Measurement Methods	OK
9	Test Report - Plots of Measurement Data	-26 dB Bandwidth (plots # 1 and 2) -Power-Line Conducted Emissions (plots # 3 and 4) -Transmitter Radiated Emissions (plots # 5 to 12)	OK
10	Test Setup Photos	-AC Conducted Emissions (photos # 1 and 2) -Radiated Emissions (photos # 3 and 4)	OK
11	External Photos of EUT	External EUT Photos (photos # 1 to 2)	OK
12	Internal Photos of EUT	Internal EUT Photos (photos # 1 to 10)	OK
13	Cover Letters	-Letter from Ultratech for Certification Request -Letter from the Applicant to appoint Ultratech to act as an agent -Letter from the Applicant to request for Confidentiality Filing	OK
14	Attestation Statements	--	--
15	Application Forms	-FCC Grantee Registration Confirmation -Form 731 -Form 159	OK
16	ID Label/Location Info	-ID Label -Location of ID Label	OK
17	Block Diagrams	Elite 770 Intelligent Base Block Diagram	OK
18	Schematic Diagrams	-MER206 RADIO BASE -MER206 EQUIPEMENT F1 -MER206 EQUIPEMENT F2 -MER206 USINAGE -MER206 MONTAGE PLAQUE 2x2 -SCHEMATICS REC109 MULTIFREQUENCY RADIO 915/434MHz -PLAN D'EQUIPMENT CARTE REC109-01 (915 MHz) -PLAN D'EQUIPMENT CARTE REC109-02 (433 MHz) -PLAN D'USINAGE CARTE REC109 -PLAN DE MONTAGE EN PLAQUE 4 x 3	OK
19	Parts List/Tune Up Info	-NOMENCLATURE CARTE MER206 -NOMENCLATURE CARTE REC109-02 (443MHz) -NOMENCLATURE CARTE REC109-01 ((915MHz)	OK

### ULTRATECH GROUP OF LABS

3000 Bristol Circle, Oakville, Ontario, Canada L6H 6G4  
 Tel. #: 905-829-1570, Fax. #: 905-829-8050, Email: [vhk.ultratech@sympatico.ca](mailto:vhk.ultratech@sympatico.ca), Website: <http://www.ultratech-labs.com>

File #: IVI73-FTX  
 June 20, 2000

- Assessed by ITI (UK) Competent Body, NVLAP (USA) Accreditation Body & ACA/AUSTEL (Australia)
- Accredited by Industry Canada (Canada) under ACC-LAB (Europe/Canada MRA)
- Recognized/Listed by FCC (USA)

All test results contained in this engineering test report are traceable to National Institute of Standards and Technology (NIST)

Exhibit No.	Exhibit Type	Description of Contents	Quality Check (OK)
20	Operational Description	-Elite 770 Short Range RF system (consist of Elite 770 -Intelligent Base and Elite 770 Hand Held)	OK
21	RF Exposure Info	--	--
22	User's Manual	-Elite 770* User's Manual -Elite 770 User's Manual Addendum	OK

---

**ULTRATECH GROUP OF LABS**

3000 Bristol Circle, Oakville, Ontario, Canada L6H 6G4

Tel. #: 905-829-1570, Fax. #: 905-829-8050, Email: [vhk.ultratech@sympatico.ca](mailto:vhk.ultratech@sympatico.ca), Website: <http://www.ultratech-labs.com>

File #: IVI73-FTX

June 20, 2000

- Assessed by ITI (UK) Competent Body, NVLAP (USA) Accreditation Body & ACA/AUSTEL (Australia)
- Accredited by Industry Canada (Canada) under ACC-LAB (Europe/Canada MRA)
- Recognized/Listed by FCC (USA)
- *All test results contained in this engineering test report are traceable to National Institute of Standards and Technology (NIST)*

## EXHIBIT 2. INTRODUCTION

### 2.1. SCOPE

<b>Reference:</b>	FCC Part 15, Subpart C, Section 15.249:1998
<b>Title</b>	Telecommunication - Code of Federal Regulations, CFR 47, Part 15
<b>Purpose of Test:</b>	To gain FCC Certification Authorization for transmitters operated within the frequency band of 911.4 - 918.6 MHz .
<b>Test Procedures</b>	Both conducted and radiated emissions measurements were conducted in accordance with American National Standards Institute ANSI C63.4 - American National Standard for Methods of Measurement of Radio-Noise Emissions from Low-Voltage Electrical and Electronic Equipment in the Range of 9 kHz to 40 GHz.
<b>Environmental Classification:</b>	<ul style="list-style-type: none"><li>• Light-industry, Commercial</li><li>• Industry</li></ul>

### 2.2. RELATED SUBMITAL(S)/GRANT(S)

None

### 2.3. NORMATIVE REFERENCES

Publication	YEAR	Title
FCC CFR Parts 0-19	1999	Code of Federal Regulations – Telecommunication
ANSI C63.4	1992	American National Standard for Methods of Measurement of Radio-Noise Emissions from Low-Voltage Electrical and Electronic Equipment in the Range of 9 kHz to 40 GHz
CISPR 22 & EN 55022	1997 1998	Limits and Methods of Measurements of Radio Disturbance Characteristics of Information Technology Equipment
CISPR 16-1		Specification for Radio Disturbance and Immunity measuring apparatus and methods

---

#### ULTRATECH GROUP OF LABS

3000 Bristol Circle, Oakville, Ontario, Canada L6H 6G4  
Tel. #: 905-829-1570, Fax. #: 905-829-8050, Email: [vhk.ultratech@sympatico.ca](mailto:vhk.ultratech@sympatico.ca), Website: <http://www.ultratech-labs.com>

File #: IVI73-FTX  
June 20, 2000

- Assessed by ITI (UK) Competent Body, NVLAP (USA) Accreditation Body & ACA/AUSTEL (Australia)
- Accredited by Industry Canada (Canada) under ACC-LAB (Europe/Canada MRA)
- Recognized/Listed by FCC (USA )
- *All test results contained in this engineering test report are traceable to National Institute of Standards and Technology (NIST)*

## EXHIBIT 3. PERFORMANCE ASSESSMENT

### 3.1. CLIENT INFORMATION

APPLICANT	
<b>Name</b>	IVI CHECKMATE INC.
<b>Address</b>	79 Torbarrie Road Toronto, Ontario Canada, M3L 1G5
<b>Contact Person</b>	Mr. Ayman Sydhom
<b>Tel</b>	(416) 245-6700
<b>Fax</b>	(416) 245-6701
<b>Email Address</b>	Email Address: asydhom@ivicm.com

MANUFACTURER	
<b>Name</b>	GROUPE INGENICO
<b>Address</b>	9 Quai De Dion Bouton 92816 Puteaux Cedex, France
<b>Tel</b>	+33 (0) 1 46 25 82 00
<b>Fax</b>	+33 (0) 1 47 72 56 95

### 3.2. EQUIPMENT UNDER TEST (EUT) INFORMATION

The following information (with the exception of the Date of Receipt) has been supplied by the applicant.

<b>Brand Name</b>	IVI CHECKMATE INC.
<b>Product Name</b>	Elite 770 Intelligent Base
<b>Model Name or Number</b>	Elite 770 Intelligent Base
<b>Serial Number</b>	Preproduction
<b>Type of Equipment</b>	Low Power Transmitters
<b>Input Power Supply Type</b>	External DC Sources
<b>Associated Device(s)</b>	IVI Checkmate Inc. Elite 770 Hand Held Model: Elite 770 Hand Held  AC Adapter M/N: D7-10-01 S/N: 97330/9736
<b>Primary User Functions of EUT:</b>	Provide data communication link through air

#### ULTRATECH GROUP OF LABS

3000 Bristol Circle, Oakville, Ontario, Canada L6H 6G4  
 Tel. #: 905-829-1570, Fax. #: 905-829-8050, Email: [vhk.ultratech@sympatico.ca](mailto:vhk.ultratech@sympatico.ca), Website: <http://www.ultratech-labs.com>

File #: IVI73-FTX  
 June 20, 2000

- Assessed by ITI (UK) Competent Body, NVLAP (USA) Accreditation Body & ACA/AUSTEL (Australia)
- Accredited by Industry Canada (Canada) under ACC-LAB (Europe/Canada MRA)
- Recognized/Listed by FCC (USA)
- All test results contained in this engineering test report are traceable to National Institute of Standards and Technology (NIST)

### 3.3. EUT'S TECHNICAL SPECIFICATIONS

<b>TRANSMITTER</b>	
<b>Equipment Type:</b>	<ul style="list-style-type: none"> <li>▪ Mobile</li> <li>▪ Base station (fixed use)</li> </ul>
<b>Intended Operating Environment:</b>	▪ Commercial, light industry & heavy industry
<b>Power Supply Requirement:</b>	12VDC, 500 mA
<b>RF Output Power Rating:</b>	0.44 mW
<b>Operating Frequency Range:</b>	911.4 – 918.6 MHz
<b>RF Output Impedance:</b>	50 Ohms
<b>Duty Cycle:</b>	Continuous
<b>26 dB Bandwidth:</b>	114.0 kHz (refer to Exhibit 9 test plots # 1 and # 2 for details)
<b>Modulation Type:</b>	FM
<b>Emission Designation:</b>	M114F1D
<b>Oscillator Frequencies:</b>	10.7 MHz
<b>Antenna Connector Type:</b>	Integral, permanently attached
<b>Antenna Description:</b>	Manufacturer: NeoFlex Technology Type: Wip Antenna Frequency Range: 911.4 – 918.6 MHz In/Out Impedance: 50 Ohms Gain: +1 ± 0.5dBi

### 3.4. LIST OF EUT'S PORTS

Port Number	EUT's Port Description	Number of Identical Ports	Connector Type	Cable Type (Shielded/Non-shielded)
1	Telephonic Line	1	RJ11	Non-shielded
2	Serial Port (RS232)	1	RJ11	Non-shielded
3	Power Supply	1	Plug-In	Non-shielded

**NOTE:**

1. Ports of the EUT which in normal operation were connected to ancillary equipment through interconnecting cables via a representative interconnecting cable to simulate the input/output characteristics. RF input/output was correctly terminated to the associated antenna.
2. Ports which are not connected to cables during normal intended operation since it is only provided for Service Uses: None.

**ULTRATECH GROUP OF LABS**

3000 Bristol Circle, Oakville, Ontario, Canada L6H 6G4  
 Tel. #: 905-829-1570, Fax. #: 905-829-8050, Email: [vhk.ultratech@sympatico.ca](mailto:vhk.ultratech@sympatico.ca), Website: <http://www.ultratech-labs.com>

File #: IVI73-FTX  
 June 20, 2000

- Assessed by ITI (UK) Competent Body, NVLAP (USA) Accreditation Body & ACA/AUSTEL (Australia)
- Accredited by Industry Canada (Canada) under ACC-LAB (Europe/Canada MRA)
- Recognized/Listed by FCC (USA)
- All test results contained in this engineering test report are traceable to National Institute of Standards and Technology (NIST)



### 3.5. GENERAL TEST SETUP

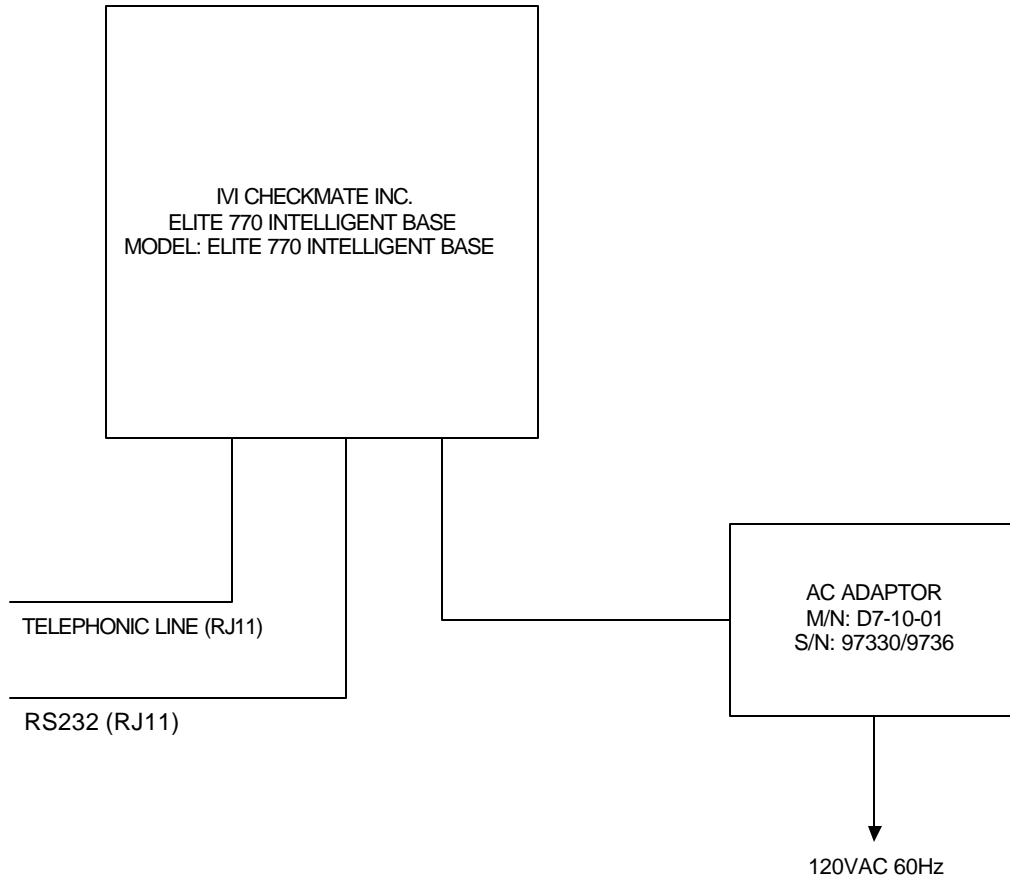

---

#### ULTRATECH GROUP OF LABS

3000 Bristol Circle, Oakville, Ontario, Canada L6H 6G4  
Tel. #: 905-829-1570, Fax. #: 905-829-8050, Email: [vhk.ultratech@sympatico.ca](mailto:vhk.ultratech@sympatico.ca), Website: <http://www.ultratech-labs.com>

File #: IVI73-FTX  
June 20, 2000

- Assessed by ITI (UK) Competent Body, NVLAP (USA) Accreditation Body & ACA/AUSTEL (Australia)
- Accredited by Industry Canada (Canada) under ACC-LAB (Europe/Canada MRA)
- Recognized/Listed by FCC (USA)
- *All test results contained in this engineering test report are traceable to National Institute of Standards and Technology (NIST)*

## EXHIBIT 4. EUT OPERATING CONDITIONS AND CONFIGURATIONS DURING TESTS

### 4.1. CLIMATE TEST CONDITIONS

The climate conditions of the test environment are as follows:

Temperature:	21°C
Humidity:	51%
Pressure:	102 kPa
Power input source:	12VDC, 500 mA

### 4.2. OPERATIONAL TEST CONDITIONS & ARRANGEMENT FOR TESTS

<b>Operating Modes:</b>	Each of lowest and highest channel frequencies transmits continuously for emissions measurements.
<b>Special Test Software:</b>	Special software is provided by the Applicant to select and operate the EUT at each channel frequency continuously. For example, the transmitter will be operated at each of lowest, middle and highest frequencies individually continuously during testing.
<b>Special Hardware Used:</b>	N/A
<b>Transmitter Test Antenna:</b>	The EUT is tested with the antenna fitted in a manner typical of normal intended use as an integral antenna equipment.

<b>Transmitter Test Signals:</b>	
<b>Frequencies:</b>	Lowest and highest channel frequencies tested:
<ul style="list-style-type: none"> <li>▪ Band III: 911.4 – 914.2 MHz</li> <li>▪ Band IV: 915.8 - 918.6 MHz</li> </ul>	911.4 MHz, 914.2 MHz 915.8 MHz, 918.6 MHz
<b>Transmitter Wanted Output Test Signals:</b>	
<ul style="list-style-type: none"> <li>▪ RF Power Output (measured maximum output power):</li> <li>▪ Normal Test Modulation</li> <li>▪ Modulating signal source:</li> </ul>	<ul style="list-style-type: none"> <li>▪ 0.44 mW</li> <li>▪ Each channel is FM modulated</li> <li>▪ Internal</li> </ul>

---

#### ULTRATECH GROUP OF LABS

3000 Bristol Circle, Oakville, Ontario, Canada L6H 6G4  
 Tel. #: 905-829-1570, Fax. #: 905-829-8050, Email: [vhk.ultratech@sympatico.ca](mailto:vhk.ultratech@sympatico.ca), Website: <http://www.ultratech-labs.com>

File #: IVI73-FTX  
 June 20, 2000

- Assessed by ITI (UK) Competent Body, NVLAP (USA) Accreditation Body & ACA/AUSTEL (Australia)
- Accredited by Industry Canada (Canada) under ACC-LAB (Europe/Canada MRA)
- Recognized/Listed by FCC (USA)
- *All test results contained in this engineering test report are traceable to National Institute of Standards and Technology (NIST)*

## EXHIBIT 5. SUMMARY OF TEST RESULTS

### 5.1. LOCATION OF TESTS

All of the measurements described in this report were performed at Ultratech Group of Labs located in the city of Oakville, Province of Ontario, Canada.

- AC Powerline Conducted Emissions were performed in UltraTech's shielded room, 16'(L) by 12'(W) by 12'(H).
- Radiated Emissions were performed at the Ultratech's 3 Meter Open Field Test Site (OFTS) situated in the Town of Oakville, province of Ontario.

The above sites have been calibrated in accordance with ANSI C63.4, and found to be in compliance with the requirements of Sec. 2.948 of the FCC Rules. The descriptions and site measurement data of the Oakville Open Field Test Site has been filed with FCC office (FCC File No.: 31040/SIT 1300B3) and Industry Canada office (Industry Canada File No.: IC2049). Last Date of Site Calibration: Sep.20, 1999.

### 5.2. APPLICABILITY & SUMMARY OF EMC EMISSION TEST RESULTS

FCC PARAGRAPH.	TEST REQUIREMENTS	COMPLIANCE (YES/NO)
15.107(a)	AC Power Conducted Emissions	Yes (Note 1)
15.249(a), 15.209, 15.205 & 1.1310	Transmitter Radiated Emissions, Harmonic Emissions and RF Exposure Limit	Yes

**Note 1:** The digital circuits portion of the EUT has been tested and verified to comply with FCC Part 15, Subpart B, Class B Digital Devices and Radio Receivers. The engineering test report can be provided upon FCC requests.

### 5.3. MODIFICATIONS INCORPORATED IN THE EUT FOR COMPLIANCE PURPOSES

None.

---

#### ULTRATECH GROUP OF LABS

3000 Bristol Circle, Oakville, Ontario, Canada L6H 6G4  
Tel. #: 905-829-1570, Fax. #: 905-829-8050, Email: [vhk.ultratech@sympatico.ca](mailto:vhk.ultratech@sympatico.ca), Website: <http://www.ultratech-labs.com>

File #: IVI73-FTX  
June 20, 2000

- Assessed by ITI (UK) Competent Body, NVLAP (USA) Accreditation Body & ACA/AUSTEL (Australia)
- Accredited by Industry Canada (Canada) under ACC-LAB (Europe/Canada MRA)
- Recognized/Listed by FCC (USA)
- All test results contained in this engineering test report are traceable to National Institute of Standards and Technology (NIST)

## **EXHIBIT 6. MEASUREMENTS, EXAMINATIONS & TEST DATA FOR EMC EMISSIONS**

### **6.1. TEST PROCEDURES**

This section contains test results only. Details of test methods and procedures can be found in Exhibit 8 of this report

### **6.2. MEASUREMENT UNCERTAINTIES**

The measurement uncertainties stated were calculated in accordance with requirements of UKAS Document NIS 81 with a confidence level of 95%. Please refer to Exhibit 7 for Measurement Uncertainties.

### **6.3. MEASUREMENT EQUIPMENT USED:**

The measurement equipment used complied with the requirements of the Standards referenced in the Methods & Procedures ANSI C64-3:1992, FCC 15.247 and CISPR 16-1.

### **6.4. ESSENTIAL/PRIMARY FUNCTIONS AS DECLARED BY THE MANUFACTURER:**

The essential function of the EUT is to correctly communicate data to and from radios over RF link.

---

#### **ULTRATECH GROUP OF LABS**

3000 Bristol Circle, Oakville, Ontario, Canada L6H 6G4

Tel. #: 905-829-1570, Fax. #: 905-829-8050, Email: [vhk.ultratech@sympatico.ca](mailto:vhk.ultratech@sympatico.ca), Website: <http://www.ultratech-labs.com>

File #: IVI73-FTX  
June 20, 2000

- Assessed by ITI (UK) Competent Body, NVLAP (USA) Accreditation Body & ACA/AUSTEL (Australia)
- Accredited by Industry Canada (Canada) under ACC-LAB (Europe/Canada MRA)
- Recognized/Listed by FCC (USA)
- *All test results contained in this engineering test report are traceable to National Institute of Standards and Technology (NIST)*

**6.5. AC POWERLINE CONDUCTED EMISSIONS @ FCC PART 15, SUBPART B, PARA.15.107(a)**

**6.5.1. Limits**

The equipment shall meet the limits of the following table:

Test Frequency Range	Test Limits	EMI Detector Used	Measuring Bandwidth
0.45 to 30 MHz	48 dB $\mu$ V	Quasi-Peak (Narrow band)	B = 10 kHz
	61 dB $\mu$ V	Quasi-Peak (Broad band)	B = 10 kHz

**6.5.2. Method of Measurements**

Refer to Exhibit 8, Sec. 8.2 of this test report & ANSI C63-4:1992

**6.5.3. Test Equipment List**

Test Instruments	Manufacturer	Model No.	Serial No.	Frequency Range
Spectrum Analyzer/ EMI Receiver	Hewlett Packard	HP 8593EM	3412A00103	9 kHz – 26.5 GHz
Transient Limiter	Hewlett Packard	11947A	310701998	9 kHz – 200 MHz 10 dB attenuation
L.I.S.N.	EMCO	3825/2	89071531	9 kHz – 200 MHz 50 Ohms / 50 $\mu$ H
12'x16'x12' RF Shielded Chamber	RF Shielding Inc.	...	..	...

**ULTRATECH GROUP OF LABS**

3000 Bristol Circle, Oakville, Ontario, Canada L6H 6G4  
 Tel. #: 905-829-1570, Fax. #: 905-829-8050, Email: [vhk.ultratech@sympatico.ca](mailto:vhk.ultratech@sympatico.ca), Website: <http://www.ultratech-labs.com>

File #: IVI73-FTX  
 June 20, 2000

- Assessed by ITI (UK) Competent Body, NVLAP (USA) Accreditation Body & ACA/AUSTEL (Australia)
- Accredited by Industry Canada (Canada) under ACC-LAB (Europe/Canada MRA)
- Recognized/Listed by FCC (USA)
- All test results contained in this engineering test report are traceable to National Institute of Standards and Technology (NIST)

6.5.4. Test Data

FREQUENCY (MHz)	RF LEVEL (dBμV)	RECEIVER DETECTOR (P/QP/AVG)	QP/NB LIMIT (dBμV)	QP/BB LIMIT (dBμV)	MARGIN (dB)	PASS/ FAIL	LINE TESTED (L1/L2)
0.479	29.9	QP	48.0	61.0	-31.1	PASS	L1
0.479	28.4	QP	48.0	61.0	-32.6	PASS	L2

6.5.5. Plots

The following plots graphically represent the test results recorded in the above Test Data Table.

AC Conducted Emissions - Line #1 (Hot)  
 IVI Checkmate Inc.  
 Elite 770 Intelligent Base, Model Elite 770 Intelligent Base

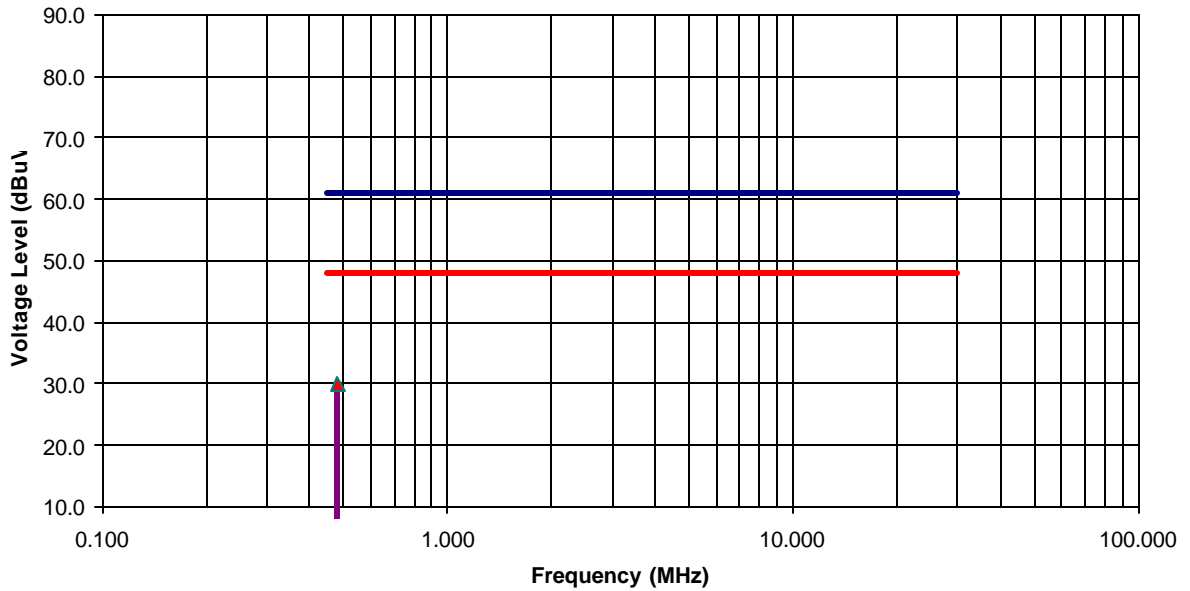

ULTRATECH GROUP OF LABS

3000 Bristol Circle, Oakville, Ontario, Canada L6H 6G4  
 Tel. #: 905-829-1570, Fax. #: 905-829-8050, Email: [vhk.ultratech@sympatico.ca](mailto:vhk.ultratech@sympatico.ca), Website: <http://www.ultratech-labs.com>

File #: IVI73-FTX  
 June 20, 2000

- Assessed by ITI (UK) Competent Body, NVLAP (USA) Accreditation Body & ACA/AUSTEL (Australia)
- Accredited by Industry Canada (Canada) under ACC-LAB (Europe/Canada MRA)
- Recognized/Listed by FCC (USA)
- All test results contained in this engineering test report are traceable to National Institute of Standards and Technology (NIST)

AC Conducted Emissions - Line #2 (Neutral)  
IVI Checkmate Inc.  
Elite 770 Intelligent Base, Model Elite 770 Intelligent Base

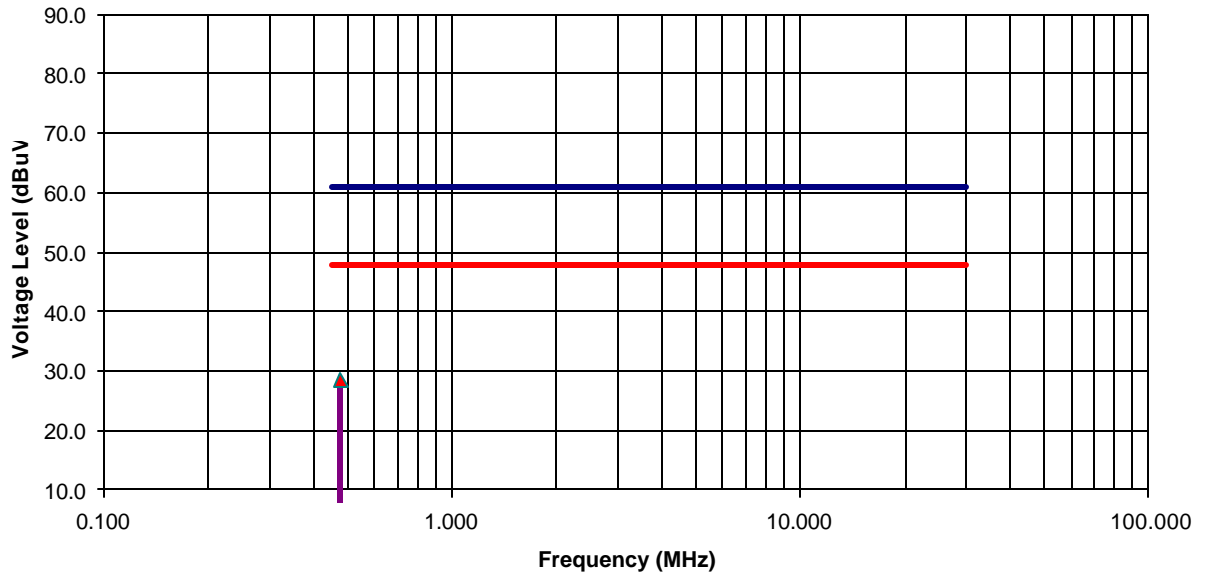

Refer to plots # 3 & 4 in Exhibit 9 for actual measurement plots

### 6.5.6. Photographs of Test Setup

Refer to the photographs #1 & #2 in Exhibit 10 for setup and arrangement of equipment under tests.

---

#### ULTRATECH GROUP OF LABS

3000 Bristol Circle, Oakville, Ontario, Canada L6H 6G4  
Tel. #: 905-829-1570, Fax. #: 905-829-8050, Email: [vhk.ultratech@sympatico.ca](mailto:vhk.ultratech@sympatico.ca), Website: <http://www.ultratech-labs.com>

File #: IVI73-FTX  
June 20, 2000

- Assessed by ITI (UK) Competent Body, NVLAP (USA) Accreditation Body & ACA/AUSTEL (Australia)
- Accredited by Industry Canada (Canada) under ACC-LAB (Europe/Canada MRA)
- Recognized/Listed by FCC (USA)
- All test results contained in this engineering test report are traceable to National Institute of Standards and Technology (NIST)

## 6.6. RF EXPOSURE LIMIT FCC 1.1310

### 6.6.1. Limits

- **FCC 1.1310**:- The criteria listed in the following table shall be used to evaluate the environmental impact of human exposure to radio-frequency (RF) radiation as specified in 1.1307(b).

**LIMITS FOR MAXIMUM PERMISSIBLE EXPOSURE (MPE)**

Frequency Range (MHz)	Electric Field Strength (V/m)	Magnetic Field Strength (A/m)	Power Density (mW/cm <sup>2</sup> )	Average Time (minutes)
<b>(A) Limits for Occupational/Control Exposures</b>				
30-300	61.4	0.163	1.0	6
300-1500	...	...	F/300	6
<b>(B) Limits for General Population/Uncontrolled Exposure</b>				
30-300	27.5	0.073	0.2	30
300-1500	...	...	F/1500	30

F = Frequency in MHz

### 6.6.2. Method of Measurements

Refer to Exhibit 8, Sec. 8.3 of this test report, ANSI C63-4:1992, FCC @ 1.1310 & OST Bulletin No. 65-October 1985

### 6.6.3. Test Arrangement

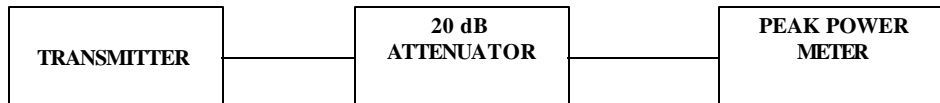

### 6.6.4. Test Equipment List

Test Instruments	Manufacturer	Model No.	Serial No.	Frequency Range
Spectrum Analyzer/ EMI Receiver	Hewlett Packard	HP 8593EM	3412A00103	9 kHz – 26.5 GHz
Peak Power Meter & Peak Power Sensor	Hewlett Packard	8900 8481A	2131A00124 2551A01965	0.1-18 GHz 50 Ohms Input
Microwave Amplifier	Hewlett Packard	HP 83017A		1 GHz to 26.5 GHz
Horn Antenna	EMCO	3155	9701-5061	1 GHz – 18 GHz
Horn Antenna	EMCO	3155	9911-5955	1 GHz – 18 GHz

## ULTRATECH GROUP OF LABS

3000 Bristol Circle, Oakville, Ontario, Canada L6H 6G4  
 Tel. #: 905-829-1570, Fax. #: 905-829-8050, Email: [vhk.ultratech@sympatico.ca](mailto:vhk.ultratech@sympatico.ca), Website: <http://www.ultratech-labs.com>

File #: IVI73-FTX  
 June 20, 2000

- Assessed by ITI (UK) Competent Body, NVLAP (USA) Accreditation Body & ACA/AUSTEL (Australia)
- Accredited by Industry Canada (Canada) under ACC-LAB (Europe/Canada MRA)
- Recognized/Listed by FCC (USA)
- All test results contained in this engineering test report are traceable to National Institute of Standards and Technology (NIST)



6.6.5. Test Data

<b>EFFECTIVE ISOTROPIC RADIATED POWER (EIRP) CALCULATED FROM FUNDAMENTAL FIELD STRENGTH MEASURED AT 3 METERS DISTANCE (Substitution Method)</b>			
<b>Tx Channel Output</b>	<b>Fundamental Frequency (MHz)</b>	<b>Max. Field Strength Level @ 100 KHz BW at 3 m (dBµV/m)</b>	<b>Max. EIRP Power In a 100 KHz BW (mW)</b>
<b>BAND 3</b>			
1	911.4	91.00	0.38
15	914.2	90.58	0.34
<b>BAND 4</b>			
1	915.8	90.53	0.34
15	918.6	91.64	0.44

<b>RF EXPOSURE DISTANCE LIMITS</b>				
<b>Transmitter Channel Output</b>	<b>Fundamental Frequency (MHz)</b>	<b>Calculated EIRP Full Power (mW)</b>	<b>Power Density (mW/cm<sup>2</sup>)</b>	<b>*Minimum Allowable Distance (r) From Skin (cm)</b>
<b>BAND 3</b>				
1	911.4	0.38	0.608	0.22
15	914.2	0.34	0.609	0.21
<b>BAND 4</b>				
1	915.8	0.34	0.610	0.21
15	918.6	0.44	0.612	0.24

\*  $S = PG/4\pi r^2 = EIRP/4\pi r^2$

Where: P: power input to the antenna in mW  
 EIRP: Equivalent (effective) isotropic radiated power.  
 S: power density mW/cm<sup>2</sup>  
 G: numeric gain of antenna relative to isotropic radiator  
 r: distance to centre of radiation in cm

$r = (PG/4\pi S)^{1/2} = (EIRP/4\pi S)^{1/2}$

FCC radio frequency exposure limits may not be exceeded at distances closer than r cm from the antenna of this device

Since the power density of 0.61 mW/cm<sup>2</sup> is at a very short distance from the radiating antenna which is integrated on the printed circuit board, and the antenna is completely enclosed inside the case, the RF exposure limit warning or SAR tests are not necessary.

**ULTRATECH GROUP OF LABS**

3000 Bristol Circle, Oakville, Ontario, Canada L6H 6G4  
 Tel. #: 905-829-1570, Fax. #: 905-829-8050, Email: [vhk.ultratech@sympatico.ca](mailto:vhk.ultratech@sympatico.ca), Website: <http://www.ultratech-labs.com>

File #: IVI73-FTX  
 June 20, 2000

- Assessed by ITI (UK) Competent Body, NVLAP (USA) Accreditation Body & ACA/AUSTEL (Australia)
- Accredited by Industry Canada (Canada) under ACC-LAB (Europe/Canada MRA)
- Recognized/Listed by FCC (USA)
- All test results contained in this engineering test report are traceable to National Institute of Standards and Technology (NIST)

**6.7. TRANSMITTER FUNDAMENTAL & HARMONIC RADIATED EMISSIONS @ FCC CFR 47, PARA 15.249 (a)**

**6.7.1. Limits**

The field strength of emissions from intentional radiators operated within these frequency bands shall comply with the following:

Fundamental Frequency	Field Strength of Fundamental @ 3m (dBμ/m)	Field Strength of Harmonics @ 3m (dBμ/m)
902 - 928 MHz	94.0	54.0
2400 - 2483.5 MHz	94.0	54.0
5725 - 5875 MHz	94.0	54.0
24.0 - 24.25 GHz	108.0	68.0

**Remarks:**

- Applies to harmonics/spurious emissions that fall in the restricted bands listed in Section 15.205. The maximum permitted average field strength is listed in Section 15.209.
- @ **FCC CFR 47, Para. 15.237(c)** - The emission limits as specified above are based on measurement instrument employing an average detector. The provisions in @ **15.35** for limiting peak emissions apply.

**FCC CFR 47, Part 15, Subpart C, Para. 15.205(a) – Restricted band of operation**

MHz	MHz	MHz	GHz
0.090 - 0.110	16.42 - 16.423	399.9 - 410	4.5 - 5.15
0.495 - 0.505	16.69475 - 16.69525	608 - 614	5.35 - 5.46
2.1735 - 2.1905	16.80425 - 16.80475	960 - 1240	7.25 - 7.75
4.125 - 4.128	25.5 - 25.67	1300 - 1427	8.025 - 8.5
4.17725 - 4.17775	37.5 - 38.25	1435 - 1626.5	9.0 - 9.2
4.20725 - 4.20775	73 - 74.6	1645.5 - 1646.5	9.3 - 9.5
6.215 - 6.218	74.8 - 75.2	1660 - 1710	10.6 - 12.7
6.26775 - 6.26825	108 - 121.94	1718.8 - 1722.2	13.25 - 13.4
6.31175 - 6.31225	123 - 138	2200 - 2300	14.47 - 14.5
8.291 - 8.294	149.9 - 150.05	2310 - 2390	15.35 - 16.2
8.362 - 8.366	156.52475 - 156.52525	2483.5 - 2500	17.7 - 21.4
8.37625 - 8.38675	156.7 - 156.9	2655 - 2900	22.01 - 23.12
8.41425 - 8.41475	162.0125 - 167.17	3260 - 3267	23.6 - 24.0
12.29 - 12.293	167.72 - 173.2	3332 - 3339	31.2 - 31.8
12.51975 - 12.52025	240 - 285	3345.8 - 3358	36.43 - 36.5
12.57675 - 12.57725	322 - 335.4	3600 - 4400	Above 38.6
13.36 - 13.41			

**ULTRATECH GROUP OF LABS**

3000 Bristol Circle, Oakville, Ontario, Canada L6H 6G4  
 Tel. #: 905-829-1570, Fax. #: 905-829-8050, Email: [vhk.ultratech@sympatico.ca](mailto:vhk.ultratech@sympatico.ca), Website: <http://www.ultratech-labs.com>

File #: IVI73-FTX  
 June 20, 2000

- Assessed by ITI (UK) Competent Body, NVLAP (USA) Accreditation Body & ACA/AUSTEL (Australia)
- Accredited by Industry Canada (Canada) under ACC-LAB (Europe/Canada MRA)
- Recognized/Listed by FCC (USA)
- All test results contained in this engineering test report are traceable to National Institute of Standards and Technology (NIST)

**FCC CFR 47, Part 15, Subpart C, Para. 15.209(a)**  
**Radiated emission limits, general requirements**

Frequency (MHz)	Field Strength (microvolts/m)	Measurement Distance (meters)
0.009 - 0.490	2,400 / F (kHz)	300
0.490 - 1.705	24,000 / F (kHz)	30
1.705 - 30.0	30	30
30 - 88	100	3
88 - 216	150	3
216 - 960	200	3
Above 960	500	3

**6.7.2. Method of Measurements**

Refer to Exhibit 8, Sec. 8.4 of this test report and **ANSI 63.4-1992, Para. 8** for detailed radiated emissions measurement procedures.

The following measurement procedures were also applied:

- Applies to harmonics/spurious that fall in the restricted bands listed in Section 15.205. the maximum permitted average field strength is listed in Section 15.209. A Pre-Amp and highpass filter are used for this measurement.
- For measurement below 1 GHz, set RBW = 100 KHz, VBW ≥ 100 KHz, SWEEP=AUTO.
- For measurement above 1 GHz, set RBW = 1 MHz, VBW = 1 MHz (Peak) & VBW = 10 Hz (Average), SWEEP=AUTO.
- If the emission is pulsed, modified the unit for continuous operation, then use the settings above for measurements, then correct the reading by subtracting the peak-average correction factor derived from the appropriate duty cycle calculation. See Section 15.35(b) and (c).

**6.7.3. Test Arrangement**

Please refer to Test Arrangement in Sec. 3.5 for details of test setup for emission measurements.

**6.7.4. Test Equipment List**

Test Instruments	Manufacturer	Model No.	Serial No.	Frequency Range
Spectrum Analyzer/ EMI Receiver	Advantest	R3271	15050203	100 Hz to 32 GHz with external mixer for frequency above 32 GHz
Microwave Amplifier	Hewlett Packard	HP 83017A		1 GHz to 26.5 GHz
Biconilog Antenna	EMCO	3143	1029	20 MHz to 2 GHz
Horn Antenna	EMCO	3155	9701-5061	1 GHz – 18 GHz
Horn Antenna	EMCO	3160-09	..	18 GHz – 26.5 GHz
Horn Antenna	EMCO	3160-10	..	26.5 GHz – 40 GHz
Mixer	Tektronix	118-0098-00	..	18 GHz – 26.5 GHz
Mixer	Tektronix	119-0098-00	..	26.5 GHz – 40 GHz

**ULTRATECH GROUP OF LABS**

3000 Bristol Circle, Oakville, Ontario, Canada L6H 6G4  
 Tel. #: 905-829-1570, Fax. #: 905-829-8050, Email: [vhk.ultratech@sympatico.ca](mailto:vhk.ultratech@sympatico.ca), Website: <http://www.ultratech-labs.com>

File #: IVI73-FTX  
 June 20, 2000

- Assessed by ITI (UK) Competent Body, NVLAP (USA) Accreditation Body & ACA/AUSTEL (Australia)
- Accredited by Industry Canada (Canada) under ACC-LAB (Europe/Canada MRA)
- Recognized/Listed by FCC (USA)
- All test results contained in this engineering test report are traceable to National Institute of Standards and Technology (NIST)

6.7.5. Test Data

BAND 3 – Lowest Frequency (911.4 MHz)							
FREQUENCY (MHz)	RF PEAK LEVEL (dBuV/m)	RF AVG LEVEL (dBuV/m)	ANTENNA PLANE (H/V)	LIMIT 15.209 (dBuV/m)	LIMIT 15.249 (dBuV/m)	MARGIN (dB)	PASS/ FAIL
911.40	91.00	--	V	--	94.0	-3.0	PASS
911.40	84.16	--	H	--	94.0	-9.8	PASS
1822.80	43.16	43.16	V	54.0	--	-10.8	PASS
1822.80	42.66	42.66	H	54.0	--	-11.3	PASS
2734.20	44.59	44.59	V	54.0	--	-9.4	PASS

The emissions were scanned from 10 MHz to 10 GHz and all emissions less 20 dB below the limits were recorded. Refer to Exhibit 9 test plots # 5 and # 6 for details.

Transmitter Radiated Emissions Measurements at 3 Meters OFTS  
 TRANSMIT Freq.: 911.4 MHz  
 IVI Checkmate Inc.  
 Elite 770 Intelligent Base, Model Elite 770 Intelligent Base

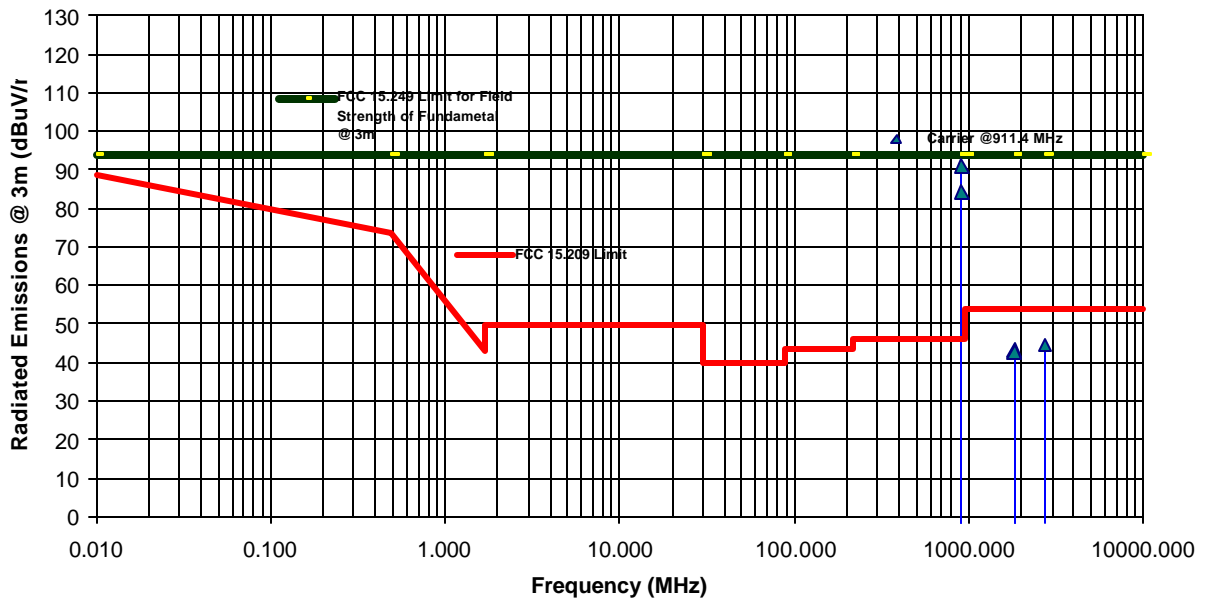

ULTRATECH GROUP OF LABS

3000 Bristol Circle, Oakville, Ontario, Canada L6H 6G4  
 Tel. #: 905-829-1570, Fax. #: 905-829-8050, Email: [vhk.ultratech@sympatico.ca](mailto:vhk.ultratech@sympatico.ca), Website: <http://www.ultratech-labs.com>

File #: IVI73-FTX  
 June 20, 2000

- Assessed by ITI (UK) Competent Body, NVLAP (USA) Accreditation Body & ACA/AUSTEL (Australia)
- Accredited by Industry Canada (Canada) under ACC-LAB (Europe/Canada MRA)
- Recognized/Listed by FCC (USA)
- All test results contained in this engineering test report are traceable to National Institute of Standards and Technology (NIST)

BAND 3 – Highest Frequency (914.2 MHz)							
FREQUENCY (MHz)	RF PEAK LEVEL (dBμV/m)	RF AVG LEVEL (dBμV/m)	ANTENNA PLANE (H/V)	LIMIT 15.209 (dBμV/m)	LIMIT 15.249 (dBμV/m)	MARGIN (dB)	PASS/ FAIL
914.2	90.58	--	V	--	94.0	-3.4	PASS
914.2	87.85	--	H	--	94.0	-6.2	PASS
1828.4	42.91	42.91	V	54.0	--	-11.1	PASS
1828.4	42.06	42.06	H	54.0	--	-11.9	PASS
2742.6	43.59	43.59	V	54.0	--	-10.4	PASS
2742.6	43.56	43.56	H	54.0	--	-10.4	PASS

The emissions were scanned from 10 MHz to 10 GHz and all emissions less 20 dB below the limits were recorded. Refer to Exhibit 9 test plots # 7 and # 8 for details.

**Transmitter Radiated Emissions Measurements at 3 Meters OFTS**  
 TRANSMIT Freq.: 914.2 MHz  
 IVI Checkmate Inc.  
 Elite 770 Intelligent Base, Model Elite 770 Intelligent Base

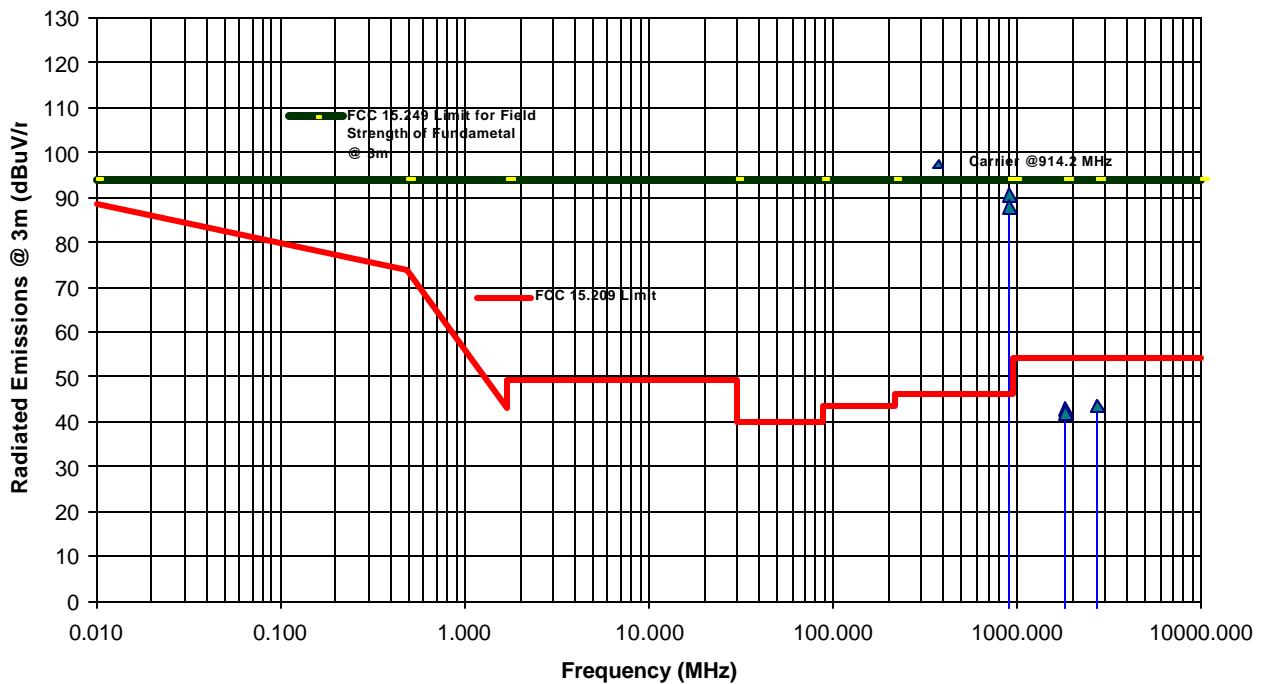

**ULTRATECH GROUP OF LABS**

3000 Bristol Circle, Oakville, Ontario, Canada L6H 6G4  
 Tel. #: 905-829-1570, Fax. #: 905-829-8050, Email: [vhk.ultratech@sympatico.ca](mailto:vhk.ultratech@sympatico.ca), Website: <http://www.ultratech-labs.com>

File #: IVI73-FTX  
 June 20, 2000

- Assessed by ITI (UK) Competent Body, NVLAP (USA) Accreditation Body & ACA/AUSTEL (Australia)
- Accredited by Industry Canada (Canada) under ACC-LAB (Europe/Canada MRA)
- Recognized/Listed by FCC (USA)
- All test results contained in this engineering test report are traceable to National Institute of Standards and Technology (NIST)

BAND 4 – Lowest Frequency (915.8 MHz)							
FREQUENCY (MHz)	RF PEAK LEVEL (dBuV/m)	RF AVG LEVEL (dBuV/m)	ANTENNA PLANE (H/V)	LIMIT 15.209 (dBuV/m)	LIMIT 15.249 (dBuV/m)	MARGIN (dB)	PASS/ FAIL
915.80	90.53	--	V	--	94.0	-3.5	PASS
915.80	86.55	--	H	--	94.0	-7.5	PASS
1831.60	41.84	41.84	V	54.0	--	-12.2	PASS
1831.60	41.31	41.31	H	54.0	--	-12.7	PASS
2747.40	43.03	43.03	V	54.0	--	-11.0	PASS
2747.40	42.28	42.28	H	54.0	--	-11.7	PASS

The emissions were scanned from 10 MHz to 10 GHz and all emissions less 20 dB below the limits were recorded. Refer to Exhibit 9 test plots # 9 and # 10 for details.

**Transmitter Radiated Emissions Measurements at 3 Meters OETS**  
**TRANSMIT Freq.: 915.8MHz**  
**IVI Checkmate Inc.**  
**Elite 770 Intelligent Base, Model Elite 770 Intelligent Base**

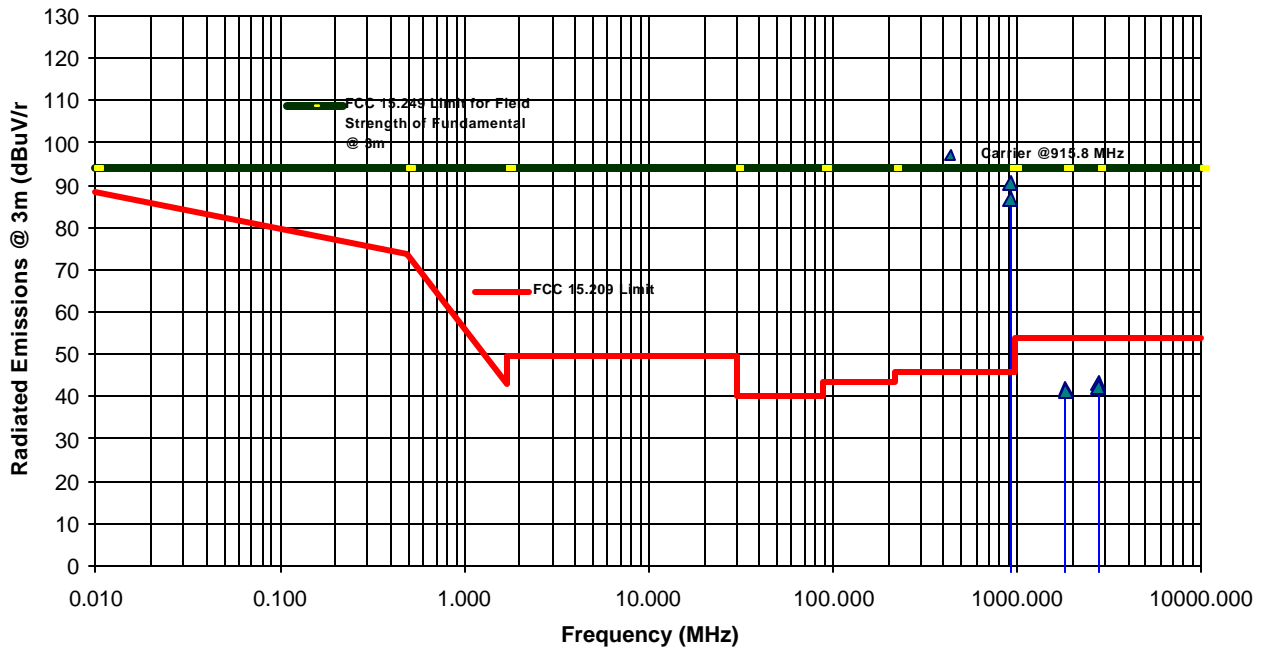

**ULTRATECH GROUP OF LABS**

3000 Bristol Circle, Oakville, Ontario, Canada L6H 6G4  
 Tel. #: 905-829-1570, Fax. #: 905-829-8050, Email: [vhk.ultratech@sympatico.ca](mailto:vhk.ultratech@sympatico.ca), Website: <http://www.ultratech-labs.com>

File #: IVI73-FTX  
 June 20, 2000

- Assessed by ITI (UK) Competent Body, NVLAP (USA) Accreditation Body & ACA/AUSTEL (Australia)
- Accredited by Industry Canada (Canada) under ACC-LAB (Europe/Canada MRA)
- Recognized/Listed by FCC (USA)
- All test results contained in this engineering test report are traceable to National Institute of Standards and Technology (NIST)

BAND 4 – Lowest Frequency (918.6 MHz)							
FREQUENCY (MHz)	RF PEAK LEVEL (dBuV/m)	RF AVG LEVEL (dBuV/m)	ANTENNA PLANE (H/V)	LIMIT 15.209 (dBuV/m)	LIMIT 15.249 (dBuV/m)	MARGIN (dB)	PASS/FAIL
918.60	91.64	--	V	--	94.0	-2.4	PASS
918.60	87.88	--	H	--	94.0	-6.1	PASS
1837.20	42.34	42.34	V	54.0	--	-11.7	PASS
1837.20	41.19	41.19	H	54.0	--	-12.8	PASS
2755.80	42.81	42.81	V	54.0	--	-11.2	PASS

The emissions were scanned from 10 MHz to 10 GHz and all emissions less 20 dB below the limits were recorded. Refer to Exhibit 9 test plots # 11 and # 12 for details.

Transmitter Radiated Emissions Measurements at 3 Meters OFTS  
 TRANSMIT Freq.: 918.6MHz  
 IVI Checkmate Inc.  
 Elite 770 Intelligent Base, Model Elite 770 Intelligent Base

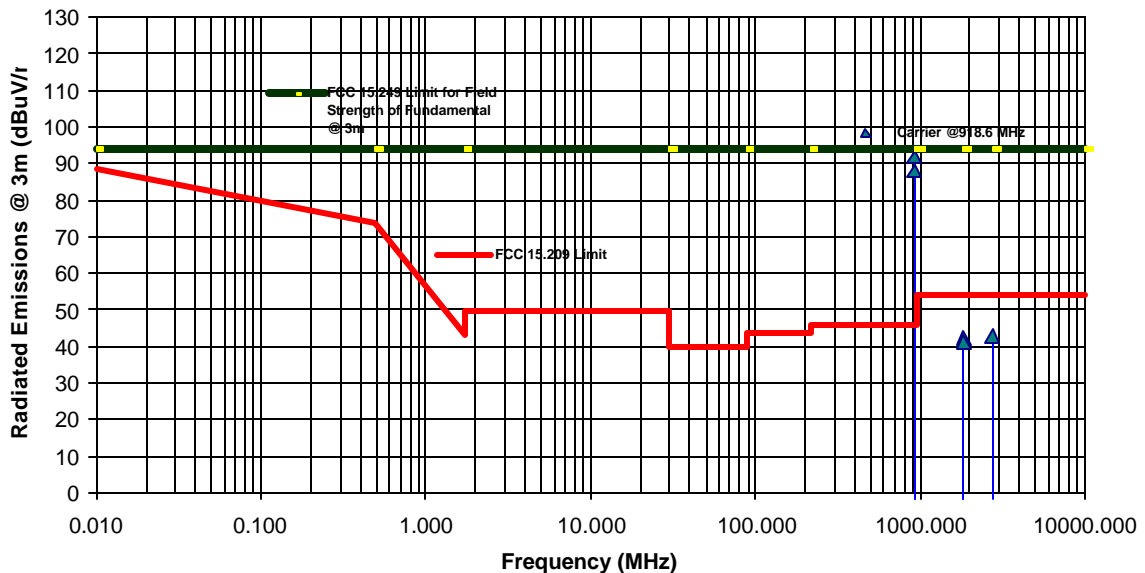

6.7.6. Photographs of Test Setup

Refer to the Photographs #3 & #4 in Exhibit 10 for setup and arrangement of equipment under tests.

ULTRATECH GROUP OF LABS

3000 Bristol Circle, Oakville, Ontario, Canada L6H 6G4  
 Tel. #: 905-829-1570, Fax. #: 905-829-8050, Email: [vhk.ultratech@sympatico.ca](mailto:vhk.ultratech@sympatico.ca), Website: <http://www.ultratech-labs.com>

File #: IVI73-FTX  
 June 20, 2000

- Assessed by ITI (UK) Competent Body, NVLAP (USA) Accreditation Body & ACA/AUSTEL (Australia)
- Accredited by Industry Canada (Canada) under ACC-LAB (Europe/Canada MRA)
- Recognized/Listed by FCC (USA)
- All test results contained in this engineering test report are traceable to National Institute of Standards and Technology (NIST)

## EXHIBIT 7. MEASUREMENT UNCERTAINTY

The measurement uncertainties stated were calculated in accordance with the requirements of NIST Technical Note 1297 and NIS 81 (1994)

### 7.1. LINE CONDUCTED EMISSION MEASUREMENT UNCERTAINTY

CONTRIBUTION (Line Conducted)	PROBABILITY DISTRIBUTION	UNCERTAINTY (dB)	
		9-150 kHz	0.15-30 MHz
EMI Receiver specification	Rectangular	±1.5	±1.5
LISN coupling specification	Rectangular	±1.5	±1.5
Cable and Input Transient Limiter calibration	Normal (k=2)	±0.3	±0.5
Mismatch: Receiver VRC $\Gamma_1 = 0.03$ LISN VRC $\Gamma_R = 0.8(9 \text{ kHz}) 0.2 (30 \text{ MHz})$ Uncertainty limits $20\text{Log}(1 \pm \Gamma_1 \Gamma_R)$	U-Shaped	±0.2	±0.3
System repeatability	Std. deviation	±0.2	±0.05
Repeatability of EUT	--	--	--
Combined standard uncertainty	Normal	±1.25	±1.30
Expanded uncertainty U	Normal (k=2)	±2.50	±2.60

Sample Calculation for Measurement Accuracy in 450 kHz to 30 MHz Band:

$$u_c(y) = \sqrt{\sum_{i=1}^m u_i^2(y)} = \pm \sqrt{(1.5^2 + 1.5^2)/3 + (0.5/2)^2 + (0.05/2)^2 + 0.35^2} = \pm 1.30 \text{ dB}$$

$$U = 2u_c(y) = \pm 2.6 \text{ dB}$$

#### ULTRATECH GROUP OF LABS

3000 Bristol Circle, Oakville, Ontario, Canada L6H 6G4  
 Tel. #: 905-829-1570, Fax. #: 905-829-8050, Email: [vhk.ultratech@sympatico.ca](mailto:vhk.ultratech@sympatico.ca), Website: <http://www.ultratech-labs.com>

File #: IVI73-FTX  
 June 20, 2000

- Assessed by ITI (UK) Competent Body, NVLAP (USA) Accreditation Body & ACA/AUSTEL (Australia)
- Accredited by Industry Canada (Canada) under ACC-LAB (Europe/Canada MRA)
- Recognized/Listed by FCC (USA)
- All test results contained in this engineering test report are traceable to National Institute of Standards and Technology (NIST)



## 7.2. RADIATED EMISSION MEASUREMENT UNCERTAINTY

CONTRIBUTION (Radiated Emissions)	PROBABILITY DISTRIBUTION	UNCERTAINTY ( $\pm$ dB)	
		3 m	10 m
Antenna Factor Calibration	Normal (k=2)	$\pm 1.0$	$\pm 1.0$
Cable Loss Calibration	Normal (k=2)	$\pm 0.3$	$\pm 0.5$
EMI Receiver specification	Rectangular	$\pm 1.5$	$\pm 1.5$
Antenna Directivit	Rectangular	+0.5	+0.5
Antenna factor variation with height	Rectangular	$\pm 2.0$	$\pm 0.5$
Antenna phase center variation	Rectangular	0.0	$\pm 0.2$
Antenna factor frequency interpolation	Rectangular	$\pm 0.25$	$\pm 0.25$
Measurement distance variation	Rectangular	$\pm 0.6$	$\pm 0.4$
Site imperfections	Rectangular	$\pm 2.0$	$\pm 2.0$
Mismatch: Receiver VRC $\Gamma_1 = 0.2$ Antenna VRC $\Gamma_R = 0.67(\text{Bi}) 0.3 (\text{Lp})$ Uncertainty limits $20\text{Log}(1 \pm \Gamma_1 \Gamma_R)$	U-Shaped	+1.1 -1.25	$\pm 0.5$
System repeatability	Std. Deviation	$\pm 0.5$	$\pm 0.5$
Repeatability of EUT		-	-
Combined standard uncertainty	Normal	+2.19 / -2.21	+1.74 / -1.72
Expanded uncertainty U	Normal (k=2)	+4.38 / -4.42	+3.48 / -3.44

Calculation for maximum uncertainty when 3m biconical antenna including a factor of k=2 is used:

$$U = 2u_c(y) = 2x(+2.19) = +4.38 \text{ dB} \quad \text{And} \quad U = 2u_c(y) = 2x(-2.21) = -4.42 \text{ dB}$$

### ULTRATECH GROUP OF LABS

3000 Bristol Circle, Oakville, Ontario, Canada L6H 6G4  
 Tel. #: 905-829-1570, Fax. #: 905-829-8050, Email: [vhk.ultratech@sympatico.ca](mailto:vhk.ultratech@sympatico.ca), Website: <http://www.ultratech-labs.com>

File #: IVI73-FTX  
 June 20, 2000

- Assessed by ITI (UK) Competent Body, NVLAP (USA) Accreditation Body & ACA/AUSTEL (Australia)
- Accredited by Industry Canada (Canada) under ACC-LAB (Europe/Canada MRA)
- Recognized/Listed by FCC (USA)
- All test results contained in this engineering test report are traceable to National Institute of Standards and Technology (NIST)

## EXHIBIT 8. MEASUREMENT METHODS

### 8.1. GENERAL TEST CONDITIONS

The following test conditions shall be applied throughout the tests covered in this report.

#### 8.1.1. Normal temperature and humidity

- Normal temperature: +15°C to +35°C
- Relative Humidity: +20% to 75%

The actual values during tests shall be recorded in the test report.

#### 8.1.2. Normal power source

##### 8.1.2.1. Mains Voltage

The nominal test voltage of the equipment to be connected to mains shall be the nominal mains voltage which is the declared voltage or any of the declared voltages for which the equipment was designed.

The frequency of test power source corresponding to the AC mains shall be between 59 Hz and 61 Hz.

##### 8.1.2.2. Battery Power Source.

For operation from battery power sources, the nominal test voltage shall be as declared by the equipment manufacturer. This shall be recorded in the test report.

#### 8.1.3. Operating Condition of Equipment under Test

- All tests were carried out while the equipment operated at the following frequencies:
  - The lowest operating frequency,
  - The middle operating frequency and
  - The highest operating frequency
- Modulation were applied using the Test Data sequence
- The transmitter was operated at the highest output power, or in the case the equipment able to operate at more than one power level, at the lowest and highest output powers

---

### ULTRATECH GROUP OF LABS

3000 Bristol Circle, Oakville, Ontario, Canada L6H 6G4  
Tel. #: 905-829-1570, Fax. #: 905-829-8050, Email: [vhk.ultratech@sympatico.ca](mailto:vhk.ultratech@sympatico.ca), Website: <http://www.ultratech-labs.com>

File #: IVI73-FTX  
June 20, 2000

- Assessed by ITI (UK) Competent Body, NVLAP (USA) Accreditation Body & ACA/AUSTEL (Australia)
- Accredited by Industry Canada (Canada) under ACC-LAB (Europe/Canada MRA)
- Recognized/Listed by FCC (USA )
- All test results contained in this engineering test report are traceable to National Institute of Standards and Technology (NIST)

## 8.2. METHOD OF MEASUREMENTS - AC MAINS CONDUCTED EMISSIONS

- AC Mains conducted emissions measurements were performed in accordance with the standard against appropriate limits for each detector function.
- The test was performed in the shielded room, 16'(L) by 16'(W) by 12'(H).
- The test was performed over the frequency range from 450 kHz to 30 MHz to determine the line-to-ground radio noise voltage which was conducted from the EUT power-input terminals that were directly connected to a public power network.
- The EUT normally received power from another device that connects to the public utility ac power lines, measurements would be made on that device with the EUT in operation to ensure that the device continues to comply with the appropriate limits while providing the EUT with power.
- If the EUT operates only from internal or dedicated batteries, with no provisions for connection to the public utility ac power lines, AC Mains conducted measurements are not required.
- Table-top devices were placed on a platform of nominal size 1 m by 1.5m raised 80 cm above the conducting ground plane.
- The EUT current-carrying power lead, except the ground (safety) lead, was individually connected through a LISN to the power source. All unused 50-Ohm connectors of the LISN was terminated in 50-ohm when not connected to the measuring instruments.
- The line cord of the EUT connected to one LISN which was connected to the measuring instrument. Those power cords for the units of devices not under measurement were connected to a separate multiple ac outlet. Drawings and photographs of typically conducted emission test setups were shown in the Test Report. Each current-carrying conductor of the EUT shall be individually tested.
- The EUT was normally operated with a ground (safety) connection, the EUT was connected to the ground at the LISN through a conductor provided in the lead from the ac power mains to the LISN.
- The excess length of the power cord was folded back and forth in an 8-shape on a wooden strip with a vertical prong located on the top of the LISN case.
- The EUT was set-up in its typical configuration and operated in its various modes as described in 3.2 of the test report.
- A preliminary scan was made by using spectrum analyzer system with the detector function set to PEAK mode (9 KHz RBW, VBW > RBW), frequency span 450 kHz to 30 MHz.
- The maximum conducted emission for a given mode of operation was found by using the following step-by-step procedure:
  - Step1. Monitor the frequency range of interest at a fixed EUT azimuth.
  - Step2. Manipulate the system cables and peripheral devices to produce highest amplitude signal relative to the limit. Note the amplitude and frequency of the suspect signal.
  - Step3. The effects of various modes of operation is examined. This is done by varying equipment operation modes as step 2 is being performed.
  - Step4. After completing step 1 through 3, record EUT and peripheral device configuration, mode of operation, cable configuration, signal levels and frequencies for final test.
- Each highest signal level at the maximized test configuration was zoomed in a small frequency span on the spectrum analyzer's display (the manipulation of cables and peripheral devices and EUT operation modes might have to be repeated to obtain the highest signal level with the spectrum analyzer set to PEAK detector mode 10 KHz RBW and VBW > RBW). The spectrum analyzer was then set to CISPR QUASI-PEAK detector mode (9 KHz RBW, 1 MHz VBW) and AVERAGE detector mode (10 kHz RBW, 1 Hz VBW). The final highest RF signal levels and frequencies were record.

---

### ULTRATECH GROUP OF LABS

3000 Bristol Circle, Oakville, Ontario, Canada L6H 6G4  
Tel. #: 905-829-1570, Fax. #: 905-829-8050, Email: [vhk.ultratech@sympatico.ca](mailto:vhk.ultratech@sympatico.ca), Website: <http://www.ultratech-labs.com>

File #: IVI73-FTX  
June 20, 2000

- Assessed by ITI (UK) Competent Body, NVLAP (USA) Accreditation Body & ACA/AUSTEL (Australia)
- Accredited by Industry Canada (Canada) under ACC-LAB (Europe/Canada MRA)
- Recognized/Listed by FCC (USA )
- *All test results contained in this engineering test report are traceable to National Institute of Standards and Technology (NIST)*

- **Broad-band ac Powerline conducted emissions**:- If the EUT exhibits ac Powerline conducted emissions that exceed the limit with the instrument set to the quasi-peak mode, then measurements should be made in the average mode. If the amplitude measured in the quasi-peak mode is at least 6 dB higher than the amplitude measured in the average mode, the level measured in quasi peak mode may be reduced by 13 dB before comparing it to the limit.

### 8.3. EFFECTIVE RADIATED POWER

- The following shall be applied to the combination(s) of the radio device and its intended antenna(e).
- If the RF level is user adjustable, all measurements shall be made with the highest power level available to the user for that combination.
- The following method of measurement shall apply to both conducted and radiated measurements.
- The radiated measurements are performed at the Ultratech Calibrated Open Field Test Site.
- The measurement shall be performed using normal operation of the equipment with modulation.

Test procedure shall be as follows:

#### Step 1: Duty Cycle measurements

- Using a spectrum analyzer with the frequency span set to 0 Hz and the sweep time set at a suitable value to capture the envelope peaks and the duty cycle of the transmitter output signal;
- The duty cycle of the transmitter,  $x = \text{Tx on} / (\text{Tx on} + \text{Tx off})$  with  $0 < x < 1$ , is measure and recorded in the test report. For the purpose of testing, the equipment shall be operated with a duty cycle that is equal or more than 0.1.

#### Step 2: Calculation of Peak and Average EIRP

- The peak output power of the transmitter shall be determined using a wideband, calibrated RF Peak Power Meter with the power sensor with an integration period that exceeds the repetition period of the transmitter by a factor 5 or more. The observed value shall be recorded as “P” (in dBm);
- The Average EIRP, shall be calculated from the above measured power output “A”, the observed duty cycle x, and the applicable antenna assembly gain “G” in dBi, according to the formula:

$$\text{Peak EIRP} = P + G$$

$$\text{Average EIRP} = \text{Peak EIRP} + 10\log(1/x)$$

Figure 1.

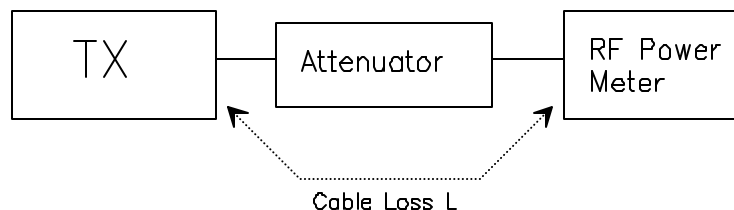

#### Step 3: Substitution Method. See Figure 2

- (a) The measurements was performed in the absence of modulation (un-modulated)
- (b) Test was performed at listed 3m open area test site (listed with FCC, IC, ITI, NVLAP, ACA & VCCI).
- (c) The transmitter under test was placed at the specified height on a non-conducting turntable (80 cm height)
- (d) The dipole test antenna was used and tuned to the transmitter carrier frequency.
- (e) The spectrum analyzer was tuned to transmitter carrier frequency. The test antenna was lowered or raised from 1 to 4 meters until the maximum signal level was detected.
- (f) The transmitter was rotated through 360° about a vertical axis until a higher maximum signal was received.

### ULTRATECH GROUP OF LABS

3000 Bristol Circle, Oakville, Ontario, Canada L6H 6G4  
Tel. #: 905-829-1570, Fax. #: 905-829-8050, Email: [vhk.ultratech@sympatico.ca](mailto:vhk.ultratech@sympatico.ca), Website: <http://www.ultratech-labs.com>

File #: IVI73-FTX  
June 20, 2000

- Assessed by ITI (UK) Competent Body, NVLAP (USA) Accreditation Body & ACA/AUSTEL (Australia)
- Accredited by Industry Canada (Canada) under ACC-LAB (Europe/Canada MRA)
- Recognized/Listed by FCC (USA)
- All test results contained in this engineering test report are traceable to National Institute of Standards and Technology (NIST)

- (g) The test antenna was lowered or raised again from 1 to 4 meters until a maximum was obtained. This level was recorded.
- (h) The substitution dipole antenna and the signal generator replaced the transmitter and antenna under test in the same position, and the substitution dipole antenna was placed in vertical polarization. The test dipole antenna was lowered or raised as necessary to ensure that the maximum signal is still received.
- (i) The input signal to the substitution antenna was adjusted in level until an equal or a known related level to that detected from the transmitter was obtained in the test receiver. The maximum carrier radiated power is equal to the power supply by the generator.
- (j) The substitution antenna gain and cable loss were added to the signal generator level for the corrected ERP level.
- (k) Repeat steps (c) to (j) with the substitution antenna oriented in horizontal polarization.
- (l) Actual gain of the EUT's antenna is the difference of the measured ERP and measured RF power at the RF port. Correct the antenna gain if necessary.

Figure 2

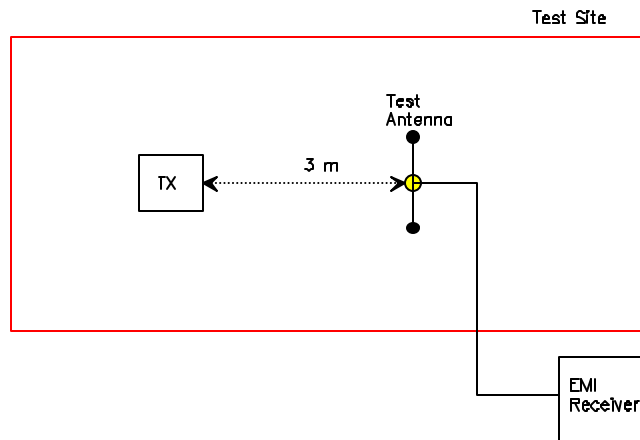
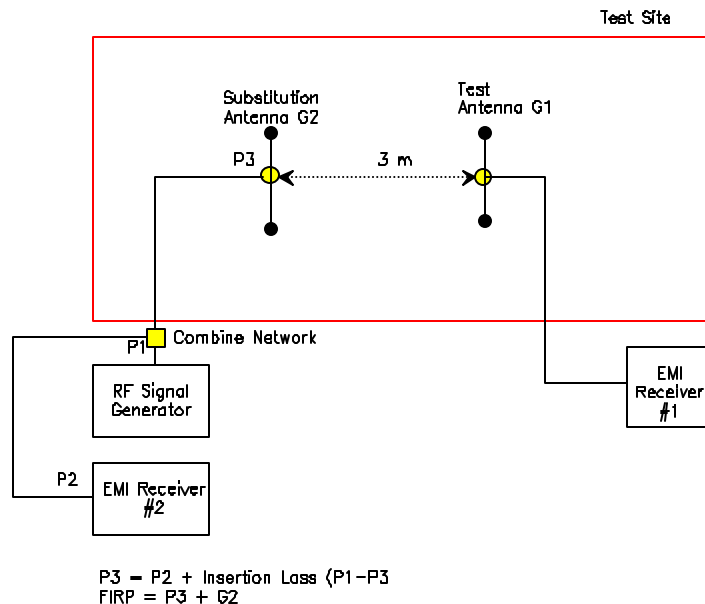

Figure 3



**ULTRATECH GROUP OF LABS**

3000 Bristol Circle, Oakville, Ontario, Canada L6H 6G4  
 Tel. #: 905-829-1570, Fax. #: 905-829-8050, Email: [vhk.ultratech@sympatico.ca](mailto:vhk.ultratech@sympatico.ca), Website: <http://www.ultratech-labs.com>

File #: IVI73-FTX  
 June 20, 2000

- Assessed by ITI (UK) Competent Body, NVLAP (USA) Accreditation Body & ACA/AUSTEL (Australia)
- Accredited by Industry Canada (Canada) under ACC-LAB (Europe/Canada MRA)
- Recognized/Listed by FCC (USA)
- All test results contained in this engineering test report are traceable to National Institute of Standards and Technology (NIST)

## 8.4. SPURIOUS EMISSIONS (RADIATED)

The spurious emissions were scanned from the lowest frequency generated by the EUT or 10 MHz whichever is lower to 10<sup>th</sup> harmonic of the highest frequency generated by the EUT.

### 8.4.1. Spurious Emissions (Radiated)

- The radiated emission measurements were performed at the UltraTech's 3 Meter Open Field Test Site (OFTS) situated in the Town of Oakville, province of Ontario. The Attenuation Characteristics of OFTS have been filed to FCC, Industry Canada, ACA/Austel, NVLap and ITI.
- Radiated emissions measurements were made using the following test instruments:
  1. Calibrated EMCO BiconiLog antenna in the frequency range from 30 MHz to 2000 MHz.
  2. Calibrated Emco Horn antennas in the frequency range above 1000 MHz (1GHz - 40 GHz).
  3. Calibrated Advantest spectrum analyzer and pre-selector were used. The spectrum analyzer would be used as follows:

For frequencies below 1 GHz:

- Resolution BW: 100 kHz
- Video BW: same or greater
- Detector Mode: Positive Peak
- Averaging: Off
- Span: 100 MHz
- Amplitude: Adjust for middle of the instrument's range
- Sweep Time: Auto

For frequencies above 1 GHz:

- Resolution BW: 1 MHz
- Video BW: same or greater
- Detector Mode: Positive Peak
- Averaging: Off
- Span: 500 MHz
- Amplitude: Adjust for middle of the instrument's range
- Sweep Time: Auto

- The frequencies of emissions were first detected. Then the amplitude of the emissions was measured at the specified measurement distance using required antenna height, polarization, and detector characteristics.
- During this process, cables and peripheral devices were manipulated within the range of likely configuration.
- For each mode of operation required to be tested, the frequency spectrum was monitored. Variations in antenna heights (from 1 meter to 4 meters above the ground plane), antenna polarization (horizontal plane and vertical plane), cable placement and peripheral placement were explored to produce the highest amplitude signal relative to the limit.

---

## ULTRATECH GROUP OF LABS

3000 Bristol Circle, Oakville, Ontario, Canada L6H 6G4  
Tel. #: 905-829-1570, Fax. #: 905-829-8050, Email: [vhk.ultratech@sympatico.ca](mailto:vhk.ultratech@sympatico.ca), Website: <http://www.ultratech-labs.com>

File #: IVI73-FTX  
June 20, 2000

- Assessed by ITI (UK) Competent Body, NVLAP (USA) Accreditation Body & ACA/AUSTEL (Australia)
- Accredited by Industry Canada (Canada) under ACC-LAB (Europe/Canada MRA)
- Recognized/Listed by FCC (USA)
- *All test results contained in this engineering test report are traceable to National Institute of Standards and Technology (NIST)*

The maximum radiated emission for a given mode of operation was found by using the following step-by-step procedure:

- Step1: Monitor the frequency range of interest at a fixed antenna height and EUT azimuth.
- Step2: Manipulate the system cables to produce highest amplitude signal relative to the limit. Note the amplitude and frequency of the suspect signal.
- Step3: Rotate the EUT 360 degrees to maximize the suspected highest amplitude signal. If the signal or another at a different frequency is observed to exceed the previously noted highest amplitude signal by 1 dB or more, go back to the azimuth and repeat Step 2. Otherwise, orient the EUT azimuth to repeat the highest amplitude observation and proceed.
- Step4: Move the antenna over its full allowable range of travel (1 to 4 meters) to maximize the suspected highest amplitude signal. If the signal or another at a different frequency is observed to exceed the previously noted highest amplitude signal by 1 dB or more, return to Step 2 with the highest amplitude observation and proceed.
- Step5: Change the polarization of the antenna and repeat Step 2 through 4. Compare the resulting suspected highest amplitude signal with that found for the other polarization. Select and note the higher of the two signals. This signal is termed the highest observed signal with respect to the limit for this EUT operational mode.
- Step6: The effects of various modes of operation is examined. This is done by varying the equipment modes as steps 2 through 5 are being performed.
- Step7: After completing steps 1 through 6, record the final highest emission level, frequency, antenna polarization and detector mode of the measuring instrument.

#### Calculation of Field Strength:

The field strength is calculated by adding the calibrated antenna factor and cable factor, and subtracting the Amplifier gain (if any) from the measured reading. The basic equation with a sample calculation is as follows:

$$FS = RA + AF + CF - AG$$

Where	FS	=	Field Strength
	RA	=	Receiver/Analyzer Reading
	AF	=	Antenna Factor
	CF	=	Cable Attenuation Factor
	AG	=	Amplifier Gain

Example: If a receiver reading of 60.0 dB $\mu$ V is obtained, the antenna factor of 7.0 dB/m and cable factor of 1.0 dB are added, and the amplifier gain of 30 dB is subtracted. The actual field strength will be:

$$\text{Field Level} = 60 + 7.0 + 1.0 - 30 = 38.0 \text{ dB}\mu\text{V/m.}$$

$$\text{Field Level} = 10^{(38/20)} = 79.43 \mu\text{V/m.}$$

---

#### ULTRATECH GROUP OF LABS

3000 Bristol Circle, Oakville, Ontario, Canada L6H 6G4  
Tel. #: 905-829-1570, Fax. #: 905-829-8050, Email: [vhk.ultratech@sympatico.ca](mailto:vhk.ultratech@sympatico.ca), Website: <http://www.ultratech-labs.com>

File #: IVI73-FTX  
June 20, 2000

- Assessed by ITI (UK) Competent Body, NVLAP (USA) Accreditation Body & ACA/AUSTEL (Australia)
- Accredited by Industry Canada (Canada) under ACC-LAB (Europe/Canada MRA)
- Recognized/Listed by FCC (USA)
- All test results contained in this engineering test report are traceable to National Institute of Standards and Technology (NIST)

## EXHIBIT 9. MEASUREMENT DATA PLOTS

---

### ULTRATECH GROUP OF LABS

3000 Bristol Circle, Oakville, Ontario, Canada L6H 6G4

Tel. #: 905-829-1570, Fax. #: 905-829-8050, Email: [vhk.ultratech@sympatico.ca](mailto:vhk.ultratech@sympatico.ca), Website: <http://www.ultratech-labs.com>

File #: IVI73-FTX

June 20, 2000

- Assessed by ITI (UK) Competent Body, NVLAP (USA) Accreditation Body & ACA/AUSTEL (Australia)
- Accredited by Industry Canada (Canada) under ACC-LAB (Europe/Canada MRA)
- Recognized/Listed by FCC (USA)
- *All test results contained in this engineering test report are traceable to National Institute of Standards and Technology (NIST)*



## EXHIBIT 10. TEST SETUP PHOTOS

---

### ULTRATECH GROUP OF LABS

3000 Bristol Circle, Oakville, Ontario, Canada L6H 6G4

Tel. #: 905-829-1570, Fax. #: 905-829-8050, Email: [vhk.ultratech@sympatico.ca](mailto:vhk.ultratech@sympatico.ca), Website: <http://www.ultratech-labs.com>

File #: IVI73-FTX

June 20, 2000

- Assessed by ITI (UK) Competent Body, NVLAP (USA) Accreditation Body & ACA/AUSTEL (Australia)
- Accredited by Industry Canada (Canada) under ACC-LAB (Europe/Canada MRA)
- Recognized/Listed by FCC (USA)
- *All test results contained in this engineering test report are traceable to National Institute of Standards and Technology (NIST)*

## EXHIBIT 11. EXTERNAL EUT PHOTOS

---

### ULTRATECH GROUP OF LABS

3000 Bristol Circle, Oakville, Ontario, Canada L6H 6G4

Tel. #: 905-829-1570, Fax. #: 905-829-8050, Email: [vhk.ultratech@sympatico.ca](mailto:vhk.ultratech@sympatico.ca), Website: <http://www.ultratech-labs.com>

File #: IVI73-FTX

June 20, 2000

- Assessed by ITI (UK) Competent Body, NVLAP (USA) Accreditation Body & ACA/AUSTEL (Australia)
- Accredited by Industry Canada (Canada) under ACC-LAB (Europe/Canada MRA)
- Recognized/Listed by FCC (USA)
- *All test results contained in this engineering test report are traceable to National Institute of Standards and Technology (NIST)*

## EXHIBIT 12. INTERNAL EUT PHOTOS

---

### ULTRATECH GROUP OF LABS

3000 Bristol Circle, Oakville, Ontario, Canada L6H 6G4

Tel. #: 905-829-1570, Fax. #: 905-829-8050, Email: [vhk.ultratech@sympatico.ca](mailto:vhk.ultratech@sympatico.ca), Website: <http://www.ultratech-labs.com>

File #: IVI73-FTX

June 20, 2000

- Assessed by ITI (UK) Competent Body, NVLAP (USA) Accreditation Body & ACA/AUSTEL (Australia)
- Accredited by Industry Canada (Canada) under ACC-LAB (Europe/Canada MRA)
- Recognized/Listed by FCC (USA )
- *All test results contained in this engineering test report are traceable to National Institute of Standards and Technology (NIST)*

## EXHIBIT 13. COVER LETTERS

---

### ULTRATECH GROUP OF LABS

3000 Bristol Circle, Oakville, Ontario, Canada L6H 6G4

Tel. #: 905-829-1570, Fax. #: 905-829-8050, Email: [vhk.ultratech@sympatico.ca](mailto:vhk.ultratech@sympatico.ca), Website: <http://www.ultratech-labs.com>

File #: IVI73-FTX

June 20, 2000

- Assessed by ITI (UK) Competent Body, NVLAP (USA) Accreditation Body & ACA/AUSTEL (Australia)
- Accredited by Industry Canada (Canada) under ACC-LAB (Europe/Canada MRA)
- Recognized/Listed by FCC (USA )
- *All test results contained in this engineering test report are traceable to National Institute of Standards and Technology (NIST)*

## EXHIBIT 14. ATTESTATION STATEMENTS

None.

---

### ULTRATECH GROUP OF LABS

3000 Bristol Circle, Oakville, Ontario, Canada L6H 6G4

Tel. #: 905-829-1570, Fax. #: 905-829-8050, Email: [vhk.ultratech@sympatico.ca](mailto:vhk.ultratech@sympatico.ca), Website: <http://www.ultratech-labs.com>

File #: IVI73-FTX

June 20, 2000

- Assessed by ITI (UK) Competent Body, NVLAP (USA) Accreditation Body & ACA/AUSTEL (Australia)
- Accredited by Industry Canada (Canada) under ACC-LAB (Europe/Canada MRA)
- Recognized/Listed by FCC (USA )
- *All test results contained in this engineering test report are traceable to National Institute of Standards and Technology (NIST)*

## EXHIBIT 15. APPLICATION FORMS

---

### ULTRATECH GROUP OF LABS

3000 Bristol Circle, Oakville, Ontario, Canada L6H 6G4

Tel. #: 905-829-1570, Fax. #: 905-829-8050, Email: [vhk.ultratech@sympatico.ca](mailto:vhk.ultratech@sympatico.ca), Website: <http://www.ultratech-labs.com>

File #: IVI73-FTX

June 20, 2000

- Assessed by ITI (UK) Competent Body, NVLAP (USA) Accreditation Body & ACA/AUSTEL (Australia)
- Accredited by Industry Canada (Canada) under ACC-LAB (Europe/Canada MRA)
- Recognized/Listed by FCC (USA )
- *All test results contained in this engineering test report are traceable to National Institute of Standards and Technology (NIST)*

## EXHIBIT 16. FCC LABEL/LOCATION INFORMATION

---

### ULTRATECH GROUP OF LABS

3000 Bristol Circle, Oakville, Ontario, Canada L6H 6G4

Tel. #: 905-829-1570, Fax. #: 905-829-8050, Email: [vhk.ultratech@sympatico.ca](mailto:vhk.ultratech@sympatico.ca), Website: <http://www.ultratech-labs.com>

File #: IVI73-FTX

June 20, 2000

- Assessed by ITI (UK) Competent Body, NVLAP (USA) Accreditation Body & ACA/AUSTEL (Australia)
- Accredited by Industry Canada (Canada) under ACC-LAB (Europe/Canada MRA)
- Recognized/Listed by FCC (USA )
- *All test results contained in this engineering test report are traceable to National Institute of Standards and Technology (NIST)*

## EXHIBIT 17. BLOCK DIAGRAMS

---

### ULTRATECH GROUP OF LABS

3000 Bristol Circle, Oakville, Ontario, Canada L6H 6G4

Tel. #: 905-829-1570, Fax. #: 905-829-8050, Email: [vhk.ultratech@sympatico.ca](mailto:vhk.ultratech@sympatico.ca), Website: <http://www.ultratech-labs.com>

File #: IVI73-FTX

June 20, 2000

- Assessed by ITI (UK) Competent Body, NVLAP (USA) Accreditation Body & ACA/AUSTEL (Australia)
- Accredited by Industry Canada (Canada) under ACC-LAB (Europe/Canada MRA)
- Recognized/Listed by FCC (USA)
- *All test results contained in this engineering test report are traceable to National Institute of Standards and Technology (NIST)*



## EXHIBIT 18. SCHEMATIC DIAGRAMS

---

### ULTRATECH GROUP OF LABS

3000 Bristol Circle, Oakville, Ontario, Canada L6H 6G4

Tel. #: 905-829-1570, Fax. #: 905-829-8050, Email: [vhk.ultratech@sympatico.ca](mailto:vhk.ultratech@sympatico.ca), Website: <http://www.ultratech-labs.com>

File #: IVI73-FTX

June 20, 2000

- Assessed by ITI (UK) Competent Body, NVLAP (USA) Accreditation Body & ACA/AUSTEL (Australia)
- Accredited by Industry Canada (Canada) under ACC-LAB (Europe/Canada MRA)
- Recognized/Listed by FCC (USA)
- *All test results contained in this engineering test report are traceable to National Institute of Standards and Technology (NIST)*

## EXHIBIT 19. PARTS LIST / TUNE UP INFORMATION

---

### ULTRATECH GROUP OF LABS

3000 Bristol Circle, Oakville, Ontario, Canada L6H 6G4

Tel. #: 905-829-1570, Fax. #: 905-829-8050, Email: [vhk.ultratech@sympatico.ca](mailto:vhk.ultratech@sympatico.ca), Website: <http://www.ultratech-labs.com>

File #: IVI73-FTX

June 20, 2000

- Assessed by ITI (UK) Competent Body, NVLAP (USA) Accreditation Body & ACA/AUSTEL (Australia)
- Accredited by Industry Canada (Canada) under ACC-LAB (Europe/Canada MRA)
- Recognized/Listed by FCC (USA)
- *All test results contained in this engineering test report are traceable to National Institute of Standards and Technology (NIST)*

## EXHIBIT 20. OPERATIONAL DESCRIPTION

---

### ULTRATECH GROUP OF LABS

3000 Bristol Circle, Oakville, Ontario, Canada L6H 6G4

Tel. #: 905-829-1570, Fax. #: 905-829-8050, Email: [vhk.ultratech@sympatico.ca](mailto:vhk.ultratech@sympatico.ca), Website: <http://www.ultratech-labs.com>

File #: IVI73-FTX

June 20, 2000

- Assessed by ITI (UK) Competent Body, NVLAP (USA) Accreditation Body & ACA/AUSTEL (Australia)
- Accredited by Industry Canada (Canada) under ACC-LAB (Europe/Canada MRA)
- Recognized/Listed by FCC (USA )
- *All test results contained in this engineering test report are traceable to National Institute of Standards and Technology (NIST)*

## EXHIBIT 21. RF EXPOSURE INFORMATION

None.

---

### ULTRATECH GROUP OF LABS

3000 Bristol Circle, Oakville, Ontario, Canada L6H 6G4

Tel. #: 905-829-1570, Fax. #: 905-829-8050, Email: [vhk.ultratech@sympatico.ca](mailto:vhk.ultratech@sympatico.ca), Website: <http://www.ultratech-labs.com>

File #: IVI73-FTX

June 20, 2000

- Assessed by ITI (UK) Competent Body, NVLAP (USA) Accreditation Body & ACA/AUSTEL (Australia)
- Accredited by Industry Canada (Canada) under ACC-LAB (Europe/Canada MRA)
- Recognized/Listed by FCC (USA)
- *All test results contained in this engineering test report are traceable to National Institute of Standards and Technology (NIST)*

## EXHIBIT 22. USER'S MANUAL

---

### ULTRATECH GROUP OF LABS

3000 Bristol Circle, Oakville, Ontario, Canada L6H 6G4

Tel. #: 905-829-1570, Fax. #: 905-829-8050, Email: [vhk.ultratech@sympatico.ca](mailto:vhk.ultratech@sympatico.ca), Website: <http://www.ultratech-labs.com>

File #: IVI73-FTX

June 20, 2000

- Assessed by ITI (UK) Competent Body, NVLAP (USA) Accreditation Body & ACA/AUSTEL (Australia)
- Accredited by Industry Canada (Canada) under ACC-LAB (Europe/Canada MRA)
- Recognized/Listed by FCC (USA)
- *All test results contained in this engineering test report are traceable to National Institute of Standards and Technology (NIST)*