



SPORTON International Inc.

No. 52, Hwa Ya 1st Rd., Hwa Ya Technology Park, Kwei-Shan Hsiang, Tao Yuan Hsien, Taiwan, R.O.C.
Ph: 886-3-327-3456 / FAX: 886-3-327-0973 / www.sporton.com.tw

FCC RADIO TEST REPORT

Applicant's company	COMPAL BROADBAND NETWORKS, INC.
Applicant Address	13F-1, No.1, Taiyuan 1st St., Zhubei City, Hsinchu County 30288, Taiwan, R.O.C.
FCC ID	O2U-CH6643
Manufacturer's company	COMPAL BROADBAND NETWORKS, INC.
Manufacturer Address	13F-1, No.1, Taiyuan 1st St., Zhubei City, Hsinchu County 30288, Taiwan, R.O.C.

Product Name	Cable modem
Brand Name	cbn
Model No.	CH6643E
Test Rule	47 CFR FCC Part 15 Subpart C § 15.247
Test Freq. Range	2400 ~ 2483.5MHz
Received Date	Sep. 18, 2014
Final Test Date	Dec. 30, 2014
Submission Type	Original Equipment

Statement

Test result included in this report is for the IEEE 802.11n and IEEE 802.11b/g of the product.

The test result in this report refers exclusively to the presented test model / sample.

Without written approval of SPORTON International Inc., the test report shall not be reproduced except in full.

The measurements and test results shown in this test report were made in accordance with the procedures and found in compliance with the limit given in ANSI C63.10-2013, 47 CFR FCC Part 15 Subpart C, KDB 558074 D01 v03r02 and KDB 662911 D01 v02r01.

The test equipment used to perform the test is calibrated and traceable to NML/ROC.



Table of Contents

1. CERTIFICATE OF COMPLIANCE	1
2. SUMMARY OF THE TEST RESULT	2
3. GENERAL INFORMATION	3
3.1. Product Details.....	3
3.2. Accessories.....	4
3.3. Table for Filed Antenna.....	5
3.4. Table for Carrier Frequencies	6
3.5. Table for Test Modes.....	7
3.6. Table for Testing Locations.....	8
3.7. Table for Supporting Units	9
3.8. Table for Parameters of Test Software Setting	11
3.9. EUT Operation during Test	11
3.10. Duty Cycle.....	11
3.11. Test Configurations	12
4. TEST RESULT	14
4.1. AC Power Line Conducted Emissions Measurement.....	14
4.2. Maximum Conducted Output Power Measurement.....	18
4.3. Power Spectral Density Measurement	21
4.4. 6dB Spectrum Bandwidth Measurement	28
4.5. Radiated Emissions Measurement	36
4.6. Emissions Measurement	55
4.7. Antenna Requirements	73
5. LIST OF MEASURING EQUIPMENTS	74
6. MEASUREMENT UNCERTAINTY.....	76
APPENDIX A. TEST PHOTOS	A1 ~ A5
APPENDIX B. RADIATED EMISSION CO-LOCATION REPORT.....	B1 ~ B3



History of This Test Report

REPORT NO.	VERSION	DESCRIPTION	ISSUED DATE
FR491841AA	Rev. 01	Initial issue of report	Jan. 16, 2015



1. CERTIFICATE OF COMPLIANCE

Product Name : Cable modem
Brand Name : 
Model No. : CH6643E
Applicant : COMPAL BROADBAND NETWORKS, INC.
Test Rule Part(s) : 47 CFR FCC Part 15 Subpart C § 15.247

Sporton International as requested by the applicant to evaluate the EMC performance of the product sample received on Sep. 18, 2014 would like to declare that the tested sample has been evaluated and found to be in compliance with the tested rule parts. The data recorded as well as the test configuration specified is true and accurate for showing the sample's EMC nature.



Sam Chen

SPORTON INTERNATIONAL INC.

2. SUMMARY OF THE TEST RESULT

Applied Standard: 47 CFR FCC Part 15 Subpart C				
Part	Rule Section	Description of Test	Result	Under Limit
4.1	15.207	AC Power Line Conducted Emissions	Complies	12.40 dB
4.2	15.247(b)(3)	Maximum Conducted Output Power	Complies	9.53 dB
4.3	15.247(e)	Power Spectral Density	Complies	15.94 dB
4.4	15.247(a)(2)	6dB Spectrum Bandwidth	Complies	-
4.5	15.247(d)	Radiated Emissions	Complies	0.07 dB
4.6	15.247(d)	Band Edge Emissions	Complies	0.15 dB
4.7	15.203	Antenna Requirements	Complies	-

3. GENERAL INFORMATION

3.1. Product Details

IEEE 802.11n

Items	Description
Product Type	WLAN (2TX, 2RX)
Radio Type	Intentional Transceiver
Power Type	From power adapter
Modulation	see the below table for IEEE 802.11n
Data Modulation	OFDM (BPSK / QPSK / 16QAM / 64QAM)
Data Rate (Mbps)	see the below table for IEEE 802.11n
Frequency Range	2400 ~ 2483.5MHz
Channel Number	11 for 20MHz bandwidth ; 7 for 40MHz bandwidth
Channel Band Width (99%)	MCS8 (HT20): 17.97 MHz ; MCS8 (HT40): 36.61 MHz
Maximum Conducted Output Power	MCS8 (HT20): 20.43 dBm ; MCS8 (HT40): 20.47 dBm
Carrier Frequencies	Please refer to section 3.4
Antenna	Please refer to section 3.3

IEEE 802.11b/g

Items	Description
Product Type	WLAN (1TX, 1RX)
Radio Type	Intentional Transceiver
Power Type	From power adapter
Modulation	DSSS for IEEE 802.11b ; OFDM for IEEE 802.11g
Data Modulation	DSSS (BPSK / QPSK / CCK) ; OFDM (BPSK / QPSK / 16QAM / 64QAM)
Data Rate (Mbps)	DSSS (1/ 2/ 5.5/11) ; OFDM (6/9/12/18/24/36/48/54)
Frequency Range	2400 ~ 2483.5MHz
Channel Number	11
Channel Band Width (99%)	11b: 15.19 MHz ; 11g: 17.01 MHz
Maximum Conducted Output Power	11b: 19.06 dBm ; 11g: 18.85 dBm
Carrier Frequencies	Please refer to section 3.4
Antenna	Please refer to section 3.3

Items	Description	
Beamforming Function	<input type="checkbox"/> With beamforming	<input checked="" type="checkbox"/> Without beamforming

Antenna and Band width

Antenna	Single (TX)		Two (TX)	
	20 MHz	40 MHz	20 MHz	40 MHz
IEEE 802.11b	V	X	X	X
IEEE 802.11g	V	X	X	X
IEEE 802.11n	X	X	V	V

IEEE 11n Spec.

Protocol	Number of Transmit Chains (NTX)	Data Rate / MCS
802.11n (HT20)	2	MCS 8-15
802.11n (HT40)	2	MCS 8-15

Note 1: IEEE Std. 802.11n modulation consists of HT20 and HT40 (HT: High Throughput).
Then EUT support HT20 and HT40.

Note 2: Modulation modes consist of below configuration: HT20/HT40: IEEE 802.11n

3.2. Accessories

Power	Brand	Model No.	Rating
Adapter	APD	WA-24Q12FU	Input: 100-240Vac, 50-60Hz, 0.6A Max. Output: 12Vdc, 2A

3.3. Table for Filed Antenna

Ant.	Brand	Model No.	Antenna Type	Connector	Gain (dBi)	
					2.4GHz	5GHz
0	CBG	141664320004C	PCB Antenna	N/A	2.68	6.30
1	CBG	141664320004C	PCB Antenna	N/A	2.68	6.30

Note: The EUT has two antennas.

For 2.4GHz WLAN function:

For IEEE 802.11b/g mode (1TX/1RX):

Only Ant. 0 could transmit/receive simultaneously.

For IEEE 802.11n mode (2TX/2RX):

Ant. 0 and Ant. 1 could transmit/receive simultaneously.

For 5GHz WLAN function:

For IEEE 802.11a mode (1TX/1RX):

Only Ant. 0 could transmit/receive simultaneously.

For IEEE 802.11n mode (2TX/2RX):

Ant. 0 and Ant. 1 could transmit/receive simultaneously.

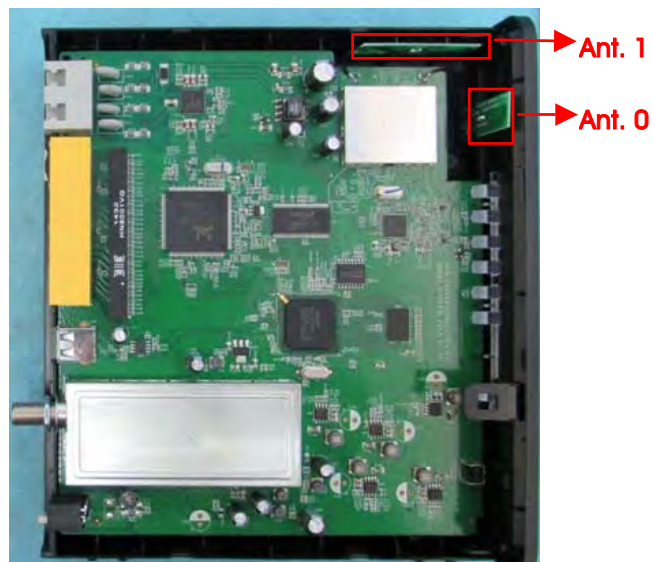

3.4. Table for Carrier Frequencies

There are two bandwidth systems.

For 20MHz bandwidth systems, use Channel 1~Channel 11.

For 40MHz bandwidth systems, use Channel 3~Channel 9.

Frequency Band	Channel No.	Frequency	Channel No.	Frequency
2400~2483.5MHz	1	2412 MHz	7	2442 MHz
	2	2417 MHz	8	2447 MHz
	3	2422 MHz	9	2452 MHz
	4	2427 MHz	10	2457 MHz
	5	2432 MHz	11	2462 MHz
	6	2437 MHz	-	-

3.5. Table for Test Modes

Preliminary tests were performed in different data rate to find the worst radiated emission. The data rate shown in the table below is the worst-case rate with respect to the specific test item. Investigation has been done on all the possible configurations for searching the worst cases. The following table is a list of the test modes shown in this test report.

Test Items	Mode	Data Rate	Channel	Ant.
AC Power Line Conducted Emissions	Normal Link	-	-	-
Maximum Conducted Output Power	802.11n HT20	MCS8	1/6/11	0+1
	802.11n HT40	MCS8	3/6/9	0+1
	11b/BPSK	1 Mbps	1/6/11	0
	11g/BPSK	6 Mbps	1/6/11	0
Power Spectral Density	802.11n HT20	MCS8	1/6/11	0+1
	802.11n HT40	MCS8	3/6/9	0+1
	11b/BPSK	1 Mbps	1/6/11	0
	11g/BPSK	6 Mbps	1/6/11	0
6dB Spectrum Bandwidth	802.11n HT20	MCS8	1/6/11	0+1
	802.11n HT40	MCS8	3/6/9	0+1
	11b/BPSK	1 Mbps	1/6/11	0
	11g/BPSK	6 Mbps	1/6/11	0
Radiated Emissions 9kHz~1GHz	Normal Link	-	-	-
Radiated Emissions 1GHz~10 th Harmonic	802.11n HT20	MCS8	1/6/11	0+1
	802.11n HT40	MCS8	3/6/9	0+1
	11b/BPSK	1 Mbps	1/6/11	0
	11g/BPSK	6 Mbps	1/6/11	0
Band Edge Emissions	802.11n HT20	MCS8	1/6/11	0+1
	802.11n HT40	MCS8	3/6/9	0+1
	11b/BPSK	1 Mbps	1/6/11	0
	11g/BPSK	6 Mbps	1/6/11	0

For Co-location MPE and Radiated Emission Co-location test:

The EUT could be applied with 2.4GHz WLAN function and 5GHz WLAN function; therefore Co-location Maximum Permissible Exposure (Please refer to Report No.: FA491841) and Radiated Emission Co-location (please refer to Appendix B) tests are added for simultaneously transmit between 2.4GHz WLAN function and 5GHz WLAN function.

3.6. Table for Testing Locations

Test Site Location				
Address:	No.8, Lane 724, Bo-ai St., Jhubei City, Hsinchu County 302, Taiwan, R.O.C.			
TEL:	886-3-656-9065			
FAX:	886-3-656-9085			
Test Site No.	Site Category	Location	FCC Reg. No.	IC File No.
03CH01-CB	SAC	Hsin Chu	262045	IC 4086D
CO01-CB	Conduction	Hsin Chu	262045	IC 4086D
TH01-CB	OVEN Room	Hsin Chu	-	-

Open Area Test Site (OATS); Semi Anechoic Chamber (SAC).

3.7. Table for Supporting Units

For Test Site No: 03CH01-CB (Below 1GHz)

Support Unit	Brand	Model	FCC ID
NB	DELL	M1330	DoC
NB	DELL	M1340	DoC
NB	DELL	E6430	DoC
Cable Modem (Terminal System)	MOTOROLA	BSR 2000	DoC
PC (Control System)	acer	CD6141E	DoC
Keyboard (Control System)	iCooky	SK068	DoC
Mouse (Control System)	Logitech	M-U0026	DoC
LCD Monitor (Control System)	DELL	1704FPT†	DoC
Flash Disk	Transcend	JetFlash-700	DoC
Phone	HTT	F-689	N/A
Phone	HTT	F-689	N/A

For Test Site No: 03CH01-CB (Above 1GHz)

Support Unit	Brand	Model	FCC ID
NB	DELL	M1330	DoC

For Test Site No: CO01-CB

Support Unit	Brand	Model	FCC ID
NB	DELL	E6430	DoC
NB	DELL	E6430	DoC
NB	DELL	E6430	DoC
Cable Modem (Terminal System)	MOTOROLA	BSR 2000	DoC
PC (Control System)	acer	CD6141E	DoC
Keyboard (Control System)	iCooky	SK068	DoC
Mouse (Control System)	Logitech	M-U0026	DoC
LCD Monitor (Control System)	DELL	1704FPT†	DoC
Flash Disk	Transcend	JetFlash-700	DoC
Phone	PHILIPS	M20	N/A
Phone	PHILIPS	M20	N/A

For Test Site No: TH01-CB

Support Unit	Brand	Model	FCC ID
NB	DELL	M1340	DoC

3.8. Table for Parameters of Test Software Setting

During testing, Channel and Power Controlling Software provided by the customer was used to control the operating channel as well as the output power level. The RF output power selection is for the setting of RF output power expected by the customer and is going to be fixed on the firmware of the final end product.

Power Parameters of IEEE 802.11n

Test Software Version	RTL819x 2.2.3		
Frequency	2412 MHz	2437 MHz	2462 MHz
MCS8 HT20	60/61	63/61	57/57
Frequency	2422 MHz	2437 MHz	2452 MHz
MCS8 HT40	56/57	62/63	61/61

Power Parameters of IEEE 802.11b/g

Test Software Version	RTL819x 2.2.3		
Frequency	2412 MHz	2437 MHz	2462 MHz
IEEE 802.11b	50	50	52
IEEE 802.11g	63	63	62

3.9. EUT Operation during Test

The EUT was programmed to be in continuously transmitting mode.

3.10. Duty Cycle

Mode	On Time (ms)	On+Off Time (ms)	Duty Cycle (%)	Duty Factor (dB)	1/T Minimum VBW (kHz)
802.11n MCS8 HT20	1.000	1.000	100.00	0.00	0.01
802.11n MCS8 HT40	1.000	1.000	100.00	0.00	0.01
802.11b	1.000	1.000	100.00	0.00	0.01
802.11g	1.000	1.000	100.00	0.00	0.01

3.11. Test Configurations

3.11.1. AC Power Line Conduction Emissions and Radiation Emissions Below 1GHz Test Configuration

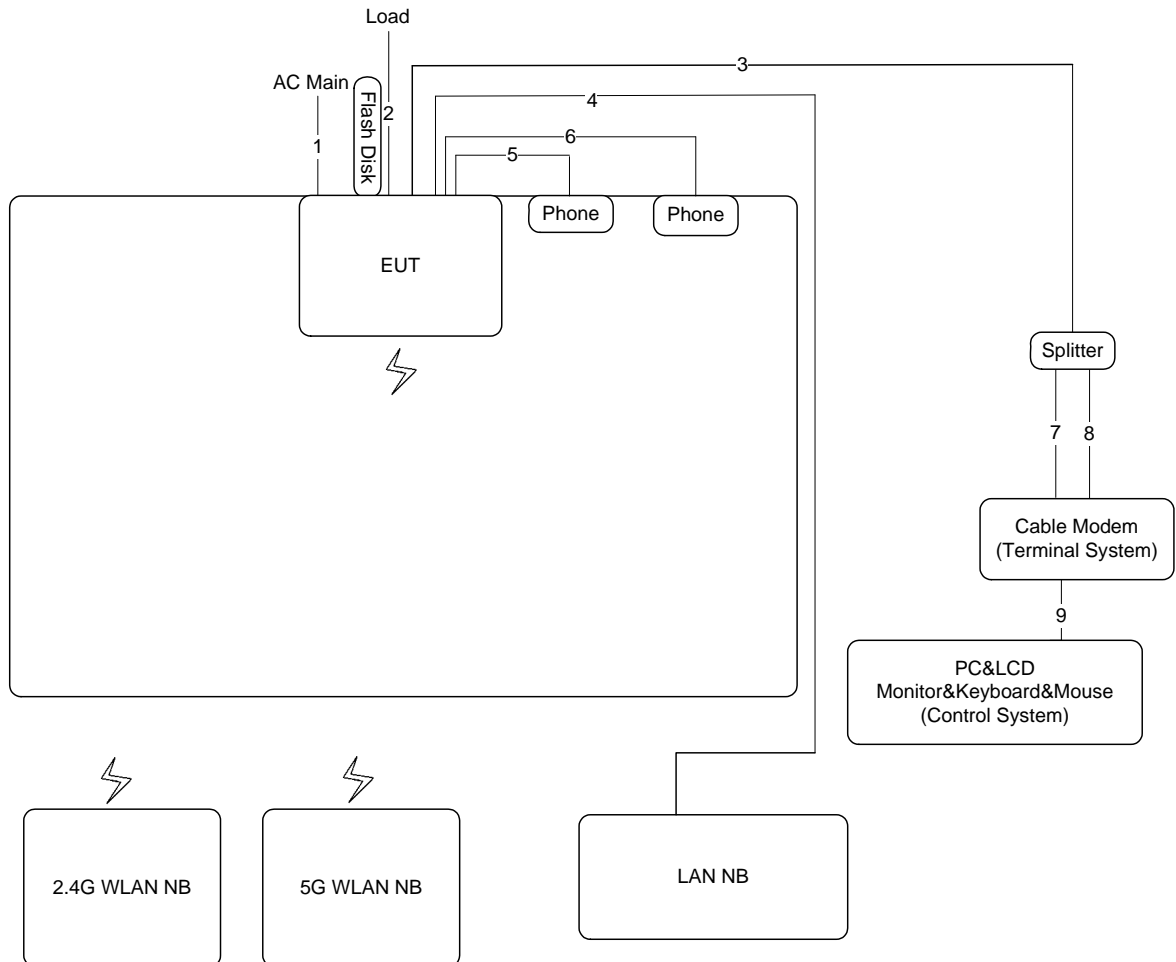

Item	Connection	Shielded	Length	Remark
1	Power cable	No	1.5m	-
2	RJ-45 cable*3	No	1.5m	Load
3	Coaxial cable	Yes	10m	-
4	RJ-45 cable	No	10m	-
5	RJ-11 cable	No	1.5m	-
6	RJ-11 cable	No	1.5m	-
7	Coaxial cable	Yes	1m	-
8	Coaxial cable	Yes	1m	-
9	RJ-45 cable	No	10m	-

3.11.2. Radiation Emissions Above 1GHz Test Configuration

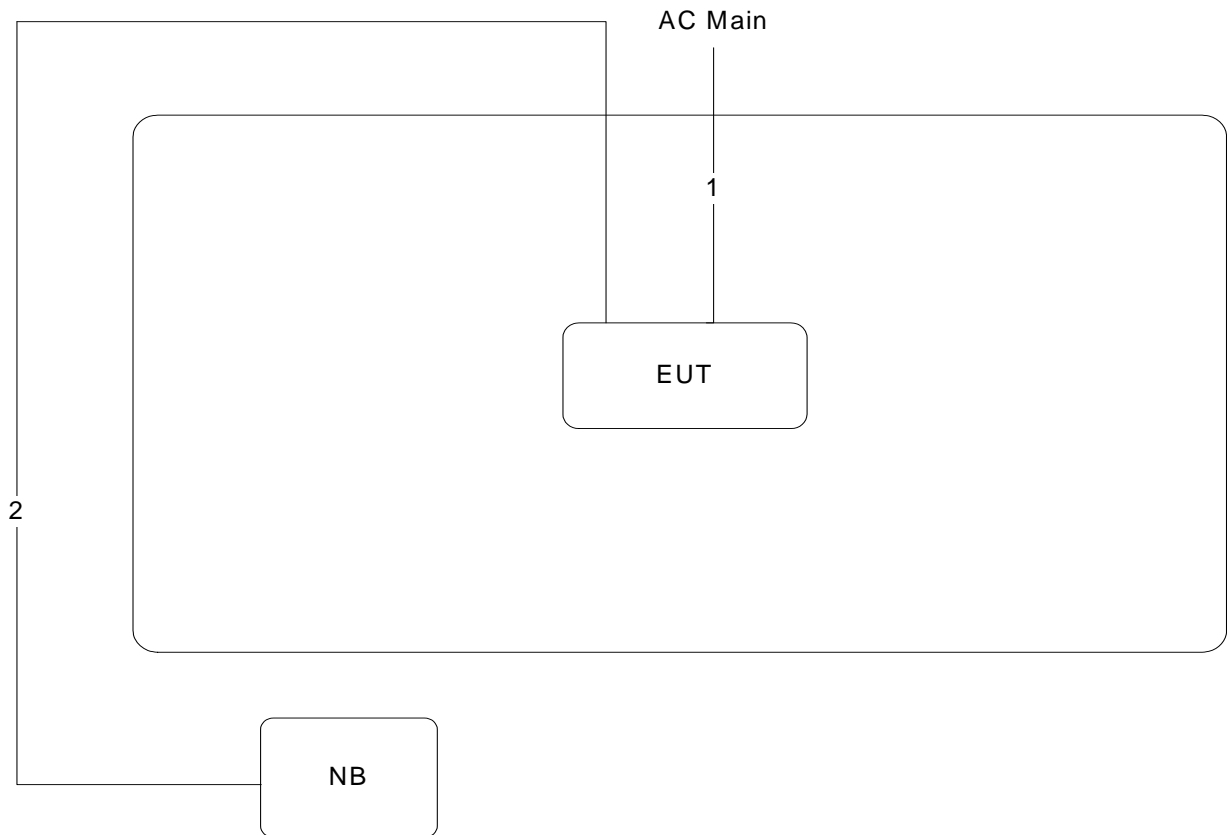

Item	Connection	Shielded	Length
1	Power cable	No	1.5m
2	RJ-45 cable	No	10m

4. TEST RESULT

4.1. AC Power Line Conducted Emissions Measurement

4.1.1. Limit

For this product which is designed to be connected to the AC power line, the radio frequency voltage that is conducted back onto the AC power line on any frequency or frequencies within the band 150 kHz to 30 MHz shall not exceed below limits table.

Frequency (MHz)	QP Limit (dBuV)	AV Limit (dBuV)
0.15~0.5	66~56	56~46
0.5~5	56	46
5~30	60	50

4.1.2. Measuring Instruments and Setting

Please refer to section 5 of equipments list in this report. The following table is the setting of the receiver.

Receiver Parameters	Setting
Attenuation	10 dB
Start Frequency	0.15 MHz
Stop Frequency	30 MHz
IF Bandwidth	9 kHz

4.1.3. Test Procedures

1. Configure the EUT according to ANSI C63.10. The EUT or host of EUT has to be placed 0.4 meter far from the conducting wall of the shielding room and at least 80 centimeters from any other grounded conducting surface.
2. Connect EUT or host of EUT to the power mains through a line impedance stabilization network (LISN).
3. All the support units are connected to the other LISNs. The LISN should provide 50uH/50ohms coupling impedance.
4. The frequency range from 150 kHz to 30 MHz was searched.
5. Set the test-receiver system to Peak Detect Function and Specified Bandwidth with Maximum Hold Mode.
6. The measurement has to be done between each power line and ground at the power terminal.

4.1.4. Test Setup Layout

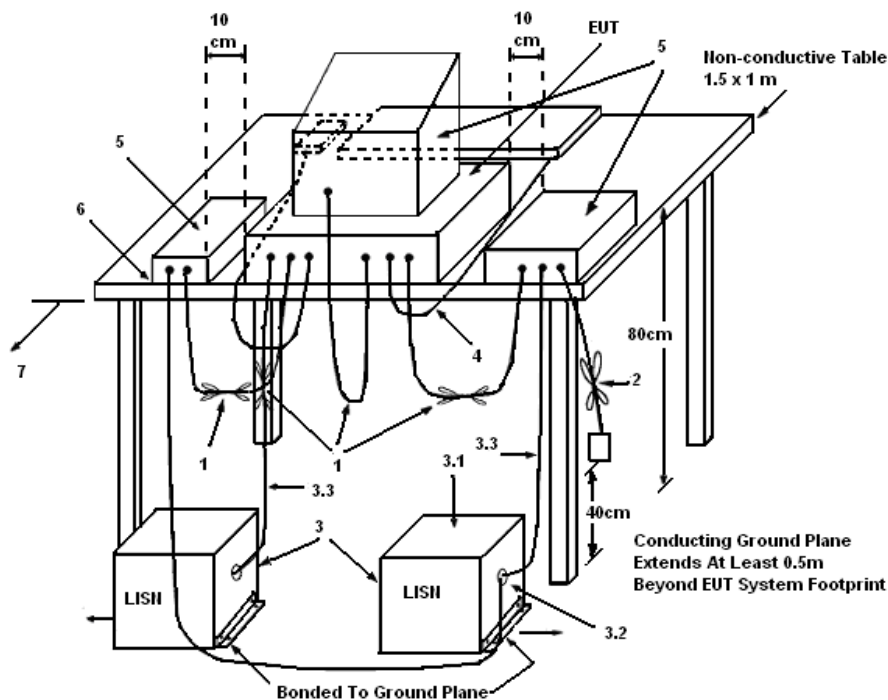

LEGEND:

- (1) Interconnecting cables that hang closer than 40 cm to the ground plane shall be folded back and forth in the center forming a bundle 30 to 40 cm long.
- (2) I/O cables that are not connected to a peripheral shall be bundled in the center. The end of the cable may be terminated, if required, using the correct terminating impedance. The overall length shall not exceed 1 m.
- (3) EUT connected to one LISN. Unused LISN measuring port connectors shall be terminated in 50 Ω . LISN can be placed on top of, or immediately beneath, reference ground plane.
 - (3.1) All other equipment powered from additional LISN(s).
 - (3.2) Multiple outlet strip can be used for multiple power cords of non-EUT equipment.
 - (3.3) LISN at least 80 cm from nearest part of EUT chassis.
- (4) Cables of hand-operated devices, such as keyboards, mice, etc., shall be placed as for normal use.
- (5) Non-EUT components of EUT system being tested.
- (6) Rear of EUT, including peripherals, shall all be aligned and flush with rear of tabletop.
- (7) Rear of tabletop shall be 40 cm removed from a vertical conducting plane that is bonded to the ground plane.

4.1.5. Test Deviation

There is no deviation with the original standard.

4.1.6. EUT Operation during Test

The EUT was placed on the test table and programmed in normal function.

4.1.7. Results of AC Power Line Conducted Emissions Measurement

Temperature	25°C	Humidity	60%
Test Engineer	Parody Lin	Phase	Line
Configuration	Normal Link		

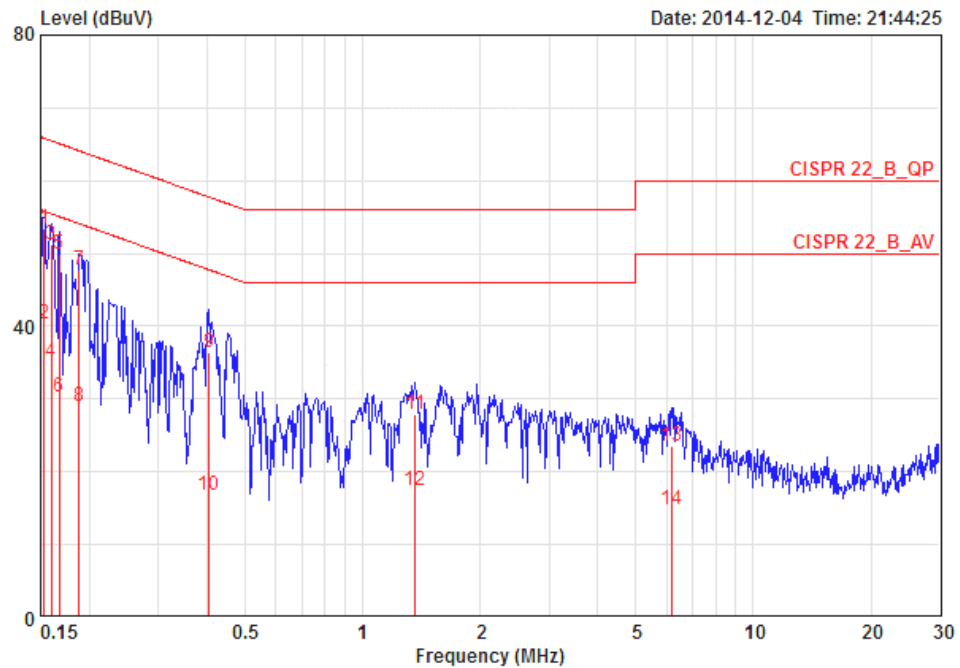

	Freq	Level	Over	Limit	Read	LISN	Cable	Remark	Pol/Phase
	MHz	dBuV	Limit	Line	Level	Factor	Loss		
			dB	dBuV	dBuV	dB	dB		
1	0.15321	53.43	-12.40	65.82	43.30	9.97	0.16	QP	LINE
2	0.15321	40.33	-15.50	55.82	30.20	9.97	0.16	AVERAGE	LINE
3	0.15985	51.31	-14.17	65.47	41.18	9.97	0.16	QP	LINE
4	0.15985	35.20	-20.28	55.47	25.07	9.97	0.16	AVERAGE	LINE
5	0.16765	49.95	-15.13	65.08	39.82	9.97	0.16	QP	LINE
6	0.16765	30.41	-24.67	55.08	20.28	9.97	0.16	AVERAGE	LINE
7	0.18838	47.75	-16.36	64.11	37.62	9.96	0.16	QP	LINE
8	0.18838	28.96	-25.15	54.11	18.83	9.96	0.16	AVERAGE	LINE
9	0.40400	36.39	-21.38	57.77	26.24	9.97	0.18	QP	LINE
10	0.40400	16.87	-30.90	47.77	6.72	9.97	0.18	AVERAGE	LINE
11	1.367	27.86	-28.14	56.00	17.68	9.95	0.22	QP	LINE
12	1.367	17.34	-28.66	46.00	7.16	9.95	0.22	AVERAGE	LINE
13	6.186	23.56	-36.44	60.00	13.18	10.04	0.34	QP	LINE
14	6.186	14.82	-35.18	50.00	4.44	10.04	0.34	AVERAGE	LINE

Temperature	25°C	Humidity	60%
Test Engineer	Parody Lin	Phase	Neutral
Configuration	Normal Link		

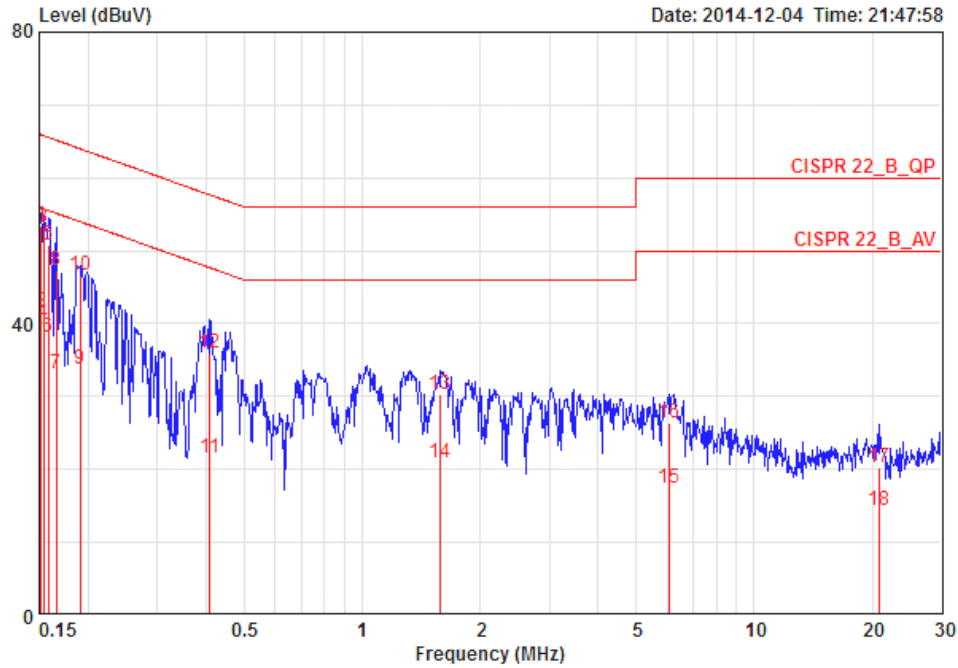

	Freq	Level	Over	Limit	Read	LISN	Cable	Remark	Pol/Phase
	MHz	dBuV	Limit	Line	Level	Factor	Loss		
			dB	dBuV	dBuV	dB	dB		
1	0.15160	53.37	-12.55	65.91	43.24	9.97	0.16	QP	NEUTRAL
2	0.15160	41.74	-14.18	55.91	31.61	9.97	0.16	AVERAGE	NEUTRAL
3	0.15403	53.13	-12.65	65.78	43.00	9.97	0.16	QP	NEUTRAL
4	0.15403	40.19	-15.59	55.78	30.06	9.97	0.16	AVERAGE	NEUTRAL
5	0.15816	50.87	-14.69	65.56	40.74	9.97	0.16	QP	NEUTRAL
6	0.15816	38.08	-17.48	55.56	27.95	9.97	0.16	AVERAGE	NEUTRAL
7	0.16589	33.18	-21.99	55.16	23.05	9.97	0.16	AVERAGE	NEUTRAL
8	0.16589	47.33	-17.84	65.16	37.20	9.97	0.16	QP	NEUTRAL
9	0.19039	33.81	-20.21	54.02	23.68	9.96	0.16	AVERAGE	NEUTRAL
10	0.19039	46.59	-17.43	64.02	36.46	9.96	0.16	QP	NEUTRAL
11	0.40831	21.49	-26.19	47.68	11.34	9.97	0.18	AVERAGE	NEUTRAL
12	0.40831	35.87	-21.81	57.68	25.72	9.97	0.18	QP	NEUTRAL
13	1.585	30.27	-25.73	56.00	20.08	9.96	0.23	QP	NEUTRAL
14	1.585	20.90	-25.10	46.00	10.71	9.96	0.23	AVERAGE	NEUTRAL
15	6.056	17.45	-32.55	50.00	7.12	9.99	0.34	AVERAGE	NEUTRAL
16	6.056	26.43	-33.57	60.00	16.10	9.99	0.34	QP	NEUTRAL
17	20.924	20.18	-39.82	60.00	9.36	10.30	0.53	QP	NEUTRAL
18	20.924	14.33	-35.67	50.00	3.51	10.30	0.53	AVERAGE	NEUTRAL

Note:

Level = Read Level + LISN Factor + Cable Loss.

4.2. Maximum Conducted Output Power Measurement

4.2.1. Limit

For systems using digital modulation in the 2400-2483.5MHz, the limit for output power is 30dBm. The limited has to be reduced by the amount in dB that the gain of the antenna exceed 6dBi. In case of point-to-point operation, the limit has to be reduced by 1dB for every 3dB that the directional gain of the antenna exceeds 6dBi.

4.2.2. Measuring Instruments and Setting

Please refer to section 5 of equipments list in this report. The following table is the setting of the power meter.

Power Meter Parameter	Setting
Bandwidth	50MHz bandwidth is greater than the EUT emission bandwidth
Detector	Average

4.2.3. Test Procedures

1. Test procedures refer KDB 558074 D01 v03r02 section 9.2.3.2 Measurement using a power meter (PM).
2. Multiple antenna systems was performed in accordance with KDB 662911 D01 v02r01 Emissions Testing of Transmitters with Multiple Outputs in the Same Band.
3. This procedure provides an alternative for determining the RMS output power using a broadband RF average power meter with a thermocouple detector.

4.2.4. Test Setup Layout

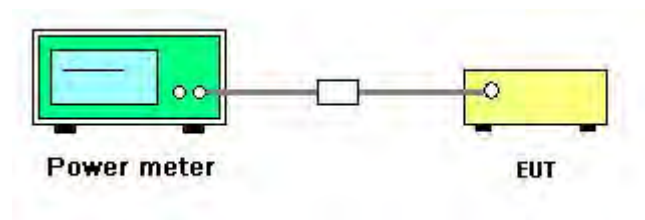

4.2.5. Test Deviation

There is no deviation with the original standard.

4.2.6. EUT Operation during Test

The EUT was programmed to be in continuously transmitting mode.

4.2.7. Test Result of Maximum Conducted Output Power

Temperature	24°C	Humidity	63%
Test Engineer	Magic Lai	Configurations	IEEE 802.11n
Test Date	Dec. 26, 2014		

Configuration IEEE 802.11n MCS8 HT20

Channel	Frequency	Conducted Power (dBm)			Max. Limit (dBm)	Result
		Ant. 0	Ant. 1	Total		
1	2412 MHz	16.32	16.55	19.45	30.00	Complies
6	2437 MHz	17.42	17.42	20.43	30.00	Complies
11	2462 MHz	16.11	15.89	19.01	30.00	Complies

Configuration IEEE 802.11n MCS8 HT40

Channel	Frequency	Conducted Power (dBm)			Max. Limit (dBm)	Result
		Ant. 0	Ant. 1	Total		
3	2422 MHz	15.42	15.21	18.33	30.00	Complies
6	2437 MHz	17.39	17.53	20.47	30.00	Complies
9	2452 MHz	16.68	17.09	19.90	30.00	Complies

Temperature	24°C	Humidity	63%
Test Engineer	Magic Lai	Configurations	IEEE 802.11b/g
Test Date	Dec. 26, 2014		

Configuration IEEE 802.11b / Ant. 0

Channel	Frequency	Conducted Power (dBm)	Max. Limit (dBm)	Result
1	2412 MHz	18.05	30.00	Complies
6	2437 MHz	18.12	30.00	Complies
11	2462 MHz	19.06	30.00	Complies

Configuration IEEE 802.11g / Ant. 0

Channel	Frequency	Conducted Power (dBm)	Max. Limit (dBm)	Result
1	2412 MHz	18.61	30.00	Complies
6	2437 MHz	18.85	30.00	Complies
11	2462 MHz	18.58	30.00	Complies

4.3. Power Spectral Density Measurement

4.3.1. Limit

For digitally modulated systems, the power spectral density conducted from the intentional radiator to the antenna shall not be greater than 8 dBm in any 3 kHz band during any time interval of continuous transmission.

4.3.2. Measuring Instruments and Setting

Please refer to section 5 of equipments list in this report. The following table is the setting of the spectrum analyzer.

Spectrum Parameter	Setting
Attenuation	Auto
Span Frequency	Set the span to 1.5 times the DTS channel bandwidth.
RBW	$3 \text{ kHz} \leq \text{RBW} \leq 100\text{kHz}$
VBW	$\geq 3 \times \text{RBW}$
Detector	Peak
Trace	Max Hold
Sweep Time	Auto couple

4.3.3. Test Procedures

1. Test was performed in accordance with KDB 558074 D01 v03r02 for Performing Compliance Measurements on Digital Transmission Systems (DTS) - section 10.2 Method PKPSD (peak PSD) and KDB 662911 D01 v02r01 section In-Band Power Spectral Density (PSD) Measurements option (b) Measure and sum spectral maximal across the outputs.
2. Use this procedure when the maximum conducted output power in the fundamental emission is used to demonstrate compliance. The EUT must be configured to transmit continuously at full power over the measurement duration.
3. Ensure that the number of measurement points in the sweep $\geq 2 \times \text{span}/\text{RBW}$ (use of a greater number of measurement points than this minimum requirement is recommended).
4. Use the peak marker function to determine the maximum level in any 3 kHz band segment within the fundamental EBW.
5. The resulting PSD level must be $\leq 8 \text{ dBm}$.

4.3.4. Test Setup Layout

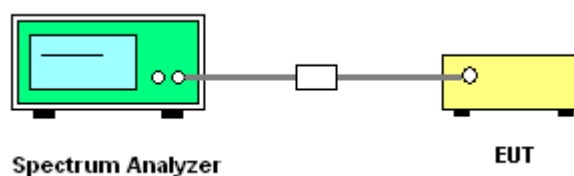

4.3.5. Test Deviation

There is no deviation with the original standard.

4.3.6. EUT Operation during Test

The EUT was programmed to be in continuously transmitting mode.

4.3.7. Test Result of Power Spectral Density

Temperature	24°C	Humidity	63%
Test Engineer	Magic Lai	Configurations	IEEE 802.11n

Configuration IEEE 802.11n MCS8 HT20

Channel	Frequency	Power Density (dBm/3kHz)			Power Density Limit (dBm/3kHz)	Result
		Ant. 0	Ant. 1	Total		
1	2412 MHz	-12.50	-11.65	-9.04	8.00	Complies
6	2437 MHz	-10.94	-10.96	-7.94	8.00	Complies
11	2462 MHz	-12.69	-13.09	-9.88	8.00	Complies

Note: Directional gain = $10 \cdot \log \left[\frac{\sum_{j=1}^{N_{ANT}} \left\{ \sum_{k=1}^{N_{ANT}} g_{j,k} \right\}^2}{N_{ANT}} \right] = 2.68\text{dBi} < 6\text{dBi}$, so the limit doesn't reduce.

Configuration IEEE 802.11n MCS8 HT40

Channel	Frequency	Power Density (dBm/3kHz)			Power Density Limit (dBm/3kHz)	Result
		Ant. 0	Ant. 1	Total		
3	2422 MHz	-16.74	-16.76	-13.74	8.00	Complies
6	2437 MHz	-14.00	-13.92	-10.95	8.00	Complies
9	2452 MHz	-14.19	-14.57	-11.37	8.00	Complies

Note: Directional gain = $10 \cdot \log \left[\frac{\sum_{j=1}^{N_{ANT}} \left\{ \sum_{k=1}^{N_{ANT}} g_{j,k} \right\}^2}{N_{ANT}} \right] = 2.68\text{dBi} < 6\text{dBi}$, so the limit doesn't reduce.

Temperature	24°C	Humidity	63%
Test Engineer	Magic Lai	Configurations	IEEE 802.11b/g

Configuration IEEE 802.11b / Ant. 0

Channel	Frequency	Power Density (dBm/3kHz)	Power Density Limit (dBm/3kHz)	Result
1	2412 MHz	-13.59	8.00	Complies
6	2437 MHz	-12.97	8.00	Complies
11	2462 MHz	-11.95	8.00	Complies

Configuration IEEE 802.11g / Ant. 0

Channel	Frequency	Power Density (dBm/3kHz)	Power Density Limit (dBm/3kHz)	Result
1	2412 MHz	-10.86	8.00	Complies
6	2437 MHz	-10.59	8.00	Complies
11	2462 MHz	-10.76	8.00	Complies

Note: All the test values were listed in the report.

For plots, only the channel with worse result was shown.

Power Density Plot on Configuration IEEE 802.11n MCS8 HT20 / 2437 MHz / Ant. 0

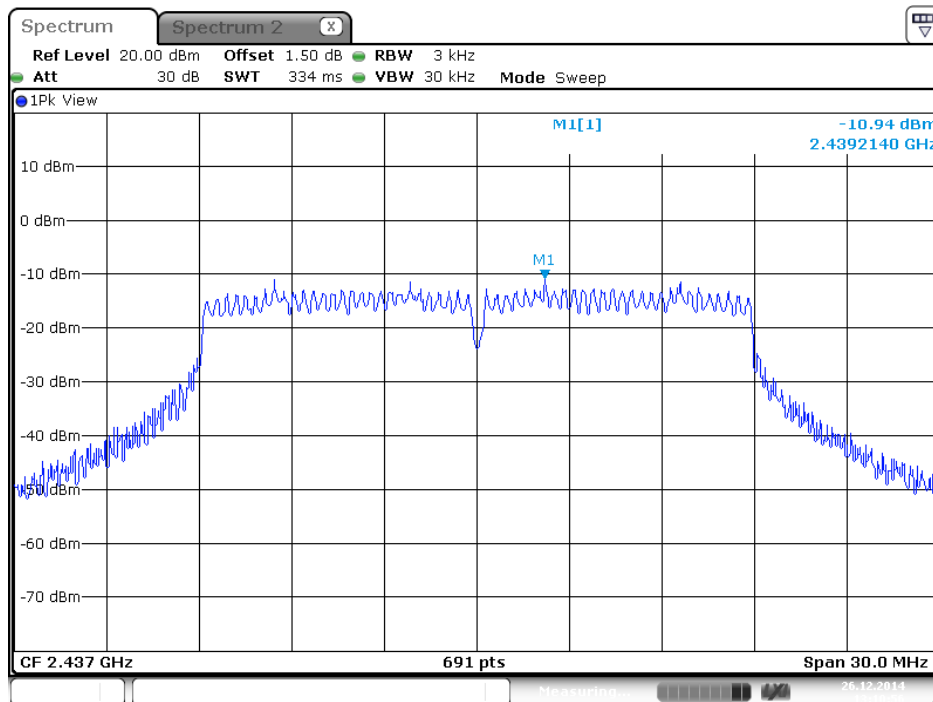

Power Density Plot on Configuration IEEE 802.11n MCS8 HT20 / 2437 MHz / Ant. 1

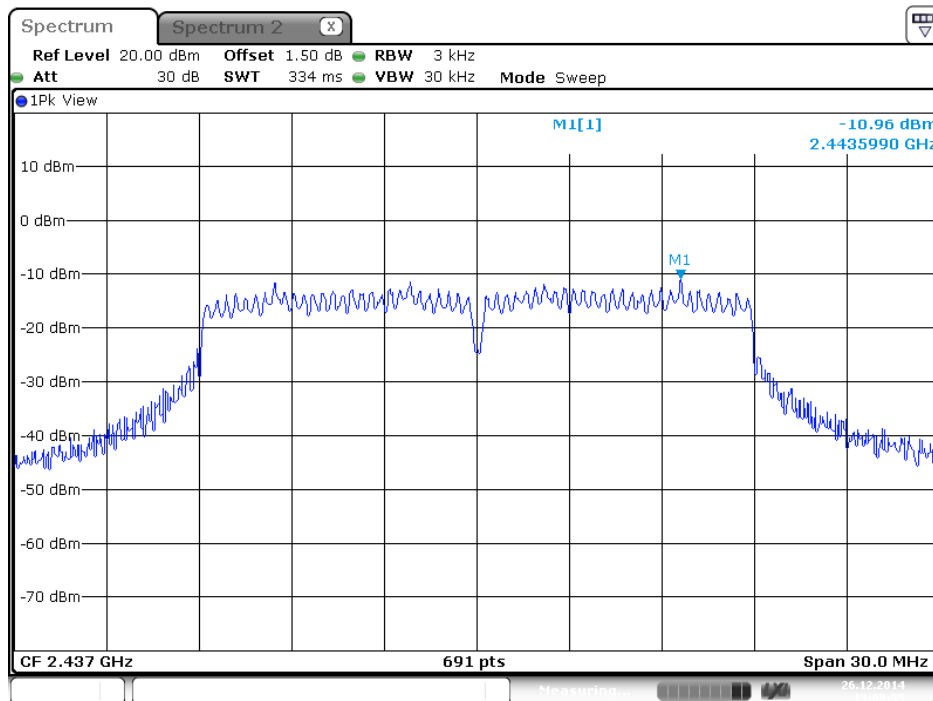

Power Density Plot on Configuration IEEE 802.11n MCS8 HT40 / 2437 MHz / Ant. 0

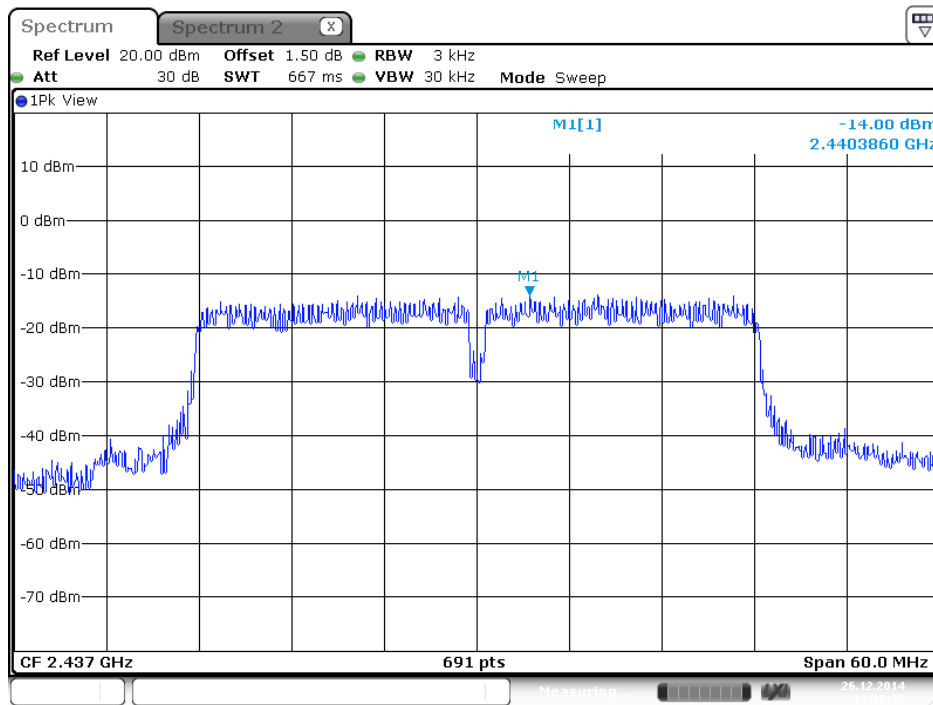

Power Density Plot on Configuration IEEE 802.11n MCS8 HT40 / 2437 MHz / Ant. 1

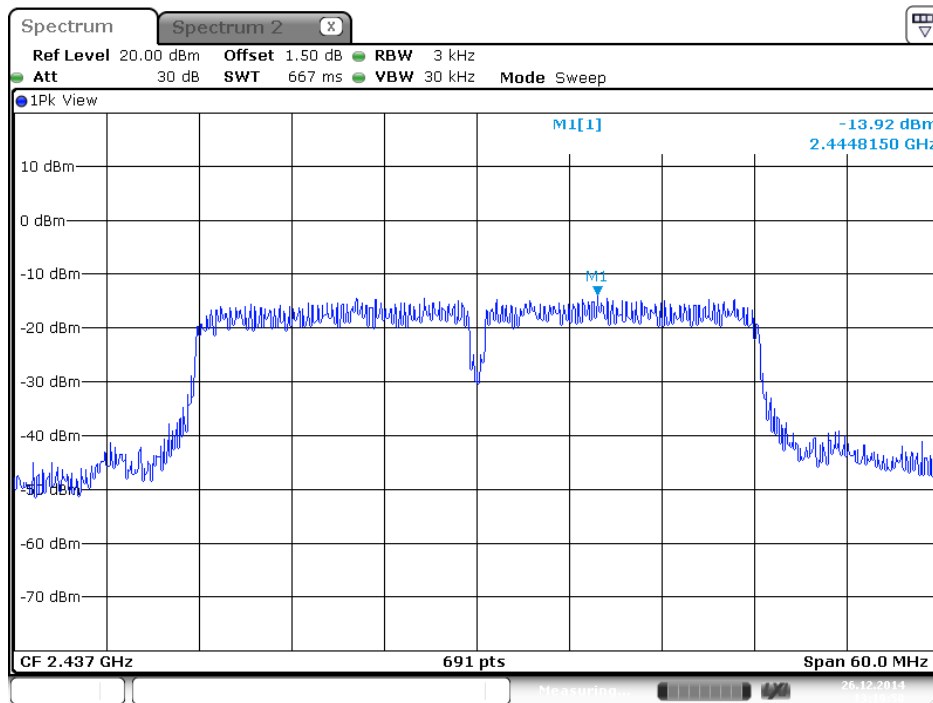

Power Density Plot on Configuration IEEE 802.11b / 2462 MHz / Ant. 0

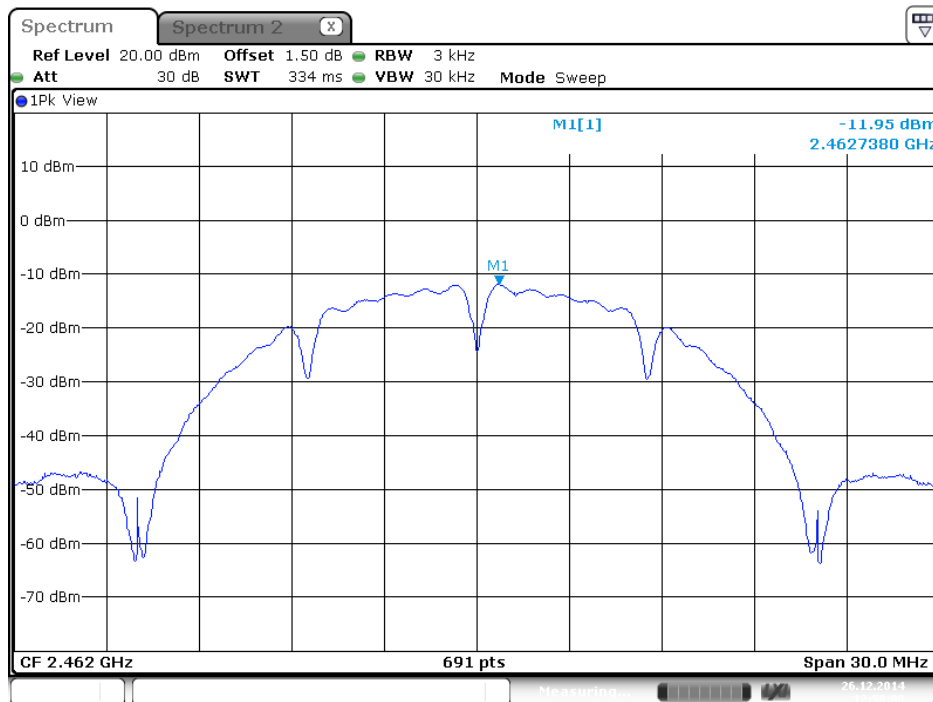

Power Density Plot on Configuration IEEE 802.11g / 2437 MHz / Ant. 0

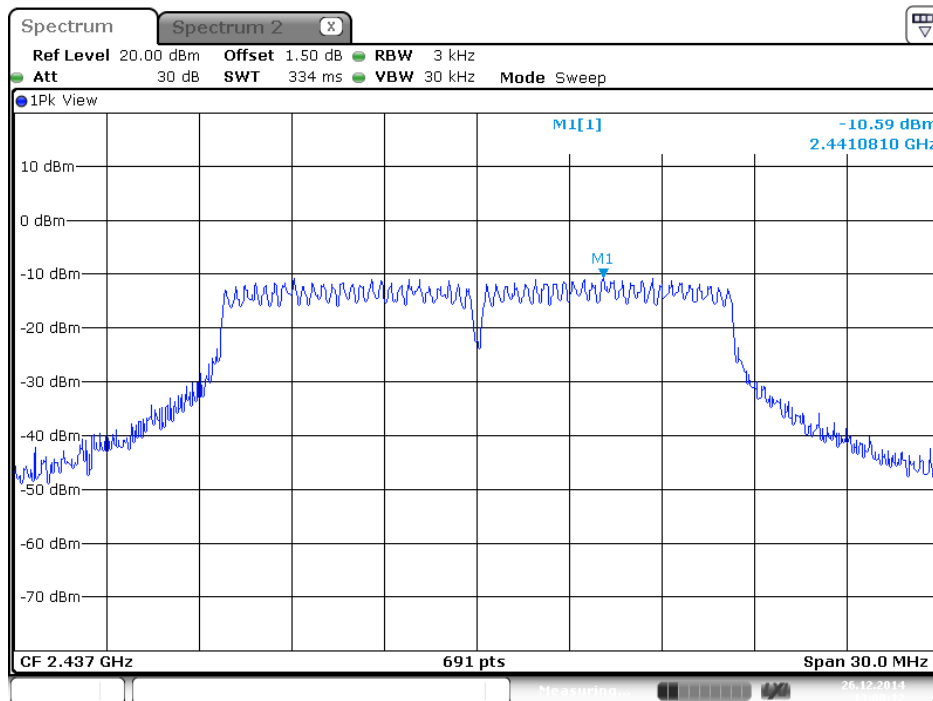

4.4. 6dB Spectrum Bandwidth Measurement

4.4.1. Limit

For digital modulation systems, the minimum 6 dB bandwidth shall be at least 500 kHz.

4.4.2. Measuring Instruments and Setting

Please refer to section 5 of equipments list in this report. The following table is the setting of the Spectrum Analyzer.

6dB Spectrum Bandwidth	
Spectrum Parameters	Setting
Attenuation	Auto
Span Frequency	> 6dB Bandwidth
RBW	100kHz
VBW	$\geq 3 \times \text{RBW}$
Detector	Peak
Trace	Max Hold
Sweep Time	Auto
99% Occupied Bandwidth	
Spectrum Parameters	Setting
Span	1.5 times to 5.0 times the OBW
RBW	1 % to 5 % of the OBW
VBW	$\geq 3 \times \text{RBW}$
Detector	Peak
Trace	Max Hold

4.4.3. Test Procedures

For Radiated 6dB Bandwidth Measurement:

1. The transmitter was radiated to the spectrum analyzer in peak hold mode.
2. Test was performed in accordance with KDB 558074 D01 v03r02 for Performing Compliance Measurements on Digital Transmission Systems (DTS) - section 8.0 DTS bandwidth = > 8.1 Option 1.
3. Multiple antenna system was performed in accordance with KDB 662911 D01 v02r01 Emissions Testing of Transmitters with Multiple Outputs in the Same Band.
4. Measured the spectrum width with power higher than 6dB below carrier.

4.4.4. Test Setup Layout

For Radiated 6dB Bandwidth Measurement:

This test setup layout is the same as that shown in section 4.5.4.

4.4.5. Test Deviation

There is no deviation with the original standard.

4.4.6. EUT Operation during Test

The EUT was programmed to be in continuously transmitting mode.

4.4.7. Test Result of 6dB Spectrum Bandwidth

Temperature	24°C	Humidity	63%
Test Engineer	Magic Lai	Configurations	IEEE 802.11n

Configuration IEEE 802.11n MCS8 HT20 / Ant. 0 + Ant. 1

Channel	Frequency	6dB Bandwidth (MHz)	99% Occupied Bandwidth (MHz)	Min. Limit (kHz)	Test Result
1	2412 MHz	17.73	17.97	500	Complies
6	2437 MHz	17.73	17.88	500	Complies
11	2462 MHz	17.68	17.97	500	Complies

Configuration IEEE 802.11n MCS8 HT40 / Ant. 0 + Ant. 1

Channel	Frequency	6dB Bandwidth (MHz)	99% Occupied Bandwidth (MHz)	Min. Limit (kHz)	Test Result
3	2422 MHz	36.40	36.32	500	Complies
6	2437 MHz	36.40	36.46	500	Complies
9	2452 MHz	36.40	36.61	500	Complies

Temperature	24°C	Humidity	63%
Test Engineer	Magic Lai	Configurations	IEEE 802.11b/g

Configuration IEEE 802.11b / Ant. 0

Channel	Frequency	6dB Bandwidth (MHz)	99% Occupied Bandwidth (MHz)	Min. Limit (kHz)	Test Result
1	2412 MHz	10.08	15.10	500	Complies
6	2437 MHz	10.08	15.19	500	Complies
11	2462 MHz	10.08	15.10	500	Complies

Configuration IEEE 802.11g / Ant. 0

Channel	Frequency	6dB Bandwidth (MHz)	99% Occupied Bandwidth (MHz)	Min. Limit (kHz)	Test Result
1	2412 MHz	16.57	16.93	500	Complies
6	2437 MHz	16.52	17.01	500	Complies
11	2462 MHz	16.52	17.01	500	Complies

Note: All the test values were listed in the report.

For plots, only the channel with worse result was shown.

6 dB Bandwidth Plot on Configuration IEEE 802.11n MCS8 HT20 / 2462 MHz / Ant. 0 + Ant. 1

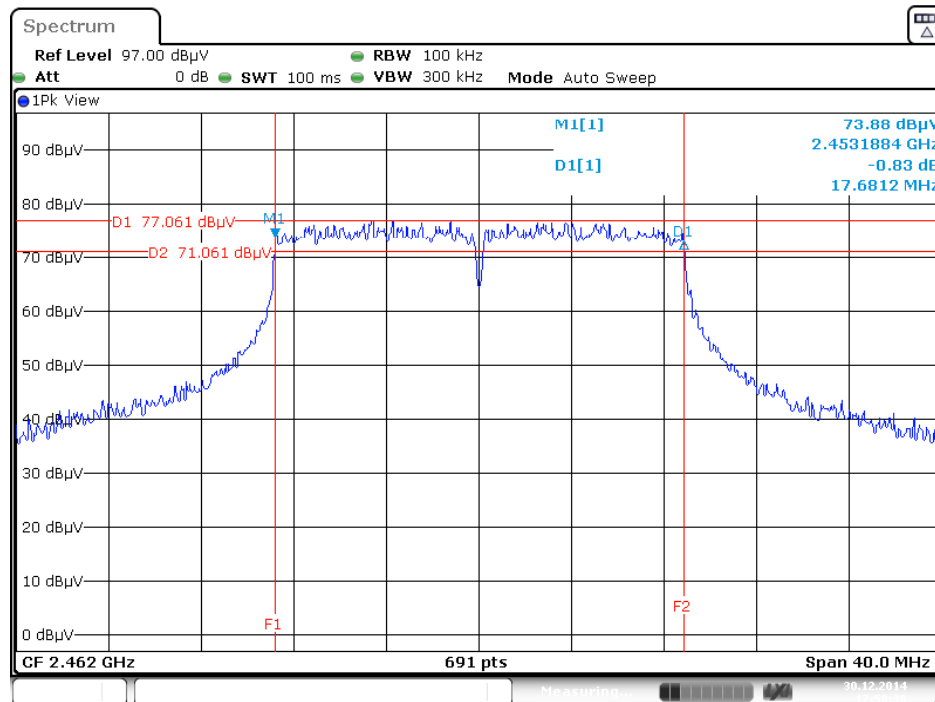

Date: 30 DEC. 2014 17:58:38

99% Occupied Bandwidth Plot on Configuration IEEE 802.11n MCS8 HT20 / 2462 MHz / Ant. 0 + Ant. 1

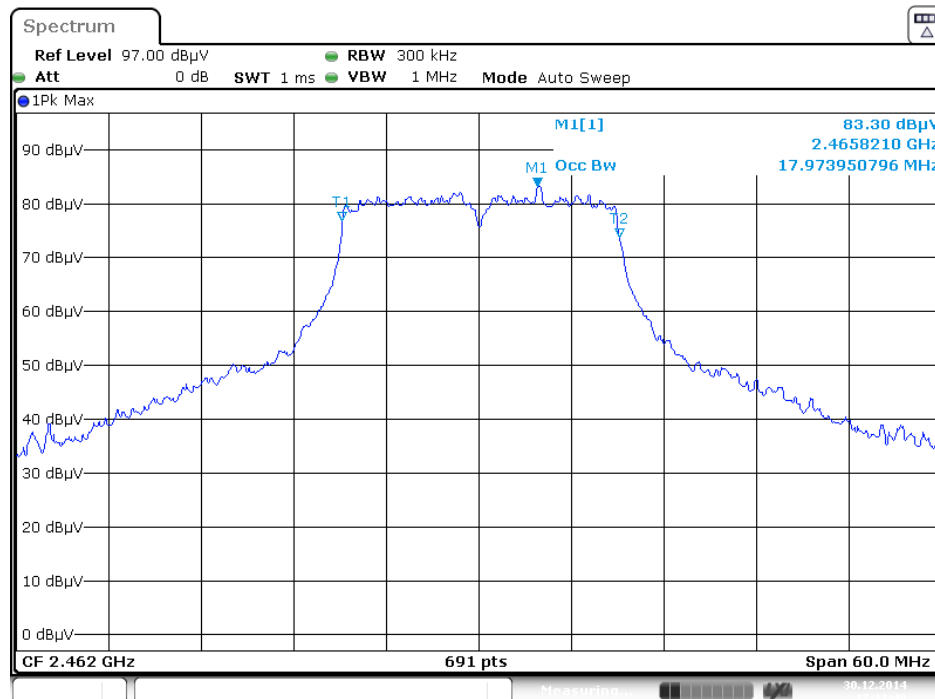

Date: 30 DEC. 2014 17:31:40

6 dB Bandwidth Plot on Configuration IEEE 802.11n MCS8 HT40 / 2422 MHz / Ant. 0 + Ant. 1

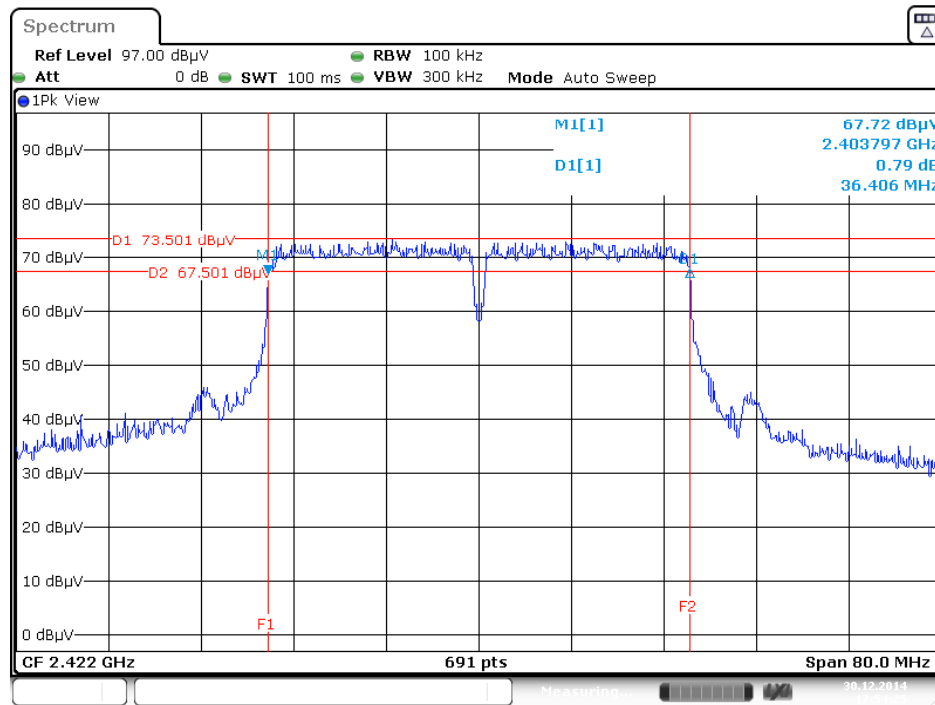

Date: 30 DEC. 2014 17:54:25

99% Occupied Bandwidth Plot on Configuration IEEE 802.11n MCS8 HT40 / 2452 MHz / Ant. 0 + Ant. 1

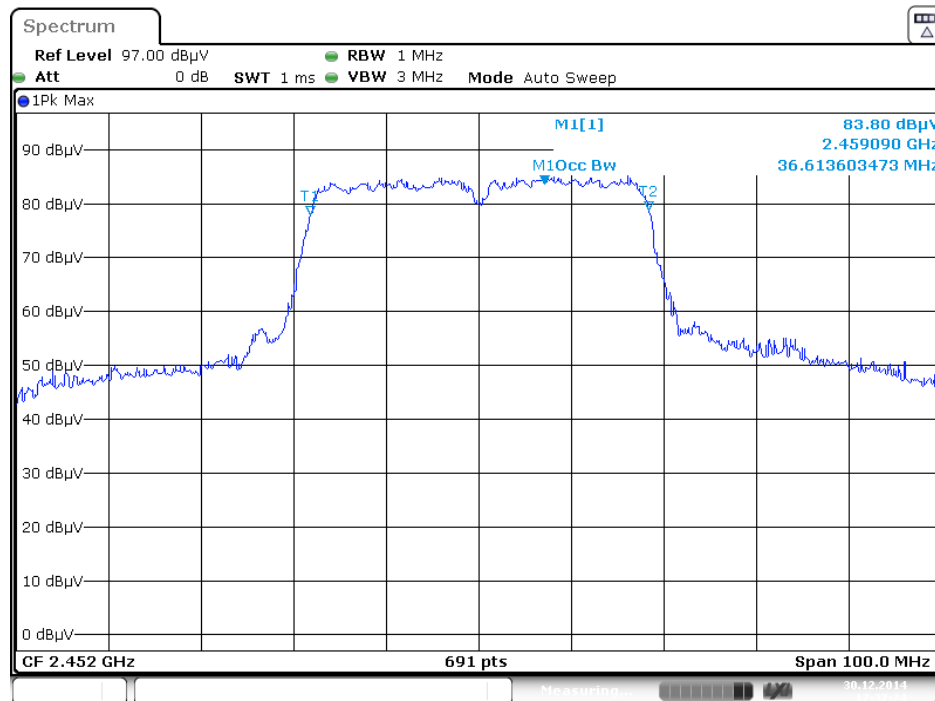

Date: 30 DEC. 2014 17:37:24

6 dB Bandwidth Plot on Configuration IEEE 802.11b / 2412 MHz / Ant. 0

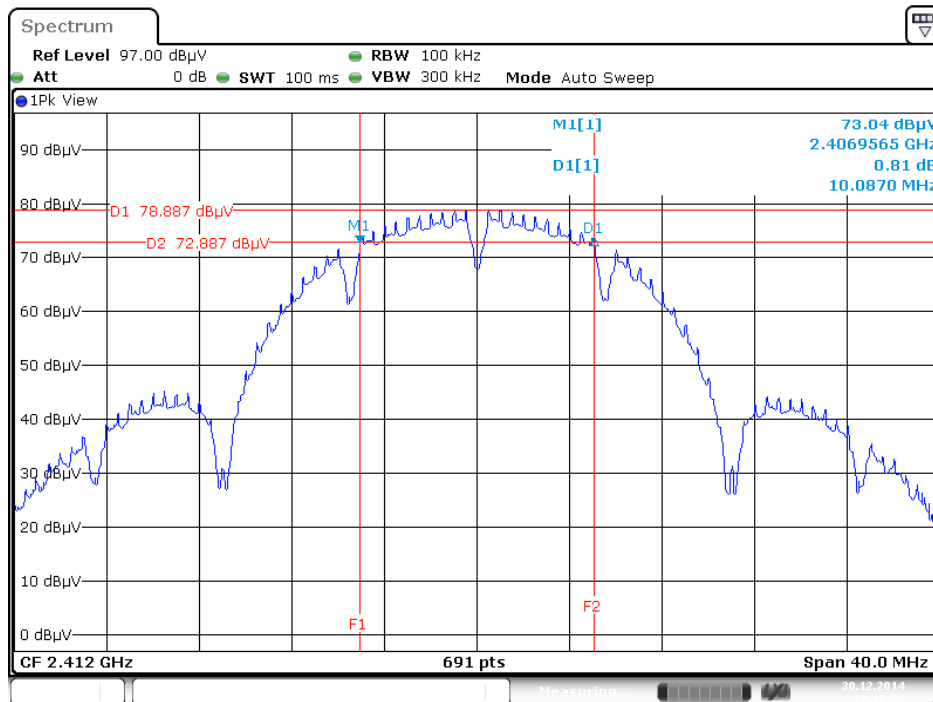

99% Occupied Bandwidth Plot on Configuration IEEE 802.11b / 2437 MHz / Ant. 0

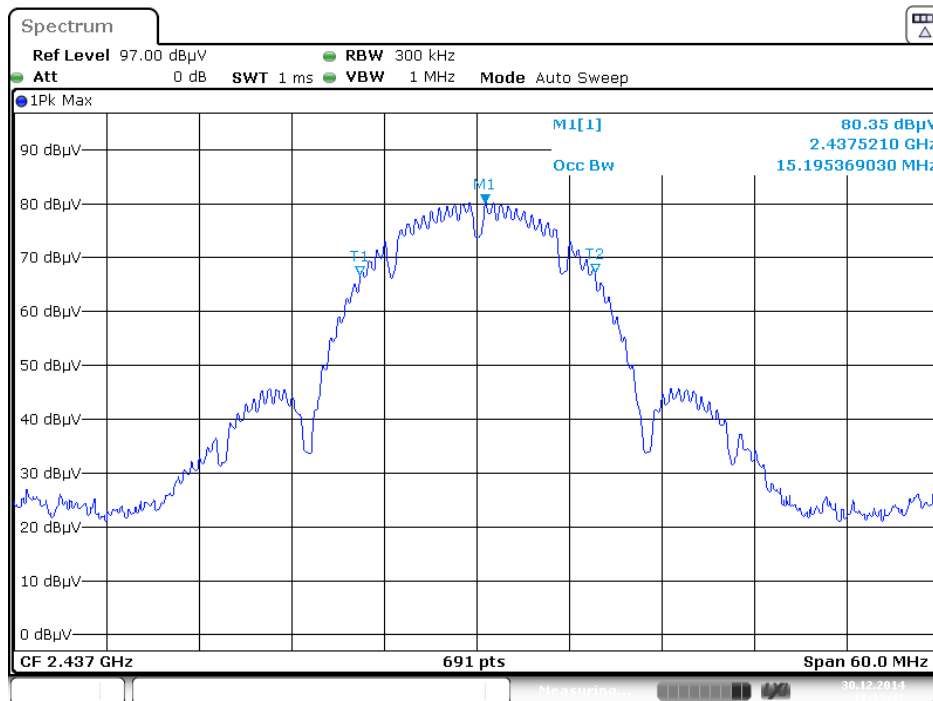

6 dB Bandwidth Plot on Configuration IEEE 802.11g / 2437 MHz / Ant. 0

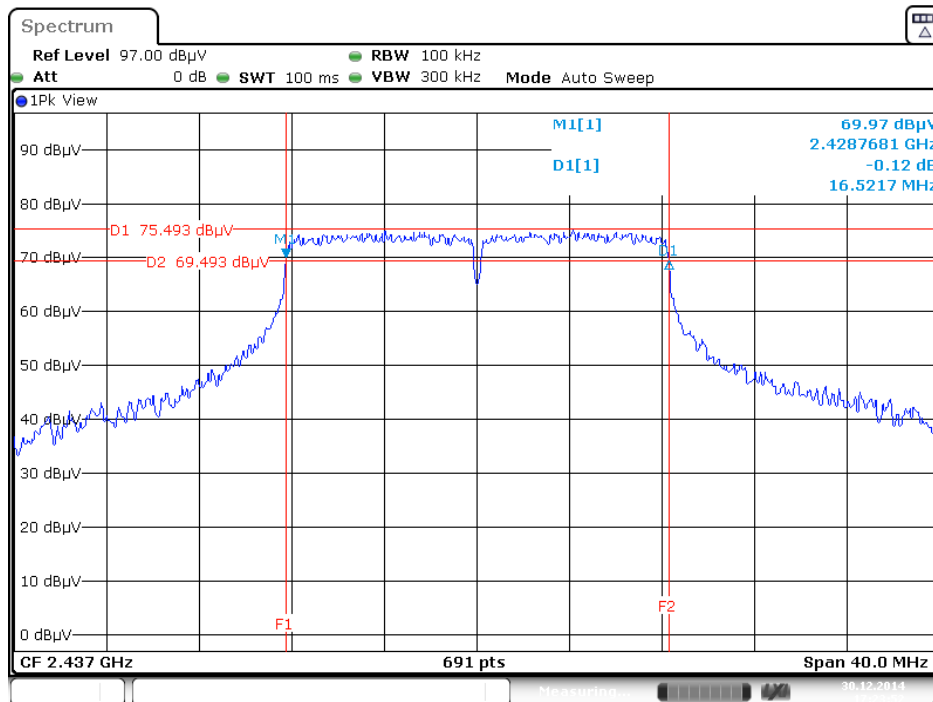

99% Occupied Bandwidth Plot on Configuration IEEE 802.11g / 2437 MHz / Ant. 0

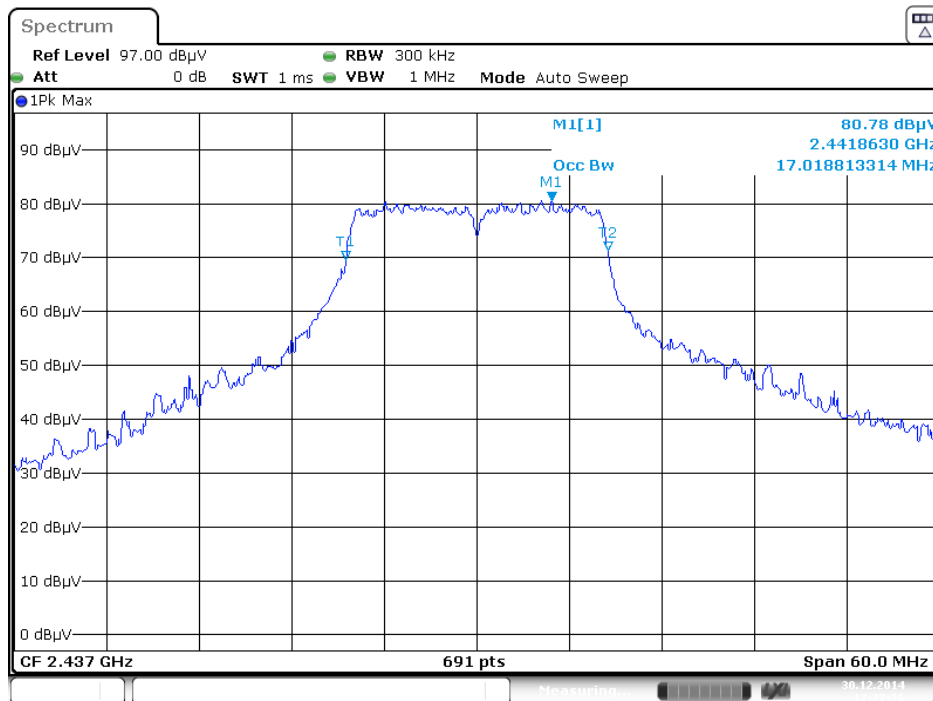

4.5. Radiated Emissions Measurement

4.5.1. Limit

30dBc in any 100 kHz bandwidth outside the operating frequency band. In case the emission fall within the restricted band specified on 15.205(a), then the 15.209(a) limit in the table below has to be followed.

Frequencies (MHz)	Field Strength (micorvolts/meter)	Measurement Distance (meters)
0.009~0.490	2400/F(kHz)	300
0.490~1.705	24000/F(kHz)	30
1.705~30.0	30	30
30~88	100	3
88~216	150	3
216~960	200	3
Above 960	500	3

4.5.2. Measuring Instruments and Setting

Please refer to section 5 of equipments list in this report. The following table is the setting of spectrum analyzer and receiver.

Spectrum Parameter	Setting
Attenuation	Auto
Start Frequency	1000 MHz
Stop Frequency	10th carrier harmonic
RBW / VBW (Emission in restricted band)	1MHz / 3MHz for Peak, 1MHz / 1/T for Average
RBW / VBW (Emission in non-restricted band)	100kHz / 300kHz for peak

Receiver Parameter	Setting
Attenuation	Auto
Start ~ Stop Frequency	9kHz~150kHz / RBW 200Hz for QP
Start ~ Stop Frequency	150kHz~30MHz / RBW 9kHz for QP
Start ~ Stop Frequency	30MHz~1000MHz / RBW 120kHz for QP

4.5.3. Test Procedures

1. Configure the EUT according to ANSI C63.10. The EUT was placed on the top of the turntable 1.5 meter above ground. The phase center of the receiving antenna mounted on the top of a height-variable antenna tower was placed 3 meters far away from the turntable.
2. Power on the EUT and all the supporting units. The turntable was rotated by 360 degrees to determine the position of the highest radiation.
3. The height of the broadband receiving antenna was varied between one meter and four meters above ground to find the maximum emissions field strength of both horizontal and vertical polarization.
4. For each suspected emissions, the antenna tower was scan (from 1 m to 4 m) and then the turntable was rotated (from 0 degree to 360 degrees) to find the maximum reading.
5. Set the test-receiver system to Peak or CISPR quasi-peak Detect Function with specified bandwidth under Maximum Hold Mode.
6. For emissions above 1GHz, use 1MHz VBW and 3MHz RBW for peak reading. Then 1MHz RBW and 1/T VBW for average reading in spectrum analyzer.
7. If the emissions level of the EUT in peak mode was 3 dB lower than the average limit specified, then testing will be stopped and peak values of EUT will be reported, otherwise, the emissions which do not have 3 dB margin will be repeated one by one using the quasi-peak method for below 1GHz.
8. For testing above 1GHz, the emissions level of the EUT in peak mode was lower than average limit (that means the emissions level in peak mode also complies with the limit in average mode), then testing will be stopped and peak values of EUT will be reported, otherwise, the emissions will be measured in average mode again and reported.
9. In case the emission is lower than 30MHz, loop antenna has to be used for measurement and the recorded data should be QP measured by receiver. High – Low scan is not required in this case.

4.5.4. Test Setup Layout

For Radiated Emissions: 9kHz ~30MHz

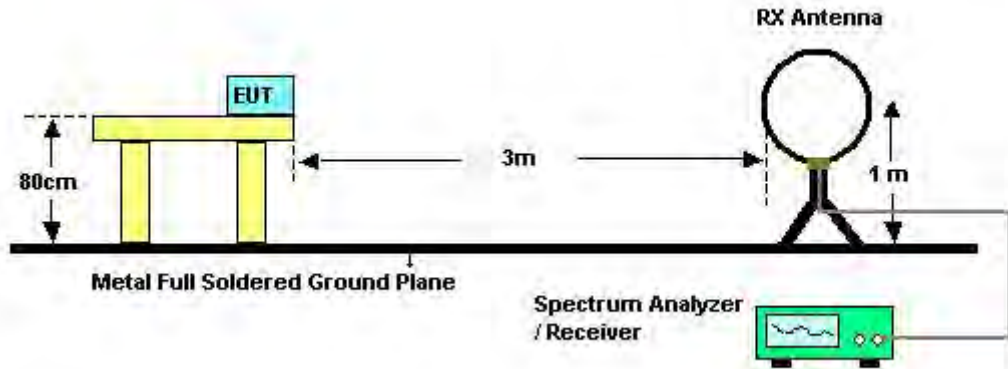

For Radiated Emissions: 30MHz~1GHz

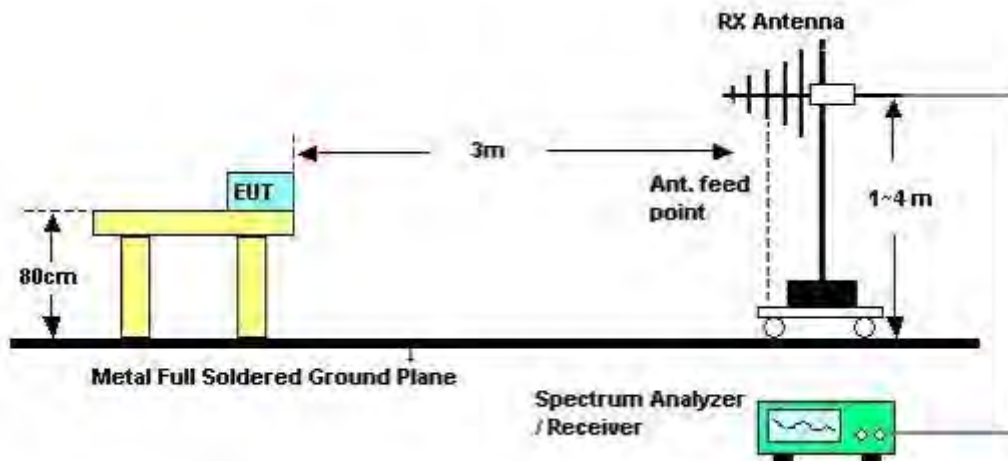

For Radiated Emissions: Above 1GHz

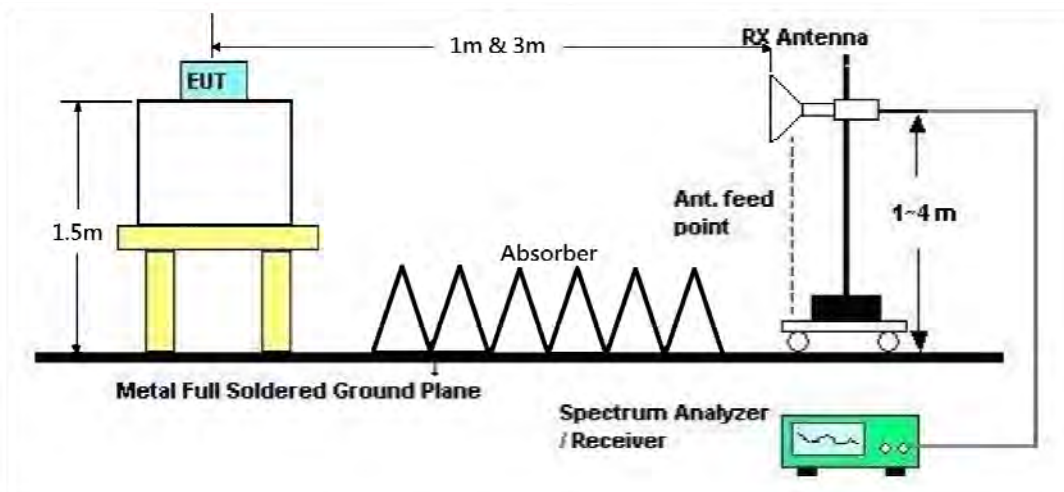

4.5.5. Test Deviation

There is no deviation with the original standard.

4.5.6. EUT Operation during Test

The EUT was programmed to be in continuously transmitting mode.

4.5.7. Results of Radiated Emissions (9kHz~30MHz)

Temperature	24°C	Humidity	61%
Test Engineer	Taka Hsu	Configurations	Normal Link
Test Date	Nov. 01, 2014		

Freq. (MHz)	Level (dBuV)	Over Limit (dB)	Limit Line (dBuV)	Remark
-	-	-	-	See Note

Note:

The amplitude of spurious emissions which are attenuated by more than 20 dB below the permissible value has no need to be reported.

Distance extrapolation factor = $40 \log(\text{specific distance} / \text{test distance})$ (dB);

Limit line = specific limits (dBuV) + distance extrapolation factor.

4.5.8. Results of Radiated Emissions (30MHz~1GHz)

Temperature	24°C	Humidity	61%
Test Engineer	Taka Hsu	Configurations	Normal Link

Horizontal

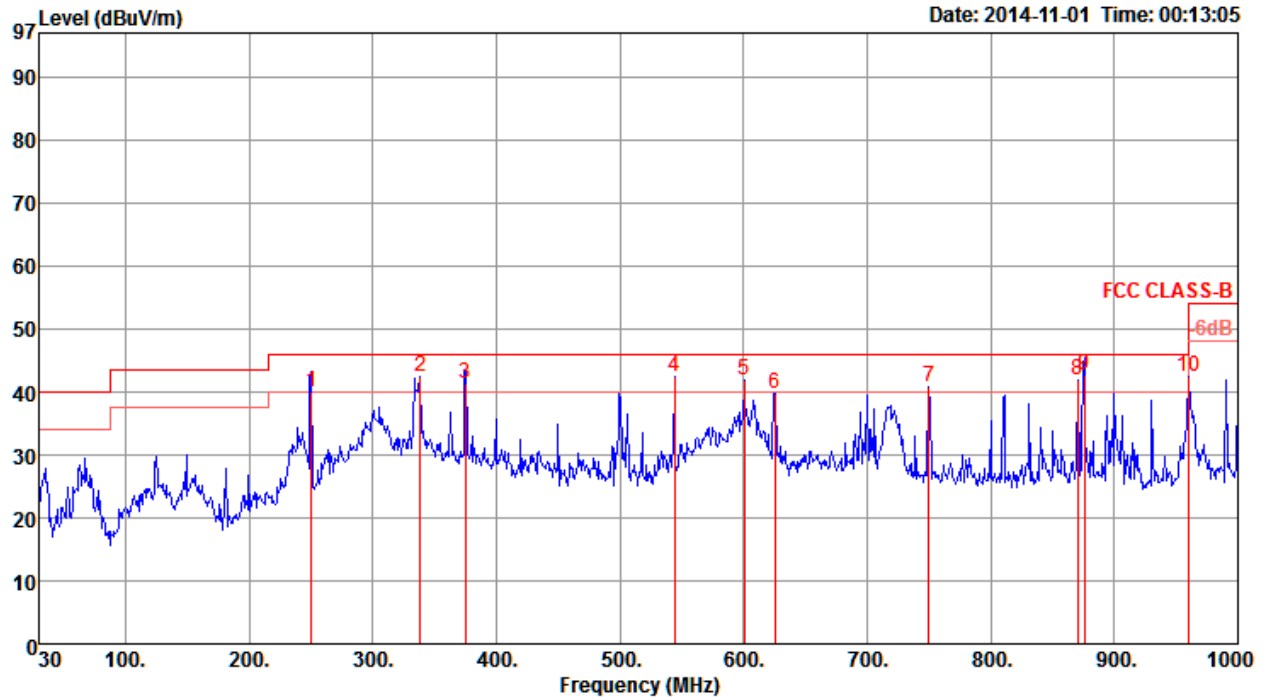

	Freq	Level	Limit	Over	Read	CableAntenna	Preamp		T/Pos	A/Pos	
	MHz	dBuV/m	dBuV/m	dB	dBuV	dB	dB/m	dB	deg	cm	Pol/Phase
1	250.19	40.12	46.00	-5.88	52.47	1.40	13.20	26.95	17	126	HORIZONTAL
2	338.46	42.46	46.00	-3.54	52.56	1.69	15.21	27.00	0	100	HORIZONTAL
3	375.32	41.40	46.00	-4.60	50.81	1.79	16.06	27.26	301	108	HORIZONTAL
4	544.10	42.46	46.00	-3.54	49.28	2.21	18.86	27.89	0	100	HORIZONTAL
5	600.36	41.83	46.00	-4.17	47.47	2.36	19.60	27.60	0	100	HORIZONTAL
6	625.58	39.83	46.00	-6.17	45.19	2.42	19.80	27.58	0	100	HORIZONTAL
7	749.74	40.83	46.00	-5.17	44.70	2.65	20.60	27.12	0	100	HORIZONTAL
8	870.02	41.96	46.00	-4.04	44.23	2.88	21.72	26.87	0	100	HORIZONTAL
9	875.84	42.67	46.00	-3.33	44.88	2.89	21.76	26.86	186	100	HORIZONTAL
10	960.00	42.52	46.00	-3.48	43.50	3.05	22.42	26.45	0	100	HORIZONTAL

Vertical

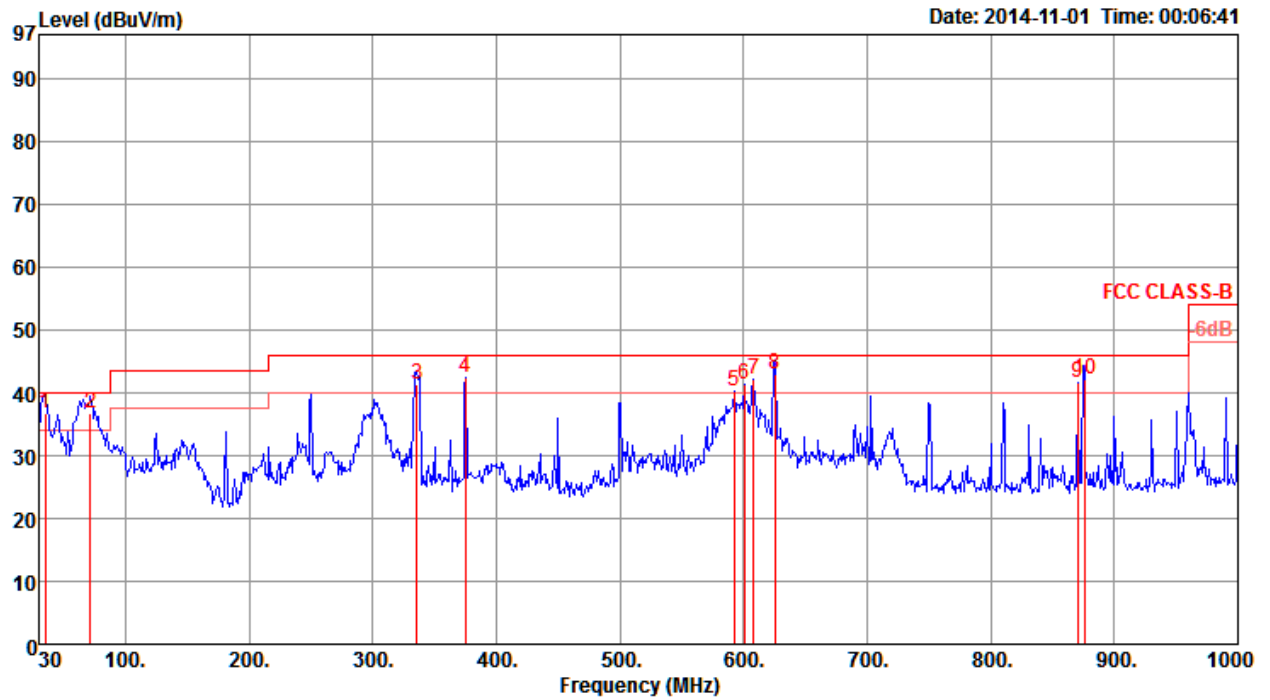

	Freq	Level	Limit	Over	Read	CableAntenna	Preamp		T/Pos	A/Pos	Pol/Phase
	MHz	dBuV/m	dBuV/m	dB	dBuV	dB	dB/m	dB	deg	cm	
1	34.85	36.74	40.00	-3.26	47.51	0.43	16.80	28.00	177	100	VERTICAL
2	71.71	36.82	40.00	-3.18	57.11	0.69	6.95	27.93	192	100	VERTICAL
3	335.55	41.36	46.00	-4.64	51.55	1.69	15.11	26.99	50	138	VERTICAL
4	375.32	42.35	46.00	-3.65	51.76	1.79	16.06	27.26	0	400	VERTICAL
5	592.60	40.31	46.00	-5.69	46.10	2.34	19.51	27.64	0	400	VERTICAL
6	600.36	41.33	46.00	-4.67	46.97	2.36	19.60	27.60	0	400	VERTICAL
7	608.12	42.21	46.00	-3.79	47.76	2.38	19.66	27.59	0	400	VERTICAL
8	625.58	42.99	46.00	-3.01	48.35	2.42	19.80	27.58	259	121	VERTICAL
9	870.02	41.58	46.00	-4.42	43.85	2.88	21.72	26.87	0	400	VERTICAL
10	875.84	42.28	46.00	-3.72	44.49	2.89	21.76	26.86	213	116	VERTICAL

Note:

The amplitude of spurious emissions which are attenuated by more than 20 dB below the permissible value has no need to be reported.

Emission level (dBuV/m) = 20 log Emission level (uV/m).

Corrected Reading: Antenna Factor + Cable Loss + Read Level - Preamp Factor = Level.

4.5.9. Results for Radiated Emissions (1GHz~10th Harmonic)

Temperature	24°C	Humidity	61%
Test Engineer	Taka Hsu	Configurations	IEEE 802.11n MCS8 HT20 CH 1 / Ant. 0 + Ant. 1
Test Date	Dec. 13, 2014		

Horizontal

	Freq	Level	Limit Line	Over Limit	Read Level	Cable Loss	Antenna Factor	Preamp Factor	Remark	A/Pos	T/Pos	Pol/Phase
	MHz	dBuV/m	dBuV/m	dB	dBuV	dB	dB/m	dB		cm	deg	
1	4823.92	41.52	54.00	-12.48	37.46	5.87	33.39	35.20	Average	178	282	HORIZONTAL
2	4824.56	54.90	74.00	-19.10	50.84	5.87	33.39	35.20	Peak	178	282	HORIZONTAL
3	7232.84	46.19	54.00	-7.81	38.13	7.09	36.37	35.40	Average	180	286	HORIZONTAL
4	7235.32	59.86	74.00	-14.14	51.80	7.09	36.37	35.40	Peak	180	286	HORIZONTAL

Vertical

	Freq	Level	Limit Line	Over Limit	Read Level	Cable Loss	Antenna Factor	Preamp Factor	Remark	A/Pos	T/Pos	Pol/Phase
	MHz	dBuV/m	dBuV/m	dB	dBuV	dB	dB/m	dB		cm	deg	
1	4822.80	48.37	74.00	-25.63	44.31	5.87	33.39	35.20	Peak	167	342	VERTICAL
2	4823.68	35.67	54.00	-18.33	31.61	5.87	33.39	35.20	Average	167	342	VERTICAL
3	7227.88	57.88	74.00	-16.12	49.82	7.08	36.37	35.39	Peak	103	260	VERTICAL
4	7233.00	43.99	54.00	-10.01	35.93	7.09	36.37	35.40	Average	103	260	VERTICAL

Temperature	24°C	Humidity	61%
Test Engineer	Taka Hsu	Configurations	IEEE 802.11n MCS8 HT20 CH 6 / Ant. 0 + Ant. 1
Test Date	Dec. 13, 2014		

Horizontal

	Freq	Level	Limit Line	Over Limit	Read Level	CableAntenna Loss	Antenna Factor	Preamp Factor	Remark	A/Pos	T/Pos	Pol/Phase
	MHz	dBuV/m	dBuV/m	dB	dBuV	dB	dB/m	dB		cm	deg	
1	4874.04	40.66	54.00	-13.34	36.46	5.92	33.48	35.20	Average	214	285	HORIZONTAL
2	4877.12	52.46	74.00	-21.54	48.26	5.92	33.48	35.20	Peak	214	285	HORIZONTAL
3	7310.12	45.86	54.00	-8.14	37.65	7.13	36.51	35.43	Average	174	286	HORIZONTAL
4	7312.08	58.84	74.00	-15.16	50.63	7.13	36.51	35.43	Peak	174	286	HORIZONTAL

Vertical

	Freq	Level	Limit Line	Over Limit	Read Level	CableAntenna Loss	Antenna Factor	Preamp Factor	Remark	A/Pos	T/Pos	Pol/Phase
	MHz	dBuV/m	dBuV/m	dB	dBuV	dB	dB/m	dB		cm	deg	
1	4873.80	35.52	54.00	-18.48	31.32	5.92	33.48	35.20	Average	175	344	VERTICAL
2	4874.16	48.49	74.00	-25.51	44.29	5.92	33.48	35.20	Peak	175	344	VERTICAL
3	7308.04	43.30	54.00	-10.70	35.09	7.13	36.51	35.43	Average	101	260	VERTICAL
4	7318.36	56.87	74.00	-17.13	48.65	7.14	36.51	35.43	Peak	101	260	VERTICAL

Temperature	24°C	Humidity	61%
Test Engineer	Taka Hsu	Configurations	IEEE 802.11n MCS8 HT20 CH 11 / Ant. 0 + Ant. 1
Test Date	Dec. 13, 2014		

Horizontal

	Freq	Level	Limit Line	Over Limit	Read Level	Cable Loss	Antenna Factor	Preamp Factor	Remark	A/Pos	T/Pos	Pol/Phase
	MHz	dBuV/m	dBuV/m	dB	dBuV	dB	dB/m	dB		cm	deg	
1	4924.04	40.06	54.00	-13.94	35.71	5.97	33.58	35.20	Average	195	316	HORIZONTAL
2	4924.12	50.16	74.00	-23.84	45.81	5.97	33.58	35.20	Peak	195	316	HORIZONTAL
3	7385.92	41.23	54.00	-12.77	32.91	7.17	36.61	35.46	Average	158	277	HORIZONTAL
4	7389.28	54.59	74.00	-19.41	46.27	7.17	36.61	35.46	Peak	158	277	HORIZONTAL

Vertical

	Freq	Level	Limit Line	Over Limit	Read Level	Cable Loss	Antenna Factor	Preamp Factor	Remark	A/Pos	T/Pos	Pol/Phase
	MHz	dBuV/m	dBuV/m	dB	dBuV	dB	dB/m	dB		cm	deg	
1	4923.88	34.08	54.00	-19.92	29.73	5.97	33.58	35.20	Average	188	256	VERTICAL
2	4927.80	46.10	74.00	-27.90	41.75	5.97	33.58	35.20	Peak	188	256	VERTICAL
3	7383.08	42.05	54.00	-11.95	33.73	7.16	36.61	35.45	Average	106	261	VERTICAL
4	7383.76	55.37	74.00	-18.63	47.05	7.17	36.61	35.46	Peak	106	261	VERTICAL



Temperature	24°C	Humidity	61%
Test Engineer	Taka Hsu	Configurations	IEEE 802.11n MCS8 HT40 CH 3 / Ant. 0 + Ant. 1
Test Date	Dec. 13, 2014		

Horizontal

	Freq	Level	Limit	Over	Read	CableAntenna	Preamp	Remark	A/Pos	T/Pos	Pol/Phase	
	MHz	dBuV/m	dBuV/m	dB	dBuV	dB	dB/m	dB	cm	deg		
1	4844.16	36.07	54.00	-17.93	31.97	5.88	33.42	35.20	Average	177	239	HORIZONTAL
2	4844.72	47.70	74.00	-26.30	43.60	5.88	33.42	35.20	Peak	177	239	HORIZONTAL
3	7258.96	52.59	74.00	-21.41	44.47	7.10	36.43	35.41	Peak	168	262	HORIZONTAL
4	7262.16	40.34	54.00	-13.66	32.22	7.10	36.43	35.41	Average	168	262	HORIZONTAL

Vertical

	Freq	Level	Limit	Over	Read	CableAntenna	Preamp	Remark	A/Pos	T/Pos	Pol/Phase	
	MHz	dBuV/m	dBuV/m	dB	dBuV	dB	dB/m	dB	cm	deg		
1	4824.40	45.86	74.00	-28.14	41.80	5.87	33.39	35.20	Peak	159	168	VERTICAL
2	4843.52	32.93	54.00	-21.07	28.83	5.88	33.42	35.20	Average	159	164	VERTICAL
3	7259.20	51.01	74.00	-22.99	42.89	7.10	36.43	35.41	Peak	166	231	VERTICAL
4	7260.16	38.41	54.00	-15.59	30.29	7.10	36.43	35.41	Average	166	231	VERTICAL

Temperature	24°C	Humidity	61%
Test Engineer	Taka Hsu	Configurations	IEEE 802.11n MCS8 HT40 CH 6 / Ant. 0 + Ant. 1
Test Date	Dec. 13, 2014		

Horizontal

	Freq	Level	Limit	Over	Read	CableAntenna	Preamp	Remark	A/Pos	T/Pos	PoI/Phase
	MHz	dBuV/m	dBuV/m	dB	dBuV	dB	dB/m	dB	cm	deg	
1	4866.32	50.50	74.00	-23.50	46.35	5.90	33.45	35.20	182	281	HORIZONTAL
2	4874.08	39.03	54.00	-14.97	34.83	5.92	33.48	35.20	182	281	HORIZONTAL
3	7314.04	43.30	54.00	-10.70	35.09	7.13	36.51	35.43	177	286	HORIZONTAL
4	7317.80	55.96	74.00	-18.04	47.74	7.14	36.51	35.43	177	286	HORIZONTAL

Vertical

	Freq	Level	Limit	Over	Read	CableAntenna	Preamp	Remark	A/Pos	T/Pos	PoI/Phase
	MHz	dBuV/m	dBuV/m	dB	dBuV	dB	dB/m	dB	cm	deg	
1	4866.48	46.25	74.00	-27.75	42.10	5.90	33.45	35.20	142	259	VERTICAL
2	4873.36	33.85	54.00	-20.15	29.65	5.92	33.48	35.20	142	259	VERTICAL
3	7307.00	55.11	74.00	-18.89	46.93	7.13	36.48	35.43	100	259	VERTICAL
4	7319.00	42.24	54.00	-11.76	34.02	7.14	36.51	35.43	100	259	VERTICAL



Temperature	24°C	Humidity	61%
Test Engineer	Taka Hsu	Configurations	IEEE 802.11n MCS8 HT40 CH 9 / Ant. 0 + Ant. 1
Test Date	Dec. 13, 2014		

Horizontal

	Freq	Level	Limit	Over	Read	CableAntenna	Preamp	Remark	A/Pos	T/Pos	Pol/Phase	
	MHz	dBuV/m	dBuV/m	dB	dBuV	dB	dB/m	dB	cm	deg		
1	4903.68	48.60	74.00	-25.40	44.34	5.95	33.51	35.20	Peak	198	318	HORIZONTAL
2	4904.08	38.65	54.00	-15.35	34.39	5.95	33.51	35.20	Average	198	318	HORIZONTAL
3	7349.12	54.50	74.00	-19.50	46.23	7.15	36.56	35.44	Peak	177	286	HORIZONTAL
4	7349.44	41.44	54.00	-12.56	33.17	7.15	36.56	35.44	Average	177	282	HORIZONTAL

Vertical

	Freq	Level	Limit	Over	Read	CableAntenna	Preamp	Remark	A/Pos	T/Pos	Pol/Phase	
	MHz	dBuV/m	dBuV/m	dB	dBuV	dB	dB/m	dB	cm	deg		
1	4903.92	33.97	54.00	-20.03	29.71	5.95	33.51	35.20	Average	184	262	VERTICAL
2	4913.12	46.25	74.00	-27.75	41.96	5.95	33.54	35.20	Peak	184	262	VERTICAL
3	7361.44	40.96	54.00	-13.04	32.66	7.16	36.59	35.45	Average	189	275	VERTICAL
4	7368.40	52.51	74.00	-21.49	44.21	7.16	36.59	35.45	Peak	189	275	VERTICAL



Temperature	24°C	Humidity	61%
Test Engineer	Taka Hsu	Configurations	IEEE 802.11b CH 1 / Ant. 0
Test Date	Dec. 12, 2014		

Horizontal

	Freq	Level	Limit Line	Over Limit	Read Level	Cable Loss	Preamp Factor	Antenna Factor	Pol/Phase	T/Pos	A/Pos	Remark
	MHz	dBuV/m	dBuV/m	dB	dBuV	dB	dB	dB/m		deg	cm	
1	4823.99	56.40	74.00	-17.60	53.27	5.74	33.70	31.09	HORIZONTAL	287	180	Peak
2	4824.04	53.89	54.00	-0.11	50.76	5.74	33.70	31.09	HORIZONTAL	287	180	Average

Vertical

	Freq	Level	Limit Line	Over Limit	Read Level	Cable Loss	Preamp Factor	Antenna Factor	Pol/Phase	T/Pos	A/Pos	Remark
	MHz	dBuV/m	dBuV/m	dB	dBuV	dB	dB	dB/m		deg	cm	
1	4824.04	41.07	54.00	-12.93	37.95	5.74	33.70	31.08	VERTICAL	213	100	Average
2	4824.18	48.91	74.00	-25.09	45.79	5.74	33.70	31.08	VERTICAL	213	100	Peak

Temperature	24°C	Humidity	61%
Test Engineer	Taka Hsu	Configurations	IEEE 802.11b CH 6 / Ant. 0
Test Date	Dec. 12, 2014		

Horizontal

	Freq	Level	Limit Line	Over Limit	Read Level	Cable Loss	Preamp Factor	Antenna Factor	Pol/Phase	T/Pos	A/Pos	Remark
	MHz	dBuV/m	dBuV/m	dB	dBuV	dB	dB	dB/m		deg	cm	
1	4874.04	53.70	54.00	-0.30	50.43	5.77	33.68	31.18	HORIZONTAL	280	176	Average
2	4874.06	56.20	74.00	-17.80	52.93	5.77	33.68	31.18	HORIZONTAL	280	176	Peak
3	7311.75	51.75	54.00	-2.25	42.50	7.19	34.00	36.06	HORIZONTAL	278	166	Average
4	7312.01	58.03	74.00	-15.97	48.78	7.19	34.00	36.06	HORIZONTAL	278	166	Peak

Vertical

	Freq	Level	Limit Line	Over Limit	Read Level	Cable Loss	Preamp Factor	Antenna Factor	Pol/Phase	T/Pos	A/Pos	Remark
	MHz	dBuV/m	dBuV/m	dB	dBuV	dB	dB	dB/m		deg	cm	
1	4874.06	41.16	54.00	-12.84	37.89	5.77	33.68	31.18	VERTICAL	223	133	Average
2	4874.17	49.21	74.00	-24.79	45.94	5.77	33.68	31.18	VERTICAL	223	133	Peak
3	7309.03	54.85	74.00	-19.15	45.61	7.19	34.00	36.05	VERTICAL	270	187	Peak
4	7311.90	42.68	54.00	-11.32	33.44	7.19	34.00	36.05	VERTICAL	270	187	Average

Temperature	24°C	Humidity	61%
Test Engineer	Taka Hsu	Configurations	IEEE 802.11b CH 11 / Ant. 0
Test Date	Dec. 12, 2014		

Horizontal

	Freq	Level	Limit	Over	Read	Cable	Preamp	Antenna		T/Pos	A/Pos	Remark
	MHz	dBuV/m	dBuV/m	dB	dBuV	Loss	Factor	Factor	Pol/Phase	deg	cm	
1	4923.99	56.47	74.00	-17.53	53.08	5.79	33.67	31.27	HORIZONTAL	281	193	Peak
2	4924.01	53.93	54.00	-0.07	50.54	5.79	33.67	31.27	HORIZONTAL	281	193	Average
3	7384.26	56.96	74.00	-17.04	47.55	7.25	34.07	36.23	HORIZONTAL	285	241	Peak
4	7386.74	49.57	54.00	-4.43	40.15	7.25	34.07	36.24	HORIZONTAL	285	241	Average

Vertical

	Freq	Level	Limit	Over	Read	Cable	Preamp	Antenna		T/Pos	A/Pos	Remark
	MHz	dBuV/m	dBuV/m	dB	dBuV	Loss	Factor	Factor	Pol/Phase	deg	cm	
1	4924.04	42.10	54.00	-11.90	38.70	5.79	33.67	31.28	VERTICAL	226	186	Average
2	4924.10	49.21	74.00	-24.79	45.81	5.79	33.67	31.28	VERTICAL	226	186	Peak
3	7385.10	43.01	54.00	-10.99	33.58	7.25	34.07	36.25	VERTICAL	272	100	Average
4	7385.91	54.37	74.00	-19.63	44.94	7.25	34.07	36.25	VERTICAL	272	100	Peak

Temperature	24°C	Humidity	61%
Test Engineer	Taka Hsu	Configurations	IEEE 802.11g CH 1 / Ant. 0
Test Date	Dec. 13, 2014		

Horizontal

	Freq	Level	Limit	Over	Read	Cable	Antenna	Preamp	Remark	A/Pos	T/Pos	Pol/Phase
	MHz	dBuV/m	dBuV/m	dB	dBuV	Loss	Factor	Factor		cm	deg	
1	4824.00	50.10	74.00	-23.90	46.04	5.87	33.39	35.20	Peak	192	306	HORIZONTAL
2	4824.08	39.24	54.00	-14.76	35.18	5.87	33.39	35.20	Average	192	306	HORIZONTAL
3	7233.20	48.51	54.00	-5.49	40.45	7.09	36.37	35.40	Average	181	294	HORIZONTAL
4	7237.84	62.29	74.00	-11.71	54.23	7.09	36.37	35.40	Peak	181	294	HORIZONTAL

Vertical

	Freq	Level	Limit	Over	Read	Cable	Antenna	Preamp	Remark	A/Pos	T/Pos	Pol/Phase
	MHz	dBuV/m	dBuV/m	dB	dBuV	Loss	Factor	Factor		cm	deg	
1	4824.12	36.38	54.00	-17.62	32.32	5.87	33.39	35.20	Average	197	293	VERTICAL
2	4826.20	48.86	74.00	-25.14	44.80	5.87	33.39	35.20	Peak	197	293	VERTICAL
3	7232.64	52.11	74.00	-21.89	44.05	7.09	36.37	35.40	Peak	100	283	VERTICAL
4	7234.52	38.30	54.00	-15.70	30.24	7.09	36.37	35.40	Average	100	283	VERTICAL

Temperature	24°C	Humidity	61%
Test Engineer	Taka Hsu	Configurations	IEEE 802.11g CH 6 / Ant. 0
Test Date	Dec. 13, 2014		

Horizontal

	Freq	Level	Limit Line	Over Limit	Read Level	Cable Loss	Antenna Factor	Preamp Factor	Remark	A/Pos	T/Pos	Pol/Phase
	MHz	dBuV/m	dBuV/m	dB	dBuV	dB	dB/m	dB		cm	deg	
1	4872.00	50.02	74.00	-23.98	45.82	5.92	33.48	35.20	Peak	180	284	HORIZONTAL
2	4874.04	38.96	54.00	-15.04	34.76	5.92	33.48	35.20	Average	180	284	HORIZONTAL
3	7310.40	45.66	54.00	-8.34	37.45	7.13	36.51	35.43	Average	175	276	HORIZONTAL
4	7312.72	60.44	74.00	-13.56	52.23	7.13	36.51	35.43	Peak	175	276	HORIZONTAL

Vertical

	Freq	Level	Limit Line	Over Limit	Read Level	Cable Loss	Antenna Factor	Preamp Factor	Remark	A/Pos	T/Pos	Pol/Phase
	MHz	dBuV/m	dBuV/m	dB	dBuV	dB	dB/m	dB		cm	deg	
1	4873.92	34.91	54.00	-19.09	30.71	5.92	33.48	35.20	Average	195	316	VERTICAL
2	4875.20	47.16	74.00	-26.84	42.96	5.92	33.48	35.20	Peak	195	316	VERTICAL
3	7312.28	52.75	74.00	-21.25	44.54	7.13	36.51	35.43	Peak	102	244	VERTICAL
4	7315.20	39.20	54.00	-14.80	30.99	7.13	36.51	35.43	Average	102	244	VERTICAL

Temperature	24°C	Humidity	61%
Test Engineer	Taka Hsu	Configurations	IEEE 802.11g CH 11 / Ant. 0
Test Date	Dec. 13, 2014		

Horizontal

	Freq	Level	Limit Line	Over Limit	Read Level	Cable Loss	Antenna Factor	Preamp Factor	Remark	A/Pos	T/Pos	Pol/Phase
	MHz	dBuV/m	dBuV/m	dB	dBuV	dB	dB/m	dB		cm	deg	
1	4924.08	40.14	54.00	-13.86	35.79	5.97	33.58	35.20	Average	209	316	HORIZONTAL
2	4924.40	51.16	74.00	-22.84	46.81	5.97	33.58	35.20	Peak	209	316	HORIZONTAL
3	7382.64	57.66	74.00	-16.34	49.34	7.16	36.61	35.45	Peak	231	292	HORIZONTAL
4	7383.32	43.34	54.00	-10.66	35.03	7.16	36.61	35.46	Average	231	292	HORIZONTAL

Vertical

	Freq	Level	Limit Line	Over Limit	Read Level	Cable Loss	Antenna Factor	Preamp Factor	Remark	A/Pos	T/Pos	Pol/Phase
	MHz	dBuV/m	dBuV/m	dB	dBuV	dB	dB/m	dB		cm	deg	
1	4923.84	47.79	74.00	-26.21	43.44	5.97	33.58	35.20	Peak	185	316	VERTICAL
2	4924.08	34.59	54.00	-19.41	30.24	5.97	33.58	35.20	Average	185	316	VERTICAL
3	7386.40	39.39	54.00	-14.61	31.07	7.17	36.61	35.46	Average	170	243	VERTICAL
4	7387.60	53.18	74.00	-20.82	44.86	7.17	36.61	35.46	Peak	170	243	VERTICAL

Note:

The amplitude of spurious emissions that are attenuated by more than 20dB below the permissible value has no need to be reported.

Emission level (dBuV/m) = 20 log Emission level (uV/m).

Corrected Reading: Antenna Factor + Cable Loss + Read Level - Preamp Factor = Level.

4.6. Emissions Measurement

4.6.1. Limit

30dBc in any 100 kHz bandwidth outside the operating frequency band. In case the emission fall within the restricted band specified on 15.205(a), then the 15.209(a) limit in the table below has to be followed.

Frequencies (MHz)	Field Strength (micorvolts/meter)	Measurement Distance (meters)
0.009~0.490	2400/F(kHz)	300
0.490~1.705	24000/F(kHz)	30
1.705~30.0	30	30
30~88	100	3
88~216	150	3
216~960	200	3
Above 960	500	3

4.6.2. Measuring Instruments and Setting

Please refer to section 5 of equipments list in this report. The following table is the setting of the spectrum analyzer.

Spectrum Parameter	Setting
Attenuation	Auto
Span Frequency	100 MHz
RBW / VBW (Emission in restricted band)	1MHz / 3MHz for Peak, 1MHz / 1/T for Average
RBW / VBW (30dBc in any 100 kHz bandwidth emission)	100 kHz / 300 kHz for Peak

4.6.3. Test Procedures

For Radiated band edges Measurement:

1. The test procedure is the same as section 4.5.3, only the frequency range investigated is limited to 100MHz around band edges.

For Radiated Out of Band Emission Measurement:

1. Test was performed in accordance with KDB 558074 D01 v03r02 for Performing Compliance Measurements on Digital Transmission Systems (DTS) Operating Under §15.247 section 10.1 Unwanted Emissions into Non-Restricted Frequency Bands Measurement Procedure.

4.6.4. Test Setup Layout

For Radiated band edges Measurement:

This test setup layout is the same as that shown in section 4.5.4.

For Radiated Out of Band Emission Measurement:

This test setup layout is the same as that shown in section 4.5.4.

4.6.5. Test Deviation

There is no deviation with the original standard.

4.6.6. EUT Operation during Test

The EUT was programmed to be in continuously transmitting mode.

4.6.7. Test Result of Band Edge and Fundamental Emissions

Temperature	24°C	Humidity	61%
Test Engineer	Taka Hsu	Configurations	IEEE 802.11n MCS8 HT20 CH 1, 6, 11 / Ant. 0 + Ant. 1
Test Date	Dec. 12, 2014		

Channel 1

	Freq	Level	Limit Line	Over Limit	Read Level	Cable Loss	Preamp Factor	Antenna Factor	Pol/Phase	T/Pos	A/Pos	Remark
	MHz	dBuV/m	dBuV/m	dB	dBuV	dB	dB	dB/m		deg	cm	
1	2388.99	70.80	74.00	-3.20	39.77	3.99	0.00	27.04	HORIZONTAL	194	187	Peak
2	2390.00	50.34	54.00	-3.66	19.31	3.99	0.00	27.04	HORIZONTAL	194	187	Average
3	2407.66	109.03			77.94	4.01	0.00	27.08	HORIZONTAL	194	187	Peak
4	2409.40	99.42			68.33	4.01	0.00	27.08	HORIZONTAL	194	187	Average

Item 3, 4 are the fundamental frequency at 2412 MHz.

Channel 6

	Freq	Level	Limit Line	Over Limit	Read Level	Cable Loss	Preamp Factor	Antenna Factor	Pol/Phase	T/Pos	A/Pos	Remark
	MHz	dBuV/m	dBuV/m	dB	dBuV	dB	dB	dB/m		deg	cm	
1	2389.13	59.01	74.00	-14.99	27.98	3.99	0.00	27.04	HORIZONTAL	197	184	Peak
2	2390.00	44.87	54.00	-9.13	13.84	3.99	0.00	27.04	HORIZONTAL	197	184	Average
3	2434.40	99.89			68.71	4.03	0.00	27.15	HORIZONTAL	197	184	Average
4	2438.74	109.50			78.30	4.04	0.00	27.16	HORIZONTAL	197	184	Peak
5	2483.50	46.17	54.00	-7.83	14.84	4.07	0.00	27.26	HORIZONTAL	197	184	Average
6	2484.37	60.67	74.00	-13.33	29.34	4.07	0.00	27.26	HORIZONTAL	197	184	Peak

Item 3, 4 are the fundamental frequency at 2437 MHz.

Channel 11

	Freq	Level	Limit Line	Over Limit	Read Level	Cable Loss	Preamp Factor	Antenna Factor	Pol/Phase	T/Pos	A/Pos	Remark
	MHz	dBuV/m	dBuV/m	dB	dBuV	dB	dB	dB/m		deg	cm	
1	2459.40	98.85			67.60	4.05	0.00	27.20	HORIZONTAL	0	187	Average
2	2463.59	108.51			77.25	4.05	0.00	27.21	HORIZONTAL	0	187	Peak
3	2483.50	53.39	54.00	-0.61	22.06	4.07	0.00	27.26	HORIZONTAL	0	187	Average
4	2483.50	73.57	74.00	-0.43	42.24	4.07	0.00	27.26	HORIZONTAL	0	187	Peak

Item 1, 2 are the fundamental frequency at 2462 MHz.

Temperature	24°C	Humidity	61%
Test Engineer	Taka Hsu	Configurations	IEEE 802.11n MCS8 HT40 CH 3, 6, 9 / Ant. 0 + Ant. 1
Test Date	Dec. 12, 2014		

Channel 3

	Freq	Level	Limit Line	Over Limit	Read Level	Cable Loss	Preamp Factor	Antenna Factor	Pol/Phase	T/Pos	A/Pos	Remark
	MHz	dBuV/m	dBuV/m	dB	dBuV	dB	dB	dB/m		deg	cm	
1	2385.37	68.21	74.00	-5.79	37.19	3.99	0.00	27.03	HORIZONTAL	170	218	Peak
2	2390.00	53.70	54.00	-0.30	22.67	3.99	0.00	27.04	HORIZONTAL	170	218	Average
3	2430.10	104.34			73.18	4.03	0.00	27.13	HORIZONTAL	170	218	Peak
4	2431.55	92.87			61.70	4.03	0.00	27.14	HORIZONTAL	170	218	Average

Item 3, 4 are the fundamental frequency at 2422 MHz.

Channel 6

	Freq	Level	Limit Line	Over Limit	Read Level	Cable Loss	Preamp Factor	Antenna Factor	Pol/Phase	T/Pos	A/Pos	Remark
	MHz	dBuV/m	dBuV/m	dB	dBuV	dB	dB	dB/m		deg	cm	
1	2390.00	52.02	54.00	-1.98	20.99	3.99	0.00	27.04	HORIZONTAL	170	215	Average
2	2390.00	64.66	74.00	-9.34	33.63	3.99	0.00	27.04	HORIZONTAL	170	215	Peak
3	2427.45	94.94			63.78	4.03	0.00	27.13	HORIZONTAL	170	215	Average
4	2432.66	105.70			74.53	4.03	0.00	27.14	HORIZONTAL	170	215	Peak
5	2483.50	52.93	54.00	-1.07	21.60	4.07	0.00	27.26	HORIZONTAL	170	215	Average
6	2485.53	67.21	74.00	-6.79	35.87	4.07	0.00	27.27	HORIZONTAL	170	215	Peak

Item 3, 4 are the fundamental frequency at 2437 MHz.

Channel 9

	Freq	Level	Limit Line	Over Limit	Read Level	Cable Loss	Preamp Factor	Antenna Factor	Pol/Phase	T/Pos	A/Pos	Remark
	MHz	dBuV/m	dBuV/m	dB	dBuV	dB	dB	dB/m		deg	cm	
1	2442.74	95.10			63.89	4.04	0.00	27.17	HORIZONTAL	198	188	Average
2	2447.66	105.64			74.42	4.04	0.00	27.18	HORIZONTAL	198	188	Peak
3	2483.50	53.32	54.00	-0.68	21.99	4.07	0.00	27.26	HORIZONTAL	198	188	Average
4	2484.08	70.21	74.00	-3.79	38.88	4.07	0.00	27.26	HORIZONTAL	198	188	Peak

Item 1, 2 are the fundamental frequency at 2452 MHz.

Temperature	24°C	Humidity	61%
Test Engineer	Taka Hsu	Configurations	IEEE 802.11b CH 1, 6, 11 / Ant. 0
Test Date	Dec. 12, 2014		

Channel 1

	Freq	Level	Limit	Over	Read	Cable	Preamp	Antenna		T/Pos	A/Pos	Remark
	MHz	dBuV/m	dBuV/m	dB	dBuV	dB	dB	dB/m	Pol/Phase	deg	cm	
1	2376.98	58.65	74.00	-15.35	27.65	3.99	0.00	27.01	HORIZONTAL	170	220	Peak
2	2390.00	44.40	54.00	-9.60	13.37	3.99	0.00	27.04	HORIZONTAL	170	220	Average
3	2412.00	105.20			74.10	4.01	0.00	27.09	HORIZONTAL	170	220	Peak
4	2412.72	102.37			71.27	4.01	0.00	27.09	HORIZONTAL	170	220	Average

Item 3, 4 are the fundamental frequency at 2412 MHz.

Channel 6

	Freq	Level	Limit	Over	Read	Cable	Preamp	Antenna		T/Pos	A/Pos	Remark
	MHz	dBuV/m	dBuV/m	dB	dBuV	dB	dB	dB/m	Pol/Phase	deg	cm	
1	2388.84	57.75	74.00	-16.25	26.72	3.99	0.00	27.04	HORIZONTAL	184	181	Peak
2	2390.00	44.18	54.00	-9.82	13.15	3.99	0.00	27.04	HORIZONTAL	184	181	Average
3	2436.28	103.36			72.18	4.03	0.00	27.15	HORIZONTAL	184	181	Average
4	2436.86	106.24			75.06	4.03	0.00	27.15	HORIZONTAL	184	181	Peak
5	2483.50	44.87	54.00	-9.13	13.54	4.07	0.00	27.26	HORIZONTAL	184	181	Average
6	2483.79	59.46	74.00	-14.54	28.13	4.07	0.00	27.26	HORIZONTAL	184	181	Peak

Item 3, 4 are the fundamental frequency at 2437 MHz.

Channel 11

	Freq	Level	Limit	Over	Read	Cable	Preamp	Antenna		T/Pos	A/Pos	Remark
	MHz	dBuV/m	dBuV/m	dB	dBuV	dB	dB	dB/m	Pol/Phase	deg	cm	
1	2462.00	107.40			76.14	4.05	0.00	27.21	HORIZONTAL	0	186	Peak
2	2462.72	104.60			73.34	4.05	0.00	27.21	HORIZONTAL	0	186	Average
3	2483.50	46.46	54.00	-7.54	15.13	4.07	0.00	27.26	HORIZONTAL	0	186	Average
4	2504.19	60.32	74.00	-13.68	28.92	4.09	0.00	27.31	HORIZONTAL	0	186	Peak

Item 1, 2 are the fundamental frequency at 2462 MHz.

Temperature	24°C	Humidity	61%
Test Engineer	Taka Hsu	Configurations	IEEE 802.11g CH 1, 6, 11 / Ant. 0
Test Date	Dec. 12, 2014		

Channel 1

	Freq	Level	Limit	Over	Read	Cable	Preamp	Antenna		T/Pos	A/Pos	Remark
	MHz	dBuV/m	dBuV/m	dB	dBuV	dB	dB	dB/m		deg	cm	
1	2388.84	67.67	74.00	-6.33	36.64	3.99	0.00	27.04	HORIZONTAL	170	184	Peak
2	2390.00	53.85	54.00	-0.15	22.82	3.99	0.00	27.04	HORIZONTAL	170	184	Average
3	2406.21	97.26			66.18	4.00	0.00	27.08	HORIZONTAL	170	184	Average
4	2406.79	108.27			77.19	4.00	0.00	27.08	HORIZONTAL	170	184	Peak

Item 3, 4 are the fundamental frequency at 2412 MHz.

Channel 6

	Freq	Level	Limit	Over	Read	Cable	Preamp	Antenna		T/Pos	A/Pos	Remark
	MHz	dBuV/m	dBuV/m	dB	dBuV	dB	dB	dB/m		deg	cm	
1	2389.13	58.40	74.00	-15.60	27.37	3.99	0.00	27.04	HORIZONTAL	168	182	Peak
2	2390.00	44.79	54.00	-9.21	13.76	3.99	0.00	27.04	HORIZONTAL	168	182	Average
3	2431.79	108.86			77.69	4.03	0.00	27.14	HORIZONTAL	168	182	Peak
4	2433.53	98.04			66.87	4.03	0.00	27.14	HORIZONTAL	168	182	Average
5	2483.50	45.60	54.00	-8.40	14.27	4.07	0.00	27.26	HORIZONTAL	168	182	Average
6	2484.08	60.96	74.00	-13.04	29.63	4.07	0.00	27.26	HORIZONTAL	168	182	Peak

Item 3, 4 are the fundamental frequency at 2437 MHz.

Channel 11

	Freq	Level	Limit	Over	Read	Cable	Preamp	Antenna		T/Pos	A/Pos	Remark
	MHz	dBuV/m	dBuV/m	dB	dBuV	dB	dB	dB/m		deg	cm	
1	2457.95	108.86			77.61	4.05	0.00	27.20	HORIZONTAL	310	227	Peak
2	2458.82	97.14			65.89	4.05	0.00	27.20	HORIZONTAL	310	227	Average
3	2483.50	52.95	54.00	-1.05	21.62	4.07	0.00	27.26	HORIZONTAL	310	227	Average
4	2484.37	69.39	74.00	-4.61	38.06	4.07	0.00	27.26	HORIZONTAL	310	227	Peak

Item 1, 2 are the fundamental frequency at 2462 MHz.

Note:

Emission level (dBuV/m) = 20 log Emission level (uV/m).

Corrected Reading: Antenna Factor + Cable Loss + Read Level - Preamp Factor = Level.

Plot on Configuration IEEE 802.11n MCS8 HT20 / CH 1 / 2500MHz~26500MHz (down 30dBc)

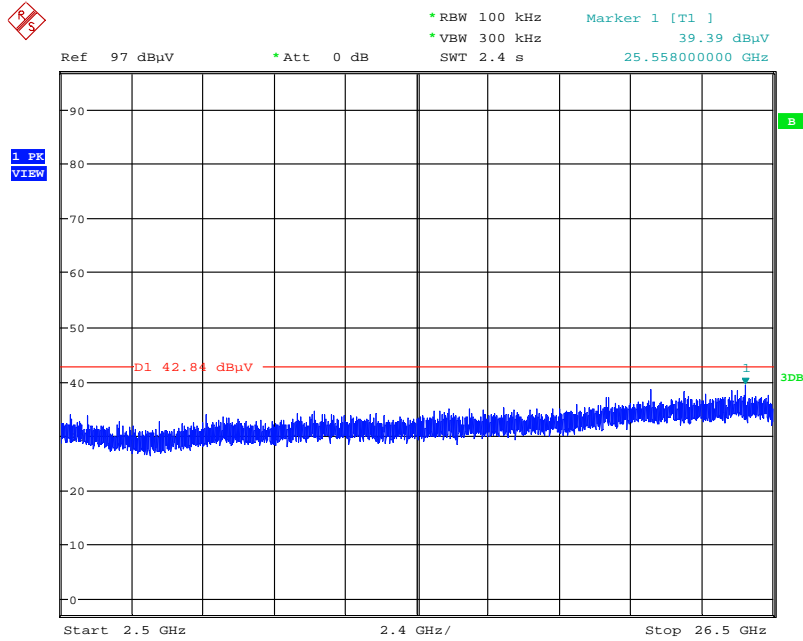

Date: 27.DEC.2014 16:45:55

Plot on Configuration IEEE 802.11n MCS8 HT20 / CH 11 / 30MHz~2400MHz (down 30dBc)

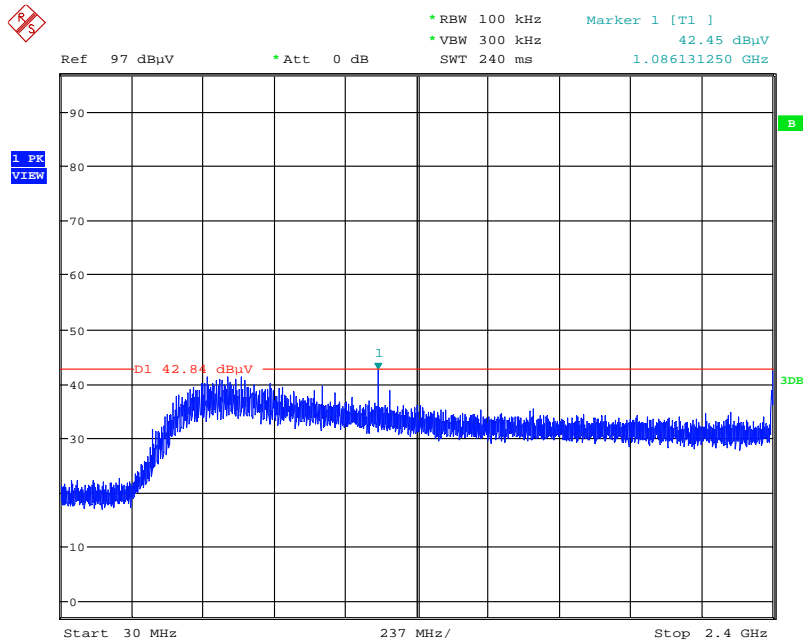

Date: 27.DEC.2014 16:48:55

Plot on Configuration IEEE 802.11n MCS8 HT40 / CH 3 / 2500MHz~26500MHz (down 30dBc)

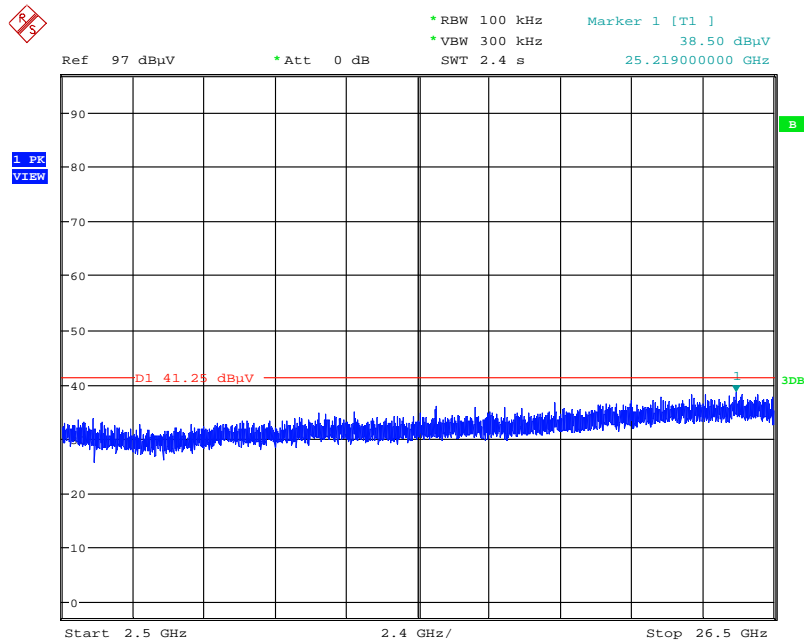

Date: 27.DEC.2014 17:27:12

Plot on Configuration IEEE 802.11n MCS8 HT40 / CH 9 / 30MHz~2400MHz (down 30dBc)

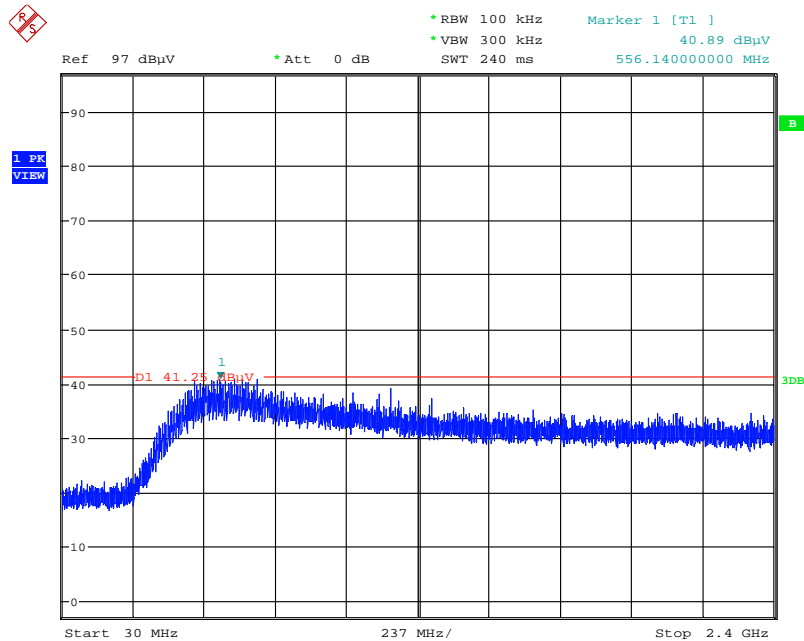

Date: 27.DEC.2014 17:31:28

Plot on Configuration IEEE 802.11n MCS8 HT40 / CH 9 / 2500MHz~26500MHz (down 30dBc)

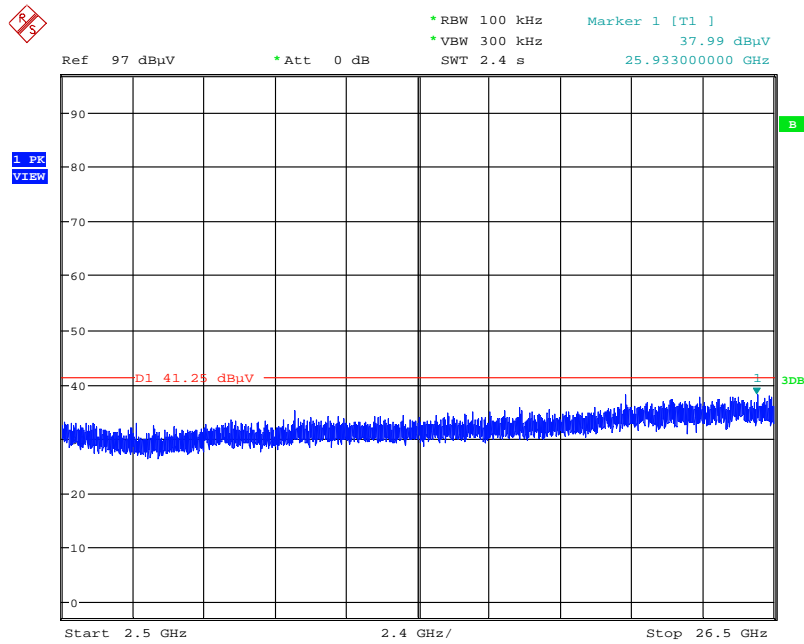

Date: 27.DEC.2014 17:32:28

Plot on Configuration IEEE 802.11b / CH 1 / 2500MHz~2650MHz (down 30dBc)

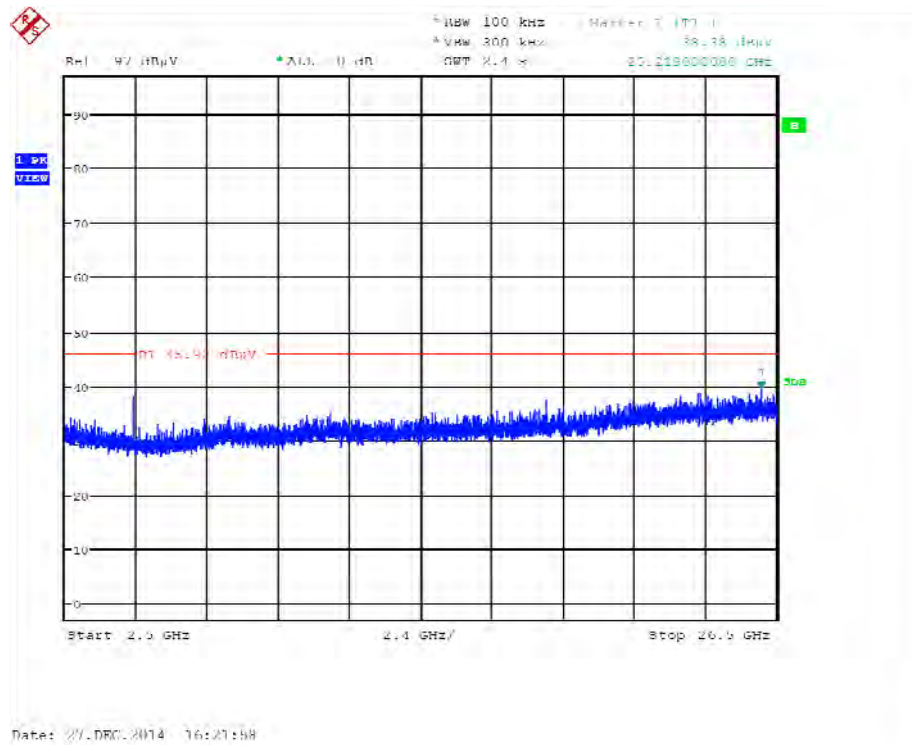

Plot on Configuration IEEE 802.11b / CH 11 / 30MHz~2400MHz (down 30dBc)

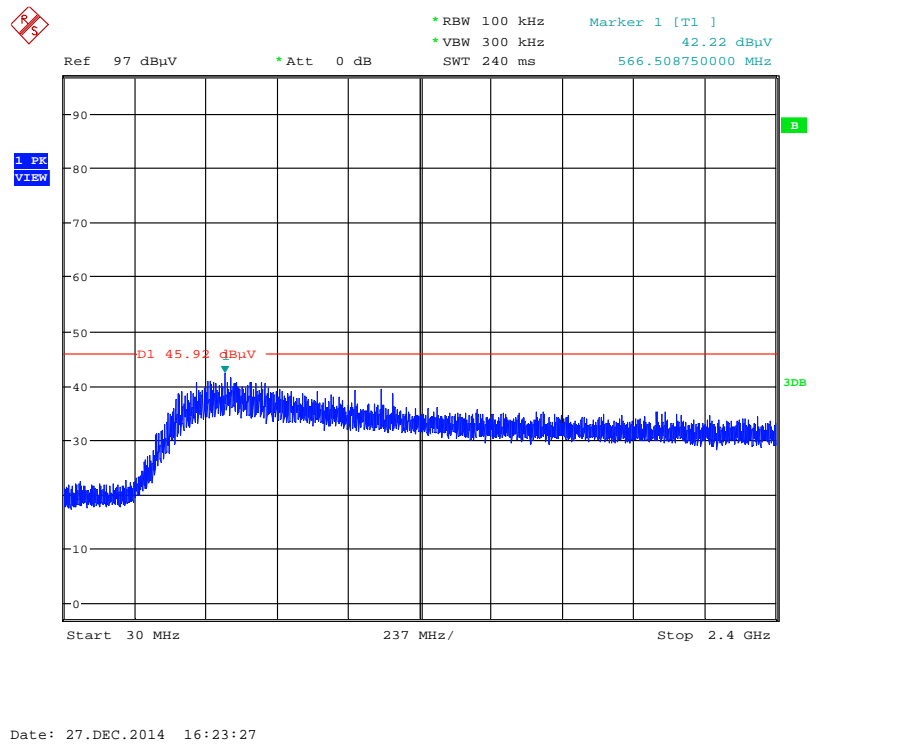

Plot on Configuration IEEE 802.11b / CH 11 / 2500MHz~26500MHz (down 30dBc)

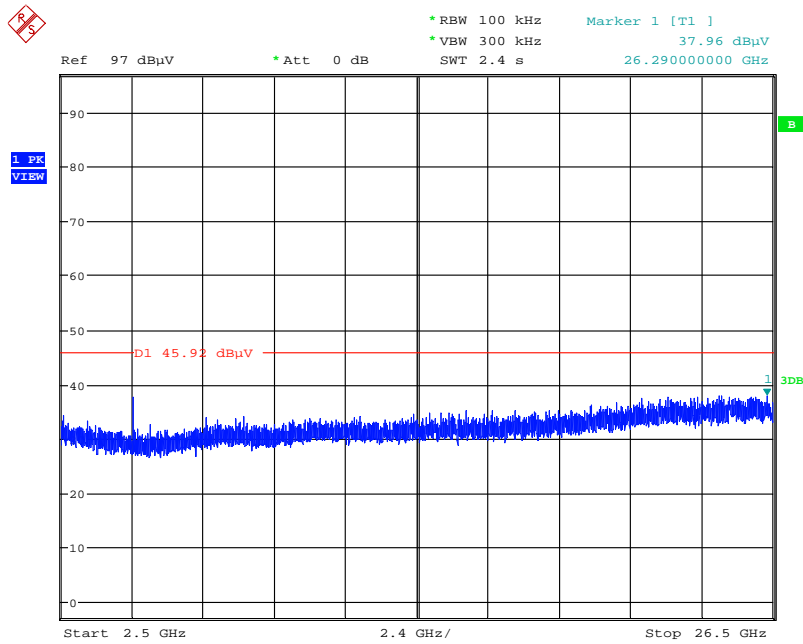

Date: 27.DEC.2014 16:23:55

4.7. Antenna Requirements

4.7.1. Limit

Except for special regulations, the Low-power Radio-frequency Devices must not be equipped with any jacket for installing an antenna with extension cable. An intentional radiator shall be designed to ensure that no antenna other than that furnished by the responsible party shall be used with the device. The use of a permanently attached antenna or of an antenna that uses a unique coupling to the intentional radiator shall be considered sufficient to comply with the provisions of this Section. The manufacturer may design the unit so that the user can replace a broken antenna, but the use of a standard antenna jack or electrical connector is prohibited. Further, this requirement does not apply to intentional radiators that must be professionally installed.

4.7.2. Antenna Connector Construction

Please refer to section 3.3 in this test report; antenna connector complied with the requirements.

5. LIST OF MEASURING EQUIPMENTS

Instrument	Manufacturer	Model No.	Serial No.	Characteristics	Calibration Date	Remark
EMI Test Receiver	R&S	ESCS 30	100355	9kHz ~ 2.75GHz	Apr. 23, 2014	Conduction (CO01-CB)
LISN	Schwarzbeck	NSLK 8127	8127650	9kHz ~ 30MHz	Nov. 17, 2014	Conduction (CO01-CB)
LISN	Schwarzbeck	NSLK 8127	8127478	9kHz ~ 30MHz	Nov. 17, 2014	Conduction (CO01-CB)
COND Cable	Woken	Cable	01	150kHz ~ 30MHz	Dec. 04, 2014	Conduction (CO01-CB)
Software	Audix	E3	5.410e	-	N.C.R.	Conduction (CO01-CB)
Signal analyzer	R&S	FSV40	100979	9kHz~40GHz	Dec.12, 2014	Conducted (TH01-CB)
RF Cable-high	Woken	High Cable-7	-	1 GHz – 26.5 GHz	Nov. 15, 2014	Conducted (TH01-CB)
RF Cable-high	Woken	High Cable-8	-	1 GHz – 26.5 GHz	Nov. 15, 2014	Conducted (TH01-CB)
RF Cable-high	Woken	High Cable-9	-	1 GHz – 26.5 GHz	Nov. 15, 2014	Conducted (TH01-CB)
RF Cable-high	Woken	High Cable-10	-	1 GHz – 26.5 GHz	Nov. 15, 2014	Conducted (TH01-CB)
RF Cable-high	Woken	High Cable-11	-	1 GHz – 26.5 GHz	Nov. 15, 2014	Conducted (TH01-CB)
Power Sensor	Anritsu	MA2411B	1126203	300MHz~40GHz	Oct. 06, 2014	Conducted (TH01-CB)
Power Meter	Anritsu	ML2495A	1210004	300MHz~40GHz	Oct. 06, 2014	Conducted (TH01-CB)
BILOG ANTENNA	Schaffner	CBL6112D	22021	20MHz ~ 2GHz	May 26, 2014	Radiation (O3CH01-CB)
Loop Antenna	Rohde & Schwarz	HFH2-Z2	100315	9 kHz~30 MHz	Jul. 28, 2014	Radiation (O3CH01-CB)
Horn Antenna	EMCO	3115	00075790	750MHz~18GHz	Oct. 28, 2014	Radiation (O3CH01-CB)
Horn Antenna	Schwarzbeck	BBHA 9170	BBHA9170252	15GHz ~ 40GHz	Aug. 22, 2014	Radiation (O3CH01-CB)
Pre-Amplifier	Agilent	8447D	2944A10991	0.1MHz ~ 1.3GHz	Nov. 12, 2013	Radiation (O3CH01-CB)
Pre-Amplifier	Agilent	8447D	2944A10991	0.1MHz ~ 1.3GHz	Nov. 15, 2014	Radiation (O3CH01-CB)
Pre-Amplifier	Agilent	8449B	3008A02310	1GHz ~ 26.5GHz	Dec. 16, 2013	Radiation (O3CH01-CB)
Pre-Amplifier	Agilent	8449B	3008A02009	1GHz ~ 26.5GHz	Dec. 17, 2014	Radiation (O3CH01-CB)
Pre-Amplifier	WM	TF-130N-R1	--	26GHz ~ 40GHz	Feb. 17, 2014	Radiation (O3CH01-CB)
Spectrum Analyzer	R&S	FSP40	100080	9kHz ~ 40GHz	Oct. 15, 2014	Radiation (O3CH01-CB)
EMI Test Receiver	Agilent	N9038A	MY52260123	9kHz ~ 8GHz	Dec. 12, 2013	Radiation (O3CH01-CB)
Turn Table	INN CO	CO 2000	N/A	0 ~ 360 degree	N.C.R.	Radiation (O3CH01-CB)
Antenna Mast	INN CO	CO 2000	N/A	1 m - 4 m	N.C.R.	Radiation (O3CH01-CB)

Instrument	Manufacturer	Model No.	Serial No.	Characteristics	Calibration Date	Remark
RF Cable-low	Woken	Low Cable-1	N/A	30 MHz - 1 GHz	Nov. 17, 2013	Radiation (03CH01-CB)
RF Cable-low	Woken	Low Cable-1	N/A	30 MHz - 1 GHz	Nov. 15, 2014	Radiation (03CH01-CB)
RF Cable-high	Woken	High Cable-1	N/A	1 GHz – 26.5 GHz	Nov. 17, 2013	Radiation (03CH01-CB)
RF Cable-high	Woken	High Cable-1	N/A	1 GHz – 26.5 GHz	Nov. 15, 2014	Radiation (03CH01-CB)
RF Cable-high	Woken	High Cable-2	N/A	1 GHz – 26.5 GHz	Nov. 17, 2013	Radiation (03CH01-CB)
RF Cable-high	Woken	High Cable-2	N/A	1 GHz – 26.5 GHz	Nov. 15, 2014	Radiation (03CH01-CB)
RF Cable-high	Woken	High Cable-3	N/A	1 GHz - 40 GHz	Nov. 17, 2013	Radiation (03CH01-CB)
RF Cable-high	Woken	High Cable-3	N/A	1 GHz - 40 GHz	Nov. 15, 2014	Radiation (03CH01-CB)
RF Cable-high	Woken	High Cable-4	N/A	1 GHz - 40 GHz	Nov. 17, 2013	Radiation (03CH01-CB)
RF Cable-high	Woken	High Cable-4	N/A	1 GHz - 40 GHz	Nov. 15, 2014	Radiation (03CH01-CB)

Note: Calibration Interval of instruments listed above is one year.

N.C.R. means Non-Calibration required.

6. MEASUREMENT UNCERTAINTY

Test Items	Uncertainty	Remark
Conducted Emission (150kHz ~ 30MHz)	2.4 dB	Confidence levels of 95%
Radiated Emission (30MHz ~ 1,000MHz)	3.6 dB	Confidence levels of 95%
Radiated Emission (1GHz ~ 18GHz)	3.7 dB	Confidence levels of 95%
Radiated Emission (18GHz ~ 40GHz)	3.5 dB	Confidence levels of 95%
Conducted Emission	1.7 dB	Confidence levels of 95%