



產品承認書

Specification for Approval

客戶 (Customer): 鎂寶科技股份有限公司

Customer Part No.: 1203000000140

Product Description: ANTENNA PIFA 5GHz PCB_25x26.5x0.6mm
BLUE CABLE LOW-LOSS OD1.13 115mm
(GRAY) WR5842 ALX21P-092AA1-00 LYNWAVE

Lynwave Part No.: ALX21P-092AA1-00

客戶簽核 (Customer Approval)

客戶承認 Customer Approval	核准 (Authorized)	檢驗 (Approved)
	日期： 年 月 日	
內部簽核 (Signature)	日期： 2022 年 05 月 20 日	
Approved by	Checked by	Tested by
<i>YungMing</i>	<i>Lisa Wei</i>	<i>Zero Chen</i>

綠億科技股份有限公司

Lynwave Technology Ltd.

Taiwan: 新北市樹林區學成路 655 號 5 樓
5F., No.655, Xuecheng Rd., Shulin Dist., New Taipei City 238701,
Taiwan Tel: 02-35018700 Fax: 02-35019833
E-mail: service@lynwave.com

Contents

Item	Description	Page
1.	Cover	1
2.	Contents	2
3.	Specification	3
4.	Drawing	4
5.	Test report	5~41
6.	Other	42~59

ALX21P-092AA1-00

Features

- Single band IEEE 802.11 a/n/ac/ax standard
- 5GHz indoor embedded Omni-directional antenna
- High efficiency and quick integration with MHF compatible connector mounting
- Available in customized cable lengths and connectors

Applications

- AP
- Router

Electrical Specification

Category	Specification
Frequency (MHz)	5150 - 5850
Peak Gain (dBi)	4.7
VSWR	2.0 : 1
Polarization	Linear
Power (Watts)	1
Impedance (Ohms)	50
Type	PIFA

Mechanical Specification

Category	Specification
Dimension (mm)	26.5 x 25
Thickness (mm)	0.6
Weight (g)	1.13
Connector	MHF compatible
Cable	Low Loss RF-1.13
Cable Length (mm)	115
Material	PCB (FR4)
Operating Temp (°C)	-40°C ~ +85°C
Storage Temp (°C)	23 ± 5°C
Storage Humidity (%)	30% ~ 70%

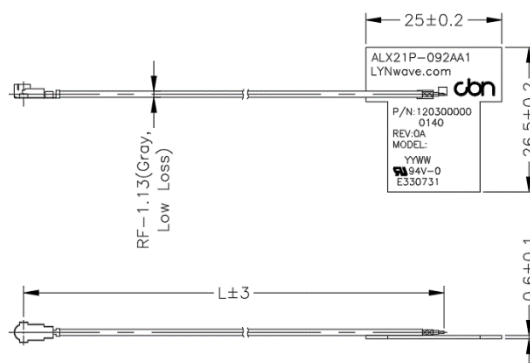

LYNwave Technology Ltd.
5F., No. 655, Xuecheng Rd., Shulin Dist.,
New Taipei City,
238701, Taiwan

Website: www.lynwave.com
Tel: +886 2 3501 8700
Email: service@lynwave.com



F

E

D

C

B

A

Rev	Zone	Description	ENG	Approved	Date
A1		修改線長, 由130mm改為115mm			2021/12/15
A2		修改PCB印刷			2022/01/05

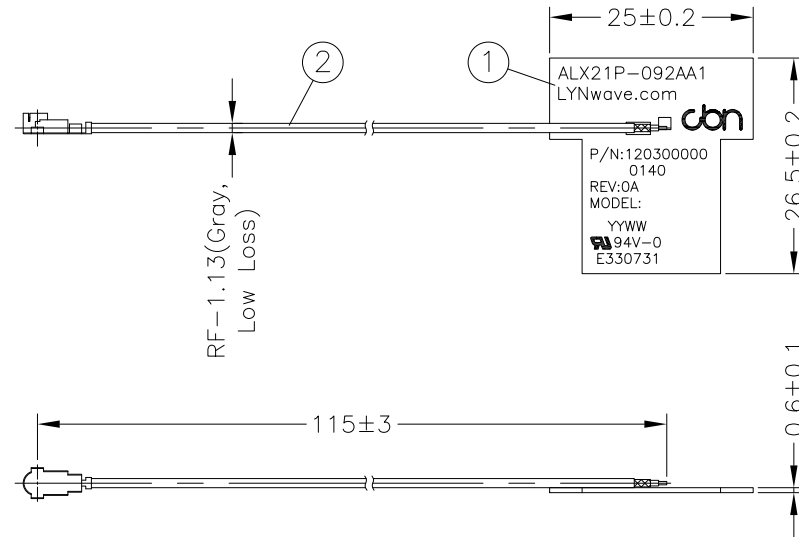

備註:

1.MHF compatible有方向性,請依照圖面方向生產.

		TOLERANCE		CUSTOMER		PART NO.		DESCRIPTION:		DWG NO.		REV.	
		XXX.	±1.0	----		----		Antenna		ALX21P-092AA1-00		A2	
		XX.	±0.5	PROJECTION		UNIT		SCALE		SIZE		SHEET	
2		Cable	DIA 1.13mm, SINGLE COAXIAL LOW LOSS CABLE, COLOR: GRAY	1		X.		±0.3		⊕		mm	
1		PCB	FR4, L26.5 x W25 x T0.6mm, COLOR: BLUE	1		.X		±0.1		APPROVED:		DESIGNED:	
No.		Description	Specification	Qty		.XX		±0.05		Alex Lee		Daniel	
										DRAWN:		Anna	

LYNwave
www.lynwave.com

F

E

D

C

B

A



WR-5842 ANTENNA MEASUREMENT REPORT (LYN)

Version: V 2.3

Released Date: 2022/05/13

Prepared By : Zino

Reviewed By: Daniel

Contents



- Revised History
- Specification
- Antenna Placement & Solution
- Test Setup for S-parameter Measurement
- Return Loss Results
- Isolation Results
- Test Setup for Radiation Pattern Measurement
- 2D Radiation Pattern Results
- System Radiation Pattern Coverage
- Results Summary (return loss, isolation, peak gain, efficiency)

Revision History



Released Date	Version	Record
2021/07/07	1.0	Antenna 1~4 Tuning
2021/11/12	2.0	Antenna 1~4 Tuning
2021/12/09	2.1	Update Antenna Placement
2021/12/28	2.2	Update PCB holder · Cable routing
2022/05/10	2.3	Update Ant.1.4 Traces

Antenna Placement & Solution

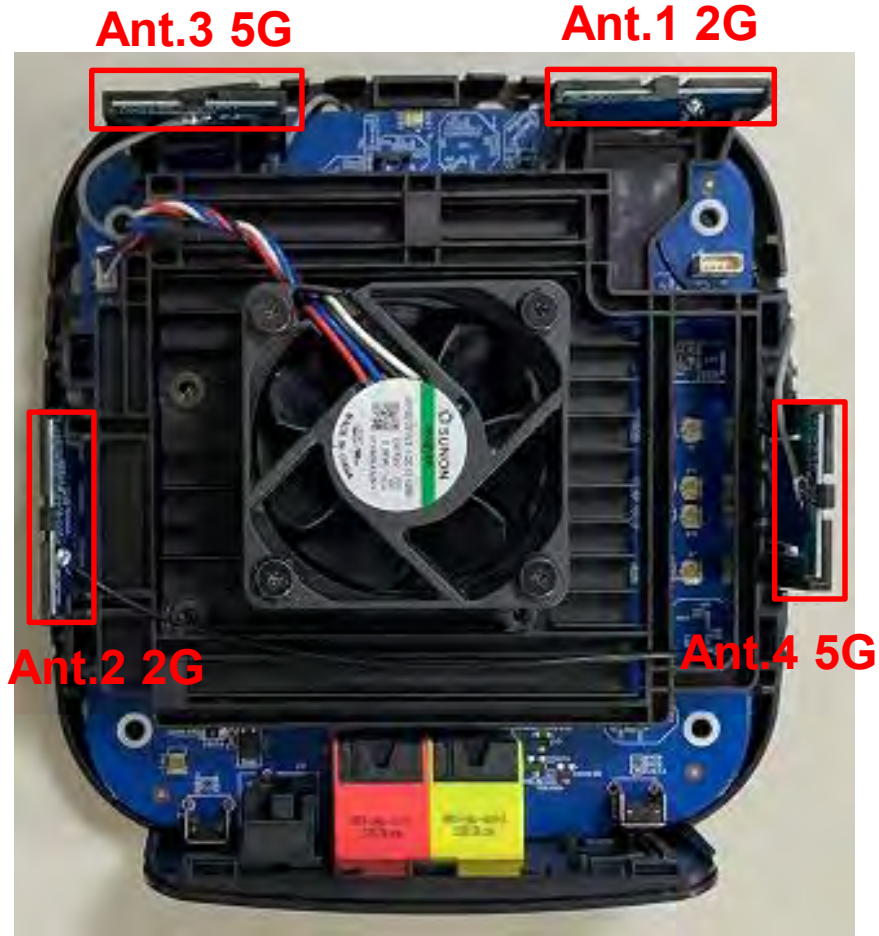

	(MHz)
ANT.1	(2400-2500)
ANT.2	
ANT.3	(5150-5850)
ANT.4	

Antenna Placement & Solution



Antenna	ANT Type	L * W * H Size (mm)	Cable Length (mm)	Cable Type
ANT.1	PCB	30 x 27 x 0.6mm	65	$\Phi=1.13$
ANT.2			140	$\Phi=1.13$
ANT.3		25 x 26.5 x 0.6mm	115	$\Phi=1.13$
ANT.4			65	$\Phi=1.13$

TEST SETUP FOR S-PARAMETER MEASUREMENT



Equipment	Brand	Model	S/N
Network analyzer	Keysight	M9010A	TW57140266

S-PARAMETER RESULTS

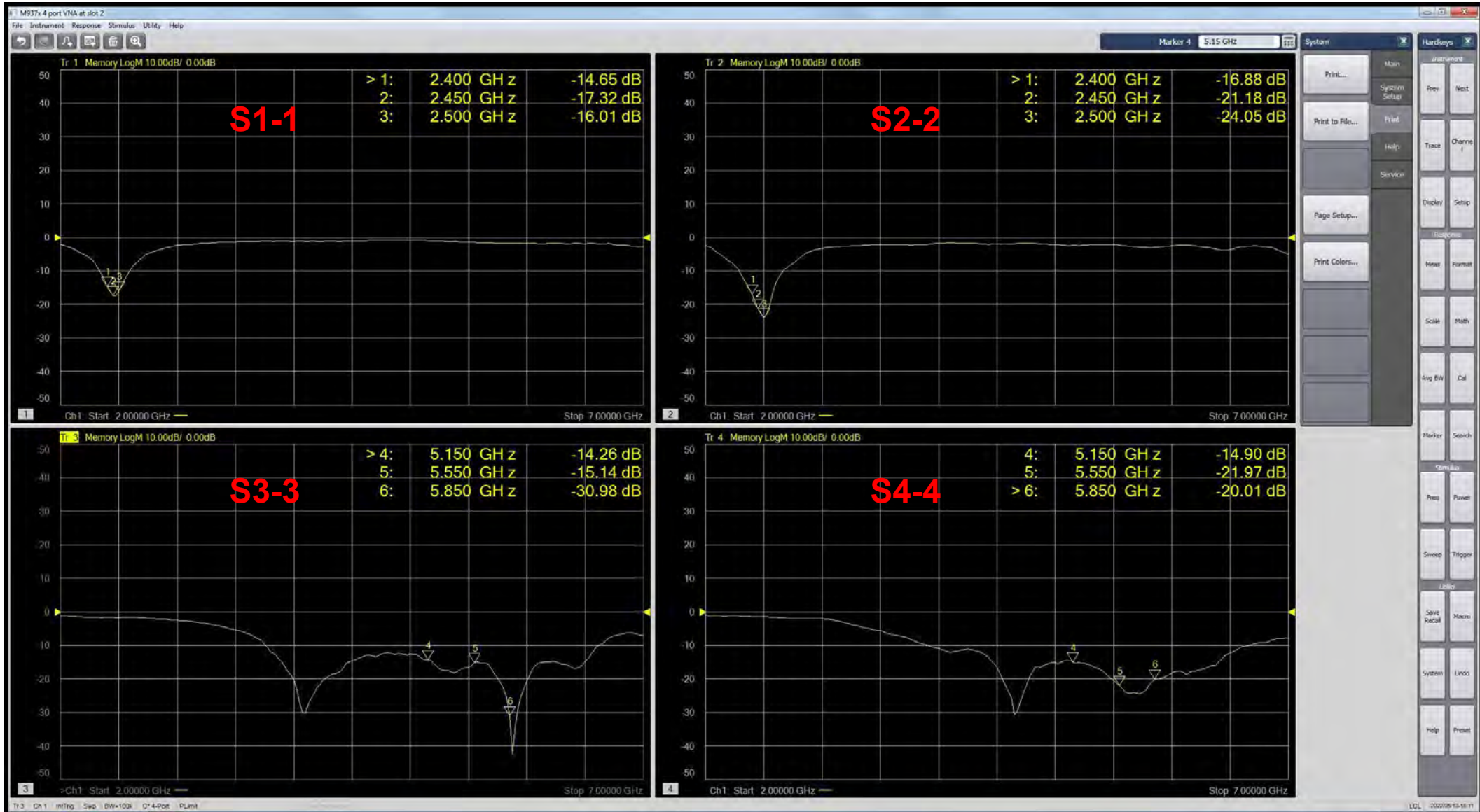

LCL 20201015 15:16:11

S-PARAMETER RESULTS

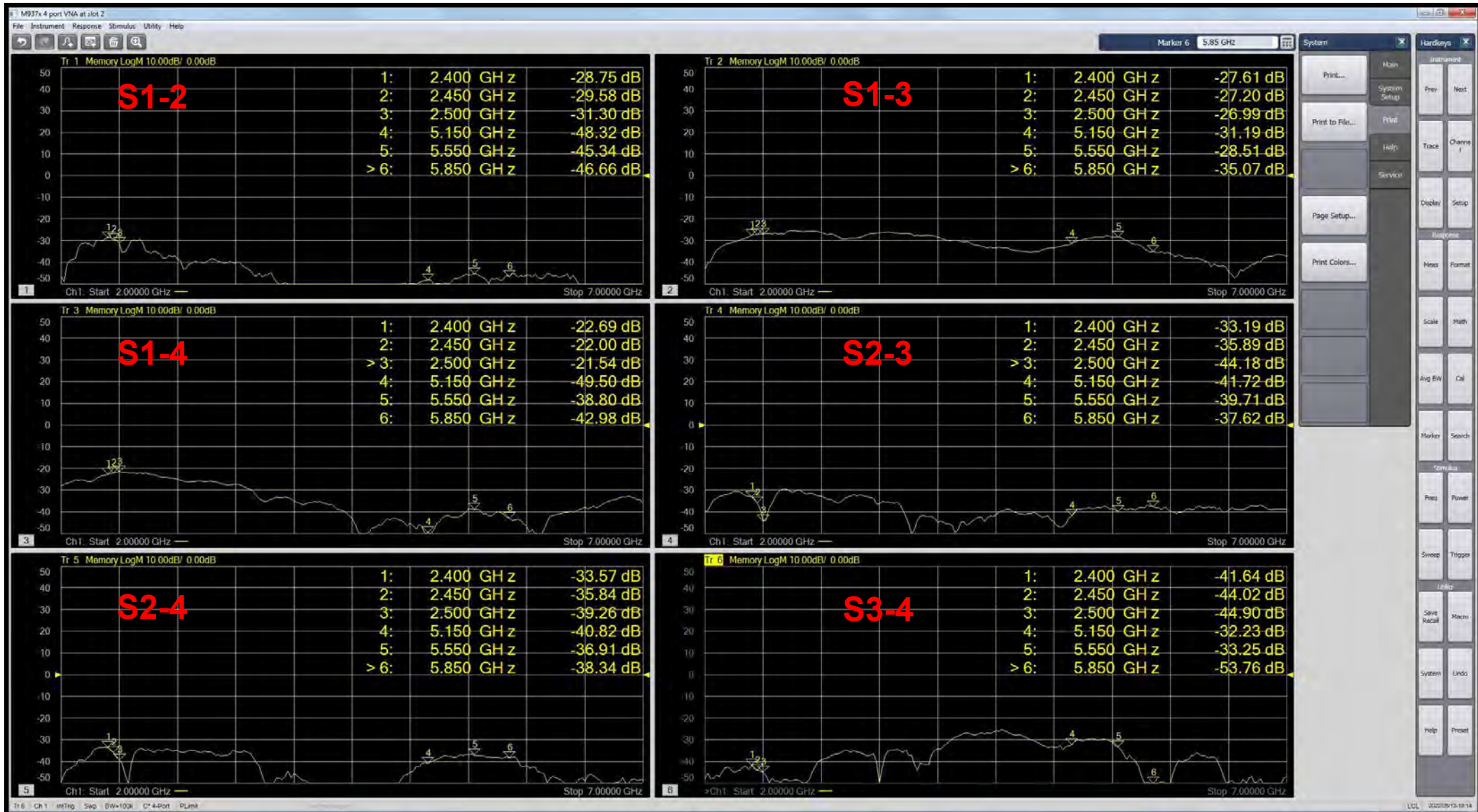

CHAMBER INFORMATION

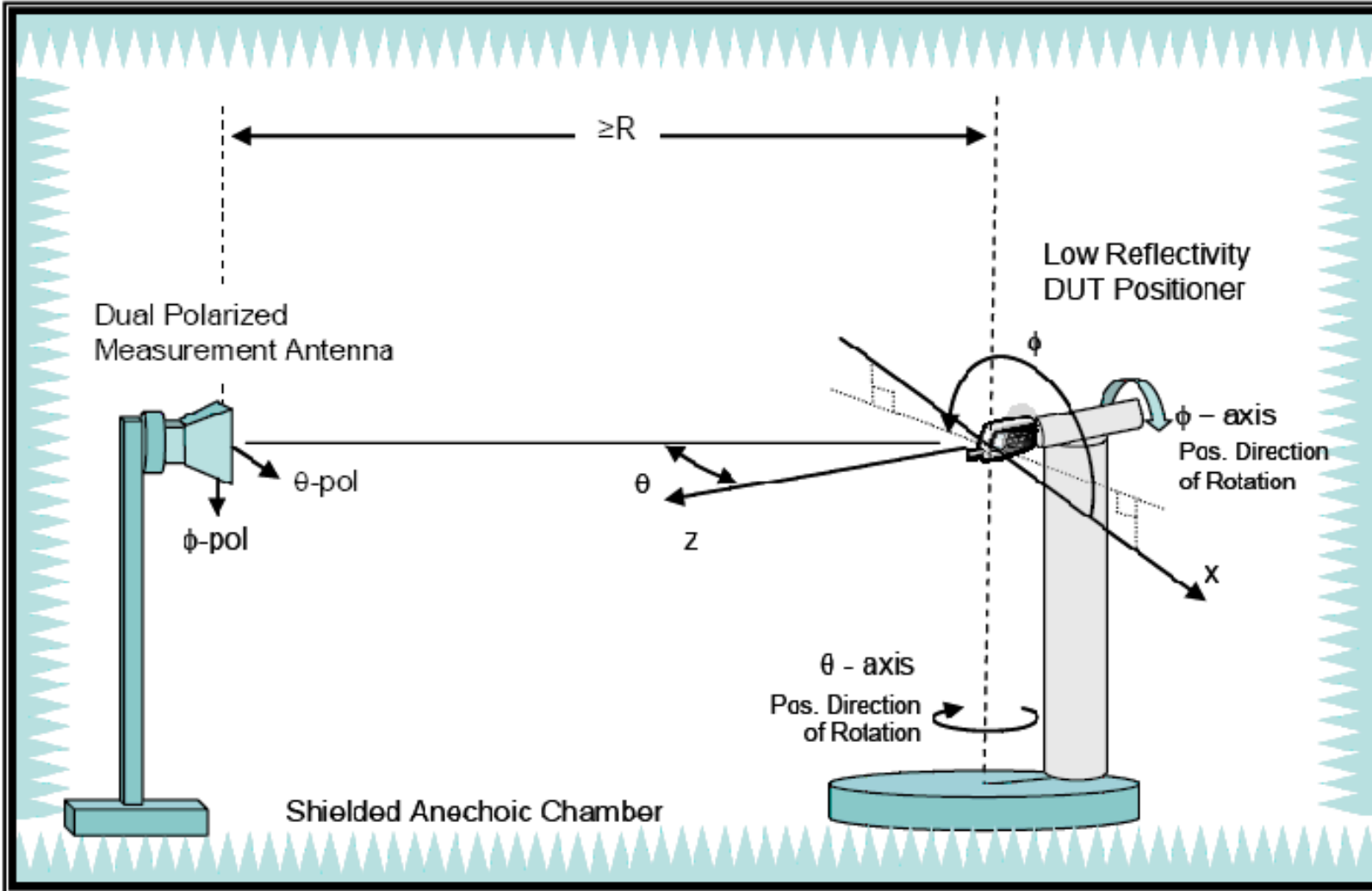

Chamber	Brand	Model	Location
ETS	ETS	Shielded Anechoic Chamber	Taiwan New Taipei City

	θ	ϕ
Total angle	180°	360°
How many angle scan one point	15°	15°
Total scan point	13	24

TEST SETUP FOR RADIATION PATTERN MEASUREMENT



2D Radiation Pattern Results



Frequency(MHz)	Anr.1/2400~2500		
Plane	XY	XZ	YZ
Radiation Pattern			
Setup			

2D Radiation Pattern Results



Frequency(MHz)	Anr.2/2400~2500		
Plane	XY	XZ	YZ
Radiation Pattern			
Setup			

2D Radiation Pattern Results



Frequency(MHz)	Anr.3/5150~5850		
Plane	XY	XZ	YZ
Radiation Pattern			
Setup			

2D Radiation Pattern Results



Frequency(MHz)	Anr.4/5150~5850		
Plane	XY	XZ	YZ
Radiation Pattern			
Setup			

2D Radiation Combine Pattern Ant. 1+2



Frequency(MHz)	2450		
Plane	XY	XZ	YZ
Radiation Pattern			
Setup			

2D Radiation Combine Pattern Ant.3+4



Frequency(MHz)	5550		
Plane	XY	XZ	YZ
Radiation Pattern			
Setup			

System Radiation Pattern Coverage



AGGREGATED ANTENNA PATTERN FOR ANT.1~2(2450MHZ)

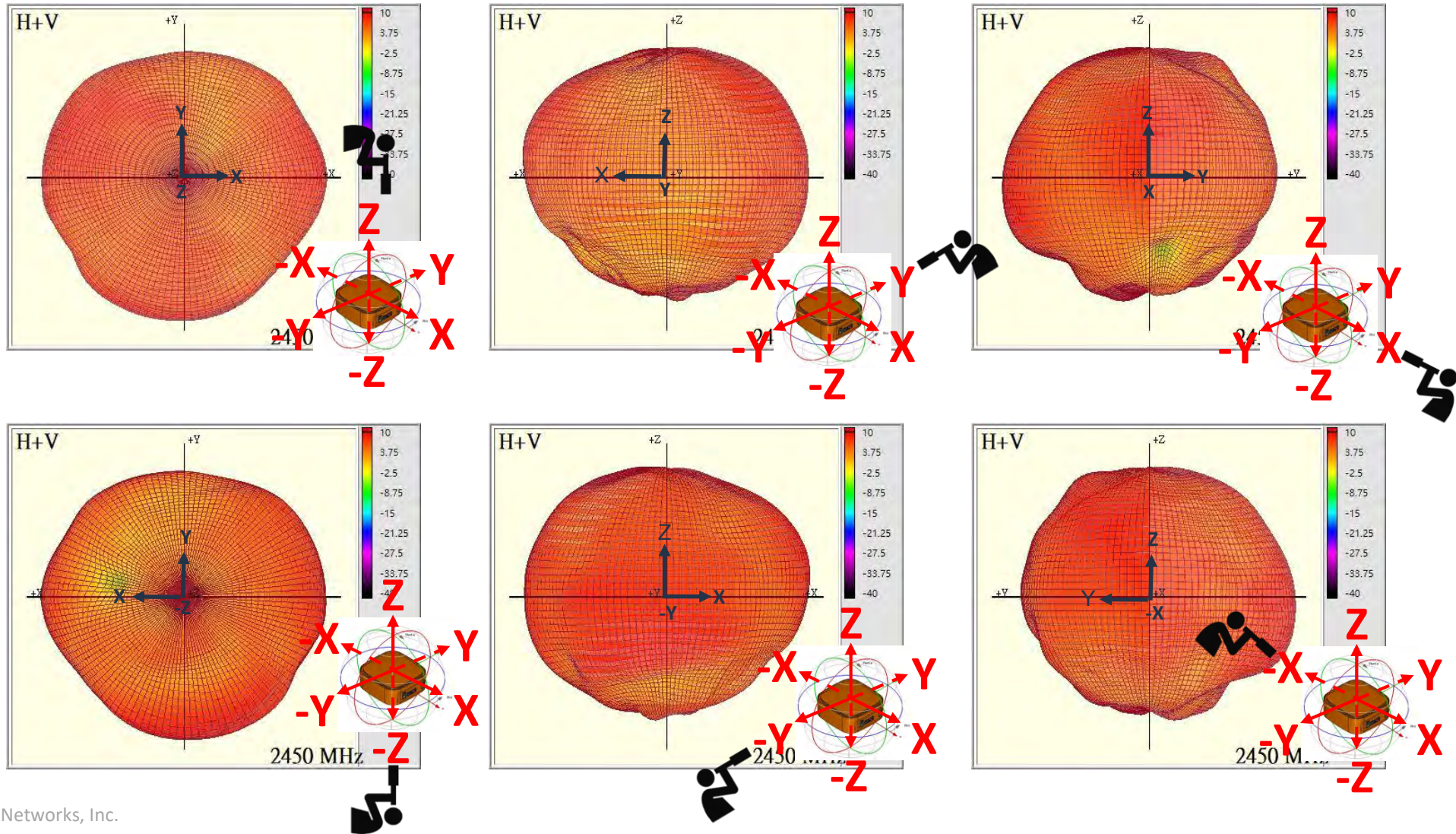

System Radiation Pattern Coverage



AGGREGATED ANTENNA PATTERN FOR ANT.3~4(5850MHZ)

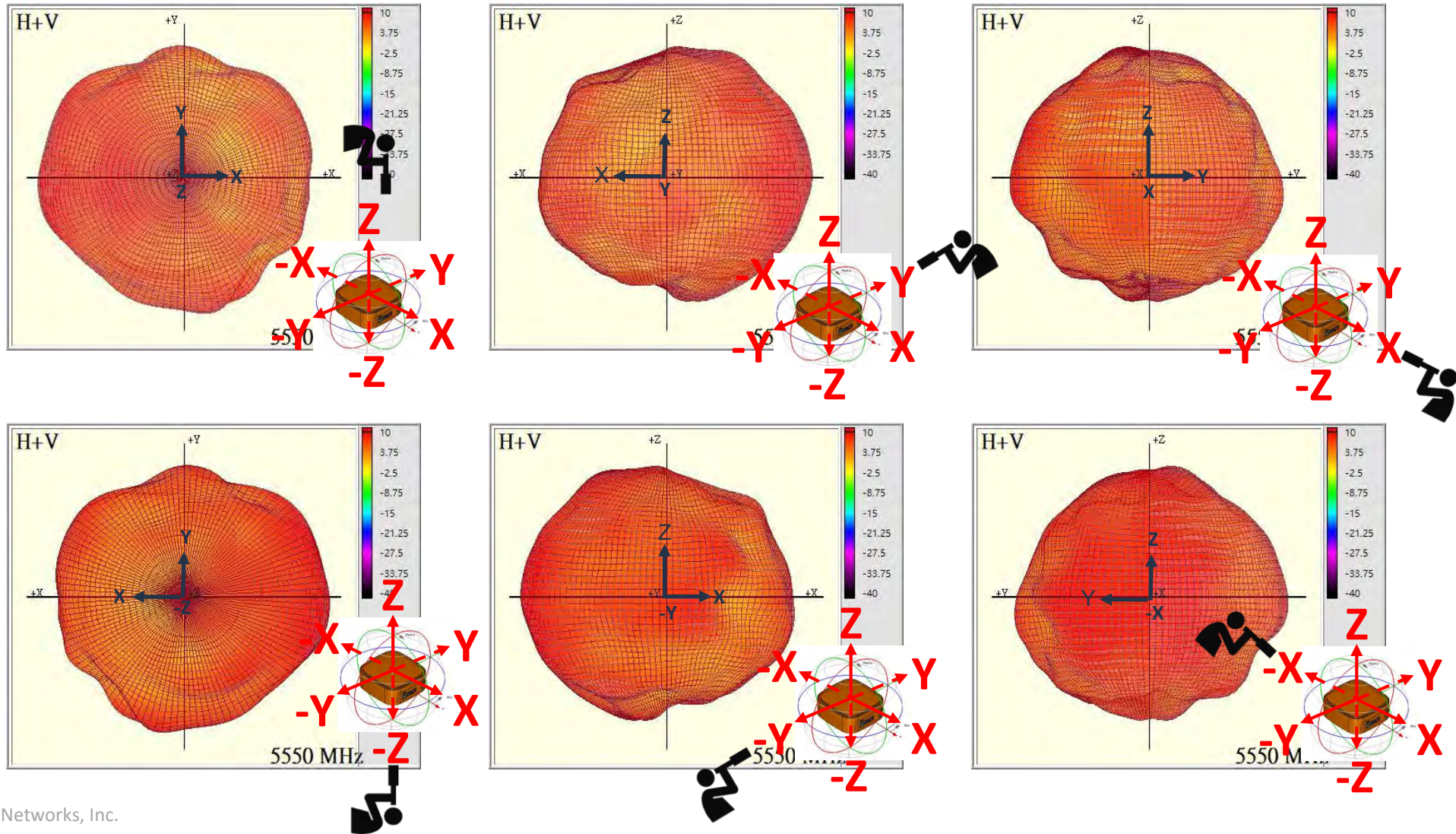

Results Summary



Return Loss

Frequency (MHz)	ANT.1	ANT.2	ANT.3	ANT.4
2400MHz	-14.65	-16.88		
2450MHz	-17.32	-21.18		
2500MHz	-16.01	-24.05		
5150MHz			-14.26	-14.90
5550MHz			-15.14	-21.97
5850MHz			-30.98	-20.01

Results Summary



Isolation

Frequency (MHz)	ANT.2	ANT.3	ANT.4
ANT.1	-28.7	-26.9	-21.5
ANT.2	-	-33.1	-33.5
ANT.3	-	-	-29.0
ANT.4	-	-	-

Results Summary



Peak gain & Efficiency – ANT.1 (Peak Gain<3.1dBi,Efficiency >60%)

Frequency (MHz)	Peak Gain (dBi)	Efficiency (%)
2400	2.4	63
2450	3.1	67
2500	2.7	66

Results Summary



Peak gain & Efficiency – ANT.2 (Peak Gain<3.3dBi,Efficiency >60%)

Frequency (MHz)	Peak Gain (dBi)	Efficiency (%)
2400	3.0	63
2450	3.3	64
2500	3.3	65

Results Summary



Peak gain & Efficiency – ANT.3 (Peak Gain<4.7dBi,Efficiency >60%)

Frequency (MHz)	Peak Gain (dBi)	Efficiency (%)
5150	3.5	65
5550	4.7	66
5850	3.9	69

Results Summary



Peak gain & Efficiency – ANT.4 (Peak Gain<4.8dBi,Efficiency >60%)

Frequency (MHz)	Peak Gain (dBi)	Efficiency (%)
5150	3.7	65
5550	4.3	68
5850	4.8	67

Summary & Comments



- **Antenna Characteristics:**
 - Return loss $< -13\text{dB}$ in operating band
 - Isolation
 - Ant.1~2 $< -20\text{dB}$ in operating band
 - Ant.3~4 $< -25\text{dB}$ in operating band

The antenna have good performance in this condition.



THANK YOU

LYNWAVE TECHNOLOGY LIMITED

日期：2022/5/13

出貨檢驗記錄

版次:A2

客戶名稱	CBN	客戶料號							
		客戶訂單編號PO_D							
成品料號	ALX21P-092AA1-00	數量	抽樣數量						
		抽樣水準	允收水準						
		MIL-STD-105E 一般水準 / II級	AQL 0.65						
項目	檢驗項目	檢驗內容	檢測工具	抽樣檢驗結果					
				OK	NG				
1	外觀檢驗	綠億外觀檢驗規範	目視	OK					
2	尺寸量測	重要尺寸量測	卡尺,鋼尺,投影	OK					
3	電氣檢驗	1.Frequency Range 2.VSWR	網路分析儀	OK					
判定結果: <input checked="" type="checkbox"/> Accept <input type="checkbox"/> Reject <input type="checkbox"/> EDC									
成品尺寸量測圖									
備註: 1.MHF compatible有方向性,請依照圖面方向生產.									
項目	規格值	儀器	取樣實測值					判定	備註
			1	2	3	4	5		
1	25±0.2	游標卡尺	25.03	25.00	25.01	25.02	25.00	OK	
2	26.5±0.2	游標卡尺	26.53	26.43	26.49	26.52	26.53	OK	
3	0.6±0.1	游標卡尺	0.6	0.6	0.6	0.6	0.6	OK	
4	115±3	鋼尺	115.00	115.00	115.00	115.00	115.00	OK	
5	RF-1.13(灰色,Low Loss)	卡尺/目視	1.13/灰色	1.13/灰色	1.13/灰色	1.13/灰色	1.13/灰色	OK	
6	PCB表面處理:單面藍漆	目視	藍色	藍色	藍色	藍色	藍色	OK	
7	PCB表面文字:白字	目視	白字	白字	白字	白字	白字	OK	
8	科信成端子	目視	OK	OK	OK	OK	OK	OK	
9	Connector方向如圖面	目視	OK	OK	OK	OK	OK	OK	
10	外觀:依外觀檢驗標準	目視/投影	OK	OK	OK	OK	OK	OK	
11	電氣: VSWR(小於 2.0 /Ref,Marker 5.15~5.825 GHz)	網路分析儀	1.74	1.65	1.78	1.69	1.66	OK	

Auditor : 王金明

Check : 陈志梅

Remark:

出貨前務必先提供檢報

LYNWAVE TECHNOLOGY LIMITED				
COMPONENT (Cpk) DATA SHEET				
PART NO.:	ALX21P-092AA1-00	PREPARED BY:	Zino	
Date:	2022/5/17	CHECKED BY:		
Returnloss				
Item	5.55GHz			
1	-15.1			
2	-13.4			
3	-13.3			
4	-14.3			
5	-14.6			
6	-14.9			
7	-13.0			
8	-14.3			
9	-14.9			
10	-14.0			
11	-14.8			
12	-14.3			
13	-14.3			
14	-13.9			
15	-14.1			
16	-13.7			
17	-13.8			
18	-13.5			
19	-15.0			
20	-14.6			
21	-13.8			
22	-13.8			
23	-14.4			
24	-14.5			
25	-14.9			
26	-14.7			
27	-14.0			
28	-13.4			
29	-13.9			
30	-14.8			
Min.	-15.1			
Max.	-13.0			

LYNWAVE TECHNOLOGY LIMITED				
COMPONENT (Cpk) DATA SHEET				
PART NO.:	ALX21P-092AA1-00	PREPARED BY:	Zino	
Date:	2022/5/17	CHECKED BY:		
Efficiency				
Item	5.55GHz			
1	64			
2	66			
3	61			
4	61			
5	65			
6	63			
7	65			
8	63			
9	64			
10	64			
11	64			
12	61			
13	62			
14	65			
15	63			
16	62			
17	66			
18	64			
19	63			
20	65			
21	64			
22	62			
23	66			
24	63			
25	65			
26	64			
27	64			
28	61			
29	61			
30	65			
Min.	61			
Max.	66			

LYNWAVE TECHNOLOGY LIMITED				
COMPONENT (Cpk) DATA SHEET				
PART NO.:	ALX21P-092AA1-00	PREPARED BY:	Zino	
Date:	2022/5/17	CHECKED BY:		
Gain				
Item	5.55GHz			
1	4.5			
2	4.4			
3	4.7			
4	4.3			
5	4.4			
6	4.4			
7	4.6			
8	4.6			
9	4.3			
10	4.5			
11	4.3			
12	4.6			
13	4.3			
14	4.3			
15	4.3			
16	4.3			
17	4.3			
18	4.5			
19	4.3			
20	4.5			
21	4.5			
22	4.3			
23	4.6			
24	4.4			
25	4.4			
26	4.4			
27	4.5			
28	4.2			
29	4.2			
30	4.5			
Min.	4.2			
Max.	4.7			

綠億科技股份有限公司
LYNwave Technology , Ltd.

Reliability Test Report

Model : Antenna

Customer Part No: 1203000000140

Lynwave Part No: ALX21P-092AA1-00

Frequency : 5150 - 5850 MHz

VSWR : 2.0 : 1

Peak Gain : 4.7 dBi

Test Results: PASS NG

Approved By : Yungming Hsu
2022/05/18

Prepared By: Zero Chen
2022/05/18

1. Test Item : High Temperature test

1.1 Test equipment :

JD-8001-80L Temperature-Humidity chamber

1.2 Test ambience :

Temperature : $80\pm 5^{\circ}\text{C}$
 Test Duration : 72hrs



1.3 EUT's Model & Quantity :

Model : Antenna

Quantity : 3 sets

1.4 Test conditions : Non Operation

1.5 Test method : Refer IEC-68-2-2

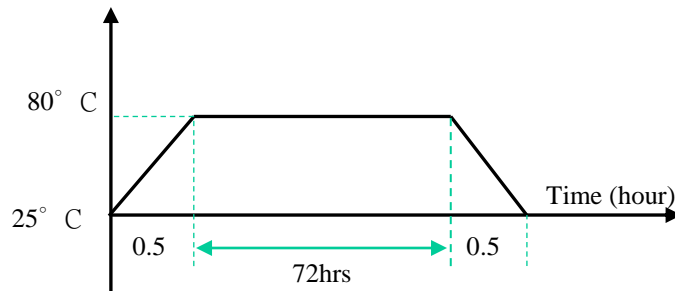

1.6 Test results :

Ant	3	
test frequency range(U) (GHZ)	5.15~5.85	
Spec.	VSWR < 2.0	
sample	test before	test after
1	1.68	1.70
2	1.69	1.67
3	1.62	1.68
Judg.	OK	OK

(1).Visual inspection as normal.

(2).Function test as normal during the test.

2. Test Item : Cold test

2.1 Test equipment :

JD-8001-80L Temperature-Humidity chamber

2.2 Test ambience :

Temperature : $-40 \pm 5^{\circ}\text{C}$
 Test Duration : 72hrs

2.3 EUT's Model & Quantity :

Model : Antenna

Quantity : 3 sets

2.4 Test conditions : Non Operation

Test method : Refer IEC-68-2-1

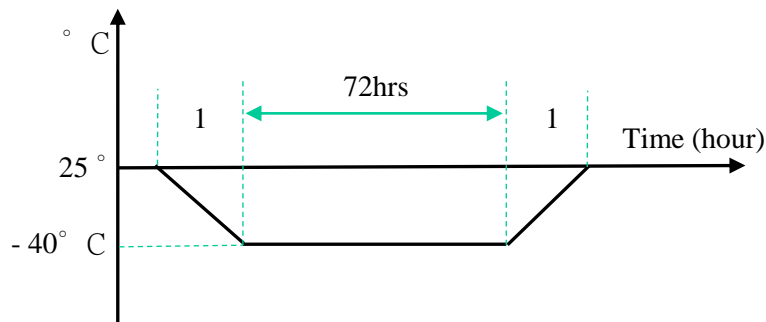

2.5 Test results :

Ant	3	
test frequency range(U) (GHZ)	5.15~5.85	
Spec.	VSWR < 2.0	
sample	test before	test after
1	1.68	1.70
2	1.69	1.69
3	1.62	1.68
Judg.	OK	OK

(1). Visual inspection as normal.

(2). Function test as normal during the test.

3. Test Item : High Temperature High Humidity test

3.1 Test equipment :

JD-8001-80L Temperature-Humidity chamber

3.2 Test ambience :

Temperature : $80 \pm 5^{\circ}\text{C}$
 Humidity(RH) : $90 \pm 15\%$
 Test Duration : 72hrs



3.3 EUT's Model & Quantity :

Model : Antenna

Quantity : 3 sets

3.4 Test conditions : Non Operation

3.5 Test method : Refer IEC-68-2-2

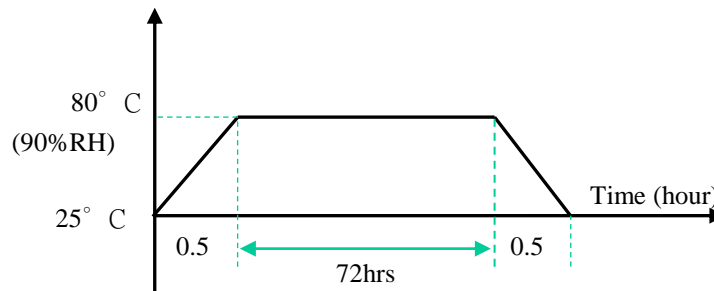

3.6 Test results :

Ant	3	
test frequency range(U) (GHZ)	5.15~5.85	
Spec.	VSWR < 2.0	
sample	test before	test after
1	1.68	1.69
2	1.69	1.68
3	1.62	1.68
Judg.	OK	OK

(1).Visual inspection as normal.

(2).Function test as normal during the test.

4. Test Item : Composite temperature / humidity cycling test

4.1 Test equipment :

JD-8001-80L Temperature-Humidity chamber

4.2 Test ambience :

Temperature : -40~85°C ±2°C
 Test Duration : 48hrs



4.3 Model : 48 Cycle

Quantity : 3 sets

4.4 Test conditions : Non Operation

Test method : Refer IEC 68-2-30

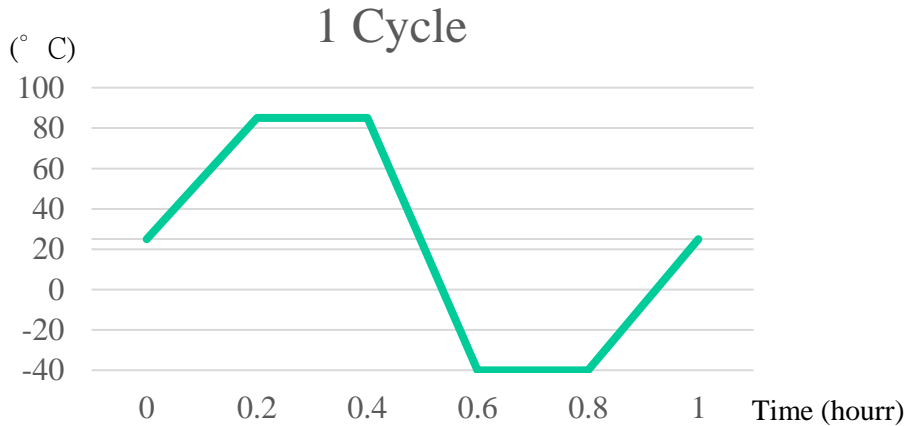

4.5 Test results :

Ant	3	
test frequency range(U) (GHZ)	5.15~5.85	
Spec.	VSWR < 2.0	
sample	test before	test after
1	1.68	1.68
2	1.69	1.69
3	1.62	1.70
Judg.	OK	OK

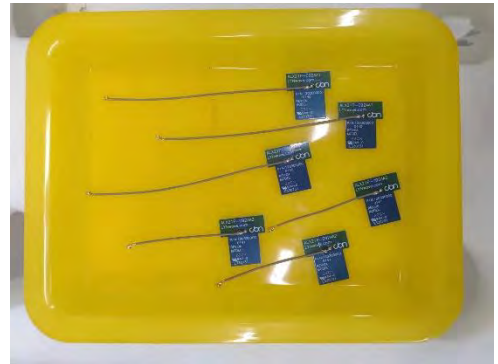

(1).Visual inspection as normal.

(2).Function test as normal during the test.

綠億科技股份有限公司
LYNwave Technology , Ltd.

MTBF Test Report

Model : PCB Antenna

Customer Part No:

1203000000136 / 1203000000138 /
1203000000140 / 1203000000141

Lynwave Part No:

ALX21P-052AA2-00 / ALX21P-052AA3-00 /
ALX21P-092AA1-00 / ALX21P-092AA2-00

Frequency : 2400 - 2500 MHz / 5150 - 5850 MHz

VSWR : 2.0 : 1

MTBF(L) : 3.2 Year

Approved By : Yungming Hsu
2022/5/18

Prepared By: Zero Chen
2022/5/18

Environment Test Index:

Test Group		A	Visual	Function	Judgement
Test Sample No.		1~10			
VSWR	1st(24 hrs)	○	OK	OK	PASS
	2nd(24hrs after 1st)	○	OK	OK	PASS
	3rd(24hrs after 2nd)	○	OK	OK	PASS
	4th(24hrs after 3rd)	○	OK	OK	PASS
	5th(24hrs after 4th)	○	OK	OK	PASS
	6th(2 days after 5th)	○	OK	OK	PASS
	7th(2 days after 6th)	○	OK	OK	PASS
	8th(final test)	○	OK	OK	PASS
Conclusion					PASS
MTBF (L)					28042 Hrs
					3.2 Years

Test Item : MTBF test

a. Test equipment :

MHU-800LRU Temperature-Humidity chamber

b. Test ambience :

Temperature : 65°C
Humidity(RH) : uncontrolled

c. Model : Antenna

Sample Q'ty: 35 EA
Start Test time : 2022/5/9
End Test time : 2022/5/18

d. Test conditions : Non Operation

Test method : Time-terminated Test

e. VSWR testing:

1st : 24 hrs
2nd : 48 hrs (24 hrs after 1st)
3rd : 72 hrs (24 hrs after 2nd)
4th : 96 hrs (24 hrs after 3rd)
From 5th : every 2days after latest VSWR test

f. Test results :

Defects time : N/A
Defects Q'ty : N/A
Total Test Times : 8400 hrs

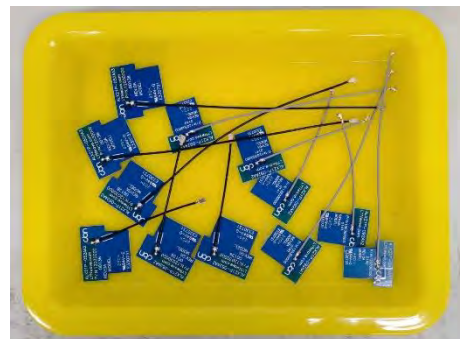

MTBF Estimation :

$$\begin{aligned}
 AF &= \exp \left\{ \frac{EA}{K} \left(\frac{1}{T_a} - \frac{1}{T_u} \right) \right\} \\
 &= \exp \left\{ \frac{0.5}{0.00008623} \left(\frac{1}{298} - \frac{1}{338} \right) \right\} \\
 &= 10 \quad (T_a = 25 \text{ } ^\circ\text{C}, T_u = 65 \text{ } ^\circ\text{C})
 \end{aligned}$$

$$\begin{aligned}
 T &= AF * \left\{ \sum_i^r t_i + (n - \gamma) * t \right\} \\
 &= 10 * \{0 + (35 - 0) * 10 * 24\} \\
 &= 84000
 \end{aligned}$$

$$\begin{aligned}
 MTBF_{(L)} &= \left\{ \frac{2T}{x^2(\alpha, 2\gamma + 2)}, \infty \right\} \\
 &= \frac{2 * 84000}{5.991} \\
 &= 28042 \text{ Hrs} \\
 &= 3.2 \text{ Years}
 \end{aligned}$$

实物照片

ALX21P-092AA1-00





文件名稱	PCB外觀檢驗規範	版本	A
文件編號		制訂日期	2020/10/20

文件修訂歷程			
版本	修訂日期	變更內容	修訂人

文件名稱	PCB外觀檢驗規範	版本	A
文件編號		制訂日期	2020/10/20

一、目的

明訂綠億科技使用之材料外觀檢驗標準

二、範圍

所有購入之PCB適用之

三、名詞定義

- a. 凹凸點、痕: 表面異常凸起或凹陷
- b. 異物殘留: 生產過程中由於作業疏忽，導致外物殘留在工件上
- c. 變形: 外力所造成的外觀形狀變異
- d. 髒污: 不明油漬、灰塵、指紋、污物附著造成
- e. 生鏽: 母材起化學變化產生鏽蝕
- g. 刮傷: 外力造成的線狀損傷
- h. 毛邊: 機械沖壓或切割後未處理好，導致加工件邊緣所產生的毛刺
- i. 不全: 作業過程中因作業疏忽造成圖案或文字不完整
- j. 雙影: 指圖案有兩層或以上的陰影，常出現於重複印刷
- k. 漏焊: 焊墊上未沾錫，未將零件及基板焊接在一起
- l. 零件脫落: 錫焊作業後零件不在應有的位置上
- m. 缺件: 應該裝的零件而未裝上
- n. 錫尖: 焊點表面非呈光滑隻連續面，而有尖銳之突起
- o. 錫不足: 被焊零件或零件腳錫過少，未達到標準焊錫量
- p. 錫多: 接腳錫量過多而溢出
- q. 錫球(珠、渣): 錫量球狀或呈薄片不在焊接處
- r. 墓碑效應: 零件之一端翹起
- s. 空焊(假焊): 零件腳與焊墊間沾有錫，但實際上沒有被錫完全焊接住
- t. 燈蕊效應: 錫膏熔融後延著零件腳上升，使焊點量不足
- u. 冷焊: 亦稱未溶錫，焊點表面乾燥粗糙，顏色黯淡
- v. 裂錫: 元件面或焊錫面的零件腳旁錫裂開

文件名稱	PCB外觀檢驗規範	版本	A
文件編號		制訂日期	2020/10/20

四、使用工具

- a. 目視
- b. 點規卡

五、作業內容

a. 檢驗環境

- ◆目視距離： 25~35cm
- ◆檢驗光源： 700~1000Lux
- ◆檢驗角度： <45度
- ◆檢驗時間： 7秒
- ◆檢驗者視力： 色覺正常且裸眼或矯正在0.7以上

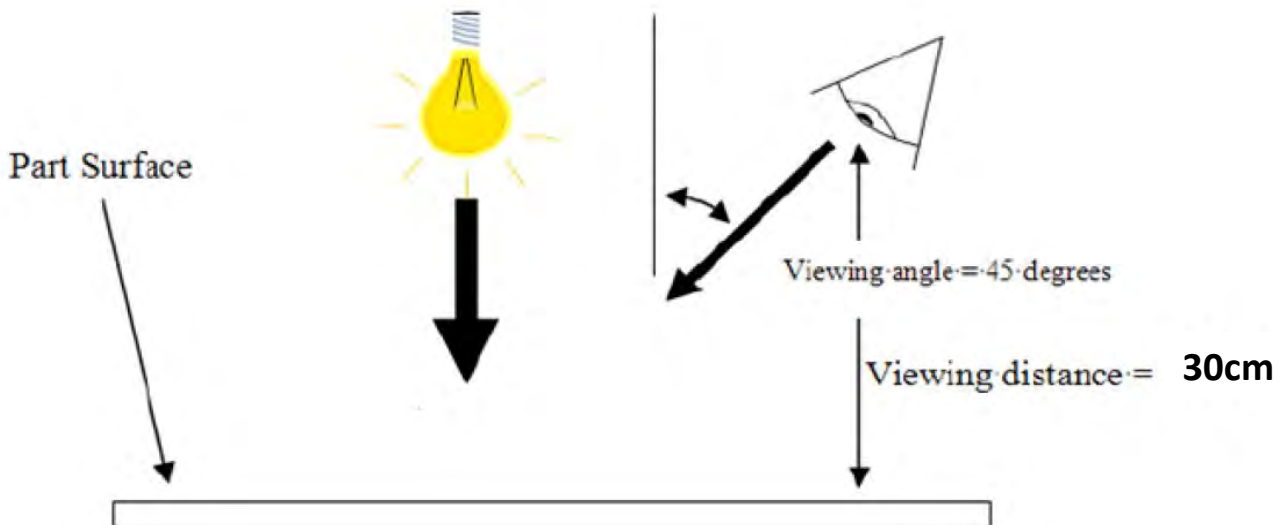

b. 抽樣水準

若無指定則使用MIL-STD-105E 一般檢驗水準 II，允收水準AQL 0.65

文件名稱	PCB外觀檢驗規範	版本	A
文件編號		制訂日期	2020/10/20

c. 檢驗區域

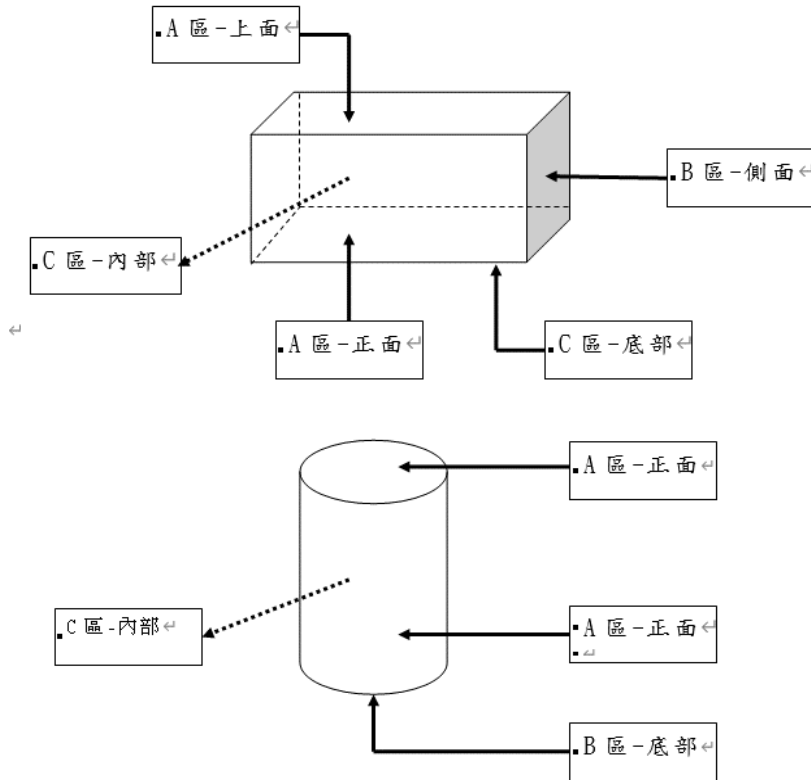

- ◆A區：產品於使用者正面可見部份，如正面，上面
- ◆B區：產品於使用者正面不可見部份，如左右側面
- ◆C區：產品底面，背面，內部

文件名稱	PCB外觀檢驗規範	版本	A
文件編號		制訂日期	2020/10/20

【記號的定義】

本基準所使用的記號,表示如下。

	長度	寬度	高度	傾角	面積	個數	直徑
記號	L	W	H	θ	S	N	φ
單位	mm	mm	mm	°	mm ²	個	mm

檢驗部位	檢驗項目		備註
基材	點瑕疵	1mm*2mm · N<2 允收	露銅不允許 脫層斷裂不允許
	線瑕疵	無感刮傷W<0.3mm · L<20mm · N<2 · 兩線相距50mm 允收	
	翹曲	<常邊對角線*1.5%	
防焊漆	點瑕疵	氣泡面積<非導體區5% 允收 凹凸不平不允許	露銅、露線路不允許
	線瑕疵	W<0.5mm · L<10mm · N<2 允收	
	補漆	S≤6mm ² · N<4 允收	
線路	污損、剝離、凹陷不允許		
印刷圖文	斷缺、模糊、油墨擴散、漏印、油墨印偏在焊墊上不允許		
焊墊	脫落、翹起不允許		
焊接	漏焊、空焊、冷焊、錫尖、錫不足、錫多、錫球、裂錫、墓碑效應、燈蕊效應、 零件脫落、缺件不允許		

※每pcs總瑕疵需<3個

※可以擦拭的髒污狀態，判定的基準需為擦拭過後的結果來判定



A3 级覆铜箔板质量技术指标

试验项目	试样处理	标准值	典型值
1.抗剥强度 磅/英寸, 最小值			
A 1/2 盎司铜箔			
接收状态	A	≥6.0	6.0-8.0
热应力	A	≥6.0	6.0-8.0
提高温度下	125℃	≥4.0	7.0
暴露于工艺溶液后	125℃	≥4.5	7.0
B 1 盎司铜箔			
接收状态	A	≥8.0	8.0-10.0
热应力	A	≥8.0	8.0-10.0
提高温度下	125℃	≥6.0	9.0
暴露于工艺溶液后	125℃	≥7.0	9.0
2.体积电阻, 最小值, MΩ·CM 在提高温度下	E-24/125	≥10 ³	10 ⁶
3.表面电阻, 最小值, MΩ 在提高温度下	E-24/125	≥10 ³	10 ⁶
4.吸水性,最大值(%)	E-1/105+des	≤0.80	0.18-0.35
5.击穿电压,最小值(KV),步进(厚度≥0.50 mm)	D-48/50 D-0.5/23	≥35	38
6.抗弯强度, 最小值(N/mm ²) (厚度≥0.50 mm)			
经向	A	≥415	495
纬向	A	≥345	405
7.抗电弧性,最小值, 秒	D-48/50 D-0.5/23	≥60	75
8.阻燃性	A	UL94V0	UL94V0
9.可焊性	A	可焊	可焊
10.介电常数,1MHZ 下	A	≤ 5.4	4.7-4.9
11.损耗角正切,1MHZ 下	A	≤0.045	0.020-0.035
12.弯曲和翘曲,最大(%)			
双面(厚度大于 0.78mm; 尺寸 300mm×300mm)	A	≤1.0	0.20-0.50
单面(厚度大于 0.78mm; 尺寸 300mm×300mm)	A	≤1.5	0.30-0.70
双面(厚度 0.5~0.78 mm; 尺寸 300mm×300mm)	A	≤1.5	0.30-0.50
单面(厚度 0.5~0.78 mm; 尺寸 300mm×300mm)	A	≤2.0	0.35-0.70
13.热应力,288℃,漂锡 10 秒 未蚀刻试样	A	NO DEFECT	55-80 Sec
14.玻璃化转变温度,TG(DSC, °C)	A	≥125	135
15.适用范围: 家电行业、电脑周边产品、普通电子产品。不适用于计量用仪表。			
16.适用线路: 最小孔径>0.3mm, 最小孔间距>0.8mm。			

备注: 1、处理方法中字母及数值的含义

A-板材交货阶段

D-恒温水浴 E-高温烘培 数 1/数 2: 1-时间(小时) 2-温度(°C) des-干燥 10 分钟以上或干燥状态下冷却至室温。

2、上表所定翘曲度标准仅适用于覆铜箔板交货验收。若以成品 PCB 板作为检验样品, 一般要求 PCB 两面布线基本均匀, 最大尺寸不大于 12", 且在 140℃热风循环烤箱中, 保持承载板水平, 烘烤 2 小时, 自然冷却至室温的试验测试值为准。

QMTS2.E330731

Polymeric Materials - Filament-wound Tubing, Industrial Laminates, Vulcanized Fiber, and Materials for Use in Fabricating Recognized Printed Wiring Boards - Component

For enhanced search functionality, please visit UL's [iQ™ Family of Databases](#).

Click on a product designation for complete information.

[Page Bottom](#)

Polymeric Materials - Filament-wound Tubing, Industrial Laminates, Vulcanized Fiber, and Materials for Use in Fabricating Recognized Printed Wiring Boards - Component

[See General Information for Polymeric Materials - Filament-wound Tubing, Industrial Laminates, Vulcanized Fiber, and Materials for Use in Fabricating Recognized Printed Wiring Boards - Component](#)

GOLDENMAX INTERNATIONAL TECHNOLOGY (ZHUHAI) LTD
8 QINSHI RD QINSHI INDUSTRIAL PARK
SANZAO TOWN
JINWAN DIST
ZHUHAI, GUANGDONG 519040 CHINA

E330731

Industrial laminates:

Mtl Dsg	ANSI Type	Color	Build up		R.T.I.		H W I	H A I	V T R	C T I	Meets 746E DSR
			Min Thk (mm)	Flame Class	Elec (°C)	Mech (°C)					
Industrial laminates, furnished as sheets, rods or tubes.											
GDM-C3, ILM-C3											
	CEM-3	NC (WT)	0.63	V-0	130	140	0	2	4	-	Yes
			1.6	V-0	130	140	0	2	4	3	Yes
GDM-R1, ILM-R1											
	FR-4	NC,YL	0.38	V-0	130	130	0	3	4	-	Yes
			0.63	V-0	130	140	0	3	4	-	Yes
			1.40	V-0	130	140	0	2	4	3	Yes
Industrial laminates.											
GF432	FR-4	NC (YL)	0.38	V-0	130	130	0	0	-	-	Yes
			0.63	V-0	130	140	0	0	-	-	Yes
			1.40	V-0	130	140	0	0	-	3	Yes

Ultrathin build ups:

Build Up					Laminate			Prepreg		
Mtl Dsg	ANSI Type	Min Thk (mm)	TI Elec	TI Mech	Mtl Dsg	Thk (mic)	TI Elec	Mtl Dsg	Thk (mic)	TI Elec
Ultrathin industrial laminates and bonding layers, furnished in sheet form, for use in multilayer printed wiring boards where the thickness is built up to the minimum specified.										
GDM-U1, ILM-U1	FR-4	0.38	130	130	GDM-U1, ILM-U1	100	120	GDM-P1, ILM-P1	100	120

		0.63	130	140	GDM-U1, ILM-U1	100	120	GDM-P1, ILM-P1	100	120
GF432	FR-4	0.38	130	130	GF432	155	120	GF432-PP	75	90
		0.63	130	140	GF432	155	120	GF432-PP	75	90

Metal clad industrial laminates:

				Bld up	Clad Cond Thk				Max		Max	Solder Lts	
Metal Clad Dsg	Laminate Dsg	Pre-preg Dsg	ANSI Type	Min Thk (mm)	Min Ext (mic)	Max Ext (mic)	Max Int (mic)	Area Dia (mm)	Flame Class	Oper Temp (°C)	Temp (°C)	Time (sec)	
Metal clad multilayer package (mass laminate) with internal circuitry and solid copper on outside surfaces, furnished as sheets.													
GDM-ML1, ILM-ML1													
	GDM-U1, ILM-U1	GDM-P1, ILM-P1	FR-4	0.38	17	102	68	50.8	V-0	130	288	20	
Metal clad industrial laminates for use in multilayer printed wiring boards with copper on one or both sides, furnished as sheets.													
GDM-U1, ILM-U1													
	GDM-U1, ILM-U1	GDM-P1- ILM-P1	FR-4	0.38	17	102	68	50.8	V-0	130	288	20	
Metal clad industrial laminates for use in multilayer printed wiring boards with copper on one or both sides.													
GF432	GF432	GF432-PP	FR-4	0.38	17	102	68	50.8	V-0	130	288	20	
Metal clad industrial laminates for use in single layer printed wiring boards with copper on one or both sides, furnished as sheets.													
GDM-C3, ILM-C3													
	GDM-C3, ILM-C3	-	CEM-3	0.63	17	102	-	12.7	V-0	130	288	10	
GDM-R1, ILM-R1													
	GDM-R1, ILM-R1	-	FR-4	0.38	17	102	-	50.8	V-0	130	288	20	
Metal clad industrial laminates for use in single layer printed wiring boards with copper on one or both sides.													
GF432	GF432	-	FR-4	0.38	17	102	-	50.8	V-0	130	288	20	



Marking: Company name or trademark **GDM, ILM** and material designation on container or wrapper.
 Last Updated on 2013-10-31

[Questions?](#)

[Print this page](#)

[Terms of Use](#)

[Page Top](#)

© 2014 UL LLC

When the UL Leaf Mark is on the product, or when the word "Environment" is included in the UL Mark, please search the [UL Environment database](#) for additional information regarding this product's certification.

The appearance of a company's name or product in this database does not in itself assure that products so identified have been manufactured under UL's Follow-Up Service. Only those products bearing the UL Mark should be considered to be Certified and covered under UL's Follow-Up Service. Always look for the Mark on the product.

UL permits the reproduction of the material contained in the Online Certification Directory subject to the following conditions: 1. The Guide Information, Assemblies, Constructions, Designs, Systems, and/or Certifications (files) must be presented in their entirety and in a non-misleading manner, without any manipulation of the data (or drawings). 2. The statement "Reprinted from the Online Certifications Directory with permission from UL" must appear adjacent to the extracted material. In addition, the reprinted material must include a copyright notice in the following format: "© 2014 UL LLC".

规格书

Specification

系列: RF1.13 LOW LOSS
Series (50 Ω) 银锡灰

料号(P/N): KB113L/50-022D



1. 结构图/Configuration

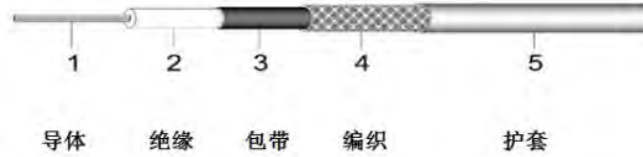

2. 结构/Construction:

项目/Item		详细资料/Details
①内导体 Inner conductor	材料/Material	镀银铜线/Silver plated Copper
	构成(根/mm)/Composition(No./mm)	7/0.08±0.005
	标称直径/NOM. O. D	0.24±0.01
②绝缘层 Insulation	材料/Material	聚全氟乙丙烯/FEP
	标称外径/NOM. O. D	0.715±0.03
	颜色/Color	Natural
③包带 Tape	材料/Material	Copper PET Tape
④外导体 Outer conductor	材料/Material	镀锡铜线 Tinned copper
	形式 Type	编织/Weaving
	构成/Composition	16/4/0.05±0.005
	遮蔽率/ Shielding rate	90±5%
⑤护套层 Jacket	标称直径/NOM. O. D	0.95±0.05
	材料/Material	聚全氟乙丙烯/FEP
	标称外径/NOM. O. D	1.15±0.05
	颜色/Color	灰/Gray

3. 性能特性 Performance characteristics

项目/Item	单位/Unit	详细资料/Details	
电容/Capacitance	pF/m	98	
特性阻抗/Conductor Resistance	Ω	50±3.0	
耐压强度/Dielectric Strength	A. C V/lmin	1000	
衰减/Attenuation	/	频率/Frequency	dB/1m
		1GHz	≤1.7
		2GHz	≤2.5
		3GHz	≤3.1
		4GHz	≤3.5
		5GHz	≤4.0
		6GHz	≤4.5
		7GHz	≤5.2
8GHz	≤5.4		
驻波比/Standing wave (0-6GHz)	/	≤1.3	
驻波比/Standing wave (6-8GHz)	/	≤1.4	

4. 机械性能特性 Mechanical characteristics

项目 Item	单位 Unit	详细资料/Details
最小弯曲半径(一次) Min.bending radius static	mm	4
工作温度范围 Operating temperature	°C	-55to125

5. 使用提示 Use tips

存储环境 Storage environment	温度：30°C以下；湿度：20%~65%
最佳保存周期 The best save cycle	2个月，2个月以上锡效果变差，但电性能不受影响，夏季高温高湿环境开剥后需尽快流转
加工温度 Processing temperature	250°C~260°C的情况下，可短时间承受；300°C以上会出现热分解现象
铁氟龙收缩 Teflon Shrink	绝缘层收缩 $\leq 0.2\text{mm}$ ；护套层收缩 $\leq 0.3\text{mm}$

6. 包装 Packing

标准单位包装长度为1000米/盘，每盘最多允许5个接头，接头最短长度10米，在搬运过程中不能损坏包装。

Standard unit for the 1000m/reel length of packaging, each set up to allow 5 joints, the joint shortest length of 10m, The finished cable shall be packed not be damaged during transportation.

7. 其他 Other

特殊加工工艺，请与供方协商后使用。

Special processing technology, please use after consultation with the supplier.

规格书完

End of specification



AVLV2.E349435 - Appliance Wiring Material - Component

Appliance Wiring Material - Component

[See General Information for Appliance Wiring Material - Component](#)

JIANGYIN KAIBO COMMUNICATION TECHNOLOGY CO LTD
No.83 Dong Ding Rd. Mountain View Town
Jiangyin, Jiangsu 214400 CHINA

E349435

Table of Recognized Styles

Single-conductor, thermoplastic insulation.							
<u>1007</u>	<u>1061</u>	<u>1569</u>	<u>10064</u>	<u>10304</u>	<u>10369</u>	<u>11149</u>	
<u>1015</u>	<u>1354</u>	<u>1571</u>	<u>10248</u>	<u>10368</u>	<u>10871</u>	<u>11180</u>	
Single-conductor, thermoset insulation.							
<u>3302</u>	<u>3385</u>	<u>3386</u>	<u>3619</u>				

Marking: Company name, voltage rating, temperature rating, conductor size, conductor material if other than copper, and use.

Last Updated on 2021-01-15

并不是所有出现在本数据库中的公司名称和产品都满足了UL 跟踪检验服务的要求。只有带有 UL 标志的产品，才应该被视为经过UL 认证，并满足UL 跟踪检验服务的要求。注意查看产品上的标志。

UL 允许在线认证目录中所含材料的复制遵循以下条件：1.指南信息、装配、构造、设计、系统和/或认证（文件）必须在不篡改任何数据（或图纸）的情况下完整且无误导性地呈现。2.“经 UL 允许从在线认证目录转载”声明必须出现在所摘取材料的邻近位置。此外，转载材料必须包含以下格式的版权声明：“© 2021 UL LLC”

CUSTOMER DRAWING

HSF

Rev.	ECN No.	DESCRIPTION
A	ECN180502-001	NEW RELEASE
B	ECN180610-001	ADD "HSF"

Notes:

- Material and finish(Plating)
 - △Housing PBT (Black), UL94V-0.
 - △Shell Phosphor bronze: Au over Ni
 - △Contact Phosphor bronze: Au over Ni
- Impedance: 50 OHM Nominal
- Frequency Rating: DC TO 6 GHZ
- VSWR: DC -- 3GHz 1.3max.
3GHz -- 6GHz 1.5max.
- Cable retention force 10N min.
- The harmful material of this part should be compliance with CCT document QW-QA-10.

PRODUCT NUMBER ORDER

ANC Z 113 * - 1 C 1
① ② ③ ④ ⑤ ⑥ ⑦

- Production Code :
ANC: ANTENNA PLUG for cable
- Height after mated broad end :
Z: Special SPEC. CCT PATENTED
- Match Cable ϕ :
113: Cable ϕ 1.13mm
- Shell Gold Plating Thickness :
L: Plating Gold 0.5u" min.
1: Plating Gold 1.0u" min.
- Product design generation:
1: First generation.
- Customer identification code:
1: CUS is Another
C: 1.13 CCT shell mark "13"
- Color of Housing:
1: Black

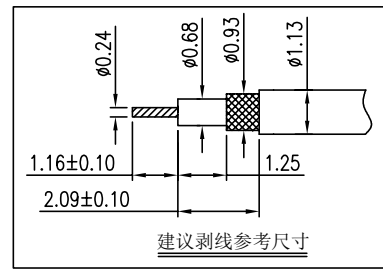
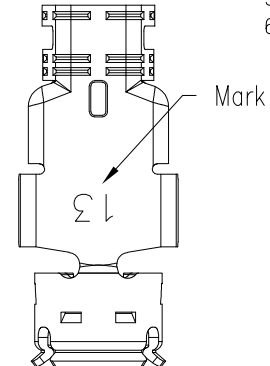
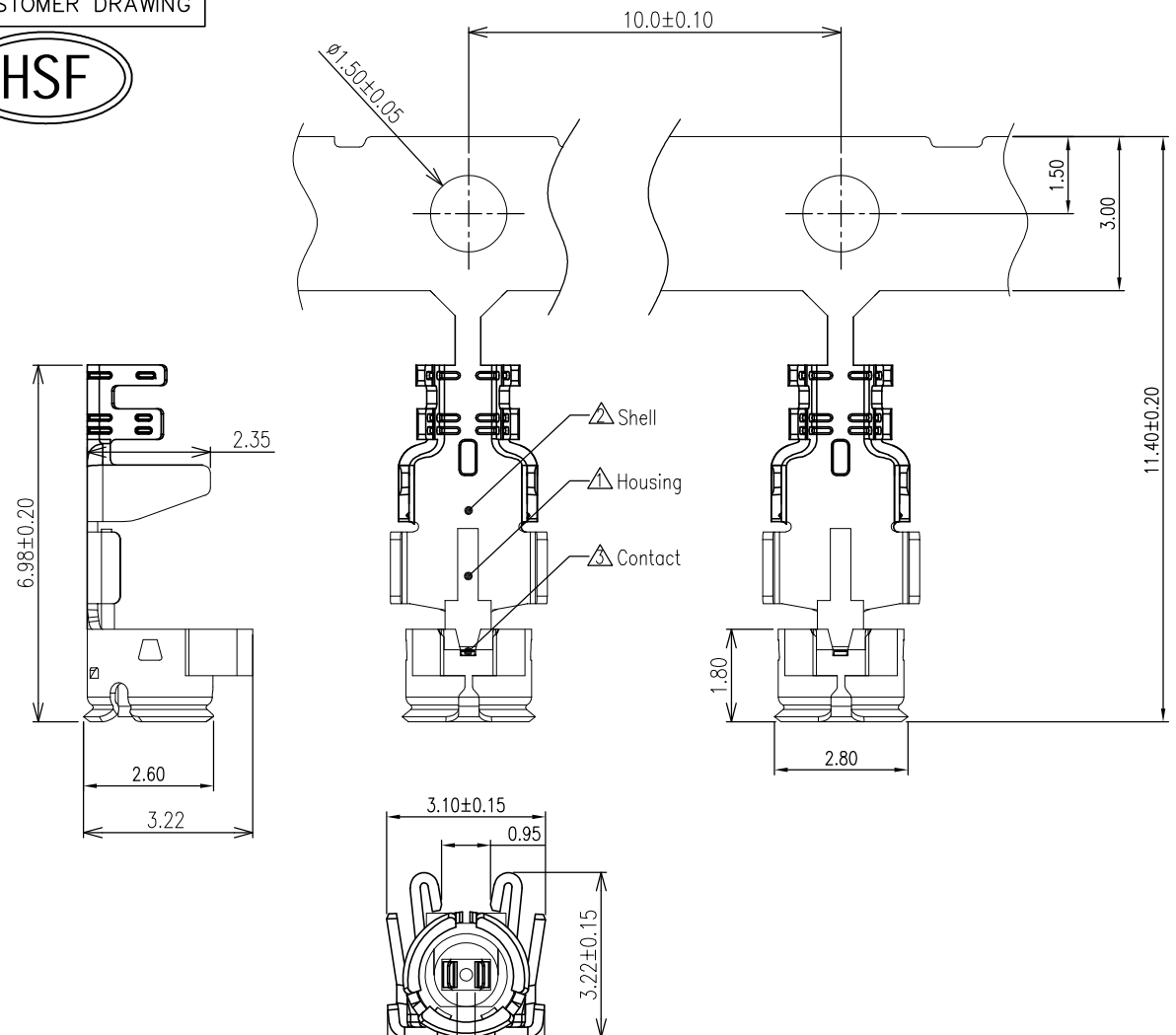

TOLERANCES UNLESS OTHERWISE SPECIFIED

X.	±0.25	X.°	±2°
.X	±0.20	.X°	±1°
.XX	±0.15	.XX°	±0.5°

THESE DRAWINGS AND SPECIFICATIONS ARE THE PROPERTY OF KUNSHAN COCENTRA ELECTRONICS CO.,LTD. AND SHALL NOT BE REPRODUCED, COPIED OR USED IN ANY MANNER WITHOUT THE PRIOR WRITTEN CONSENT OF COCENTRA PRECISION TECHNOLOGY (JIANGSU) Co. LTD.

科信成精密科技(江苏)有限公司 COCENTRA PRECISION TECHNOLOGY (JIANGSU) Co. LTD.					
SERIES: RF CABLE PLUG CONN.			TITLE: RF1代 PLUG 1.13 C TYPE		
APPD: 王宁 2018/06/10			PART No.: ANCZ113x-1C1		
CKD: 魏国强 2018/06/10			DWG No.: 307-0000-0183		
DR: 魏国强 2018/06/10			UNITS	MAT'L	FINISH
			MM	N/A	N/A
			SCALE	SHEET	REV.
			1:1	1/1	B



SHINKONG SYNTHETIC FIBERS CORP
223 YEN PING RD SEC 3, PIN CHENG TAOYUAN HSIEN 324 TW



F202G15

Polybutylene Terephthalate (PBT), pellets

可燃性	Value	测试方法
UL 阻燃等级		UL 94
1.50 mm, ALL	V-0	IEC 60695-11-10, -20
3.20 mm, ALL	V-0	
灼热丝易燃指数		IEC 60695-2-12
1.50 mm	800 °C	
3.20 mm	960 °C	
热灯丝点火温度		IEC 60695-2-13
1.50 mm	750 °C	
3.20 mm	725 °C	
电气性能	Value	测试方法
热丝引燃 (HWI)		UL 746
1.50 mm	PLC 0	
3.20 mm	PLC 0	
高电弧燃烧指数(HAI)		UL 746
1.50 mm	PLC 0	
3.20 mm	PLC 0	
相比耐漏电起痕指数(CTI)	PLC 0	UL 746
介电强度	24 kV/mm	ASTM D149 IEC 60243-1
高电压电弧起痕速率 (HVTR)	PLC 1	UL 746
体积电阻率	1.0E+15 ohm·cm	ASTM D257 IEC 60093
耐电弧性	PLC 5	ASTM D495
热性能	Value	测试方法
RTI Elec		UL 746
1.50 mm	75.0 °C	
3.20 mm	75.0 °C	
RTI Imp		UL 746
1.50 mm	75.0 °C	
3.20 mm	75.0 °C	
RTI Str		UL 746
1.50 mm	75.0 °C	
3.20 mm	75.0 °C	

Component - Plastics

UL 档案号: E107536



Notice of Disclaimer

By accessing this Yellow Card data information sheet and the database from which this information was generated (the "Yellow Card"), the user acknowledges and accepts the terms and conditions upon which this Yellow Card is made available. This Yellow Card, the database from which it was generated, and all related materials, support, and services, are made available by UL for use only by permission and "as is", without any representation or warranty of any kind, express or implied, including but not limited to any implied warranties of merchantability, fitness for a particular purpose or that the products identified in this Yellow Card will satisfy the user's requirements. UL cannot and does not warrant that the data contained in this Yellow Card is current, accurate, or complete. The user must independently confirm the conformance of any product to the applicable standards or requirements with the manufacturer of that product. Permission to access this Yellow Card may be withdrawn at any time by UL in its sole discretion. The identification of products and companies on this Yellow Card does not in any way imply endorsement of those products or companies by UL. UL does not assume and expressly disclaims, liability to any person for any loss or damage (including lost profits, lost savings, or any indirect, special, incidental, consequential or punitive damages whether or not UL has been advised of the possibility of such damages) arising out of, or in connection with, the use of this Yellow Card regardless of the cause or causes of such loss or damage.



綠億科技股份有限公司

LYNwave Technology Limited

包裝規範書

包裝規範書				
產品名稱	天線	客戶名稱	版次	A
綠億料號		客戶料號	製作日期	
產品包裝說明		產品包裝圖示		
<p>一、包裝：</p> <p>(1)20~30PCS/束</p> <p>(2)2~4束/袋</p> <p>二、裝箱：</p> <p>每箱50~100袋</p> <p>註：</p> <p>1.線長50mm以下,接頭端不包珍珠棉</p> <p>2.以實際裝箱數量為準</p>		<p>PE袋</p> <p>紙箱</p>		

核准：徐永銘

審核：張良鉅

製表：魏詩怡