

REVISIONS

ECN NO.	I.R	ZONE	LTR	DESCRIPTION	DATE	APPROVED
	X					

GRAPHICS

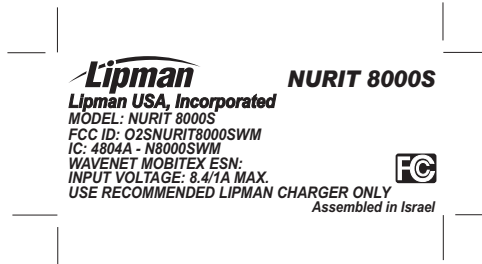

CUTTING DIMENSIONS

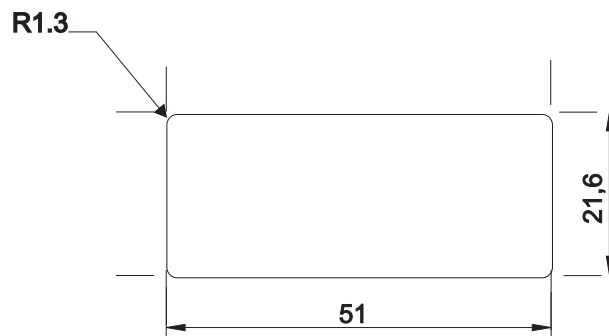

LIPMAN PART No: LBP09565

MATERIAL		POLYCARBONATE, MATTE, 0.25mm THICK				
ADHESIVE		ON REVERSE SIDE OF LABEL				
ADHESIVE TYPE		467MP, 3M COMPANY				
TEXT COLOR		BLACK				
BACKGROUND COLOR		PANTONE 430C				
CONTRACT NO.	SIGNATURE	DATE	 LIPMAN ELECTRONIC ENGINEERING LTD. TITLE BOTTOM LABEL - NURIT 8000S FOR USA (WAVENET)			
DRAWN	O.FRIEDMAN	11.12.03				
CHECK	S.LEPEL	11.12.03				
DESIGN	K.ZELTSER	11.12.03				
DESIGN ACTIVITY			SIZE	FILE:	DWG NO.	REV.
			A	0958113	0958113	A
			SCALE	RELEASE DATE	SHEET	1 OF 1

REVISIONS

ECN NO.	ZONE	LTR	DESCRIPTION	DATE	APPROVED
				11.12.03	

NOTICE

This device complies with Part 15 of FCC Rules. Operation is subject to the following two conditions:
 (1) this device may cause harmful interference, and
 (2) this device must accept any interference received, including interference that may cause undesired operation.

GRAPHICS

CUTTING DIMENSIONS



LIPMAN P.N.: LBP09566

MATERIAL	POLYESTER WHITE ADHESIVE WITH LAMINATION OR UV COATING
ADHESIVE	ON REVERSE SIDE OF LABEL
PRINT COLOR	BLACK, RESISTANT HEXAN MATERIAL



CONTRACT NO.		SIGNATURE	DATE	 LIPMAN ELECTRONIC ENGINEERING LTD. TITLE NURIT 8000S FCC LABEL			
DRAWN	O.FRIEDMAN		11.12.03				
CHECK	S.LEPEL	<i>[Signature]</i>	11.12.03				
DESIGN	K.ZELTSER						
DESIGN ACTIVITY				SIZE	DIR:	DWG NO.	REV.
				A	FILE: 0958114	0958114	A
NEXT ASSY				SCALE	RELEASE DATE	11.12.03	SHEET 1 OF 1

REVISIONS

ECN NO.	I.R	ZONE	LTR	DESCRIPTION	DATE	APPROVED
	X					

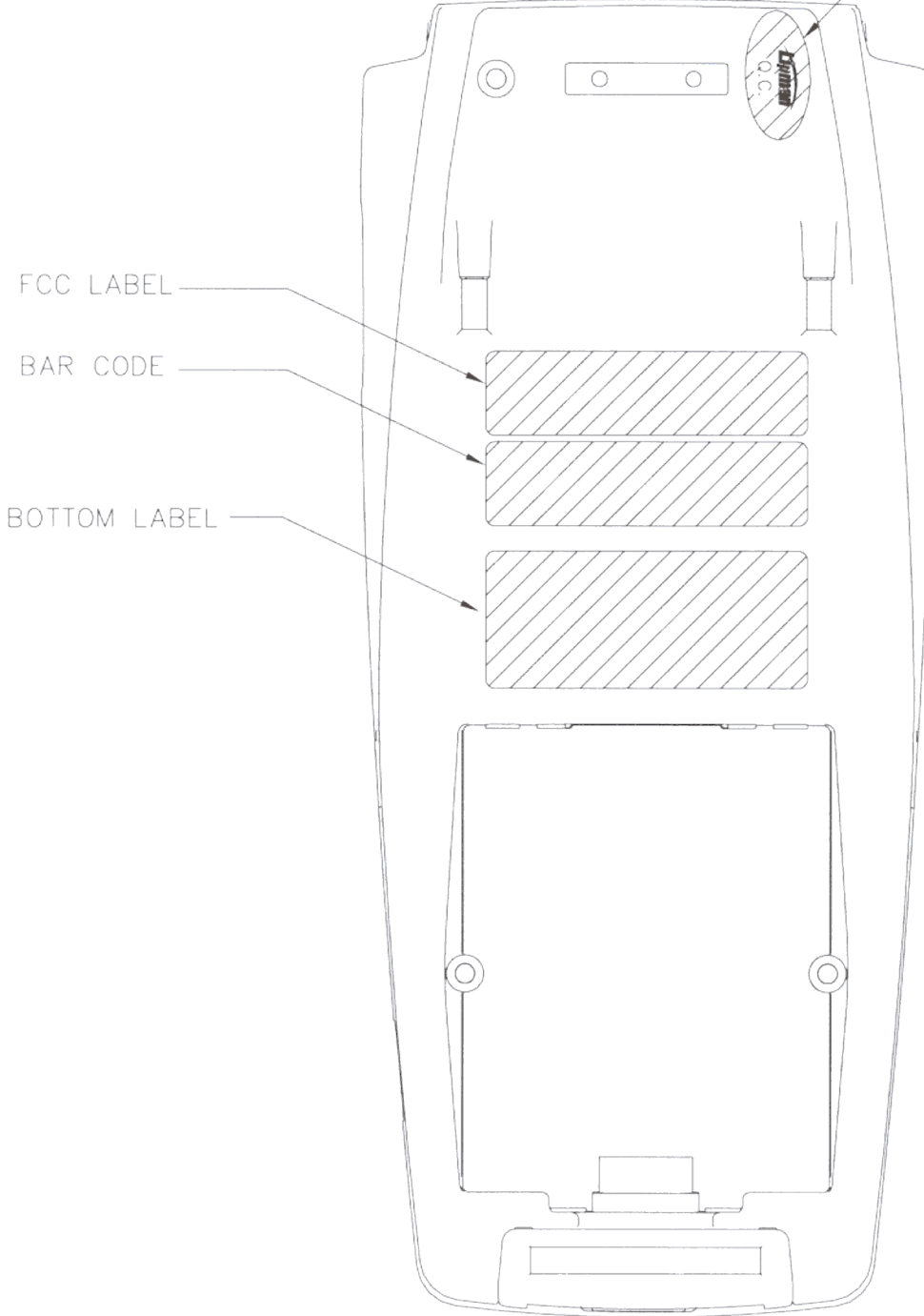
PROTECTION LABEL
(LBP000168)



TOLERANCE TABLE		CONTRACT NO.		SIGNATURE	DATE	 Lipman Electronic Engineering Ltd.		
UNLESS OTHERWISE SPECIFIED		DRAWN	O.FRIEDMAN		11.12.03	TITLE NURIT 8000 LABELS LOCATION		
		CHECK	S.LEPEL		11.12.03			
GEN. TOLERANCE	±0.1	DESIGN			11.12.03			
PRODUCTION FILE:		DESIGN ACTIVITY			SIZE	DIR:095	DWG NO.	REV.
		APPROVED			B	0956010	0956010	A
				SCALE	RELEASE DATE		SHEET	