

ENGINEERING TEST REPORT

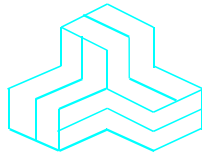

Boomer-III Mobitex Wireless OEM Modem Module

Model No.: BM3-900M

FCC ID: PQS-BM3900M

Applicant:

Wavenet Technology Pty Ltd.

140 Burswood Road

Burswood, Perth, WA

Australia, 6100

Tested in Accordance With

Federal Communications Commission (FCC)

47 CFR, PARTS 2 and 90 (Subpart I)

UltraTech's File No.: WTP015QFCC90

This Test report is Issued under the Authority of
Tri M. Luu, Professional Engineer,
Vice President of Engineering
UltraTech Group of Labs

Date: October 01, 2003



Report Prepared by: Dharmajit Solanki, RFI Engineer

Tested by: Mr.Hung Trinh, RFI Technician

Issued Date: October 01, 2003

Test Dates: September 24 - 30, 2003

- *The results in this Test Report apply only to the sample(s) tested, and the sample tested is randomly selected.*
- *This report must not be used by the client to claim product endorsement by NVLAP or any agency of the US Government.*

UltraTech

3000 Bristol Circle, Oakville, Ontario, Canada, L6H 6G4

Tel.: (905) 829-1570 Fax.: (905) 829-8050

Website: www.ultratech-labs.com, Email: vic@ultratech-labs.com, Email: tri@ultratech-labs.com



31040/SIT



C-1376



46390-2049



200093-0



SL2-IN-E-1119R



00-034



TABLE OF CONTENTS

EXHIBIT 1.	SUBMITTAL CHECK LIST.....	1
EXHIBIT 2.	INTRODUCTION	2
2.1.	SCOPE.....	2
2.2.	RELATED SUBMITTAL(S)/GRANT(S).....	2
2.3.	NORMATIVE REFERENCES	2
EXHIBIT 3.	PERFORMANCE ASSESSMENT	3
3.1.	CLIENT INFORMATION	3
3.2.	EQUIPMENT UNDER TEST (EUT) INFORMATION.....	3
3.3.	EUT’S TECHNICAL SPECIFICATIONS.....	4
3.4.	LIST OF EUT’S PORTS	5
3.5.	ANCILLARY EQUIPMENT	5
3.6.	TEST SETUP BLOCK DIAGRAM.....	5
EXHIBIT 4.	EUT OPERATING CONDITIONS AND CONFIGURATIONS DURING TESTS.....	7
4.1.	CLIMATE TEST CONDITIONS	7
4.2.	OPERATIONAL TEST CONDITIONS & ARRANGEMENT FOR TEST SIGNALS	7
EXHIBIT 5.	SUMMARY OF TEST RESULTS	8
5.1.	LOCATION OF TESTS	8
5.2.	APPLICABILITY & SUMMARY OF EMISSION TEST RESULTS.....	8
5.3.	MODIFICATIONS INCORPORATED IN THE EUT FOR COMPLIANCE PURPOSES	9
5.4.	DEVIATION FROM STANDARD TEST PROCEDURES.....	9
EXHIBIT 6.	MEASUREMENTS, EXAMINATIONS & TEST DATA FOR EMC EMISSIONS.....	10
6.1.	TEST PROCEDURES	10
6.2.	MEASUREMENT UNCERTAINTIES	10
6.3.	MEASUREMENT EQUIPMENT USED:.....	10
6.4.	ESSENTIAL/PRIMARY FUNCTIONS AS DECLARED BY THE MANUFACTURER:.....	10
6.4.1.	<i>RF power output @ FCC 2.1046 & 90.205.....</i>	<i>11</i>
6.4.2.	<i>Limits @ FCC 90.205. Please refer to FCC CFR 47, Part 90, Subpart I, Para. 90.205 for specification details. 11</i>	
6.4.3.	<i>Method of Measurements.....</i>	<i>11</i>
6.4.4.	<i>Test Equipment List</i>	<i>11</i>
6.4.5.	<i>Test Arrangement</i>	<i>11</i>
6.4.6.	<i>Test Data :</i>	<i>12</i>
CONDUCTED POWER.....		12
6.5.	RF EXPOSURE REQUIREMENTS @ 1.1310 & 2.1091	13
6.5.1.	<i>Limits</i>	<i>13</i>
6.5.2.	<i>Method of Measurements.....</i>	<i>13</i>
6.5.3.	<i>Test Data.....</i>	<i>15</i>
6.6.	FREQUENCY STABILITY @ FCC 2.1055 & 90.213	17
6.6.1.	<i>Limits @ FCC 90.213.....</i>	<i>17</i>
6.6.2.	<i>Method of Measurements.....</i>	<i>17</i>
6.6.3.	<i>Test Equipment List</i>	<i>17</i>
6.6.4.	<i>Test Arrangement</i>	<i>17</i>
6.6.5.	<i>Test Data.....</i>	<i>18</i>

6.7.	MODULATION LIMITING @ FCC 2.1047(B) & 90.210.....	19
6.7.1.	<i>Limits @ FCC 2.1047(b) and 90.210</i>	19
6.7.2.	<i>Method of Measurements</i>	19
6.7.3.	<i>Test Equipment List</i>	19
6.7.4.	<i>Test Arrangement</i>	19
6.7.5.	<i>Test Data</i>	20
6.8.	99% OCCUPIED BANDWIDTH & EMISSION MASK @ FCC 2.1049, 90.209 & 90.210.....	21
6.8.1.	<i>Limits @ FCC 90.209 & 90.210</i>	21
6.8.2.	<i>Method of Measurements</i>	21
6.8.3.	<i>Test Equipment List</i>	21
6.8.4.	<i>Test Arrangement</i>	21
6.8.5.	<i>Test Data</i>	22
6.9.	TRANSMITTER ANTENNA POWER SPURIOUS/HARMONIC CONDUCTED EMISSIONS @ FCC 90.210.....	32
6.9.1.	<i>Limits @ 90.210</i>	32
6.9.2.	<i>Method of Measurements</i>	32
6.9.3.	<i>Test Equipment List</i>	32
6.9.4.	<i>Test Arrangement</i>	32
6.9.5.	<i>Test Data</i>	33
6.10.	TRANSMITTER SPURIOUS/HARMONIC RADIATED EMISSIONS @ FCC 90.210.....	47
6.10.1.	<i>Limits @ FCC 90.210(J)</i>	47
6.10.2.	<i>Method of Measurements</i>	47
6.10.3.	<i>Test Equipment List</i>	47
6.10.4.	<i>Test Setup</i>	48
6.10.5.	<i>Test Data (Low Transmitter Power)</i>	49
EXHIBIT 7.	MEASUREMENT UNCERTAINTY.....	50
7.1.	RADIATED EMISSION MEASUREMENT UNCERTAINTY.....	50
EXHIBIT 8.	MEASUREMENT METHODS.....	51
8.1.	CONDUCTED POWER MEASUREMENTS.....	51
8.2.	RADIATED POWER MEASUREMENTS (ERP & EIRP) USING SUBSTITUTION METHOD.....	52
8.2.1.	<i>Maximizing RF Emission Level (E-Field)</i>	52
8.2.2.	<i>Measuring the EIRP of Spurious/Harmonic Emissions using Substitution Method</i>	53
8.3.	FREQUENCY STABILITY.....	55
8.4.	EMISSION MASK.....	56
8.5.	SPURIOUS EMISSIONS (CONDUCTED).....	56

EXHIBIT 1. SUBMITTAL CHECK LIST

Annex No.	Exhibit Type	Description of Contents	Quality Check (OK)
--	Test Report	<ul style="list-style-type: none"> Exhibit 1: Submittal check lists Exhibit 2: Introduction Exhibit 3: Performance Assessment Exhibit 4: EUT Operation and Configuration during Tests Exhibit 5: Summary of test Results Exhibit 6: Measurement Data Exhibit 7: Measurement Uncertainty Exhibit 8: Measurement Methods 	OK
1	Test Setup Photos	Photos # 1 to 3	OK
2	External Photos of EUT	Photos # 1 to 2	OK
3	Internal Photos of EUT	Photos # 1 to 2	OK
4	Cover Letters	<ul style="list-style-type: none"> Letter from Ultratech for Certification Request Letter from the Applicant to appoint Ultratech to act as an agent Letter from the Applicant to request for Confidentiality Filing 	OK
5	Attestation Statements	<ul style="list-style-type: none"> N/A 	N/A
6	ID Label/Location Info	ID Label Location of ID Label	OK
7	Block Diagrams	Block Diagrams	OK
8	Schematic Diagrams	Schematic diagrams # 1 to 8	OK
9	Parts List/Tune Up Info	Parts List of Module	OK
10	Operational Description	System Description	OK
11	RF Exposure Info	Radio Frequency Exposure	OK
12	Users Manual	User Manual	OK

ULTRATECH GROUP OF LABS

3000 Bristol Circle, Oakville, Ontario, Canada L6H 6G4
 Tel. #: 905-829-1570, Fax. #: 905-829-8050, Email: vic@ultratech-labs.com, Website: <http://www.ultratech-labs.com>

File #: WTP015QFCC90
 October 01, 2003

- All test results contained in this engineering test report are traceable to National Institute of Standards and Technology (NIST)

EXHIBIT 2. INTRODUCTION

2.1. SCOPE

Reference:	FCC Parts 2 and 90
Title:	Telecommunication - Code of Federal Regulations, CFR 47, Parts 2 & 90
Purpose of Test:	To gain FCC Certification Authorization for Radio operating in the frequency band 896-901MHz (12.5kHz Channel Spacing)
Test Procedures:	Both conducted and radiated emissions measurements were conducted in accordance with American National Standards Institute ANSI C63.4 - American National Standard for Methods of Measurement of Radio-Noise Emissions from Low-Voltage Electrical and Electronic Equipment in the Range of 9 kHz to 40 GHz.
FCC Grant Limitation:	<ul style="list-style-type: none">• For Mobile and Base Devices only. FCC new certification with SAR compliance for a Portable OEM product, which employs this radio, is required.• For any antenna with the gain less than or equal to 5 dBi• The separation distance from antenna to any person shall be not less than 20 cm

2.2. RELATED SUBMITTAL(S)/GRANT(S)

None

2.3. NORMATIVE REFERENCES

Publication	Year	Title
FCC CFR Parts 0-19, 80-End	2002	Code of Federal Regulations – Telecommunication
ANSI C63.4	1992	American National Standard for Methods of Measurement of Radio-Noise Emissions from Low-Voltage Electrical and Electronic Equipment in the Range of 9 kHz to 40 GHz
CISPR 22 & EN 55022	1997 1998	Limits and Methods of Measurements of Radio Disturbance Characteristics of Information Technology Equipment
CISPR 16-1	1999	Specification for Radio Disturbance and Immunity measuring apparatus and methods

EXHIBIT 3. PERFORMANCE ASSESSMENT

3.1. CLIENT INFORMATION

APPLICANT	
Name:	Wavenet Technology Pty Ltd.
Address:	140 Burswood Road Burswood, Perth, WA Australia, 6100
Contact Person:	Mr. David Shawcross Phone #: + 61 8 9262 0239 Fax # + 61 8 9355 5622 Email Address: dshawcross@wavenet.com.au

MANUFACTURER	
Name:	Wavenet Technology Pty Ltd.
Address:	140 Burswood Road Burswood, Perth, WA Australia, 6100
Contact Person:	Mr. David Shawcross Phone #: + 61 8 9262 0239 Fax # + 61 8 9355 5622 Email Address: dshawcross@wavenet.com.au

3.2. EQUIPMENT UNDER TEST (EUT) INFORMATION

The following information (with the exception of the Date of Receipt) has been supplied by the applicant.

Brand Name:	Wavenet Technology Pty Ltd.
Product Name:	Boomer-III Mobitex Wireless OEM Modem Module
Model Name or Number:	BM3-900M
Serial Number:	Pre-production
Type of Equipment:	Non-broadcast Radio Communication Equipment
Power Supply:	External regulated DC source
Transmitting/Receiving Antenna Type:	Non-integral
Primary User Functions of EUT:	Wireless Data Communication Modem

ULTRATECH GROUP OF LABS

3000 Bristol Circle, Oakville, Ontario, Canada L6H 6G4
Tel. #: 905-829-1570, Fax. #: 905-829-8050, Email: vic@ultratech-labs.com, Website: <http://www.ultratech-labs.com>

File #: WTP015QFCC90
October 01, 2003

- All test results contained in this engineering test report are traceable to National Institute of Standards and Technology (NIST)

3.3. EUT'S TECHNICAL SPECIFICATIONS

TRANSMITTER	
Equipment Type:	<input checked="" type="checkbox"/> Mobile <input checked="" type="checkbox"/> Base station (fixed use) Note: FCC Re-certification with compliance with SAR is required if the EUT is employed in a Portable OEM device .
Intended Operating Environment:	<input checked="" type="checkbox"/> Commercial <input checked="" type="checkbox"/> Light Industry & Heavy Industry
Power Supply Requirement:	External 3.8 VDC regulated
RF Output Power Rating:	0.032 Watts min 2.0 Watts max.
Operating Frequency Range:	896-901 MHz
RF Output Impedance:	50 Ohms
Channel Spacing:	12.5 kHz
Duty Cycle:	30% Maximum
Occupied Bandwidth (99%):	8 KHz
Modulation Type:	2 Level 8 kbps GMSK (2 kHz max. frequency deviation)
Emission Designation*:	12K0F1D
Antenna Connector Type:	Standard MMCX connector (Professional Installation). Please refer to the User's Manual page# 20 for detailed instruction of antenna installation and RF Exposure Warning.
Antenna Description:	No specific antenna supply. The maximum antenna gain specified by the manufacturer is 5 dBi

* For an average case of commercial telephony, the Necessary Bandwidth is calculated as follows:

For FM Digital Modulation:

Channel Spacing = 12.5 KHz, D = 2.0 KHz max., K = 1, M = Data Rate in kb/s / Level of FM,
 Level of FM = 2

M = 8/2 kb/s

$B_n = 2M + 2DK = 2(8/2) + 2(2.0)(1) = \underline{12 \text{ KHz}}$

Emission designation: 12K0F1D

RECEIVER	
Operating Frequency Range:	935-940 MHz
RF Input Impedance:	50 Ohms

ULTRATECH GROUP OF LABS

3000 Bristol Circle, Oakville, Ontario, Canada L6H 6G4
 Tel. #: 905-829-1570, Fax. #: 905-829-8050, Email: vic@ultratech-labs.com, Website: <http://www.ultratech-labs.com>

File #: WTP015QFCC90
 October 01, 2003

- All test results contained in this engineering test report are traceable to National Institute of Standards and Technology (NIST)

3.4. LIST OF EUT'S PORTS

Port Number	EUT's Port Description	Number of Identical Ports	Connector Type	Cable Type (Shielded/Non-shielded)
1	Data Interface Port	1	30 Way FPC	Non-shielded
2	RF In/Out Port	1	MMCX	Shielded

3.5. ANCILLARY EQUIPMENT

1. Wavenet Technology Special Test Jig
2. IBM ThinkPad Computer, Model 2625, S/N: 78-WWM48, FCC & CE Class B compliance

3.6. TEST SETUP BLOCK DIAGRAM

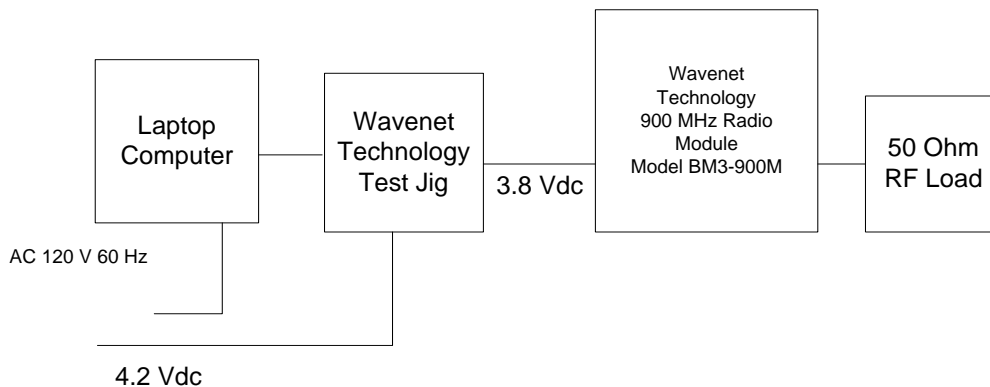

ULTRATECH GROUP OF LABS

3000 Bristol Circle, Oakville, Ontario, Canada L6H 6G4
Tel. #: 905-829-1570, Fax. #: 905-829-8050, Email: vic@ultratech-labs.com, Website: <http://www.ultratech-labs.com>

File #: WTP015QFCC90
October 01, 2003

- All test results contained in this engineering test report are traceable to National Institute of Standards and Technology (NIST)

EXHIBIT 4. EUT OPERATING CONDITIONS AND CONFIGURATIONS DURING TESTS

4.1. CLIMATE TEST CONDITIONS

The climate conditions of the test environment are as follows:

Temperature:	21°C
Humidity:	51%
Pressure:	102 kPa
Power input source:	3.8 VDC Regulated

4.2. OPERATIONAL TEST CONDITIONS & ARRANGEMENT FOR TEST SIGNALS

Operating Modes:	The transmitter was operated in a continuous transmission mode with the carrier modulated as specified in the Test Data.
Special Test Software:	Special Test software provided by Wavenet Technology
Special Hardware Used:	Special Test Jig for interfacing the EUT and laptop computer
Transmitter Test Antenna:	The EUT is tested with the transmitter antenna port terminated to a 50 Ohms RF Load.

Transmitter Test Signals	
Frequency Band(s):	Lowest, Middle & Highest frequencies in each frequency bands that the transmitter covers:
<ul style="list-style-type: none"> ▪ 896 – 901 MHz band: 	<ul style="list-style-type: none"> ▪ 896, 898.5 and 901 MHz
Transmitter Wanted Output Test Signals:	
<ul style="list-style-type: none"> ▪ RF Power Output (measured maximum output power): ▪ Normal Test Modulation ▪ Modulating signal source: 	<ul style="list-style-type: none"> ▪ 0.033 Watts min & 2.1 Watts max. ▪ FM ▪ Internal

EXHIBIT 5. SUMMARY OF TEST RESULTS

5.1. LOCATION OF TESTS

All of the measurements described in this report were performed at Ultratech Group of Labs located in the city of Oakville, Province of Ontario, Canada.

- AC Powerline Conducted Emissions were performed in UltraTech's shielded room, 16'(L) by 12'(W) by 12'(H).
- Radiated Emissions were performed at the Ultratech's 3 Meter Open Field Test Site (OFTS) situated in the Town of Oakville, province of Ontario.

The above sites have been calibrated in accordance with ANSI C63.4, and found to be in compliance with the requirements of Sec. 2.948 of the FCC Rules. The descriptions and site measurement data of the Oakville Open Field Test Site has been filed with FCC office (FCC File No.: 31040/SIT 1300B3) and Industry Canada office (Industry Canada File No.: IC2049). Last Date of Site Calibration: Aug. 10, 2002.

5.2. APPLICABILITY & SUMMARY OF EMISSION TEST RESULTS

FCC PARAGRAPH.	TEST REQUIREMENTS	APPLICABILITY (YES/NO)
90.205 & 2.1046	RF Power Output	Yes
1.1307, 1.1310, 2.1091 & 2.1093	RF Exposure Limit	Yes
90.213 & 2.1055	Frequency Stability	Yes
90.242(b)(8) & 2.1047(a)	Audio Frequency Response	Not applicable to new standard. However, tests are conducted under FCC's recommendation.
90.210 & 2.1047(b)	Modulation Limiting	Yes
90.210 & 2.1049	Emission Limitation & Emission Mask	Yes
90.210, 2.1057 & 2.1051	Emission Limits - Spurious Emissions at Antenna Terminal	Yes
90.210, 2.1057 & 2.1053	Emission Limits - Field Strength of Spurious Emissions	Yes
Boomer-III Mobitex Wireless OEM Modem Module, Model No.: BM3-900M, by Wavenet Technology Pty Ltd. has also been tested and found to comply with FCC Part 15, Subpart B - Radio Receivers and Class B Digital Devices . The engineering test report has been documented and kept in file and it is available anytime upon FCC request.		

ULTRATECH GROUP OF LABS

3000 Bristol Circle, Oakville, Ontario, Canada L6H 6G4
 Tel. #: 905-829-1570, Fax. #: 905-829-8050, Email: vic@ultratech-labs.com, Website: <http://www.ultratech-labs.com>

File #: WTP015QFCC90
 October 01, 2003

- *All test results contained in this engineering test report are traceable to National Institute of Standards and Technology (NIST)*

5.3. MODIFICATIONS INCORPORATED IN THE EUT FOR COMPLIANCE PURPOSES

None

5.4. DEVIATION FROM STANDARD TEST PROCEDURES

None

EXHIBIT 6. MEASUREMENTS, EXAMINATIONS & TEST DATA FOR EMC EMISSIONS

6.1. TEST PROCEDURES

This section contains test results only. Details of test methods and procedures can be found in Exhibit 8 of this report

6.2. MEASUREMENT UNCERTAINTIES

The measurement uncertainties stated were calculated in accordance with requirements of UKAS Document NIS 81 with a confidence level of 95%. Please refer to Exhibit 7 for Measurement Uncertainties.

6.3. MEASUREMENT EQUIPMENT USED:

The measurement equipment used complied with the requirements of the Standards referenced in the Methods & Procedures ANSI C63.4:1992 and CISPR 16-1.

6.4. ESSENTIAL/PRIMARY FUNCTIONS AS DECLARED BY THE MANUFACTURER:

The essential function of the EUT is to correctly communicate data to and from radios over RF link.

6.4.1. RF power output @ FCC 2.1046 & 90.205

6.4.2. Limits @ FCC 90.205. Please refer to FCC CFR 47, Part 90, Subpart I, Para. 90.205 for specification details.

Please refer to FCC CFR 47, Paragraph 90.205 for power limit for frequency band:

EUT's Operating Frequency Band (MHz)	FCC Allowable Frequency band (MHz)	FCC Rules	FCC Maximum ERP Limits (Watts)
896-901 MHz	896-901	90.635	100 Watts peak ERP for mobile station.

6.4.3. Method of Measurements

Refer to Exhibit 8, § 8.1 (Conducted) and 8.2 (Radiated) of this report for measurement details

6.4.4. Test Equipment List

Test Instruments	Manufacturer	Model No.	Serial No.	Frequency Range
Attenuator(s)	Bird	DC – 22 GHz
Attenuator(s)	Weinschel Corp	24-20-34	BJ2357	DC – 8.5 GHz
Power Meter	Hewlett Packard	436A	1725A0224 9	10 kHz – 50 GHz, sensor dependent
Power Sensor	Hewlett Packard	8481A	2702A6898 3	10 MHz – 18 GHz

6.4.5. Test Arrangement

- Power at RF Power Output Terminals

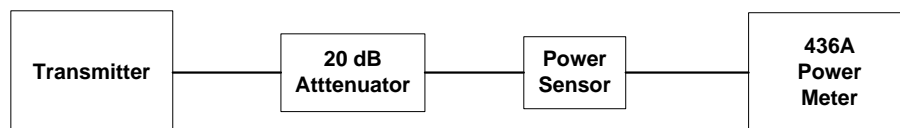

6.4.6. Test Data :

Conducted Power

High Power Setting:

Transmitter Channel Output	Fundamental Frequency (MHz)	Measured (Peak) Power (dBm)	Power Rating (dBm)
Lowest	896.0	33.29	33.0
Middle	898.5	33.29	33.0
Highest	901.0	33.31	33.0

Low Power Setting:

Transmitter Channel Output	Fundamental Frequency (MHz)	Measured (Peak) Power (dBm)	Power Rating (dBm)
Lowest	896.0	15.18	15.0
Middle	898.5	15.18	15.0
Highest	901.0	15.18	15.0

6.5. RF EXPOSURE REQUIREMENTS @ 1.1310 & 2.1091

6.5.1. Limits

- **FCC 1.1310**:- The criteria listed in the following table shall be used to evaluate the environmental impact of human exposure to radio-frequency (RF) radiation as specified in 1.1307(b).

LIMITS FOR MAXIMUM PERMISSIBLE EXPOSURE (MPE)

Frequency Range (MHz)	Electric Field Strength (V/m)	Magnetic Field Strength (A/m)	Power Density (mW/cm ²)	Average Time (minutes)
(A) Limits for Occupational/Control Exposures				
300-1500	F/300	6
(B) Limits for General Population/Uncontrolled Exposure				
300-1500	F/1500	6

F = Frequency in MHz

6.5.2. Method of Measurements

Refer to FCC @ 1.1310 & 2.1091

In order to demonstrate compliance with MPE requirements (see Section 2.1091), the following information is typically needed:

- (1) Calculation that estimates the minimum separation distance (20 cm or more) between an antenna and persons required to satisfy power density limits defined for free space.
- (2) Antenna installation and device operating instructions for installers (professional/unskilled users), and the parties responsible for ensuring compliance with the RF exposure requirement
- (3) Any caution statements and/or warning labels that are necessary in order to comply with the exposure limits
- (4) Any other RF exposure related issues that may affect MPE compliance

- *All test results contained in this engineering test report are traceable to National Institute of Standards and Technology (NIST)*

Calculation Method of RF Safety Distance:

$$S = PG/4\pi r^2 = EIRP/4\pi r^2$$

Where: P: power input to the antenna in mW
EIRP: Equivalent (effective) isotropic radiated power.
S: power density mW/cm²
G: numeric gain of antenna relative to isotropic radiator
r: distance to centre of radiation in cm

FCC radio frequency exposure limits may be exceeded at distances closer than r cm from the antenna of this device

$$r = \sqrt{PG/4\pi S}$$

FCC radio frequency exposure limits may not be exceeded at distances closer than r cm from the antenna of this device

For portable transmitters (see Section 2.1093), or devices designed to operate next to a person's body, compliance is determined with respect to the SAR limit (define in the body tissues) for near-field exposure conditions. If the maximum average output power, operating condition configurations and exposure conditions are comparable to those of existing cellular and PCS phones., an SAR evaluation may be required in order to determine if such a device complies with SAR limit. When SAR evaluation data is not available, and the additional supporting information cannot assure compliance, the Commission may request that an SAR evaluation be performed, as provided for in Section 1.1307(d)

6.5.3. Test Data

Antenna Gain Limit specified by Manufacturer: 5.0 dBi maximum

Lowest Channel Frequency (MHz)	Measured Maximum Peak RF Conducted Power (Watts)	Calculated Average RF Conducted Power with 30% Duty Cycle (Watts)	Calculated Average EIRP (Watts)	Calculated RF Safety Distance r (cm)
896	2.14	0.642	2.0	16.3

Note 1: RF EXPOSURE DISTANCE LIMITS: $r = (PG/4\Pi IS)^{1/2} = (EIRP/4\Pi IS)^{1/2}$
 $S = F/1500 = \text{lowest-f}/1500 = 896/1500 = 0.597 \text{ mW/cm}^2$

- Please refer to the Plot #1 for Duty Cycle Measurement.

Evaluation of RF Exposure Compliance Requirements	
RF Exposure Requirements	Compliance with FCC Rules
Minimum calculated separation distance between antenna and persons required: 16.3 cm	Manufacturer's instruction for separation distance between antenna and persons required: 20 cm. Please refer to the Users/ Manual and FCC RF Exposure folder
Antenna installation and device operating instructions for installers	Please refer to the Users/ Manual and FCC RF Exposure folder
Caution statements and/or warning labels that are necessary in order to comply with the exposure limits	Please refer to the Users/ Manual and FCC RF Exposure folder
Any other RF exposure related issues that may affect MPE compliance	N/A

- All test results contained in this engineering test report are traceable to National Institute of Standards and Technology (NIST)

Plot #1: Duty Cycle Measurements

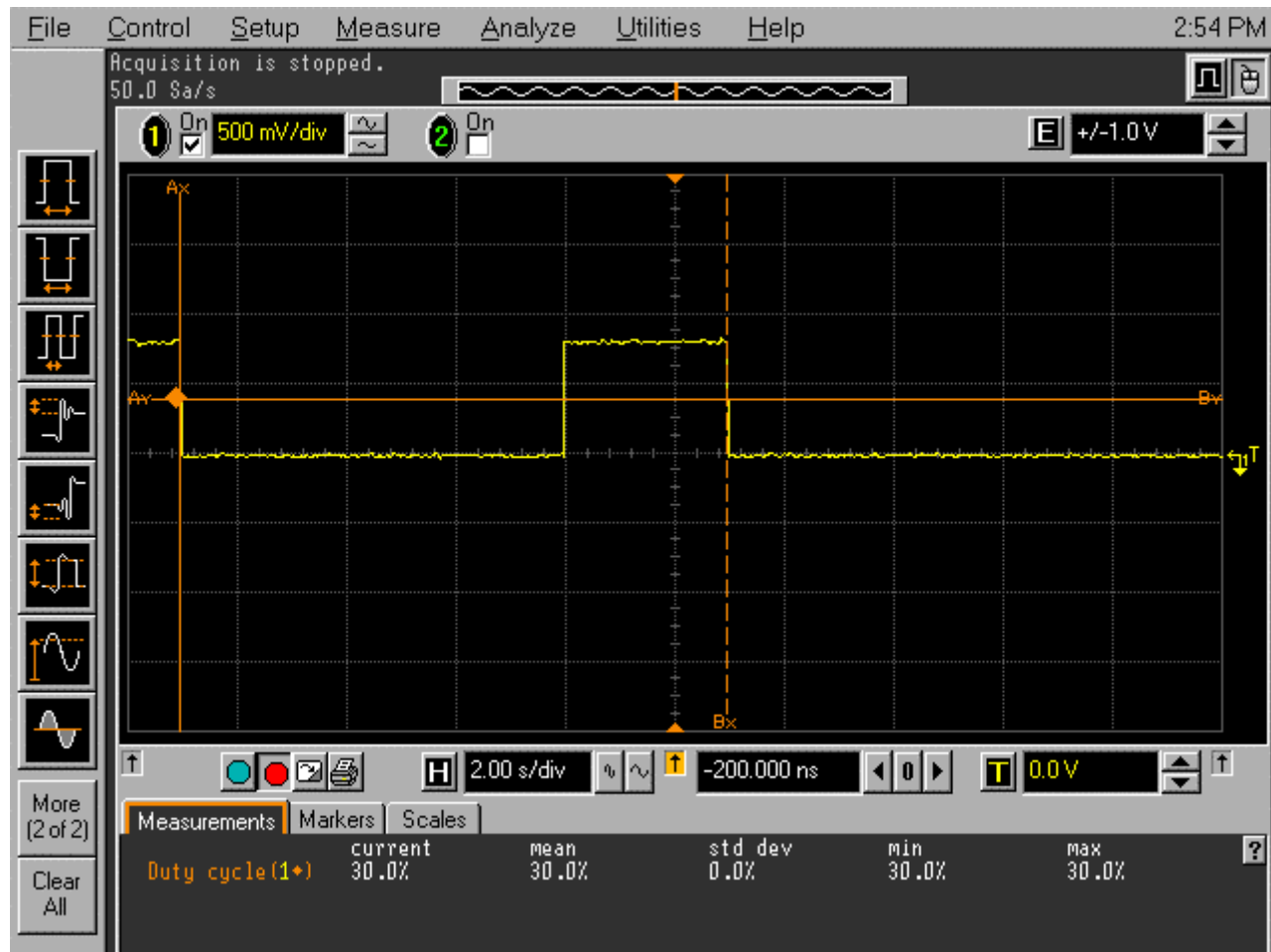

- All test results contained in this engineering test report are traceable to National Institute of Standards and Technology (NIST)

6.6. FREQUENCY STABILITY @ FCC 2.1055 & 90.213

6.6.1. Limits @ FCC 90.213

Please refer to FCC CFR 47, Part 90, Subpart I, Para. 90.213 for specification details.

FREQUENCY RANGE (MHz)	FIXED & BASE STATIONS (ppm)	MOBILE STATIONS (ppm)
896-901	0.1	≤ 2 W 1.5

6.6.2. Method of Measurements

Refer to Exhibit 8, § 8.3 of this report for measurement details

6.6.3. Test Equipment List

Test Instruments	Manufacturer	Model No.	Serial No.	Frequency Range
EMI Receiver/ EMI Receiver	Hewlett Packard	HP 8593EM	3412A00103	9 kHz – 26.5 GHz
Attenuator(s)	Bird	DC – 22 GHz
Temperature & Humidity Chamber	Tenney	T5	9723B	-40° to +60° C range

6.6.4. Test Arrangement

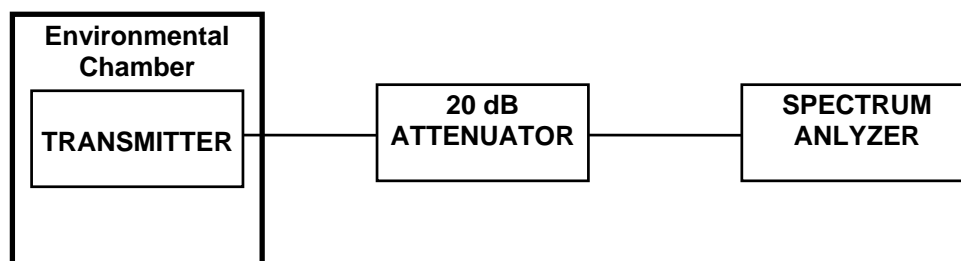

6.6.5. Test Data

Product Name:	Boomer-III Mobitex Wireless OEM Modem Module
Model No.:	BM3-900M
Center Frequency:	896 MHz
Full Power Level:	33 dBm
Frequency Tolerance Limit:	± 1.5 ppm or ± 1344 Hz at 896 MHz
Max. Frequency Tolerance Measured:	-0.73 ppm or -662 Hz
Input Voltage Rating:	3.8 VDC

CENTER FREQUENCY & RF POWER OUTPUT VARIATION			
Ambient Temperature (°C)	Supply Voltage (Nominal)	Supply Voltage (85% of Nominal)	Supply Voltage (115% of Nominal)
	3.8 Volts Hz	3.2 Volts Hz	4.4 Volts Hz
-30	515	N/A	N/A
-25	233	N/A	N/A
-20	-304	N/A	N/A
-15	-614	N/A	N/A
-10	-662	N/A	N/A
-5	-586	N/A	N/A
0	-456	N/A	N/A
+5	-273	N/A	N/A
+10	-166	N/A	N/A
+15	-79	N/A	N/A
+20	-6	+14	+22
+25	-7	N/A	N/A
+30	-56	N/A	N/A
+35	-75	N/A	N/A
+45	-64	N/A	N/A
+50	-3	N/A	N/A
+55	55	N/A	N/A
+60	185	N/A	N/A

ULTRATECH GROUP OF LABS

3000 Bristol Circle, Oakville, Ontario, Canada L6H 6G4
 Tel. #: 905-829-1570, Fax. #: 905-829-8050, Email: vic@ultratech-labs.com, Website: <http://www.ultratech-labs.com>

File #: WTP015QFCC90
 October 01, 2003

- All test results contained in this engineering test report are traceable to National Institute of Standards and Technology (NIST)

6.7. MODULATION LIMITING @ FCC 2.1047(B) & 90.210

6.7.1. Limits @ FCC 2.1047(b) and 90.210

Recommended frequency deviation characteristics are given below:

- 2.5 kHz for 12.5 kHz Channel Spacing
- 5 kHz for 25 kHz Channel Spacing System

6.7.2. Method of Measurements

For Audio Transmitter:- The carrier frequency deviation was measured with the tone input signal level varied from 0 Vp to audio input rating level plus 16 dB at frequencies 0.1, 0.5, 1.0, 3.0 and 5.0 kHz. The maximum deviation was recorded at each test condition.

For Data Transmitter with Maximum Frequency Deviation set by Factory:- The EUT was set at maximum frequency deviation, and its peak frequency deviation was then measured using EUT's internal random data source.

6.7.3. Test Equipment List

Test Instruments	Manufacturer	Model No.	Serial No.	Frequency Range
Communication Analyzer	Rohde & Schawrz	SMF02	879988/057	400 kHz - 1000 MHz including AF & RF Signal Generators, SINAD, DISTORTION, DEVIATION meters and etc

6.7.4. Test Arrangement

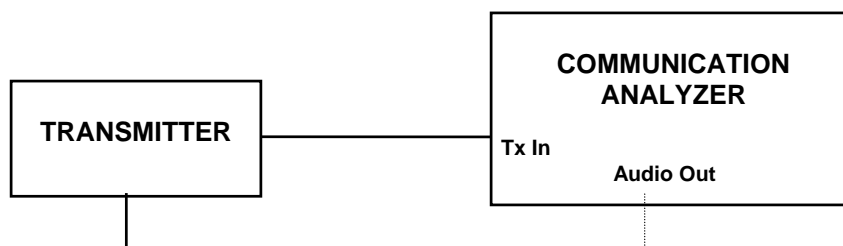

6.7.5. Test Data

6.7.5.1. *Data Modulation Limiting: FM modulation with random data and Modulation Limiter set at a Maximum Frequency Deviation (Factory Setting).*

Data Baud Rate	Peak Deviation (kHz)	Maximum Limit (kHz)
8000	2.0	2.5

6.8. 99% OCCUPIED BANDWIDTH & EMISSION MASK @ FCC 2.1049, 90.209 & 90.210

6.8.1. Limits @ FCC 90.209 & 90.210

Emissions shall be attenuated below the mean output power of the transmitter as follows:

FREQUENCY RANGE (MHz)	Maximum Authorized BW (KHz)	CHANNEL SPACING (KHz)	Recommended Max. FREQ. DEVIATION (KHz)	FCC APPLICABLE MASK @ FCC 90.210
896-901	13.6	12.5	2.5	MASK J (Data)

6.8.2. Method of Measurements

Refer to Exhibit 8, § 8.4 of this report for measurement details

6.8.3. Test Equipment List

Test Instruments	Manufacturer	Model No.	Serial No.	Frequency Range
EMI Receiver/ EMI Receiver	Hewlett Packard	HP 8593EM	3412A00103	9 kHz – 26.5 GHz
Attenuator(s)	Bird	DC – 22 GHz
Audio Oscillator	Hewlett Packard	HP 204C	0989A08798	DC to 1.2 MHz

6.8.4. Test Arrangement

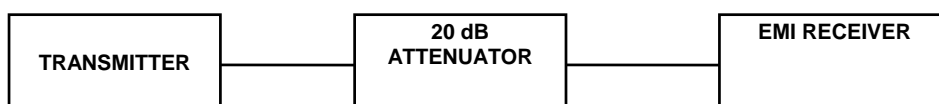

6.8.5. Test Data

6.8.5.1. 99% Occupied Bandwidth

Frequency (MHz)	Channel Spacing (kHz)	Measured 99% OBW (kHz)	Recommended 99% OBW (kHz)
896.0	12.5	7.88	13.6
898.5	12.5	7.90	13.6
901.0	12.5	7.97	13.6

Please refer plot # 2 to 4 for details of measurement.

6.8.5.2. Emission Masks

Conform.

- Please refer to Plots # 5 to 7 for Emission Mask J with GMSK Modulation in High Transmitter O/p Power.
- Please refer to Plots # 8 to 10 for Emission Mask J with GMSK Modulation in Low Transmitter O/p Power.

Note : The significant difference between the measured 99% Bandwidth and calculated emission designation is due to the GMSK modulation signal having a $BT=0.3$ which means there is a reasonable amount of filtering of the 8kHz data signal which limits the bandwidth it would otherwise occupy and which the FCC formula does not take into account.

Plot # 2 : 99% OBW, RF Output
Frequency: 896 MHz, Modulation: 2-Level 8kbps GMSK

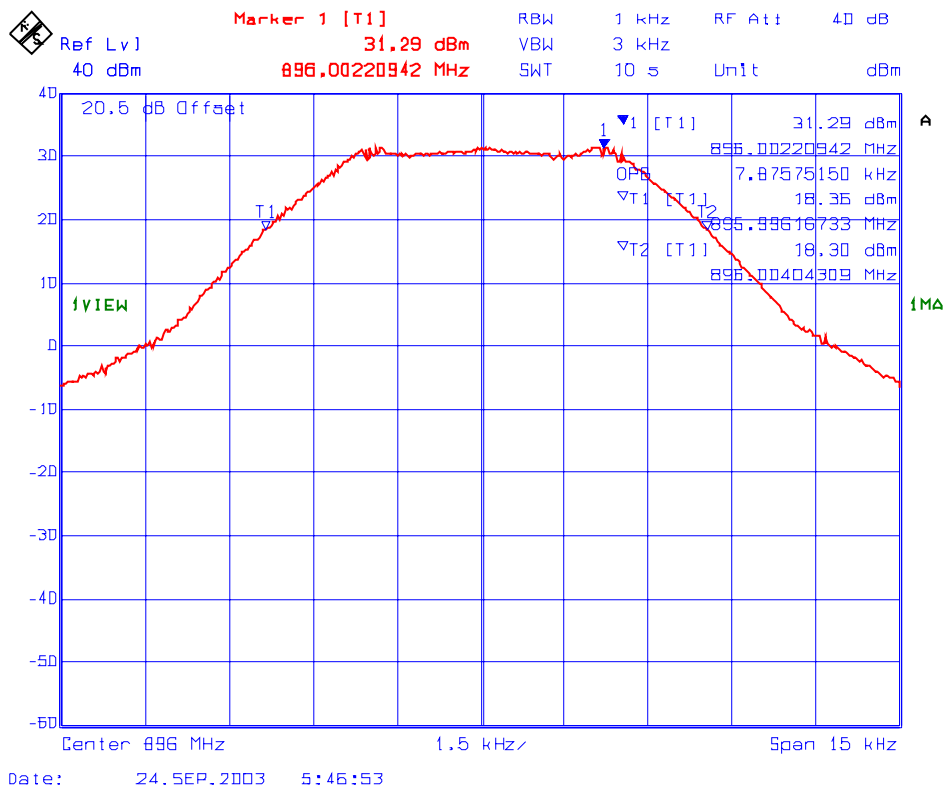

ULTRATECH GROUP OF LABS

3000 Bristol Circle, Oakville, Ontario, Canada L6H 6G4
 Tel. #: 905-829-1570, Fax. #: 905-829-8050, Email: vic@ultratech-labs.com, Website: <http://www.ultratech-labs.com>

File #: WTP015QFCC90
 October 01, 2003

- All test results contained in this engineering test report are traceable to National Institute of Standards and Technology (NIST)

Plot # 3 : 99% OBW, RF Output
Frequency: 898.5 MHz, Modulation: 2-Level 8kpbs GMSK

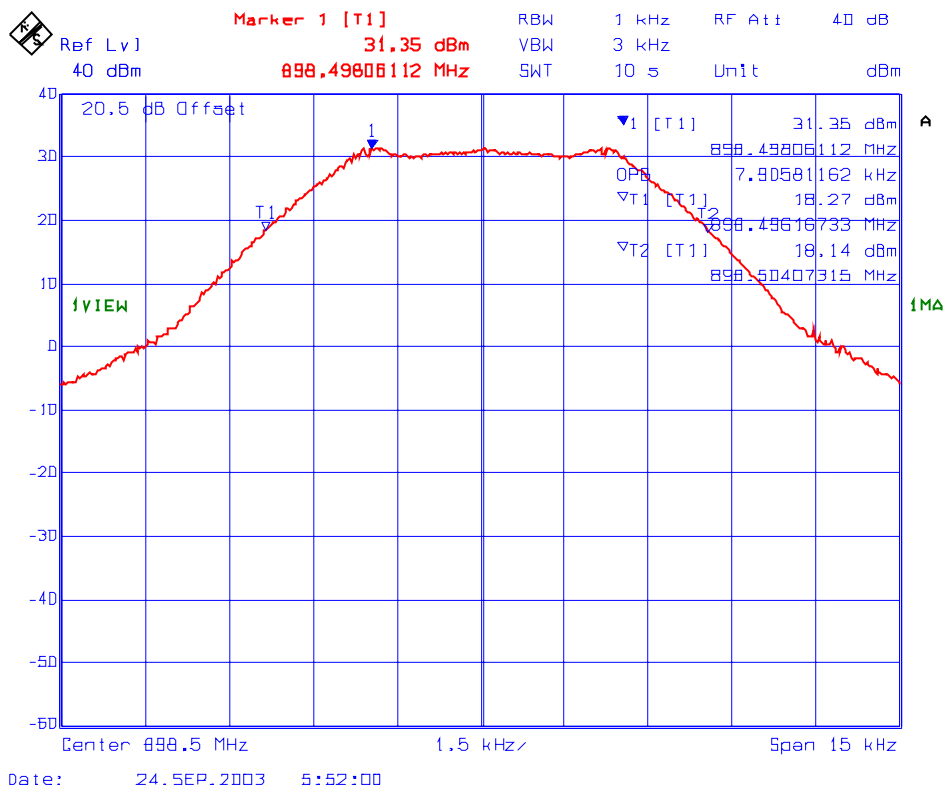

ULTRATECH GROUP OF LABS

3000 Bristol Circle, Oakville, Ontario, Canada L6H 6G4
 Tel. #: 905-829-1570, Fax. #: 905-829-8050, Email: vic@ultratech-labs.com, Website: <http://www.ultratech-labs.com>

File #: WTP015QFCC90
 October 01, 2003

- All test results contained in this engineering test report are traceable to National Institute of Standards and Technology (NIST)

Plot # 4 : 99% OBW, RF Output
Frequency: 901 MHz, Modulation: 2-Level 8kbps GMSK

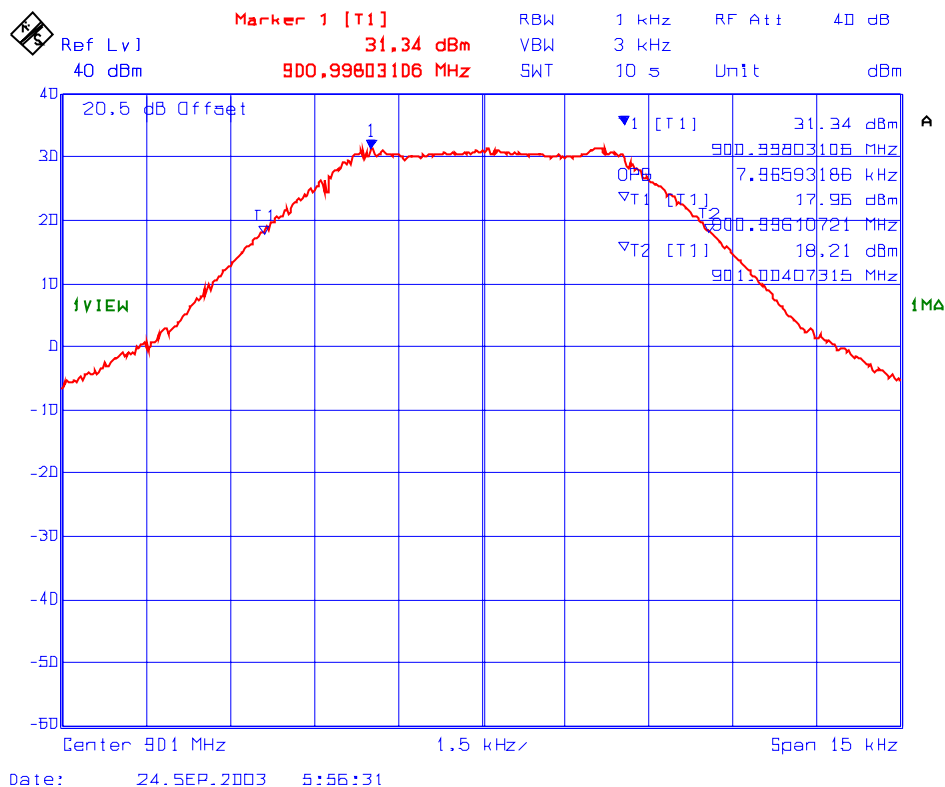

ULTRATECH GROUP OF LABS

3000 Bristol Circle, Oakville, Ontario, Canada L6H 6G4
 Tel. #: 905-829-1570, Fax. #: 905-829-8050, Email: vic@ultratech-labs.com, Website: <http://www.ultratech-labs.com>

File #: WTP015QFCC90
 October 01, 2003

- All test results contained in this engineering test report are traceable to National Institute of Standards and Technology (NIST)

Plot # 5 : Emission Mask J , RF Output, High Power Setting
Frequency: 896 MHz, Modulation: 2-Level 8kbps GMSK

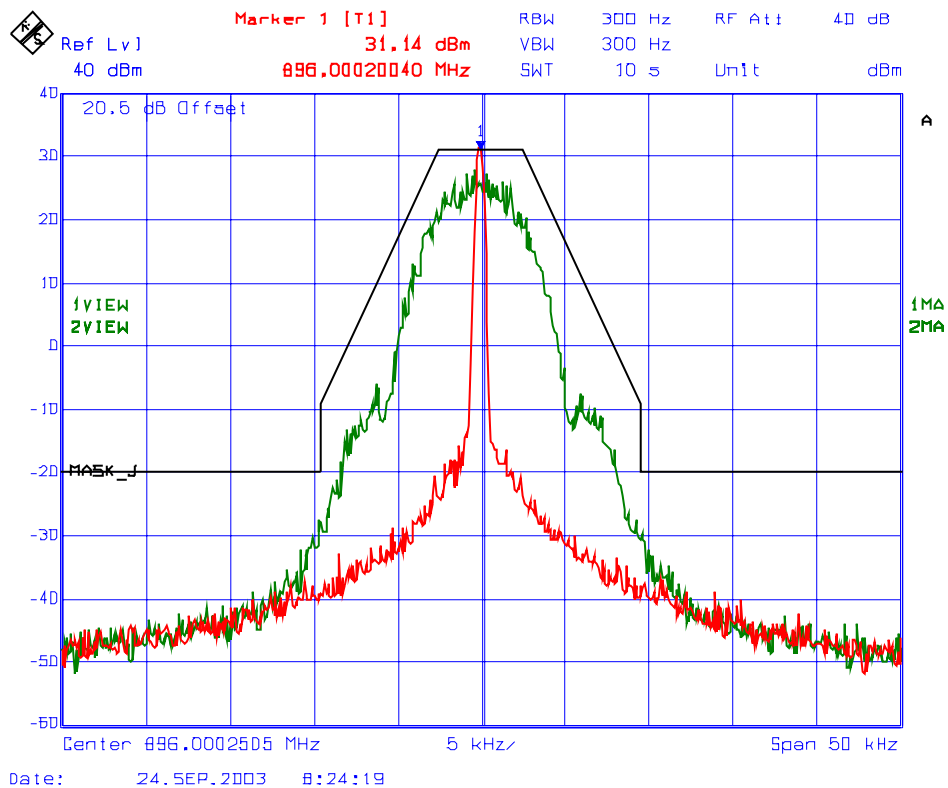

ULTRATECH GROUP OF LABS

3000 Bristol Circle, Oakville, Ontario, Canada L6H 6G4
Tel. #: 905-829-1570, Fax. #: 905-829-8050, Email: vic@ultratech-labs.com, Website: <http://www.ultratech-labs.com>

File #: WTP015QFCC90
October 01, 2003

- All test results contained in this engineering test report are traceable to National Institute of Standards and Technology (NIST)

Plot # 6 : Emission Mask J , , RF Output, High Power Setting
Frequency: 898.5 MHz, Modulation: 2-Level 8kbps GMSK

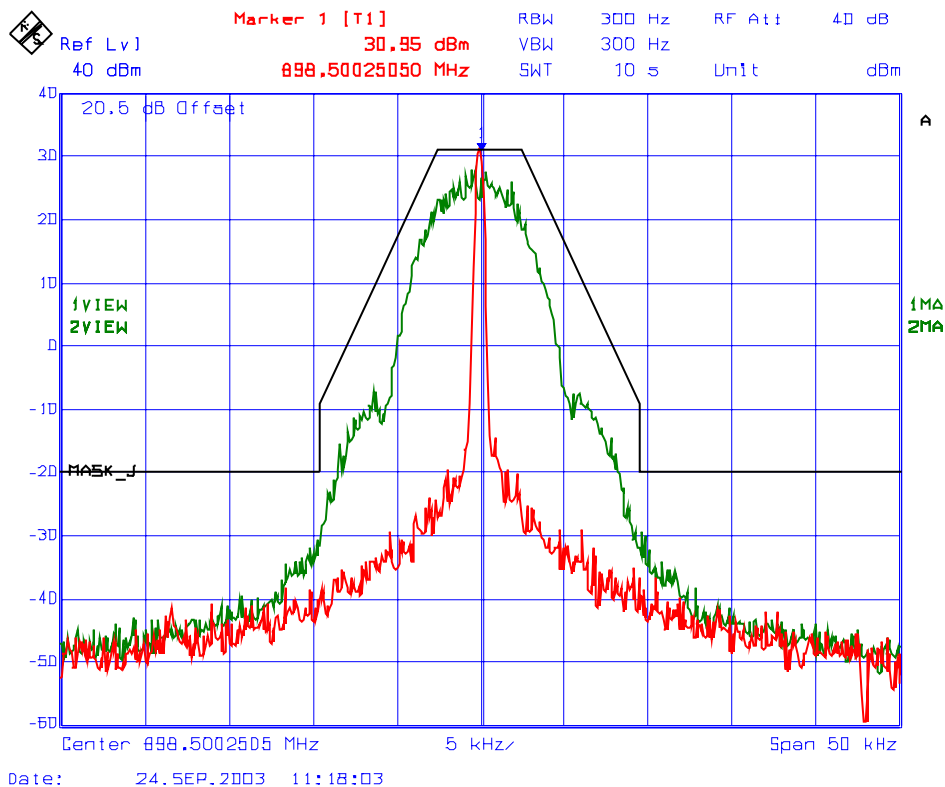

ULTRATECH GROUP OF LABS

3000 Bristol Circle, Oakville, Ontario, Canada L6H 6G4
Tel. #: 905-829-1570, Fax. #: 905-829-8050, Email: vic@ultratech-labs.com, Website: <http://www.ultratech-labs.com>

File #: WTP015QFCC90
October 01, 2003

- All test results contained in this engineering test report are traceable to National Institute of Standards and Technology (NIST)

Plot # 7 : Emission Mask J , , RF Output, High Power Setting
Frequency: 901 MHz, Modulation: 2-Level 8kbps GMSK

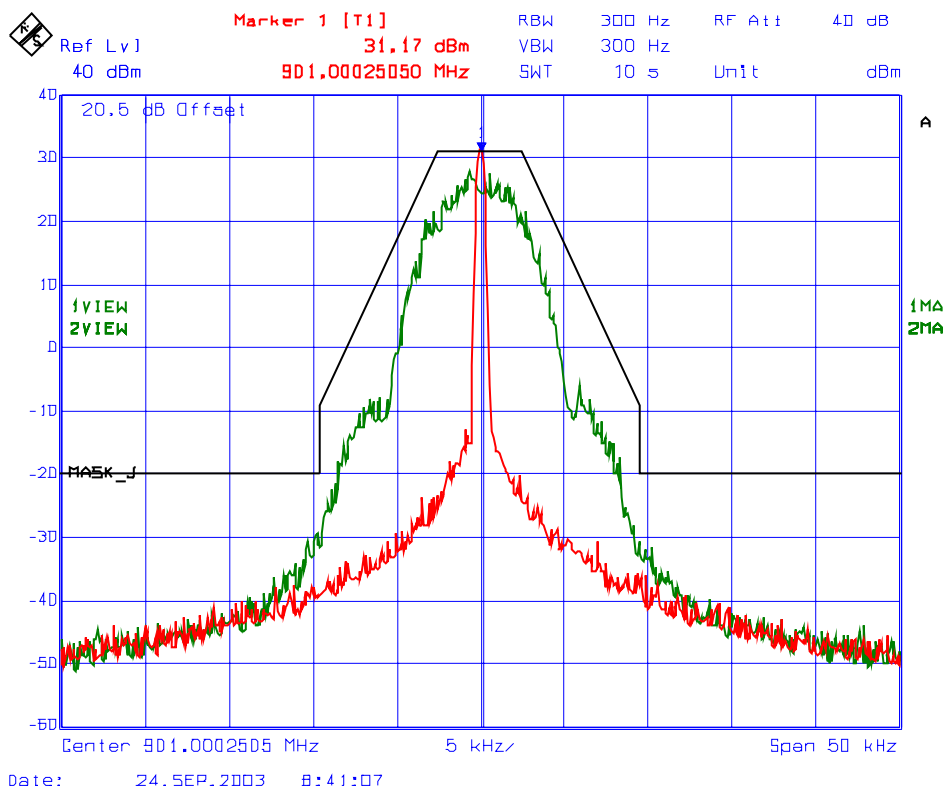

ULTRATECH GROUP OF LABS

3000 Bristol Circle, Oakville, Ontario, Canada L6H 6G4
Tel. #: 905-829-1570, Fax. #: 905-829-8050, Email: vic@ultratech-labs.com, Website: <http://www.ultratech-labs.com>

File #: WTP015QFCC90
October 01, 2003

- All test results contained in this engineering test report are traceable to National Institute of Standards and Technology (NIST)

Plot # 8 : Emission Mask J , , RF Output, Low Power Setting
Frequency: 896 MHz, Modulation: 2-Level 8kbps GMSK

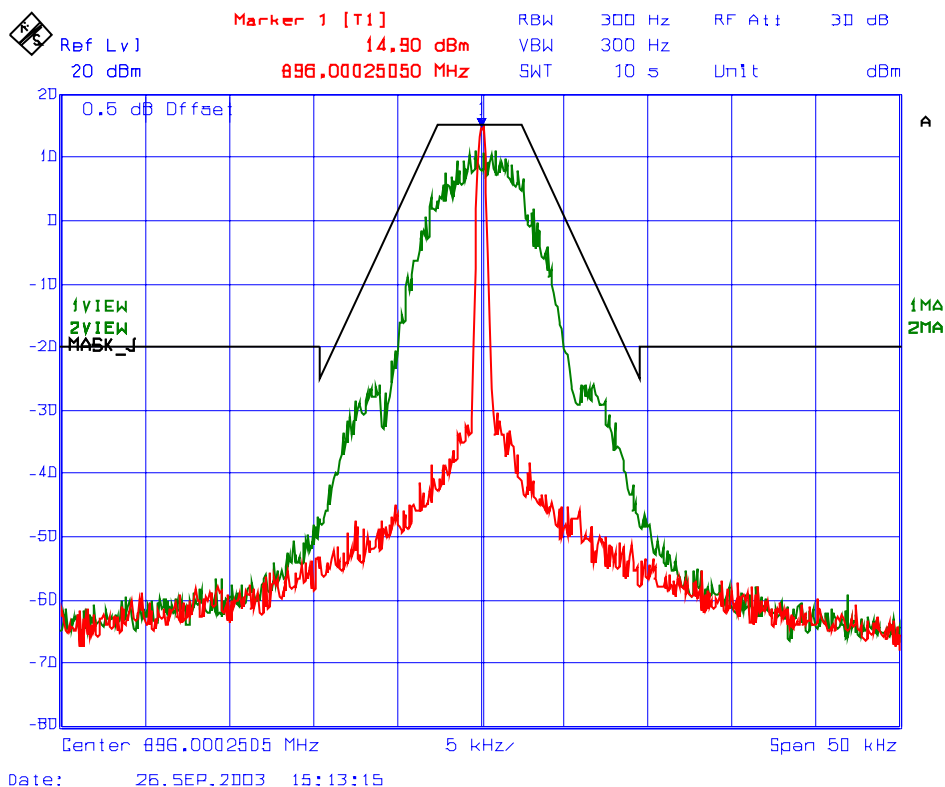

ULTRATECH GROUP OF LABS

3000 Bristol Circle, Oakville, Ontario, Canada L6H 6G4
Tel. #: 905-829-1570, Fax. #: 905-829-8050, Email: vic@ultratech-labs.com, Website: <http://www.ultratech-labs.com>

File #: WTP015QFCC90
October 01, 2003

- All test results contained in this engineering test report are traceable to National Institute of Standards and Technology (NIST)

Plot # 9 : Emission Mask J , , RF Output, Low Power Setting
Frequency: 898.5 MHz, Modulation: 2-Level 8kbps GMSK

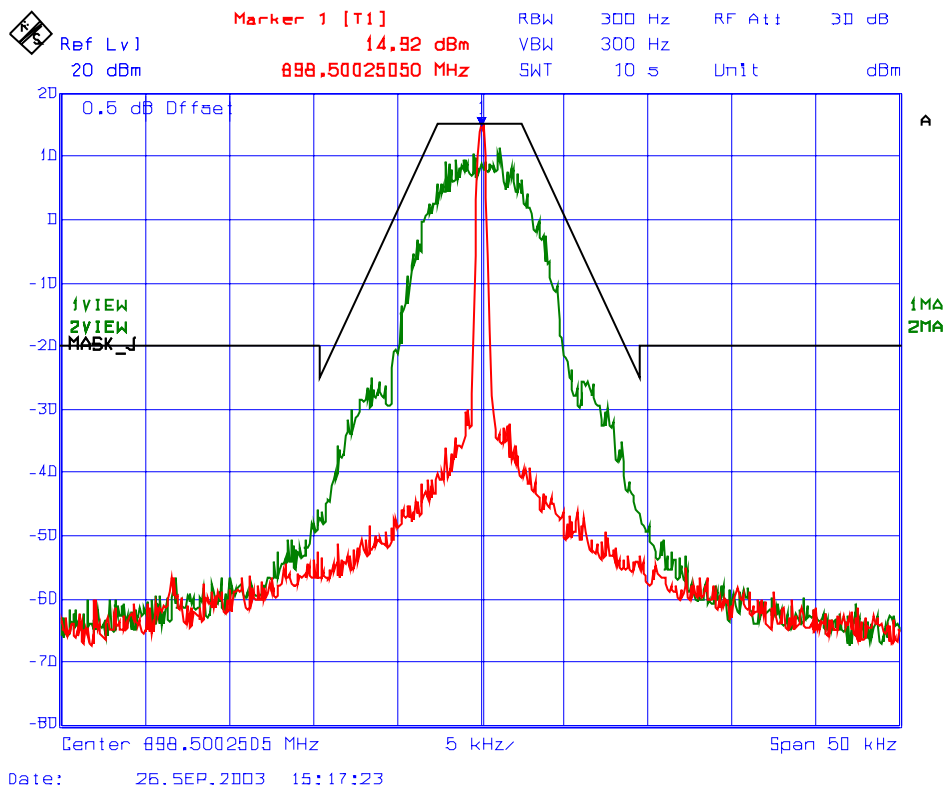

ULTRATECH GROUP OF LABS

3000 Bristol Circle, Oakville, Ontario, Canada L6H 6G4
Tel. #: 905-829-1570, Fax. #: 905-829-8050, Email: vic@ultratech-labs.com, Website: <http://www.ultratech-labs.com>

File #: WTP015QFCC90
October 01, 2003

- All test results contained in this engineering test report are traceable to National Institute of Standards and Technology (NIST)

Plot # 10 : Emission Mask J , , RF Output, Low Power Setting
Frequency: 901 MHz, Modulation: 2-Level 8kbps GMSK

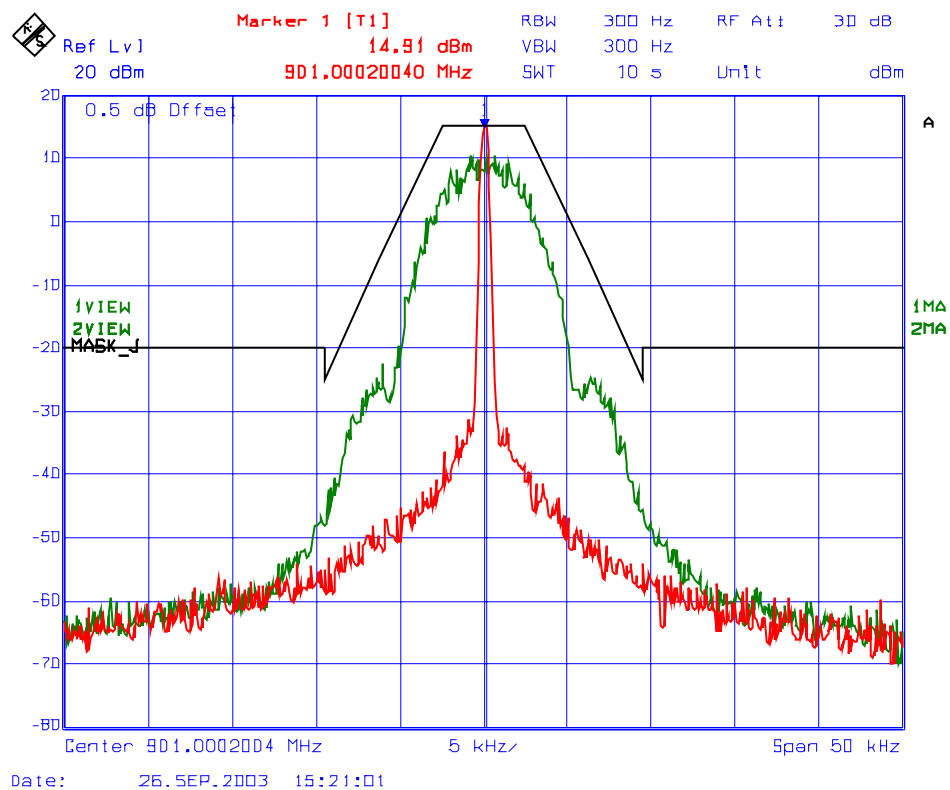

ULTRATECH GROUP OF LABS

3000 Bristol Circle, Oakville, Ontario, Canada L6H 6G4
Tel. #: 905-829-1570, Fax. #: 905-829-8050, Email: vic@ultratech-labs.com, Website: <http://www.ultratech-labs.com>

File #: WTP015QFCC90
October 01, 2003

- All test results contained in this engineering test report are traceable to National Institute of Standards and Technology (NIST)

6.9. TRANSMITTER ANTENNA POWER SPURIOUS/HARMONIC CONDUCTED EMISSIONS @ FCC 90.210

6.9.1. Limits @ 90.210

Emissions shall be attenuated below the mean output power of the transmitter as follows:

Frequency Band	Frequency Range	Attenuation Limit (dBc)
896-901MHz	10 MHz to Lowest frequency of the radio to 10 th harmonic of the highest frequency of the radio	50+10*log(P) or -20 dBm or 70 dBc whichever is less

6.9.2. Method of Measurements

Refer to Exhibit 8 § 8.5 of this report for measurement details

6.9.3. Test Equipment List

Test Instruments	Manufacturer	Model No.	Serial No.	Frequency Range
EMI Receiver/ EMI Receiver	Hewlett Packard	HP 8593EM	3412A00103	9 kHz – 26.5 GHz
Attenuator(s)	Bird	DC – 22 GHz
Audio Oscillator	Hewlett Packard	HP 204C	0989A08798	DC to 1.2 MHz
Highpass Filter, Microphase	Microphase	CR220HID	IIT111000AC	Cut-off Frequency at 600 MHz, 1.3 GHz or 4 GHz

6.9.4. Test Arrangement

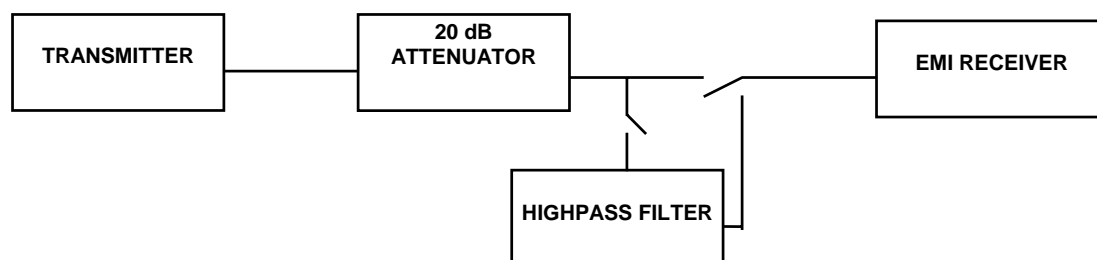

6.9.5. Test Data

6.9.5.1. High Power Setting (2 Watts) at Lowest Frequency (896 MHz)

Fundamental Frequency:	896 MHz				
RF Output Power:	33.3 dBm (Conducted)				
Modulation:	2 level 8kbps GMSK				
FREQUENCY (MHz)	TRANSMITTER CONDUCTED ANTENNA EMISSIONS		LIMIT (dBc)	MARGIN (dB)	PASS/ FAIL
	(dBm)	(dBc)			
4480.9	-37.4	-70.7	-53.3	-17.4	PASS
5382.7	-27.8	-61.1	-53.3	-7.8	PASS
6266.5	-31.6	-64.9	-53.3	-11.6	PASS
<ul style="list-style-type: none"> ** The emissions were scanned from 10 MHz to 10 GHz and all emissions within 20 dB below the limits were recorded. Please refer to plots # 11 & 12 for details of measurement. 					

6.9.5.2. High Power Setting (2 Watts) at Middle Frequency (898.5 MHz)

Fundamental Frequency:	898.5 MHz				
RF Output Power:	33.3 dBm (Conducted)				
Modulation:	2 level 8kbps GMSK				
FREQUENCY (MHz)	TRANSMITTER CONDUCTED ANTENNA EMISSIONS		LIMIT (dBc)	MARGIN (dB)	PASS/ FAIL
	(dBm)	(dBc)			
4499.0	-37.4	-70.7	-53.3	-17.4	PASS
5382.7	-28.0	-61.3	-53.3	-8.0	PASS
6284.5	-31.5	-64.8	-53.3	-11.5	PASS
<ul style="list-style-type: none"> ** The emissions were scanned from 10 MHz to 10 GHz and all emissions within 20 dB below the limits were recorded. Please refer to plots # 13 & 14 for details of measurement. 					

6.9.5.3. High Power Setting (2 Watts) at Highest Frequency (901 MHz)

Fundamental Frequency:	901 MHz				
RF Output Power:	33.3 dBm (Conducted)				
Modulation:	2 level 8kbps GMSK				
FREQUENCY (MHz)	TRANSMITTER CONDUCTED ANTENNA EMISSIONS		LIMIT (dBc)	MARGIN (dB)	PASS/ FAIL
	(dBm)	(dBc)			
4499.0	-37.7	-71.0	-53.3	-17.7	PASS
5400.8	-27.6	-60.9	-53.3	-7.6	PASS
6302.6	-31.6	-64.9	-53.3	-11.6	PASS
<ul style="list-style-type: none"> ** The emissions were scanned from 10 MHz to 10 GHz and all emissions within 20 dB below the limits were recorded. Please refer to plots # 15 & 16 for details of measurement. 					

ULTRATECH GROUP OF LABS

3000 Bristol Circle, Oakville, Ontario, Canada L6H 6G4
 Tel. #: 905-829-1570, Fax. #: 905-829-8050, Email: vic@ultratech-labs.com, Website: <http://www.ultratech-labs.com>

File #: WTP015QFCC90
 October 01, 2003

- All test results contained in this engineering test report are traceable to National Institute of Standards and Technology (NIST)

6.9.5.4. Low Power Setting (0.033 Watts) at Lowest Frequency (896 MHz)

Fundamental Frequency:		896 MHz			
RF Output Power:		15.2 dBm (Conducted)			
Modulation:		2 level 8kbps GMSK			
FREQUENCY (MHz)	TRANSMITTER CONDUCTED ANTENNA EMISSIONS		LIMIT (dBc)	MARGIN (dB)	PASS/ FAIL
	(dBm)	(dBc)			
1793.6	-42.6	-57.8	-35.2	-22.6	PASS
6266.5	-38.1	-53.3	-35.2	-18.1	PASS
<ul style="list-style-type: none"> ** The emissions were scanned from 10 MHz to 10 GHz and all emissions within 20 dB below the limits were recorded. Please refer to plots # 17 & 18 for details of measurement. 					

6.9.5.5. Low Power Setting (0.033 Watts) at Middle Frequency (898.5 MHz)

Fundamental Frequency:		898.5 MHz			
RF Output Power:		15.2 dBm (Conducted)			
Modulation:		2 level 8kbps GMSK			
FREQUENCY (MHz)	TRANSMITTER CONDUCTED ANTENNA EMISSIONS		LIMIT (dBc)	MARGIN (dB)	PASS/ FAIL
	(dBm)	(dBc)			
1793.6	-41.7	-56.9	-35.2	-21.7	PASS
6284.5	-38.3	-53.5	-35.2	-18.3	PASS
<ul style="list-style-type: none"> ** The emissions were scanned from 10 MHz to 10 GHz and all emissions within 20 dB below the limits were recorded. Please refer to plots # 19 & 20 for details of measurement. 					

6.9.5.6. Low Power Setting (0.033 Watts) at Highest Frequency (901 MHz)

Fundamental Frequency:		901 MHz			
RF Output Power:		15.2 dBm (Conducted)			
Modulation:		2 level 8kbps GMSK			
FREQUENCY (MHz)	TRANSMITTER CONDUCTED ANTENNA EMISSIONS		LIMIT (dBc)	MARGIN (dB)	PASS/ FAIL
	(dBm)	(dBc)			
1793.6	-40.5	-55.7	-35.2	-20.5	PASS
6302.6	-39.1	-54.3	-35.2	-19.1	PASS
<ul style="list-style-type: none"> ** The emissions were scanned from 10 MHz to 10 GHz and all emissions within 20 dB below the limits were recorded. Please refer to plots # 21 & 22 for details of measurement. 					

Plot # 11 : Spurious Emission Conducted at Antenna terminal, High power setting
Frequency: 896 MHz, Modulation: 2-Level 8kbps GMSK

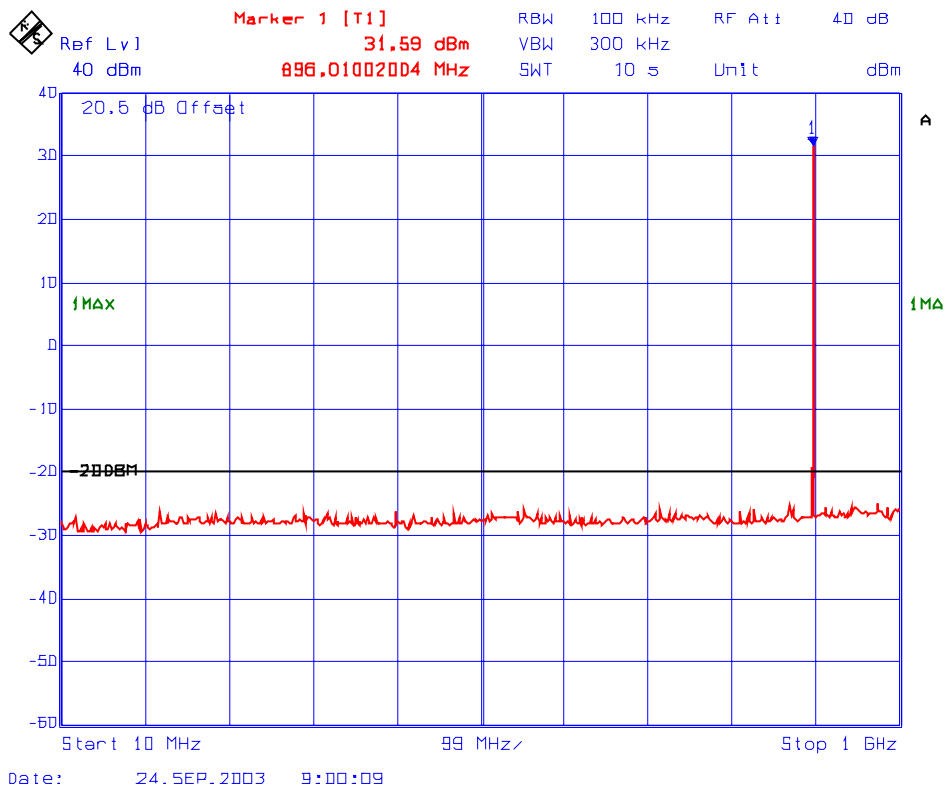

ULTRATECH GROUP OF LABS

3000 Bristol Circle, Oakville, Ontario, Canada L6H 6G4
Tel. #: 905-829-1570, Fax. #: 905-829-8050, Email: vic@ultratech-labs.com, Website: <http://www.ultratech-labs.com>

File #: WTP015QFCC90
October 01, 2003

- All test results contained in this engineering test report are traceable to National Institute of Standards and Technology (NIST)

Plot # 12 : Spurious Emission Conducted at Antenna terminal, High power setting
Frequency: 896 MHz, Modulation: 2-Level 8kbps GMSK

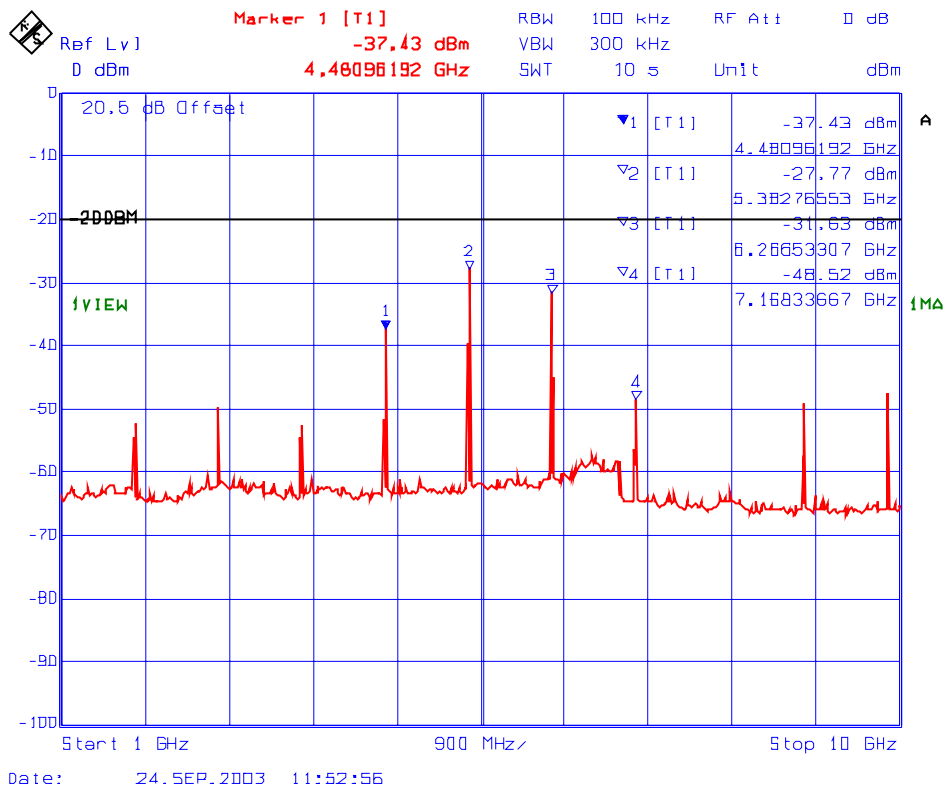

ULTRATECH GROUP OF LABS

3000 Bristol Circle, Oakville, Ontario, Canada L6H 6G4
Tel. #: 905-829-1570, Fax. #: 905-829-8050, Email: vic@ultratech-labs.com, Website: <http://www.ultratech-labs.com>

File #: WTP015QFCC90
October 01, 2003

- All test results contained in this engineering test report are traceable to National Institute of Standards and Technology (NIST)

Plot # 13 : Spurious Emission Conducted at Antenna terminal, High power setting
Frequency: 898.5 MHz, Modulation: 2-Level 8kbps GMSK

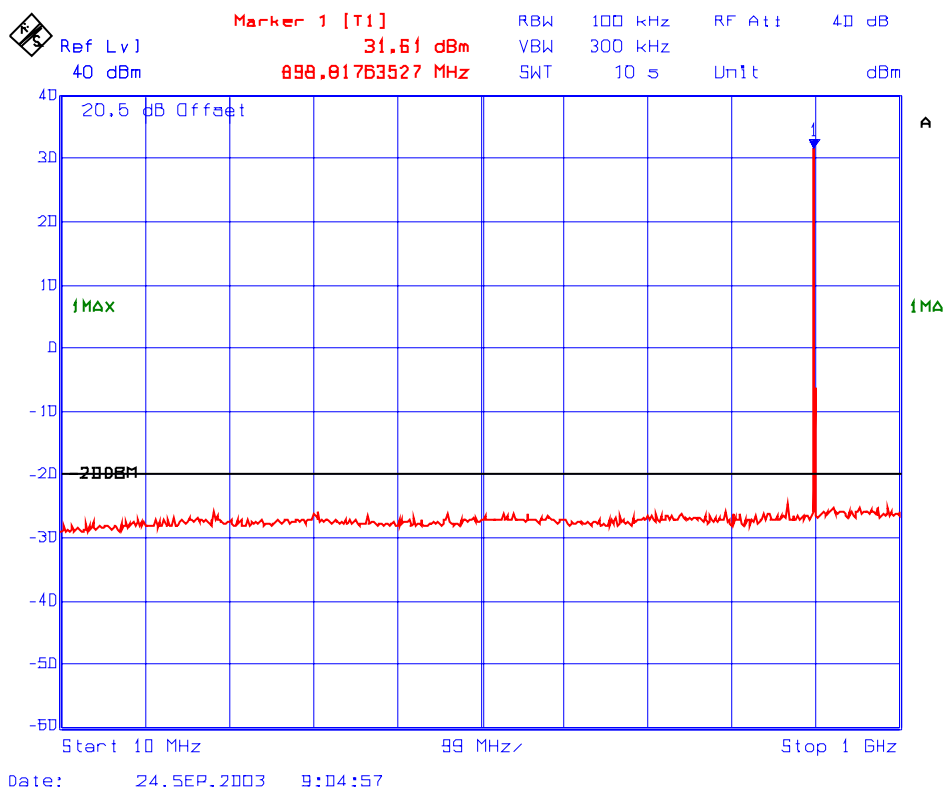

Plot # 14 : Spurious Emission Conducted at Antenna terminal, High power setting
Frequency: 898.5 MHz, Modulation: 2-Level 8kbps GMSK

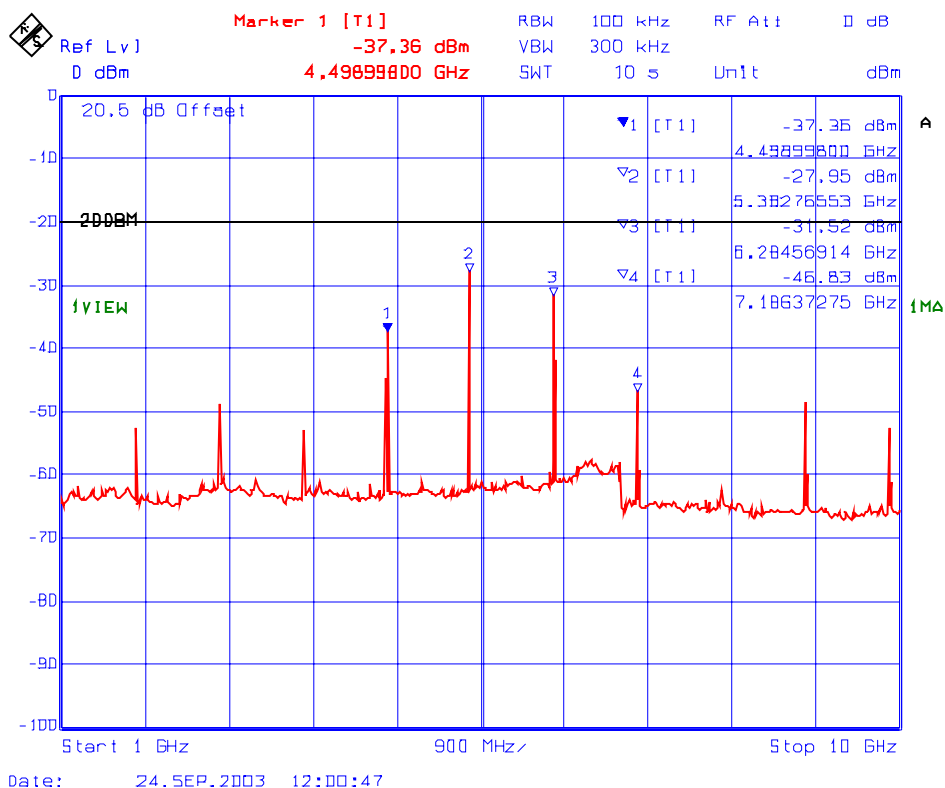

ULTRATECH GROUP OF LABS

3000 Bristol Circle, Oakville, Ontario, Canada L6H 6G4
Tel. #: 905-829-1570, Fax. #: 905-829-8050, Email: vic@ultratech-labs.com, Website: <http://www.ultratech-labs.com>

File #: WTP015QFCC90
October 01, 2003

- All test results contained in this engineering test report are traceable to National Institute of Standards and Technology (NIST)

Plot # 15 : Spurious Emission Conducted at Antenna terminal, High power setting
Frequency: 901 MHz, Modulation: 2-Level 8kbps GMSK

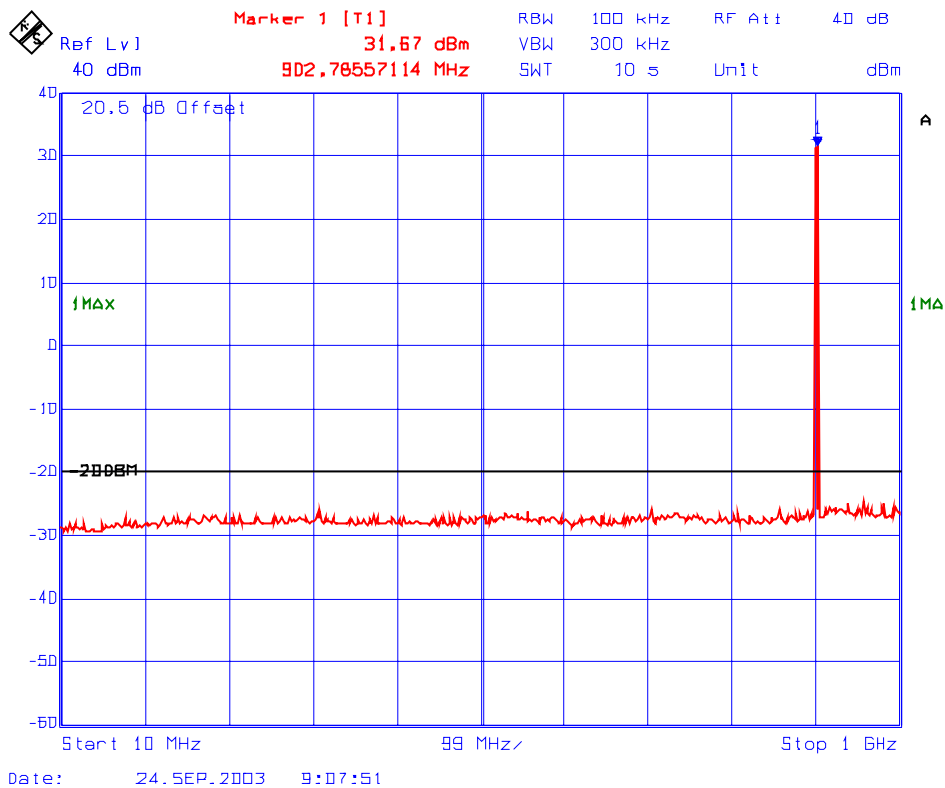

ULTRATECH GROUP OF LABS

3000 Bristol Circle, Oakville, Ontario, Canada L6H 6G4
Tel. #: 905-829-1570, Fax. #: 905-829-8050, Email: vic@ultratech-labs.com, Website: <http://www.ultratech-labs.com>

File #: WTP015QFCC90
October 01, 2003

- All test results contained in this engineering test report are traceable to National Institute of Standards and Technology (NIST)

Plot # 16 : Spurious Emission Conducted at Antenna terminal, High power setting
Frequency: 901 MHz, Modulation: 2-Level 8kbps GMSK

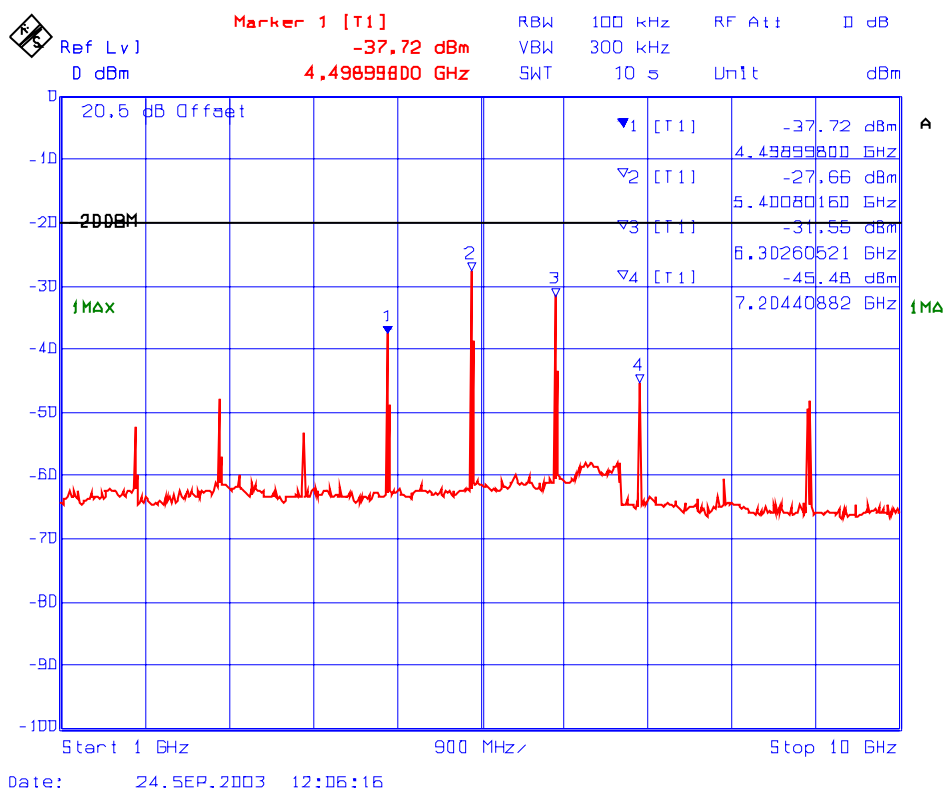

ULTRATECH GROUP OF LABS

3000 Bristol Circle, Oakville, Ontario, Canada L6H 6G4
 Tel. #: 905-829-1570, Fax. #: 905-829-8050, Email: vic@ultratech-labs.com, Website: <http://www.ultratech-labs.com>

File #: WTP015QFCC90
 October 01, 2003

- All test results contained in this engineering test report are traceable to National Institute of Standards and Technology (NIST)

Plot # 17 : Spurious Emission Conducted at Antenna terminal, Low power setting
Frequency: 896 MHz, Modulation: 2-Level 8kbps GMSK

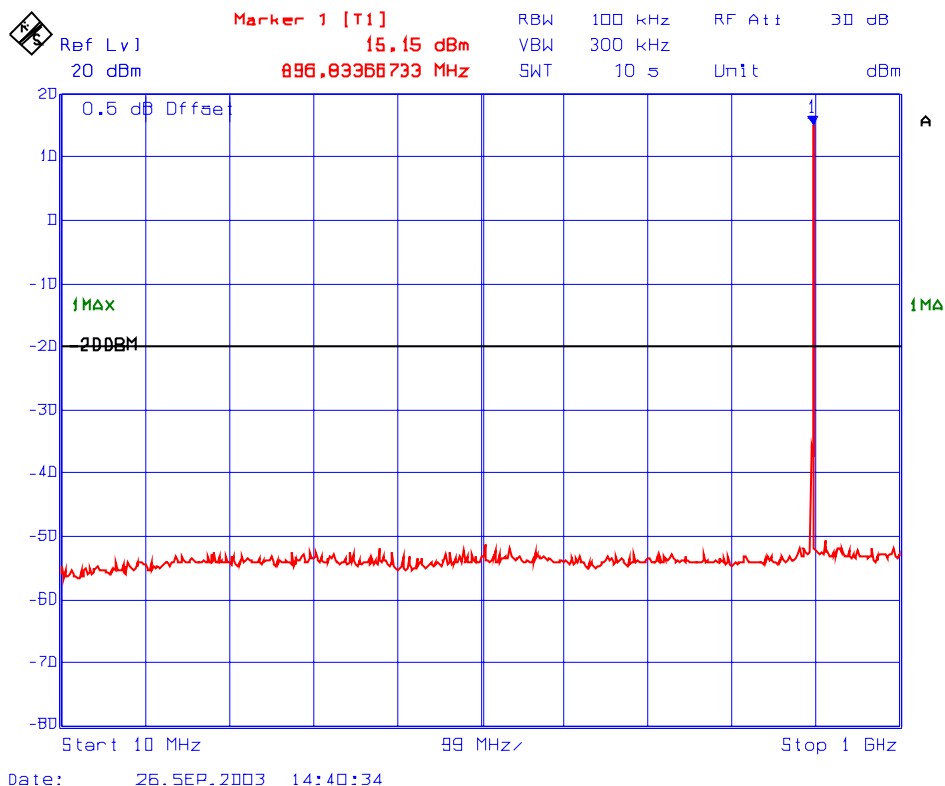

ULTRATECH GROUP OF LABS

3000 Bristol Circle, Oakville, Ontario, Canada L6H 6G4
Tel. #: 905-829-1570, Fax. #: 905-829-8050, Email: vic@ultratech-labs.com, Website: <http://www.ultratech-labs.com>

File #: WTP015QFCC90
October 01, 2003

- All test results contained in this engineering test report are traceable to National Institute of Standards and Technology (NIST)

Plot # 18 : Spurious Emission Conducted at Antenna terminal, Low power setting
Frequency: 896 MHz, Modulation: 2-Level 8kbps GMSK

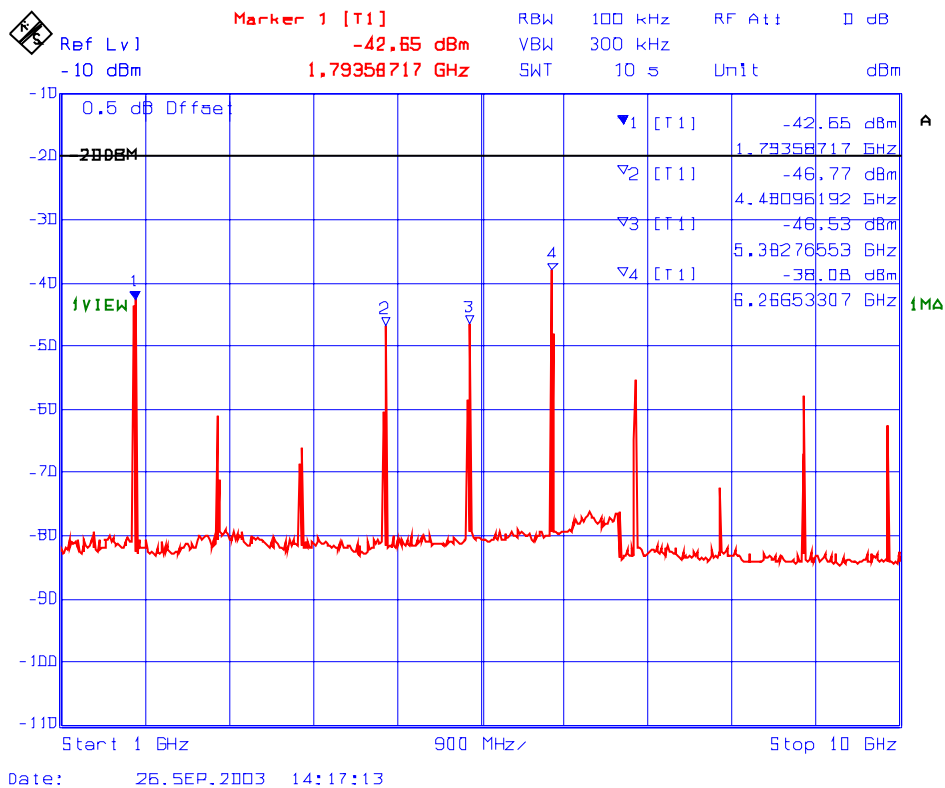

ULTRATECH GROUP OF LABS

3000 Bristol Circle, Oakville, Ontario, Canada L6H 6G4
 Tel. #: 905-829-1570, Fax. #: 905-829-8050, Email: vic@ultratech-labs.com, Website: <http://www.ultratech-labs.com>

File #: WTP015QFCC90
 October 01, 2003

- All test results contained in this engineering test report are traceable to National Institute of Standards and Technology (NIST)

Plot # 19 : Spurious Emission Conducted at Antenna terminal, Low power setting
Frequency: 898.5 MHz, Modulation: 2-Level 8kbps GMSK

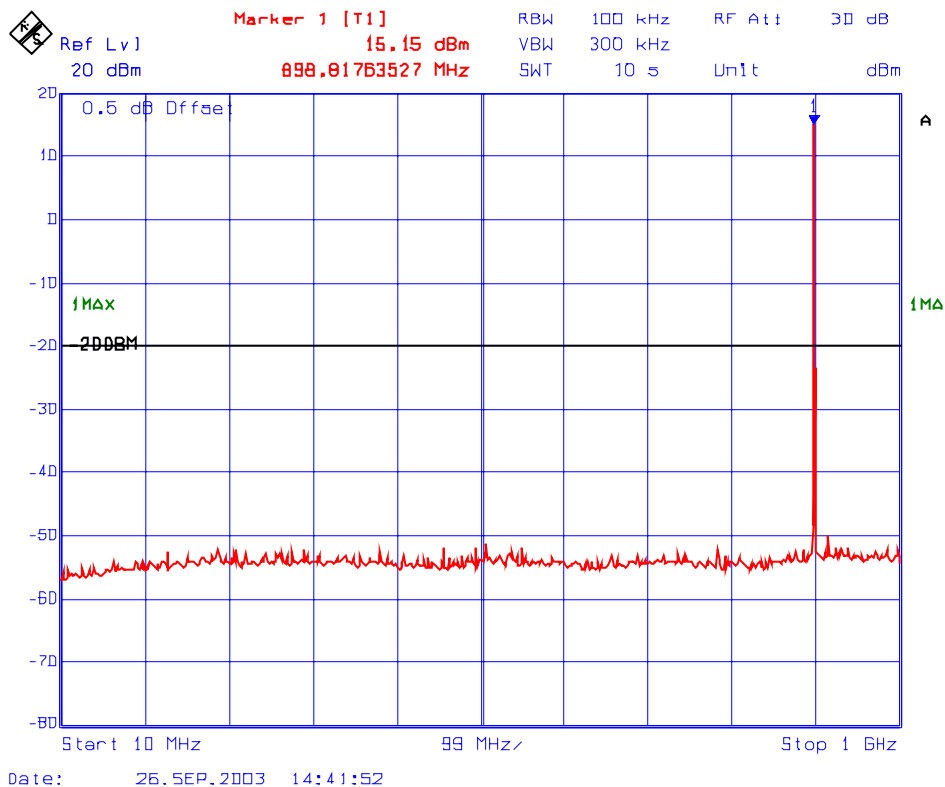

ULTRATECH GROUP OF LABS

3000 Bristol Circle, Oakville, Ontario, Canada L6H 6G4
Tel. #: 905-829-1570, Fax. #: 905-829-8050, Email: vic@ultratech-labs.com, Website: <http://www.ultratech-labs.com>

File #: WTP015QFCC90
October 01, 2003

- All test results contained in this engineering test report are traceable to National Institute of Standards and Technology (NIST)

Plot # 20 : Spurious Emission Conducted at Antenna terminal, Low power setting
Frequency: 898.5 MHz, Modulation: 2-Level 8kbps GMSK

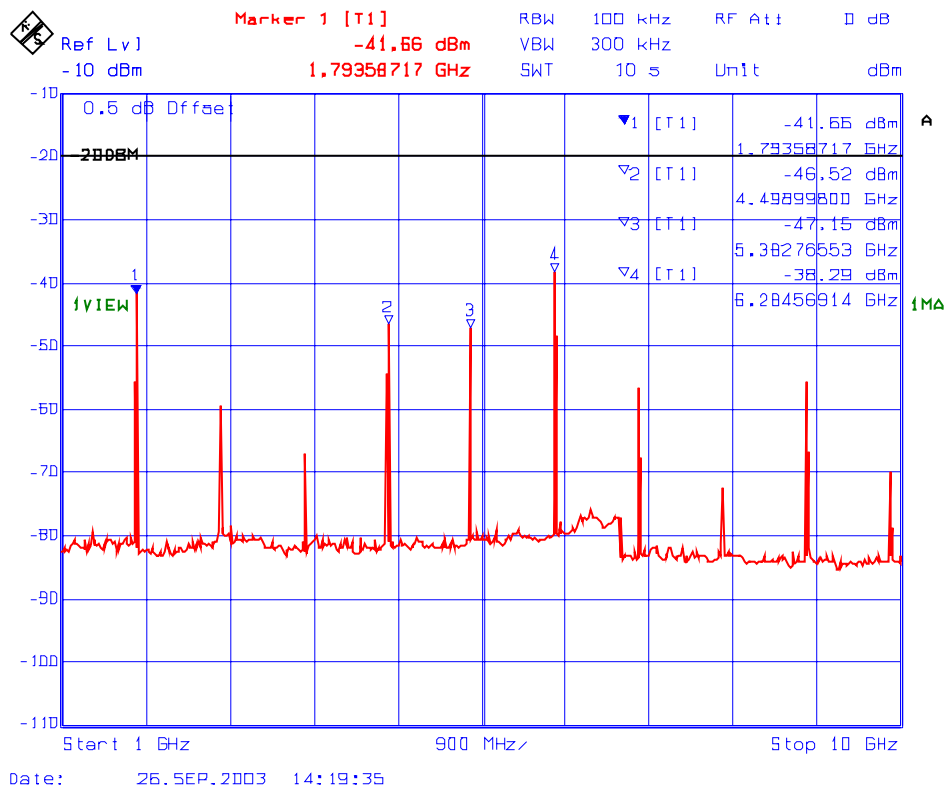

ULTRATECH GROUP OF LABS

3000 Bristol Circle, Oakville, Ontario, Canada L6H 6G4
 Tel. #: 905-829-1570, Fax. #: 905-829-8050, Email: vic@ultratech-labs.com, Website: <http://www.ultratech-labs.com>

File #: WTP015QFCC90
 October 01, 2003

- All test results contained in this engineering test report are traceable to National Institute of Standards and Technology (NIST)

Plot # 21 : Spurious Emission Conducted at Antenna terminal, Low power setting
Frequency: 901 MHz, Modulation: 2-Level 8kbps GMSK

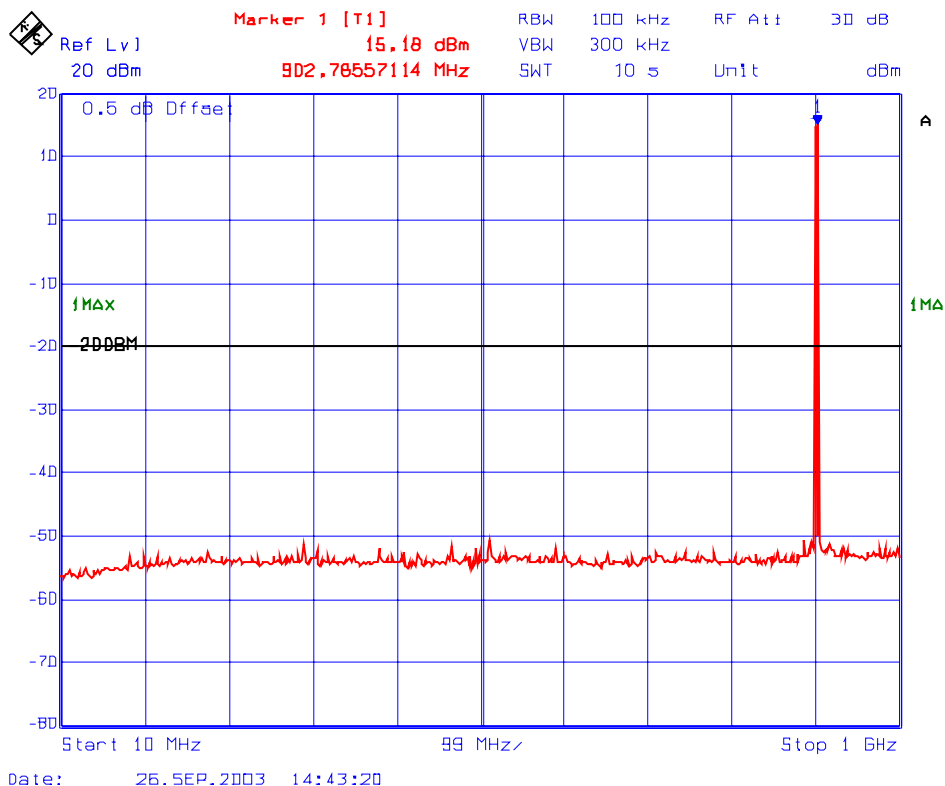

ULTRATECH GROUP OF LABS

3000 Bristol Circle, Oakville, Ontario, Canada L6H 6G4
Tel. #: 905-829-1570, Fax. #: 905-829-8050, Email: vic@ultratech-labs.com, Website: <http://www.ultratech-labs.com>

File #: WTP015QFCC90
October 01, 2003

- All test results contained in this engineering test report are traceable to National Institute of Standards and Technology (NIST)

Plot # 22 : Spurious Emission Conducted at Antenna terminal, Low power setting
Frequency: 901 MHz, Modulation: 2-Level 8kbps GMSK

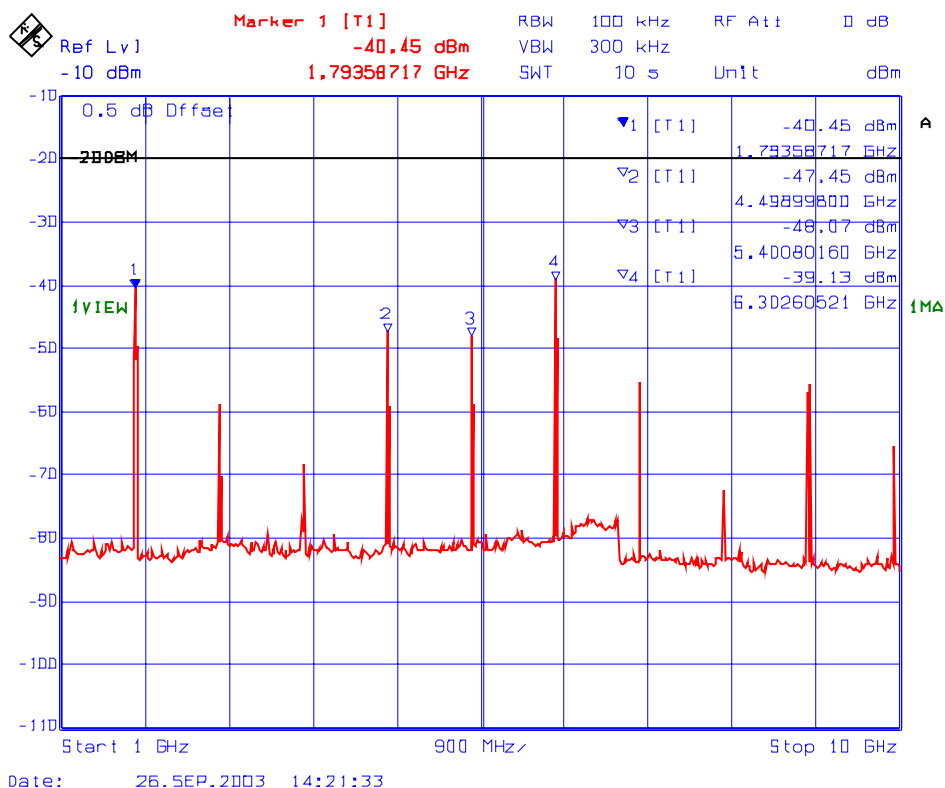

ULTRATECH GROUP OF LABS

3000 Bristol Circle, Oakville, Ontario, Canada L6H 6G4
Tel. #: 905-829-1570, Fax. #: 905-829-8050, Email: vic@ultratech-labs.com, Website: <http://www.ultratech-labs.com>

File #: WTP015QFCC90
October 01, 2003

- All test results contained in this engineering test report are traceable to National Institute of Standards and Technology (NIST)

6.10. TRANSMITTER SPURIOUS/HARMONIC RADIATED EMISSIONS @ FCC 90.210

6.10.1. Limits @ FCC 90.210(J)

Emissions shall be attenuated below the mean output power of the transmitter as follows:

Frequency Band	Frequency Range	Attenuation Limit (dBc)
896-901MHz	10 MHz to Lowest frequency of the radio to 10 th harmonic of the highest frequency of the radio	50+10*log(P) or -20 dBm or 70 dBc whichever is less

6.10.2. Method of Measurements

The spurious/harmonic ERP measurements are using substitution method specified in Exhibit 8, § 8.2 of this report and its value in dBc is calculated as follows:

- (1) If the transmitter's antenna is an integral part of the EUT, the ERP is measured using substitution method.
- (2) If the transmitter's antenna is non-integral and diverse, the lowest ERP of the carrier with 0 dBi antenna gain is used for calculation of the spurious/harmonic emissions in dBc:
 Lowest ERP of the carrier = EIRP – 2.15 dB = P_c + G - 2.15 dB = xxx dBm (conducted) + 0 dBi – 2.15 dB
- (3) Spurious /harmonic emissions levels expressed in dBc (dB below carrier) are as follows:

$$\text{ERP of spurious/harmonic (dBc)} = \text{ERP of carrier (dBm)} - \text{ERP of spurious/harmonic emission (dBm)}$$

6.10.3. Test Equipment List

Test Instruments	Manufacturer	Model No.	Serial No.	Frequency Range
Spectrum Analyzer/ EMI Receiver	Hewlett Packard	HP 8546A	...	9 kHz to 5.6 GHz with built-in 30 dB Gain Pre- selector, QP, Average & Peak Detectors.
RF Amplifier	Com-Power	PA-102		1 MHz to 1 GHz, 30 dB gain nominal
Microwave Amplifier	Hewlett Packard	HP 83017A		1 GHz to 26.5 GHz, 30 dB nominal
Biconilog Antenna	EMCO	3142	10005	30 MHz to 2 GHz
Dipole Antenna	EMCO	3121C	8907-434	30 GHz – 1 GHz
Dipole Antenna	EMCO	3121C	8907-440	30 GHz – 1 GHz
Horn Antenna	EMCO	3155	9701-5061	1 GHz – 18 GHz
Horn Antenna	EMCO	3155	9911-5955	1 GHz – 18 GHz
RF Signal Generator	Hewlett Packard	HP 83752B	3610A00457	0.01 – 20 GHz

6.10.4. Test Setup

Please refer to Photo #1 to 3 in Annex 1 for detailed of test setup.

- The Radiated emissions were performed at 3 meters distance

6.10.4.1. High Power Setting (2 Watts) at Lowest Frequency (896 MHz)

Fundamental Frequency:		896 MHz						
RF Output Power:		33.3 dBm (Conducted)						
Modulation:		2 level 8kbps GMSK						
FREQUENCY (MHz)	E-FIELD @3m (dBuV/m)	ERP measured by Substitution Method (dBm) (dBc)		EMI DETECTOR (Peak/QP)	ANTENNA POLARIZATION (H/V)	LIMIT (dBc)	MARGIN (dB)	PASS/ FAIL
**	**	**	**	PEAK	V	-53.3	**	PASS
The emissions were scanned from 10 MHz to 10 GHz and no emissions within 20 dB below the limits were found.								

6.10.4.2. High Power Setting (2 Watts) at Middle Frequency (898.5 MHz)

Fundamental Frequency:		898.5 MHz						
RF Output Power:		33.3 dBm (Conducted)						
Modulation:		2 level 8kbps GMSK						
FREQUENCY (MHz)	E-FIELD @3m (dBuV/m)	ERP measured by Substitution Method (dBm) (dBc)		EMI DETECTOR (Peak/QP)	ANTENNA POLARIZATION (H/V)	LIMIT (dBc)	MARGIN (dB)	PASS/ FAIL
**	**	**	**	PEAK	V	-53.3	**	PASS
The emissions were scanned from 10 MHz to 10 GHz and no emissions within 20 dB below the limits were found.								

6.10.4.3. High Power Setting (2 Watts) at Highest Frequency (901 MHz)

Fundamental Frequency:		901 MHz						
RF Output Power:		33.3 dBm (Conducted)						
Modulation:		2 level 8kbps GMSK						
FREQUENCY (MHz)	E-FIELD @3m (dBuV/m)	ERP measured by Substitution Method (dBm) (dBc)		EMI DETECTOR (Peak/QP)	ANTENNA POLARIZATION (H/V)	LIMIT (dBc)	MARGIN (dB)	PASS/ FAIL
**	**	**	**	PEAK	V	-53.3	**	PASS
The emissions were scanned from 10 MHz to 10 GHz and no emissions within 20 dB below the limits were found.								

6.10.5. Test Data (Low Transmitter Power)

6.10.5.1. Low Power Setting (0.032 Watts) at Lowest Frequency (896 MHz)

Fundamental Frequency:		896 MHz						
RF Output Power:		15.2 dBm (Conducted)						
Modulation:		2 level 8kbps GMSK						
FREQUENCY (MHz)	E-FIELD @3m (dBuV/m)	ERP measured by Substitution Method (dBm) (dBc)		EMI DETECTOR (Peak/QP)	ANTENNA POLARIZATION (H/V)	LIMIT (dBc)	MARGIN (dB)	PASS/ FAIL
**	**	**	**	PEAK	V	-35.2	**	PASS
The emissions were scanned from 10 MHz to 10 GHz and no emissions within 20 dB below the limits were found.								

6.10.5.2. Low Power Setting (0.032 Watts) at Middle Frequency (898.5 MHz)

Fundamental Frequency:		898.5 MHz						
RF Output Power:		15.2 dBm (Conducted)						
Modulation:		2 level 8kbps GMSK						
FREQUENCY (MHz)	E-FIELD @3m (dBuV/m)	ERP measured by Substitution Method (dBm) (dBc)		EMI DETECTOR (Peak/QP)	ANTENNA POLARIZATION (H/V)	LIMIT (dBc)	MARGIN (dB)	PASS/ FAIL
**	**	**	**	PEAK	V	-35.2	**	PASS
The emissions were scanned from 10 MHz to 10 GHz and no emissions within 20 dB below the limits were found.								

6.10.5.3. Low Power Setting (0.032 Watts) at Highest Frequency (901 MHz)

Fundamental Frequency:		901 MHz						
RF Output Power:		15.2 dBm (Conducted)						
Modulation:		2 level 8kbps GMSK						
FREQUENCY (MHz)	E-FIELD @3m (dBuV/m)	ERP measured by Substitution Method (dBm) (dBc)		EMI DETECTOR (Peak/QP)	ANTENNA POLARIZATION (H/V)	LIMIT (dBc)	MARGIN (dB)	PASS/ FAIL
**	**	**	**	PEAK	V	-35.2	**	PASS
The emissions were scanned from 10 MHz to 10 GHz and no emissions within 20 dB below the limits were found.								

EXHIBIT 7. MEASUREMENT UNCERTAINTY

The measurement uncertainties stated were calculated in accordance with the requirements of NIST Technical Note 1297 and NIS 81 (1994)

7.1. RADIATED EMISSION MEASUREMENT UNCERTAINTY

CONTRIBUTION (Radiated Emissions)	PROBABILITY DISTRIBUTION	UNCERTAINTY (+ dB)	
		3 m	10 m
Antenna Factor Calibration	Normal (k=2)	± 1.0	± 1.0
Cable Loss Calibration	Normal (k=2)	± 0.3	± 0.5
EMI Receiver specification	Rectangular	± 1.5	± 1.5
Antenna Directivity	Rectangular	+0.5	+0.5
Antenna factor variation with height	Rectangular	± 2.0	± 0.5
Antenna phase center variation	Rectangular	0.0	± 0.2
Antenna factor frequency interpolation	Rectangular	± 0.25	± 0.25
Measurement distance variation	Rectangular	± 0.6	± 0.4
Site imperfections	Rectangular	± 2.0	± 2.0
Mismatch: Receiver VRC $\Gamma_1 = 0.2$ Antenna VRC $\Gamma_R = 0.67(Bi) 0.3 (Lp)$ Uncertainty limits $20\text{Log}(1 \pm \Gamma_1 \Gamma_R)$	U-Shaped	+1.1 -1.25	± 0.5
System repeatability	Std. Deviation	± 0.5	± 0.5
Repeatability of EUT		-	-
Combined standard uncertainty	Normal	+2.19 / -2.21	+1.74 / -1.72
Expanded uncertainty U	Normal (k=2)	+4.38 / -4.42	+3.48 / -3.44

Calculation for maximum uncertainty when 3m biconical antenna including a factor of k=2 is used:

$$U = 2u_c(y) = 2x(+2.19) = +4.38 \text{ dB} \quad \text{And} \quad U = 2u_c(y) = 2x(-2.21) = -4.42 \text{ dB}$$

EXHIBIT 8. MEASUREMENT METHODS

8.1. CONDUCTED POWER MEASUREMENTS

- The following shall be applied to the combination(s) of the radio device and its intended antenna(e).
- If the RF level is user adjustable, all measurements shall be made with the highest power level available to the user for that combination.
- The following method of measurement shall apply to both conducted and radiated measurements.
- The radiated measurements are performed at the Ultratech Calibrated Open Field Test Site.
- The measurement shall be performed using normal operation of the equipment with modulation.

Test procedure shall be as follows:

Step 1: Duty Cycle measurements if the transmitter's transmission is transient

- Using a EMI Receiver with the frequency span set to 0 Hz and the sweep time set at a suitable value to capture the envelope peaks and the duty cycle of the transmitter output signal;
- The duty cycle of the transmitter, $x = \text{Tx on} / (\text{Tx on} + \text{Tx off})$ with $0 < x < 1$, is measure and recorded in the test report. For the purpose of testing, the equipment shall be operated with a duty cycle that is equal or more than 0.1.

Step 2: Calculation of Average EIRP. See Figure 1

- The average output power of the transmitter shall be determined using a wideband, calibrated RF average power meter with the power sensor with an integration period that exceeds the repetition period of the transmitter by a factor 5 or more. The observed value shall be recorded as "A" (in dBm);
- The e.i.r.p. shall be calculated from the above measured power output "A", the observed duty cycle x, and the applicable antenna assembly gain "G" in dBi, according to the formula:

$$\text{EIRP} = \text{A} + \text{G} + 10\log(1/x)$$

{ X = 1 for continuous transmission => $10\log(1/x) = 0$ dB }

Figure 1.

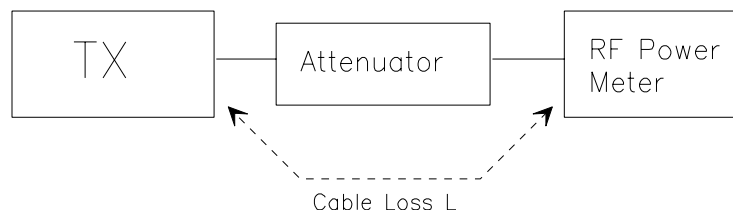

- All test results contained in this engineering test report are traceable to National Institute of Standards and Technology (NIST)

8.2. RADIATED POWER MEASUREMENTS (ERP & EIRP) USING SUBSTITUTION METHOD

8.2.1. Maximizing RF Emission Level (E-Field)

- (a) The measurements was performed with full rf output power and modulation.
- (b) Test was performed at listed 3m open area test site (listed with FCC, IC, ITI, NVLAP, ACA & VCCI).
- (c) The transmitter under test was placed at the specified height on a non-conducting turntable (80 cm height)
- (d) The BICONILOG antenna (20 MHz to 1 GHz) or HORN antenna (1 GHz to 18 GHz) was used for measuring.
- (e) Load an appropriate correction factors file in EMI Receiver for correcting the field strength reading level

Total Correction Factor recorded in the EMI Receiver = Cable Loss + Antenna Factor
E (dBuV/m) = Reading (dBuV) + Total Correction Factor (dB/m)

- (f) Set the EMI Receiver and #2 as follows:

Center Frequency:	test frequency
Resolution BW:	100 kHz
Video BW:	same
Detector Mode:	positive
Average:	off
Span:	3 x the signal bandwidth

- (g) The test antenna was lowered or raised from 1 to 4 meters until the maximum signal level was detected.
- (h) The transmitter was rotated through 360° about a vertical axis until a higher maximum signal was received.
- (i) The test antenna was lowered or raised again from 1 to 4 meters until a maximum was obtained. This level was recorded.
- (j) The recorded reading was corrected to the true field strength level by adding the antenna factor, cable loss and subtracting the pre-amplifier gain.
- (k) The above steps were repeated with both transmitters' antenna and test receiving antenna placed in vertical and horizontal polarization. Both readings with the antennas placed in vertical and horizontal polarization shall be recorded.
- (l) Repeat for all different test signal frequencies

8.2.2. Measuring the EIRP of Spurious/Harmonic Emissions using Substitution Method

- (a) Set the EMI Receiver (for measuring E-Field) and Receiver #2 (for measuring EIRP) as follows:

Center Frequency: equal to the signal source
Resolution BW: 10 kHz
Video BW: same
Detector Mode: positive
Average: off
Span: 3 x the signal bandwidth

- (b) Load an appropriate correction factors file in EMI Receiver for correcting the field strength reading level

Total Correction Factor recorded in the EMI Receiver = Cable Loss + Antenna Factor
 $E \text{ (dBuV/m)} = \text{Reading (dBuV)} + \text{Total Correction Factor (dB/m)}$

- (c) Select the frequency and E-field levels obtained in the Section 8.2.1 for ERP/EIRP measurements.
(d) Substitute the EUT by a signal generator and one of the following transmitting antenna (substitution antenna):
♦ DIPOLE antenna for frequency from 30-1000 MHz or
♦ HORN antenna for frequency above 1 GHz }
(e) Mount the transmitting antenna at 1.5 meter high from the ground plane.
(f) Use one of the following antenna as a receiving antenna:
♦ DIPOLE antenna for frequency from 30-1000 MHz or
♦ HORN antenna for frequency above 1 GHz }
(g) If the DIPOLE antenna is used, tune it's elements to the frequency as specified in the calibration manual.
(h) Adjust both transmitting and receiving antenna in a VERTICAL polarization.
(i) Tune the EMI Receivers to the test frequency.
(j) Lower or raise the test antenna from 1 to 4 meters until the maximum signal level was detected.
(k) The transmitter was rotated through 360° about a vertical axis until a higher maximum signal was received.
(l) Lower or raise the test antenna from 1 to 4 meters until the maximum signal level was detected.
(m) Adjust input signal to the substitution antenna until an equal or a known related level to that detected from the transmitter was obtained in the test receiver.
(n) Record the power level read from the Average Power Meter and calculate the ERP/EIRP as follows:

$$P = P1 - L1 = (P2 + L2) - L1 = P3 + A + L2 - L1$$

$$EIRP = P + G1 = P3 + L2 - L1 + A + G1$$

$$ERP = EIRP - 2.15 \text{ dB}$$

$$\text{Total Correction factor in EMI Receiver \# 2} = L2 - L1 + G1$$

Where: P: Actual RF Power fed into the substitution antenna port after corrected.
P1: Power output from the signal generator
P2: Power measured at attenuator A input
P3: Power reading on the Average Power Meter
EIRP: EIRP after correction
ERP: ERP after correction

- (o) Adjust both transmitting and receiving antenna in a HORIZONTAL polarization, then repeat step (k) to (o)
(p) Repeat step (d) to (o) for different test frequency
(q) Repeat steps (c) to (j) with the substitution antenna oriented in horizontal polarization.
(r) Actual gain of the EUT's antenna is the difference of the measured EIRP and measured RF power at the RF port. Correct the antenna gain if necessary.:

Figure 2

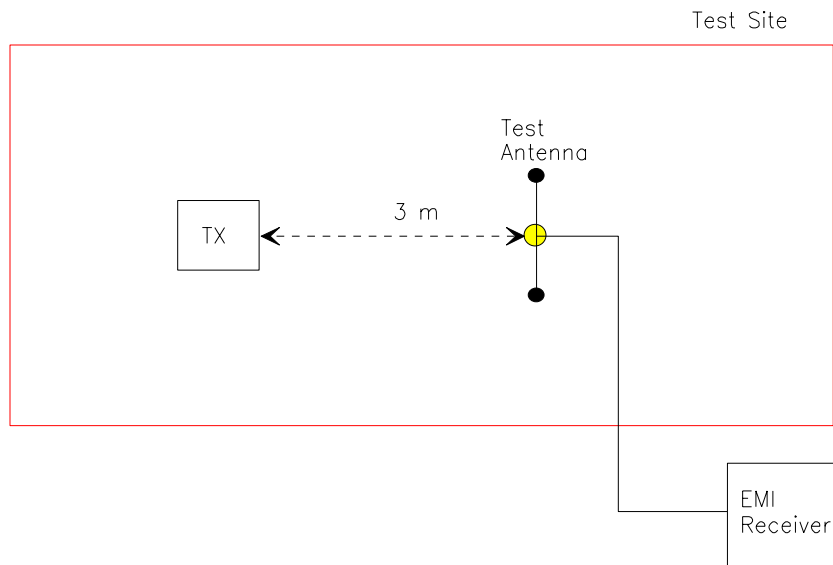
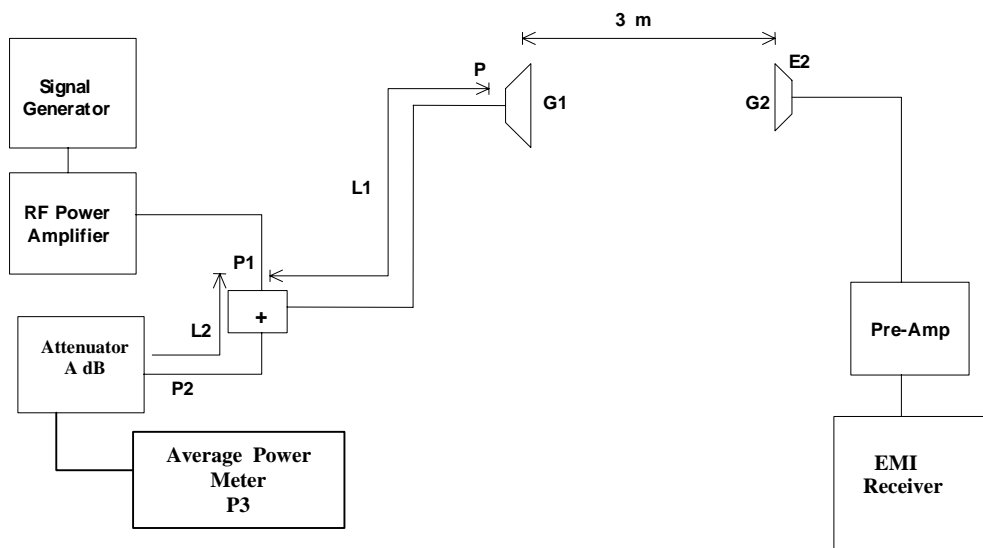

Figure 3



8.3. FREQUENCY STABILITY

Refer to FCC @ 2.1055.

- (a) The frequency stability shall be measured with variation of ambient temperature as follows: From -30 to +50 centigrade except that specified in subparagraph (2) & (3) of this paragraph.
- (b) Frequency measurements shall be made at extremes of the specified temperature range and at intervals of not more than 10 centigrade through the range. A period of time sufficient to stabilize all of the components of the oscillator circuit at each temperature level shall be allowed prior to frequency measurement. The short-term transient effects on the frequency of the transmitter due to keying (except for broadcast transmitters) and any heating element cycling normally occurring at each ambient temperature level also shall be shown. Only the portion or portions of the transmitter containing the frequency determining and stability circuitry need be subjected to the temperature variation test.
- (d) The frequency stability supply shall be measured with variation of primary supply voltage as follows:
 - (1) Vary primary supply voltage from 85 to 115 percent of the nominal value for other than hand carried battery equipment.
 - (2) For hand carried, battery powered equipment, reduce primary supply voltage to the battery operating end point which shall be specified by the manufacturer.
 - (3) The supply voltage shall be measured at the input to the cable normally provide with the equipment, or at the power supply terminals if cables are not normally provided. Effects on frequency of transmitter keying (except for broadcast transmitters) and any heating element cycling at the nominal supply voltage and at each extreme also shall be shown.
- (e) When deemed necessary, the Commission may require tests of frequency stability under conditions in addition to those specifically set out in paragraphs (a), (b), (c) and (d) of this section. (For example, measurements showing the effect of proximity to large metal objects, or of various types of antennas, may be required for portable equipment).

8.4. EMISSION MASK

Voice or Digital Modulation Through a Voice Input Port @ 2.1049(c)(i):- The transmitter was modulated by a 2.5 KHz tone signal at an input level 16 dB greater than that required to produce 50% modulation (e.g.: ± 2.5 KHz peak deviation at 1 KHz modulating frequency). The input level was established at the frequency of maximum response of the audio modulating circuit.

Digital Modulation Through a Data Input Port @ 2.1049(h):- Transmitters employing digital modulation techniques - when modulated by an input signal such that its amplitude and symbol rate represent the maximum rated conditions under which the equipment will be operated. The signal shall be applied through any filter networks, pseudo-random generators or other devices required in normal service. Additionally, the Emission Masks shall be shown for operation with any devices used for modifying the spectrum when such devices are operational at the discretion of the user.

The following EMI Receiver bandwidth shall be used for measurement of Emission Mask/Out-of-Band Emission Measurements:

- (1) For 25 kHz Channel Spacing: RBW = 300 Hz
- (2) For 12.5 kHz or 6.25 kHz Channel Spacings: RBW = 100 Hz

The all cases the Video Bandwidth shall be equal or greater than the measuring bandwidth.

8.5. SPURIOUS EMISSIONS (CONDUCTED)

With transmitter modulation characteristics described in Out-of-Band Emissions measurements @ 2.1049, the transmitter spurious and harmonic emissions were scanned. The spurious and harmonic emissions were measured with the EMI Receiver controls set as RBW = 30 kHz minimum , VBW \geq RBW and SWEEP TIME = AUTO). The transmitter was operated at a full rated power output, and modulated as follows:

FCC CFR 47, Para. 2.1057 - Frequency spectrum to be investigated:- The spectrum was investigated from the lowest radio generated in the equipment up to at least the 10th harmonic of the carrier frequency or to the highest frequency practicable in the present state of the art of measuring techniques, whichever is lower. Particular attention should be paid to harmonics and subharmonics of the carrier frequency. Radiation at the frequencies of multiplier stages should be checked. The amplitude of spurious emissions which are attenuated more than 20 dB below the permissible value need not be reported.

FCC CFR 47, Para. 2.1051 - Spurious Emissions at Antenna Terminal:- The radio frequency voltage or powers generated within the equipment and appearing on a spurious frequency shall be checked at the equipment output terminals when properly loaded with a suitable artificial antenna. Curves or equivalent data shall show the magnitude of the harmonic and other spurious emission that can be detected when the equipment is operated under the conditions specified in 2.1049 as appropriate. The magnitude of spurious emissions which are attenuated more than 20 dB below the permissible value need not be specified.