

FCC

RF Test Report

Product Type : LE910-NA V2
Applicant : Telit Communications S.p.A.
Address : Viale Stazione di Prosecco 5/B, 34010 Sgonico- Trieste- Italy
Trade Name : Telit
Model Number : LE910-NA V2
Test Specification : FCC 47 CFR PART 22H: Oct, 2014
FCC 47 CFR PART 24E: Oct, 2014
FCC 47 CFR PART 27: Oct. 2014
ANSI/TIA/EIA-603-C
Application Purpose : Original
Receive Date : Jun. 04, 2015
Test Period : Jun. 11 ~ Aug. 03, 2015
Issue Date : Aug. 04, 2015

Issue by

A Test Lab Techno Corp.
No. 140-1, Changan Street, Bade City,
Taoyuan County 334, Taiwan R.O.C.
Tel : +886-3-2710188 / Fax : +886-3-2710190



Taiwan Accreditation Foundation accreditation number: 1330

Note: This report shall not be reproduced except in full, without the written approval of A Test Lab Techno Corp. This document may be altered or revised by A Test Lab Techno Corp. personnel only, and shall be noted in the revision section of the document. The client should not use it to claim product endorsement by TAF, or any government agencies. The test results in the report only apply to the tested sample.

Revision History

Rev.	Issue Date	Revisions	Revised By
00	Jul. 28, 2015	Initial Issue	
01	Aug. 04, 2015	Revised report information.	Snow Wang

Verification of Compliance

Issued Date: 08/04/2015

Product Type : LE910-NA V2
Applicant : Telit Communications S.p.A.
Address : Viale Stazione di Prosecco 5/B, 34010 Sgonico- Trieste- Italy
Trade Name : Telit
Model Number : LE910-NA V2
EUT Rated Voltage : DC 3.4V / 3.8V / 4.2V
Test Voltage : DC 3.8V
Applicable Standard : FCC 47 CFR PART 22H: Oct, 2014
FCC 47 CFR PART 24E: Oct, 2014
FCC 47 CFR PART 27: Oct. 2014
ANSI/TIA/EIA-603-C
Test Result : Complied
Application Purpose : Original
Performing Lab. : A Test Lab Techno Corp.

No. 140-1, Changan Street, Bade City,
Taoyuan County 334, Taiwan R.O.C.

Tel : +886-3-2710188 / Fax : +886-3-2710190

Taiwan Accreditation Foundation accreditation number: 1330

<http://www.atl-lab.com.tw/e-index.htm>



The above equipment was tested by A Test Lab Techno Corp. The test data, data evaluation, test procedures, and equipment configurations shown in this report were made in accordance with the procedures given in ANSI/TIA/EIA-603-C and the energy emitted by the sample tested as described in this report is in compliance with the requirements of FCC Rules Part 27L.

The test results of this report relate only to the tested sample identified in this report.

Approved By : Fly Lu Reviewed By : Eric Ou Yang
(Manager) (Fly Lu) (Testing Engineer) (Eric Ou Yang)

TABLE OF CONTENTS

1	General Information	6
	1.1. EUT Description	6
	1.2. Mode of Operation.....	9
	1.3. EUT Exercise Software	16
	1.4. Configuration of Test System Details	16
	1.5. Test Site Environment	16
	1.6. Summary of Test Result	17
2	Conducted Output Average Power Test.....	18
	2.1. Limit	18
	2.2. Test Instruments	18
	2.3. Test Setup.....	18
	2.4. Test Procedure	18
	2.5. Uncertainty	18
	2.6. Test Result.....	19
3	Effective Radiated Power / Equivalent Isotropic Radiated Power Test	43
	3.1. Limit	43
	3.2. Test Instruments	43
	3.3. Test Setup.....	43
	3.4. Test Procedure	45
	3.5. Uncertainty	45
	3.6. Test Result.....	46
4	Frequency Stability Test	48
	4.1. Limit	48
	4.2. Test Instruments	48
	4.3. Setup	48
	4.4. Test Procedure	49
	4.5. Uncertainty	49
	4.6. Test Result.....	50
5	Emission Bandwidth & Occupied Bandwidth Test.....	53
	5.1. Limit	53
	5.2. Test Instruments	53
	5.3. Setup	53
	5.4. Test Procedure	54
	5.5. Uncertainty	54
	5.6. Test Result.....	55
	5.7. Test Graphs	60

6	Peak to Average Ratio Test.....	108
	6.1. Limit.....	108
	6.2. Test Instruments.....	108
	6.3. Setup.....	108
	6.4. Test Procedure.....	109
	6.5. Uncertainty.....	109
	6.6. Test Result.....	110
	6.7. Test Graphs.....	112
7	Band Edge Test.....	136
	7.1. Limit.....	136
	7.2. Test Instruments.....	136
	7.3. Setup.....	137
	7.4. Test Procedure.....	137
	7.5. Uncertainty.....	137
	7.6. Test Result.....	138
8	Conducted Spurious Emission and Radiation Emission Test.....	164
	8.1. Limit.....	164
	8.2. Test Instruments.....	164
	8.3. Setup.....	164
	8.4. Test Procedure.....	165
	8.5. Uncertainty.....	165
	8.6. Test Graphs.....	166
	8.7. Test Result.....	236
9	Radiated Emission Test.....	241
	9.1. Limit.....	241
	9.2. Test Instruments.....	241
	9.3. Setup.....	241
	9.4. Test Procedure.....	243
	9.5. Uncertainty.....	243
	9.6. Test Result.....	244

1 General Information

1.1. EUT Description

Applicant		Telit Communications S.p.A.			
Applicant Address		Viale Stazione di Prosecco 5/B, 34010 Sgonico- Trieste- Italy			
Manufacturer		Telit Communications S.p.A.			
Manufacturer Address		Viale Stazione di Prosecco 5/B, 34010 Sgonico- Trieste- Italy			
Product Type		LE910-NA V2			
Trade Name		Telit			
Model Number		LE910-NA V2			
Mode	LTE	Band	UL Frequency (MHz)	DL Frequency (MHz)	Modulation
		2	1850.7 ~ 1909.3	1930.7 ~ 1989.3	QPSK, 16QAM
		4	1710.7 ~ 1754.3	2110.7 ~ 2154.3	QPSK, 16QAM
		5	824.7 ~ 848.3	869.7 ~ 893.3	QPSK, 16QAM
		12	699 ~ 716	729 ~ 746	QPSK, 16QAM
		13	777 ~ 787	746 ~ 756	QPSK, 16QAM
		17	704.0 ~ 715.9	734.0 ~ 745.9	QPSK, 16QAM
Channel Bandwidth		LTE Band 2	1.4M, 3M, 5MHz, 10MHz, 15MHz, 20MHz		
		LTE Band 4	1.4M, 3M, 5MHz, 10MHz, 15MHz, 20MHz		
		LTE Band 5	1.4M, 3M, 5MHz, 10MHz		
		LTE Band 12	1.4M, 3M, 5MHz, 10MHz		
		LTE Band 13	5MHz, 10MHz		
		LTE Band 17	5MHz, 10MHz		
Antenna Gain		LTE Band 2	2.14 dBi		
		LTE Band 4	2.14 dBi		
		LTE Band 5	2.14 dBi		
		LTE Band 12	2.14 dBi		
		LTE Band 13	2.14 dBi		
		LTE Band 17	2.14 dBi		

Max. Conducted Output	LTE Band 2 (Channel Bandwidth 1.4MHz)	0.218	W
Average Power	LTE Band 2 (Channel Bandwidth 3MHz)	0.218	W
	LTE Band 2 (Channel Bandwidth 5MHz)	0.219	W
	LTE Band 2 (Channel Bandwidth 10MHz)	0.214	W
	LTE Band 2 (Channel Bandwidth 15MHz)	0.220	W
	LTE Band 2 (Channel Bandwidth 20MHz)	0.219	W
	LTE Band 4 (Channel Bandwidth 1.4MHz)	0.205	W
	LTE Band 4 (Channel Bandwidth 3MHz)	0.199	W
	LTE Band 4 (Channel Bandwidth 5MHz)	0.200	W
	LTE Band 4 (Channel Bandwidth 10MHz)	0.203	W
	LTE Band 4 (Channel Bandwidth 15MHz)	0.205	W
	LTE Band 4 (Channel Bandwidth 20MHz)	0.203	W
	LTE Band 5 (Channel Bandwidth 1.4MHz)	0.191	W
	LTE Band 5 (Channel Bandwidth 3MHz)	0.195	W
	LTE Band 5 (Channel Bandwidth 5MHz)	0.189	W
	LTE Band 5 (Channel Bandwidth 10MHz)	0.190	W
	LTE Band 12 (Channel Bandwidth 1.4MHz)	0.191	W
	LTE Band 12 (Channel Bandwidth 3MHz)	0.193	W
	LTE Band 12 (Channel Bandwidth 5MHz)	0.189	W
	LTE Band 12 (Channel Bandwidth 10MHz)	0.190	W
	LTE Band 13 (Channel Bandwidth 5MHz)	0.194	W
LTE Band 13 (Channel Bandwidth 10MHz)	0.188	W	
LTE Band 17 (Channel Bandwidth 5MHz)	0.195	W	
LTE Band 17 (Channel Bandwidth 10MHz)	0.197	W	

Max. E.R.P. / E.I.R.P.	LTE Band 2 (Channel Bandwidth 1.4MHz)	0.356	W (E.I.R.P.)
	LTE Band 2 (Channel Bandwidth 3MHz)	0.357	W (E.I.R.P.)
	LTE Band 2 (Channel Bandwidth 5MHz)	0.358	W (E.I.R.P.)
	LTE Band 2 (Channel Bandwidth 10MHz)	0.350	W (E.I.R.P.)
	LTE Band 2 (Channel Bandwidth 15MHz)	0.361	W (E.I.R.P.)
	LTE Band 2 (Channel Bandwidth 20MHz)	0.359	W (E.I.R.P.)
	LTE Band 4 (Channel Bandwidth 1.4MHz)	0.336	W (E.I.R.P.)
	LTE Band 4 (Channel Bandwidth 3MHz)	0.326	W (E.I.R.P.)
	LTE Band 4 (Channel Bandwidth 5MHz)	0.327	W (E.I.R.P.)
	LTE Band 4 (Channel Bandwidth 10MHz)	0.332	W (E.I.R.P.)
	LTE Band 4 (Channel Bandwidth 15MHz)	0.335	W (E.I.R.P.)
	LTE Band 4 (Channel Bandwidth 20MHz)	0.333	W (E.I.R.P.)
	LTE Band 5 (Channel Bandwidth 1.4MHz)	0.191	W (E.R.P.)
	LTE Band 5 (Channel Bandwidth 3MHz)	0.195	W (E.R.P.)
	LTE Band 5 (Channel Bandwidth 5MHz)	0.189	W (E.R.P.)
	LTE Band 5 (Channel Bandwidth 10MHz)	0.190	W (E.R.P.)
	LTE Band 12 (Channel Bandwidth 1.4MHz)	0.313	W (E.R.P.)
	LTE Band 12 (Channel Bandwidth 3MHz)	0.316	W (E.R.P.)
	LTE Band 12 (Channel Bandwidth 5MHz)	0.310	W (E.R.P.)
	LTE Band 12 (Channel Bandwidth 10MHz)	0.311	W (E.R.P.)
	LTE Band 13 (Channel Bandwidth 5MHz)	0.318	W (E.R.P.)
	LTE Band 13 (Channel Bandwidth 10MHz)	0.308	W (E.R.P.)
	LTE Band 17 (Channel Bandwidth 5MHz)	0.195	W (E.R.P.)
	LTE Band 17 (Channel Bandwidth 10MHz)	0.197	W (E.R.P.)

1.2. Mode of Operation

Three channels had been tested for each channel bandwidth.

LTE Band 2						
Channel Bandwidth	1.4MHz		3MHz		5MHz	
	Channel	Frequency (MHz)	Channel	Frequency (MHz)	Channel	Frequency (MHz)
Low CH	18607	1850.7	18615	1851.5	18625	1852.5
Middle CH	18900	1880.0	18900	1880.0	18900	1880.0
High CH	19193	1909.3	19185	1908.5	19175	1907.5
Channel Bandwidth	10MHz		15MHz		20MHz	
	Channel	Frequency (MHz)	Channel	Frequency (MHz)	Channel	Frequency (MHz)
Low CH	18650	1855.0	18675	1857.5	18700	1860.0
Middle CH	18900	1880.0	18900	1880.0	18900	1880.0
High CH	19150	1905.0	19125	1902.5	19100	1900.0

LTE Band 4						
Channel Bandwidth	1.4MHz		3MHz		5MHz	
	Channel	Frequency (MHz)	Channel	Frequency (MHz)	Channel	Frequency (MHz)
Low CH	19957	1710.7	19965	1711.5	19975	1712.5
Middle CH	20175	1732.5	20175	1732.5	20175	1732.5
High CH	20393	1754.3	20385	1753.5	20375	1752.5
Channel Bandwidth	10MHz		15MHz		20MHz	
	Channel	Frequency (MHz)	Channel	Frequency (MHz)	Channel	Frequency (MHz)
Low CH	20000	1715.0	20025	1717.5	20050	1720.0
Middle CH	20175	1732.5	20175	1732.5	20175	1732.5
High CH	20350	1750.0	20325	1747.5	20300	1745.0

LTE Band 5				
Channel Bandwidth	1.4MHz		3MHz	
	Channel	Frequency (MHz)	Channel	Frequency (MHz)
Low CH	20407	824.7	20415	825.5
Middle CH	20525	836.5	20525	836.5
High CH	20643	848.3	20635	847.5
Channel Bandwidth	5MHz		10MHz	
	Channel	Frequency (MHz)	Channel	Frequency (MHz)
Low CH	20425	826.5	20450	829.0
Middle CH	20525	836.5	20525	836.5
High CH	20625	846.5	20600	844.0

LTE Band 12				
Channel Bandwidth	1.4MHz		3MHz	
	Channel	Frequency (MHz)	Channel	Frequency (MHz)
Low CH	23017	699.7	23025	700.5
Middle CH	23095	707.5	23095	707.5
High CH	23173	715.3	23165	714.5
Channel Bandwidth	5MHz		10MHz	
	Channel	Frequency (MHz)	Channel	Frequency (MHz)
Low CH	23035	701.5	23060	704.0
Middle CH	23095	707.5	23095	707.5
High CH	23155	713.5	23130	711.0

LTE Band 13				
Channel Bandwidth	5MHz		10MHz	
	Channel	Frequency (MHz)	Channel	Frequency (MHz)
Low CH	23205	779.5	---	---
Middle CH	23230	782.0	23230	782.0
High CH	23255	784.5	---	---

LTE Band 17				
Channel Bandwidth	5MHz		10MHz	
	Channel	Frequency (MHz)	Channel	Frequency (MHz)
Low CH	23755	706.5	23780	709.0
Middle CH	23790	710.0	23790	710.0
High CH	23825	713.5	23800	711.0

Note: Regards to the frequency band operation: the lowest, middle and highest frequency of channel were selected to perform the test, then shown on this report.

During all testing, EUT is in link mode with base station emulator at maximum power level. The spurious emission measurements were carried out in semi-anechoic chamber with 3-meter test range, and EUT is rotated on three test planes to find out the worst emission.

Frequency range investigated for radiated emission: 30MHz to 19000 MHz.

Band	Channel Bandwidth	Test Modes	
LTE Band 2	1.4 MHz	<input checked="" type="checkbox"/> LTE(RB Size 1, RB Offset 0) Link <input type="checkbox"/> LTE(RB Size 1, RB Offset 2) Link <input type="checkbox"/> LTE(RB Size 1, RB Offset 5) Link <input type="checkbox"/> LTE(RB Size 3, RB Offset 0) Link <input type="checkbox"/> LTE(RB Size 3, RB Offset 1) Link <input type="checkbox"/> LTE(RB Size 3, RB Offset 3) Link <input type="checkbox"/> LTE(RB Size 6, RB Offset 0) Link	QPSK
	3 MHz	<input checked="" type="checkbox"/> LTE(RB Size 1, RB Offset 0) Link <input type="checkbox"/> LTE(RB Size 1, RB Offset 8) Link <input type="checkbox"/> LTE(RB Size 1, RB Offset 14) Link <input type="checkbox"/> LTE(RB Size 8, RB Offset 0) Link <input type="checkbox"/> LTE(RB Size 8, RB Offset 4) Link <input type="checkbox"/> LTE(RB Size 8, RB Offset 7) Link <input type="checkbox"/> LTE(RB Size 15, RB Offset 0) Link	QPSK
	5 MHz	<input checked="" type="checkbox"/> LTE(RB Size 1, RB Offset 0) Link <input type="checkbox"/> LTE(RB Size 1, RB Offset 12) Link <input type="checkbox"/> LTE(RB Size 1, RB Offset 24) Link <input type="checkbox"/> LTE(RB Size 12, RB Offset 0) Link <input type="checkbox"/> LTE(RB Size 12, RB Offset 6) Link <input type="checkbox"/> LTE(RB Size 12, RB Offset 13) Link <input type="checkbox"/> LTE(RB Size 25, RB Offset 0) Link	QPSK
	10 MHz	<input checked="" type="checkbox"/> LTE(RB Size 1, RB Offset 0) Link <input type="checkbox"/> LTE(RB Size 1, RB Offset 24) Link <input type="checkbox"/> LTE(RB Size 1, RB Offset 49) Link <input type="checkbox"/> LTE(RB Size 25, RB Offset 0) Link <input type="checkbox"/> LTE(RB Size 25, RB Offset 12) Link <input type="checkbox"/> LTE(RB Size 25, RB Offset 25) Link <input type="checkbox"/> LTE(RB Size 50, RB Offset 0) Link	QPSK
	15 MHz	<input checked="" type="checkbox"/> LTE(RB Size 1, RB Offset 0) Link <input type="checkbox"/> LTE(RB Size 1, RB Offset 38) Link <input type="checkbox"/> LTE(RB Size 1, RB Offset 74) Link <input type="checkbox"/> LTE(RB Size 38, RB Offset 0) Link <input type="checkbox"/> LTE(RB Size 38, RB Offset 18) Link <input type="checkbox"/> LTE(RB Size 38, RB Offset 37) Link <input type="checkbox"/> LTE(RB Size 75, RB Offset 0) Link	QPSK
	20 MHz	<input checked="" type="checkbox"/> LTE(RB Size 1, RB Offset 0) Link <input type="checkbox"/> LTE(RB Size 1, RB Offset 49) Link <input type="checkbox"/> LTE(RB Size 1, RB Offset 99) Link <input type="checkbox"/> LTE(RB Size 50, RB Offset 0) Link <input type="checkbox"/> LTE(RB Size 50, RB Offset 25) Link <input type="checkbox"/> LTE(RB Size 50, RB Offset 50) Link <input type="checkbox"/> LTE(RB Size 100, RB Offset 0) Link	QPSK

Band	Channel Bandwidth	Test Modes	
LTE Band 4	1.4 MHz	<input checked="" type="checkbox"/> LTE(RB Size 1, RB Offset 0) Link <input type="checkbox"/> LTE(RB Size 1, RB Offset 2) Link <input type="checkbox"/> LTE(RB Size 1, RB Offset 5) Link <input type="checkbox"/> LTE(RB Size 3, RB Offset 0) Link <input type="checkbox"/> LTE(RB Size 3, RB Offset 1) Link <input type="checkbox"/> LTE(RB Size 3, RB Offset 3) Link <input type="checkbox"/> LTE(RB Size 6, RB Offset 0) Link	QPSK
	3 MHz	<input checked="" type="checkbox"/> LTE(RB Size 1, RB Offset 0) Link <input type="checkbox"/> LTE(RB Size 1, RB Offset 8) Link <input type="checkbox"/> LTE(RB Size 1, RB Offset 14) Link <input type="checkbox"/> LTE(RB Size 8, RB Offset 0) Link <input type="checkbox"/> LTE(RB Size 8, RB Offset 4) Link <input type="checkbox"/> LTE(RB Size 8, RB Offset 7) Link <input type="checkbox"/> LTE(RB Size 15, RB Offset 0) Link	QPSK
	5 MHz	<input checked="" type="checkbox"/> LTE(RB Size 1, RB Offset 0) Link <input type="checkbox"/> LTE(RB Size 1, RB Offset 12) Link <input type="checkbox"/> LTE(RB Size 1, RB Offset 24) Link <input type="checkbox"/> LTE(RB Size 12, RB Offset 0) Link <input type="checkbox"/> LTE(RB Size 12, RB Offset 6) Link <input type="checkbox"/> LTE(RB Size 12, RB Offset 13) Link <input type="checkbox"/> LTE(RB Size 25, RB Offset 0) Link	QPSK
	10 MHz	<input checked="" type="checkbox"/> LTE(RB Size 1, RB Offset 0) Link <input type="checkbox"/> LTE(RB Size 1, RB Offset 24) Link <input type="checkbox"/> LTE(RB Size 1, RB Offset 49) Link <input type="checkbox"/> LTE(RB Size 25, RB Offset 0) Link <input type="checkbox"/> LTE(RB Size 25, RB Offset 12) Link <input type="checkbox"/> LTE(RB Size 25, RB Offset 25) Link <input type="checkbox"/> LTE(RB Size 50, RB Offset 0) Link	QPSK
	15 MHz	<input checked="" type="checkbox"/> LTE(RB Size 1, RB Offset 0) Link <input type="checkbox"/> LTE(RB Size 1, RB Offset 38) Link <input type="checkbox"/> LTE(RB Size 1, RB Offset 74) Link <input type="checkbox"/> LTE(RB Size 38, RB Offset 0) Link <input type="checkbox"/> LTE(RB Size 38, RB Offset 18) Link <input type="checkbox"/> LTE(RB Size 38, RB Offset 37) Link <input type="checkbox"/> LTE(RB Size 75, RB Offset 0) Link	QPSK
	20 MHz	<input checked="" type="checkbox"/> LTE(RB Size 1, RB Offset 0) Link <input type="checkbox"/> LTE(RB Size 1, RB Offset 49) Link <input type="checkbox"/> LTE(RB Size 1, RB Offset 99) Link <input type="checkbox"/> LTE(RB Size 50, RB Offset 0) Link <input type="checkbox"/> LTE(RB Size 50, RB Offset 25) Link <input type="checkbox"/> LTE(RB Size 50, RB Offset 50) Link <input type="checkbox"/> LTE(RB Size 100, RB Offset 0) Link	QPSK

Band	Channel Bandwidth	Test Modes	
LTE Band 5	1.4 MHz	<input checked="" type="checkbox"/> LTE(RB Size 1, RB Offset 0) Link <input type="checkbox"/> LTE(RB Size 1, RB Offset 2) Link <input type="checkbox"/> LTE(RB Size 1, RB Offset 5) Link <input type="checkbox"/> LTE(RB Size 3, RB Offset 0) Link <input type="checkbox"/> LTE(RB Size 3, RB Offset 1) Link <input type="checkbox"/> LTE(RB Size 3, RB Offset 3) Link <input type="checkbox"/> LTE(RB Size 6, RB Offset 0) Link	QPSK
	3 MHz	<input checked="" type="checkbox"/> LTE(RB Size 1, RB Offset 0) Link <input type="checkbox"/> LTE(RB Size 1, RB Offset 8) Link <input type="checkbox"/> LTE(RB Size 1, RB Offset 14) Link <input type="checkbox"/> LTE(RB Size 8, RB Offset 0) Link <input type="checkbox"/> LTE(RB Size 8, RB Offset 4) Link <input type="checkbox"/> LTE(RB Size 8, RB Offset 7) Link <input type="checkbox"/> LTE(RB Size 15, RB Offset 0) Link	QPSK
	5 MHz	<input checked="" type="checkbox"/> LTE(RB Size 1, RB Offset 0) Link <input type="checkbox"/> LTE(RB Size 1, RB Offset 12) Link <input type="checkbox"/> LTE(RB Size 1, RB Offset 24) Link <input type="checkbox"/> LTE(RB Size 12, RB Offset 0) Link <input type="checkbox"/> LTE(RB Size 12, RB Offset 6) Link <input type="checkbox"/> LTE(RB Size 12, RB Offset 13) Link <input type="checkbox"/> LTE(RB Size 25, RB Offset 0) Link	QPSK
	10 MHz	<input checked="" type="checkbox"/> LTE(RB Size 1, RB Offset 0) Link <input type="checkbox"/> LTE(RB Size 1, RB Offset 24) Link <input type="checkbox"/> LTE(RB Size 1, RB Offset 49) Link <input type="checkbox"/> LTE(RB Size 25, RB Offset 0) Link <input type="checkbox"/> LTE(RB Size 25, RB Offset 12) Link <input type="checkbox"/> LTE(RB Size 25, RB Offset 25) Link <input type="checkbox"/> LTE(RB Size 50, RB Offset 0) Link	QPSK

Band	Channel Bandwidth	Test Modes	
LTE Band 12	1.4 MHz	<input checked="" type="checkbox"/> LTE(RB Size 1, RB Offset 0) Link <input type="checkbox"/> LTE(RB Size 1, RB Offset 2) Link <input type="checkbox"/> LTE(RB Size 1, RB Offset 5) Link <input type="checkbox"/> LTE(RB Size 3, RB Offset 0) Link <input type="checkbox"/> LTE(RB Size 3, RB Offset 1) Link <input type="checkbox"/> LTE(RB Size 3, RB Offset 3) Link <input type="checkbox"/> LTE(RB Size 6, RB Offset 0) Link	QPSK
	3 MHz	<input checked="" type="checkbox"/> LTE(RB Size 1, RB Offset 0) Link <input type="checkbox"/> LTE(RB Size 1, RB Offset 8) Link <input type="checkbox"/> LTE(RB Size 1, RB Offset 14) Link <input type="checkbox"/> LTE(RB Size 8, RB Offset 0) Link <input type="checkbox"/> LTE(RB Size 8, RB Offset 4) Link <input type="checkbox"/> LTE(RB Size 8, RB Offset 7) Link <input type="checkbox"/> LTE(RB Size 15, RB Offset 0) Link	QPSK
	5 MHz	<input checked="" type="checkbox"/> LTE(RB Size 1, RB Offset 0) Link <input type="checkbox"/> LTE(RB Size 1, RB Offset 12) Link <input type="checkbox"/> LTE(RB Size 1, RB Offset 24) Link <input type="checkbox"/> LTE(RB Size 12, RB Offset 0) Link <input type="checkbox"/> LTE(RB Size 12, RB Offset 6) Link <input type="checkbox"/> LTE(RB Size 12, RB Offset 13) Link <input type="checkbox"/> LTE(RB Size 25, RB Offset 0) Link	QPSK
	10 MHz	<input checked="" type="checkbox"/> LTE(RB Size 1, RB Offset 0) Link <input type="checkbox"/> LTE(RB Size 1, RB Offset 24) Link <input type="checkbox"/> LTE(RB Size 1, RB Offset 49) Link <input type="checkbox"/> LTE(RB Size 25, RB Offset 0) Link <input type="checkbox"/> LTE(RB Size 25, RB Offset 12) Link <input type="checkbox"/> LTE(RB Size 25, RB Offset 25) Link <input type="checkbox"/> LTE(RB Size 50, RB Offset 0) Link	QPSK

Band	Channel Bandwidth	Test Modes	
LTE Band 13	5 MHz	<input checked="" type="checkbox"/> LTE(RB Size 1, RB Offset 0) Link <input type="checkbox"/> LTE(RB Size 1, RB Offset 12) Link <input type="checkbox"/> LTE(RB Size 1, RB Offset 24) Link <input type="checkbox"/> LTE(RB Size 12, RB Offset 0) Link <input type="checkbox"/> LTE(RB Size 12, RB Offset 6) Link <input type="checkbox"/> LTE(RB Size 12, RB Offset 13) Link <input type="checkbox"/> LTE(RB Size 25, RB Offset 0) Link	QPSK
	10 MHz	<input checked="" type="checkbox"/> LTE(RB Size 1, RB Offset 0) Link <input type="checkbox"/> LTE(RB Size 1, RB Offset 24) Link <input type="checkbox"/> LTE(RB Size 1, RB Offset 49) Link <input type="checkbox"/> LTE(RB Size 25, RB Offset 0) Link <input type="checkbox"/> LTE(RB Size 25, RB Offset 12) Link <input type="checkbox"/> LTE(RB Size 25, RB Offset 25) Link <input type="checkbox"/> LTE(RB Size 50, RB Offset 0) Link	QPSK
LTE Band 17	5 MHz	<input checked="" type="checkbox"/> LTE(RB Size 1, RB Offset 0) Link <input type="checkbox"/> LTE(RB Size 1, RB Offset 12) Link <input type="checkbox"/> LTE(RB Size 1, RB Offset 24) Link <input type="checkbox"/> LTE(RB Size 12, RB Offset 0) Link <input type="checkbox"/> LTE(RB Size 12, RB Offset 6) Link <input type="checkbox"/> LTE(RB Size 12, RB Offset 13) Link <input type="checkbox"/> LTE(RB Size 25, RB Offset 0) Link	QPSK
	10 MHz	<input checked="" type="checkbox"/> LTE(RB Size 1, RB Offset 0) Link <input type="checkbox"/> LTE(RB Size 1, RB Offset 24) Link <input type="checkbox"/> LTE(RB Size 1, RB Offset 49) Link <input type="checkbox"/> LTE(RB Size 25, RB Offset 0) Link <input type="checkbox"/> LTE(RB Size 25, RB Offset 12) Link <input type="checkbox"/> LTE(RB Size 25, RB Offset 25) Link <input type="checkbox"/> LTE(RB Size 50, RB Offset 0) Link	QPSK

1.3. EUT Exercise Software

1	Setup the EUT and Base Station (CMW500) as shown on 1.4.
2	Turn on the power of all equipment.
3	EUT run test program test.

1.4. Configuration of Test System Details

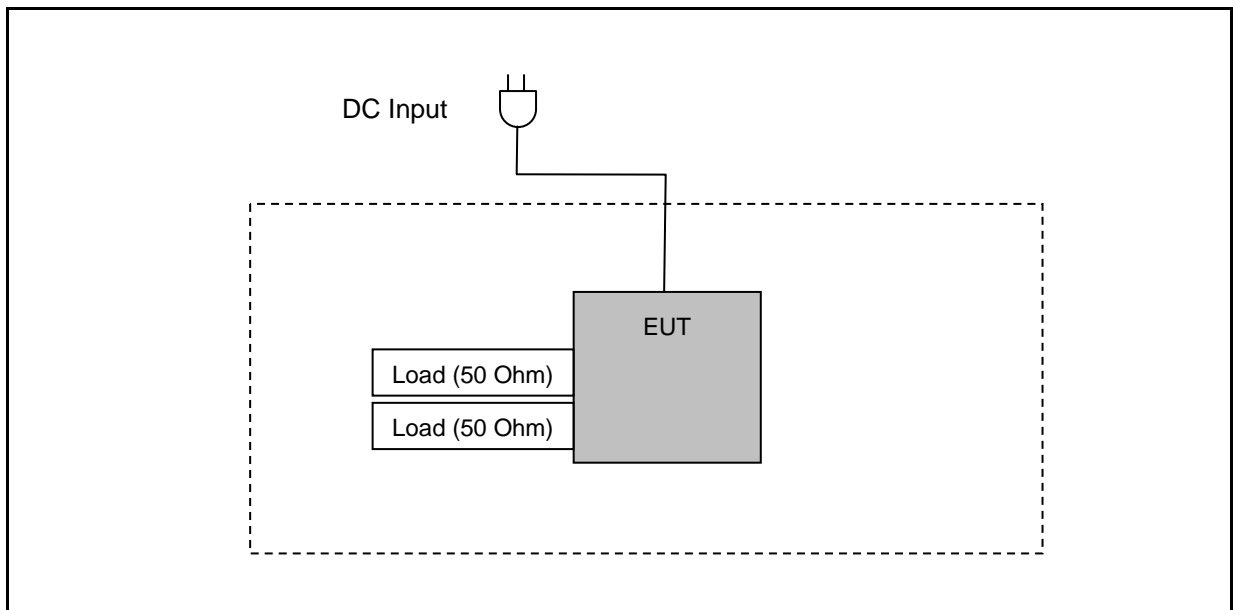

1.5. Test Site Environment

Items	Required (IEC 68-1)	Actual
Temperature (°C)	15-35	26
Humidity (%RH)	25-75	60
Barometric pressure (mbar)	860-1060	950

1.6. Summary of Test Result

FCC Rule	Description	Result
§2.1046	Conducted Output Average Power	Pass
§22.913 §24.232 §27.50	Equivalent Isotropic Radiated Power / Equivalent Radiated Power	Pass
§2.1055 §22.355 §24.235 §27.54	Frequency Stability	Pass
§2.1049	Emission Bandwidth & Occupied Bandwidth	Pass
§24.232 §27.50	Peak to average ratio	Pass
§22.917 §24.238 §27.53	Band Edge	Pass
§2.1051 §22.917 §24.238 §27.53	Conducted Spurious Emissions	Pass
§2.1053 §22.917 §24.238 §27.53	Radiated Spurious Emissions	Pass

2 Conducted Output Average Power Test

2.1. Limit

N/A

2.2. Test Instruments

Equipment	Manufacturer	Model No.	Serial No.	Cal. Date	Remark
Wideband Radio Communication Tester	R & S	CMW500	103168	11/05/2014	(1)
Wideband Power Sensor	Agilent	N1921A	MY45241957	12/15/2014	(1)
Single Channel PK Power Meter	Agilent	N1911A	MY45101619	12/15/2014	(1)
Test Site	ATL	TE05	TE05	N.C.R.	-----

Remark: ⁽¹⁾ Calibration period 1 year. ⁽²⁾ Calibration period 2 years.

Note: N.C.R. = No Calibration Request.

2.3. Test Setup

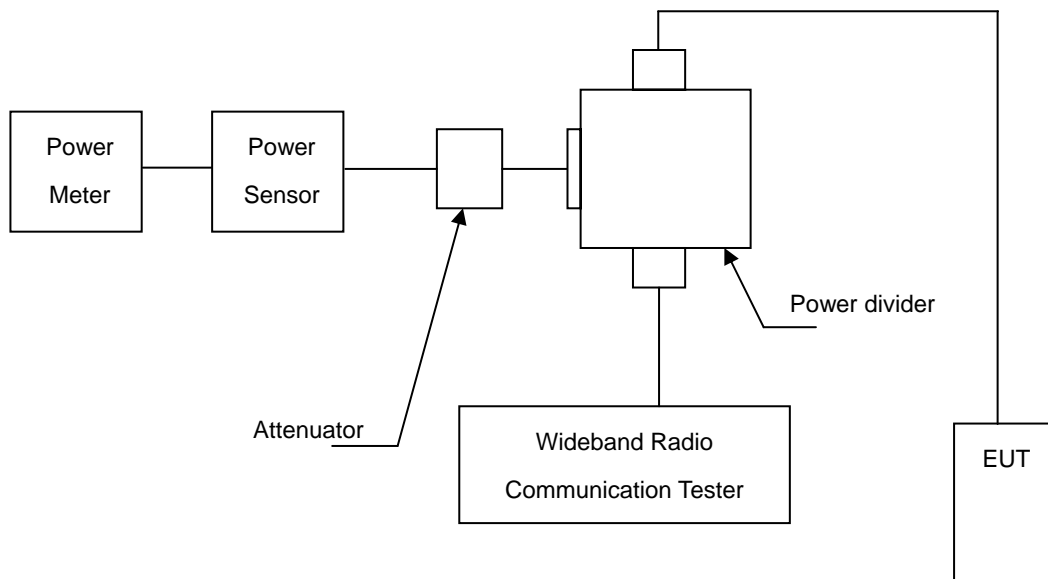

2.4. Test Procedure

- The EUT was set up for the maximum power with LTE link data modulation and link up with simulator.
- Set the EUT to transmit under low, middle and high channel and record the power level shown on simulator.

2.5. Uncertainty

The measurement uncertainty is defined as for Conducted Power measurement is 1.2 dB.

2.6. Test Result

Model Number	LE910-NA V2		
Test Item	Conducted Output Average Power		
Date of Test	06/18/2015	Test Site	TE05

Band	Channel Bandwidth	Modulation	Channel	Frequency (MHz)	RB Configuration		Average Power	
					Size	Offset	(dBm)	(W)
LTE Band 2	1.4 MHz	QPSK	18607	1850.7	1	0	23.25	0.211
					1	2	23.21	0.209
					1	5	23.17	0.207
					3	0	23.14	0.206
					3	1	23.09	0.204
					3	3	23.07	0.203
			6	0	22.39	0.173		
			1	0	23.38	0.218		
			1	2	23.37	0.217		
			1	5	23.35	0.216		
			3	0	23.31	0.214		
			3	1	23.29	0.213		
			3	3	23.25	0.211		
			6	0	22.42	0.175		
			1	0	23.09	0.204		
			1	2	23.08	0.203		
			1	5	23.05	0.202		
			3	0	23.04	0.201		
		3	1	23.01	0.200			
		3	3	22.99	0.199			
		6	0	22.22	0.167			
		1	0	22.61	0.182			
		1	2	22.35	0.172			
		1	5	22.33	0.171			
		3	0	22.21	0.166			
		3	1	22.20	0.166			
		3	3	22.18	0.165			
		6	0	21.43	0.139			
		1	0	22.66	0.185			
		1	2	22.64	0.184			
		1	5	22.50	0.178			
		3	0	22.49	0.177			
		3	1	22.48	0.177			
		3	3	22.17	0.165			
		6	0	21.50	0.141			
		1	0	22.26	0.168			
1	2	22.12	0.163					
1	5	22.10	0.162					
3	0	22.09	0.162					
3	1	22.06	0.161					
3	3	22.05	0.160					
6	0	21.47	0.140					

Band	Channel Bandwidth	Modulation	Channel	Frequency (MHz)	RB Configuration		Average Power	
					Size	Offset	(dBm)	(W)
LTE Band 2	3 MHz	QPSK	18615	1851.5	1	0	23.23	0.210
					1	8	23.21	0.209
					1	14	23.15	0.207
					8	0	22.34	0.171
					8	4	22.32	0.171
					8	7	22.22	0.167
			15	0	22.19	0.166		
			1	0	23.39	0.218		
			1	8	23.30	0.214		
			1	14	23.26	0.212		
			8	0	22.41	0.174		
			8	4	22.40	0.174		
			8	7	22.39	0.173		
			15	0	22.37	0.173		
			1	0	23.21	0.209		
			1	8	23.10	0.204		
			1	14	22.96	0.198		
			8	0	22.35	0.172		
		8	4	22.32	0.171			
		8	7	22.27	0.169			
		15	0	22.22	0.167			
		1	0	22.47	0.177			
		1	8	22.26	0.168			
		1	14	22.09	0.162			
		8	0	21.40	0.138			
		8	4	21.39	0.138			
		8	7	21.37	0.137			
		15	0	21.29	0.135			
		1	0	22.56	0.180			
		1	8	22.22	0.167			
		1	14	22.12	0.163			
		8	0	21.46	0.140			
		8	4	21.43	0.139			
		8	7	21.42	0.139			
		15	0	21.41	0.138			
		1	0	22.37	0.173			
		1	8	22.34	0.171			
		1	14	21.79	0.151			
		8	0	21.38	0.137			
		8	4	21.33	0.136			
		8	7	21.32	0.136			
		15	0	21.29	0.135			

Band	Channel Bandwidth	Modulation	Channel	Frequency (MHz)	RB Configuration		Average Power			
					Size	Offset	(dBm)	(W)		
LTE Band 2	5 MHz	QPSK	18625	1852.5	1	0	23.22	0.210		
					1	12	23.16	0.207		
					1	24	22.95	0.197		
					12	0	22.36	0.172		
					12	6	22.26	0.168		
					12	13	22.25	0.168		
					25	0	22.18	0.165		
					1	0	23.40	0.219		
			18900	1880.0	1	12	23.36	0.217		
					1	24	23.21	0.209		
					12	0	22.46	0.176		
					12	6	22.46	0.176		
					12	13	22.44	0.175		
					25	0	22.32	0.171		
					19175	1907.5	1	0	23.24	0.211
							1	12	23.17	0.207
			1	24			22.98	0.199		
			12	0			22.35	0.172		
			12	6			22.34	0.171		
			12	13			22.31	0.170		
			25	0			22.29	0.169		
			16QAM	18625			1852.5	1	0	22.46
					1	12		22.21	0.166	
					1	24		22.02	0.159	
		12			0	21.44		0.139		
		12			6	21.43		0.139		
		12			13	21.34		0.136		
		25			0	21.24		0.133		
		18900			1880.0	1		0	22.67	0.185
				1		12	22.28	0.169		
				1		24	22.07	0.161		
				12		0	21.44	0.139		
				12		6	21.41	0.138		
				12		13	21.38	0.137		
				25		0	21.37	0.137		
				19175		1907.5	1	0	22.49	0.177
		1			12		22.22	0.167		
		1			24		21.76	0.150		
		12			0		21.53	0.142		
		12			6		21.50	0.141		
		12			11		21.43	0.139		
		25			0		21.34	0.136		

Band	Channel Bandwidth	Modulation	Channel	Frequency (MHz)	RB Configuration		Average Power	
					Size	Offset	(dBm)	(W)
LTE Band 2	10 MHz	QPSK	18650	1855.0	1	0	23.30	0.214
					1	24	23.20	0.209
					1	49	23.00	0.200
					25	0	22.33	0.171
					25	12	22.30	0.170
					25	25	22.25	0.168
			50	0	22.23	0.167		
			1	0	23.29	0.213		
			1	24	23.28	0.213		
			1	49	23.24	0.211		
			25	0	22.41	0.174		
			25	12	22.41	0.174		
			25	25	22.38	0.173		
			50	0	22.36	0.172		
			1	0	23.25	0.211		
			1	24	23.17	0.207		
			1	49	22.89	0.195		
			25	0	22.43	0.175		
		25	12	22.29	0.169			
		25	25	22.29	0.169			
		50	0	22.22	0.167			
		1	0	22.32	0.171			
		1	24	22.19	0.166			
		1	49	22.08	0.161			
		25	0	21.51	0.142			
		25	12	21.51	0.142			
		25	25	21.31	0.135			
		50	0	21.27	0.134			
		1	0	22.54	0.179			
		1	24	22.51	0.178			
		1	49	22.15	0.164			
		25	0	21.57	0.144			
		25	12	21.48	0.141			
		25	25	21.44	0.139			
		50	0	21.42	0.139			
		1	0	22.42	0.175			
		1	24	22.23	0.167			
		1	49	21.79	0.151			
		25	0	21.43	0.139			
		25	12	21.41	0.138			
		25	25	21.39	0.138			
		50	0	21.38	0.137			

Band	Channel Bandwidth	Modulation	Channel	Frequency (MHz)	RB Configuration		Average Power			
					Size	Offset	(dBm)	(W)		
LTE Band 2	15 MHz	QPSK	18675	1857.5	1	0	23.33	0.215		
					1	38	23.29	0.213		
					1	74	23.22	0.210		
					38	0	22.34	0.171		
					38	18	22.32	0.171		
					38	37	22.32	0.171		
					75	0	22.30	0.170		
					1	0	23.43	0.220		
			18900	1880.0	1	38	23.32	0.215		
					1	74	23.28	0.213		
					38	0	22.48	0.177		
					38	18	22.43	0.175		
					38	37	22.40	0.174		
					75	0	22.39	0.173		
					1	0	23.38	0.218		
					1	38	23.14	0.206		
			19125	1902.5	1	74	23.02	0.200		
					38	0	22.32	0.171		
					38	18	22.31	0.170		
					38	37	22.29	0.169		
					75	0	22.27	0.169		
					1	0	22.25	0.168		
					1	38	22.23	0.167		
					1	74	22.00	0.158		
		16QAM	18675	1857.5	38	0	21.52	0.142		
					38	18	21.51	0.142		
					38	37	21.37	0.137		
					75	0	21.29	0.135		
					1	0	22.59	0.182		
					1	38	22.49	0.177		
					1	74	22.29	0.169		
					38	0	21.53	0.142		
					38	18	21.51	0.142		
					38	37	21.48	0.141		
					75	0	21.47	0.140		
					18900	1880.0	1	0	22.20	0.166
			1	38			22.13	0.163		
			1	74			22.09	0.162		
			38	0			21.51	0.142		
			38	18			21.48	0.141		
			38	37			21.46	0.140		
			75	0			21.45	0.140		
			19125	1902.5			1	0	22.20	0.166
							1	38	22.13	0.163
							1	74	22.09	0.162
							38	0	21.51	0.142
							38	18	21.48	0.141
					38	37	21.46	0.140		
75	0	21.45			0.140					

Band	Channel Bandwidth	Modulation	Channel	Frequency (MHz)	RB Configuration		Average Power	
					Size	Offset	(dBm)	(W)
LTE Band 2	20 MHz	QPSK	18700	1860.0	1	0	23.31	0.214
					1	49	23.27	0.212
					1	99	23.22	0.210
					50	0	22.32	0.171
					50	25	22.19	0.166
					50	50	22.19	0.166
			100	0	22.17	0.165		
			1	0	23.41	0.219		
			1	49	23.38	0.218		
			1	99	23.24	0.211		
			50	0	22.44	0.175		
			50	25	22.39	0.173		
			50	50	22.33	0.171		
			100	0	22.32	0.171		
			1	0	23.26	0.212		
			1	49	23.15	0.207		
			1	99	23.02	0.200		
			50	0	22.34	0.171		
		50	25	22.32	0.171			
		50	50	22.28	0.169			
		100	0	22.27	0.169			
		1	0	22.37	0.173			
		1	49	22.22	0.167			
		1	99	22.17	0.165			
		50	0	21.41	0.138			
		50	25	21.35	0.136			
		50	50	21.34	0.136			
		100	0	21.33	0.136			
		1	0	22.38	0.173			
		1	49	22.37	0.173			
		1	99	22.28	0.169			
		50	0	21.49	0.141			
		50	25	21.46	0.140			
		50	50	21.43	0.139			
		100	0	21.35	0.136			
		1	0	22.77	0.189			
1	49	22.17	0.165					
1	99	22.12	0.163					
50	0	21.44	0.139					
50	25	21.42	0.139					
50	50	21.37	0.137					
100	0	21.35	0.136					

Band	Channel Bandwidth	Modulation	Channel	Frequency (MHz)	RB Configuration		Average Power	
					Size	Offset	(dBm)	(W)
LTE Band 4	1.4 MHz	QPSK	19957	1710.7	1	0	23.12	0.205
					1	2	23.09	0.204
					1	5	23.07	0.203
					3	0	23.05	0.202
					3	1	23.01	0.200
					3	3	22.99	0.199
			6	0	22.13	0.163		
			20175	1732.5	1	0	22.92	0.196
					1	2	22.89	0.195
					1	5	22.87	0.194
					3	0	22.84	0.192
					3	1	22.81	0.191
					3	3	22.82	0.191
			6	0	22.01	0.159		
			20393	1754.3	1	0	22.99	0.199
					1	2	22.90	0.195
					1	5	22.89	0.195
					3	0	22.87	0.194
		3			1	22.86	0.193	
		3			3	22.83	0.192	
		6	0	21.94	0.156			
		16QAM	19957	1710.7	1	0	22.42	0.175
					1	2	22.16	0.164
					1	5	22.11	0.163
					3	0	22.04	0.160
					3	1	21.99	0.158
					3	3	21.93	0.156
			6	0	21.06	0.128		
			20175	1732.5	1	0	22.22	0.167
					1	2	22.14	0.164
					1	5	22.11	0.163
					3	0	22.08	0.161
					3	1	21.97	0.157
					3	3	21.75	0.150
			6	0	21.07	0.128		
			20393	1754.3	1	0	21.94	0.156
					1	2	21.92	0.156
					1	5	21.92	0.156
					3	0	21.81	0.152
		3			1	21.77	0.150	
		3			3	21.73	0.149	
		6	0	20.96	0.125			

Band	Channel Bandwidth	Modulation	Channel	Frequency (MHz)	RB Configuration		Average Power	
					Size	Offset	(dBm)	(W)
LTE Band 4	3 MHz	QPSK	19965	1711.5	1	0	22.99	0.199
					1	8	22.97	0.198
					1	14	22.92	0.196
					8	0	22.15	0.164
					8	4	22.14	0.164
					8	7	22.13	0.163
			15	0	22.01	0.159		
			1	0	22.89	0.195		
			1	8	22.86	0.193		
			1	14	22.84	0.192		
			8	0	22.04	0.160		
			8	4	21.97	0.157		
			8	7	21.93	0.156		
			15	0	21.90	0.155		
			1	0	22.87	0.194		
			1	8	22.86	0.193		
			1	14	22.84	0.192		
			8	0	21.96	0.157		
		8	4	21.91	0.155			
		8	7	21.87	0.154			
		15	0	21.84	0.153			
		1	0	22.41	0.174			
		1	8	21.90	0.155			
		1	14	21.73	0.149			
		8	0	21.17	0.131			
		8	4	21.10	0.129			
		8	7	21.00	0.126			
		15	0	20.94	0.124			
		1	0	22.22	0.167			
		1	8	22.05	0.160			
		1	14	21.80	0.151			
		8	0	21.00	0.126			
		8	4	20.94	0.124			
		8	7	20.90	0.123			
		15	0	20.87	0.122			
		1	0	21.96	0.157			
		1	8	21.86	0.153			
		1	14	21.61	0.145			
		8	0	20.92	0.124			
		8	4	20.88	0.122			
		8	7	20.88	0.122			
		15	0	20.83	0.121			

Band	Channel Bandwidth	Modulation	Channel	Frequency (MHz)	RB Configuration		Average Power	
					Size	Offset	(dBm)	(W)
LTE Band 4	5 MHz	QPSK	19975	1712.5	1	0	23.01	0.200
					1	12	22.97	0.198
					1	24	22.95	0.197
					12	0	22.08	0.161
					12	6	22.04	0.160
					12	13	21.99	0.158
			25	0	21.98	0.158		
			1	0	22.89	0.195		
			1	12	22.86	0.193		
			1	24	22.79	0.190		
			12	0	22.03	0.160		
			12	6	22.01	0.159		
			12	13	22.00	0.158		
			25	0	21.92	0.156		
			1	0	22.88	0.194		
			1	12	22.85	0.193		
			1	24	22.82	0.191		
			12	0	22.02	0.159		
		12	6	21.96	0.157			
		12	13	21.94	0.156			
		25	0	21.89	0.155			
		1	0	22.30	0.170			
		1	12	22.05	0.160			
		1	24	21.85	0.153			
		12	0	21.11	0.129			
		12	6	21.09	0.129			
		12	13	21.04	0.127			
		25	0	20.97	0.125			
		1	0	22.17	0.165			
		1	12	22.06	0.161			
		1	24	21.70	0.148			
		12	0	21.07	0.128			
		12	6	21.01	0.126			
		12	13	20.99	0.126			
		25	0	20.98	0.125			
		1	0	21.86	0.153			
1	12	21.83	0.152					
1	24	21.57	0.144					
12	0	20.98	0.125					
12	6	20.95	0.124					
12	11	20.84	0.121					
25	0	20.77	0.119					

Band	Channel Bandwidth	Modulation	Channel	Frequency (MHz)	RB Configuration		Average Power	
					Size	Offset	(dBm)	(W)
LTE Band 4	10 MHz	QPSK	2000	1715.0	1	0	23.07	0.203
					1	24	22.93	0.196
					1	49	22.88	0.194
					25	0	22.15	0.164
					25	12	22.06	0.161
					25	25	22.05	0.160
			50	0	22.00	0.158		
			1	0	22.88	0.194		
			1	24	22.86	0.193		
			1	49	22.84	0.192		
			25	0	21.96	0.157		
			25	12	21.96	0.157		
			25	25	21.93	0.156		
			50	0	21.92	0.156		
			1	0	22.96	0.198		
			1	24	22.86	0.193		
			1	49	22.84	0.192		
			25	0	21.94	0.156		
		25	12	21.91	0.155			
		25	25	21.89	0.155			
		50	0	21.87	0.154			
		1	0	22.02	0.159			
		1	24	21.88	0.154			
		1	49	21.71	0.148			
		25	0	21.09	0.129			
		25	12	21.07	0.128			
		25	25	21.06	0.128			
		50	0	21.03	0.127			
		1	0	22.21	0.166			
		1	24	22.05	0.160			
		1	49	21.80	0.151			
		25	0	21.03	0.127			
		25	12	21.02	0.126			
		25	25	20.95	0.124			
		50	0	20.91	0.123			
		1	0	22.27	0.169			
		1	24	22.19	0.166			
		1	49	21.82	0.152			
		25	0	20.96	0.125			
		25	12	20.84	0.121			
		25	25	20.83	0.121			
		50	0	20.77	0.119			

Band	Channel Bandwidth	Modulation	Channel	Frequency (MHz)	RB Configuration		Average Power	
					Size	Offset	(dBm)	(W)
LTE Band 4	15 MHz	QPSK	20025	1717.5	1	0	23.11	0.205
					1	38	23.03	0.201
					1	74	22.90	0.195
					38	0	22.06	0.161
					38	18	22.04	0.160
					38	37	21.99	0.158
					75	0	21.96	0.157
					1	0	23.01	0.200
			20175	1732.5	1	38	22.98	0.199
					1	74	22.86	0.193
					38	0	22.04	0.160
					38	18	22.03	0.160
					38	37	22.02	0.159
					75	0	21.95	0.157
					1	0	23.07	0.203
					1	38	23.00	0.200
			20325	1747.5	1	74	22.95	0.197
					38	0	22.03	0.160
					38	18	21.99	0.158
					38	37	21.94	0.156
					75	0	21.84	0.153
					1	0	22.37	0.173
					1	38	22.27	0.169
					1	74	21.91	0.155
		16QAM	20025	1717.5	38	0	21.08	0.128
					38	18	21.01	0.126
					38	37	21.01	0.126
					75	0	20.92	0.124
					1	0	21.91	0.155
					1	38	21.72	0.149
					1	74	21.70	0.148
					38	0	21.11	0.129
			20175	1732.5	38	18	21.06	0.128
					38	37	20.95	0.124
					75	0	20.92	0.124
					1	0	22.35	0.172
					1	38	22.17	0.165
					1	74	22.14	0.164
					38	0	21.02	0.126
					38	18	20.92	0.124
			20325	1747.5	38	37	20.90	0.123
					75	0	20.75	0.119

Band	Channel Bandwidth	Modulation	Channel	Frequency (MHz)	RB Configuration		Average Power	
					Size	Offset	(dBm)	(W)
LTE Band 4	20 MHz	QPSK	20050	1720.0	1	0	23.08	0.203
					1	49	22.95	0.197
					1	99	22.83	0.192
					50	0	22.08	0.161
					50	25	22.03	0.160
					50	50	22.03	0.160
			100	0	22.02	0.159		
			1	0	23.02	0.200		
			1	49	22.91	0.195		
			1	99	22.73	0.187		
			50	0	22.04	0.160		
			50	25	21.92	0.156		
			50	50	21.91	0.155		
			100	0	21.91	0.155		
			1	0	22.99	0.199		
			1	49	22.90	0.195		
			1	99	22.88	0.194		
			50	0	21.96	0.157		
		50	25	21.85	0.153			
		50	50	21.83	0.152			
		100	0	21.82	0.152			
		1	0	22.38	0.173			
		1	49	22.31	0.170			
		1	99	21.54	0.143			
		50	0	21.02	0.126			
		50	25	20.97	0.125			
		50	50	20.95	0.124			
		100	0	20.93	0.124			
		1	0	22.26	0.168			
		1	49	21.96	0.157			
		1	99	21.62	0.145			
		50	0	21.02	0.126			
		50	25	20.99	0.126			
		50	50	20.93	0.124			
		100	0	20.84	0.121			
		1	0	22.33	0.171			
		1	49	22.23	0.167			
		1	99	21.78	0.151			
		50	0	20.88	0.122			
		50	25	20.87	0.122			
		50	50	20.86	0.122			
		100	0	20.83	0.121			

Band	Channel Bandwidth	Modulation	Channel	Frequency (MHz)	RB Configuration		Average Power	
					Size	Offset	(dBm)	(W)
LTE Band 5	1.4 MHz	QPSK	20407	824.7	1	0	22.74	0.188
					1	2	22.72	0.187
					1	5	22.71	0.187
					3	0	22.70	0.186
					3	1	22.69	0.186
					3	3	22.68	0.185
			20525	836.5	6	0	21.73	0.149
					1	0	22.76	0.189
					1	2	22.72	0.187
					1	5	22.69	0.186
					3	0	22.67	0.185
					3	1	22.66	0.185
			20643	848.3	3	3	22.60	0.182
					6	0	21.83	0.152
					1	0	22.81	0.191
					1	2	22.80	0.191
					1	5	22.77	0.189
					3	0	22.76	0.189
		16QAM	20407	824.7	3	1	22.67	0.185
					3	3	22.64	0.184
					6	0	21.81	0.152
					1	0	21.77	0.150
					1	2	21.71	0.148
					1	5	21.65	0.146
			20525	836.5	3	0	21.63	0.146
					3	1	21.55	0.143
					3	3	21.31	0.135
					6	0	20.71	0.118
					1	0	21.86	0.153
					1	2	21.83	0.152
			20643	848.3	1	5	21.80	0.151
					3	0	21.68	0.147
					3	1	21.50	0.141
					3	3	21.42	0.139
					6	0	20.64	0.116
					1	0	21.94	0.156
20407	824.7	1	2	21.93	0.156			
		1	5	21.85	0.153			
		3	0	21.69	0.148			
		3	1	21.63	0.146			
		3	3	21.60	0.145			
		6	0	20.69	0.117			

Band	Channel Bandwidth	Modulation	Channel	Frequency (MHz)	RB Configuration		Average Power	
					Size	Offset	(dBm)	(W)
LTE Band 5	3 MHz	QPSK	20415	825.5	1	0	22.71	0.187
					1	8	22.68	0.185
					1	14	22.64	0.184
					8	0	21.74	0.149
					8	4	21.70	0.148
					8	7	21.64	0.146
			15	0	21.62	0.145		
			1	0	22.71	0.187		
			1	8	22.71	0.187		
			1	14	22.63	0.183		
			8	0	21.77	0.150		
			8	4	21.76	0.150		
			8	7	21.71	0.148		
			15	0	21.68	0.147		
			1	0	22.90	0.195		
			1	8	22.78	0.190		
			1	14	22.71	0.187		
			8	0	21.84	0.153		
		8	4	21.82	0.152			
		8	7	21.76	0.150			
		15	0	21.71	0.148			
		1	0	21.97	0.157			
		1	8	21.52	0.142			
		1	14	21.34	0.136			
		8	0	20.71	0.118			
		8	4	20.57	0.114			
		8	7	20.55	0.114			
		15	0	20.54	0.113			
		1	0	21.95	0.157			
		1	8	21.70	0.148			
		1	14	21.29	0.135			
		8	0	20.74	0.119			
		8	4	20.68	0.117			
		8	7	20.59	0.115			
		15	0	20.38	0.109			
		1	0	21.70	0.148			
1	8	21.61	0.145					
1	14	21.59	0.144					
8	0	20.80	0.120					
8	4	20.69	0.117					
8	7	20.67	0.117					
15	0	20.61	0.115					

Band	Channel Bandwidth	Modulation	Channel	Frequency (MHz)	RB Configuration		Average Power	
					Size	Offset	(dBm)	(W)
LTE Band 5	5 MHz	QPSK	20425	826.5	1	0	22.74	0.188
					1	12	22.74	0.188
					1	24	22.65	0.184
					12	0	21.80	0.151
					12	6	21.79	0.151
					12	13	21.69	0.148
			20525	836.5	25	0	21.68	0.147
					1	0	22.61	0.182
					1	12	22.61	0.182
					1	24	22.56	0.180
					12	0	21.78	0.151
					12	6	21.74	0.149
			20625	846.5	12	13	21.71	0.148
					25	0	21.70	0.148
					1	0	22.77	0.189
					1	12	22.63	0.183
					1	24	22.61	0.182
					12	0	21.84	0.153
		16QAM	20425	826.5	12	6	21.77	0.150
					12	13	21.70	0.148
					25	0	21.65	0.146
					1	0	21.93	0.156
					1	12	21.81	0.152
					1	24	21.59	0.144
			20525	836.5	12	0	20.71	0.118
					12	6	20.64	0.116
					12	13	20.59	0.115
					25	0	20.58	0.114
					1	0	21.90	0.155
					1	12	21.65	0.146
			20625	846.5	1	24	21.48	0.141
					12	0	20.63	0.116
					12	6	20.61	0.115
					12	13	20.60	0.115
					25	0	20.53	0.113
					1	0	21.95	0.157
20425	826.5	1	12	21.70	0.148			
		1	24	21.58	0.144			
		12	0	20.92	0.124			
		12	6	20.86	0.122			
		12	11	20.74	0.119			
		25	0	20.61	0.115			

Band	Channel Bandwidth	Modulation	Channel	Frequency (MHz)	RB Configuration		Average Power	
					Size	Offset	(dBm)	(W)
LTE Band 5	10 MHz	QPSK	20450	829.0	1	0	22.77	0.189
					1	24	22.60	0.182
					1	49	22.57	0.181
					25	0	21.72	0.149
					25	12	21.70	0.148
					25	25	21.67	0.147
			50	0	21.62	0.145		
			1	0	22.76	0.189		
			1	24	22.72	0.187		
			1	49	22.59	0.182		
			25	0	21.73	0.149		
			25	12	21.70	0.148		
			25	25	21.66	0.147		
			50	0	21.61	0.145		
			1	0	22.79	0.190		
			1	24	22.76	0.189		
			1	49	22.64	0.184		
			25	0	21.72	0.149		
		25	12	21.71	0.148			
		25	25	21.71	0.148			
		50	0	21.68	0.147			
		1	0	21.59	0.144			
		1	24	21.54	0.143			
		1	49	21.49	0.141			
		25	0	20.63	0.116			
		25	12	20.61	0.115			
		25	25	20.58	0.114			
		50	0	20.54	0.113			
		1	0	21.92	0.156			
		1	24	21.81	0.152			
		1	49	21.33	0.136			
		25	0	20.64	0.116			
		25	12	20.64	0.116			
		25	25	20.61	0.115			
		50	0	20.57	0.114			
		1	0	21.93	0.156			
1	24	21.80	0.151					
1	49	21.64	0.146					
25	0	20.68	0.117					
25	12	20.67	0.117					
25	25	20.64	0.116					
50	0	20.56	0.114					

Band	Channel Bandwidth	Modulation	Channel	Frequency (MHz)	RB Configuration		Average Power	
					Size	Offset	(dBm)	(W)
LTE Band 12	1.4 MHz	QPSK	23017	699.7	1	0	22.74	0.188
					1	2	22.72	0.187
					1	5	22.71	0.187
					3	0	22.70	0.186
					3	1	22.69	0.186
					3	3	22.68	0.185
			23095	707.5	6	0	21.73	0.149
					1	0	22.76	0.189
					1	2	22.72	0.187
					1	5	22.69	0.186
					3	0	22.67	0.185
					3	1	22.66	0.185
			23173	715.3	3	3	22.60	0.182
					6	0	21.83	0.152
					1	0	22.81	0.191
					1	2	22.80	0.191
					1	5	22.77	0.189
					3	0	22.76	0.189
		16QAM	23017	699.7	3	1	22.67	0.185
					3	3	22.64	0.184
					6	0	21.81	0.152
					1	0	21.77	0.150
					1	2	21.71	0.148
					1	5	21.65	0.146
			23095	707.5	3	0	21.63	0.146
					3	1	21.55	0.143
					3	3	21.31	0.135
					6	0	20.71	0.118
					1	0	21.86	0.153
					1	2	21.83	0.152
			23173	715.3	1	5	21.80	0.151
					3	0	21.68	0.147
					3	1	21.50	0.141
					3	3	21.42	0.139
					6	0	20.64	0.116
					1	0	21.94	0.156
23017	699.7	1	2	21.93	0.156			
		1	5	21.85	0.153			
		3	0	21.69	0.148			
		3	1	21.63	0.146			
		3	3	21.60	0.145			
		6	0	20.69	0.117			

Band	Channel Bandwidth	Modulation	Channel	Frequency (MHz)	RB Configuration		Average Power			
					Size	Offset	(dBm)	(W)		
LTE Band 12	3 MHz	QPSK	23025	700.5	1	0	22.71	0.187		
					1	8	22.68	0.185		
					1	14	22.64	0.184		
					8	0	21.74	0.149		
					8	4	21.70	0.148		
					8	7	21.64	0.146		
			15	0	21.62	0.145				
			23095	707.5	1	0	22.73	0.187		
					1	8	22.71	0.187		
					1	14	22.63	0.183		
					8	0	21.77	0.150		
					8	4	21.76	0.150		
					8	7	21.71	0.148		
			15	0	21.68	0.147				
			23165	714.5	1	0	22.86	0.193		
					1	8	22.78	0.190		
					1	14	22.71	0.187		
					8	0	21.84	0.153		
		8			4	21.82	0.152			
		8			7	21.76	0.150			
		15	0	21.71	0.148					
		16QAM	23025	700.5	1	0	21.97	0.157		
					1	8	21.52	0.142		
					1	14	21.34	0.136		
					8	0	20.71	0.118		
					8	4	20.57	0.114		
					8	7	20.55	0.114		
					15	0	20.54	0.113		
					23095	707.5	1	0	21.95	0.157
							1	8	21.70	0.148
							1	14	21.29	0.135
			8	0			20.74	0.119		
			8	4			20.68	0.117		
			8	7			20.59	0.115		
			15	0	20.38	0.109				
			23165	714.5	1	0	21.70	0.148		
					1	8	21.61	0.145		
					1	14	21.59	0.144		
					8	0	20.80	0.120		
					8	4	20.69	0.117		
					8	7	20.67	0.117		
					15	0	20.61	0.115		

Band	Channel Bandwidth	Modulation	Channel	Frequency (MHz)	RB Configuration		Average Power	
					Size	Offset	(dBm)	(W)
LTE Band 12	5 MHz	QPSK	23035	701.5	1	0	22.74	0.188
					1	12	22.74	0.188
					1	24	22.65	0.184
					12	0	21.80	0.151
					12	6	21.79	0.151
					12	13	21.69	0.148
			23095	707.5	25	0	21.68	0.147
					1	0	22.61	0.182
					1	12	22.61	0.182
					1	24	22.56	0.180
					12	0	21.78	0.151
					12	6	21.74	0.149
			23155	713.5	12	13	21.71	0.148
					25	0	21.70	0.148
					1	0	22.77	0.189
					1	12	22.63	0.183
					1	24	22.61	0.182
					12	0	21.84	0.153
		16QAM	23035	701.5	12	6	21.77	0.150
					12	13	21.70	0.148
					25	0	21.65	0.146
					1	0	21.93	0.156
					1	12	21.81	0.152
					1	24	21.59	0.144
			23095	707.5	12	0	20.71	0.118
					12	6	20.64	0.116
					12	13	20.59	0.115
					25	0	20.58	0.114
					1	0	21.90	0.155
					1	12	21.65	0.146
			23155	713.5	1	24	21.48	0.141
					12	0	20.63	0.116
					12	6	20.61	0.115
					12	13	20.60	0.115
					25	0	20.53	0.113
					1	0	21.95	0.157
23035	701.5	1	12	21.70	0.148			
		1	24	21.58	0.144			
		12	0	20.92	0.124			
		12	6	20.86	0.122			
		12	11	20.74	0.119			
		25	0	20.61	0.115			

Band	Channel Bandwidth	Modulation	Channel	Frequency (MHz)	RB Configuration		Average Power	
					Size	Offset	(dBm)	(W)
LTE Band 12	10 MHz	QPSK	23060	704.0	1	0	22.77	0.189
					1	24	22.60	0.182
					1	49	22.57	0.181
					25	0	21.72	0.149
					25	12	21.70	0.148
					25	25	21.67	0.147
			50	0	21.62	0.145		
			1	0	22.76	0.189		
			1	24	22.72	0.187		
			1	49	22.59	0.182		
			25	0	21.73	0.149		
			25	12	21.70	0.148		
			25	25	21.66	0.147		
			50	0	21.61	0.145		
			1	0	22.79	0.190		
			1	24	22.76	0.189		
			1	49	22.64	0.184		
			25	0	21.72	0.149		
		25	12	21.71	0.148			
		25	25	21.71	0.148			
		50	0	21.68	0.147			
		1	0	21.59	0.144			
		1	24	21.54	0.143			
		1	49	21.49	0.141			
		25	0	20.63	0.116			
		25	12	20.61	0.115			
		25	25	20.58	0.114			
		50	0	20.54	0.113			
		1	0	21.92	0.156			
		1	24	21.81	0.152			
		1	49	21.33	0.136			
		25	0	20.64	0.116			
		25	12	20.64	0.116			
		25	25	20.61	0.115			
		50	0	20.57	0.114			
		1	0	21.93	0.156			
1	24	21.80	0.151					
1	49	21.64	0.146					
25	0	20.68	0.117					
25	12	20.67	0.117					
25	25	20.64	0.116					
50	0	20.56	0.114					

Band	Channel Bandwidth	Modulation	Channel	Frequency (MHz)	RB Configuration		Average Power	
					Size	Offset	(dBm)	(W)
LTE Band 13	5 MHz	QPSK	23205	779.5	1	0	22.82	0.191
					1	12	22.43	0.175
					1	24	22.32	0.171
					12	0	21.93	0.156
					12	6	21.92	0.156
					12	13	21.59	0.144
			25	0	21.21	0.132		
			1	0	22.86	0.193		
			1	12	22.84	0.192		
			1	24	22.35	0.172		
			12	0	22.06	0.161		
			12	6	21.90	0.155		
			12	13	21.47	0.140		
			25	0	21.45	0.140		
			1	0	22.88	0.194		
			1	12	22.78	0.190		
			1	24	22.75	0.188		
			12	0	22.06	0.161		
		12	6	21.76	0.150			
		12	13	21.48	0.141			
		25	0	21.44	0.139			
		1	0	21.96	0.157			
		1	12	21.88	0.154			
		1	24	21.16	0.131			
		12	0	21.06	0.128			
		12	6	20.87	0.122			
		12	13	20.81	0.121			
		25	0	20.61	0.115			
		1	0	21.94	0.156			
		1	12	21.80	0.151			
		1	24	21.66	0.147			
		12	0	21.13	0.130			
		12	6	20.95	0.124			
		12	13	20.56	0.114			
		25	0	20.33	0.108			
		1	0	22.02	0.159			
1	12	21.72	0.149					
1	24	21.64	0.146					
12	0	21.05	0.127					
12	6	21.01	0.126					
12	11	20.86	0.122					
25	0	20.49	0.112					

Band	Channel Bandwidth	Modulation	Channel	Frequency (MHz)	RB Configuration		Average Power	
					Size	Offset	(dBm)	(W)
LTE Band 13	10 MHz	QPSK	23230	782.0	1	0	22.74	0.188
					1	24	22.65	0.184
					1	49	22.59	0.182
					25	0	22.21	0.166
					25	12	22.17	0.165
					25	25	22.12	0.163
					50	0	21.72	0.149
		16QAM	23230	782.0	1	0	21.91	0.155
					1	24	21.75	0.150
					1	49	21.55	0.143
					25	0	21.46	0.140
					25	12	21.35	0.136
					25	25	21.01	0.126
					50	0	20.58	0.114

Band	Channel Bandwidth	Modulation	Channel	Frequency (MHz)	RB Configuration		Average Power	
					Size	Offset	(dBm)	(W)
LTE Band 17	5 MHz	QPSK	23755	706.5	1	0	22.90	0.195
					1	12	22.84	0.192
					1	24	22.77	0.189
					12	0	21.86	0.153
					12	6	21.79	0.151
					12	13	21.76	0.150
			23790	710.0	25	0	21.72	0.149
					1	0	22.83	0.192
					1	12	22.82	0.191
					1	24	22.62	0.183
					12	0	21.88	0.154
					12	6	21.84	0.153
			23825	713.5	12	13	21.83	0.152
					25	0	21.82	0.152
					1	0	22.90	0.195
					1	12	22.72	0.187
					1	24	22.53	0.179
					12	0	21.85	0.153
		16QAM	23755	706.5	12	6	21.84	0.153
					12	13	21.80	0.151
					25	0	21.76	0.150
					1	0	22.08	0.161
					1	12	22.02	0.159
					1	24	21.69	0.148
			23790	710.0	12	0	20.82	0.121
					12	6	20.78	0.120
					12	13	20.75	0.119
					25	0	20.74	0.119
					1	0	21.78	0.151
					1	12	21.72	0.149
			23825	713.5	1	24	21.44	0.139
					12	0	20.94	0.124
					12	6	20.83	0.121
					12	13	20.65	0.116
					25	0	20.61	0.115
					1	0	21.97	0.157
23755	706.5	1	12	21.68	0.147			
		1	24	21.48	0.141			
		12	0	20.96	0.125			
		12	6	20.96	0.125			
		12	13	20.82	0.121			
		25	0	20.78	0.120			

Band	Channel Bandwidth	Modulation	Channel	Frequency (MHz)	RB Configuration		Average Power	
					Size	Offset	(dBm)	(W)
LTE Band 17	10 MHz	QPSK	23780	709.0	1	0	22.95	0.197
					1	24	22.76	0.189
					1	49	22.65	0.184
					25	0	21.88	0.154
					25	12	21.83	0.152
					25	25	21.82	0.152
			50	0	21.78	0.151		
			1	0	22.92	0.196		
			1	24	22.82	0.191		
			1	49	22.64	0.184		
			25	0	21.82	0.152		
			25	12	21.80	0.151		
			25	25	21.80	0.151		
			50	0	21.76	0.150		
			1	0	22.76	0.189		
			1	24	22.65	0.184		
			1	49	22.63	0.183		
			25	0	21.79	0.151		
		25	12	21.77	0.150			
		25	25	21.76	0.150			
		50	0	21.69	0.148			
		1	0	21.83	0.152			
		1	24	21.70	0.148			
		1	49	21.45	0.140			
		25	0	20.85	0.122			
		25	12	20.77	0.119			
		25	25	20.72	0.118			
		50	0	20.72	0.118			
		1	0	22.14	0.164			
		1	24	21.96	0.157			
		1	49	21.66	0.147			
		25	0	20.82	0.121			
		25	12	20.81	0.121			
		25	25	20.75	0.119			
		50	0	20.72	0.118			
		1	0	21.97	0.157			
1	24	21.64	0.146					
1	49	21.52	0.142					
25	0	20.79	0.120					
25	12	20.78	0.120					
25	25	20.73	0.118					
50	0	20.67	0.117					

3 Effective Radiated Power / Equivalent Isotropic Radiated Power Test

3.1. Limit

For FCC Part 27: The EIRP of mobile transmitters and auxiliary test transmitters must not exceed 1 Watts.

For FCC Part 27.50(b)(9): Control stations and mobile stations transmitting in the 746-757 MHz, and 776-788 MHz bands are limited to 30 watts ERP.

For FCC Part 27.50(c)(9): Control and mobile stations in the 698-746 MHz band are limited to 30 watts ERP.

For FCC Part 27.50(c)(10): Portable stations in the 698-746 MHz band are limited to 3 watts ERP.

For FCC Part 22.913(a)(2): The ERP of mobile transmitters and auxiliary test transmitters must not exceed 7 Watts.

For FCC Part 24.232(b): The EIRP of mobile transmitters and auxiliary test transmitters must not exceed 2 Watts.

3.2. Test Instruments

3 Meter Chamber					
Equipment	Manufacturer	Model Number	Serial Number	Cal. Date	Remark
RF Pre-selector	Agilent	N9039A	MY46520256	01/06/2015	(1)
Spectrum Analyzer	Agilent	E4446A	MY46180578	01/06/2015	(1)
Pre Amplifier	Agilent	8449B	3008A02237	02/24/2015	(1)
Pre Amplifier	Agilent	8447D	2944A10961	02/24/2015	(1)
Broadband Antenna (30MHz~1GHz)	SCHWARZBECK MESS-ELEKTRONIK	VULB9163	9163-270	07/22/2014	(1)
Horn Antenna (1~18GHz)	SCHWARZBECK MESS-ELEKTRONIK	BBHA9120D	9120D-550	06/12/2015	(1)
Horn Antenna (18~40GHz)	SCHWARZBECK MESS-ELEKTRONIK	BBHA9170	9170-320	07/02/2014	(1)
Test Site	ATL	TE01	888001	08/28/2014	(1)

Remark: ⁽¹⁾ Calibration period 1 year. ⁽²⁾ Calibration period 2 years.

Note: N.C.R. = No Calibration Request.

3.3. Test Setup

Below 1 GHz

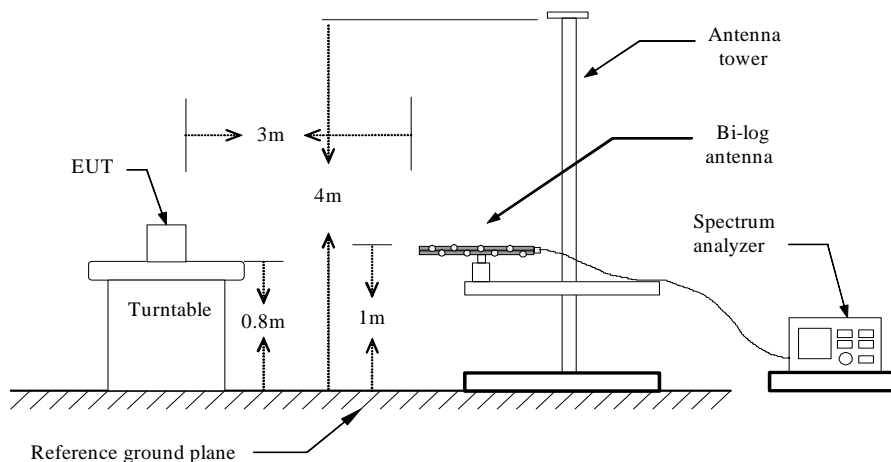

Above 1 GHz

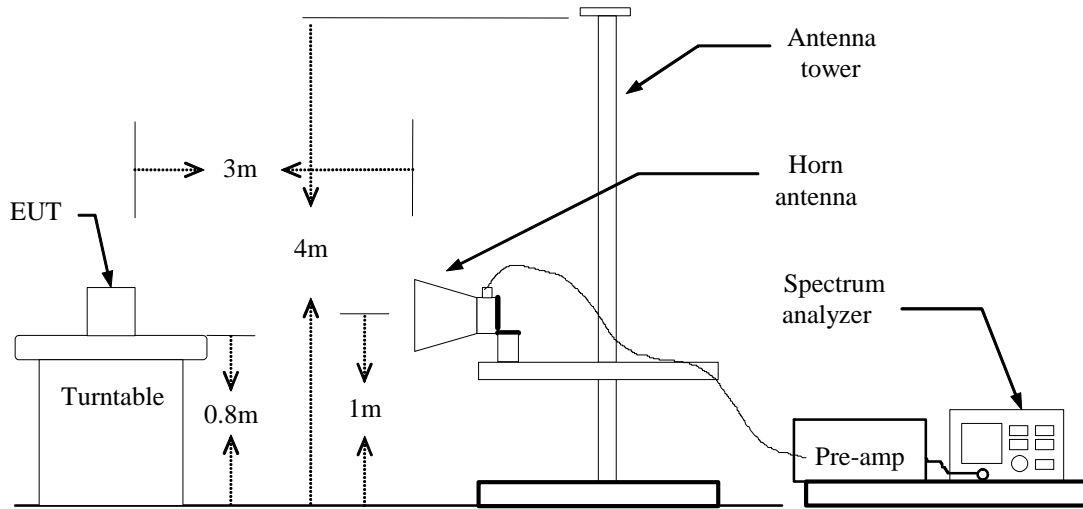

For Substituted Method Test Set-UP

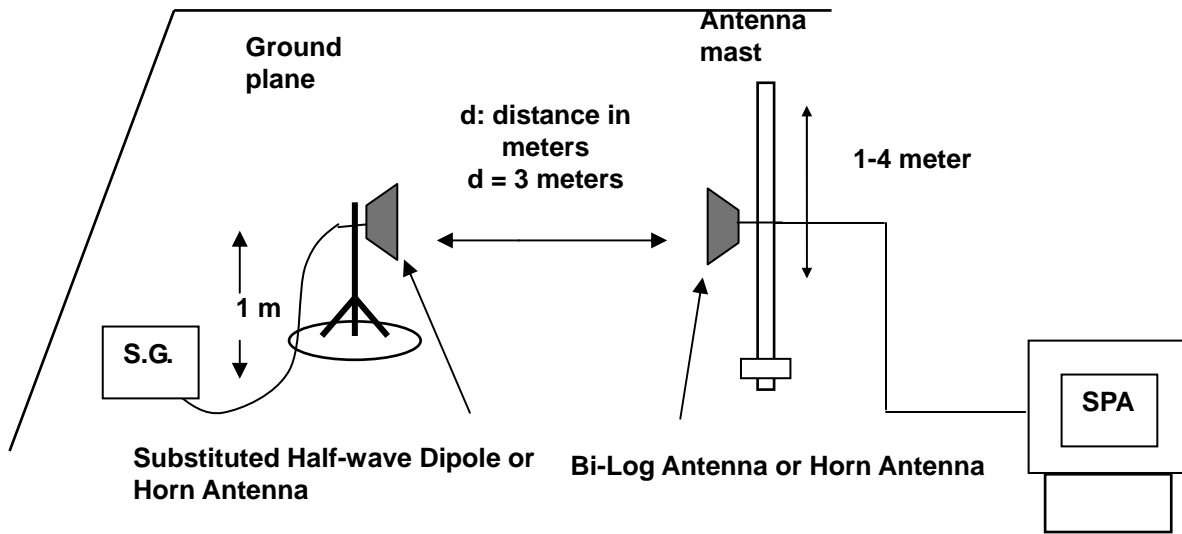

3.4. Test Procedure

- a. The EUT was set up for the maximum power with LTE link data modulation. The power was measured with Spectrum Analyzer. All measurements were done at 3 channels (low, middle and high operational frequency range). RBW and VBW is 5MHz for LTE and WCDMA mode.
- b. E.I.R.P power measurement. In the semi-anechoic chamber, EUT placed on the 0.8m height of Turn Table, rotated the table around 360 degrees to search the maximum radiation power and receiver antenna shall be rotated vertical and horizontal polarization and moved height from 1m to 4m to find the maximum polar radiated power. The "Read Value" is the spectrum reading the maximum power value.
- c. The substitution horn antenna is substituted for EUT at the same position and signals generator export the CW signal to the substitution antenna via a TX cable. Rotated the Turn Table and moved receiving antenna to find the maximum radiation power. Adjust output power level of S.G to get a Value of spectrum reading equal to "Read Value" of step a. Record the power level of S.G.
- d. E.I.R.P. = Output power level of S.G - TX cable loss + Antenna gain of substitution horn
- e. E.R.P. = E.I.R.P- 2.15 dB

3.5. Uncertainty

The measurement uncertainty is defined as for Field Strength of Spurious Radiation measurement is ± 3.072 dB.

3.6. Test Result

Model Number	LE910-NA V2		
Test Item	E.I.R.P. / E.R.P.		
Date of Test	08/03/2015	Test Site	TC03

LTE Band 2										
Channel Bandwidth	Modulation	CH	Frequency (MHz)	RB Configuration		Average Power (dBm)	Antenna Gain (dBi)	E.I.R.P.		Limit (W)
				Size	Offset			(dBm)	(W)	
1.4 M	QPSK	18900	1880.0	1	0	23.38	2.14	25.52	0.356	< 2
3 MHz	QPSK	18900	1880.0	1	0	23.39	2.14	25.53	0.357	< 2
5 MHz	QPSK	18900	1880.0	1	0	23.40	2.14	25.54	0.358	< 2
10 MHz	QPSK	18650	1855.0	1	0	23.30	2.14	25.44	0.350	< 2
15 MHz	QPSK	18900	1880.0	1	0	23.43	2.14	25.57	0.361	< 2
20 MHz	QPSK	18900	1880.0	1	0	23.41	2.14	25.55	0.359	< 2

LTE Band 4										
Channel Bandwidth	Modulation	CH	Frequency (MHz)	RB Configuration		Average Power (dBm)	Antenna Gain (dBi)	E.I.R.P.		Limit (W)
				Size	Offset			(dBm)	(W)	
1.4 M	QPSK	19957	1710.7	1	0	23.12	2.14	25.26	0.336	< 1
3 MHz	QPSK	19965	1711.5	1	0	22.99	2.14	25.13	0.326	< 1
5 MHz	QPSK	19975	1712.5	1	0	23.01	2.14	25.15	0.327	< 1
10 MHz	QPSK	20000	1715.0	1	0	23.07	2.14	25.21	0.332	< 1
15 MHz	QPSK	20025	1717.5	1	0	23.11	2.14	25.25	0.335	< 1
20 MHz	QPSK	20050	1720.0	1	0	23.08	2.14	25.22	0.333	< 1

LTE Band 5										
Channel Bandwidth	Modulation	CH	Frequency (MHz)	RB Configuration		Average Power (dBm)	Antenna Gain (dBi)	E.R.P.		Limit (W)
				Size	Offset			(dBm)	(W)	
1.4 M	QPSK	20643	848.3	1	0	22.81	2.14	22.80	0.191	< 7
3 MHz	QPSK	20635	847.5	1	0	22.90	2.14	22.89	0.195	< 7
5 MHz	QPSK	20625	846.5	1	0	22.77	2.14	22.76	0.189	< 7
10 MHz	QPSK	20600	844.0	1	0	22.79	2.14	22.78	0.190	< 7

LTE Band 12										
Channel Bandwidth	Modulation	CH	Frequency (MHz)	RB Configuration		Average Power (dBm)	Antenna Gain (dBi)	E.R.P.		Limit (W)
				Size	Offset			(dBm)	(W)	
1.4 MHz	QPSK	23173	715.3	1	0	22.81	2.14	24.95	0.313	< 30
3 MHz	QPSK	23165	714.5	1	0	22.86	2.14	25.00	0.316	< 30
5 MHz	QPSK	23155	713.5	1	0	22.77	2.14	24.91	0.310	< 30
10 MHz	QPSK	23130	711.0	1	0	22.79	2.14	24.93	0.311	< 30

LTE Band 13										
Channel Bandwidth	Modulation	CH	Frequency (MHz)	RB Configuration		Average Power (dBm)	Antenna Gain (dBi)	E.R.P.		Limit (W)
				Size	Offset			(dBm)	(W)	
5 MHz	QPSK	23255	784.5	1	0	22.88	2.14	25.02	0.318	< 30
10 MHz	QPSK	23230	782.0	1	0	22.74	2.14	24.88	0.308	< 30

LTE Band 17										
Channel Bandwidth	Modulation	CH	Frequency (MHz)	RB Configuration		Average Power (dBm)	Antenna Gain (dBi)	E.R.P.		Limit (W)
				Size	Offset			(dBm)	(W)	
5 MHz	QPSK	23755	706.5	1	0	22.90	2.14	22.89	0.195	< 3
		23825	713.5	1	0	22.90	2.14	22.89	0.195	< 3
10 MHz	QPSK	23780	709.0	1	0	22.95	2.14	22.94	0.197	< 3

4 Frequency Stability Test

4.1. Limit

According to the FCC rule shall be tested the frequency stability. The rule is defined that” The frequency stability shall be sufficient to ensure that the fundamental emissions stay within the authorized bands of operation. The test extreme voltage is according to the 2.1055(d)(1) Vary primary supply voltage from 85 to 115 percent of the nominal value for other than hand carried battery equipment and the extreme temperature rule is comply with the 2.1055(a)(1) -30°C ~ 50°C.

4.2. Test Instruments

Equipment	Manufacturer	Model No.	Serial No.	Cal. Date	Remark
Wideband Radio Communication Test	R & S	CMW500	103168	11/05/2014	(1)
Temperature & Humidity Chamber	TAICHY	MHU-225LA	980729	04/27/2015	(1)
Test Site	ATL	TE05	TE05	N.C.R.	-----

Remark: ⁽¹⁾ Calibration period 1 year. ⁽²⁾ Calibration period 2 years.

Note: N.C.R. = No Calibration Request.

4.3. Setup

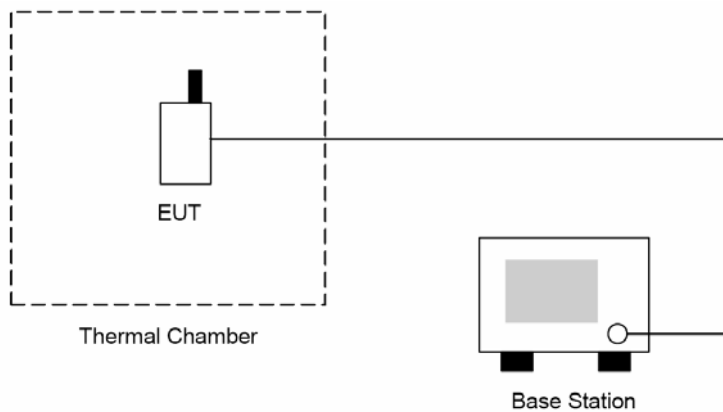

4.4. Test Procedure

The measurement is made according to FCC rules:

1. The EUT and test equipment were set up as shown on the following section.
2. With all power removed, the temperature was decreased to -30°C and permitted to stabilize for three hours. Power was applied and the maximum change in frequency was note within one minute.
3. With power OFF, the temperature was raised in 10°C steps. The sample was permitted to stabilize at each step for at least one-half hour. Power was applied and the maximum frequency change was noted within one minute.
4. The EUT was placed in a temperature chamber at $25 \pm 5^{\circ}\text{C}$ and connected as the following section.
5. The power supply voltage to the EUT was varied from BEP to 115% of the nominal value measured at the input to the EUT.
6. The temperature tests were performed for the worst case.
7. Test data was recorded.

4.5. Uncertainty

The measurement uncertainty is defined as for Frequency Stability measurement is $\pm 10\text{Hz}$.

4.6. Test Result

Model Number	LE910-NA V2		
Test Item	Frequency Stability		
Date of Test	06/18/2015	Test Site	TE05

LTE Band 2 _ QPSK						
Voltage						
Channel Bandwidth	Frequency (MHz)	Voltage [Vdc]	Temperature (°C)	Deviation (Hz)	Deviation (ppm)	Limit (ppm)
20 MHz	1880.0	4.20	20	1.76	0.001	± 2.5
		3.80	20	3.35	0.002	± 2.5
		3.40	20	-3.87	-0.002	± 2.5
Temperature						
Channel Bandwidth	Frequency (MHz)	Voltage [Vdc]	Temperature (°C)	Deviation (Hz)	Deviation (ppm)	Limit (ppm)
20 MHz	1880.0	3.80	-10	2.11	0.001	± 2.5
		3.80	0	3.04	0.002	± 2.5
		3.80	10	-3.85	-0.002	± 2.5
		3.80	20	-0.56	0.000	± 2.5
		3.80	30	-4.11	-0.002	± 2.5
		3.80	40	1.28	0.001	± 2.5
		3.80	50	6.90	0.004	± 2.5
		3.80	55	-14.24	-0.008	± 2.5

LTE Band 4 _ QPSK						
Voltage						
Channel Bandwidth	Frequency (MHz)	Voltage [Vdc]	Temperature (°C)	Deviation (Hz)	Deviation (ppm)	Limit (ppm)
20 MHz	1732.5	4.20	20	2.28	0.001	± 2.5
		3.80	20	0.56	0.000	± 2.5
		3.40	20	-6.58	-0.004	± 2.5
Temperature						
Channel Bandwidth	Frequency (MHz)	Voltage [Vdc]	Temperature (°C)	Deviation (Hz)	Deviation (ppm)	Limit (ppm)
20 MHz	1732.5	3.80	-10	0.78	0.000	± 2.5
		3.80	0	2.75	0.002	± 2.5
		3.80	10	-3.35	-0.002	± 2.5
		3.80	20	2.57	0.001	± 2.5
		3.80	30	-2.75	-0.002	± 2.5
		3.80	40	-0.98	-0.001	± 2.5
		3.80	50	6.29	0.004	± 2.5
		3.80	55	-11.71	-0.007	± 2.5

Note: The device temperature only support -10°C to +55°C.

LTE Band 5 _ QPSK						
Voltage						
Channel Bandwidth	Frequency (MHz)	Voltage [Vdc]	Temperature (°C)	Deviation (Hz)	Deviation (ppm)	Limit (ppm)
10 MHz	836.5	4.20	20	1.11	0.001	± 2.5
		3.80	20	0.73	0.001	± 2.5
		3.40	20	-3.74	-0.004	± 2.5
Temperature						
Channel Bandwidth	Frequency (MHz)	Voltage [Vdc]	Temperature (°C)	Deviation (Hz)	Deviation (ppm)	Limit (ppm)
10 MHz	836.5	3.80	-10	1.84	0.002	± 2.5
		3.80	0	1.49	0.002	± 2.5
		3.80	10	-4.86	-0.006	± 2.5
		3.80	20	-0.28	0.000	± 2.5
		3.80	30	-5.47	-0.007	± 2.5
		3.80	40	1.35	0.002	± 2.5
		3.80	50	4.49	0.005	± 2.5
		3.80	55	-13.63	-0.016	± 2.5

LTE Band 12 _ QPSK						
Voltage						
Channel Bandwidth	Frequency (MHz)	Voltage [Vdc]	Temperature (°C)	Deviation (Hz)	Deviation (ppm)	Limit (ppm)
10 MHz	705.5	4.20	20	2.34	0.003	± 2.5
		3.80	20	2.37	0.003	± 2.5
		3.40	20	-6.77	-0.010	± 2.5
Temperature						
Channel Bandwidth	Frequency (MHz)	Voltage [Vdc]	Temperature (°C)	Deviation (Hz)	Deviation (ppm)	Limit (ppm)
10 MHz	707.5	3.80	-10	3.41	0.005	± 2.5
		3.80	0	3.39	0.005	± 2.5
		3.80	10	-5.57	-0.008	± 2.5
		3.80	20	0.88	0.001	± 2.5
		3.80	30	-1.58	-0.002	± 2.5
		3.80	40	1.35	0.002	± 2.5
		3.80	50	3.93	0.006	± 2.5
		3.80	55	-12.54	-0.018	± 2.5

Note: The device temperature only support -10°C to +55°C.

LTE Band 13 _ QPSK						
Voltage						
Channel Bandwidth	Frequency (MHz)	Voltage [Vdc]	Temperature (°C)	Deviation (Hz)	Deviation (ppm)	Limit (ppm)
10 MHz	782.0	4.20	20	1.88	0.002	± 2.5
		3.80	20	1.79	0.002	± 2.5
		3.40	20	-7.01	-0.009	± 2.5
Temperature						
Channel Bandwidth	Frequency (MHz)	Voltage [Vdc]	Temperature (°C)	Deviation (Hz)	Deviation (ppm)	Limit (ppm)
10 MHz	782.0	3.80	-10	4.05	0.005	± 2.5
		3.80	0	3.80	0.005	± 2.5
		3.80	10	-3.85	-0.005	± 2.5
		3.80	20	1.17	0.001	± 2.5
		3.80	30	-3.84	-0.005	± 2.5
		3.80	40	-0.65	-0.001	± 2.5
		3.80	50	4.50	0.006	± 2.5
		3.80	55	-11.65	-0.015	± 2.5

LTE Band 17 _ QPSK						
Voltage						
Channel Bandwidth	Frequency (MHz)	Voltage [Vdc]	Temperature (°C)	Deviation (Hz)	Deviation (ppm)	Limit (ppm)
10 MHz	710.0	4.20	20	4.27	0.006	± 2.5
		3.80	20	3.20	0.005	± 2.5
		3.40	20	-3.24	-0.005	± 2.5
Temperature						
Channel Bandwidth	Frequency (MHz)	Voltage [Vdc]	Temperature (°C)	Deviation (Hz)	Deviation (ppm)	Limit (ppm)
10 MHz	710.0	3.80	-10	1.11	0.002	± 2.5
		3.80	0	1.05	0.001	± 2.5
		3.80	10	-4.62	-0.007	± 2.5
		3.80	20	1.40	0.002	± 2.5
		3.80	30	-4.92	-0.007	± 2.5
		3.80	40	-1.28	-0.002	± 2.5
		3.80	50	7.54	0.011	± 2.5
		3.80	55	-12.05	-0.017	± 2.5

Note: The device temperature only support -10°C to +55°C.

5 Emission Bandwidth & Occupied Bandwidth Test

5.1. Limit

The width of a frequency band such that, below the lower and above the upper frequency limits, the mean powers emitted are each equal to a specified percentage 0.5 %of the total mean power of a given emission.

The emission bandwidth is defined as the width of the signal between two points, located at the 2 sides of the carrier frequency, outside of which all emissions are attenuated at least 26 dB below the transmitter power.

5.2. Test Instruments

Equipment	Manufacturer	Model No.	Serial No.	Cal. Date	Remark
Spectrum Analyzer	Agilent	E4445A	MY46181986	05/14/2015	(1)
Wideband Radio Communication Test	R & S	CMW500	103168	11/05/2014	(1)
Attenuator	RADIALL	R41572000	0603033073	N.C.R.	-----
Power divider	Agilent	87302C	3239A00760	N.C.R.	-----
Test Site	ATL	TE05	TE05	N.C.R.	-----

Remark: ⁽¹⁾ Calibration period 1 year. ⁽²⁾ Calibration period 2 years.

Note: N.C.R. = No Calibration Request.

5.3. Setup

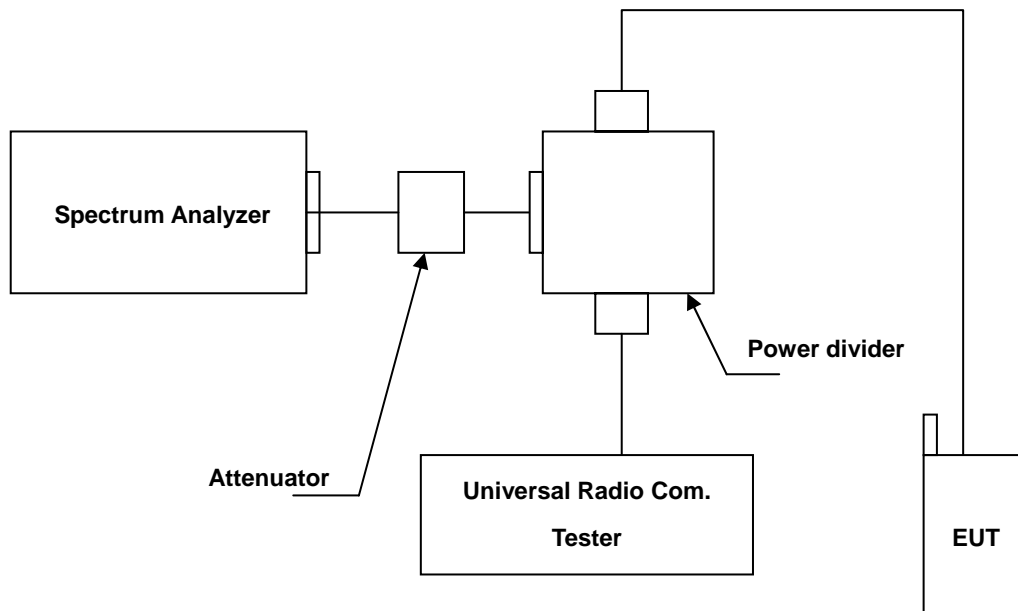

5.4. Test Procedure

The measurement is made according to FCC rules:

- a. The EUT makes a phone call to the communication simulator. The power was measured with R&S Spectrum Analyzer. All measurements were done at 3 channels. (low, middle and high operational frequency range.)
- b. The conducted occupied bandwidth used the power splitter via EUT RF power connector between simulation base station and spectrum analyzer.
- c. The communication simulator station system controlled a EUT to export maximum output power under transmission mode and specific channel frequency. Use OBW measurement function of Spectrum analyzer to measure 99 % occupied bandwidth.

5.5. Uncertainty

The measurement uncertainty is defined as $\pm 10\text{Hz}$

5.6. Test Result

Model Number	LE910-NA V2		
Test Item	Emission Bandwidth & Occupied Bandwidth		
Date of Test	06/11/2015	Test Site	TE05

LTE Band 2				
Modulation	Channel Bandwidth	Frequency (MHz)	26dB Bandwidth (MHz)	Occupied Bandwidth (MHz)
QPSK	1.4 MHz	1850.7	1.248	1.0854
		1880.0	1.248	1.0761
		1909.3	1.247	1.0837
	3 MHz	1851.5	2.965	2.6905
		1880.0	2.937	2.6827
		1908.5	2.971	2.6849
	5 MHz	1852.5	4.991	4.4720
		1880.0	4.849	4.4571
		1907.5	4.949	4.4698
	10 MHz	1855.0	9.863	8.9686
		1880.0	9.815	8.9667
		1905.0	9.778	8.9397
	15 MHz	1857.5	15.371	13.4528
		1880.0	14.617	13.4608
		1902.5	14.589	13.3895
	20 MHz	1860.0	19.361	17.8655
		1880.0	19.324	17.9052
		1900.0	19.538	17.8316
16QAM	1.4 MHz	1850.7	1.248	1.0847
		1880.0	1.248	1.0762
		1909.3	1.245	1.0826
	3 MHz	1851.5	2.973	2.6924
		1880.0	2.938	2.6821
		1908.5	2.932	2.6833
	5 MHz	1852.5	4.950	4.4686
		1880.0	4.871	4.4643
		1907.5	4.975	4.4683
	10 MHz	1855.0	9.821	8.9631
		1880.0	9.831	8.9604
		1905.0	9.742	8.9522
	15 MHz	1857.5	15.265	13.4425
		1880.0	14.837	13.4464
		1902.5	14.730	13.4010
	20 MHz	1860.0	19.203	17.8778
		1880.0	19.383	17.9027
		1900.0	19.538	17.7768

LTE Band 4				
Modulation	Channel Bandwidth	Frequency (MHz)	26dB Bandwidth (MHz)	Occupied Bandwidth (MHz)
QPSK	1.4 MHz	1710.7	1.302	1.0800
		1732.5	1.230	1.0834
		1754.3	1.295	1.0806
	3 MHz	1711.5	2.979	2.6882
		1732.5	2.973	2.6841
		1753.5	2.938	2.6788
	5 MHz	1712.5	4.878	4.4739
		1732.5	4.909	4.4611
		1752.5	4.898	4.4506
	10 MHz	1715.0	9.959	8.9670
		1732.5	9.854	8.9554
		1750.0	9.835	8.9723
	15 MHz	1717.5	15.297	13.4593
		1732.5	14.665	13.4221
		1747.5	15.039	13.4448
	20 MHz	1720.0	19.573	17.8902
		1732.5	19.484	17.8358
		1745.0	19.752	17.9703
16QAM	1.4 MHz	1710.7	1.307	1.0808
		1732.5	1.246	1.0832
		1754.3	1.277	1.0808
	3 MHz	1711.5	2.983	2.6873
		1732.5	2.981	2.6940
		1753.5	2.929	2.6803
	5 MHz	1712.5	4.861	4.4657
		1732.5	4.941	4.4657
		1752.5	4.866	4.4478
	10 MHz	1715.0	9.936	8.9679
		1732.5	9.923	8.9525
		1750.0	9.804	8.9652
	15 MHz	1717.5	14.921	13.4265
		1732.5	14.876	13.4029
		1747.5	15.039	13.4260
	20 MHz	1720.0	19.565	17.8961
		1732.5	19.504	17.8465
		1745.0	19.659	17.9862

LTE Band 5				
Modulation	Channel Bandwidth	Frequency (MHz)	26dB Bandwidth (MHz)	Occupied Bandwidth (MHz)
QPSK	1.4 MHz	824.7	1.283	1.0815
		836.5	1.222	1.0820
		848.3	1.246	1.0858
	3 MHz	825.5	2.965	2.6901
		836.5	2.953	2.6876
		847.5	2.948	2.6904
	5 MHz	826.5	4.923	4.4747
		836.5	4.891	4.4618
		846.5	4.848	4.4555
	10 MHz	829.0	9.888	8.9697
		836.5	9.813	8.9613
		844.0	9.787	8.9640
16QAM	1.4 MHz	824.7	1.282	1.0814
		836.5	1.232	1.0817
		848.3	1.239	1.0857
	3 MHz	825.5	2.954	2.6906
		836.5	2.966	2.6914
		847.5	2.928	2.6924
	5 MHz	826.5	4.903	4.4558
		836.5	4.915	4.4661
		846.5	4.802	4.4482
	10 MHz	829.0	9.841	8.9701
		836.5	9.768	8.9534
		844.0	9.792	8.9318

LTE Band 12				
Modulation	Channel Bandwidth	Frequency (MHz)	26dB Bandwidth (MHz)	Occupied Bandwidth (MHz)
QPSK	1.4 MHz	699.7	1.246	1.0891
		707.5	1.294	1.0796
		715.3	1.232	1.0823
	3 MHz	700.5	2.958	2.6928
		707.5	2.963	2.6947
		714.5	2.933	2.6874
	5 MHz	701.5	4.916	4.4600
		707.5	4.907	4.4589
		713.5	4.871	4.4548
	10 MHz	704.0	10.108	8.9831
		707.5	9.675	8.9567
		711.0	9.893	8.9505
16QAM	1.4 MHz	699.7	1.242	1.0870
		707.5	1.296	1.0814
		715.3	1.232	1.0817
	3 MHz	700.5	2.954	2.6919
		707.5	2.965	2.6946
		714.5	2.917	2.6868
	5 MHz	701.5	4.910	4.4605
		707.5	4.966	4.4658
		713.5	4.818	4.4490
	10 MHz	704.0	10.103	8.9834
		707.5	9.911	8.9548
		711.0	9.702	8.9481

LTE Band 13				
Modulation	Channel Bandwidth	Frequency (MHz)	-26dB Bandwidth (MHz)	Occupied Bandwidth (MHz)
QPSK	5 MHz	779.5	4.840	4.4606
		782.0	4.947	4.4669
		784.5	4.884	4.4500
16QAM		779.5	4.829	4.4560
		782.0	4.964	4.4717
		784.5	4.903	4.4482
QPSK	10 MHz	782.0	9.812	8.9809
16QAM		782.0	9.812	8.9625

LTE Band 17				
Channel Bandwidth	Modulation	Frequency (MHz)	-26dB Bandwidth (MHz)	Occupied Bandwidth (MHz)
QPSK	5 MHz	706.5	4.990	4.4758
		710.0	4.888	4.4559
		713.5	4.920	4.4752
	10 MHz	706.5	9.775	8.9568
		710.0	9.719	8.9352
		713.5	9.896	8.9558
16QAM	5 MHz	709.0	4.969	4.4770
		710.0	4.888	4.4634
		711.0	4.912	4.4647
	10 MHz	709.0	9.754	8.9507
		710.0	9.864	8.9502
		711.0	9.795	8.9435

5.7. Test Graphs

LTE Band 2 (Channel Bandwidth: 1.4 MHz) _ QPSK	
1850.7 MHz	<p>Agilent R T Freq/Channel</p> <p>Ch Freq 1.8507 GHz Trig Free</p> <p>Center Freq 1.8507000 GHz</p> <p>Start Freq 1.8492000 GHz</p> <p>Stop Freq 1.8522000 GHz</p> <p>CF Step 300.000000 kHz</p> <p>Freq Offset 0.0000000 Hz</p> <p>Signal Track On Off</p> <p>Ref 20 dBm Atten 30 dB</p> <p>#Peak Log 10 dB/Offst 4.3 dB</p> <p>Center 1.850 700 GHz Span 3 MHz</p> <p>#Res BW 15 kHz #VBW 15 kHz Sweep 16.08 ms (601 pts)</p> <p>Occupied Bandwidth 1.0854 MHz</p> <p>Occ BW % Pwr 99.00 %</p> <p>x dB -26.00 dB</p> <p>Transmit Freq Error -1.432 kHz</p> <p>x dB Bandwidth 1.248 MHz</p> <p>Copyright 2000-2006 Agilent Technologies</p>
1880.0 MHz	<p>Agilent R T Freq/Channel</p> <p>Ch Freq 1.88 GHz Trig Free</p> <p>Center Freq 1.8800000 GHz</p> <p>Start Freq 1.8785000 GHz</p> <p>Stop Freq 1.8815000 GHz</p> <p>CF Step 300.000000 kHz</p> <p>Freq Offset 0.0000000 Hz</p> <p>Signal Track On Off</p> <p>Ref 20 dBm Atten 30 dB</p> <p>#Peak Log 10 dB/Offst 4.3 dB</p> <p>Center 1.880 000 GHz Span 3 MHz</p> <p>#Res BW 15 kHz #VBW 15 kHz Sweep 16.08 ms (601 pts)</p> <p>Occupied Bandwidth 1.0761 MHz</p> <p>Occ BW % Pwr 99.00 %</p> <p>x dB -26.00 dB</p> <p>Transmit Freq Error 978.454 Hz</p> <p>x dB Bandwidth 1.248 MHz</p> <p>Copyright 2000-2006 Agilent Technologies</p>
1909.3 MHz	<p>Agilent R T Freq/Channel</p> <p>Ch Freq 1.9093 GHz Trig Free</p> <p>Center Freq 1.9093000 GHz</p> <p>Start Freq 1.9078000 GHz</p> <p>Stop Freq 1.9108000 GHz</p> <p>CF Step 300.000000 kHz</p> <p>Freq Offset 0.0000000 Hz</p> <p>Signal Track On Off</p> <p>Ref 20 dBm Atten 30 dB</p> <p>#Peak Log 10 dB/Offst 4.3 dB</p> <p>Center 1.909 300 GHz Span 3 MHz</p> <p>#Res BW 15 kHz #VBW 15 kHz Sweep 16.08 ms (601 pts)</p> <p>Occupied Bandwidth 1.0837 MHz</p> <p>Occ BW % Pwr 99.00 %</p> <p>x dB -26.00 dB</p> <p>Transmit Freq Error -1.573 kHz</p> <p>x dB Bandwidth 1.247 MHz</p> <p>Copyright 2000-2006 Agilent Technologies</p>

LTE Band 2 (Channel Bandwidth: 3 MHz) _ QPSK	
1851.5 MHz	<p>Agilent R T Freq/Channel</p> <p>Ch Freq 1.8515 GHz Trig Free</p> <p>Center Freq 1.85150000 GHz</p> <p>Start Freq 1.84850000 GHz</p> <p>Stop Freq 1.85450000 GHz</p> <p>CF Step 600.000000 kHz</p> <p>Freq Offset 0.00000000 Hz</p> <p>Signal Track On Off</p> <p>Ref 20 dBm Atten 30 dB</p> <p>#Peak 10</p> <p>Log dB/Offst 4.3 dB</p> <p>Center 1.851 500 GHz Span 6 MHz</p> <p>#Res BW 33 kHz #VBW 33 kHz Sweep 6.68 ms (601 pts)</p> <p>Occupied Bandwidth 2.6905 MHz</p> <p>Occ BW % Pwr 99.00 %</p> <p>x dB Bandwidth 2.965 MHz x dB -26.00 dB</p> <p>Transmit Freq Error 5.855 kHz</p> <p>Copyright 2000-2006 Agilent Technologies</p>
1880.0 MHz	<p>Agilent R T Freq/Channel</p> <p>Ch Freq 1.88 GHz Trig Free</p> <p>Center Freq 1.88000000 GHz</p> <p>Start Freq 1.87700000 GHz</p> <p>Stop Freq 1.88300000 GHz</p> <p>CF Step 600.000000 kHz</p> <p>Freq Offset 0.00000000 Hz</p> <p>Signal Track On Off</p> <p>Ref 20 dBm Atten 30 dB</p> <p>#Peak 10</p> <p>Log dB/Offst 4.3 dB</p> <p>Start 1.877 000 GHz Stop 1.883 000 GHz</p> <p>#Res BW 33 kHz #VBW 33 kHz Sweep 6.68 ms (601 pts)</p> <p>Occupied Bandwidth 2.6827 MHz</p> <p>Occ BW % Pwr 99.00 %</p> <p>x dB Bandwidth 2.937 MHz x dB -26.00 dB</p> <p>Transmit Freq Error 301.989 Hz</p> <p>Copyright 2000-2006 Agilent Technologies</p>
1908.5 MHz	<p>Agilent R T Freq/Channel</p> <p>Ch Freq 1.9085 GHz Trig Free</p> <p>Center Freq 1.90850000 GHz</p> <p>Start Freq 1.90550000 GHz</p> <p>Stop Freq 1.91150000 GHz</p> <p>CF Step 600.000000 kHz</p> <p>Freq Offset 0.00000000 Hz</p> <p>Signal Track On Off</p> <p>Ref 20 dBm Atten 30 dB</p> <p>#Peak 10</p> <p>Log dB/Offst 4.3 dB</p> <p>Center 1.908 500 GHz Span 6 MHz</p> <p>#Res BW 33 kHz #VBW 33 kHz Sweep 6.68 ms (601 pts)</p> <p>Occupied Bandwidth 2.6849 MHz</p> <p>Occ BW % Pwr 99.00 %</p> <p>x dB Bandwidth 2.971 MHz x dB -26.00 dB</p> <p>Transmit Freq Error -129.367 Hz</p> <p>Copyright 2000-2006 Agilent Technologies</p>

LTE Band 2 (Channel Bandwidth: 5 MHz) _ QPSK	
1852.5 MHz	<p>Agilent R T Freq/Channel</p> <p>Ch Freq 1.8525 GHz Trig Free</p> <p>Center Freq 1.85250000 GHz</p> <p>Start Freq 1.84750000 GHz</p> <p>Stop Freq 1.85750000 GHz</p> <p>CF Step 1.00000000 MHz</p> <p>Freq Offset 0.00000000 Hz</p> <p>Signal Track On Off</p> <p>Ref 20 dBm Atten 30 dB</p> <p>Peak 10 dB/Offst 4.3 dB</p> <p>Center 1.852 50 GHz Span 10 MHz</p> <p>Res BW 51 kHz VBW 51 kHz Sweep 4.64 ms (601 pts)</p> <p>Occupied Bandwidth 4.4720 MHz Occ BW % Pwr 99.00 % x dB -26.00 dB</p> <p>Transmit Freq Error 9.567 kHz</p> <p>x dB Bandwidth 4.991 MHz</p> <p>Copyright 2000-2006 Agilent Technologies</p>
1880.0 MHz	<p>Agilent R T Freq/Channel</p> <p>Ch Freq 1.88 GHz Trig Free</p> <p>Center Freq 1.88000000 GHz</p> <p>Start Freq 1.87500000 GHz</p> <p>Stop Freq 1.88500000 GHz</p> <p>CF Step 1.00000000 MHz</p> <p>Freq Offset 0.00000000 Hz</p> <p>Signal Track On Off</p> <p>Ref 20 dBm Atten 30 dB</p> <p>Peak 10 dB/Offst 4.3 dB</p> <p>Center 1.880 00 GHz Span 10 MHz</p> <p>Res BW 51 kHz VBW 51 kHz Sweep 4.64 ms (601 pts)</p> <p>Occupied Bandwidth 4.4571 MHz Occ BW % Pwr 99.00 % x dB -26.00 dB</p> <p>Transmit Freq Error -5.426 kHz</p> <p>x dB Bandwidth 4.849 MHz</p> <p>Copyright 2000-2006 Agilent Technologies</p>
1907.5 MHz	<p>Agilent R T Freq/Channel</p> <p>Ch Freq 1.9075 GHz Trig Free</p> <p>Center Freq 1.90750000 GHz</p> <p>Start Freq 1.90250000 GHz</p> <p>Stop Freq 1.91250000 GHz</p> <p>CF Step 1.00000000 MHz</p> <p>Freq Offset 0.00000000 Hz</p> <p>Signal Track On Off</p> <p>Ref 20 dBm Atten 30 dB</p> <p>Peak 10 dB/Offst 4.3 dB</p> <p>Center 1.907 50 GHz Span 10 MHz</p> <p>Res BW 51 kHz VBW 51 kHz Sweep 4.64 ms (601 pts)</p> <p>Occupied Bandwidth 4.4698 MHz Occ BW % Pwr 99.00 % x dB -26.00 dB</p> <p>Transmit Freq Error 1.182 kHz</p> <p>x dB Bandwidth 4.949 MHz</p> <p>Copyright 2000-2006 Agilent Technologies</p>

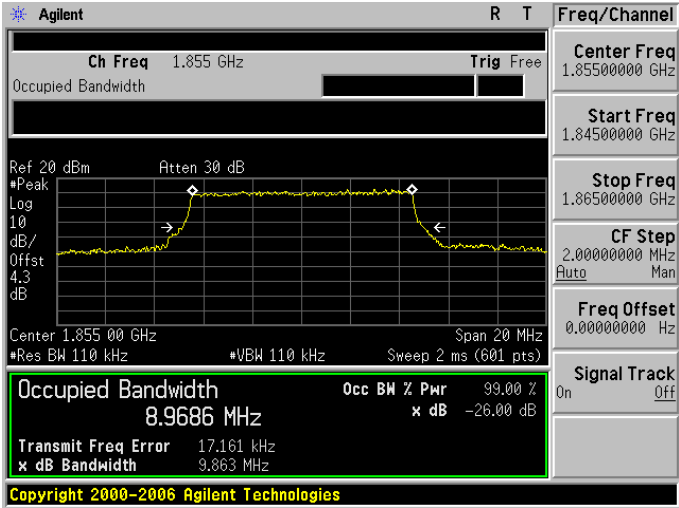
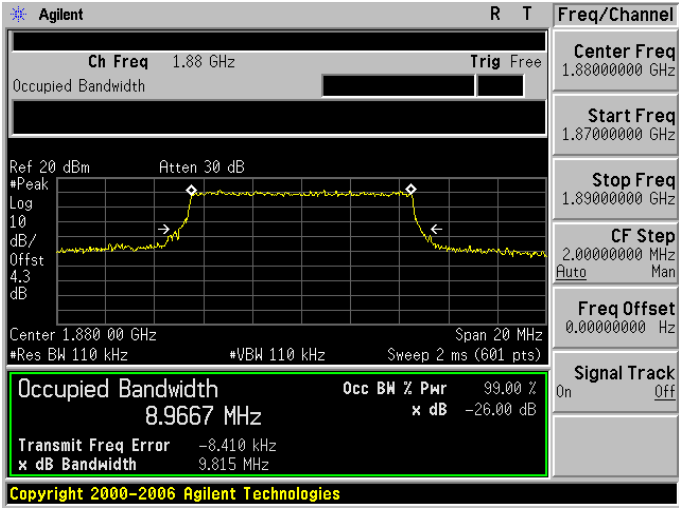
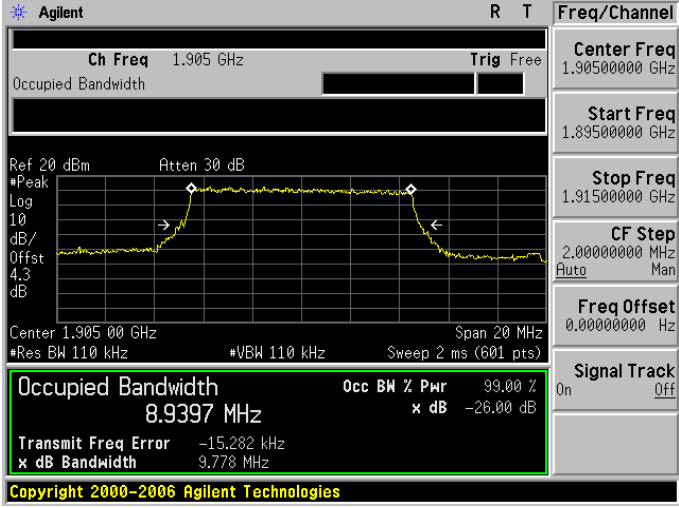
LTE Band 2 (Channel Bandwidth: 10 MHz) _ QPSK	
1855.0 MHz	 <p>Agilent R T Freq/Channel</p> <p>Ch Freq 1.855 GHz Trig Free</p> <p>Center Freq 1.85500000 GHz</p> <p>Start Freq 1.84500000 GHz</p> <p>Stop Freq 1.86500000 GHz</p> <p>CF Step 2.00000000 MHz Auto Man</p> <p>Freq Offset 0.00000000 Hz</p> <p>Signal Track On Off</p> <p>Ref 20 dBm Atten 30 dB</p> <p>Peak Log 10 dB/Offst 4.3 dB</p> <p>Center 1.855 00 GHz Span 20 MHz</p> <p>Res BW 110 kHz VBW 110 kHz Sweep 2 ms (601 pts)</p> <p>Occupied Bandwidth 8.9686 MHz Occ BW % Pwr 99.00 % x dB -26.00 dB</p> <p>Transmit Freq Error 17.161 kHz</p> <p>x dB Bandwidth 9.363 MHz</p> <p>Copyright 2000-2006 Agilent Technologies</p>
1880.0 MHz	 <p>Agilent R T Freq/Channel</p> <p>Ch Freq 1.88 GHz Trig Free</p> <p>Center Freq 1.88000000 GHz</p> <p>Start Freq 1.87000000 GHz</p> <p>Stop Freq 1.89000000 GHz</p> <p>CF Step 2.00000000 MHz Auto Man</p> <p>Freq Offset 0.00000000 Hz</p> <p>Signal Track On Off</p> <p>Ref 20 dBm Atten 30 dB</p> <p>Peak Log 10 dB/Offst 4.3 dB</p> <p>Center 1.880 00 GHz Span 20 MHz</p> <p>Res BW 110 kHz VBW 110 kHz Sweep 2 ms (601 pts)</p> <p>Occupied Bandwidth 8.9667 MHz Occ BW % Pwr 99.00 % x dB -26.00 dB</p> <p>Transmit Freq Error -8.410 kHz</p> <p>x dB Bandwidth 9.315 MHz</p> <p>Copyright 2000-2006 Agilent Technologies</p>
1905.0 MHz	 <p>Agilent R T Freq/Channel</p> <p>Ch Freq 1.905 GHz Trig Free</p> <p>Center Freq 1.90500000 GHz</p> <p>Start Freq 1.89500000 GHz</p> <p>Stop Freq 1.91500000 GHz</p> <p>CF Step 2.00000000 MHz Auto Man</p> <p>Freq Offset 0.00000000 Hz</p> <p>Signal Track On Off</p> <p>Ref 20 dBm Atten 30 dB</p> <p>Peak Log 10 dB/Offst 4.3 dB</p> <p>Center 1.905 00 GHz Span 20 MHz</p> <p>Res BW 110 kHz VBW 110 kHz Sweep 2 ms (601 pts)</p> <p>Occupied Bandwidth 8.9397 MHz Occ BW % Pwr 99.00 % x dB -26.00 dB</p> <p>Transmit Freq Error -15.282 kHz</p> <p>x dB Bandwidth 9.778 MHz</p> <p>Copyright 2000-2006 Agilent Technologies</p>

LTE Band 2 (Channel Bandwidth: 15 MHz) _ QPSK	
1857.5 MHz	<p>Agilent R T Freq/Channel</p> <p>Ch Freq 1.8575 GHz Trig Free</p> <p>Center Freq 1.85750000 GHz</p> <p>Start Freq 1.84250000 GHz</p> <p>Stop Freq 1.87250000 GHz</p> <p>CF Step 3.00000000 MHz</p> <p>Freq Offset 0.00000000 Hz</p> <p>Signal Track On Off</p> <p>Ref 20 dBm Atten 30 dB</p> <p>Peak</p> <p>Log 10</p> <p>dB/Offst 4.3 dB</p> <p>Center 1.857 50 GHz Span 30 MHz</p> <p>Res BW 160 kHz VBW 160 kHz Sweep 1.44 ms (601 pts)</p> <p>Occupied Bandwidth 13.4528 MHz Occ BW % Pwr 99.00 %</p> <p>Transmit Freq Error 32.975 kHz x dB -26.00 dB</p> <p>x dB Bandwidth 15.371 MHz</p> <p>Copyright 2000-2006 Agilent Technologies</p>
1880.0 MHz	<p>Agilent R T Freq/Channel</p> <p>Ch Freq 1.88 GHz Trig Free</p> <p>Center Freq 1.88000000 GHz</p> <p>Start Freq 1.86500000 GHz</p> <p>Stop Freq 1.89500000 GHz</p> <p>CF Step 3.00000000 MHz</p> <p>Freq Offset 0.00000000 Hz</p> <p>Signal Track On Off</p> <p>Ref 20 dBm Atten 30 dB</p> <p>Peak</p> <p>Log 10</p> <p>dB/Offst 4.3 dB</p> <p>Center 1.880 00 GHz Span 30 MHz</p> <p>Res BW 160 kHz VBW 160 kHz Sweep 1.44 ms (601 pts)</p> <p>Occupied Bandwidth 13.4608 MHz Occ BW % Pwr 99.00 %</p> <p>Transmit Freq Error -25.612 kHz x dB -26.00 dB</p> <p>x dB Bandwidth 14.617 MHz</p> <p>Copyright 2000-2006 Agilent Technologies</p>
1902.5 MHz	<p>Agilent R T Freq/Channel</p> <p>Ch Freq 1.9025 GHz Trig Free</p> <p>Center Freq 1.90250000 GHz</p> <p>Start Freq 1.88750000 GHz</p> <p>Stop Freq 1.91750000 GHz</p> <p>CF Step 3.00000000 MHz</p> <p>Freq Offset 0.00000000 Hz</p> <p>Signal Track On Off</p> <p>Ref 20 dBm Atten 30 dB</p> <p>Peak</p> <p>Log 10</p> <p>dB/Offst 4.3 dB</p> <p>Center 1.902 50 GHz Span 30 MHz</p> <p>Res BW 160 kHz VBW 160 kHz Sweep 1.44 ms (601 pts)</p> <p>Occupied Bandwidth 13.3895 MHz Occ BW % Pwr 99.00 %</p> <p>Transmit Freq Error -23.426 kHz x dB -26.00 dB</p> <p>x dB Bandwidth 14.589 MHz</p> <p>Copyright 2000-2006 Agilent Technologies</p>

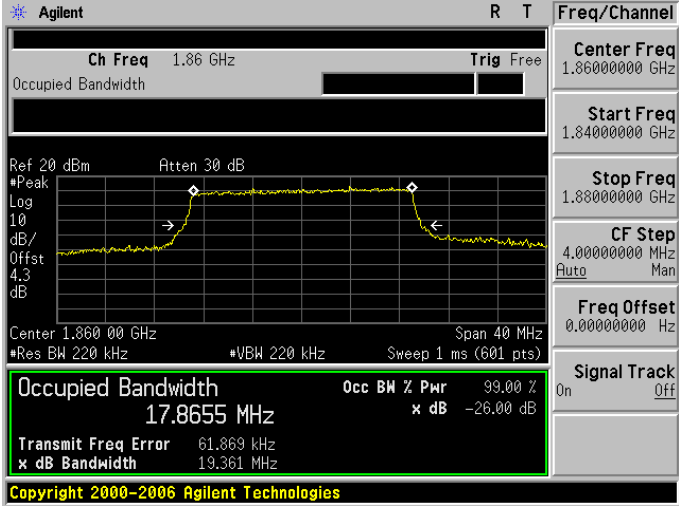
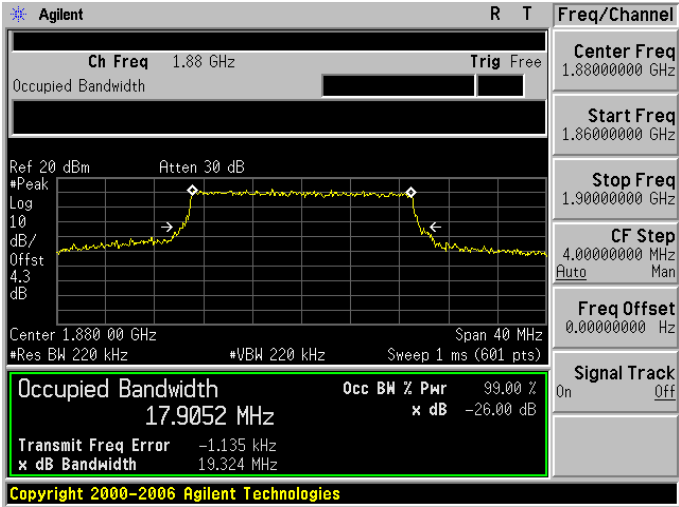
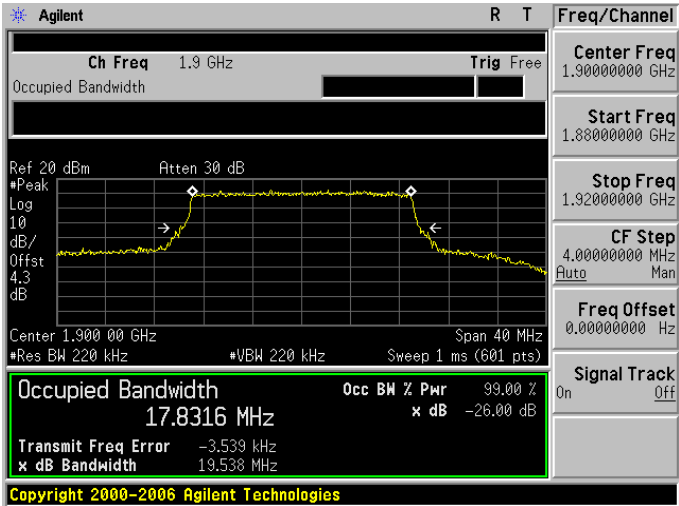
LTE Band 2 (Channel Bandwidth: 20 MHz) _ QPSK	
1860.0 MHz	 <p>Agilent R T Freq/Channel</p> <p>Ch Freq 1.86 GHz Trig Free</p> <p>Center Freq 1.86000000 GHz</p> <p>Start Freq 1.84000000 GHz</p> <p>Stop Freq 1.88000000 GHz</p> <p>CF Step 4.00000000 MHz</p> <p>Freq Offset 0.00000000 Hz</p> <p>Signal Track On Off</p> <p>Ref 20 dBm Atten 30 dB</p> <p>#Peak Log 10 dB/Offst 4.3 dB</p> <p>Center 1.860 00 GHz Span 40 MHz</p> <p>#Res BW 220 kHz #VBW 220 kHz Sweep 1 ms (601 pts)</p> <p>Occupied Bandwidth 17.8655 MHz</p> <p>Occ BW % Pwr 99.00 %</p> <p>x dB -26.00 dB</p> <p>Transmit Freq Error 61.869 kHz</p> <p>x dB Bandwidth 19.361 MHz</p> <p>Copyright 2000-2006 Agilent Technologies</p>
1880.0 MHz	 <p>Agilent R T Freq/Channel</p> <p>Ch Freq 1.88 GHz Trig Free</p> <p>Center Freq 1.88000000 GHz</p> <p>Start Freq 1.86000000 GHz</p> <p>Stop Freq 1.90000000 GHz</p> <p>CF Step 4.00000000 MHz</p> <p>Freq Offset 0.00000000 Hz</p> <p>Signal Track On Off</p> <p>Ref 20 dBm Atten 30 dB</p> <p>#Peak Log 10 dB/Offst 4.3 dB</p> <p>Center 1.880 00 GHz Span 40 MHz</p> <p>#Res BW 220 kHz #VBW 220 kHz Sweep 1 ms (601 pts)</p> <p>Occupied Bandwidth 17.9052 MHz</p> <p>Occ BW % Pwr 99.00 %</p> <p>x dB -26.00 dB</p> <p>Transmit Freq Error -1.135 kHz</p> <p>x dB Bandwidth 19.324 MHz</p> <p>Copyright 2000-2006 Agilent Technologies</p>
1900.0 MHz	 <p>Agilent R T Freq/Channel</p> <p>Ch Freq 1.9 GHz Trig Free</p> <p>Center Freq 1.90000000 GHz</p> <p>Start Freq 1.88000000 GHz</p> <p>Stop Freq 1.92000000 GHz</p> <p>CF Step 4.00000000 MHz</p> <p>Freq Offset 0.00000000 Hz</p> <p>Signal Track On Off</p> <p>Ref 20 dBm Atten 30 dB</p> <p>#Peak Log 10 dB/Offst 4.3 dB</p> <p>Center 1.900 00 GHz Span 40 MHz</p> <p>#Res BW 220 kHz #VBW 220 kHz Sweep 1 ms (601 pts)</p> <p>Occupied Bandwidth 17.8316 MHz</p> <p>Occ BW % Pwr 99.00 %</p> <p>x dB -26.00 dB</p> <p>Transmit Freq Error -3.539 kHz</p> <p>x dB Bandwidth 19.538 MHz</p> <p>Copyright 2000-2006 Agilent Technologies</p>

LTE Band 2 (Channel Bandwidth: 1.4 MHz) _ 16QAM	
1850.7 MHz	<p>Agilent R T Freq/Channel</p> <p>Ch Freq 1.8507 GHz Trig Free</p> <p>Center Freq 1.85070000 GHz</p> <p>Start Freq 1.84920000 GHz</p> <p>Stop Freq 1.85220000 GHz</p> <p>CF Step 300.000000 kHz</p> <p>Freq Offset 0.00000000 Hz</p> <p>Signal Track On Off</p> <p>Ref 20 dBm Atten 30 dB</p> <p>Peak 10 dB/Offst 4.3 dB</p> <p>Center 1.850 700 GHz Span 3 MHz</p> <p>Res BW 15 kHz VBW 15 kHz Sweep 16.08 ms (601 pts)</p> <p>Occupied Bandwidth 1.0847 MHz</p> <p>Occ BW % Pwr 99.00 %</p> <p>x dB -26.00 dB</p> <p>Transmit Freq Error -1.033 kHz</p> <p>x dB Bandwidth 1.248 MHz</p> <p>Copyright 2000-2006 Agilent Technologies</p>
1880.0 MHz	<p>Agilent R T Freq/Channel</p> <p>Ch Freq 1.88 GHz Trig Free</p> <p>Center Freq 1.88000000 GHz</p> <p>Start Freq 1.87850000 GHz</p> <p>Stop Freq 1.88150000 GHz</p> <p>CF Step 300.000000 kHz</p> <p>Freq Offset 0.00000000 Hz</p> <p>Signal Track On Off</p> <p>Ref 20 dBm Atten 30 dB</p> <p>Peak 10 dB/Offst 4.3 dB</p> <p>Center 1.880 000 GHz Span 3 MHz</p> <p>Res BW 15 kHz VBW 15 kHz Sweep 16.08 ms (601 pts)</p> <p>Occupied Bandwidth 1.0762 MHz</p> <p>Occ BW % Pwr 99.00 %</p> <p>x dB -26.00 dB</p> <p>Transmit Freq Error 977.008 Hz</p> <p>x dB Bandwidth 1.248 MHz</p> <p>Copyright 2000-2006 Agilent Technologies</p>
1909.3 MHz	<p>Agilent R T Freq/Channel</p> <p>Ch Freq 1.9093 GHz Trig Free</p> <p>Center Freq 1.90930000 GHz</p> <p>Start Freq 1.90780000 GHz</p> <p>Stop Freq 1.91080000 GHz</p> <p>CF Step 300.000000 kHz</p> <p>Freq Offset 0.00000000 Hz</p> <p>Signal Track On Off</p> <p>Ref 20 dBm Atten 30 dB</p> <p>Peak 10 dB/Offst 4.3 dB</p> <p>Center 1.909 300 GHz Span 3 MHz</p> <p>Res BW 15 kHz VBW 15 kHz Sweep 16.08 ms (601 pts)</p> <p>Occupied Bandwidth 1.0826 MHz</p> <p>Occ BW % Pwr 99.00 %</p> <p>x dB -26.00 dB</p> <p>Transmit Freq Error -2.583 kHz</p> <p>x dB Bandwidth 1.245 MHz</p> <p>Copyright 2000-2006 Agilent Technologies</p>

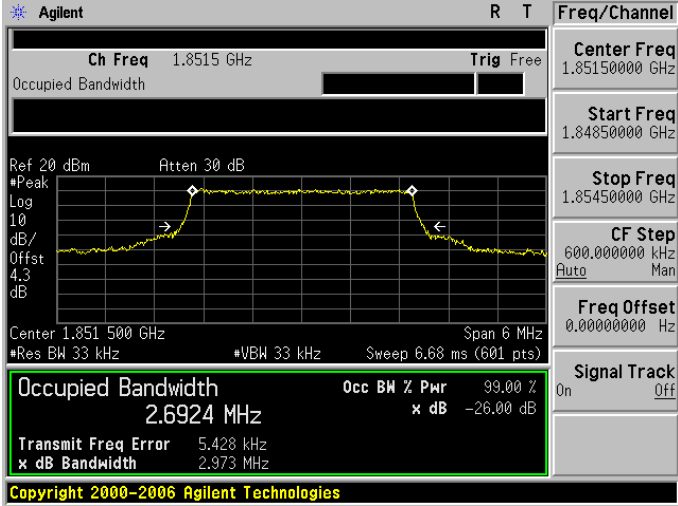
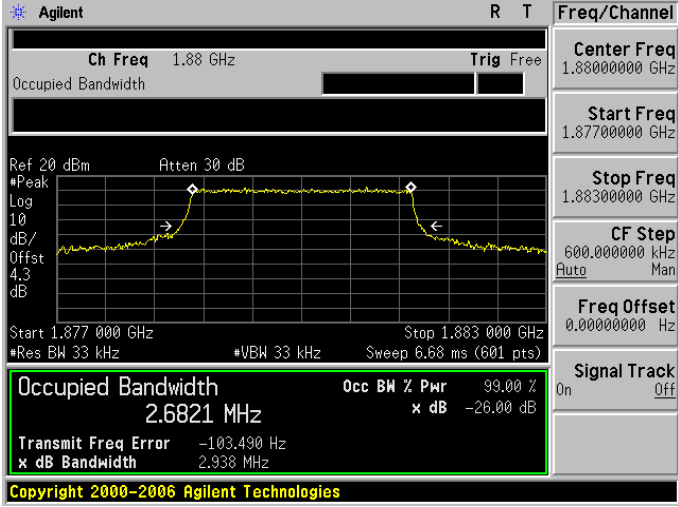
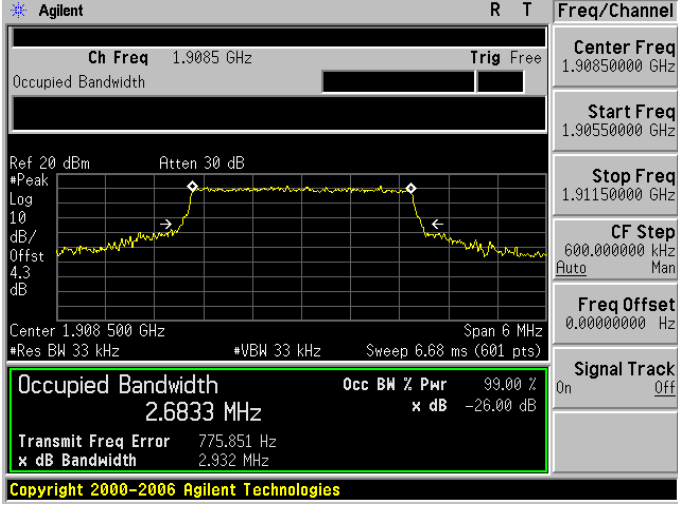
LTE Band 2 (Channel Bandwidth: 3 MHz) _ 16QAM	
1851.5 MHz	 <p>Agilent R T Freq/Channel</p> <p>Ch Freq 1.8515 GHz Trig Free</p> <p>Center Freq 1.85150000 GHz</p> <p>Start Freq 1.84850000 GHz</p> <p>Stop Freq 1.85450000 GHz</p> <p>CF Step 600.000000 kHz</p> <p>Freq Offset 0.00000000 Hz</p> <p>Signal Track On Off</p> <p>Ref 20 dBm Atten 30 dB</p> <p>#Peak 10</p> <p>Log dB/Offst 4.3 dB</p> <p>Center 1.851 500 GHz Span 6 MHz</p> <p>#Res BW 33 kHz #VBW 33 kHz Sweep 6.68 ms (601 pts)</p> <p>Occupied Bandwidth 2.6924 MHz</p> <p>Occ BW % Pwr 99.00 %</p> <p>x dB -26.00 dB</p> <p>Transmit Freq Error 5.428 kHz</p> <p>x dB Bandwidth 2.973 MHz</p> <p>Copyright 2000-2006 Agilent Technologies</p>
1880.0 MHz	 <p>Agilent R T Freq/Channel</p> <p>Ch Freq 1.88 GHz Trig Free</p> <p>Center Freq 1.88000000 GHz</p> <p>Start Freq 1.87700000 GHz</p> <p>Stop Freq 1.88300000 GHz</p> <p>CF Step 600.000000 kHz</p> <p>Freq Offset 0.00000000 Hz</p> <p>Signal Track On Off</p> <p>Ref 20 dBm Atten 30 dB</p> <p>#Peak 10</p> <p>Log dB/Offst 4.3 dB</p> <p>Start 1.877 000 GHz Stop 1.883 000 GHz</p> <p>#Res BW 33 kHz #VBW 33 kHz Sweep 6.68 ms (601 pts)</p> <p>Occupied Bandwidth 2.6821 MHz</p> <p>Occ BW % Pwr 99.00 %</p> <p>x dB -26.00 dB</p> <p>Transmit Freq Error -103.490 Hz</p> <p>x dB Bandwidth 2.938 MHz</p> <p>Copyright 2000-2006 Agilent Technologies</p>
1908.5 MHz	 <p>Agilent R T Freq/Channel</p> <p>Ch Freq 1.9085 GHz Trig Free</p> <p>Center Freq 1.90850000 GHz</p> <p>Start Freq 1.90550000 GHz</p> <p>Stop Freq 1.91150000 GHz</p> <p>CF Step 600.000000 kHz</p> <p>Freq Offset 0.00000000 Hz</p> <p>Signal Track On Off</p> <p>Ref 20 dBm Atten 30 dB</p> <p>#Peak 10</p> <p>Log dB/Offst 4.3 dB</p> <p>Center 1.908 500 GHz Span 6 MHz</p> <p>#Res BW 33 kHz #VBW 33 kHz Sweep 6.68 ms (601 pts)</p> <p>Occupied Bandwidth 2.6833 MHz</p> <p>Occ BW % Pwr 99.00 %</p> <p>x dB -26.00 dB</p> <p>Transmit Freq Error 775.851 Hz</p> <p>x dB Bandwidth 2.932 MHz</p> <p>Copyright 2000-2006 Agilent Technologies</p>

LTE Band 2 (Channel Bandwidth: 5 MHz) _ 16QAM	
1852.5 MHz	<p>Agilent R T Freq/Channel</p> <p>Ch Freq 1.8525 GHz Trig Free</p> <p>Center Freq 1.85250000 GHz</p> <p>Start Freq 1.84750000 GHz</p> <p>Stop Freq 1.85750000 GHz</p> <p>CF Step 1.00000000 MHz</p> <p>Freq Offset 0.00000000 Hz</p> <p>Signal Track On Off</p> <p>Ref 20 dBm Atten 30 dB</p> <p>#Peak Log 10 dB/Offst 4.3 dB</p> <p>Center 1.852 50 GHz Span 10 MHz</p> <p>#Res BW 51 kHz #VBW 51 kHz Sweep 4.64 ms (601 pts)</p> <p>Occupied Bandwidth 4.4686 MHz</p> <p>Occ BW % Pwr 99.00 %</p> <p>x dB -26.00 dB</p> <p>Transmit Freq Error 10.845 kHz</p> <p>x dB Bandwidth 4.950 MHz</p> <p>Copyright 2000-2006 Agilent Technologies</p>
1880.0 MHz	<p>Agilent R T Freq/Channel</p> <p>Ch Freq 1.88 GHz Trig Free</p> <p>Center Freq 1.88000000 GHz</p> <p>Start Freq 1.87500000 GHz</p> <p>Stop Freq 1.88500000 GHz</p> <p>CF Step 1.00000000 MHz</p> <p>Freq Offset 0.00000000 Hz</p> <p>Signal Track On Off</p> <p>Ref 20 dBm Atten 30 dB</p> <p>#Peak Log 10 dB/Offst 4.3 dB</p> <p>Center 1.880 00 GHz Span 10 MHz</p> <p>#Res BW 51 kHz #VBW 51 kHz Sweep 4.64 ms (601 pts)</p> <p>Occupied Bandwidth 4.4643 MHz</p> <p>Occ BW % Pwr 99.00 %</p> <p>x dB -26.00 dB</p> <p>Transmit Freq Error -630.273 Hz</p> <p>x dB Bandwidth 4.871 MHz</p> <p>Copyright 2000-2006 Agilent Technologies</p>
1907.5 MHz	<p>Agilent R T Freq/Channel</p> <p>Ch Freq 1.9075 GHz Trig Free</p> <p>Center Freq 1.90750000 GHz</p> <p>Start Freq 1.90250000 GHz</p> <p>Stop Freq 1.91250000 GHz</p> <p>CF Step 1.00000000 MHz</p> <p>Freq Offset 0.00000000 Hz</p> <p>Signal Track On Off</p> <p>Ref 20 dBm Atten 30 dB</p> <p>#Peak Log 10 dB/Offst 4.3 dB</p> <p>Center 1.907 50 GHz Span 10 MHz</p> <p>#Res BW 51 kHz #VBW 51 kHz Sweep 4.64 ms (601 pts)</p> <p>Occupied Bandwidth 4.4683 MHz</p> <p>Occ BW % Pwr 99.00 %</p> <p>x dB -26.00 dB</p> <p>Transmit Freq Error 4.008 kHz</p> <p>x dB Bandwidth 4.975 MHz</p> <p>Copyright 2000-2006 Agilent Technologies</p>

LTE Band 2 (Channel Bandwidth: 10 MHz) _ 16QAM	
1855.0 MHz	<p>Agilent R T Freq/Channel</p> <p>Ch Freq 1.855 GHz Trig Free</p> <p>Center Freq 1.8550000 GHz</p> <p>Start Freq 1.8450000 GHz</p> <p>Stop Freq 1.8650000 GHz</p> <p>CF Step 2.0000000 MHz Auto Man</p> <p>Freq Offset 0.0000000 Hz</p> <p>Signal Track On Off</p> <p>Ref 20 dBm Atten 30 dB</p> <p>#Peak Log 10 dB/Offst 4.3 dB</p> <p>Center 1.855 00 GHz Span 20 MHz</p> <p>#Res BW 110 kHz #VBW 110 kHz Sweep 2 ms (601 pts)</p> <p>Occupied Bandwidth 8.9631 MHz Occ BW % Pwr 99.00 % x dB -26.00 dB</p> <p>Transmit Freq Error 21.869 kHz</p> <p>x dB Bandwidth 9.821 MHz</p> <p>Copyright 2000-2006 Agilent Technologies</p>
1880.0 MHz	<p>Agilent R T Freq/Channel</p> <p>Ch Freq 1.88 GHz Trig Free</p> <p>Center Freq 1.8800000 GHz</p> <p>Start Freq 1.8700000 GHz</p> <p>Stop Freq 1.8900000 GHz</p> <p>CF Step 2.0000000 MHz Auto Man</p> <p>Freq Offset 0.0000000 Hz</p> <p>Signal Track On Off</p> <p>Ref 20 dBm Atten 30 dB</p> <p>#Peak Log 10 dB/Offst 4.3 dB</p> <p>Center 1.880 00 GHz Span 20 MHz</p> <p>#Res BW 110 kHz #VBW 110 kHz Sweep 2 ms (601 pts)</p> <p>Occupied Bandwidth 8.9604 MHz Occ BW % Pwr 99.00 % x dB -26.00 dB</p> <p>Transmit Freq Error -6.463 kHz</p> <p>x dB Bandwidth 9.831 MHz</p> <p>Copyright 2000-2006 Agilent Technologies</p>
1905.0 MHz	<p>Agilent R T Freq/Channel</p> <p>Ch Freq 1.905 GHz Trig Free</p> <p>Center Freq 1.9050000 GHz</p> <p>Start Freq 1.8950000 GHz</p> <p>Stop Freq 1.9150000 GHz</p> <p>CF Step 2.0000000 MHz Auto Man</p> <p>Freq Offset 0.0000000 Hz</p> <p>Signal Track On Off</p> <p>Ref 20 dBm Atten 30 dB</p> <p>#Peak Log 10 dB/Offst 4.3 dB</p> <p>Center 1.905 00 GHz Span 20 MHz</p> <p>#Res BW 110 kHz #VBW 110 kHz Sweep 2 ms (601 pts)</p> <p>Occupied Bandwidth 8.9522 MHz Occ BW % Pwr 99.00 % x dB -26.00 dB</p> <p>Transmit Freq Error -14.559 kHz</p> <p>x dB Bandwidth 9.742 MHz</p> <p>Copyright 2000-2006 Agilent Technologies</p>

LTE Band 2 (Channel Bandwidth: 15 MHz) _ 16QAM	
1857.5 MHz	<p>Agilent R T Freq/Channel</p> <p>Ch Freq 1.8575 GHz Trig Free</p> <p>Center Freq 1.85750000 GHz</p> <p>Start Freq 1.84250000 GHz</p> <p>Stop Freq 1.87250000 GHz</p> <p>CF Step 3.00000000 MHz Auto Man</p> <p>Freq Offset 0.00000000 Hz</p> <p>Signal Track On Off</p> <p>Ref 20 dBm Atten 30 dB</p> <p>#Peak Log 10 dB/Offst 4.3 dB</p> <p>Center 1.857 50 GHz Span 30 MHz</p> <p>#Res BW 160 kHz #VBW 160 kHz Sweep 1.44 ms (601 pts)</p> <p>Occupied Bandwidth 13.4528 MHz</p> <p>Occ BW % Pwr 99.00 %</p> <p>x dB Bandwidth 15.371 MHz x dB -26.00 dB</p> <p>Transmit Freq Error 32.975 kHz</p> <p>Copyright 2000-2006 Agilent Technologies</p>
1880.0 MHz	<p>Agilent R T Freq/Channel</p> <p>Ch Freq 1.88 GHz Trig Free</p> <p>Center Freq 1.88000000 GHz</p> <p>Start Freq 1.86500000 GHz</p> <p>Stop Freq 1.89500000 GHz</p> <p>CF Step 3.00000000 MHz Auto Man</p> <p>Freq Offset 0.00000000 Hz</p> <p>Signal Track On Off</p> <p>Ref 20 dBm Atten 30 dB</p> <p>#Peak Log 10 dB/Offst 4.3 dB</p> <p>Center 1.880 00 GHz Span 30 MHz</p> <p>#Res BW 160 kHz #VBW 160 kHz Sweep 1.44 ms (601 pts)</p> <p>Occupied Bandwidth 13.4608 MHz</p> <p>Occ BW % Pwr 99.00 %</p> <p>x dB Bandwidth 14.617 MHz x dB -26.00 dB</p> <p>Transmit Freq Error -25.612 kHz</p> <p>Copyright 2000-2006 Agilent Technologies</p>
1902.5 MHz	<p>Agilent R T Freq/Channel</p> <p>Ch Freq 1.9025 GHz Trig Free</p> <p>Center Freq 1.90250000 GHz</p> <p>Start Freq 1.88750000 GHz</p> <p>Stop Freq 1.91750000 GHz</p> <p>CF Step 3.00000000 MHz Auto Man</p> <p>Freq Offset 0.00000000 Hz</p> <p>Signal Track On Off</p> <p>Ref 20 dBm Atten 30 dB</p> <p>#Peak Log 10 dB/Offst 4.3 dB</p> <p>Center 1.902 50 GHz Span 30 MHz</p> <p>#Res BW 160 kHz #VBW 160 kHz Sweep 1.44 ms (601 pts)</p> <p>Occupied Bandwidth 13.3895 MHz</p> <p>Occ BW % Pwr 99.00 %</p> <p>x dB Bandwidth 14.589 MHz x dB -26.00 dB</p> <p>Transmit Freq Error -23.426 kHz</p> <p>Copyright 2000-2006 Agilent Technologies</p>

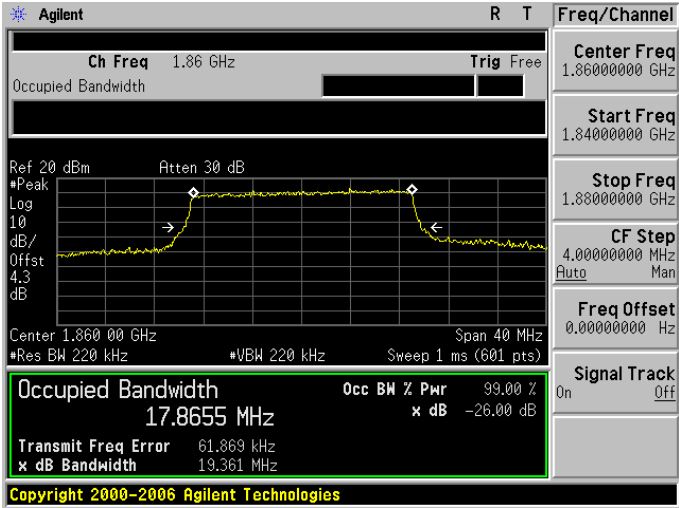
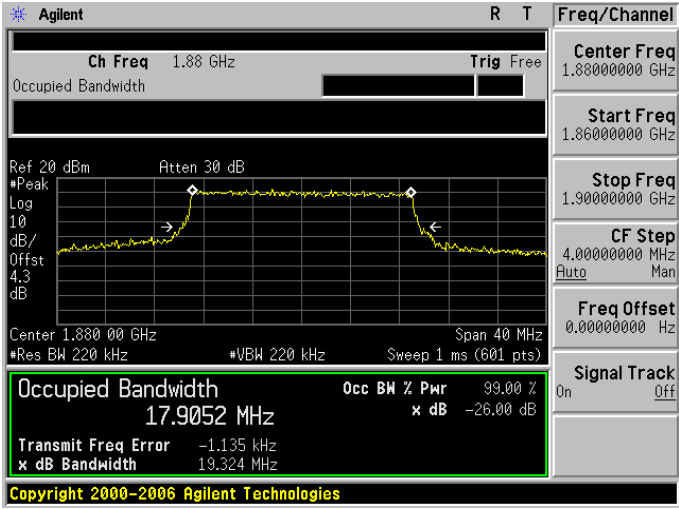
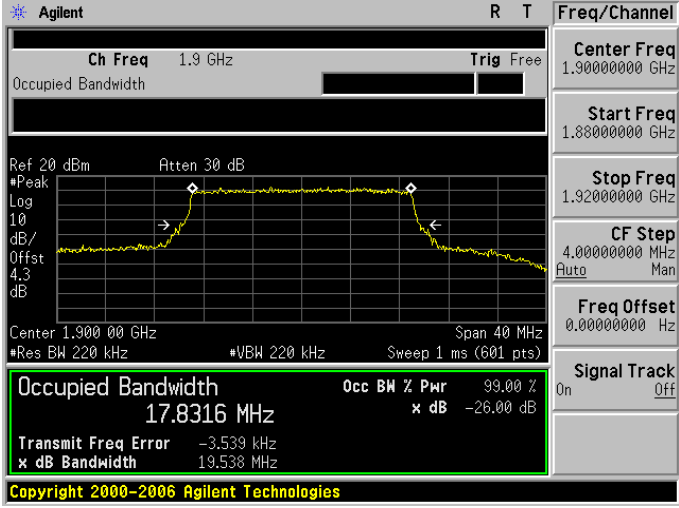
LTE Band 2 (Channel Bandwidth: 20 MHz) _ 16QAM	
1860.0 MHz	 <p>Agilent R T Freq/Channel</p> <p>Ch Freq 1.86 GHz Trig Free</p> <p>Center Freq 1.86000000 GHz</p> <p>Start Freq 1.84000000 GHz</p> <p>Stop Freq 1.88000000 GHz</p> <p>CF Step 4.00000000 MHz Auto Man</p> <p>Freq Offset 0.00000000 Hz</p> <p>Signal Track On Off</p> <p>Ref 20 dBm Atten 30 dB</p> <p>#Peak Log 10 dB/Offst 4.3 dB</p> <p>Center 1.860 00 GHz Span 40 MHz</p> <p>#Res BW 220 kHz #VBW 220 kHz Sweep 1 ms (601 pts)</p> <p>Occupied Bandwidth 17.8655 MHz</p> <p>Occ BW % Pwr 99.00 %</p> <p>x dB -26.00 dB</p> <p>Transmit Freq Error 61.869 kHz</p> <p>x dB Bandwidth 19.361 MHz</p> <p>Copyright 2000-2006 Agilent Technologies</p>
1880.0 MHz	 <p>Agilent R T Freq/Channel</p> <p>Ch Freq 1.88 GHz Trig Free</p> <p>Center Freq 1.88000000 GHz</p> <p>Start Freq 1.86000000 GHz</p> <p>Stop Freq 1.90000000 GHz</p> <p>CF Step 4.00000000 MHz Auto Man</p> <p>Freq Offset 0.00000000 Hz</p> <p>Signal Track On Off</p> <p>Ref 20 dBm Atten 30 dB</p> <p>#Peak Log 10 dB/Offst 4.3 dB</p> <p>Center 1.880 00 GHz Span 40 MHz</p> <p>#Res BW 220 kHz #VBW 220 kHz Sweep 1 ms (601 pts)</p> <p>Occupied Bandwidth 17.9052 MHz</p> <p>Occ BW % Pwr 99.00 %</p> <p>x dB -26.00 dB</p> <p>Transmit Freq Error -1.135 kHz</p> <p>x dB Bandwidth 19.324 MHz</p> <p>Copyright 2000-2006 Agilent Technologies</p>
1900.0 MHz	 <p>Agilent R T Freq/Channel</p> <p>Ch Freq 1.9 GHz Trig Free</p> <p>Center Freq 1.90000000 GHz</p> <p>Start Freq 1.88000000 GHz</p> <p>Stop Freq 1.92000000 GHz</p> <p>CF Step 4.00000000 MHz Auto Man</p> <p>Freq Offset 0.00000000 Hz</p> <p>Signal Track On Off</p> <p>Ref 20 dBm Atten 30 dB</p> <p>#Peak Log 10 dB/Offst 4.3 dB</p> <p>Center 1.900 00 GHz Span 40 MHz</p> <p>#Res BW 220 kHz #VBW 220 kHz Sweep 1 ms (601 pts)</p> <p>Occupied Bandwidth 17.8316 MHz</p> <p>Occ BW % Pwr 99.00 %</p> <p>x dB -26.00 dB</p> <p>Transmit Freq Error -3.539 kHz</p> <p>x dB Bandwidth 19.538 MHz</p> <p>Copyright 2000-2006 Agilent Technologies</p>

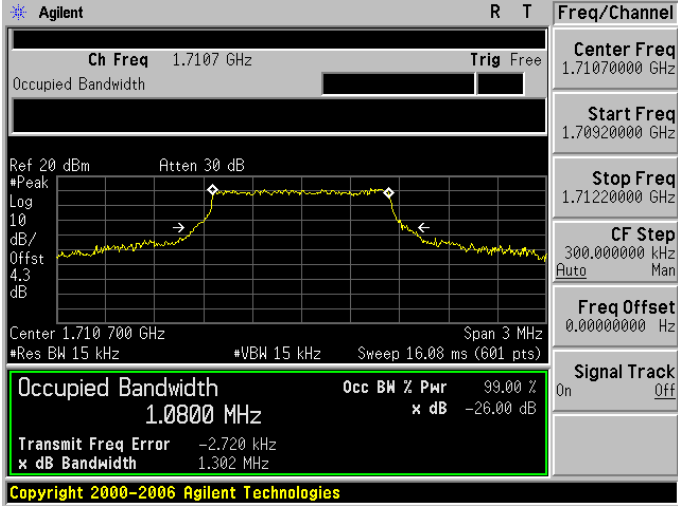
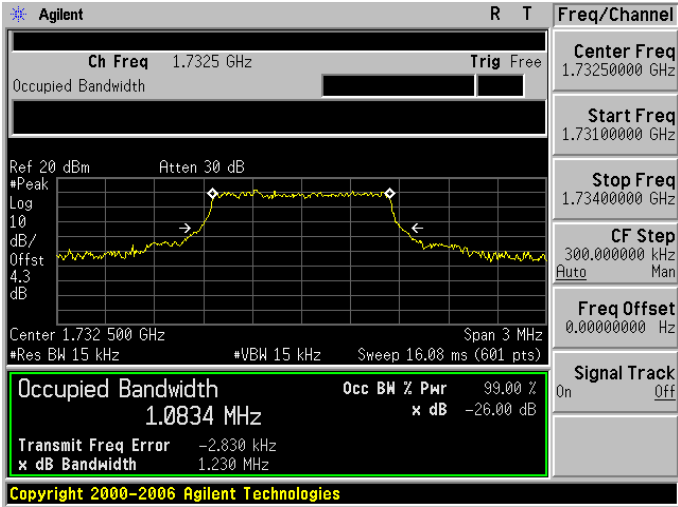
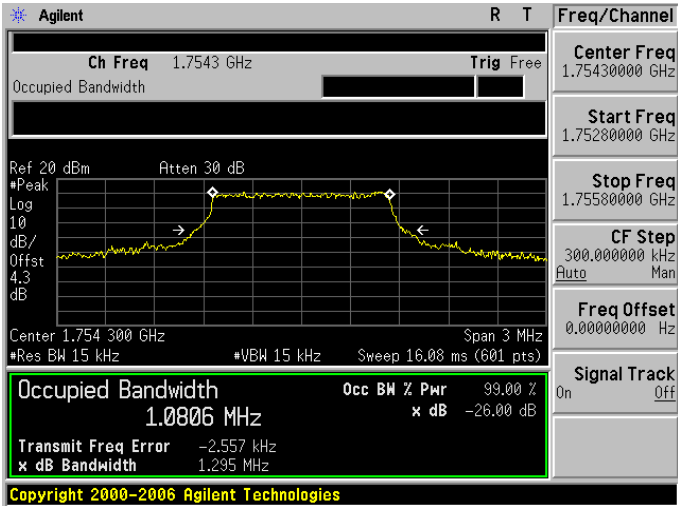
LTE Band 4 (Channel Bandwidth: 1.4 MHz) _ QPSK	
1710.7 MHz	 <p>Agilent R T Freq/Channel</p> <p>Ch Freq 1.7107 GHz Trig Free</p> <p>Center Freq 1.71070000 GHz</p> <p>Start Freq 1.70920000 GHz</p> <p>Stop Freq 1.71220000 GHz</p> <p>CF Step 300.000000 kHz</p> <p>Freq Offset 0.00000000 Hz</p> <p>Signal Track On Off</p> <p>Ref 20 dBm Atten 30 dB</p> <p>#Peak Log 10 dB/Offst 4.3 dB</p> <p>Center 1.710 700 GHz Span 3 MHz</p> <p>#Res BW 15 kHz #VBW 15 kHz Sweep 16.08 ms (601 pts)</p> <p>Occupied Bandwidth 1.0800 MHz</p> <p>Occ BW % Pwr 99.00 %</p> <p>x dB -26.00 dB</p> <p>Transmit Freq Error -2.720 kHz</p> <p>x dB Bandwidth 1.302 MHz</p> <p>Copyright 2000-2006 Agilent Technologies</p>
1732.5 MHz	 <p>Agilent R T Freq/Channel</p> <p>Ch Freq 1.7325 GHz Trig Free</p> <p>Center Freq 1.73250000 GHz</p> <p>Start Freq 1.73100000 GHz</p> <p>Stop Freq 1.73400000 GHz</p> <p>CF Step 300.000000 kHz</p> <p>Freq Offset 0.00000000 Hz</p> <p>Signal Track On Off</p> <p>Ref 20 dBm Atten 30 dB</p> <p>#Peak Log 10 dB/Offst 4.3 dB</p> <p>Center 1.732 500 GHz Span 3 MHz</p> <p>#Res BW 15 kHz #VBW 15 kHz Sweep 16.08 ms (601 pts)</p> <p>Occupied Bandwidth 1.0834 MHz</p> <p>Occ BW % Pwr 99.00 %</p> <p>x dB -26.00 dB</p> <p>Transmit Freq Error -2.830 kHz</p> <p>x dB Bandwidth 1.230 MHz</p> <p>Copyright 2000-2006 Agilent Technologies</p>
1754.3 MHz	 <p>Agilent R T Freq/Channel</p> <p>Ch Freq 1.7543 GHz Trig Free</p> <p>Center Freq 1.75430000 GHz</p> <p>Start Freq 1.75280000 GHz</p> <p>Stop Freq 1.75580000 GHz</p> <p>CF Step 300.000000 kHz</p> <p>Freq Offset 0.00000000 Hz</p> <p>Signal Track On Off</p> <p>Ref 20 dBm Atten 30 dB</p> <p>#Peak Log 10 dB/Offst 4.3 dB</p> <p>Center 1.754 300 GHz Span 3 MHz</p> <p>#Res BW 15 kHz #VBW 15 kHz Sweep 16.08 ms (601 pts)</p> <p>Occupied Bandwidth 1.0806 MHz</p> <p>Occ BW % Pwr 99.00 %</p> <p>x dB -26.00 dB</p> <p>Transmit Freq Error -2.557 kHz</p> <p>x dB Bandwidth 1.295 MHz</p> <p>Copyright 2000-2006 Agilent Technologies</p>

LTE Band 4 (Channel Bandwidth: 3 MHz) _ QPSK	
1711.5 MHz	<p>Agilent R T Freq/Channel</p> <p>Ch Freq 1.7115 GHz Trig Free</p> <p>Center Freq 1.71150000 GHz</p> <p>Start Freq 1.70850000 GHz</p> <p>Stop Freq 1.71450000 GHz</p> <p>CF Step 600.000000 kHz</p> <p>Freq Offset 0.00000000 Hz</p> <p>Signal Track On Off</p> <p>Ref 20 dBm Atten 30 dB</p> <p>#Peak 10</p> <p>Log dB/Offst 4.3 dB</p> <p>Center 1.711 500 GHz Span 6 MHz</p> <p>#Res BW 33 kHz #VBW 33 kHz Sweep 6.68 ms (601 pts)</p> <p>Occupied Bandwidth 2.6882 MHz</p> <p>Occ BW % Pwr 99.00 %</p> <p>x dB Bandwidth 2.979 MHz x dB -26.00 dB</p> <p>Transmit Freq Error 4.890 kHz</p> <p>Copyright 2000-2006 Agilent Technologies</p>
1732.5 MHz	<p>Agilent R T Freq/Channel</p> <p>Ch Freq 1.7325 GHz Trig Free</p> <p>Center Freq 1.73250000 GHz</p> <p>Start Freq 1.72950000 GHz</p> <p>Stop Freq 1.73550000 GHz</p> <p>CF Step 600.000000 kHz</p> <p>Freq Offset 0.00000000 Hz</p> <p>Signal Track On Off</p> <p>Ref 20 dBm Atten 30 dB</p> <p>#Peak 10</p> <p>Log dB/Offst 4.3 dB</p> <p>Center 1.732 500 GHz Span 6 MHz</p> <p>#Res BW 33 kHz #VBW 33 kHz Sweep 6.68 ms (601 pts)</p> <p>Occupied Bandwidth 2.6841 MHz</p> <p>Occ BW % Pwr 99.00 %</p> <p>x dB Bandwidth 2.973 MHz x dB -26.00 dB</p> <p>Transmit Freq Error 439.268 Hz</p> <p>Copyright 2000-2006 Agilent Technologies</p>
1753.5 MHz	<p>Agilent R T Freq/Channel</p> <p>Ch Freq 1.7535 GHz Trig Free</p> <p>Center Freq 1.75350000 GHz</p> <p>Start Freq 1.75050000 GHz</p> <p>Stop Freq 1.75650000 GHz</p> <p>CF Step 600.000000 kHz</p> <p>Freq Offset 0.00000000 Hz</p> <p>Signal Track On Off</p> <p>Ref 20 dBm Atten 30 dB</p> <p>#Peak 10</p> <p>Log dB/Offst 4.3 dB</p> <p>Center 1.753 500 GHz Span 6 MHz</p> <p>#Res BW 33 kHz #VBW 33 kHz Sweep 6.68 ms (601 pts)</p> <p>Occupied Bandwidth 2.6788 MHz</p> <p>Occ BW % Pwr 99.00 %</p> <p>x dB Bandwidth 2.938 MHz x dB -26.00 dB</p> <p>Transmit Freq Error 2.622 kHz</p> <p>Copyright 2000-2006 Agilent Technologies</p>

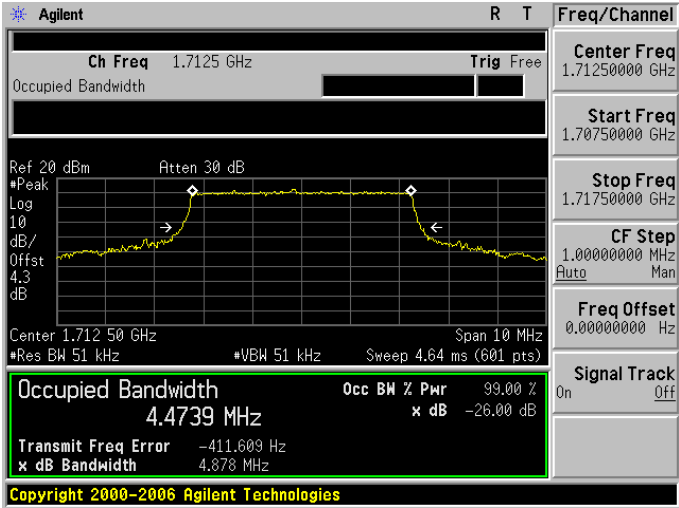
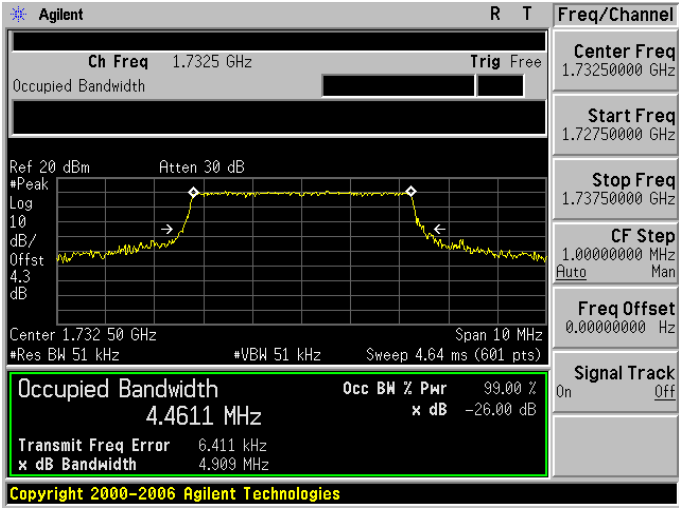
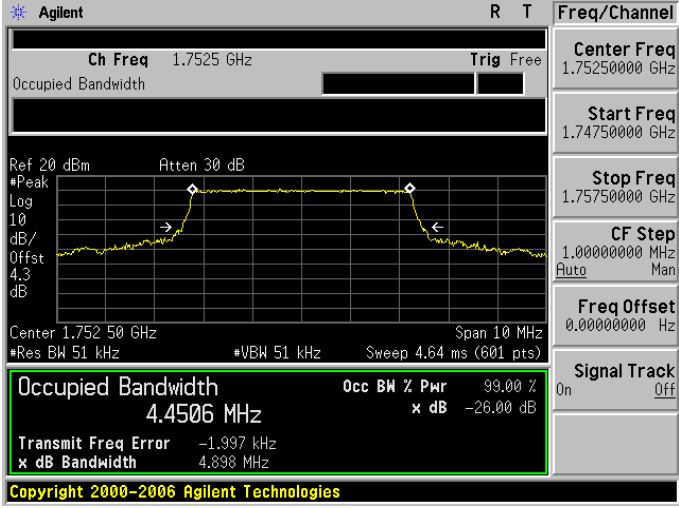
LTE Band 4 (Channel Bandwidth: 5 MHz) _ QPSK	
1712.5 MHz	 <p>Agilent R T Freq/Channel</p> <p>Ch Freq 1.7125 GHz Trig Free</p> <p>Center Freq 1.7125000 GHz</p> <p>Start Freq 1.7075000 GHz</p> <p>Stop Freq 1.7175000 GHz</p> <p>CF Step 1.00000000 MHz Auto Man</p> <p>Freq Offset 0.0000000 Hz</p> <p>Signal Track On Off</p> <p>Ref 20 dBm Atten 30 dB</p> <p>#Peak Log 10 dB/Offst 4.3 dB</p> <p>Center 1.712 50 GHz Span 10 MHz</p> <p>#Res BW 51 kHz #VBW 51 kHz Sweep 4.64 ms (601 pts)</p> <p>Occupied Bandwidth 4.4739 MHz</p> <p>Occ BW % Pwr 99.00 %</p> <p>x dB -26.00 dB</p> <p>Transmit Freq Error -411.609 Hz</p> <p>x dB Bandwidth 4.378 MHz</p> <p>Copyright 2000-2006 Agilent Technologies</p>
1732.5 MHz	 <p>Agilent R T Freq/Channel</p> <p>Ch Freq 1.7325 GHz Trig Free</p> <p>Center Freq 1.7325000 GHz</p> <p>Start Freq 1.7275000 GHz</p> <p>Stop Freq 1.7375000 GHz</p> <p>CF Step 1.00000000 MHz Auto Man</p> <p>Freq Offset 0.0000000 Hz</p> <p>Signal Track On Off</p> <p>Ref 20 dBm Atten 30 dB</p> <p>#Peak Log 10 dB/Offst 4.3 dB</p> <p>Center 1.732 50 GHz Span 10 MHz</p> <p>#Res BW 51 kHz #VBW 51 kHz Sweep 4.64 ms (601 pts)</p> <p>Occupied Bandwidth 4.4611 MHz</p> <p>Occ BW % Pwr 99.00 %</p> <p>x dB -26.00 dB</p> <p>Transmit Freq Error 6.411 kHz</p> <p>x dB Bandwidth 4.303 MHz</p> <p>Copyright 2000-2006 Agilent Technologies</p>
1752.5 MHz	 <p>Agilent R T Freq/Channel</p> <p>Ch Freq 1.7525 GHz Trig Free</p> <p>Center Freq 1.7525000 GHz</p> <p>Start Freq 1.7475000 GHz</p> <p>Stop Freq 1.7575000 GHz</p> <p>CF Step 1.00000000 MHz Auto Man</p> <p>Freq Offset 0.0000000 Hz</p> <p>Signal Track On Off</p> <p>Ref 20 dBm Atten 30 dB</p> <p>#Peak Log 10 dB/Offst 4.3 dB</p> <p>Center 1.752 50 GHz Span 10 MHz</p> <p>#Res BW 51 kHz #VBW 51 kHz Sweep 4.64 ms (601 pts)</p> <p>Occupied Bandwidth 4.4506 MHz</p> <p>Occ BW % Pwr 99.00 %</p> <p>x dB -26.00 dB</p> <p>Transmit Freq Error -1.997 kHz</p> <p>x dB Bandwidth 4.398 MHz</p> <p>Copyright 2000-2006 Agilent Technologies</p>

LTE Band 4 (Channel Bandwidth: 10 MHz) _ QPSK	
1715.0 MHz	<p>Agilent R T Freq/Channel</p> <p>Ch Freq 1.715 GHz Trig Free</p> <p>Center Freq 1.7150000 GHz</p> <p>Start Freq 1.7050000 GHz</p> <p>Stop Freq 1.7250000 GHz</p> <p>CF Step 2.00000000 MHz Auto Man</p> <p>Freq Offset 0.0000000 Hz</p> <p>Signal Track On Off</p> <p>Ref 20 dBm Atten 30 dB</p> <p>#Peak Log 10 dB/Offst 4.3 dB</p> <p>Center 1.715 00 GHz Span 20 MHz</p> <p>#Res BW 110 kHz #VBW 110 kHz Sweep 2 ms (601 pts)</p> <p>Occupied Bandwidth 8.9670 MHz</p> <p>Occ BW % Pwr 99.00 %</p> <p>x dB -26.00 dB</p> <p>Transmit Freq Error 9.435 kHz</p> <p>x dB Bandwidth 9.959 MHz</p> <p>Copyright 2000-2006 Agilent Technologies</p>
1732.5 MHz	<p>Agilent R T Freq/Channel</p> <p>Ch Freq 1.7325 GHz Trig Free</p> <p>Center Freq 1.7325000 GHz</p> <p>Start Freq 1.7225000 GHz</p> <p>Stop Freq 1.7425000 GHz</p> <p>CF Step 2.00000000 MHz Auto Man</p> <p>Freq Offset 0.0000000 Hz</p> <p>Signal Track On Off</p> <p>Ref 20 dBm Atten 30 dB</p> <p>#Peak Log 10 dB/Offst 4.3 dB</p> <p>Center 1.732 50 GHz Span 20 MHz</p> <p>#Res BW 110 kHz #VBW 110 kHz Sweep 2 ms (601 pts)</p> <p>Occupied Bandwidth 8.9554 MHz</p> <p>Occ BW % Pwr 99.00 %</p> <p>x dB -26.00 dB</p> <p>Transmit Freq Error 4.308 kHz</p> <p>x dB Bandwidth 9.854 MHz</p> <p>Copyright 2000-2006 Agilent Technologies</p>
1750.0 MHz	<p>Agilent R T Freq/Channel</p> <p>Ch Freq 1.75 GHz Trig Free</p> <p>Center Freq 1.7500000 GHz</p> <p>Start Freq 1.7400000 GHz</p> <p>Stop Freq 1.7600000 GHz</p> <p>CF Step 2.00000000 MHz Auto Man</p> <p>Freq Offset 0.0000000 Hz</p> <p>Signal Track On Off</p> <p>Ref 20 dBm Atten 30 dB</p> <p>#Peak Log 10 dB/Offst 4.3 dB</p> <p>Center 1.750 00 GHz Span 20 MHz</p> <p>#Res BW 110 kHz #VBW 110 kHz Sweep 2 ms (601 pts)</p> <p>Occupied Bandwidth 8.9723 MHz</p> <p>Occ BW % Pwr 99.00 %</p> <p>x dB -26.00 dB</p> <p>Transmit Freq Error -8.148 kHz</p> <p>x dB Bandwidth 9.835 MHz</p> <p>Copyright 2000-2006 Agilent Technologies</p>

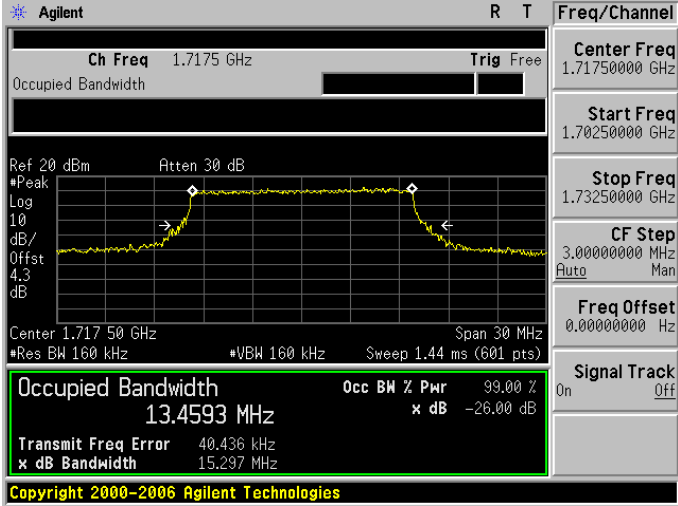
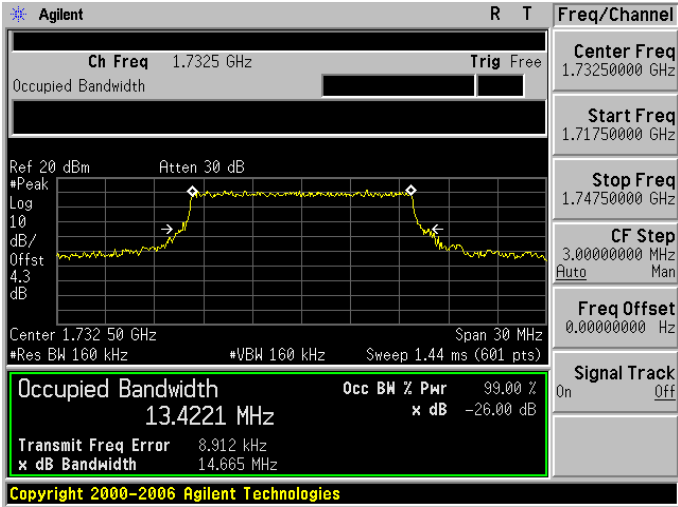
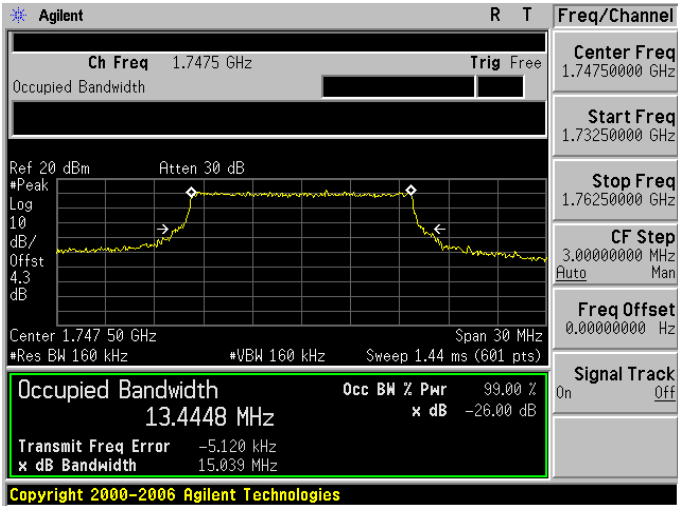
LTE Band 4 (Channel Bandwidth: 15 MHz) _ QPSK	
1717.5 MHz	 <p>Agilent R T Freq/Channel</p> <p>Ch Freq 1.7175 GHz Trig Free</p> <p>Center Freq 1.7175000 GHz</p> <p>Start Freq 1.7025000 GHz</p> <p>Stop Freq 1.7325000 GHz</p> <p>CF Step 3.0000000 MHz Auto Man</p> <p>Freq Offset 0.0000000 Hz</p> <p>Signal Track On Off</p> <p>Ref 20 dBm Atten 30 dB</p> <p>#Peak Log 10 dB/Offst 4.3 dB</p> <p>Center 1.717 50 GHz Span 30 MHz</p> <p>#Res BW 160 kHz #VBW 160 kHz Sweep 1.44 ms (601 pts)</p> <p>Occupied Bandwidth 13.4593 MHz Occ BW % Pwr 99.00 % x dB -26.00 dB</p> <p>Transmit Freq Error 40.436 kHz</p> <p>x dB Bandwidth 15.297 MHz</p> <p>Copyright 2000-2006 Agilent Technologies</p>
1732.5 MHz	 <p>Agilent R T Freq/Channel</p> <p>Ch Freq 1.7325 GHz Trig Free</p> <p>Center Freq 1.7325000 GHz</p> <p>Start Freq 1.7175000 GHz</p> <p>Stop Freq 1.7475000 GHz</p> <p>CF Step 3.0000000 MHz Auto Man</p> <p>Freq Offset 0.0000000 Hz</p> <p>Signal Track On Off</p> <p>Ref 20 dBm Atten 30 dB</p> <p>#Peak Log 10 dB/Offst 4.3 dB</p> <p>Center 1.732 50 GHz Span 30 MHz</p> <p>#Res BW 160 kHz #VBW 160 kHz Sweep 1.44 ms (601 pts)</p> <p>Occupied Bandwidth 13.4221 MHz Occ BW % Pwr 99.00 % x dB -26.00 dB</p> <p>Transmit Freq Error 8.912 kHz</p> <p>x dB Bandwidth 14.665 MHz</p> <p>Copyright 2000-2006 Agilent Technologies</p>
1747.5 MHz	 <p>Agilent R T Freq/Channel</p> <p>Ch Freq 1.7475 GHz Trig Free</p> <p>Center Freq 1.7475000 GHz</p> <p>Start Freq 1.7325000 GHz</p> <p>Stop Freq 1.7625000 GHz</p> <p>CF Step 3.0000000 MHz Auto Man</p> <p>Freq Offset 0.0000000 Hz</p> <p>Signal Track On Off</p> <p>Ref 20 dBm Atten 30 dB</p> <p>#Peak Log 10 dB/Offst 4.3 dB</p> <p>Center 1.747 50 GHz Span 30 MHz</p> <p>#Res BW 160 kHz #VBW 160 kHz Sweep 1.44 ms (601 pts)</p> <p>Occupied Bandwidth 13.4448 MHz Occ BW % Pwr 99.00 % x dB -26.00 dB</p> <p>Transmit Freq Error -5.120 kHz</p> <p>x dB Bandwidth 15.039 MHz</p> <p>Copyright 2000-2006 Agilent Technologies</p>

LTE Band 4 (Channel Bandwidth: 20 MHz) _ QPSK	
1720.0 MHz	<p>Agilent R T Freq/Channel</p> <p>Ch Freq 1.72 GHz Trig Free</p> <p>Center Freq 1.7200000 GHz</p> <p>Start Freq 1.7000000 GHz</p> <p>Stop Freq 1.7400000 GHz</p> <p>CF Step 4.0000000 MHz Auto Man</p> <p>Freq Offset 0.0000000 Hz</p> <p>Signal Track On Off</p> <p>Ref 20 dBm Atten 30 dB</p> <p>#Peak Log 10 dB/Offst 4.3 dB</p> <p>Center 1.720 00 GHz Span 40 MHz</p> <p>#Res BW 220 kHz #VBW 220 kHz Sweep 1 ms (601 pts)</p> <p>Occupied Bandwidth 17.8902 MHz Occ BW % Pwr 99.00 % x dB -26.00 dB</p> <p>Transmit Freq Error 54.557 kHz x dB Bandwidth 19.573 MHz</p> <p>Copyright 2000-2006 Agilent Technologies</p>
1732.5 MHz	<p>Agilent R T Freq/Channel</p> <p>Ch Freq 1.7325 GHz Trig Free</p> <p>Center Freq 1.7325000 GHz</p> <p>Start Freq 1.7125000 GHz</p> <p>Stop Freq 1.7525000 GHz</p> <p>CF Step 4.0000000 MHz Auto Man</p> <p>Freq Offset 0.0000000 Hz</p> <p>Signal Track On Off</p> <p>Ref 20 dBm Atten 30 dB</p> <p>#Peak Log 10 dB/Offst 4.3 dB</p> <p>Center 1.732 50 GHz Span 40 MHz</p> <p>#Res BW 220 kHz #VBW 220 kHz Sweep 1 ms (601 pts)</p> <p>Occupied Bandwidth 17.8358 MHz Occ BW % Pwr 99.00 % x dB -26.00 dB</p> <p>Transmit Freq Error -1.874 kHz x dB Bandwidth 19.484 MHz</p> <p>Copyright 2000-2006 Agilent Technologies</p>
1745.0 MHz	<p>Agilent R T Freq/Channel</p> <p>Ch Freq 1.745 GHz Trig Free</p> <p>Center Freq 1.7450000 GHz</p> <p>Start Freq 1.7250000 GHz</p> <p>Stop Freq 1.7650000 GHz</p> <p>CF Step 4.0000000 MHz Auto Man</p> <p>Freq Offset 0.0000000 Hz</p> <p>Signal Track On Off</p> <p>Ref 20 dBm Atten 30 dB</p> <p>#Peak Log 10 dB/Offst 4.3 dB</p> <p>Center 1.745 00 GHz Span 40 MHz</p> <p>#Res BW 220 kHz #VBW 220 kHz Sweep 1 ms (601 pts)</p> <p>Occupied Bandwidth 17.9703 MHz Occ BW % Pwr 99.00 % x dB -26.00 dB</p> <p>Transmit Freq Error -15.615 kHz x dB Bandwidth 19.752 MHz</p> <p>Copyright 2000-2006 Agilent Technologies</p>

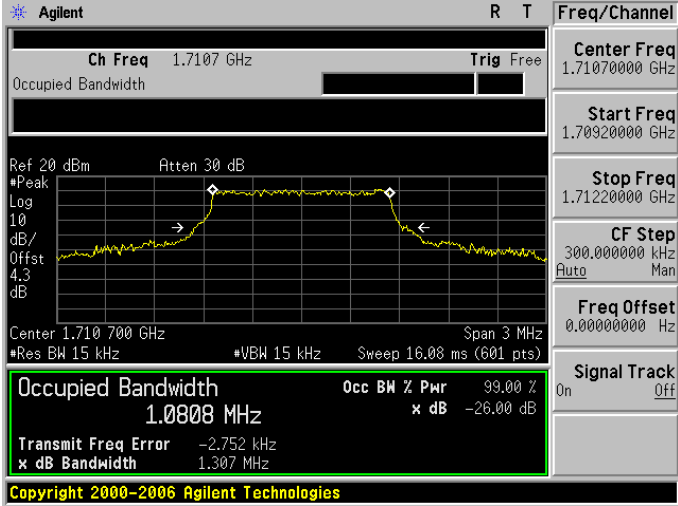
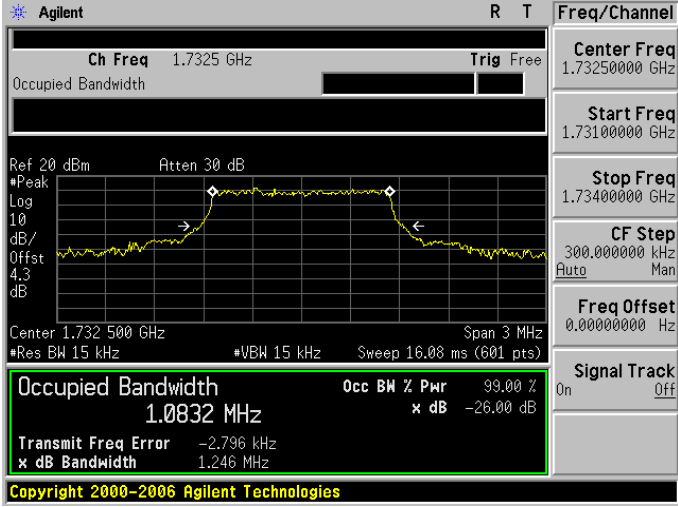
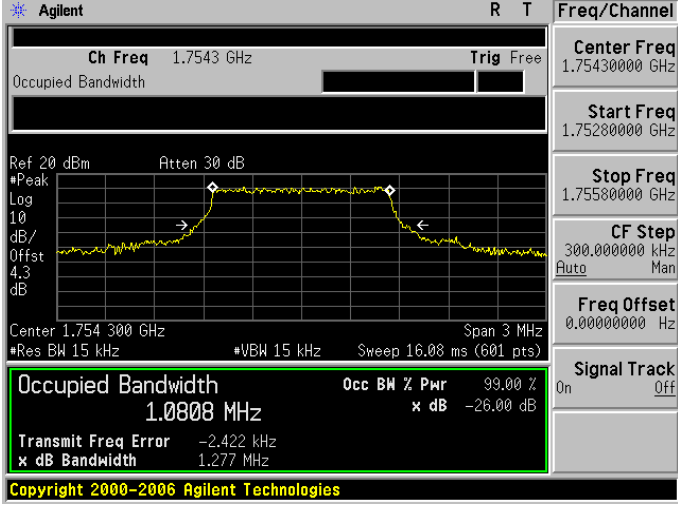
LTE Band 4 (Channel Bandwidth: 1.4 MHz) _ 16QAM	
1710.7 MHz	 <p>Agilent R T Freq/Channel</p> <p>Ch Freq 1.7107 GHz Trig Free</p> <p>Center Freq 1.71070000 GHz</p> <p>Start Freq 1.70920000 GHz</p> <p>Stop Freq 1.71220000 GHz</p> <p>CF Step 300.000000 kHz Auto Man</p> <p>Freq Offset 0.00000000 Hz</p> <p>Signal Track On Off</p> <p>Ref 20 dBm Atten 30 dB</p> <p>#Peak Log 10 dB/Offst 4.3 dB</p> <p>Center 1.710 700 GHz Span 3 MHz</p> <p>#Res BW 15 kHz #VBW 15 kHz Sweep 16.08 ms (601 pts)</p> <p>Occupied Bandwidth 1.0808 MHz</p> <p>Occ BW % Pwr 99.00 %</p> <p>x dB -26.00 dB</p> <p>Transmit Freq Error -2.752 kHz</p> <p>x dB Bandwidth 1.307 MHz</p> <p>Copyright 2000-2006 Agilent Technologies</p>
1732.5 MHz	 <p>Agilent R T Freq/Channel</p> <p>Ch Freq 1.7325 GHz Trig Free</p> <p>Center Freq 1.73250000 GHz</p> <p>Start Freq 1.73100000 GHz</p> <p>Stop Freq 1.73400000 GHz</p> <p>CF Step 300.000000 kHz Auto Man</p> <p>Freq Offset 0.00000000 Hz</p> <p>Signal Track On Off</p> <p>Ref 20 dBm Atten 30 dB</p> <p>#Peak Log 10 dB/Offst 4.3 dB</p> <p>Center 1.732 500 GHz Span 3 MHz</p> <p>#Res BW 15 kHz #VBW 15 kHz Sweep 16.08 ms (601 pts)</p> <p>Occupied Bandwidth 1.0832 MHz</p> <p>Occ BW % Pwr 99.00 %</p> <p>x dB -26.00 dB</p> <p>Transmit Freq Error -2.796 kHz</p> <p>x dB Bandwidth 1.246 MHz</p> <p>Copyright 2000-2006 Agilent Technologies</p>
1754.3 MHz	 <p>Agilent R T Freq/Channel</p> <p>Ch Freq 1.7543 GHz Trig Free</p> <p>Center Freq 1.75430000 GHz</p> <p>Start Freq 1.75280000 GHz</p> <p>Stop Freq 1.75580000 GHz</p> <p>CF Step 300.000000 kHz Auto Man</p> <p>Freq Offset 0.00000000 Hz</p> <p>Signal Track On Off</p> <p>Ref 20 dBm Atten 30 dB</p> <p>#Peak Log 10 dB/Offst 4.3 dB</p> <p>Center 1.754 300 GHz Span 3 MHz</p> <p>#Res BW 15 kHz #VBW 15 kHz Sweep 16.08 ms (601 pts)</p> <p>Occupied Bandwidth 1.0808 MHz</p> <p>Occ BW % Pwr 99.00 %</p> <p>x dB -26.00 dB</p> <p>Transmit Freq Error -2.422 kHz</p> <p>x dB Bandwidth 1.277 MHz</p> <p>Copyright 2000-2006 Agilent Technologies</p>

LTE Band 4 (Channel Bandwidth: 3 MHz) _ 16QAM	
1711.5 MHz	<p>Agilent R T Freq/Channel</p> <p>Ch Freq 1.7115 GHz Trig Free</p> <p>Center Freq 1.7115000 GHz</p> <p>Start Freq 1.7085000 GHz</p> <p>Stop Freq 1.7145000 GHz</p> <p>CF Step 600.000000 kHz Auto Man</p> <p>Freq Offset 0.0000000 Hz</p> <p>Signal Track On Off</p> <p>Ref 20 dBm Atten 30 dB</p> <p>#Peak 10</p> <p>Log dB/Offst 4.3 dB</p> <p>Center 1.711 500 GHz Span 6 MHz</p> <p>#Res BW 33 kHz #VBW 33 kHz Sweep 6.68 ms (601 pts)</p> <p>Occupied Bandwidth 2.6873 MHz Occ BW % Pwr 99.00 % x dB -26.00 dB</p> <p>Transmit Freq Error 3.406 kHz</p> <p>x dB Bandwidth 2.983 MHz</p> <p>Copyright 2000-2006 Agilent Technologies</p>
1732.5 MHz	<p>Agilent R T Freq/Channel</p> <p>Ch Freq 1.7325 GHz Trig Free</p> <p>Center Freq 1.7325000 GHz</p> <p>Start Freq 1.7295000 GHz</p> <p>Stop Freq 1.7355000 GHz</p> <p>CF Step 600.000000 kHz Auto Man</p> <p>Freq Offset 0.0000000 Hz</p> <p>Signal Track On Off</p> <p>Ref 20 dBm Atten 30 dB</p> <p>#Peak 10</p> <p>Log dB/Offst 4.3 dB</p> <p>Center 1.732 500 GHz Span 6 MHz</p> <p>#Res BW 33 kHz #VBW 33 kHz Sweep 6.68 ms (601 pts)</p> <p>Occupied Bandwidth 2.6940 MHz Occ BW % Pwr 99.00 % x dB -26.00 dB</p> <p>Transmit Freq Error 6.997 kHz</p> <p>x dB Bandwidth 2.981 MHz</p> <p>Copyright 2000-2006 Agilent Technologies</p>
1753.5 MHz	<p>Agilent R T Freq/Channel</p> <p>Ch Freq 1.7535 GHz Trig Free</p> <p>Center Freq 1.7535000 GHz</p> <p>Start Freq 1.7505000 GHz</p> <p>Stop Freq 1.7565000 GHz</p> <p>CF Step 600.000000 kHz Auto Man</p> <p>Freq Offset 0.0000000 Hz</p> <p>Signal Track On Off</p> <p>Ref 20 dBm Atten 30 dB</p> <p>#Peak 10</p> <p>Log dB/Offst 4.3 dB</p> <p>Center 1.753 500 GHz Span 6 MHz</p> <p>#Res BW 33 kHz #VBW 33 kHz Sweep 6.68 ms (601 pts)</p> <p>Occupied Bandwidth 2.6803 MHz Occ BW % Pwr 99.00 % x dB -26.00 dB</p> <p>Transmit Freq Error 2.618 kHz</p> <p>x dB Bandwidth 2.929 MHz</p> <p>Copyright 2000-2006 Agilent Technologies</p>

LTE Band 4 (Channel Bandwidth: 5 MHz) _ 16QAM	
1712.5 MHz	<p>Agilent R T Freq/Channel</p> <p>Ch Freq 1.7125 GHz Trig Free</p> <p>Center Freq 1.71250000 GHz</p> <p>Start Freq 1.70750000 GHz</p> <p>Stop Freq 1.71750000 GHz</p> <p>CF Step 1.00000000 MHz Auto Man</p> <p>Freq Offset 0.00000000 Hz</p> <p>Signal Track On Off</p> <p>Ref 20 dBm Atten 30 dB</p> <p>#Peak Log 10 dB/Offst 4.3 dB</p> <p>Center 1.712 50 GHz Span 10 MHz</p> <p>#Res BW 51 kHz #VBW 51 kHz Sweep 4.64 ms (601 pts)</p> <p>Occupied Bandwidth 4.4657 MHz</p> <p>Occ BW % Pwr 99.00 %</p> <p>x dB Bandwidth 4.861 MHz x dB -26.00 dB</p> <p>Transmit Freq Error 4.098 kHz</p> <p>Copyright 2000-2006 Agilent Technologies</p>
1732.5 MHz	<p>Agilent R T Freq/Channel</p> <p>Ch Freq 1.7325 GHz Trig Free</p> <p>Center Freq 1.73250000 GHz</p> <p>Start Freq 1.72750000 GHz</p> <p>Stop Freq 1.73750000 GHz</p> <p>CF Step 1.00000000 MHz Auto Man</p> <p>Freq Offset 0.00000000 Hz</p> <p>Signal Track On Off</p> <p>Ref 20 dBm Atten 30 dB</p> <p>#Peak Log 10 dB/Offst 4.3 dB</p> <p>Center 1.732 50 GHz Span 10 MHz</p> <p>#Res BW 51 kHz #VBW 51 kHz Sweep 4.64 ms (601 pts)</p> <p>Occupied Bandwidth 4.4657 MHz</p> <p>Occ BW % Pwr 99.00 %</p> <p>x dB Bandwidth 4.941 MHz x dB -26.00 dB</p> <p>Transmit Freq Error 2.989 kHz</p> <p>Copyright 2000-2006 Agilent Technologies</p>
1752.5 MHz	<p>Agilent R T Freq/Channel</p> <p>Ch Freq 1.7525 GHz Trig Free</p> <p>Center Freq 1.75250000 GHz</p> <p>Start Freq 1.74750000 GHz</p> <p>Stop Freq 1.75750000 GHz</p> <p>CF Step 1.00000000 MHz Auto Man</p> <p>Freq Offset 0.00000000 Hz</p> <p>Signal Track On Off</p> <p>Ref 20 dBm Atten 30 dB</p> <p>#Peak Log 10 dB/Offst 4.3 dB</p> <p>Center 1.752 50 GHz Span 10 MHz</p> <p>#Res BW 51 kHz #VBW 51 kHz Sweep 4.64 ms (601 pts)</p> <p>Occupied Bandwidth 4.4478 MHz</p> <p>Occ BW % Pwr 99.00 %</p> <p>x dB Bandwidth 4.866 MHz x dB -26.00 dB</p> <p>Transmit Freq Error 923.072 Hz</p> <p>Copyright 2000-2006 Agilent Technologies</p>

LTE Band 4 (Channel Bandwidth: 10 MHz) _ 16QAM	
1715.0 MHz	<p>Agilent R T Freq/Channel</p> <p>Ch Freq 1.715 GHz Trig Free</p> <p>Center Freq 1.7150000 GHz</p> <p>Start Freq 1.7050000 GHz</p> <p>Stop Freq 1.7250000 GHz</p> <p>CF Step 2.00000000 MHz Auto Man</p> <p>Freq Offset 0.0000000 Hz</p> <p>Signal Track On Off</p> <p>Ref 20 dBm Atten 30 dB</p> <p>#Peak 10</p> <p>Log dB/Offst 4.3 dB</p> <p>Center 1.715 00 GHz Span 20 MHz</p> <p>#Res BW 110 kHz #VBW 110 kHz Sweep 2 ms (601 pts)</p> <p>Occupied Bandwidth 8.9679 MHz</p> <p>Occ BW % Pwr 99.00 %</p> <p>x dB Bandwidth 9.336 MHz x dB -26.00 dB</p> <p>Transmit Freq Error 6.147 kHz</p> <p>Copyright 2000-2006 Agilent Technologies</p>
1732.5 MHz	<p>Agilent R T Freq/Channel</p> <p>Ch Freq 1.7325 GHz Trig Free</p> <p>Center Freq 1.7325000 GHz</p> <p>Start Freq 1.7225000 GHz</p> <p>Stop Freq 1.7425000 GHz</p> <p>CF Step 2.00000000 MHz Auto Man</p> <p>Freq Offset 0.0000000 Hz</p> <p>Signal Track On Off</p> <p>Ref 20 dBm Atten 30 dB</p> <p>#Peak 10</p> <p>Log dB/Offst 4.3 dB</p> <p>Center 1.732 50 GHz Span 20 MHz</p> <p>#Res BW 110 kHz #VBW 110 kHz Sweep 2 ms (601 pts)</p> <p>Occupied Bandwidth 8.9525 MHz</p> <p>Occ BW % Pwr 99.00 %</p> <p>x dB Bandwidth 9.323 MHz x dB -26.00 dB</p> <p>Transmit Freq Error 2.133 kHz</p> <p>Copyright 2000-2006 Agilent Technologies</p>
1750.0 MHz	<p>Agilent R T Freq/Channel</p> <p>Ch Freq 1.75 GHz Trig Free</p> <p>Center Freq 1.7500000 GHz</p> <p>Start Freq 1.7400000 GHz</p> <p>Stop Freq 1.7600000 GHz</p> <p>CF Step 2.00000000 MHz Auto Man</p> <p>Freq Offset 0.0000000 Hz</p> <p>Signal Track On Off</p> <p>Ref 20 dBm Atten 30 dB</p> <p>#Peak 10</p> <p>Log dB/Offst 4.3 dB</p> <p>Center 1.750 00 GHz Span 20 MHz</p> <p>#Res BW 110 kHz #VBW 110 kHz Sweep 2 ms (601 pts)</p> <p>Occupied Bandwidth 8.9652 MHz</p> <p>Occ BW % Pwr 99.00 %</p> <p>x dB Bandwidth 9.304 MHz x dB -26.00 dB</p> <p>Transmit Freq Error -1.981 kHz</p> <p>Copyright 2000-2006 Agilent Technologies</p>

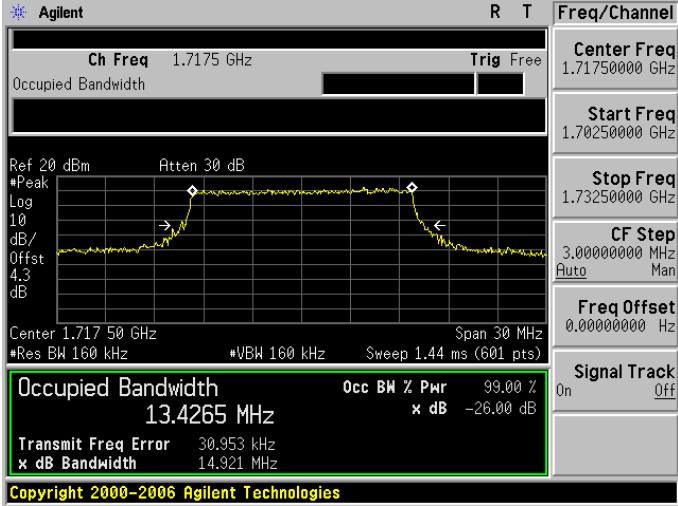
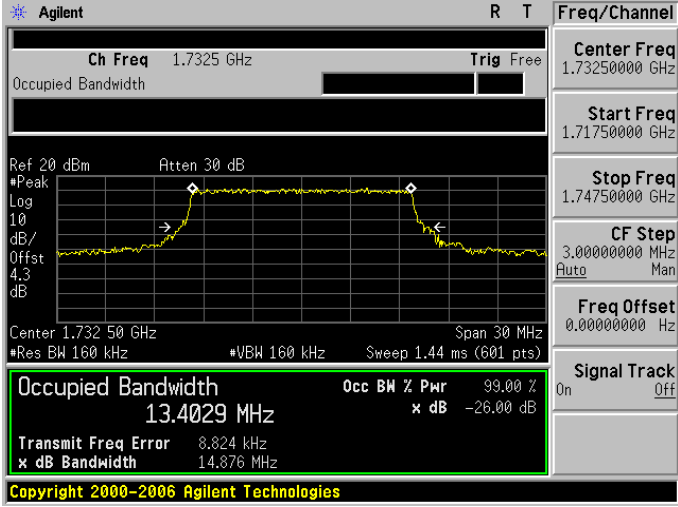
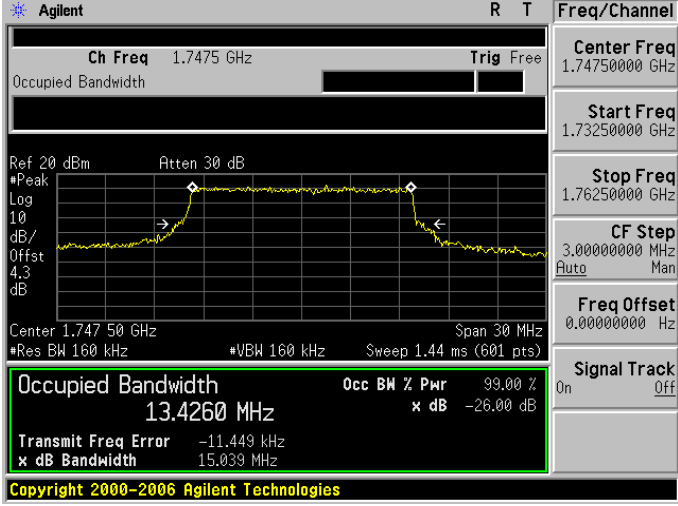
LTE Band 4 (Channel Bandwidth: 15 MHz) _ 16QAM	
1717.5 MHz	 <p>Agilent R T Freq/Channel</p> <p>Ch Freq 1.7175 GHz Trig Free</p> <p>Center Freq 1.7175000 GHz</p> <p>Start Freq 1.7025000 GHz</p> <p>Stop Freq 1.7325000 GHz</p> <p>CF Step 3.0000000 MHz Auto Man</p> <p>Freq Offset 0.0000000 Hz</p> <p>Signal Track On Off</p> <p>Ref 20 dBm Atten 30 dB</p> <p>#Peak Log 10 dB/Offst 4.3 dB</p> <p>Center 1.717 50 GHz Span 30 MHz</p> <p>#Res BW 160 kHz #VBW 160 kHz Sweep 1.44 ms (601 pts)</p> <p>Occupied Bandwidth 13.4265 MHz Occ BW % Pwr 99.00 % x dB -26.00 dB</p> <p>Transmit Freq Error 30.953 kHz</p> <p>x dB Bandwidth 14.921 MHz</p> <p>Copyright 2000-2006 Agilent Technologies</p>
1732.5 MHz	 <p>Agilent R T Freq/Channel</p> <p>Ch Freq 1.7325 GHz Trig Free</p> <p>Center Freq 1.7325000 GHz</p> <p>Start Freq 1.7175000 GHz</p> <p>Stop Freq 1.7475000 GHz</p> <p>CF Step 3.0000000 MHz Auto Man</p> <p>Freq Offset 0.0000000 Hz</p> <p>Signal Track On Off</p> <p>Ref 20 dBm Atten 30 dB</p> <p>#Peak Log 10 dB/Offst 4.3 dB</p> <p>Center 1.732 50 GHz Span 30 MHz</p> <p>#Res BW 160 kHz #VBW 160 kHz Sweep 1.44 ms (601 pts)</p> <p>Occupied Bandwidth 13.4029 MHz Occ BW % Pwr 99.00 % x dB -26.00 dB</p> <p>Transmit Freq Error 8.824 kHz</p> <p>x dB Bandwidth 14.876 MHz</p> <p>Copyright 2000-2006 Agilent Technologies</p>
1747.5 MHz	 <p>Agilent R T Freq/Channel</p> <p>Ch Freq 1.7475 GHz Trig Free</p> <p>Center Freq 1.7475000 GHz</p> <p>Start Freq 1.7325000 GHz</p> <p>Stop Freq 1.7625000 GHz</p> <p>CF Step 3.0000000 MHz Auto Man</p> <p>Freq Offset 0.0000000 Hz</p> <p>Signal Track On Off</p> <p>Ref 20 dBm Atten 30 dB</p> <p>#Peak Log 10 dB/Offst 4.3 dB</p> <p>Center 1.747 50 GHz Span 30 MHz</p> <p>#Res BW 160 kHz #VBW 160 kHz Sweep 1.44 ms (601 pts)</p> <p>Occupied Bandwidth 13.4260 MHz Occ BW % Pwr 99.00 % x dB -26.00 dB</p> <p>Transmit Freq Error -11.449 kHz</p> <p>x dB Bandwidth 15.039 MHz</p> <p>Copyright 2000-2006 Agilent Technologies</p>

LTE Band 4 (Channel Bandwidth: 20 MHz) _ 16QAM	
1720.0 MHz	<p>Agilent R T Freq/Channel</p> <p>Ch Freq 1.72 GHz Trig Free</p> <p>Center Freq 1.7200000 GHz</p> <p>Start Freq 1.7000000 GHz</p> <p>Stop Freq 1.7400000 GHz</p> <p>CF Step 4.0000000 MHz Auto Man</p> <p>Freq Offset 0.0000000 Hz</p> <p>Signal Track On Off</p> <p>Ref 20 dBm Atten 30 dB</p> <p>Peak 10 dB/Offst 4.3 dB</p> <p>Center 1.720 00 GHz Span 40 MHz</p> <p>Res BW 220 kHz #VBW 220 kHz Sweep 1 ms (601 pts)</p> <p>Occupied Bandwidth 17.8961 MHz Occ BW % Pwr 99.00 % x dB -26.00 dB</p> <p>Transmit Freq Error 56.650 kHz</p> <p>x dB Bandwidth 19.565 MHz</p> <p>Copyright 2000-2006 Agilent Technologies</p>
1732.5 MHz	<p>Agilent R T Freq/Channel</p> <p>Ch Freq 1.7325 GHz Trig Free</p> <p>Center Freq 1.7325000 GHz</p> <p>Start Freq 1.7125000 GHz</p> <p>Stop Freq 1.7525000 GHz</p> <p>CF Step 4.0000000 MHz Auto Man</p> <p>Freq Offset 0.0000000 Hz</p> <p>Signal Track On Off</p> <p>Ref 20 dBm Atten 30 dB</p> <p>Peak 10 dB/Offst 4.3 dB</p> <p>Center 1.732 50 GHz Span 40 MHz</p> <p>Res BW 220 kHz #VBW 220 kHz Sweep 1 ms (601 pts)</p> <p>Occupied Bandwidth 17.8465 MHz Occ BW % Pwr 99.00 % x dB -26.00 dB</p> <p>Transmit Freq Error 11.654 kHz</p> <p>x dB Bandwidth 19.504 MHz</p> <p>Copyright 2000-2006 Agilent Technologies</p>
1745.0 MHz	<p>Agilent R T Freq/Channel</p> <p>Ch Freq 1.745 GHz Trig Free</p> <p>Center Freq 1.7450000 GHz</p> <p>Start Freq 1.7250000 GHz</p> <p>Stop Freq 1.7650000 GHz</p> <p>CF Step 4.0000000 MHz Auto Man</p> <p>Freq Offset 0.0000000 Hz</p> <p>Signal Track On Off</p> <p>Ref 20 dBm Atten 30 dB</p> <p>Peak 10 dB/Offst 4.3 dB</p> <p>Center 1.745 00 GHz Span 40 MHz</p> <p>Res BW 220 kHz #VBW 220 kHz Sweep 1 ms (601 pts)</p> <p>Occupied Bandwidth 17.9862 MHz Occ BW % Pwr 99.00 % x dB -26.00 dB</p> <p>Transmit Freq Error -10.823 kHz</p> <p>x dB Bandwidth 19.659 MHz</p> <p>Copyright 2000-2006 Agilent Technologies</p>

LTE Band 5 (Channel Bandwidth: 1.4 MHz) _ QPSK	
824.7 MHz	<p>Agilent R T Freq/Channel</p> <p>Ch Freq 824.7 MHz Trig Free</p> <p>Center Freq 824.700000 MHz</p> <p>Start Freq 823.200000 MHz</p> <p>Stop Freq 826.200000 MHz</p> <p>CF Step 300.000000 kHz</p> <p>Freq Offset 0.00000000 Hz</p> <p>Signal Track On Off</p> <p>Ref 20 dBm Atten 30 dB</p> <p>Peak Log 10 dB/Offst 3.9 dB</p> <p>Center 824.700 MHz Span 3 MHz</p> <p>Res BW 15 kHz VBW 15 kHz Sweep 16.08 ms (601 pts)</p> <p>Occupied Bandwidth 1.0815 MHz</p> <p>Occ BW % Pwr 99.00 %</p> <p>x dB -26.00 dB</p> <p>Transmit Freq Error -1.431 kHz</p> <p>x dB Bandwidth 1.283 MHz</p> <p>Copyright 2000-2006 Agilent Technologies</p>
836.5 MHz	<p>Agilent R T Freq/Channel</p> <p>Ch Freq 836.5 MHz Trig Free</p> <p>Center Freq 836.500000 MHz</p> <p>Start Freq 835.000000 MHz</p> <p>Stop Freq 838.000000 MHz</p> <p>CF Step 300.000000 kHz</p> <p>Freq Offset 0.00000000 Hz</p> <p>Signal Track On Off</p> <p>Ref 20 dBm Atten 30 dB</p> <p>Peak Log 10 dB/Offst 3.9 dB</p> <p>Center 836.500 MHz Span 3 MHz</p> <p>Res BW 15 kHz VBW 15 kHz Sweep 16.08 ms (601 pts)</p> <p>Occupied Bandwidth 1.0820 MHz</p> <p>Occ BW % Pwr 99.00 %</p> <p>x dB -26.00 dB</p> <p>Transmit Freq Error -72.727 Hz</p> <p>x dB Bandwidth 1.222 MHz</p> <p>Copyright 2000-2006 Agilent Technologies</p>
848.3 MHz	<p>Agilent R T Freq/Channel</p> <p>Ch Freq 848.3 MHz Trig Free</p> <p>Center Freq 848.300000 MHz</p> <p>Start Freq 846.800000 MHz</p> <p>Stop Freq 849.800000 MHz</p> <p>CF Step 300.000000 kHz</p> <p>Freq Offset 0.00000000 Hz</p> <p>Signal Track On Off</p> <p>Ref 20 dBm Atten 30 dB</p> <p>Peak Log 10 dB/Offst 3.9 dB</p> <p>Center 848.300 MHz Span 3 MHz</p> <p>Res BW 15 kHz VBW 15 kHz Sweep 16.08 ms (601 pts)</p> <p>Occupied Bandwidth 1.0858 MHz</p> <p>Occ BW % Pwr 99.00 %</p> <p>x dB -26.00 dB</p> <p>Transmit Freq Error -1.581 kHz</p> <p>x dB Bandwidth 1.246 MHz</p> <p>Copyright 2000-2006 Agilent Technologies</p>

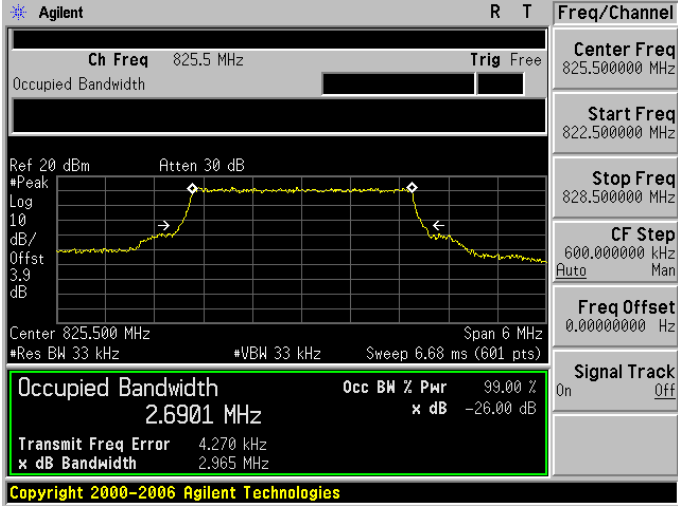
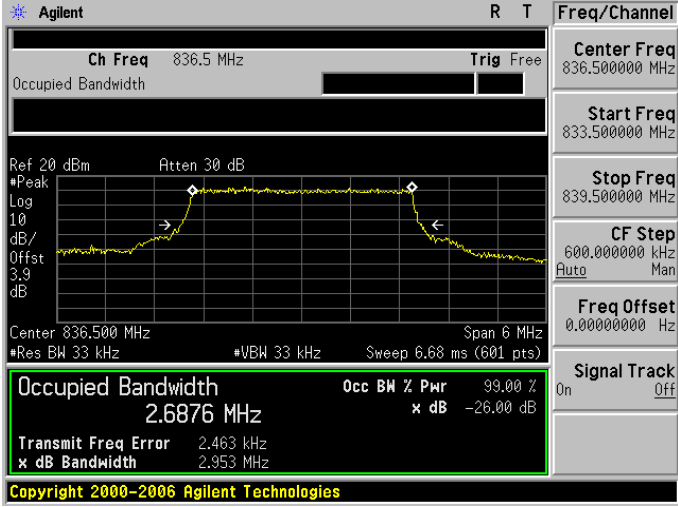
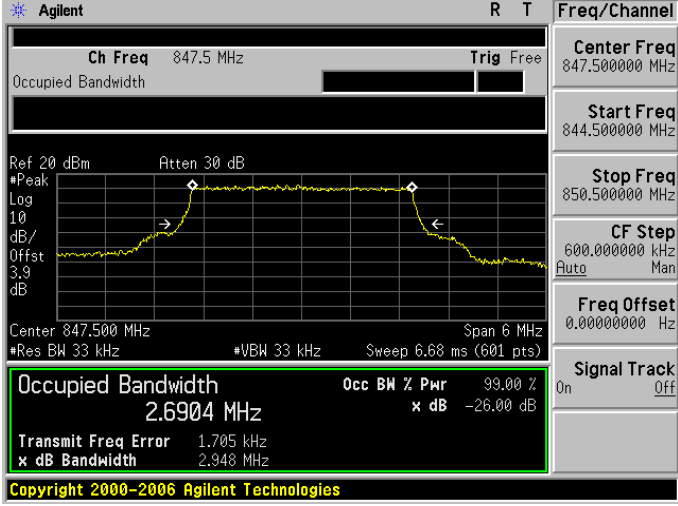
LTE Band 5 (Channel Bandwidth: 3 MHz) _ QPSK	
825.5 MHz	 <p>Agilent R T Freq/Channel</p> <p>Ch Freq 825.5 MHz Trig Free</p> <p>Center Freq 825.500000 MHz</p> <p>Start Freq 822.500000 MHz</p> <p>Stop Freq 828.500000 MHz</p> <p>CF Step 600.000000 kHz Auto Man</p> <p>Freq Offset 0.00000000 Hz</p> <p>Signal Track On Off</p> <p>Ref 20 dBm Atten 30 dB</p> <p>Peak</p> <p>Log 10</p> <p>dB/ Offst 3.9 dB</p> <p>Center 825.500 MHz Span 6 MHz</p> <p>Res BW 33 kHz VBW 33 kHz Sweep 6.68 ms (601 pts)</p> <p>Occupied Bandwidth 2.6901 MHz Occ BW % Pwr 99.00 % x dB -26.00 dB</p> <p>Transmit Freq Error 4.270 kHz</p> <p>x dB Bandwidth 2.965 MHz</p> <p>Copyright 2000-2006 Agilent Technologies</p>
836.5 MHz	 <p>Agilent R T Freq/Channel</p> <p>Ch Freq 836.5 MHz Trig Free</p> <p>Center Freq 836.500000 MHz</p> <p>Start Freq 833.500000 MHz</p> <p>Stop Freq 839.500000 MHz</p> <p>CF Step 600.000000 kHz Auto Man</p> <p>Freq Offset 0.00000000 Hz</p> <p>Signal Track On Off</p> <p>Ref 20 dBm Atten 30 dB</p> <p>Peak</p> <p>Log 10</p> <p>dB/ Offst 3.9 dB</p> <p>Center 836.500 MHz Span 6 MHz</p> <p>Res BW 33 kHz VBW 33 kHz Sweep 6.68 ms (601 pts)</p> <p>Occupied Bandwidth 2.6876 MHz Occ BW % Pwr 99.00 % x dB -26.00 dB</p> <p>Transmit Freq Error 2.463 kHz</p> <p>x dB Bandwidth 2.953 MHz</p> <p>Copyright 2000-2006 Agilent Technologies</p>
847.5 MHz	 <p>Agilent R T Freq/Channel</p> <p>Ch Freq 847.5 MHz Trig Free</p> <p>Center Freq 847.500000 MHz</p> <p>Start Freq 844.500000 MHz</p> <p>Stop Freq 850.500000 MHz</p> <p>CF Step 600.000000 kHz Auto Man</p> <p>Freq Offset 0.00000000 Hz</p> <p>Signal Track On Off</p> <p>Ref 20 dBm Atten 30 dB</p> <p>Peak</p> <p>Log 10</p> <p>dB/ Offst 3.9 dB</p> <p>Center 847.500 MHz Span 6 MHz</p> <p>Res BW 33 kHz VBW 33 kHz Sweep 6.68 ms (601 pts)</p> <p>Occupied Bandwidth 2.6904 MHz Occ BW % Pwr 99.00 % x dB -26.00 dB</p> <p>Transmit Freq Error 1.705 kHz</p> <p>x dB Bandwidth 2.948 MHz</p> <p>Copyright 2000-2006 Agilent Technologies</p>

LTE Band 5 (Channel Bandwidth: 5 MHz) _ QPSK	
826.5 MHz	<p>Agilent R T Freq/Channel</p> <p>Ch Freq 826.5 MHz Trig Free</p> <p>Center Freq 826.500000 MHz</p> <p>Start Freq 821.500000 MHz</p> <p>Stop Freq 831.500000 MHz</p> <p>CF Step 1.00000000 MHz Auto Man</p> <p>Freq Offset 0.00000000 Hz</p> <p>Signal Track On Off</p> <p>Ref 20 dBm Atten 30 dB</p> <p>#Peak Log 10 dB/Offst 3.9 dB</p> <p>Center 826.50 MHz Span 10 MHz</p> <p>#Res BW 51 kHz #VBW 51 kHz Sweep 4.64 ms (601 pts)</p> <p>Occupied Bandwidth 4.4747 MHz</p> <p>Occ BW % Pwr 99.00 %</p> <p>x dB -26.00 dB</p> <p>Transmit Freq Error 3.396 kHz</p> <p>x dB Bandwidth 4.923 MHz</p> <p>Copyright 2000-2006 Agilent Technologies</p>
836.5 MHz	<p>Agilent R T Freq/Channel</p> <p>Ch Freq 836.5 MHz Trig Free</p> <p>Center Freq 836.500000 MHz</p> <p>Start Freq 831.500000 MHz</p> <p>Stop Freq 841.500000 MHz</p> <p>CF Step 1.00000000 MHz Auto Man</p> <p>Freq Offset 0.00000000 Hz</p> <p>Signal Track On Off</p> <p>Ref 20 dBm Atten 30 dB</p> <p>#Peak Log 10 dB/Offst 3.9 dB</p> <p>Center 836.50 MHz Span 10 MHz</p> <p>#Res BW 51 kHz #VBW 51 kHz Sweep 4.64 ms (601 pts)</p> <p>Occupied Bandwidth 4.4618 MHz</p> <p>Occ BW % Pwr 99.00 %</p> <p>x dB -26.00 dB</p> <p>Transmit Freq Error 3.499 kHz</p> <p>x dB Bandwidth 4.891 MHz</p> <p>Copyright 2000-2006 Agilent Technologies</p>
846.5 MHz	<p>Agilent R T Freq/Channel</p> <p>Ch Freq 846.5 MHz Trig Free</p> <p>Center Freq 846.500000 MHz</p> <p>Start Freq 841.500000 MHz</p> <p>Stop Freq 851.500000 MHz</p> <p>CF Step 1.00000000 MHz Auto Man</p> <p>Freq Offset 0.00000000 Hz</p> <p>Signal Track On Off</p> <p>Ref 20 dBm Atten 30 dB</p> <p>#Peak Log 10 dB/Offst 3.9 dB</p> <p>Center 846.50 MHz Span 10 MHz</p> <p>#Res BW 51 kHz #VBW 51 kHz Sweep 4.64 ms (601 pts)</p> <p>Occupied Bandwidth 4.4555 MHz</p> <p>Occ BW % Pwr 99.00 %</p> <p>x dB -26.00 dB</p> <p>Transmit Freq Error 423.721 Hz</p> <p>x dB Bandwidth 4.848 MHz</p> <p>Copyright 2000-2006 Agilent Technologies</p>

LTE Band 5 (Channel Bandwidth: 10 MHz) _ QPSK	
829.0 MHz	<p>Agilent R T Freq/Channel</p> <p>Ch Freq 829 MHz Trig Free</p> <p>Center 829.00 MHz Span 20 MHz</p> <p>Occupied Bandwidth 8.9697 MHz</p> <p>Transmit Freq Error 14.226 kHz</p> <p>x dB Bandwidth 9.388 MHz</p> <p>Occ BW % Pwr 99.00 %</p> <p>x dB -26.00 dB</p> <p>Copyright 2000-2006 Agilent Technologies</p>
836.5 MHz	<p>Agilent R T Freq/Channel</p> <p>Ch Freq 836.5 MHz Trig Free</p> <p>Center 836.50 MHz Span 20 MHz</p> <p>Occupied Bandwidth 8.9613 MHz</p> <p>Transmit Freq Error -1.647 kHz</p> <p>x dB Bandwidth 9.313 MHz</p> <p>Occ BW % Pwr 99.00 %</p> <p>x dB -26.00 dB</p> <p>Copyright 2000-2006 Agilent Technologies</p>
844.0 MHz	<p>Agilent R T Freq/Channel</p> <p>Ch Freq 844 MHz Trig Free</p> <p>Center 844.00 MHz Span 20 MHz</p> <p>Occupied Bandwidth 8.9640 MHz</p> <p>Transmit Freq Error -12.980 kHz</p> <p>x dB Bandwidth 9.787 MHz</p> <p>Occ BW % Pwr 99.00 %</p> <p>x dB -26.00 dB</p> <p>Copyright 2000-2006 Agilent Technologies</p>

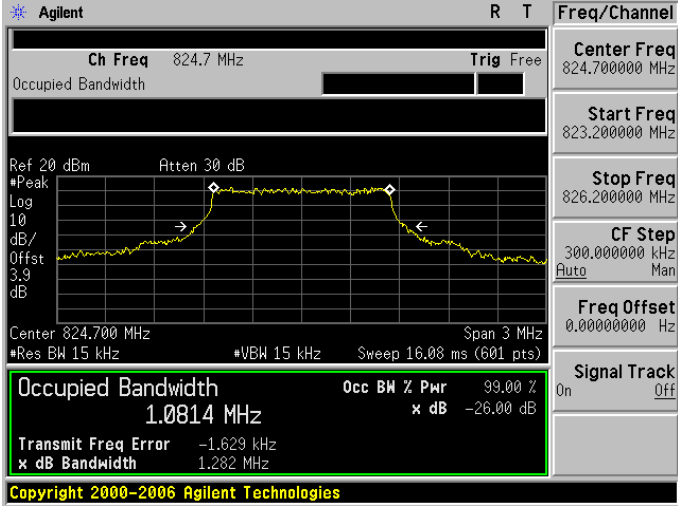
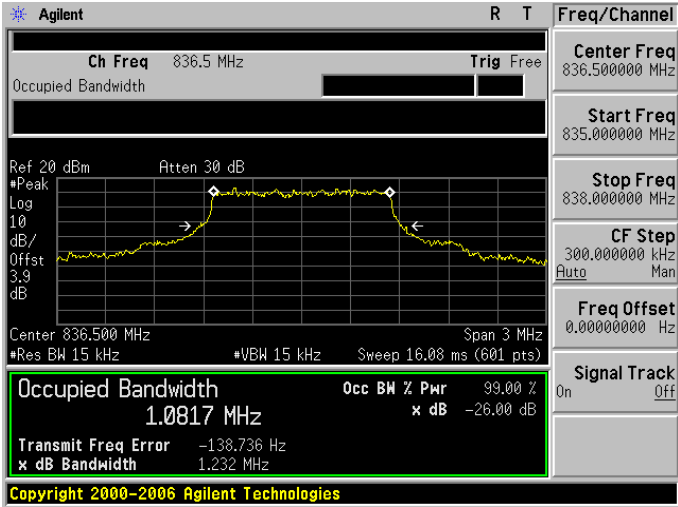
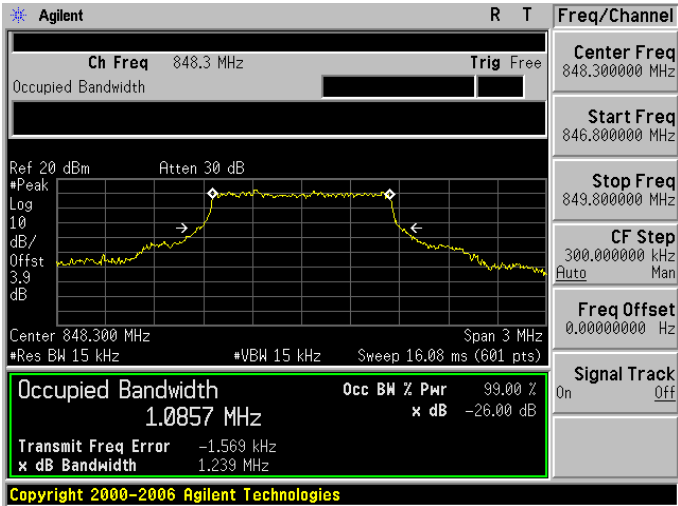
LTE Band 5 (Channel Bandwidth: 1.4 MHz) _ 16QAM	
824.7 MHz	 <p>Agilent R T Freq/Channel</p> <p>Ch Freq 824.7 MHz Trig Free</p> <p>Center Freq 824.700000 MHz</p> <p>Start Freq 823.200000 MHz</p> <p>Stop Freq 826.200000 MHz</p> <p>CF Step 300.000000 kHz</p> <p>Freq Offset 0.00000000 Hz</p> <p>Signal Track On Off</p> <p>Ref 20 dBm Atten 30 dB</p> <p>Peak</p> <p>Log 10</p> <p>dB/Offst 3.9 dB</p> <p>Center 824.700 MHz Span 3 MHz</p> <p>Res BW 15 kHz VBW 15 kHz Sweep 16.08 ms (601 pts)</p> <p>Occupied Bandwidth 1.0814 MHz</p> <p>Occ BW % Pwr 99.00 %</p> <p>x dB -26.00 dB</p> <p>Transmit Freq Error -1.629 kHz</p> <p>x dB Bandwidth 1.282 MHz</p> <p>Copyright 2000-2006 Agilent Technologies</p>
836.5 MHz	 <p>Agilent R T Freq/Channel</p> <p>Ch Freq 836.5 MHz Trig Free</p> <p>Center Freq 836.500000 MHz</p> <p>Start Freq 835.000000 MHz</p> <p>Stop Freq 838.000000 MHz</p> <p>CF Step 300.000000 kHz</p> <p>Freq Offset 0.00000000 Hz</p> <p>Signal Track On Off</p> <p>Ref 20 dBm Atten 30 dB</p> <p>Peak</p> <p>Log 10</p> <p>dB/Offst 3.9 dB</p> <p>Center 836.500 MHz Span 3 MHz</p> <p>Res BW 15 kHz VBW 15 kHz Sweep 16.08 ms (601 pts)</p> <p>Occupied Bandwidth 1.0817 MHz</p> <p>Occ BW % Pwr 99.00 %</p> <p>x dB -26.00 dB</p> <p>Transmit Freq Error -138.736 Hz</p> <p>x dB Bandwidth 1.232 MHz</p> <p>Copyright 2000-2006 Agilent Technologies</p>
848.3 MHz	 <p>Agilent R T Freq/Channel</p> <p>Ch Freq 848.3 MHz Trig Free</p> <p>Center Freq 848.300000 MHz</p> <p>Start Freq 846.800000 MHz</p> <p>Stop Freq 849.800000 MHz</p> <p>CF Step 300.000000 kHz</p> <p>Freq Offset 0.00000000 Hz</p> <p>Signal Track On Off</p> <p>Ref 20 dBm Atten 30 dB</p> <p>Peak</p> <p>Log 10</p> <p>dB/Offst 3.9 dB</p> <p>Center 848.300 MHz Span 3 MHz</p> <p>Res BW 15 kHz VBW 15 kHz Sweep 16.08 ms (601 pts)</p> <p>Occupied Bandwidth 1.0857 MHz</p> <p>Occ BW % Pwr 99.00 %</p> <p>x dB -26.00 dB</p> <p>Transmit Freq Error -1.569 kHz</p> <p>x dB Bandwidth 1.239 MHz</p> <p>Copyright 2000-2006 Agilent Technologies</p>

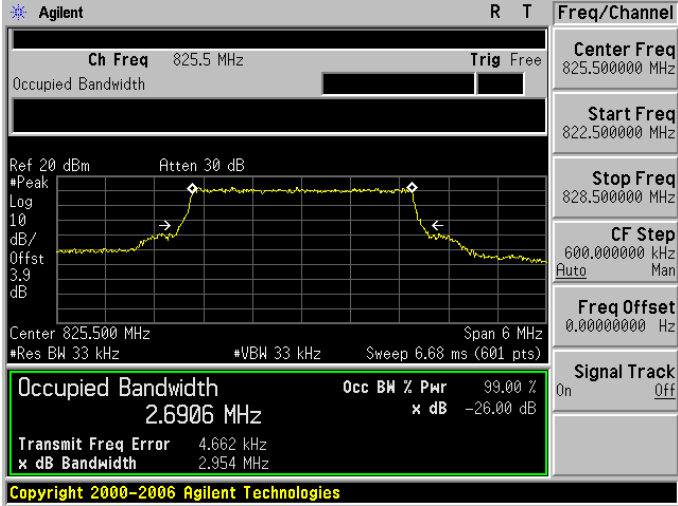
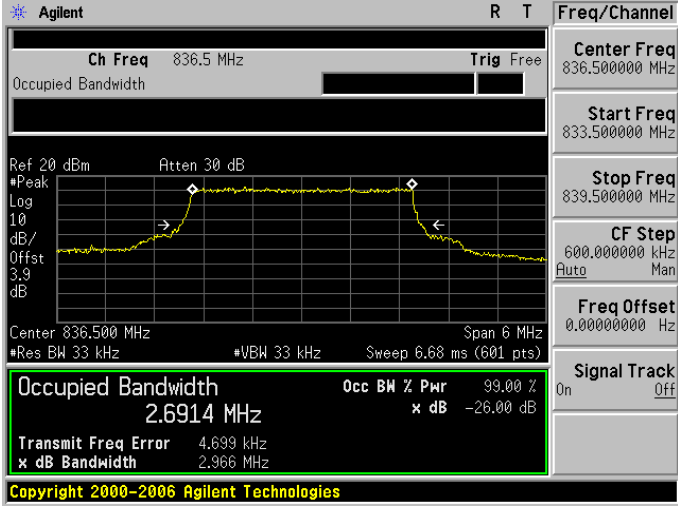
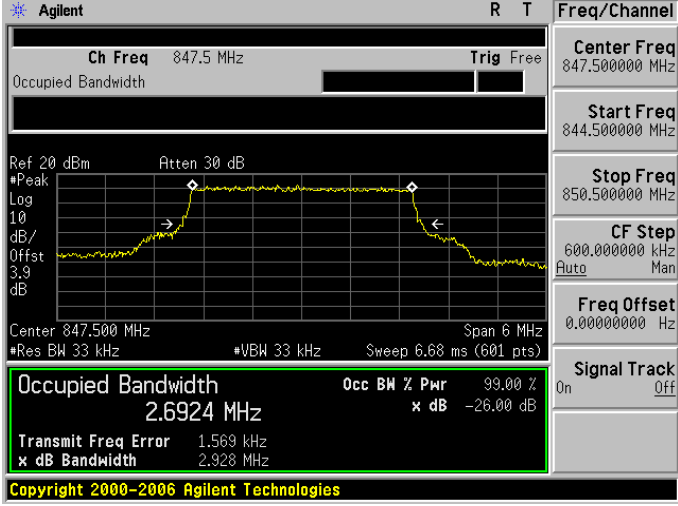
LTE Band 5 (Channel Bandwidth: 3 MHz) _ 16QAM	
825.5 MHz	 <p>Agilent R T Freq/Channel</p> <p>Ch Freq 825.5 MHz Trig Free</p> <p>Center Freq 825.500000 MHz</p> <p>Start Freq 822.500000 MHz</p> <p>Stop Freq 828.500000 MHz</p> <p>CF Step 600.000000 kHz Auto Man</p> <p>Freq Offset 0.00000000 Hz</p> <p>Signal Track On Off</p> <p>Ref 20 dBm Atten 30 dB</p> <p>Peak</p> <p>Log 10</p> <p>dB/ Offst 3.9 dB</p> <p>Center 825.500 MHz Span 6 MHz</p> <p>Res BW 33 kHz VBW 33 kHz Sweep 6.68 ms (601 pts)</p> <p>Occupied Bandwidth 2.6906 MHz Occ BW % Pwr 99.00 % x dB -26.00 dB</p> <p>Transmit Freq Error 4.662 kHz</p> <p>x dB Bandwidth 2.954 MHz</p> <p>Copyright 2000-2006 Agilent Technologies</p>
836.5 MHz	 <p>Agilent R T Freq/Channel</p> <p>Ch Freq 836.5 MHz Trig Free</p> <p>Center Freq 836.500000 MHz</p> <p>Start Freq 833.500000 MHz</p> <p>Stop Freq 839.500000 MHz</p> <p>CF Step 600.000000 kHz Auto Man</p> <p>Freq Offset 0.00000000 Hz</p> <p>Signal Track On Off</p> <p>Ref 20 dBm Atten 30 dB</p> <p>Peak</p> <p>Log 10</p> <p>dB/ Offst 3.9 dB</p> <p>Center 836.500 MHz Span 6 MHz</p> <p>Res BW 33 kHz VBW 33 kHz Sweep 6.68 ms (601 pts)</p> <p>Occupied Bandwidth 2.6914 MHz Occ BW % Pwr 99.00 % x dB -26.00 dB</p> <p>Transmit Freq Error 4.699 kHz</p> <p>x dB Bandwidth 2.966 MHz</p> <p>Copyright 2000-2006 Agilent Technologies</p>
847.5 MHz	 <p>Agilent R T Freq/Channel</p> <p>Ch Freq 847.5 MHz Trig Free</p> <p>Center Freq 847.500000 MHz</p> <p>Start Freq 844.500000 MHz</p> <p>Stop Freq 850.500000 MHz</p> <p>CF Step 600.000000 kHz Auto Man</p> <p>Freq Offset 0.00000000 Hz</p> <p>Signal Track On Off</p> <p>Ref 20 dBm Atten 30 dB</p> <p>Peak</p> <p>Log 10</p> <p>dB/ Offst 3.9 dB</p> <p>Center 847.500 MHz Span 6 MHz</p> <p>Res BW 33 kHz VBW 33 kHz Sweep 6.68 ms (601 pts)</p> <p>Occupied Bandwidth 2.6924 MHz Occ BW % Pwr 99.00 % x dB -26.00 dB</p> <p>Transmit Freq Error 1.569 kHz</p> <p>x dB Bandwidth 2.928 MHz</p> <p>Copyright 2000-2006 Agilent Technologies</p>

LTE Band 5 (Channel Bandwidth: 5 MHz) _ 16QAM	
826.5 MHz	<p>Agilent R T Freq/Channel</p> <p>Ch Freq 826.5 MHz Trig Free</p> <p>Center Freq 826.500000 MHz</p> <p>Start Freq 821.500000 MHz</p> <p>Stop Freq 831.500000 MHz</p> <p>CF Step 1.00000000 MHz Auto Man</p> <p>Freq Offset 0.00000000 Hz</p> <p>Signal Track On Off</p> <p>Ref 20 dBm Atten 30 dB</p> <p>Peak 10 dB/Offst 3.9 dB</p> <p>Center 826.50 MHz Span 10 MHz</p> <p>Res BW 51 kHz VBW 51 kHz Sweep 4.64 ms (601 pts)</p> <p>Occupied Bandwidth 4.4558 MHz</p> <p>Occ BW % Pwr 99.00 %</p> <p>x dB Bandwidth 4.903 MHz x dB -26.00 dB</p> <p>Transmit Freq Error 6.958 kHz</p> <p>Copyright 2000-2006 Agilent Technologies</p>
836.5 MHz	<p>Agilent R T Freq/Channel</p> <p>Ch Freq 836.5 MHz Trig Free</p> <p>Center Freq 836.500000 MHz</p> <p>Start Freq 831.500000 MHz</p> <p>Stop Freq 841.500000 MHz</p> <p>CF Step 1.00000000 MHz Auto Man</p> <p>Freq Offset 0.00000000 Hz</p> <p>Signal Track On Off</p> <p>Ref 20 dBm Atten 30 dB</p> <p>Peak 10 dB/Offst 3.9 dB</p> <p>Center 836.50 MHz Span 10 MHz</p> <p>Res BW 51 kHz VBW 51 kHz Sweep 4.64 ms (601 pts)</p> <p>Occupied Bandwidth 4.4661 MHz</p> <p>Occ BW % Pwr 99.00 %</p> <p>x dB Bandwidth 4.915 MHz x dB -26.00 dB</p> <p>Transmit Freq Error 6.792 kHz</p> <p>Copyright 2000-2006 Agilent Technologies</p>
846.5 MHz	<p>Agilent R T Freq/Channel</p> <p>Ch Freq 846.5 MHz Trig Free</p> <p>Center Freq 846.500000 MHz</p> <p>Start Freq 841.500000 MHz</p> <p>Stop Freq 851.500000 MHz</p> <p>CF Step 1.00000000 MHz Auto Man</p> <p>Freq Offset 0.00000000 Hz</p> <p>Signal Track On Off</p> <p>Ref 20 dBm Atten 30 dB</p> <p>Peak 10 dB/Offst 3.9 dB</p> <p>Center 846.50 MHz Span 10 MHz</p> <p>Res BW 51 kHz VBW 51 kHz Sweep 4.64 ms (601 pts)</p> <p>Occupied Bandwidth 4.4482 MHz</p> <p>Occ BW % Pwr 99.00 %</p> <p>x dB Bandwidth 4.802 MHz x dB -26.00 dB</p> <p>Transmit Freq Error -2.932 kHz</p> <p>Copyright 2000-2006 Agilent Technologies</p>

LTE Band 5 (Channel Bandwidth: 10 MHz) _ 16QAM	
829.0 MHz	<p>Agilent R T Freq/Channel</p> <p>Ch Freq 829 MHz Trig Free</p> <p>Center Freq 829.000000 MHz</p> <p>Start Freq 819.000000 MHz</p> <p>Stop Freq 839.000000 MHz</p> <p>CF Step 2.00000000 MHz</p> <p>Freq Offset 0.00000000 Hz</p> <p>Signal Track On Off</p> <p>Ref 20 dBm Atten 30 dB</p> <p>Peak Log 10 dB/Offst 3.9 dB</p> <p>Center 829.00 MHz Span 20 MHz</p> <p>Res BW 110 kHz VBW 110 kHz Sweep 2 ms (601 pts)</p> <p>Occupied Bandwidth 8.9701 MHz</p> <p>Occ BW % Pwr 99.00 %</p> <p>x dB -26.00 dB</p> <p>Transmit Freq Error 12.610 kHz</p> <p>x dB Bandwidth 9.841 MHz</p> <p>Copyright 2000-2006 Agilent Technologies</p>
836.5 MHz	<p>Agilent R T Freq/Channel</p> <p>Ch Freq 836.5 MHz Trig Free</p> <p>Center Freq 836.500000 MHz</p> <p>Start Freq 826.500000 MHz</p> <p>Stop Freq 846.500000 MHz</p> <p>CF Step 2.00000000 MHz</p> <p>Freq Offset 0.00000000 Hz</p> <p>Signal Track On Off</p> <p>Ref 20 dBm Atten 30 dB</p> <p>Peak Log 10 dB/Offst 3.9 dB</p> <p>Center 836.50 MHz Span 20 MHz</p> <p>Res BW 110 kHz VBW 110 kHz Sweep 2 ms (601 pts)</p> <p>Occupied Bandwidth 8.9534 MHz</p> <p>Occ BW % Pwr 99.00 %</p> <p>x dB -26.00 dB</p> <p>Transmit Freq Error -1.914 kHz</p> <p>x dB Bandwidth 9.768 MHz</p> <p>Copyright 2000-2006 Agilent Technologies</p>
844.0 MHz	<p>Agilent R T Freq/Channel</p> <p>Ch Freq 844 MHz Trig Free</p> <p>Center Freq 844.000000 MHz</p> <p>Start Freq 834.000000 MHz</p> <p>Stop Freq 854.000000 MHz</p> <p>CF Step 2.00000000 MHz</p> <p>Freq Offset 0.00000000 Hz</p> <p>Signal Track On Off</p> <p>Ref 20 dBm Atten 30 dB</p> <p>Peak Log 10 dB/Offst 3.9 dB</p> <p>Center 844.00 MHz Span 20 MHz</p> <p>Res BW 110 kHz VBW 110 kHz Sweep 2 ms (601 pts)</p> <p>Occupied Bandwidth 8.9318 MHz</p> <p>Occ BW % Pwr 99.00 %</p> <p>x dB -26.00 dB</p> <p>Transmit Freq Error -1.180 kHz</p> <p>x dB Bandwidth 9.792 MHz</p> <p>Copyright 2000-2006 Agilent Technologies</p>

LTE Band 12 (Channel Bandwidth: 1.4 MHz) _ QPSK	
699.7 MHz	<p>Agilent R T Freq/Channel</p> <p>Ch Freq 699.7 MHz Trig Free</p> <p>Center Freq 699.700000 MHz</p> <p>Start Freq 698.200000 MHz</p> <p>Stop Freq 701.200000 MHz</p> <p>CF Step 300.000000 kHz</p> <p>Freq Offset 0.00000000 Hz</p> <p>Signal Track On Off</p> <p>Ref 20 dBm Atten 30 dB</p> <p>Peak 10</p> <p>Log dB/Offst 3.9 dB</p> <p>Center 699.700 MHz Span 3 MHz</p> <p>Res BW 15 kHz VBW 15 kHz Sweep 16.08 ms (601 pts)</p> <p>Occupied Bandwidth 1.0891 MHz Occ BW % Pwr 99.00 %</p> <p>Transmit Freq Error -339.992 Hz x dB -26.00 dB</p> <p>x dB Bandwidth 1.246 MHz</p> <p>Copyright 2000-2006 Agilent Technologies</p>
707.5 MHz	<p>Agilent R T Freq/Channel</p> <p>Ch Freq 707.5 MHz Trig Free</p> <p>Center Freq 707.500000 MHz</p> <p>Start Freq 706.000000 MHz</p> <p>Stop Freq 709.000000 MHz</p> <p>CF Step 300.000000 kHz</p> <p>Freq Offset 0.00000000 Hz</p> <p>Signal Track On Off</p> <p>Ref 20 dBm Atten 30 dB</p> <p>Peak 10</p> <p>Log dB/Offst 3.9 dB</p> <p>Center 707.500 MHz Span 3 MHz</p> <p>Res BW 15 kHz VBW 15 kHz Sweep 16.08 ms (601 pts)</p> <p>Occupied Bandwidth 1.0796 MHz Occ BW % Pwr 99.00 %</p> <p>Transmit Freq Error -2.778 kHz x dB -26.00 dB</p> <p>x dB Bandwidth 1.294 MHz</p> <p>Copyright 2000-2006 Agilent Technologies</p>
715.3 MHz	<p>Agilent R T Freq/Channel</p> <p>Ch Freq 715.3 MHz Trig Free</p> <p>Center Freq 715.300000 MHz</p> <p>Start Freq 713.800000 MHz</p> <p>Stop Freq 716.800000 MHz</p> <p>CF Step 300.000000 kHz</p> <p>Freq Offset 0.00000000 Hz</p> <p>Signal Track On Off</p> <p>Ref 20 dBm Atten 30 dB</p> <p>Peak 10</p> <p>Log dB/Offst 3.9 dB</p> <p>Center 715.300 MHz Span 3 MHz</p> <p>Res BW 15 kHz VBW 15 kHz Sweep 16.08 ms (601 pts)</p> <p>Occupied Bandwidth 1.0823 MHz Occ BW % Pwr 99.00 %</p> <p>Transmit Freq Error -789.081 Hz x dB -26.00 dB</p> <p>x dB Bandwidth 1.232 MHz</p> <p>Copyright 2000-2006 Agilent Technologies</p>

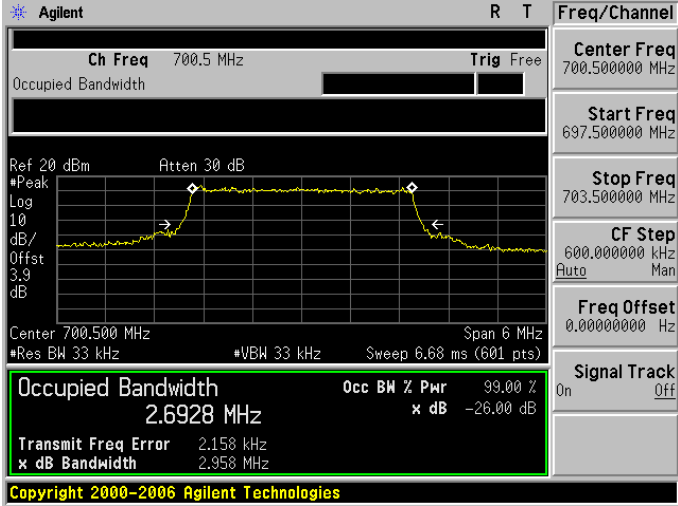
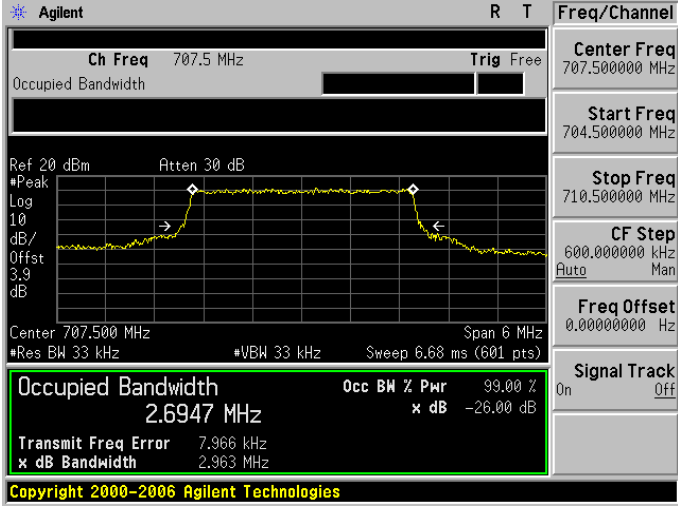
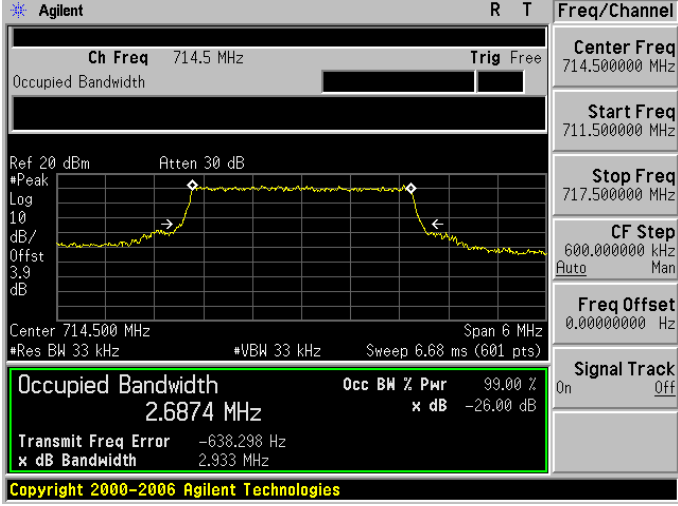
LTE Band 12 (Channel Bandwidth: 3 MHz) _ QPSK	
700.5 MHz	 <p>Agilent R T Freq/Channel</p> <p>Ch Freq 700.5 MHz Trig Free</p> <p>Center 700.500 MHz Span 6 MHz</p> <p>Res BW 33 kHz VBW 33 kHz Sweep 6.68 ms (601 pts)</p> <p>Occupied Bandwidth 2.6928 MHz Occ BW % Pwr 99.00 %</p> <p>Transmit Freq Error 2.158 kHz x dB Bandwidth 2.958 MHz x dB -26.00 dB</p> <p>Copyright 2000-2006 Agilent Technologies</p>
707.5 MHz	 <p>Agilent R T Freq/Channel</p> <p>Ch Freq 707.5 MHz Trig Free</p> <p>Center 707.500 MHz Span 6 MHz</p> <p>Res BW 33 kHz VBW 33 kHz Sweep 6.68 ms (601 pts)</p> <p>Occupied Bandwidth 2.6947 MHz Occ BW % Pwr 99.00 %</p> <p>Transmit Freq Error 7.966 kHz x dB Bandwidth 2.963 MHz x dB -26.00 dB</p> <p>Copyright 2000-2006 Agilent Technologies</p>
714.5 MHz	 <p>Agilent R T Freq/Channel</p> <p>Ch Freq 714.5 MHz Trig Free</p> <p>Center 714.500 MHz Span 6 MHz</p> <p>Res BW 33 kHz VBW 33 kHz Sweep 6.68 ms (601 pts)</p> <p>Occupied Bandwidth 2.6874 MHz Occ BW % Pwr 99.00 %</p> <p>Transmit Freq Error -638.298 Hz x dB Bandwidth 2.933 MHz x dB -26.00 dB</p> <p>Copyright 2000-2006 Agilent Technologies</p>

LTE Band 12 (Channel Bandwidth: 5 MHz) _ QPSK	
701.5 MHz	<p>Agilent R T Freq/Channel</p> <p>Ch Freq 701.5 MHz Trig Free</p> <p>Center 701.50 MHz Span 10 MHz</p> <p>Res BW 51 kHz VBW 51 kHz Sweep 4.64 ms (601 pts)</p> <p>Occupied Bandwidth 4.4600 MHz</p> <p>Occ BW % Pwr 99.00 %</p> <p>x dB Bandwidth 4.916 MHz x dB -26.00 dB</p> <p>Transmit Freq Error -5.220 kHz</p> <p>Copyright 2000-2006 Agilent Technologies</p>
707.5 MHz	<p>Agilent R T Freq/Channel</p> <p>Ch Freq 707.5 MHz Trig Free</p> <p>Center 707.50 MHz Span 10 MHz</p> <p>Res BW 51 kHz VBW 51 kHz Sweep 4.64 ms (601 pts)</p> <p>Occupied Bandwidth 4.4589 MHz</p> <p>Occ BW % Pwr 99.00 %</p> <p>x dB Bandwidth 4.907 MHz x dB -26.00 dB</p> <p>Transmit Freq Error 3.750 kHz</p> <p>Copyright 2000-2006 Agilent Technologies</p>
713.5 MHz	<p>Agilent R T Freq/Channel</p> <p>Ch Freq 713.5 MHz Trig Free</p> <p>Center 713.50 MHz Span 10 MHz</p> <p>Res BW 51 kHz VBW 51 kHz Sweep 4.64 ms (601 pts)</p> <p>Occupied Bandwidth 4.4548 MHz</p> <p>Occ BW % Pwr 99.00 %</p> <p>x dB Bandwidth 4.871 MHz x dB -26.00 dB</p> <p>Transmit Freq Error -4.546 kHz</p> <p>Copyright 2000-2006 Agilent Technologies</p>

LTE Band 12 (Channel Bandwidth: 10 MHz) _ QPSK	
704.0 MHz	<p>Agilent R T Freq/Channel</p> <p>Ch Freq 704 MHz Trig Free</p> <p>Center 704.00 MHz Span 20 MHz</p> <p>Occupied Bandwidth 8.9831 MHz</p> <p>Transmit Freq Error 393.435 Hz</p> <p>x dB Bandwidth 10.108 MHz</p> <p>Occ BW % Pwr 99.00 %</p> <p>x dB -26.00 dB</p> <p>Copyright 2000-2006 Agilent Technologies</p>
707.5 MHz	<p>Agilent R T Freq/Channel</p> <p>Ch Freq 707.5 MHz Trig Free</p> <p>Center 707.50 MHz Span 20 MHz</p> <p>Occupied Bandwidth 8.9567 MHz</p> <p>Transmit Freq Error 16.752 kHz</p> <p>x dB Bandwidth 9.675 MHz</p> <p>Occ BW % Pwr 99.00 %</p> <p>x dB -26.00 dB</p> <p>Copyright 2000-2006 Agilent Technologies</p>
711.0 MHz	<p>Agilent R T Freq/Channel</p> <p>Ch Freq 711 MHz Trig Free</p> <p>Center 711.00 MHz Span 20 MHz</p> <p>Occupied Bandwidth 8.9505 MHz</p> <p>Transmit Freq Error -6.818 kHz</p> <p>x dB Bandwidth 9.393 MHz</p> <p>Occ BW % Pwr 99.00 %</p> <p>x dB -26.00 dB</p> <p>Copyright 2000-2006 Agilent Technologies</p>

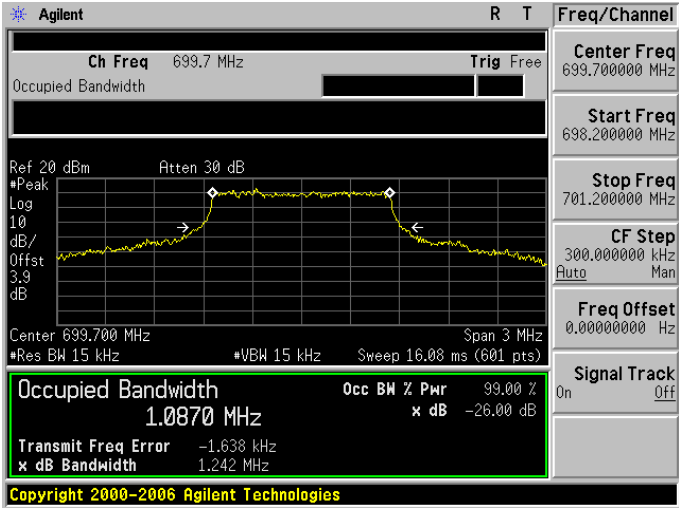
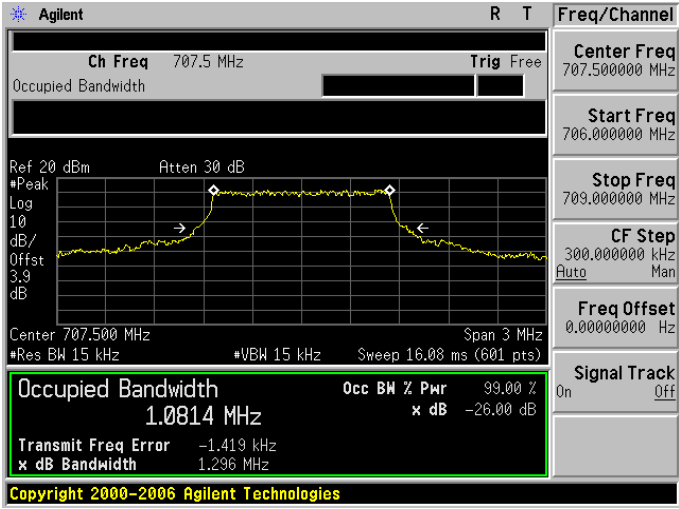
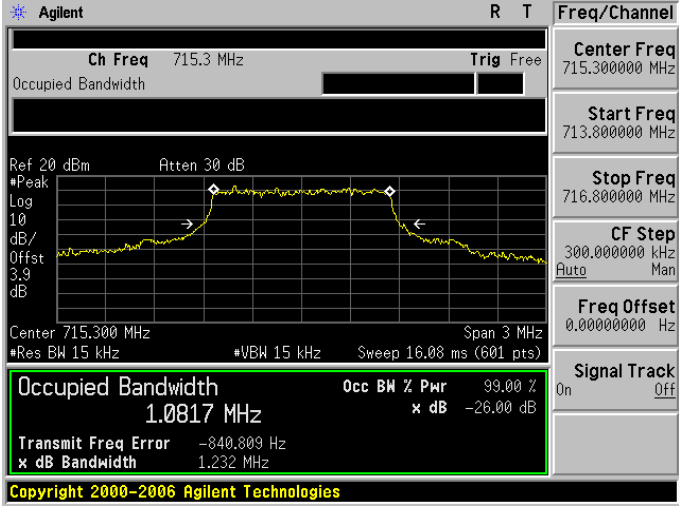
LTE Band 12 (Channel Bandwidth: 1.4 MHz) _ 16QAM	
669.7 MHz	 <p>Agilent R T Freq/Channel</p> <p>Ch Freq 699.7 MHz Trig Free</p> <p>Center Freq 699.700000 MHz</p> <p>Start Freq 698.200000 MHz</p> <p>Stop Freq 701.200000 MHz</p> <p>CF Step 300.000000 kHz</p> <p>Freq Offset 0.00000000 Hz</p> <p>Signal Track On Off</p> <p>Ref 20 dBm Atten 30 dB</p> <p>Peak 10</p> <p>Log dB/Offst 3.9 dB</p> <p>Center 699.700 MHz Span 3 MHz</p> <p>Res BW 15 kHz VBW 15 kHz Sweep 16.08 ms (601 pts)</p> <p>Occupied Bandwidth 1.0870 MHz</p> <p>Occ BW % Pwr 99.00 %</p> <p>x dB Bandwidth 1.242 MHz x dB -26.00 dB</p> <p>Transmit Freq Error -1.638 kHz</p> <p>Copyright 2000-2006 Agilent Technologies</p>
707.5 MHz	 <p>Agilent R T Freq/Channel</p> <p>Ch Freq 707.5 MHz Trig Free</p> <p>Center Freq 707.500000 MHz</p> <p>Start Freq 706.000000 MHz</p> <p>Stop Freq 709.000000 MHz</p> <p>CF Step 300.000000 kHz</p> <p>Freq Offset 0.00000000 Hz</p> <p>Signal Track On Off</p> <p>Ref 20 dBm Atten 30 dB</p> <p>Peak 10</p> <p>Log dB/Offst 3.9 dB</p> <p>Center 707.500 MHz Span 3 MHz</p> <p>Res BW 15 kHz VBW 15 kHz Sweep 16.08 ms (601 pts)</p> <p>Occupied Bandwidth 1.0814 MHz</p> <p>Occ BW % Pwr 99.00 %</p> <p>x dB Bandwidth 1.296 MHz x dB -26.00 dB</p> <p>Transmit Freq Error -1.419 kHz</p> <p>Copyright 2000-2006 Agilent Technologies</p>
715.3 MHz	 <p>Agilent R T Freq/Channel</p> <p>Ch Freq 715.3 MHz Trig Free</p> <p>Center Freq 715.300000 MHz</p> <p>Start Freq 713.800000 MHz</p> <p>Stop Freq 716.800000 MHz</p> <p>CF Step 300.000000 kHz</p> <p>Freq Offset 0.00000000 Hz</p> <p>Signal Track On Off</p> <p>Ref 20 dBm Atten 30 dB</p> <p>Peak 10</p> <p>Log dB/Offst 3.9 dB</p> <p>Center 715.300 MHz Span 3 MHz</p> <p>Res BW 15 kHz VBW 15 kHz Sweep 16.08 ms (601 pts)</p> <p>Occupied Bandwidth 1.0817 MHz</p> <p>Occ BW % Pwr 99.00 %</p> <p>x dB Bandwidth 1.232 MHz x dB -26.00 dB</p> <p>Transmit Freq Error -840.809 Hz</p> <p>Copyright 2000-2006 Agilent Technologies</p>

LTE Band 12 (Channel Bandwidth: 3 MHz) _ 16QAM	
700.5 MHz	<p>Agilent R T Freq/Channel</p> <p>Ch Freq 700.5 MHz Trig Free</p> <p>Center Freq 700.500000 MHz</p> <p>Start Freq 697.500000 MHz</p> <p>Stop Freq 703.500000 MHz</p> <p>CF Step 600.000000 kHz</p> <p>Freq Offset 0.00000000 Hz</p> <p>Signal Track On Off</p> <p>Ref 20 dBm Atten 30 dB</p> <p>Peak</p> <p>Log 10</p> <p>dB/Offst 3.9 dB</p> <p>Center 700.500 MHz Span 6 MHz</p> <p>Res BW 33 kHz VBW 33 kHz Sweep 6.68 ms (601 pts)</p> <p>Occupied Bandwidth 2.6919 MHz Occ BW % Pwr 99.00 %</p> <p>Transmit Freq Error 2.380 kHz x dB -26.00 dB</p> <p>x dB Bandwidth 2.954 MHz</p> <p>Copyright 2000-2006 Agilent Technologies</p>
707.5 MHz	<p>Agilent R T Freq/Channel</p> <p>Ch Freq 707.5 MHz Trig Free</p> <p>Center Freq 707.500000 MHz</p> <p>Start Freq 704.500000 MHz</p> <p>Stop Freq 710.500000 MHz</p> <p>CF Step 600.000000 kHz</p> <p>Freq Offset 0.00000000 Hz</p> <p>Signal Track On Off</p> <p>Ref 20 dBm Atten 30 dB</p> <p>Peak</p> <p>Log 10</p> <p>dB/Offst 3.9 dB</p> <p>Center 707.500 MHz Span 6 MHz</p> <p>Res BW 33 kHz VBW 33 kHz Sweep 6.68 ms (601 pts)</p> <p>Occupied Bandwidth 2.6946 MHz Occ BW % Pwr 99.00 %</p> <p>Transmit Freq Error 6.580 kHz x dB -26.00 dB</p> <p>x dB Bandwidth 2.965 MHz</p> <p>Copyright 2000-2006 Agilent Technologies</p>
714.5 MHz	<p>Agilent R T Freq/Channel</p> <p>Ch Freq 714.5 MHz Trig Free</p> <p>Center Freq 714.500000 MHz</p> <p>Start Freq 711.500000 MHz</p> <p>Stop Freq 717.500000 MHz</p> <p>CF Step 600.000000 kHz</p> <p>Freq Offset 0.00000000 Hz</p> <p>Signal Track On Off</p> <p>Ref 20 dBm Atten 30 dB</p> <p>Peak</p> <p>Log 10</p> <p>dB/Offst 3.9 dB</p> <p>Center 714.500 MHz Span 6 MHz</p> <p>Res BW 33 kHz VBW 33 kHz Sweep 6.68 ms (601 pts)</p> <p>Occupied Bandwidth 2.6868 MHz Occ BW % Pwr 99.00 %</p> <p>Transmit Freq Error -1.755 kHz x dB -26.00 dB</p> <p>x dB Bandwidth 2.917 MHz</p> <p>Copyright 2000-2006 Agilent Technologies</p>

LTE Band 12 (Channel Bandwidth: 5 MHz) _ 16QAM	
701.5 MHz	<p>Agilent R T Freq/Channel</p> <p>Ch Freq 701.5 MHz Trig Free</p> <p>Center 701.50 MHz Span 10 MHz</p> <p>Res BW 51 kHz VBW 51 kHz Sweep 4.64 ms (601 pts)</p> <p>Occupied Bandwidth 4.4605 MHz</p> <p>Occ BW % Pwr 99.00 %</p> <p>Transmit Freq Error -5.740 kHz</p> <p>x dB Bandwidth 4.910 MHz</p> <p>x dB -26.00 dB</p> <p>Copyright 2000-2006 Agilent Technologies</p>
707.5 MHz	<p>Agilent R T Freq/Channel</p> <p>Ch Freq 707.5 MHz Trig Free</p> <p>Center 707.50 MHz Span 10 MHz</p> <p>Res BW 51 kHz VBW 51 kHz Sweep 4.64 ms (601 pts)</p> <p>Occupied Bandwidth 4.4658 MHz</p> <p>Occ BW % Pwr 99.00 %</p> <p>Transmit Freq Error 6.576 kHz</p> <p>x dB Bandwidth 4.966 MHz</p> <p>x dB -26.00 dB</p> <p>Copyright 2000-2006 Agilent Technologies</p>
713.5 MHz	<p>Agilent R T Freq/Channel</p> <p>Ch Freq 713.5 MHz Trig Free</p> <p>Center 713.50 MHz Span 10 MHz</p> <p>Res BW 51 kHz VBW 51 kHz Sweep 4.64 ms (601 pts)</p> <p>Occupied Bandwidth 4.4490 MHz</p> <p>Occ BW % Pwr 99.00 %</p> <p>Transmit Freq Error -3.212 kHz</p> <p>x dB Bandwidth 4.818 MHz</p> <p>x dB -26.00 dB</p> <p>Copyright 2000-2006 Agilent Technologies</p>

LTE Band 12 (Channel Bandwidth: 10 MHz) _ 16QAM	
704.0 MHz	<p>Agilent R T Freq/Channel</p> <p>Ch Freq 704 MHz Trig Free</p> <p>Center Freq 704.000000 MHz</p> <p>Start Freq 694.000000 MHz</p> <p>Stop Freq 714.000000 MHz</p> <p>CF Step 2.00000000 MHz Auto Man</p> <p>Freq Offset 0.00000000 Hz</p> <p>Signal Track On Off</p> <p>Ref 20 dBm Atten 30 dB</p> <p>#Peak Log 10 dB/Offst 3.9 dB</p> <p>Center 704.00 MHz Span 20 MHz</p> <p>#Res BW 110 kHz #VBW 110 kHz Sweep 2 ms (601 pts)</p> <p>Occupied Bandwidth 8.9834 MHz</p> <p>Occ BW % Pwr 99.00 %</p> <p>x dB -26.00 dB</p> <p>Transmit Freq Error -272.738 Hz</p> <p>x dB Bandwidth 10.103 MHz</p> <p>Copyright 2000-2006 Agilent Technologies</p>
707.5 MHz	<p>Agilent R T Freq/Channel</p> <p>Ch Freq 707.5 MHz Trig Free</p> <p>Center Freq 707.500000 MHz</p> <p>Start Freq 697.500000 MHz</p> <p>Stop Freq 717.500000 MHz</p> <p>CF Step 2.00000000 MHz Auto Man</p> <p>Freq Offset 0.00000000 Hz</p> <p>Signal Track On Off</p> <p>Ref 20 dBm Atten 30 dB</p> <p>#Peak Log 10 dB/Offst 3.9 dB</p> <p>Center 707.50 MHz Span 20 MHz</p> <p>#Res BW 110 kHz #VBW 110 kHz Sweep 2 ms (601 pts)</p> <p>Occupied Bandwidth 8.9548 MHz</p> <p>Occ BW % Pwr 99.00 %</p> <p>x dB -26.00 dB</p> <p>Transmit Freq Error 13.289 kHz</p> <p>x dB Bandwidth 9.911 MHz</p> <p>Copyright 2000-2006 Agilent Technologies</p>
711.0 MHz	<p>Agilent R T Freq/Channel</p> <p>Ch Freq 711 MHz Trig Free</p> <p>Center Freq 711.000000 MHz</p> <p>Start Freq 701.000000 MHz</p> <p>Stop Freq 721.000000 MHz</p> <p>CF Step 2.00000000 MHz Auto Man</p> <p>Freq Offset 0.00000000 Hz</p> <p>Signal Track On Off</p> <p>Ref 20 dBm Atten 30 dB</p> <p>#Peak Log 10 dB/Offst 3.9 dB</p> <p>Center 711.00 MHz Span 20 MHz</p> <p>#Res BW 110 kHz #VBW 110 kHz Sweep 2 ms (601 pts)</p> <p>Occupied Bandwidth 8.9481 MHz</p> <p>Occ BW % Pwr 99.00 %</p> <p>x dB -26.00 dB</p> <p>Transmit Freq Error -10.191 kHz</p> <p>x dB Bandwidth 9.702 MHz</p> <p>Copyright 2000-2006 Agilent Technologies</p>

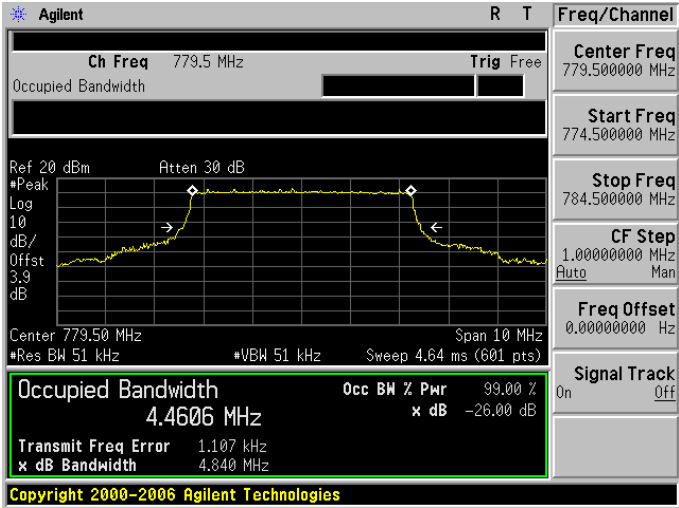
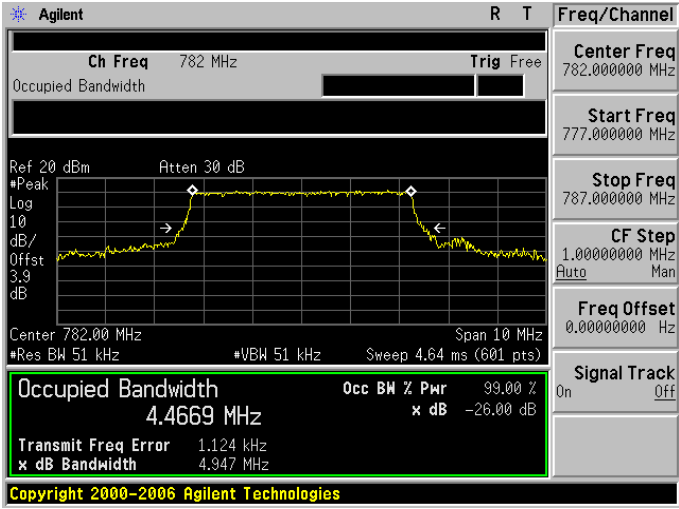
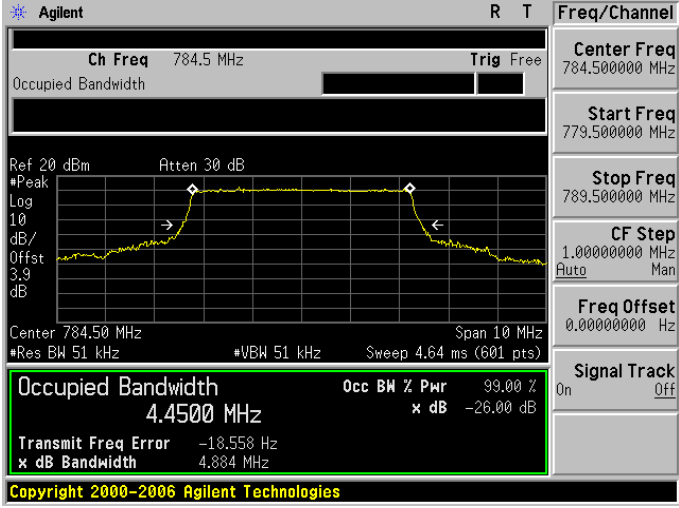
LTE Band 13 (Channel Bandwidth: 5 MHz) _ QPSK	
779.5 MHz	 <p>Agilent R T Freq/Channel</p> <p>Ch Freq 779.5 MHz Trig Free</p> <p>Center 779.50 MHz Span 10 MHz</p> <p>Res BW 51 kHz VBW 51 kHz Sweep 4.64 ms (601 pts)</p> <p>Occupied Bandwidth 4.4606 MHz Occ BW % Pwr 99.00 %</p> <p>Transmit Freq Error 1.107 kHz x dB Bandwidth 4.840 MHz x dB -26.00 dB</p> <p>Copyright 2000-2006 Agilent Technologies</p>
782.0 MHz	 <p>Agilent R T Freq/Channel</p> <p>Ch Freq 782 MHz Trig Free</p> <p>Center 782.00 MHz Span 10 MHz</p> <p>Res BW 51 kHz VBW 51 kHz Sweep 4.64 ms (601 pts)</p> <p>Occupied Bandwidth 4.4669 MHz Occ BW % Pwr 99.00 %</p> <p>Transmit Freq Error 1.124 kHz x dB Bandwidth 4.947 MHz x dB -26.00 dB</p> <p>Copyright 2000-2006 Agilent Technologies</p>
784.5 MHz	 <p>Agilent R T Freq/Channel</p> <p>Ch Freq 784.5 MHz Trig Free</p> <p>Center 784.50 MHz Span 10 MHz</p> <p>Res BW 51 kHz VBW 51 kHz Sweep 4.64 ms (601 pts)</p> <p>Occupied Bandwidth 4.4500 MHz Occ BW % Pwr 99.00 %</p> <p>Transmit Freq Error -18.558 Hz x dB Bandwidth 4.884 MHz x dB -26.00 dB</p> <p>Copyright 2000-2006 Agilent Technologies</p>

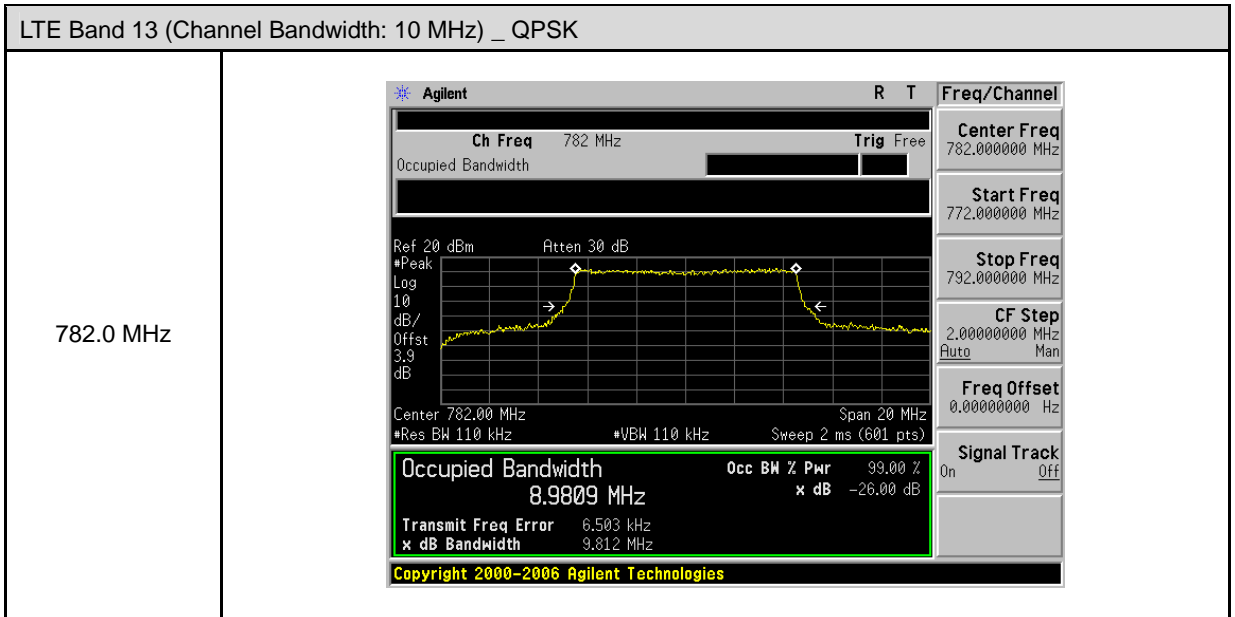

LTE Band 13 (Channel Bandwidth: 5 MHz) _ 16QAM	
779.5 MHz	<p>Agilent R T Freq/Channel</p> <p>Ch Freq 779.5 MHz Trig Free</p> <p>Center Freq 779.500000 MHz</p> <p>Start Freq 774.500000 MHz</p> <p>Stop Freq 784.500000 MHz</p> <p>CF Step 1.00000000 MHz</p> <p>Freq Offset 0.00000000 Hz</p> <p>Signal Track On Off</p> <p>Ref 20 dBm Atten 30 dB</p> <p>Peak 10 dB/Offst 3.9 dB</p> <p>Center 779.50 MHz Span 10 MHz</p> <p>Res BW 51 kHz VBW 51 kHz Sweep 4.64 ms (601 pts)</p> <p>Occupied Bandwidth 4.4560 MHz</p> <p>Occ BW % Pwr 99.00 %</p> <p>x dB -26.00 dB</p> <p>Transmit Freq Error -2.046 kHz</p> <p>x dB Bandwidth 4.829 MHz</p> <p>Copyright 2000-2006 Agilent Technologies</p>
782.0 MHz	<p>Agilent R T Freq/Channel</p> <p>Ch Freq 782 MHz Trig Free</p> <p>Center Freq 782.000000 MHz</p> <p>Start Freq 777.000000 MHz</p> <p>Stop Freq 787.000000 MHz</p> <p>CF Step 1.00000000 MHz</p> <p>Freq Offset 0.00000000 Hz</p> <p>Signal Track On Off</p> <p>Ref 20 dBm Atten 30 dB</p> <p>Peak 10 dB/Offst 3.9 dB</p> <p>Center 782.00 MHz Span 10 MHz</p> <p>Res BW 51 kHz VBW 51 kHz Sweep 4.64 ms (601 pts)</p> <p>Occupied Bandwidth 4.4717 MHz</p> <p>Occ BW % Pwr 99.00 %</p> <p>x dB -26.00 dB</p> <p>Transmit Freq Error 1.094 kHz</p> <p>x dB Bandwidth 4.964 MHz</p> <p>Copyright 2000-2006 Agilent Technologies</p>
784.5 MHz	<p>Agilent R T Freq/Channel</p> <p>Ch Freq 784.5 MHz Trig Free</p> <p>Center Freq 784.500000 MHz</p> <p>Start Freq 779.500000 MHz</p> <p>Stop Freq 789.500000 MHz</p> <p>CF Step 1.00000000 MHz</p> <p>Freq Offset 0.00000000 Hz</p> <p>Signal Track On Off</p> <p>Ref 20 dBm Atten 30 dB</p> <p>Peak 10 dB/Offst 3.9 dB</p> <p>Center 784.50 MHz Span 10 MHz</p> <p>Res BW 51 kHz VBW 51 kHz Sweep 4.64 ms (601 pts)</p> <p>Occupied Bandwidth 4.4482 MHz</p> <p>Occ BW % Pwr 99.00 %</p> <p>x dB -26.00 dB</p> <p>Transmit Freq Error 759.220 Hz</p> <p>x dB Bandwidth 4.903 MHz</p> <p>Copyright 2000-2006 Agilent Technologies</p>

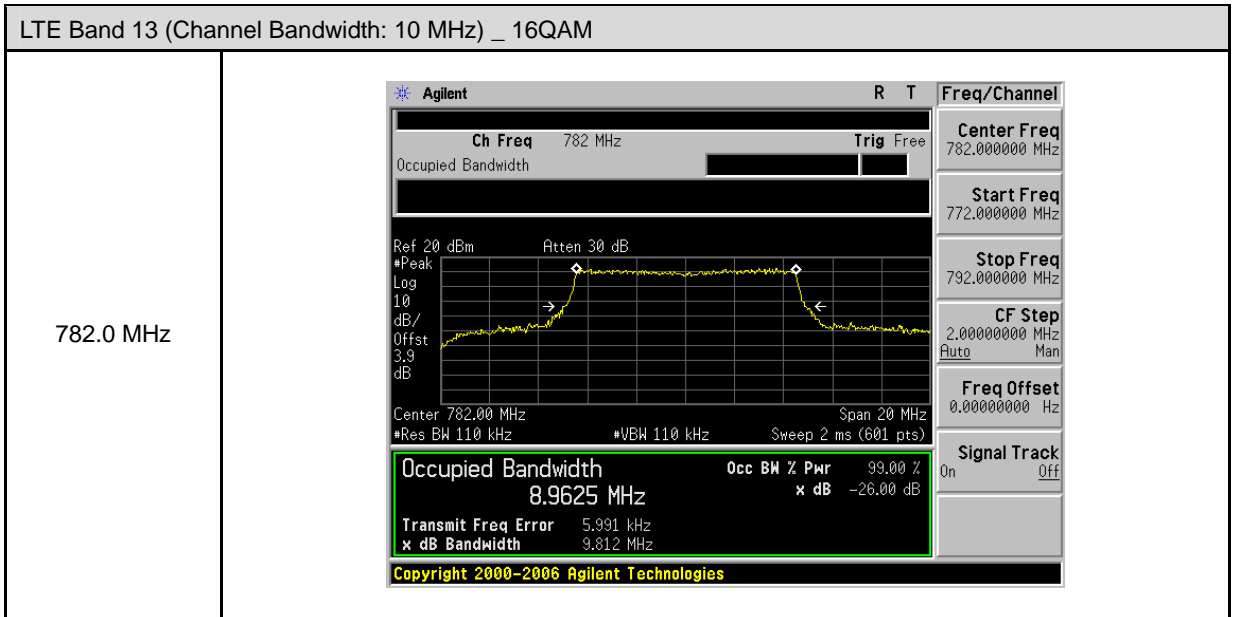

LTE Band 17 (Channel Bandwidth: 5 MHz) _ QPSK	
706.5 MHz	<p>Agilent R T Freq/Channel</p> <p>Ch Freq 706.5 MHz Trig Free</p> <p>Center Freq 706.500000 MHz</p> <p>Start Freq 701.500000 MHz</p> <p>Stop Freq 711.500000 MHz</p> <p>CF Step 1.00000000 MHz Auto Man</p> <p>Freq Offset 0.00000000 Hz</p> <p>Signal Track On Off</p> <p>Ref 20 dBm Atten 30 dB</p> <p>#Peak Log 10 dB/Offst 3.9 dB</p> <p>Center 706.50 MHz Span 10 MHz</p> <p>#Res BW 51 kHz #VBW 51 kHz Sweep 4.64 ms (601 pts)</p> <p>Occupied Bandwidth 4.4758 MHz</p> <p>Occ BW % Pwr 99.00 %</p> <p>x dB -26.00 dB</p> <p>Transmit Freq Error 8.523 kHz</p> <p>x dB Bandwidth 4.990 MHz</p> <p>Copyright 2000-2006 Agilent Technologies</p>
710.0 MHz	<p>Agilent R T Freq/Channel</p> <p>Ch Freq 710 MHz Trig Free</p> <p>Center Freq 710.000000 MHz</p> <p>Start Freq 705.000000 MHz</p> <p>Stop Freq 715.000000 MHz</p> <p>CF Step 1.00000000 MHz Auto Man</p> <p>Freq Offset 0.00000000 Hz</p> <p>Signal Track On Off</p> <p>Ref 20 dBm Atten 30 dB</p> <p>#Peak Log 10 dB/Offst 3.9 dB</p> <p>Center 710.00 MHz Span 10 MHz</p> <p>#Res BW 51 kHz #VBW 51 kHz Sweep 4.64 ms (601 pts)</p> <p>Occupied Bandwidth 4.4559 MHz</p> <p>Occ BW % Pwr 99.00 %</p> <p>x dB -26.00 dB</p> <p>Transmit Freq Error 2.676 kHz</p> <p>x dB Bandwidth 4.888 MHz</p> <p>Copyright 2000-2006 Agilent Technologies</p>
713.5 MHz	<p>Agilent R T Freq/Channel</p> <p>Ch Freq 713.5 MHz Trig Free</p> <p>Center Freq 713.500000 MHz</p> <p>Start Freq 708.500000 MHz</p> <p>Stop Freq 718.500000 MHz</p> <p>CF Step 1.00000000 MHz Auto Man</p> <p>Freq Offset 0.00000000 Hz</p> <p>Signal Track On Off</p> <p>Ref 20 dBm Atten 30 dB</p> <p>#Peak Log 10 dB/Offst 3.9 dB</p> <p>Center 713.50 MHz Span 10 MHz</p> <p>#Res BW 51 kHz #VBW 51 kHz Sweep 4.64 ms (601 pts)</p> <p>Occupied Bandwidth 4.4752 MHz</p> <p>Occ BW % Pwr 99.00 %</p> <p>x dB -26.00 dB</p> <p>Transmit Freq Error 1.256 kHz</p> <p>x dB Bandwidth 4.920 MHz</p> <p>Copyright 2000-2006 Agilent Technologies</p>

LTE Band 17 (Channel Bandwidth: 10 MHz) _ QPSK	
709.0 MHz	<p>Agilent R T Freq/Channel</p> <p>Ch Freq 709 MHz Trig Free</p> <p>Center 709.00 MHz Span 20 MHz</p> <p>Occupied Bandwidth 8.9668 MHz</p> <p>Transmit Freq Error 13.448 kHz</p> <p>x dB Bandwidth 9.775 MHz</p> <p>Occ BW % Pwr 99.00 %</p> <p>x dB -26.00 dB</p> <p>Copyright 2000-2006 Agilent Technologies</p>
710.0 MHz	<p>Agilent R T Freq/Channel</p> <p>Ch Freq 710 MHz Trig Free</p> <p>Center 710.00 MHz Span 20 MHz</p> <p>Occupied Bandwidth 8.9352 MHz</p> <p>Transmit Freq Error 8.325 kHz</p> <p>x dB Bandwidth 9.719 MHz</p> <p>Occ BW % Pwr 99.00 %</p> <p>x dB -26.00 dB</p> <p>Copyright 2000-2006 Agilent Technologies</p>
711.0 MHz	<p>Agilent R T Freq/Channel</p> <p>Ch Freq 711 MHz Trig Free</p> <p>Center 711.00 MHz Span 20 MHz</p> <p>Occupied Bandwidth 8.9558 MHz</p> <p>Transmit Freq Error -4.226 kHz</p> <p>x dB Bandwidth 9.896 MHz</p> <p>Occ BW % Pwr 99.00 %</p> <p>x dB -26.00 dB</p> <p>Copyright 2000-2006 Agilent Technologies</p>

LTE Band 17 (Channel Bandwidth: 5 MHz) _ 16QAM	
706.5 MHz	<p>Agilent R T Freq/Channel</p> <p>Ch Freq 706.5 MHz Trig Free</p> <p>Center 706.50 MHz Span 10 MHz</p> <p>Res BW 51 kHz VBW 51 kHz Sweep 4.64 ms (601 pts)</p> <p>Occupied Bandwidth 4.4770 MHz</p> <p>Transmit Freq Error 8.129 kHz</p> <p>x dB Bandwidth 4.969 MHz</p> <p>Occ BW % Pwr 99.00 %</p> <p>x dB -26.00 dB</p> <p>Copyright 2000-2006 Agilent Technologies</p>
710.0 MHz	<p>Agilent R T Freq/Channel</p> <p>Ch Freq 710 MHz Trig Free</p> <p>Center 710.00 MHz Span 10 MHz</p> <p>Res BW 51 kHz VBW 51 kHz Sweep 4.64 ms (601 pts)</p> <p>Occupied Bandwidth 4.4634 MHz</p> <p>Transmit Freq Error 4.523 kHz</p> <p>x dB Bandwidth 4.888 MHz</p> <p>Occ BW % Pwr 99.00 %</p> <p>x dB -26.00 dB</p> <p>Copyright 2000-2006 Agilent Technologies</p>
713.5 MHz	<p>Agilent R T Freq/Channel</p> <p>Ch Freq 713.5 MHz Trig Free</p> <p>Center 713.50 MHz Span 10 MHz</p> <p>Res BW 51 kHz VBW 51 kHz Sweep 4.64 ms (601 pts)</p> <p>Occupied Bandwidth 4.4647 MHz</p> <p>Transmit Freq Error -4.820 kHz</p> <p>x dB Bandwidth 4.912 MHz</p> <p>Occ BW % Pwr 99.00 %</p> <p>x dB -26.00 dB</p> <p>Copyright 2000-2006 Agilent Technologies</p>

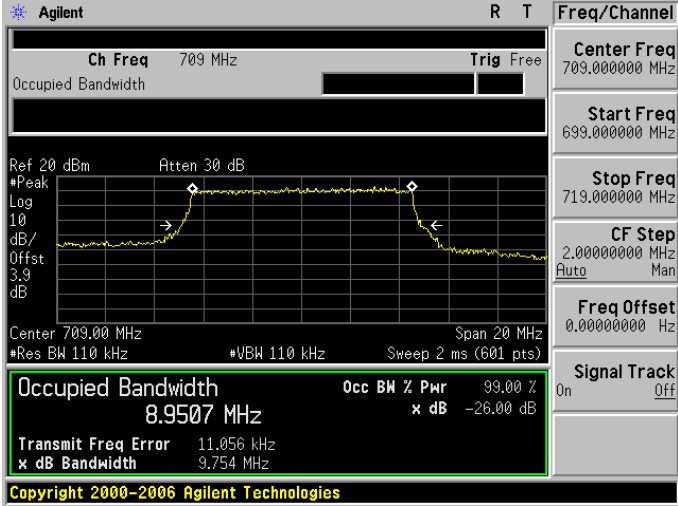
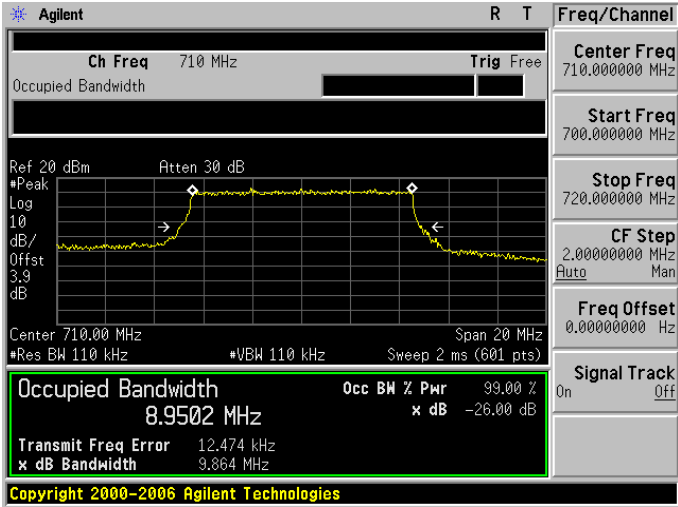
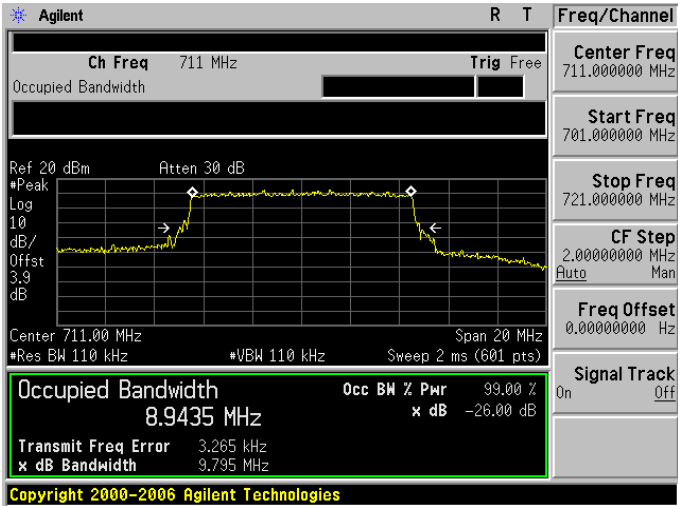
LTE Band 17 (Channel Bandwidth: 10 MHz) _ 16QAM	
709.0 MHz	 <p>Agilent R T Freq/Channel</p> <p>Ch Freq 709 MHz Trig Free</p> <p>Center Freq 709.000000 MHz</p> <p>Start Freq 699.000000 MHz</p> <p>Stop Freq 719.000000 MHz</p> <p>CF Step 2.00000000 MHz Auto Man</p> <p>Freq Offset 0.00000000 Hz</p> <p>Signal Track On Off</p> <p>Ref 20 dBm Atten 30 dB</p> <p>#Peak Log 10 dB/Offst 3.9 dB</p> <p>Center 709.00 MHz Span 20 MHz</p> <p>#Res BW 110 kHz #VBW 110 kHz Sweep 2 ms (601 pts)</p> <p>Occupied Bandwidth 8.9507 MHz</p> <p>Occ BW % Pwr 99.00 %</p> <p>x dB Bandwidth 9.754 MHz x dB -26.00 dB</p> <p>Transmit Freq Error 11.056 kHz</p> <p>Copyright 2000-2006 Agilent Technologies</p>
710.0 MHz	 <p>Agilent R T Freq/Channel</p> <p>Ch Freq 710 MHz Trig Free</p> <p>Center Freq 710.000000 MHz</p> <p>Start Freq 700.000000 MHz</p> <p>Stop Freq 720.000000 MHz</p> <p>CF Step 2.00000000 MHz Auto Man</p> <p>Freq Offset 0.00000000 Hz</p> <p>Signal Track On Off</p> <p>Ref 20 dBm Atten 30 dB</p> <p>#Peak Log 10 dB/Offst 3.9 dB</p> <p>Center 710.00 MHz Span 20 MHz</p> <p>#Res BW 110 kHz #VBW 110 kHz Sweep 2 ms (601 pts)</p> <p>Occupied Bandwidth 8.9502 MHz</p> <p>Occ BW % Pwr 99.00 %</p> <p>x dB Bandwidth 9.864 MHz x dB -26.00 dB</p> <p>Transmit Freq Error 12.474 kHz</p> <p>Copyright 2000-2006 Agilent Technologies</p>
711.0 MHz	 <p>Agilent R T Freq/Channel</p> <p>Ch Freq 711 MHz Trig Free</p> <p>Center Freq 711.000000 MHz</p> <p>Start Freq 701.000000 MHz</p> <p>Stop Freq 721.000000 MHz</p> <p>CF Step 2.00000000 MHz Auto Man</p> <p>Freq Offset 0.00000000 Hz</p> <p>Signal Track On Off</p> <p>Ref 20 dBm Atten 30 dB</p> <p>#Peak Log 10 dB/Offst 3.9 dB</p> <p>Center 711.00 MHz Span 20 MHz</p> <p>#Res BW 110 kHz #VBW 110 kHz Sweep 2 ms (601 pts)</p> <p>Occupied Bandwidth 8.9435 MHz</p> <p>Occ BW % Pwr 99.00 %</p> <p>x dB Bandwidth 9.795 MHz x dB -26.00 dB</p> <p>Transmit Freq Error 3.265 kHz</p> <p>Copyright 2000-2006 Agilent Technologies</p>

6 Peak to Average Ratio Test

6.1. Limit

In measuring transmissions in this band using an average power technique, the peak to-average ratio (PAR) of the transmission may not exceed 13 dB.

6.2. Test Instruments

Equipment	Manufacturer	Model No.	Serial No.	Cal. Date	Remark
Spectrum Analyzer	Agilent	E4445A	MY46181986	05/14/2015	(1)
Wideband Radio Communication Test	R & S	CMW500	103168	11/05/2014	(1)
Attenuator	RADIALL	R41572000	0603033073	N.C.R.	-----
Power divider	Agilent	87302C	3239A00760	N.C.R.	-----
Test Site	ATL	TE05	TE05	N.C.R.	-----

Remark: ⁽¹⁾ Calibration period 1 year. ⁽²⁾ Calibration period 2 years.

Note: N.C.R. = No Calibration Request.

6.3. Setup

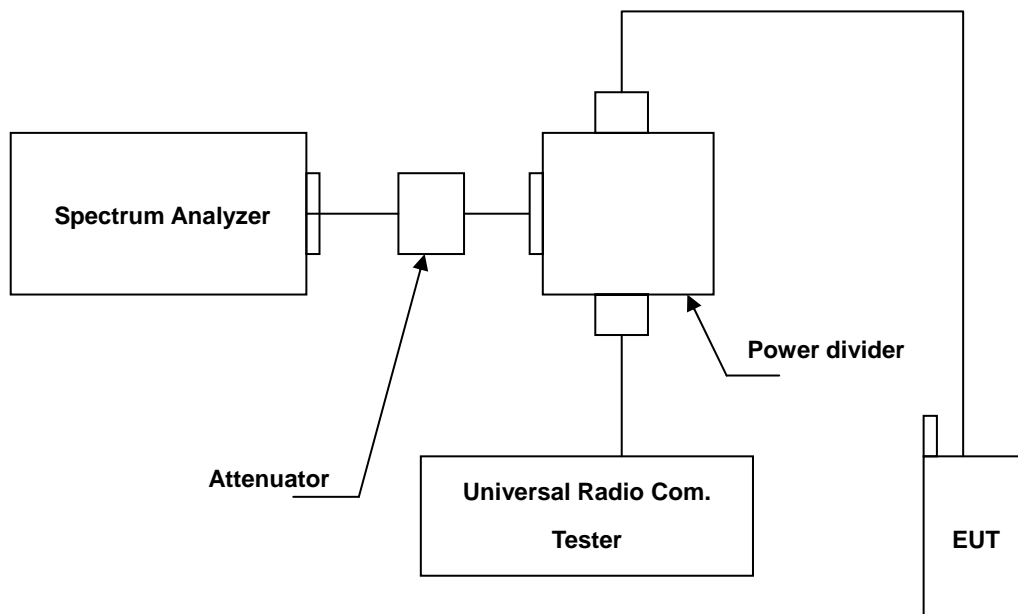

6.4. Test Procedure

The measurement is made according to FCC rules:

- a. Set resolution/measurement bandwidth signal's occupied bandwidth;
- b. Set the number of counts to a value that stabilizes the measured CCDF curve;
- c. Record the maximum PAPR level associated with a probability of 0.1%.

6.5. Uncertainty

The measurement uncertainty is defined as for Conducted Power measurement is 1.2 dB.

6.6. Test Result

Model Number	LE910-NA V2		
Test Item	Peak to Average Ratio		
Date of Test	06/12/2015	Test Site	TE05

LTE Band 2				
Modulation	Channel Bandwidth	Frequency (MHz)	Peak to Average Ratio (dB)	Limit (dB)
QPSK	1.4 MHz	1880.0	4.70	< 13
	3 MHz	1880.0	4.46	< 13
	5 MHz	1880.0	3.93	< 13
	10 MHz	1880.0	3.70	< 13
	15 MHz	1880.0	3.47	< 13
	20 MHz	1880.0	3.53	< 13
16QAM	1.4 MHz	1880.0	5.52	< 13
	3 MHz	1880.0	5.21	< 13
	5 MHz	1880.0	4.60	< 13
	10 MHz	1880.0	4.56	< 13
	15 MHz	1880.0	4.29	< 13
	20 MHz	1880.0	4.14	< 13

LTE Band 4				
Modulation	Channel Bandwidth	Frequency (MHz)	Peak to Average Ratio (dB)	Limit (dB)
QPSK	1.4 MHz	1732.5	5.40	< 13
	3 MHz	1732.5	5.22	< 13
	5 MHz	1732.5	5.18	< 13
	10 MHz	1732.5	5.25	< 13
	15 MHz	1732.5	5.24	< 13
	20 MHz	1732.5	5.22	< 13
16QAM	1.4 MHz	1732.5	6.18	< 13
	3 MHz	1732.5	5.95	< 13
	5 MHz	1732.5	5.80	< 13
	10 MHz	1732.5	6.05	< 13
	15 MHz	1732.5	6.14	< 13
	20 MHz	1732.5	5.77	< 13

LTE Band 5				
Modulation	Channel Bandwidth	Frequency (MHz)	Peak to Average Ratio (dB)	Limit (dB)
QPSK	1.4 MHz	836.5	6.12	< 13
	3 MHz	836.5	5.67	< 13
	5 MHz	836.5	5.56	< 13
	10 MHz	836.5	5.84	< 13
16QAM	1.4 MHz	836.5	6.71	< 13
	3 MHz	836.5	6.29	< 13
	5 MHz	836.5	6.18	< 13
	10 MHz	836.5	6.53	< 13

LTE Band 12				
Modulation	Channel Bandwidth	Frequency (MHz)	Peak to Average Ratio (dB)	Limit (dB)
QPSK	1.4 MHz	707.5	5.83	< 13
	3 MHz	707.5	5.52	< 13
	5 MHz	707.5	5.57	< 13
	10 MHz	707.5	5.80	< 13
16QAM	1.4 MHz	707.5	6.67	< 13
	3 MHz	707.5	6.25	< 13
	5 MHz	707.5	6.11	< 13
	10 MHz	707.5	6.61	< 13

LTE Band 13				
Modulation	Channel Bandwidth	Frequency (MHz)	Peak to Average Ratio (dB)	Limit (dB)
QPSK	5 MHz	782.0	5.40	< 13
	10 MHz	782.0	5.46	< 13
16QAM	5 MHz	782.0	5.94	< 13
	10 MHz	782.0	6.29	< 13

LTE Band 17				
Modulation	Channel Bandwidth	Frequency (MHz)	Peak to Average Ratio (dB)	Limit (dB)
QPSK	5 MHz	710.0	5.43	< 13
	10 MHz	710.0	5.71	< 13
16QAM	5 MHz	710.0	6.03	< 13
	10 MHz	710.0	6.41	< 13

6.7. Test Graphs

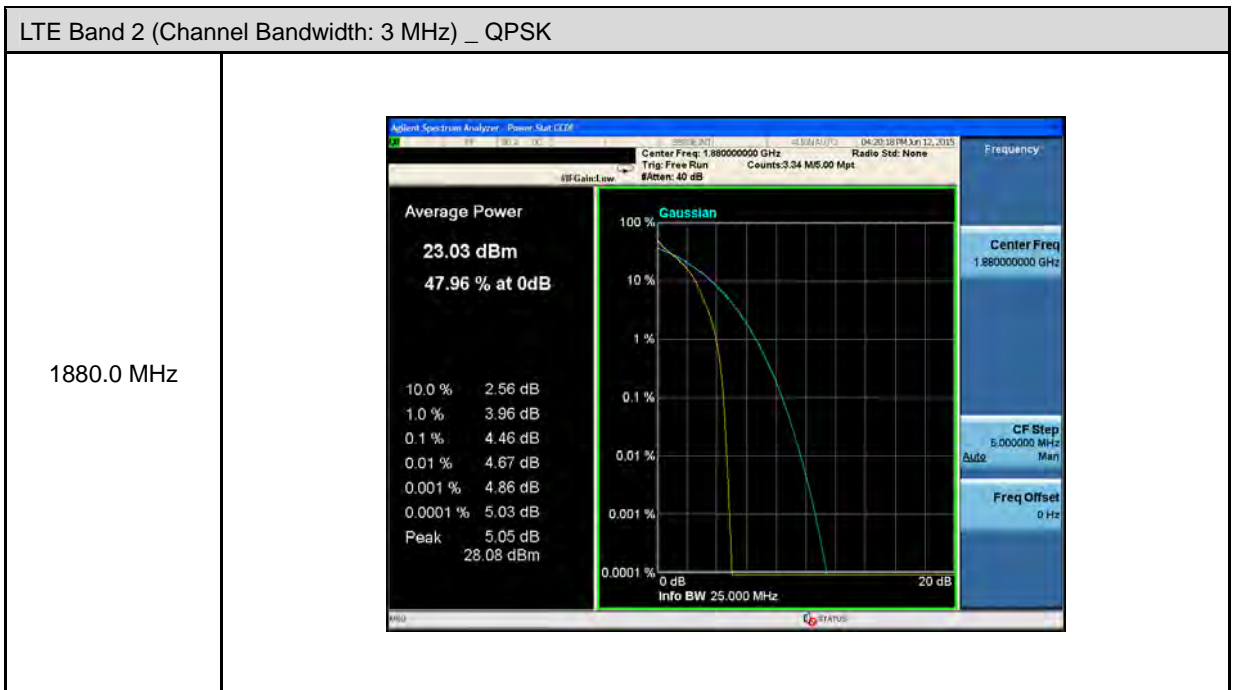
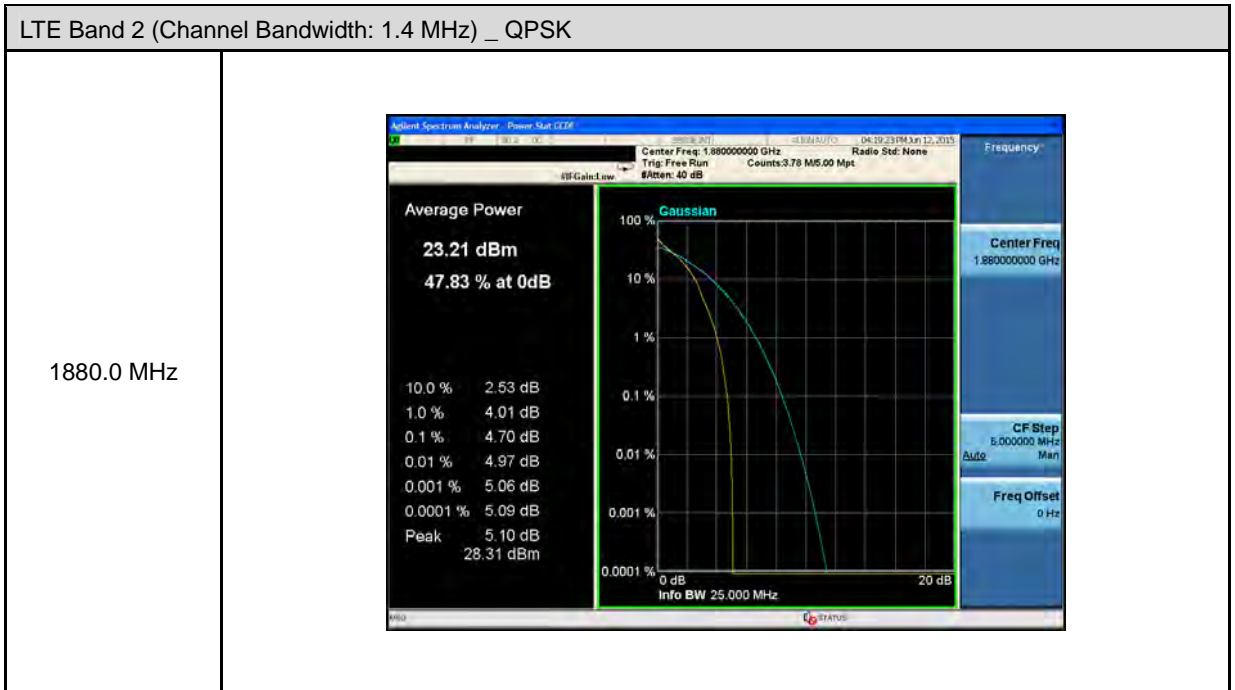

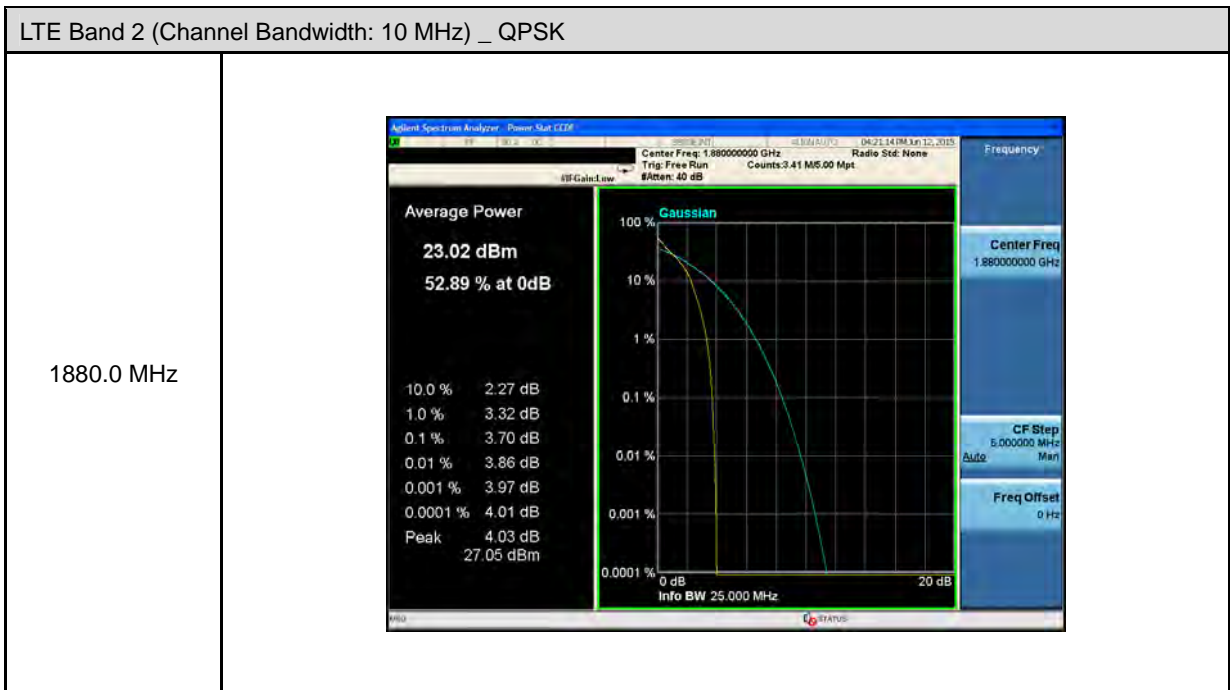
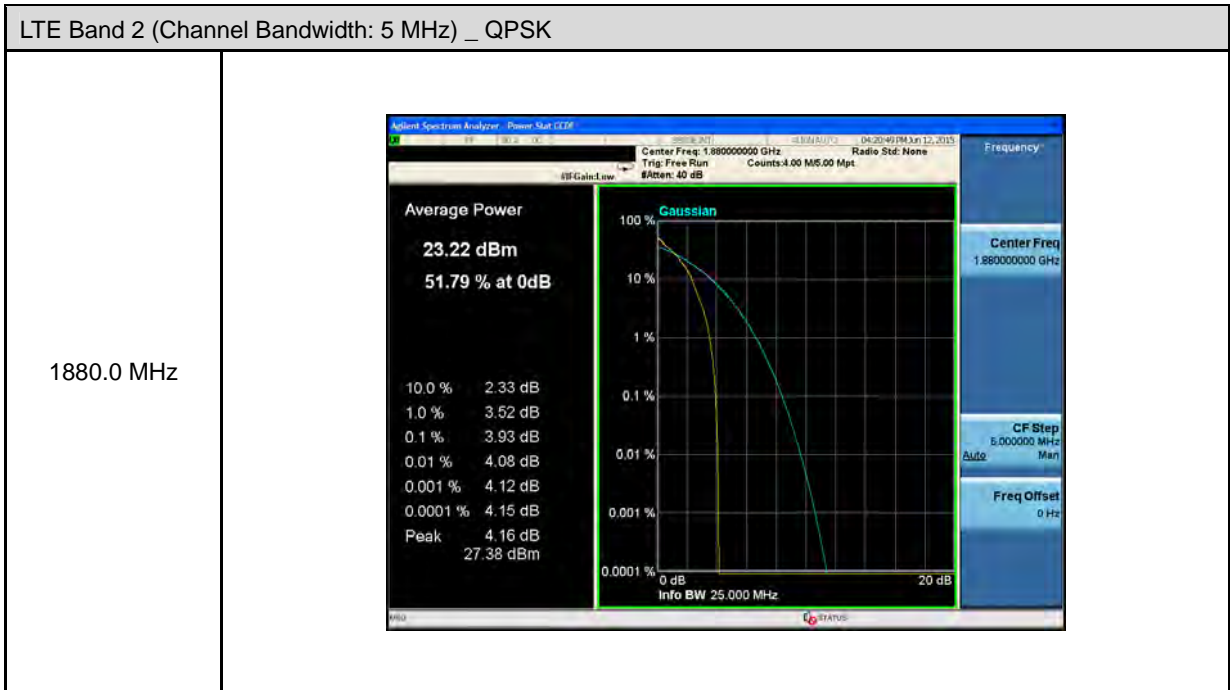

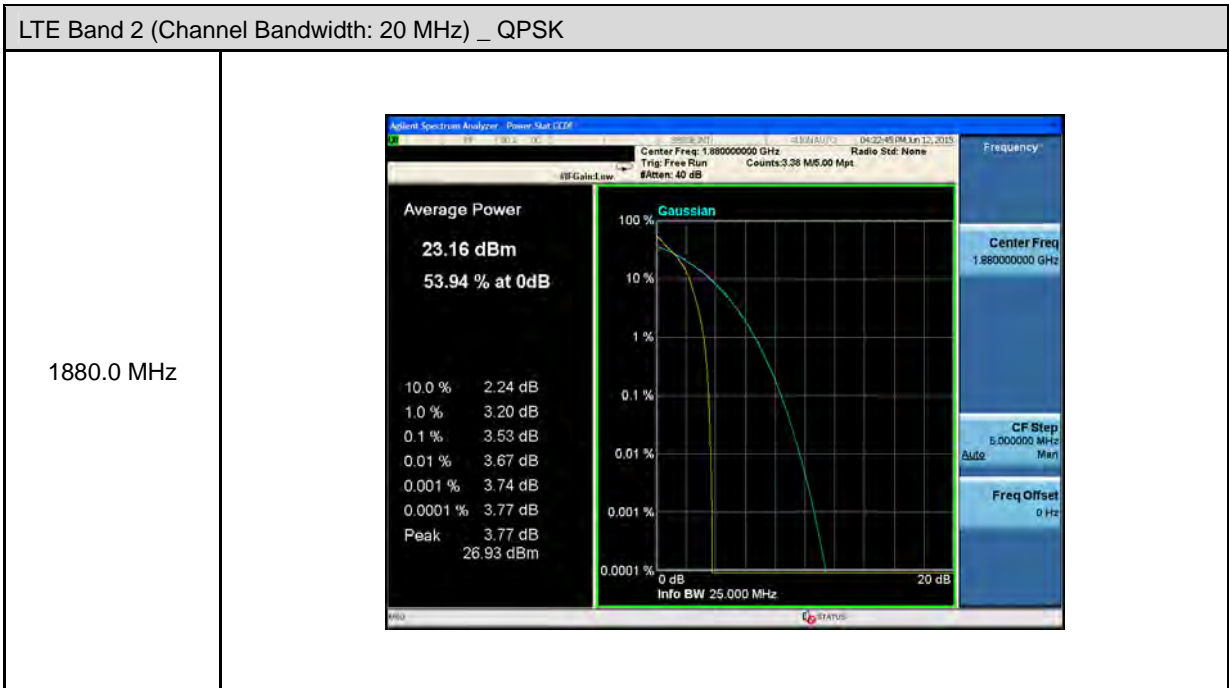
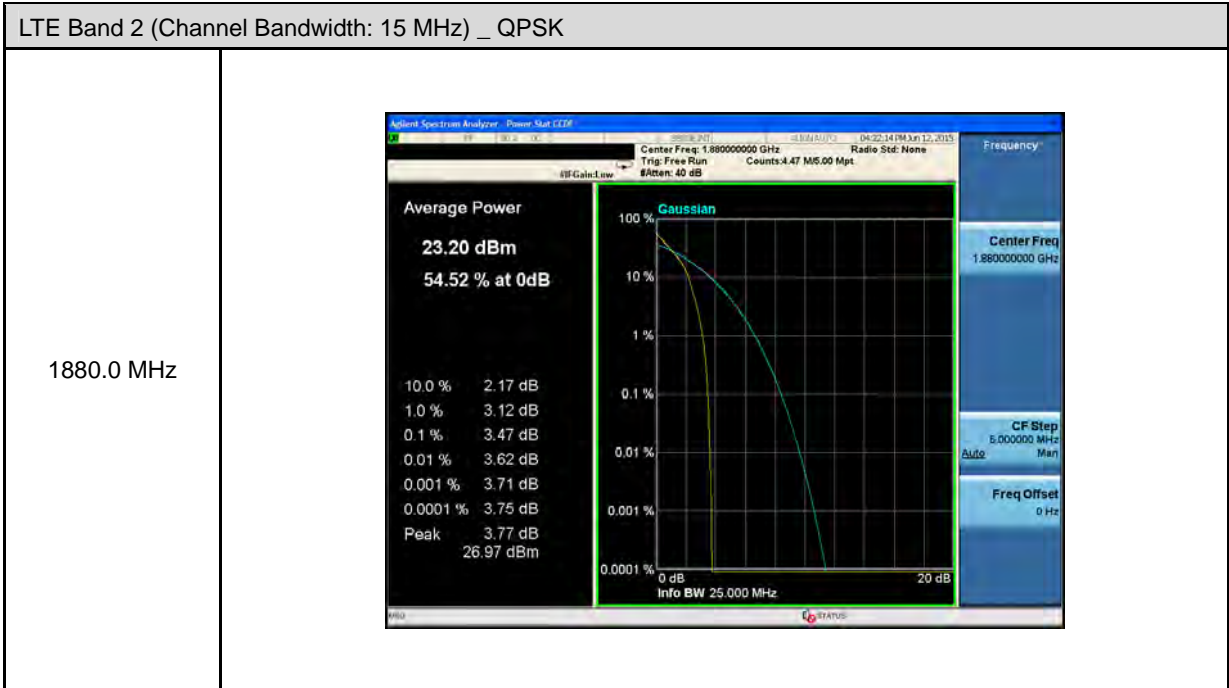

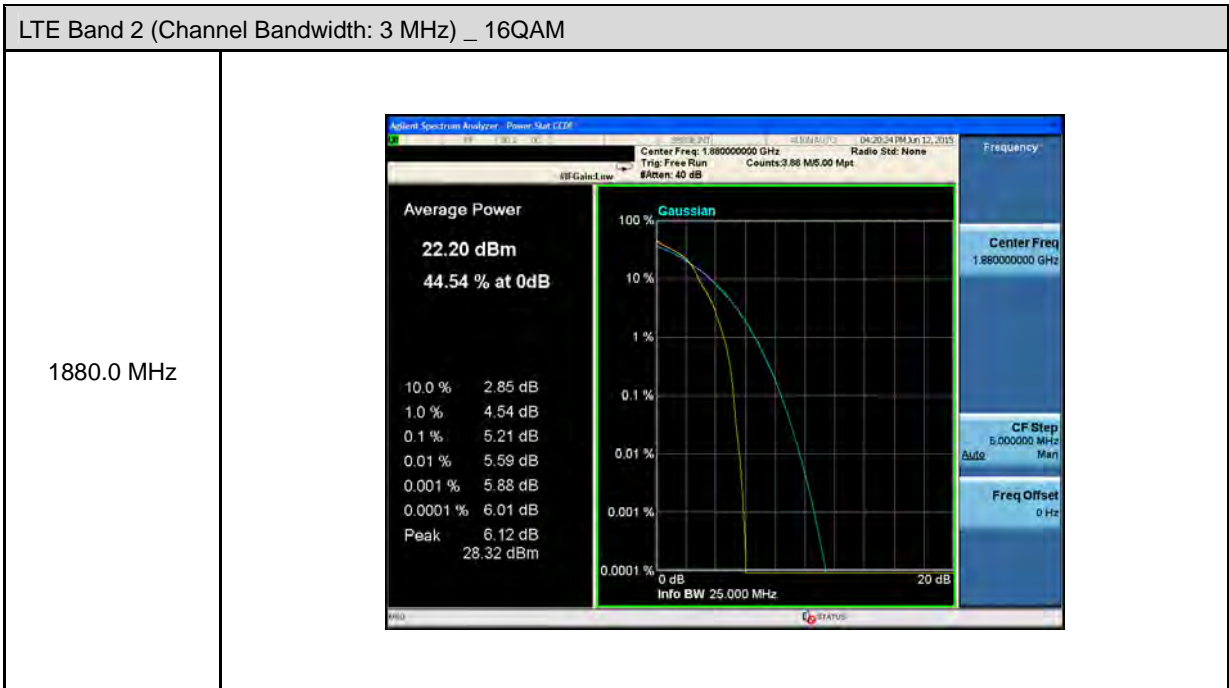
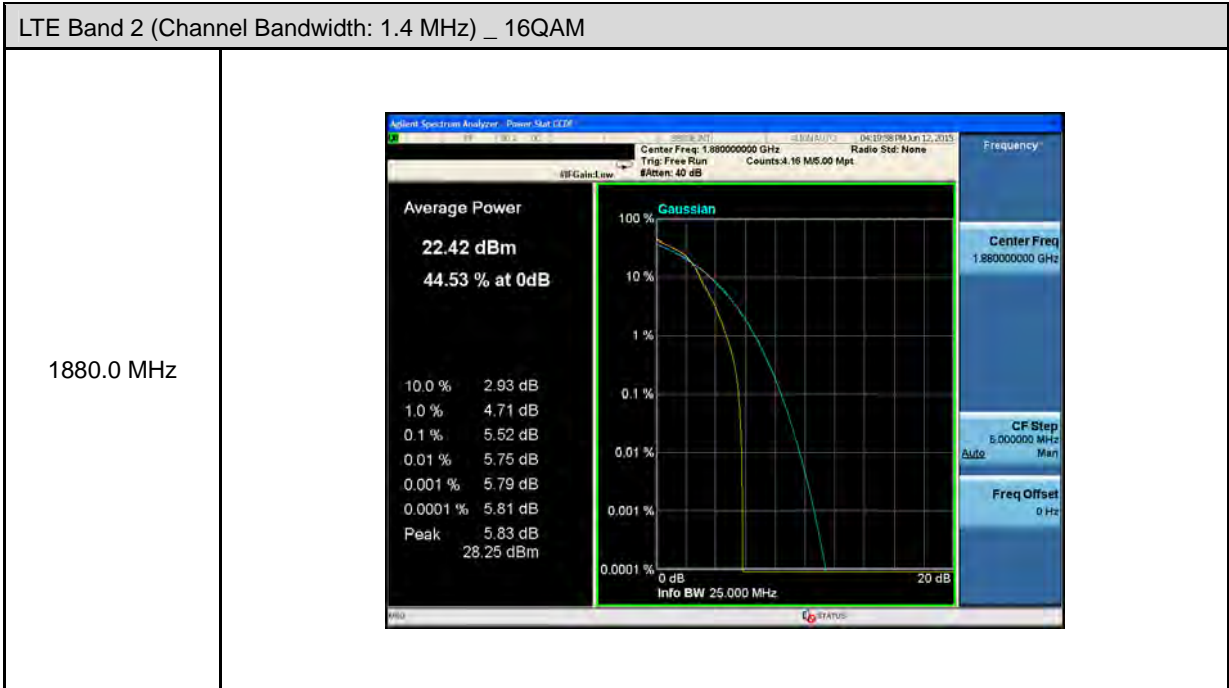

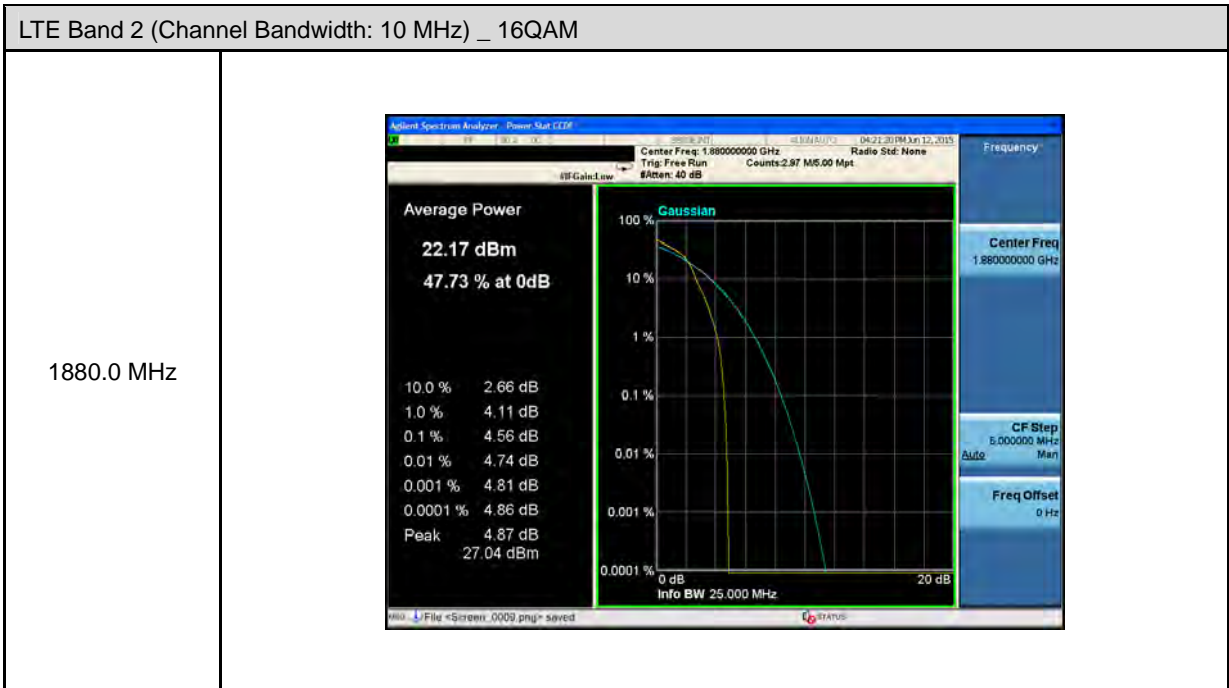
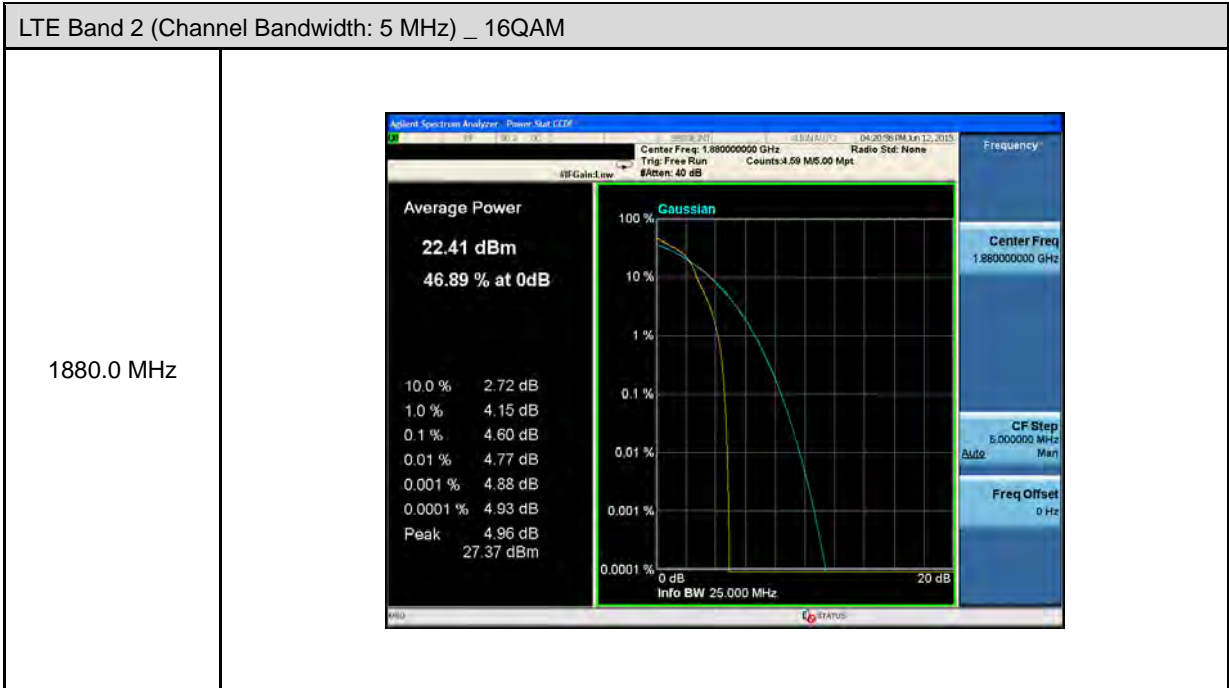

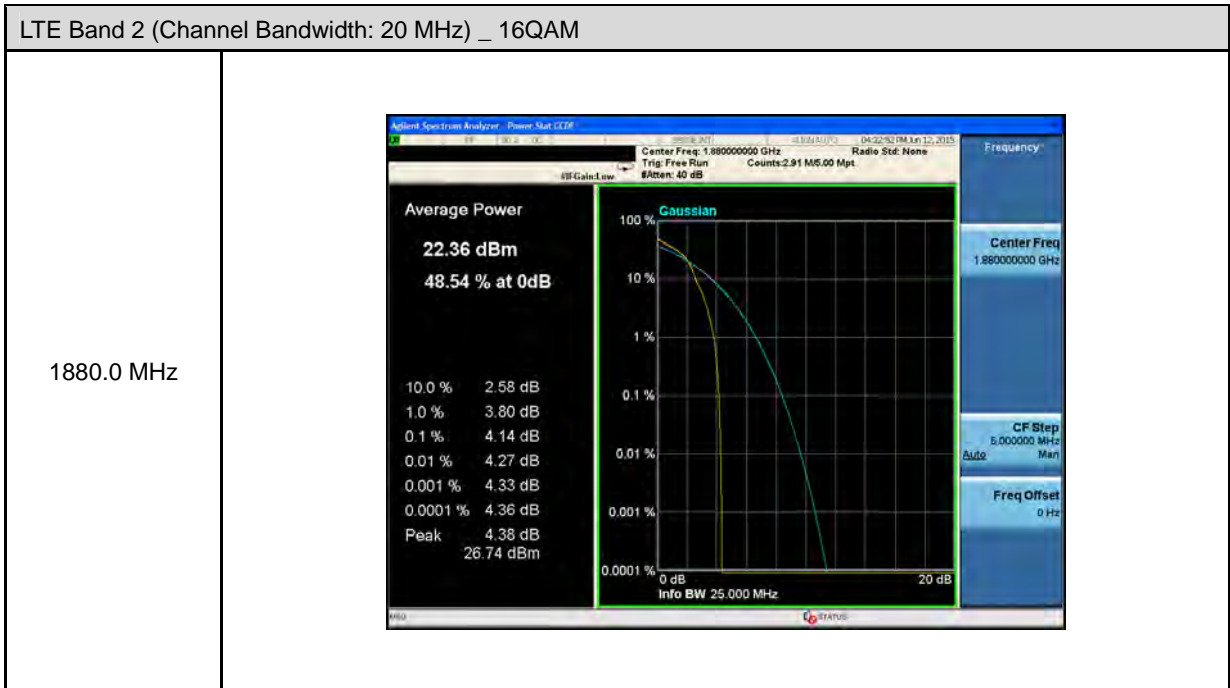
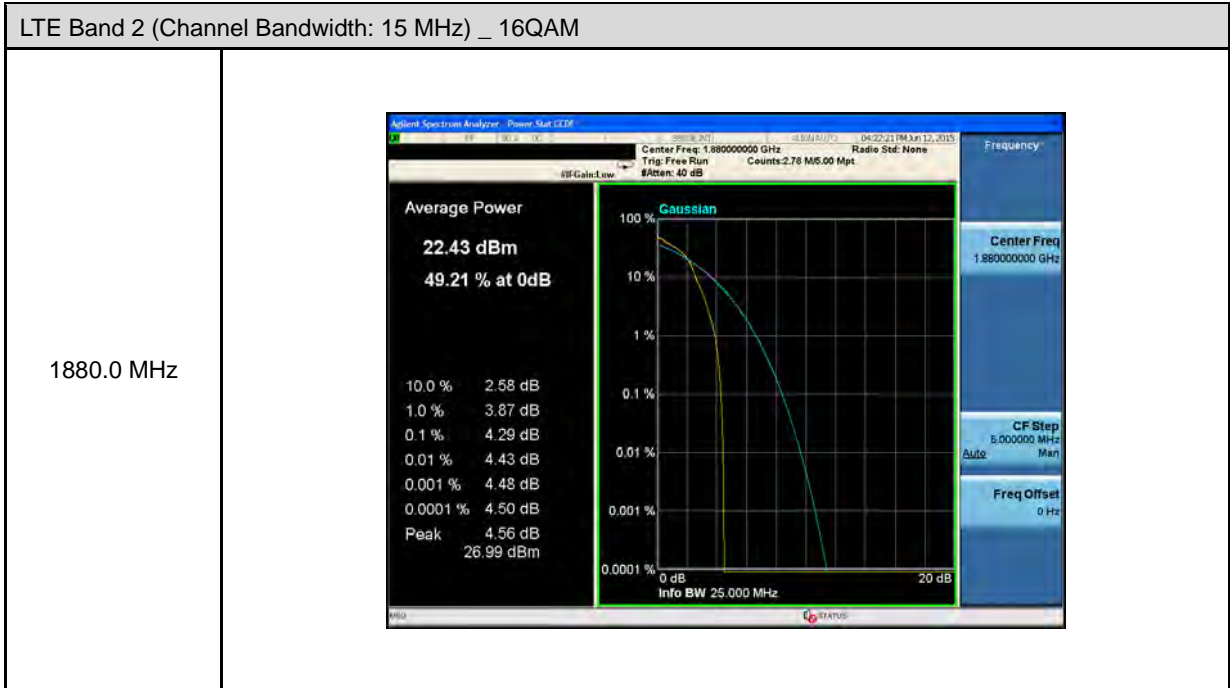

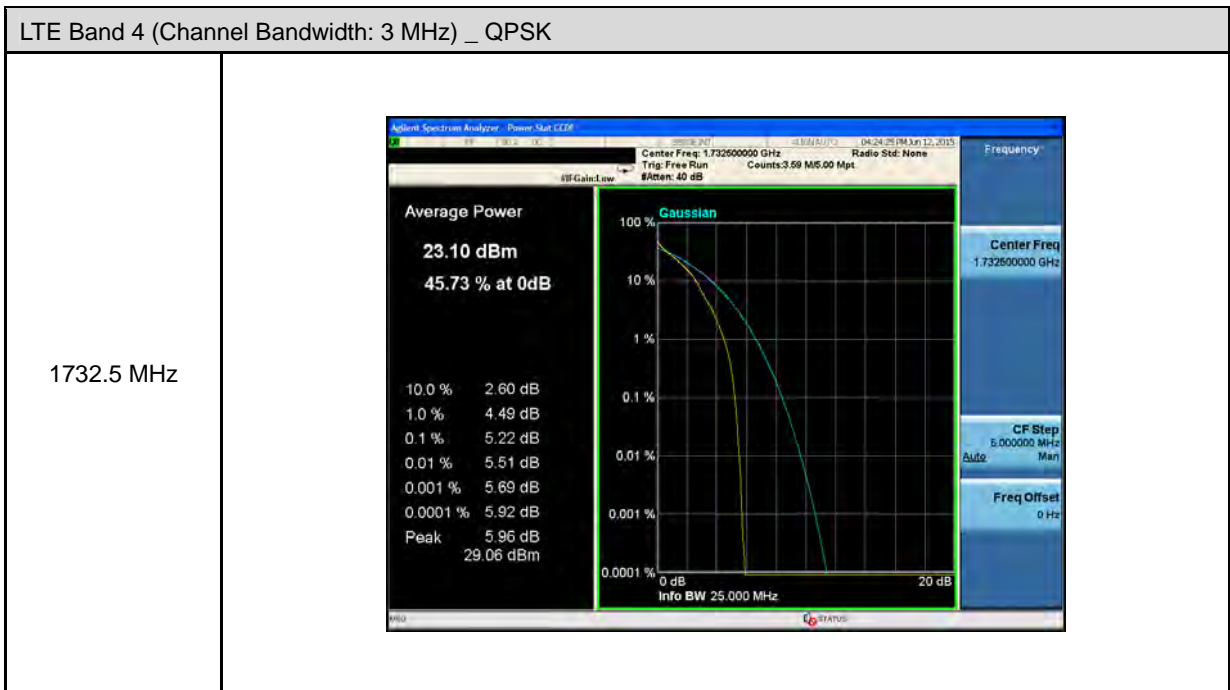
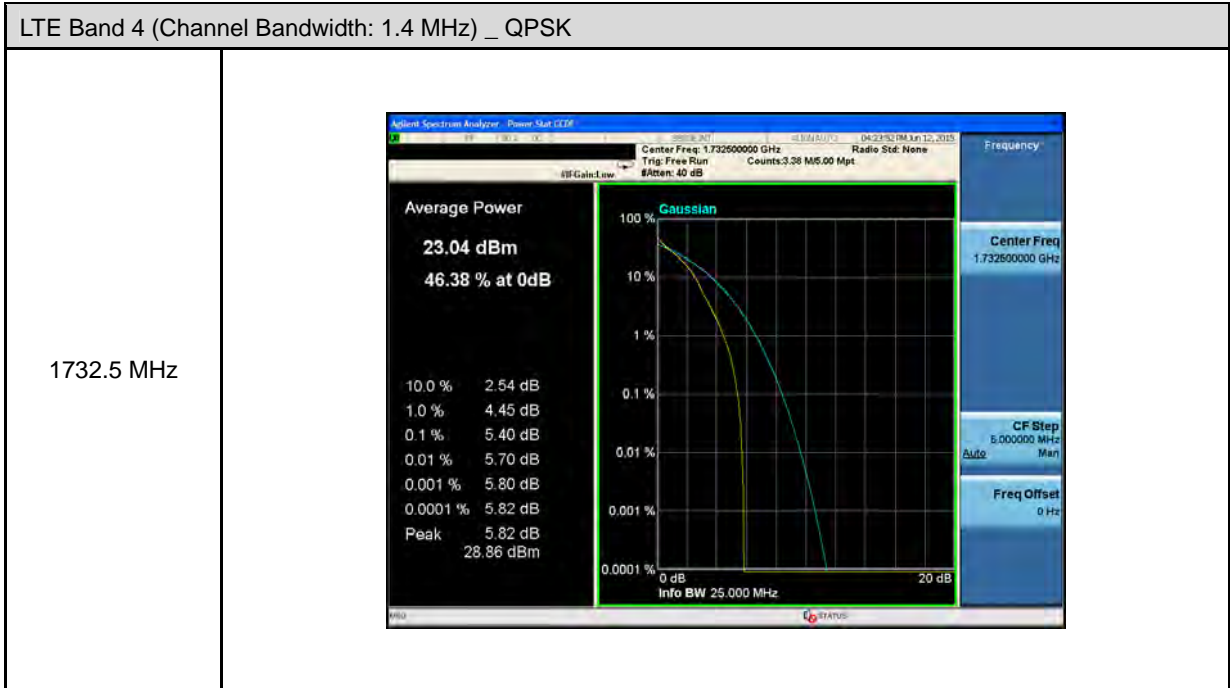

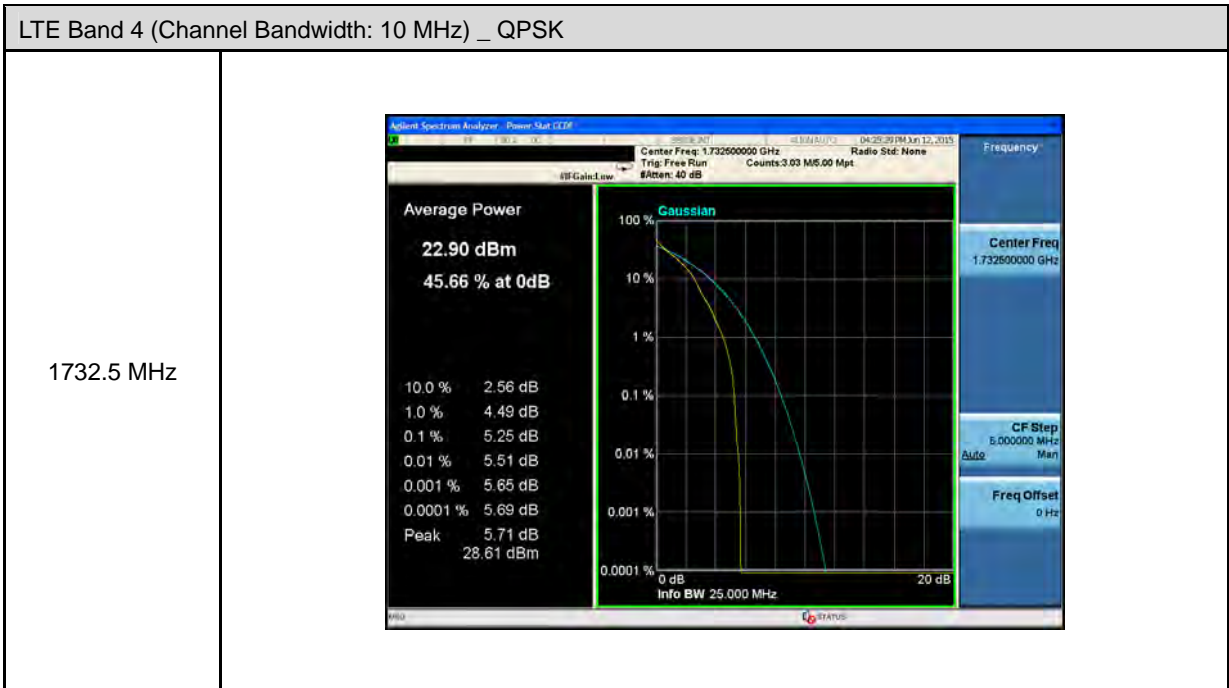
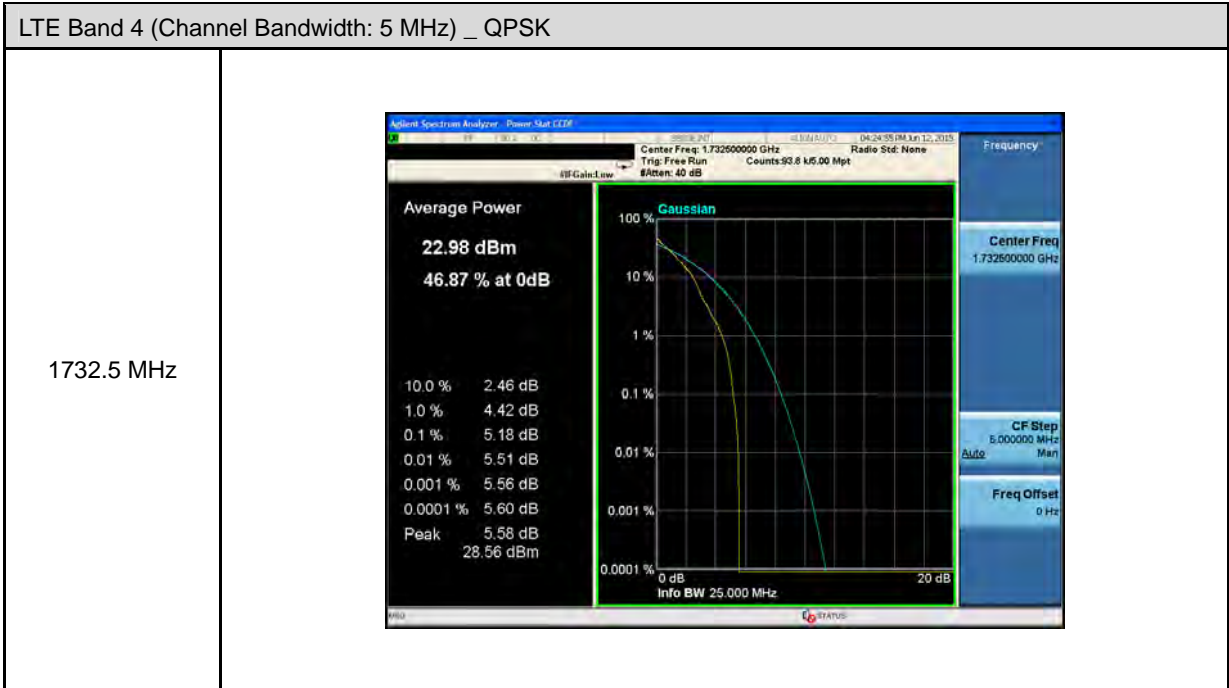

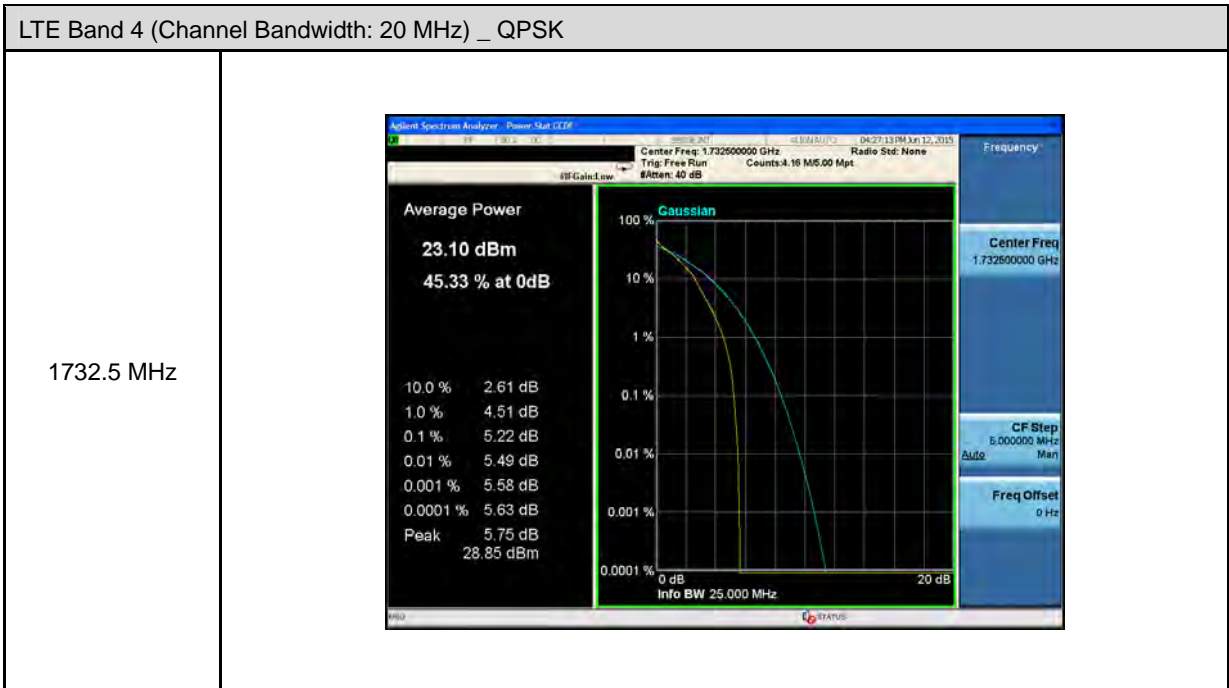
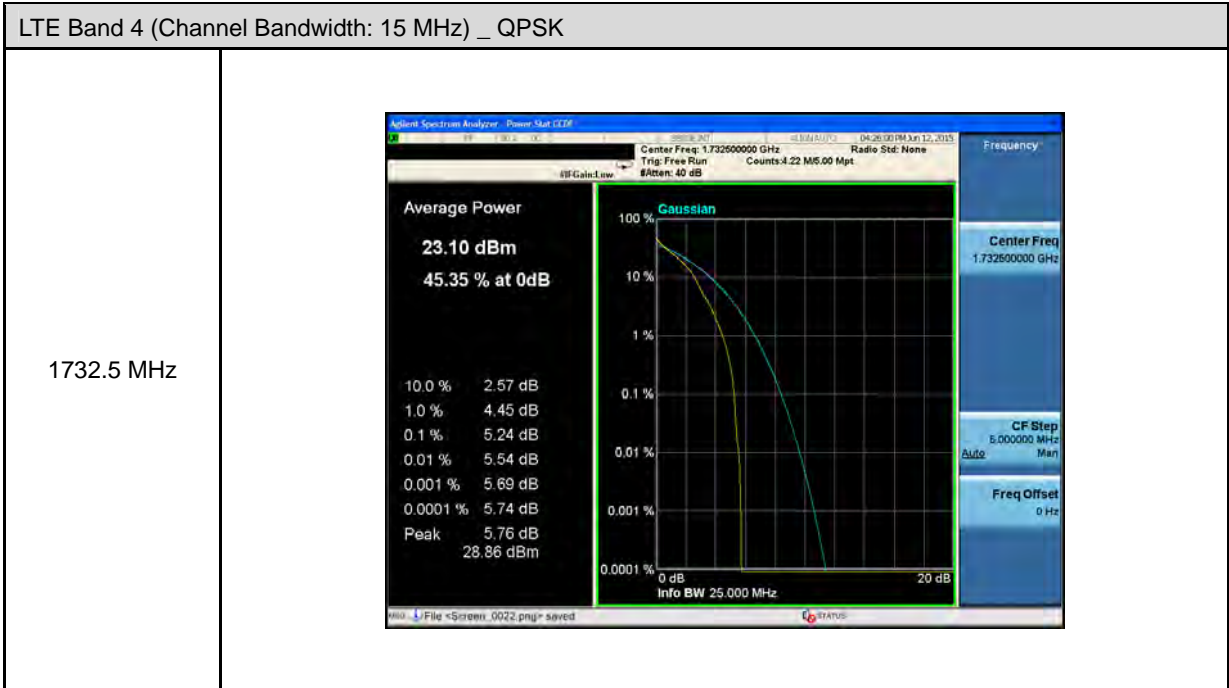

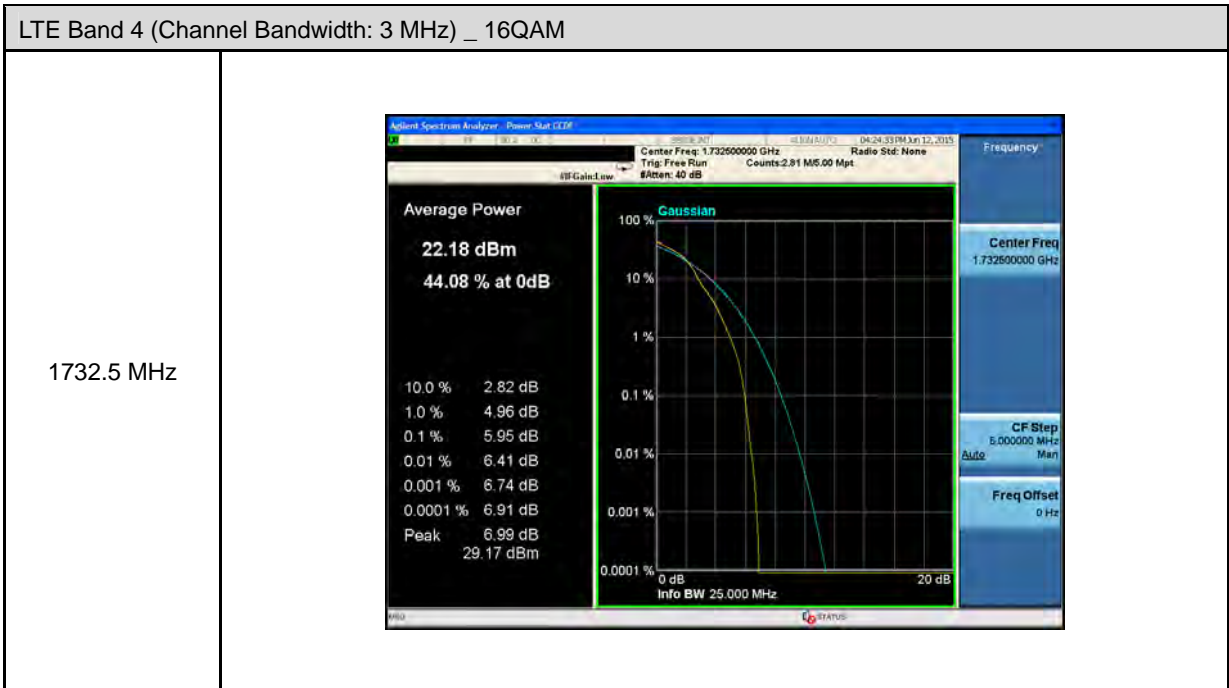
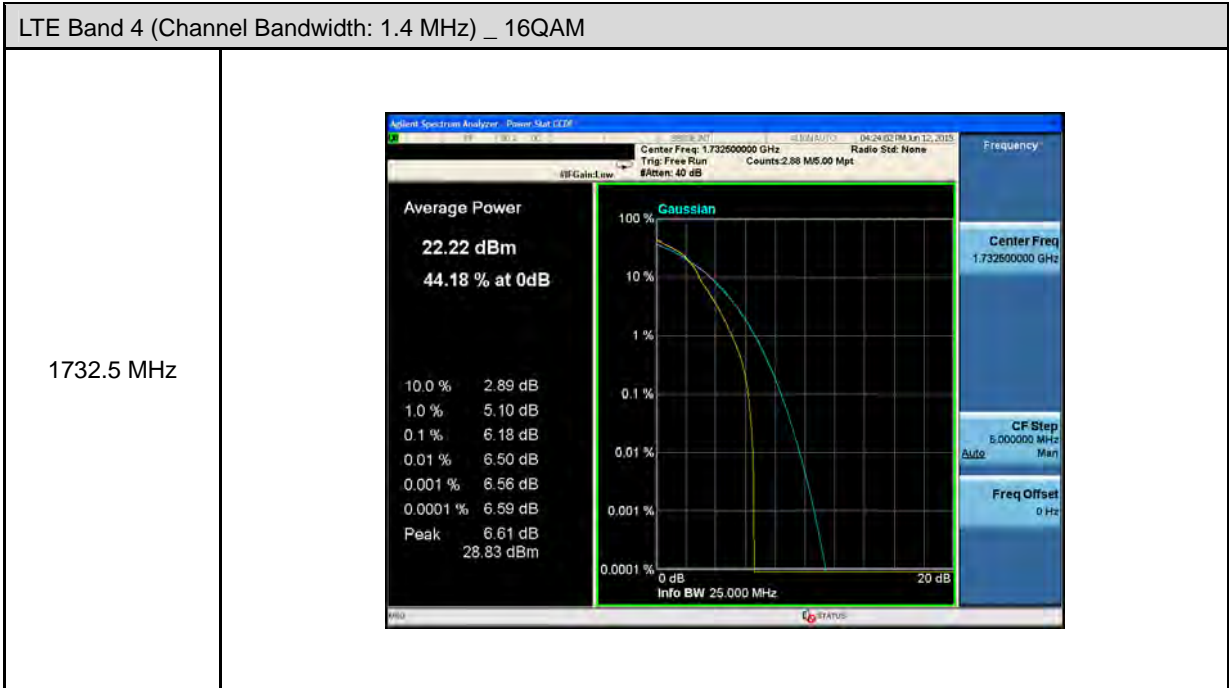

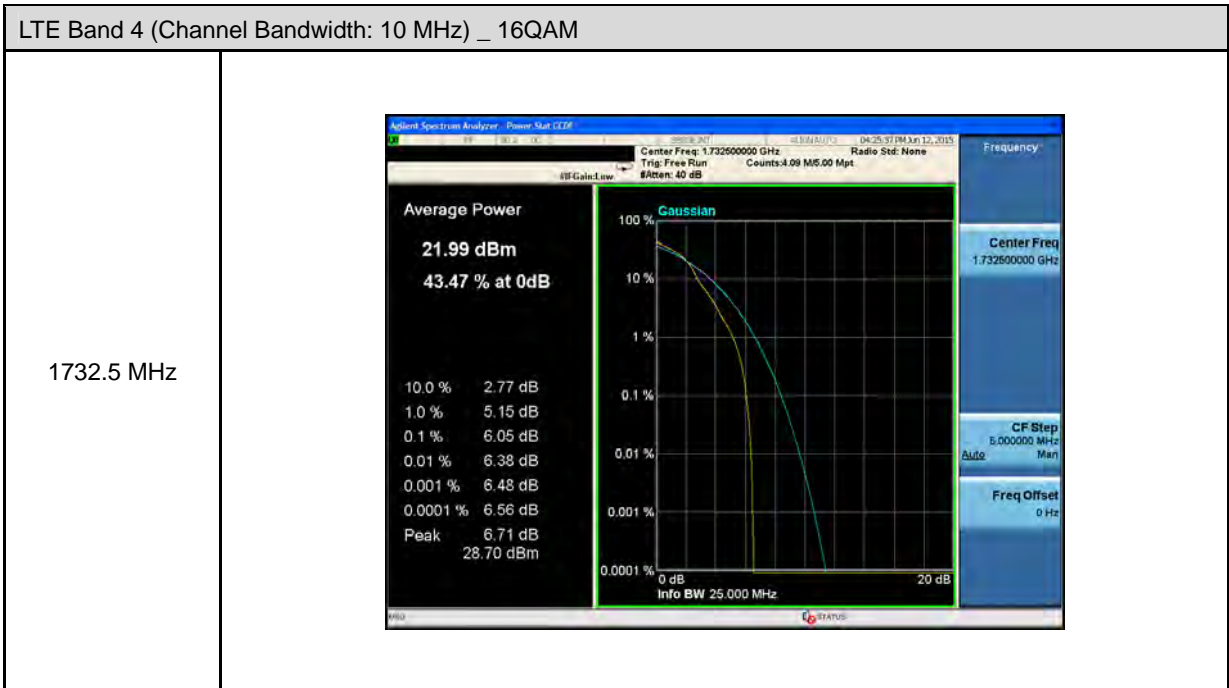
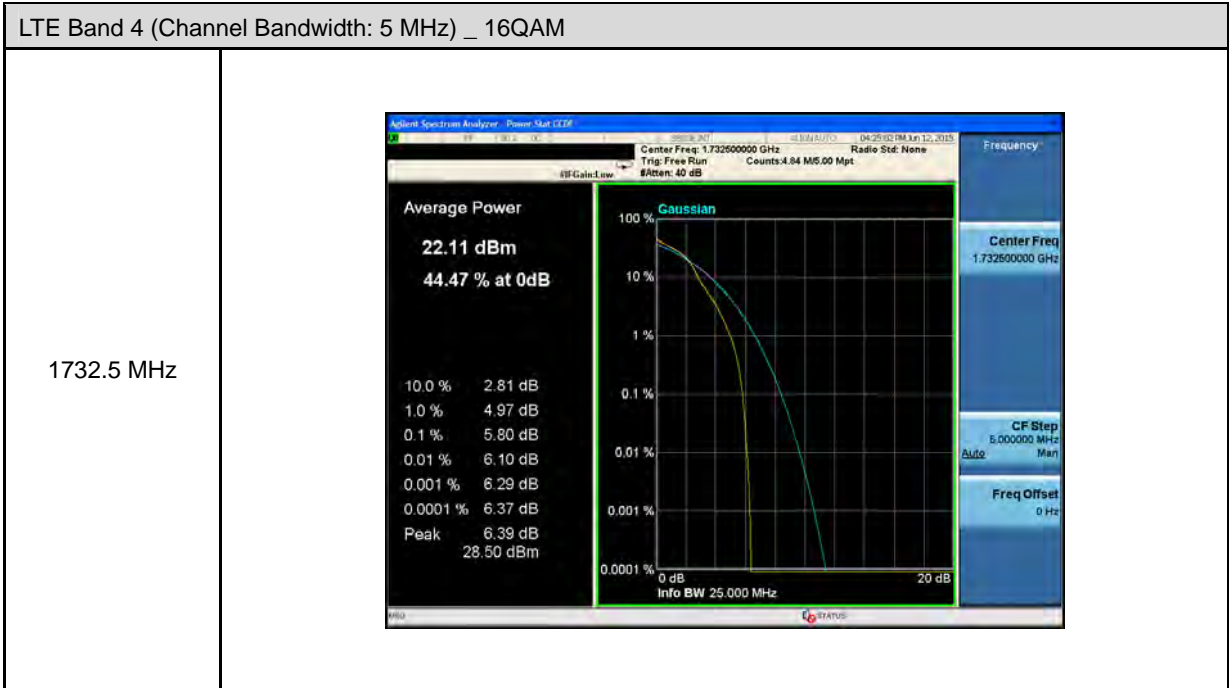

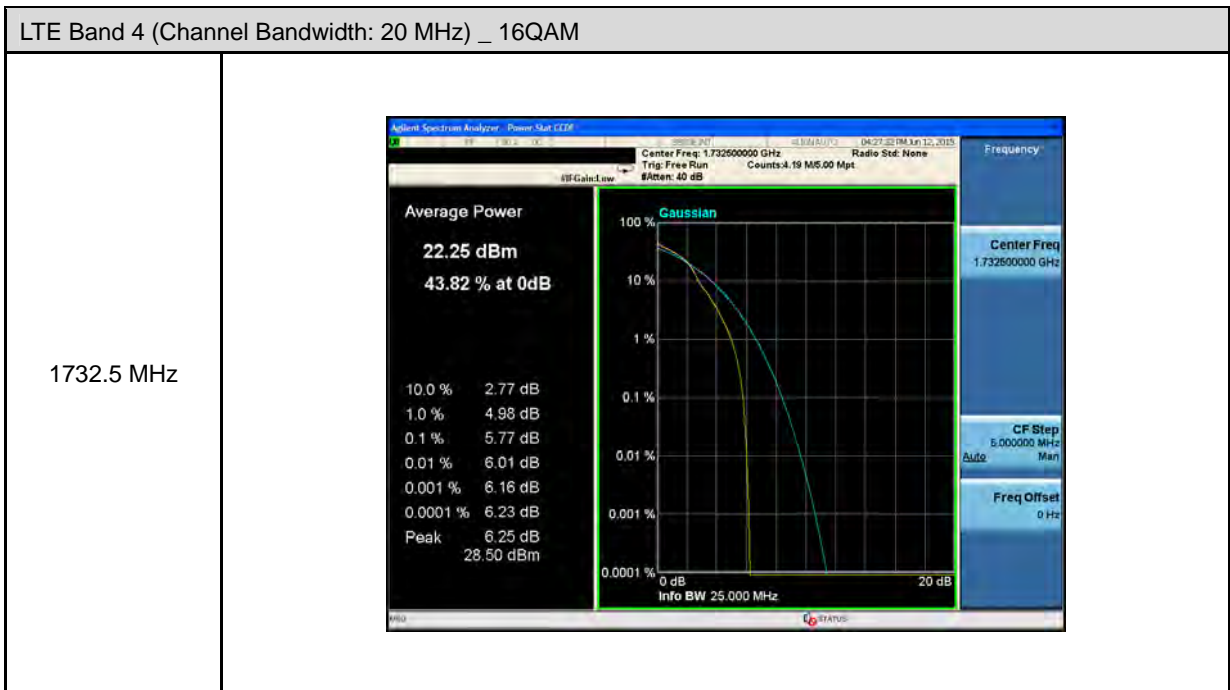
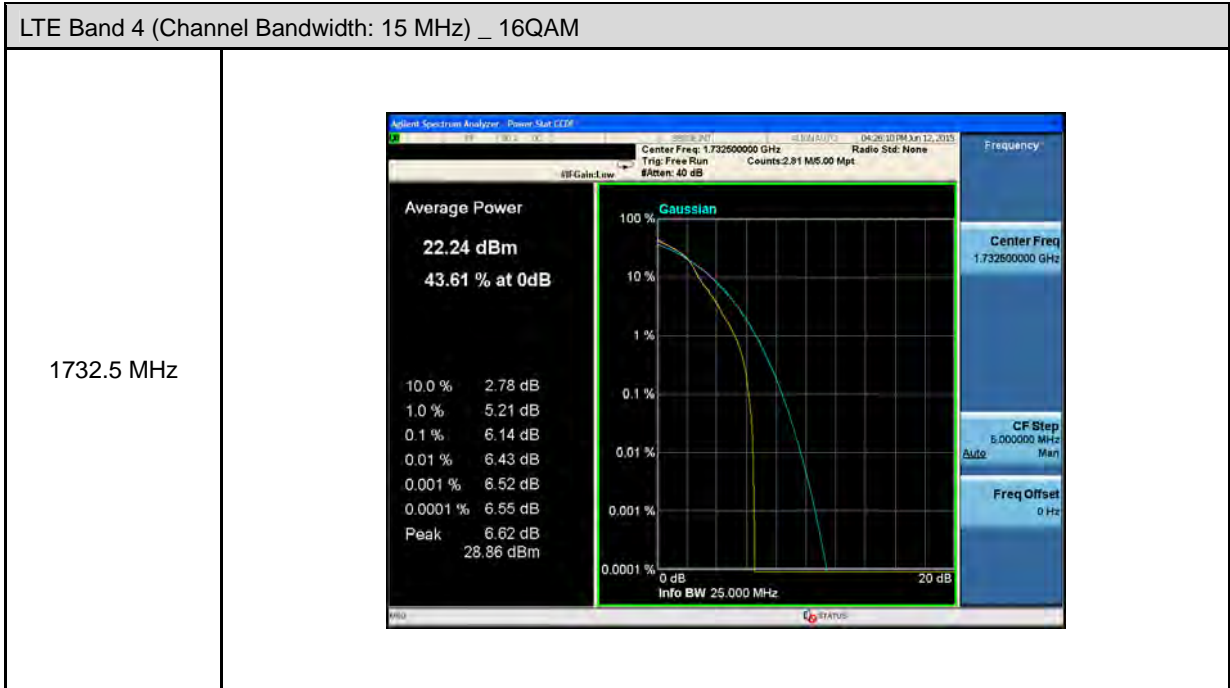

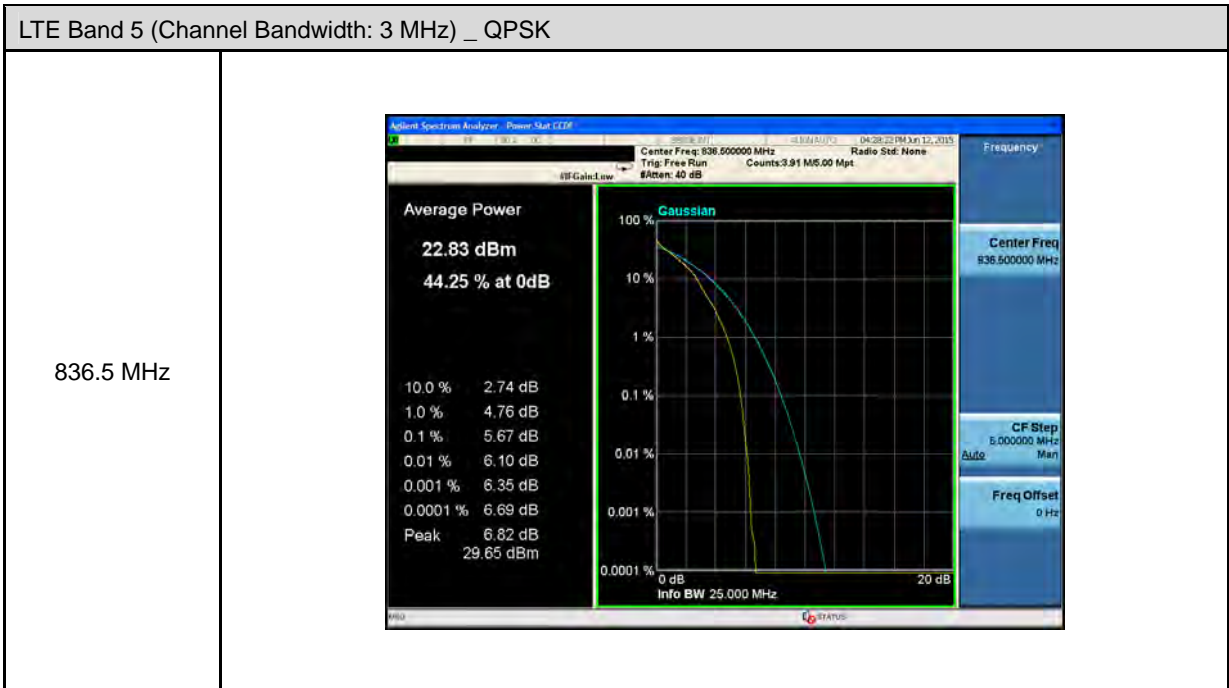
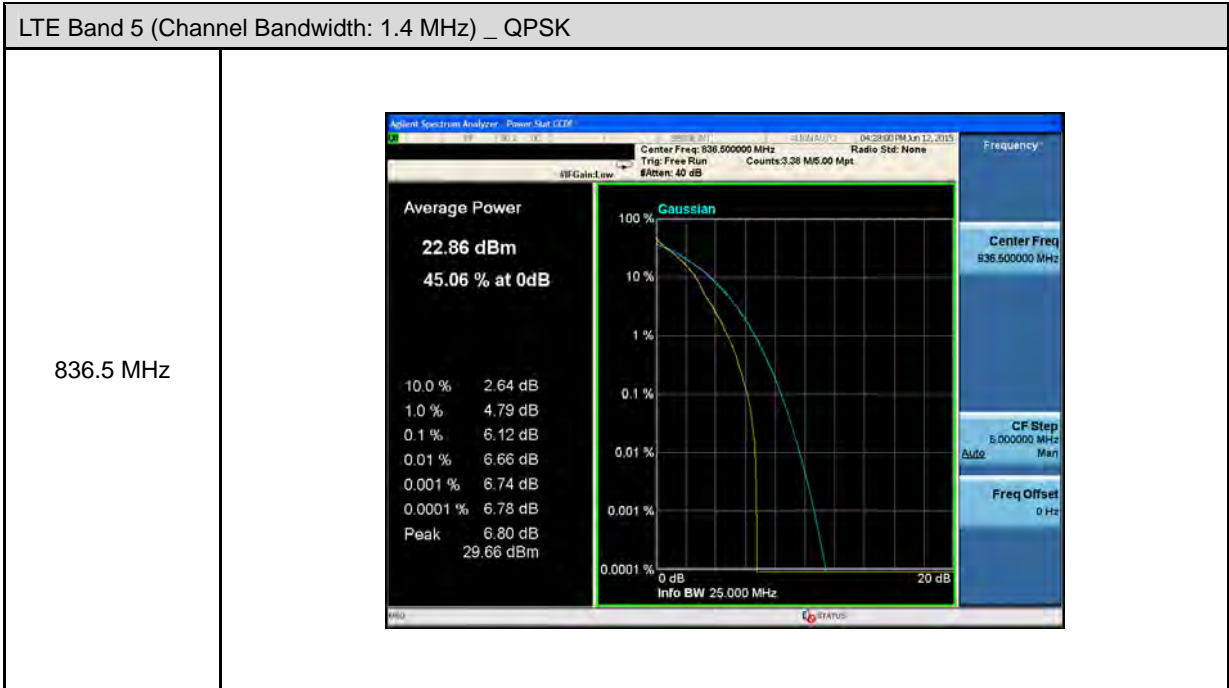

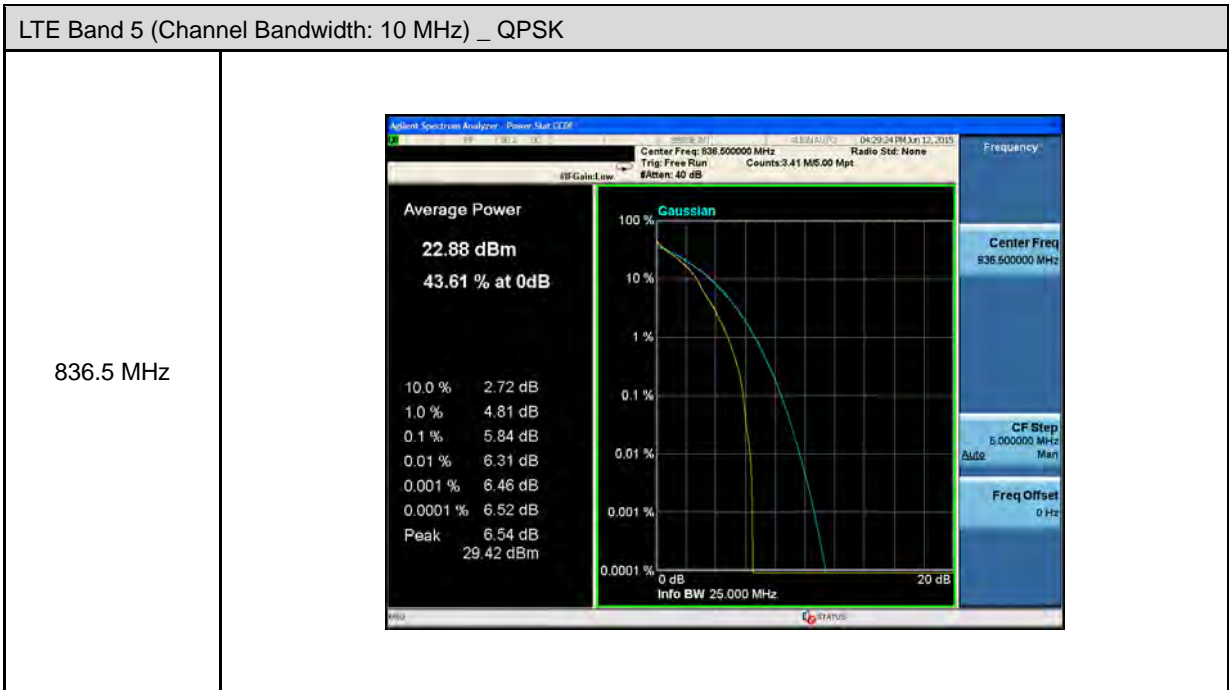
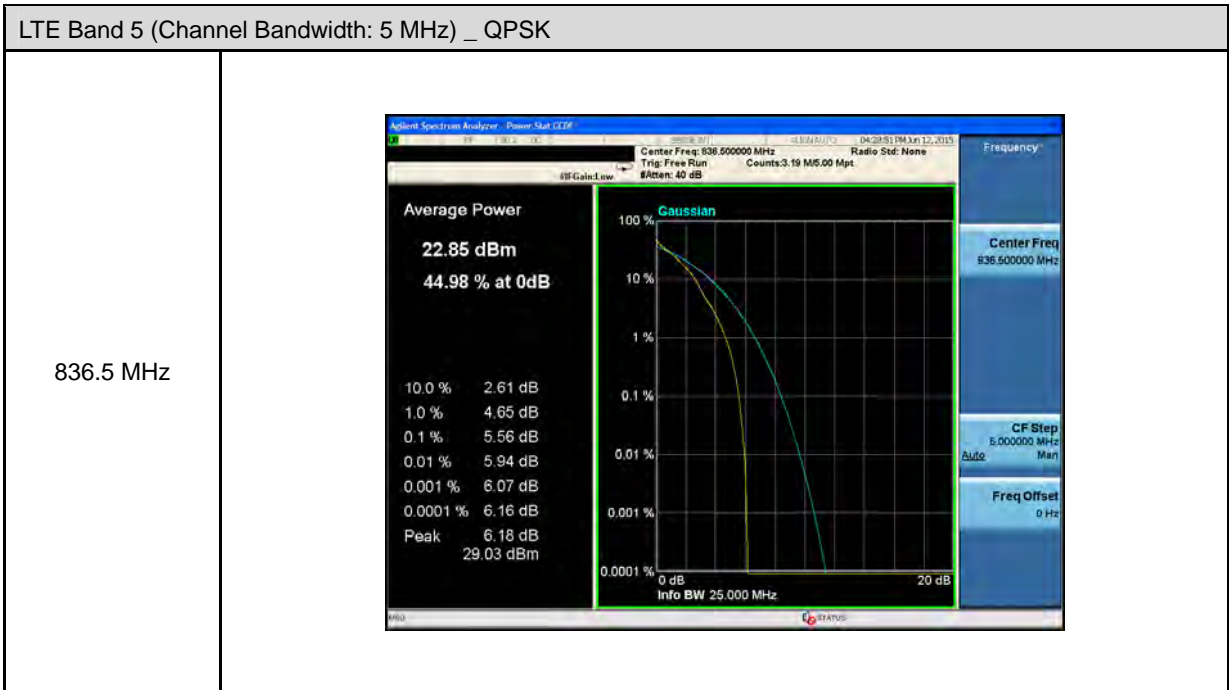

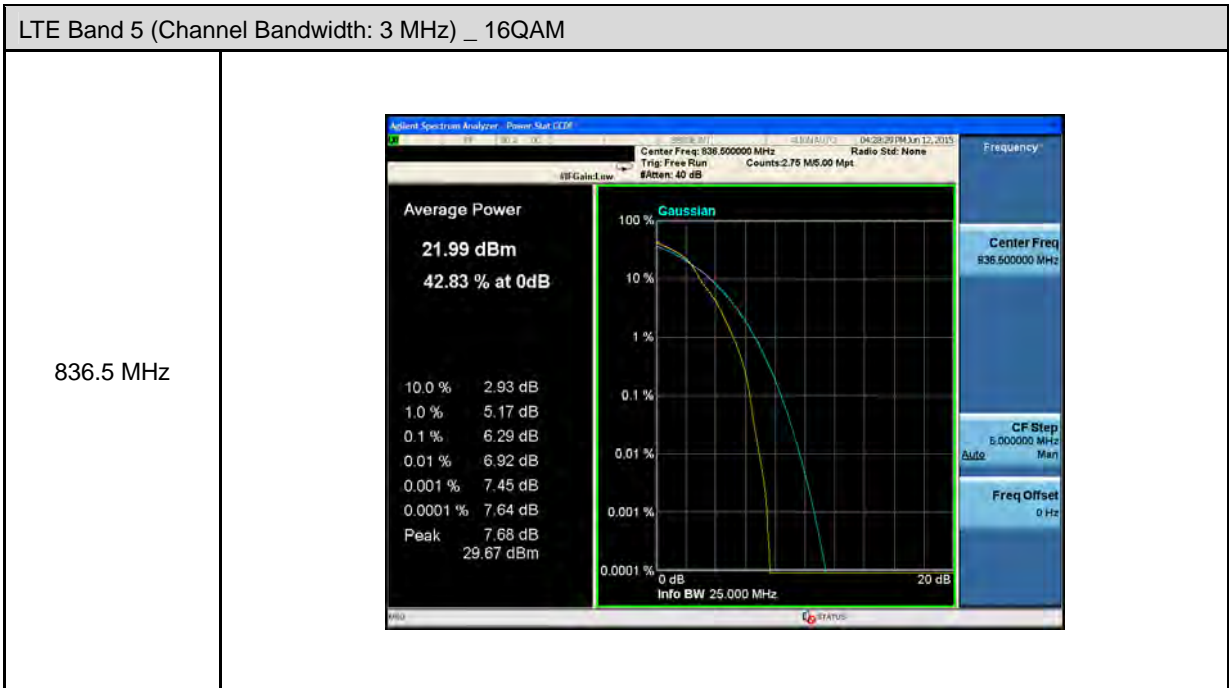
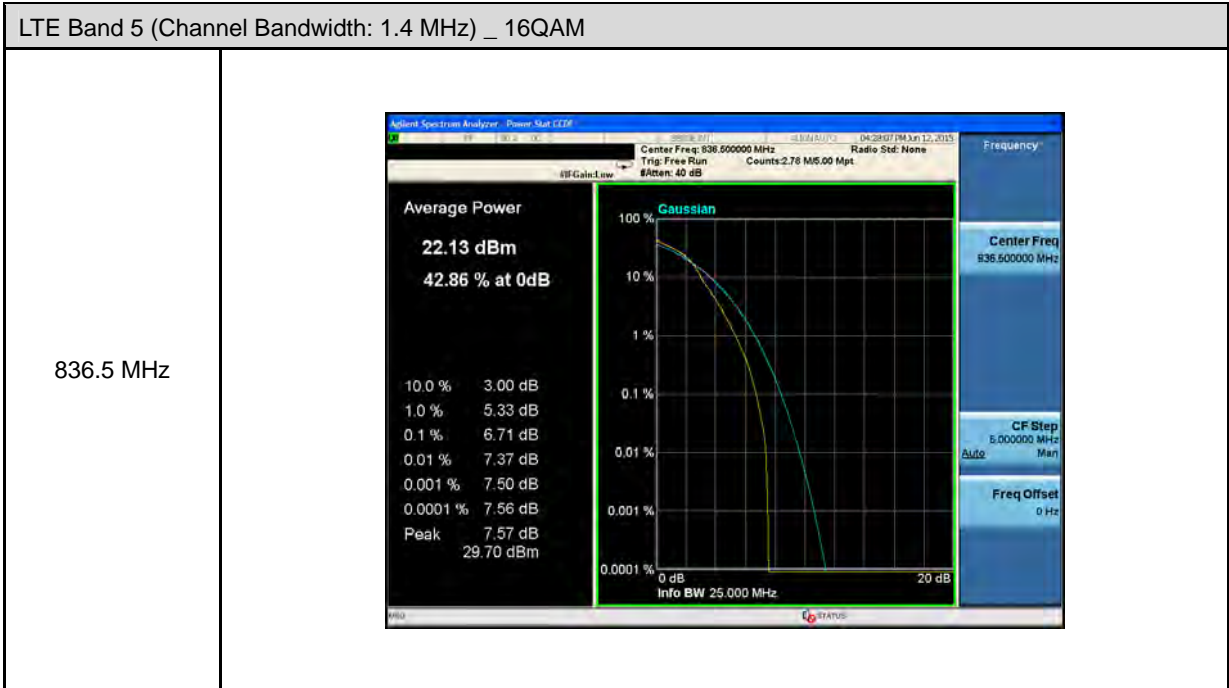

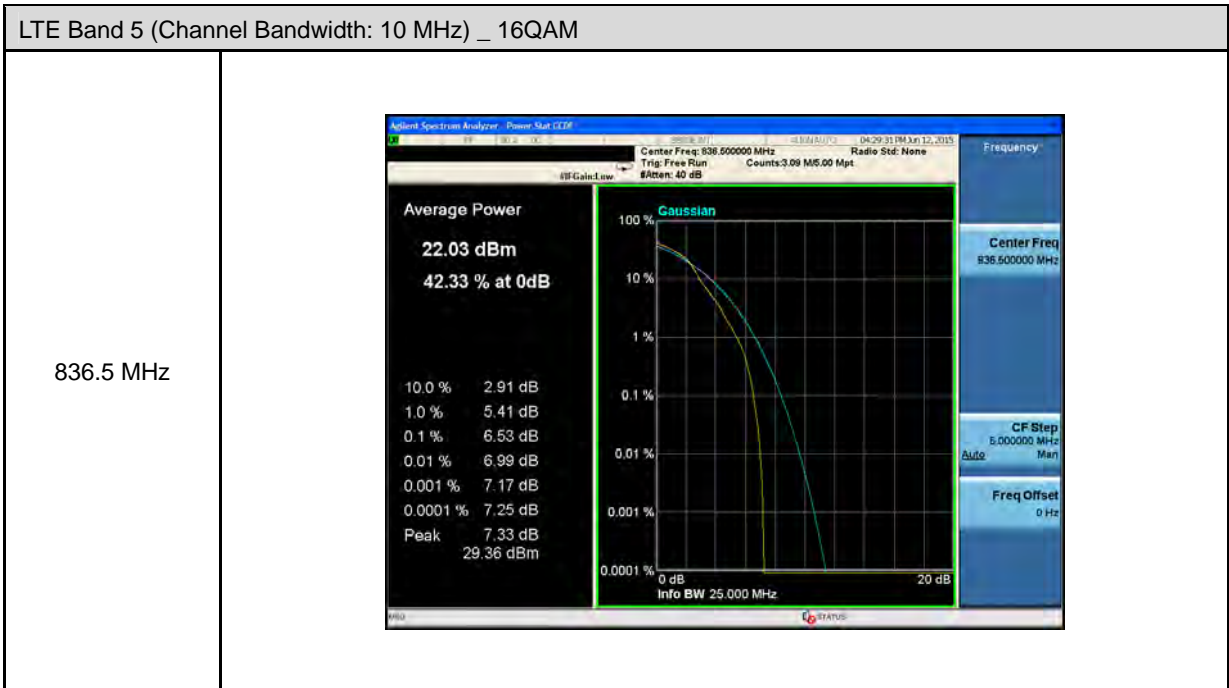
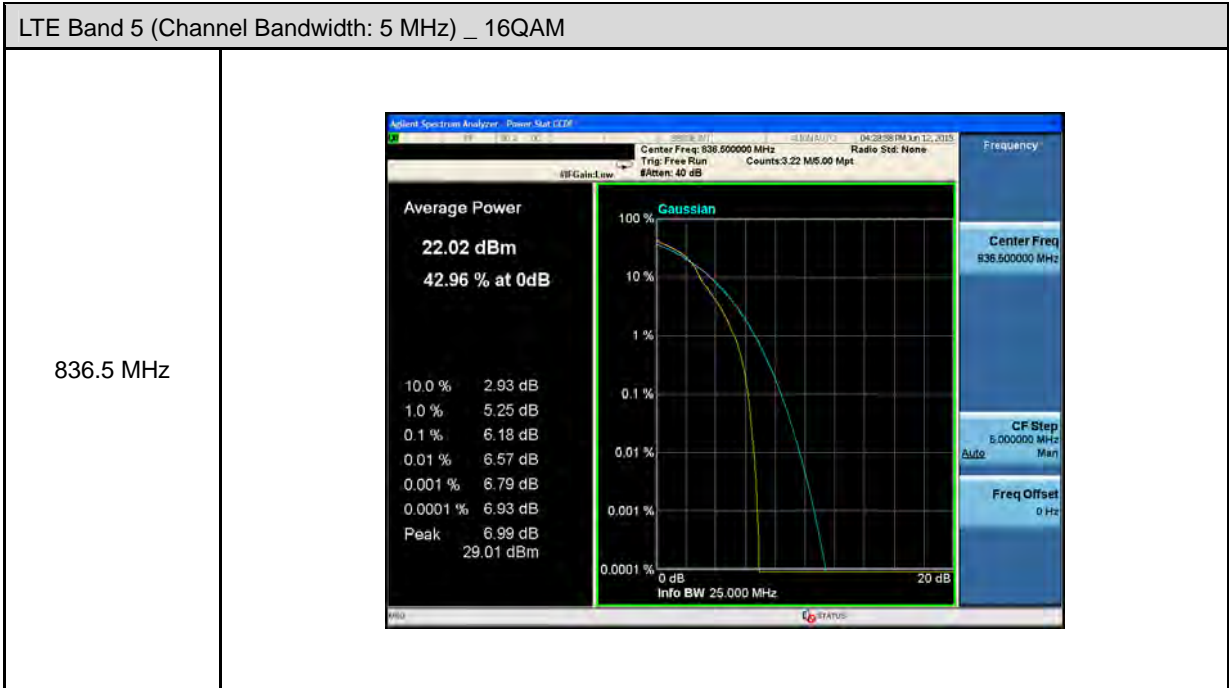

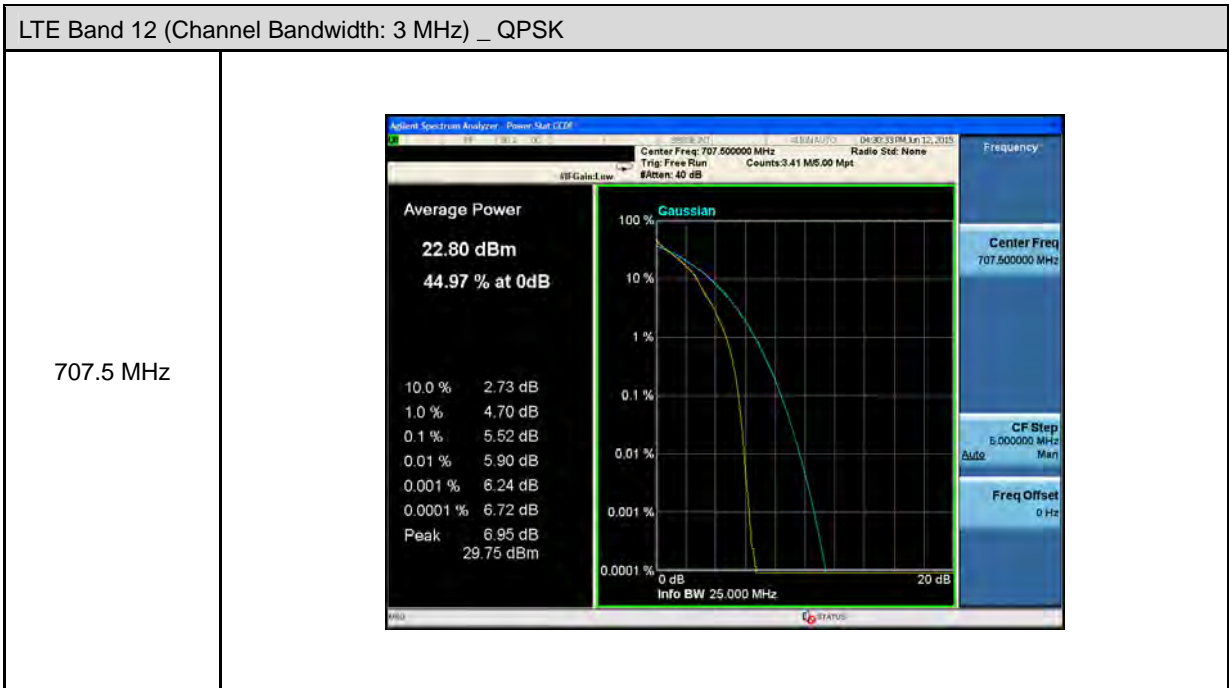
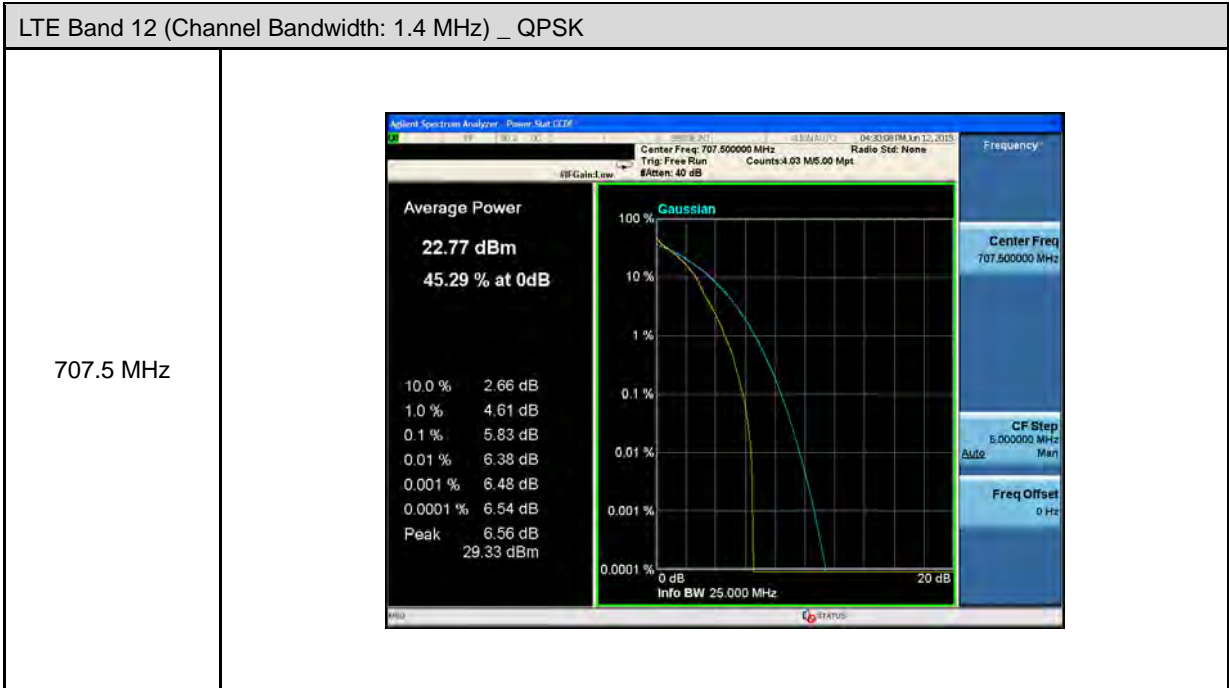

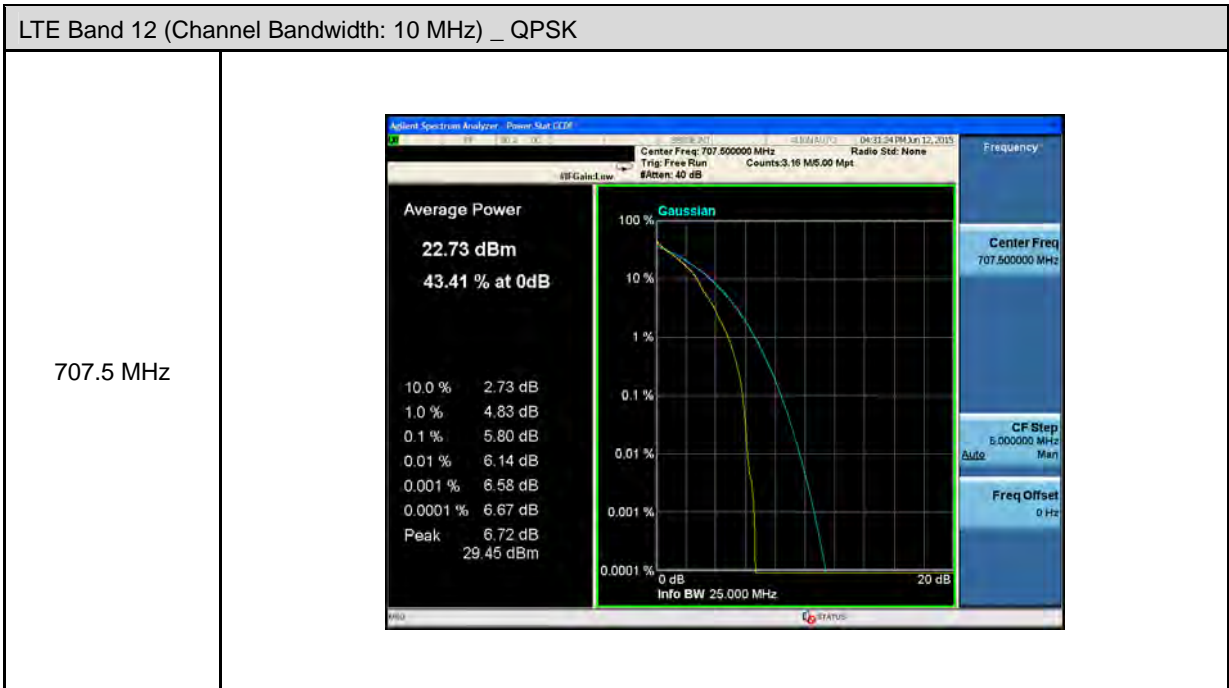
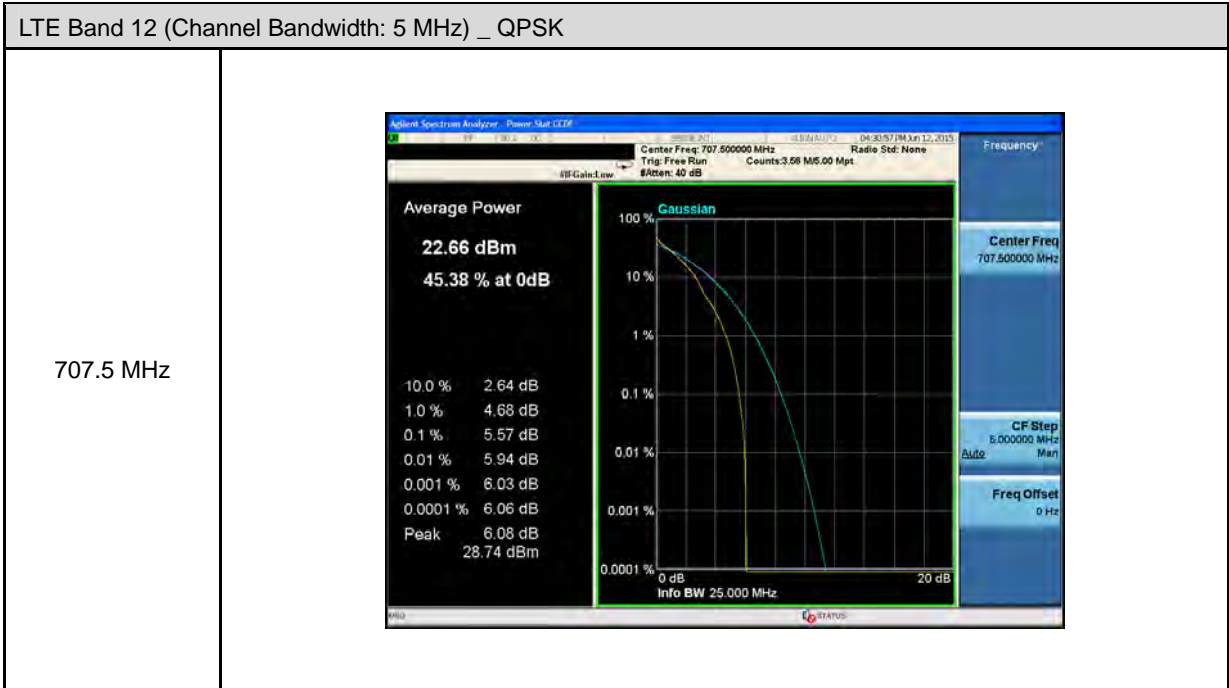

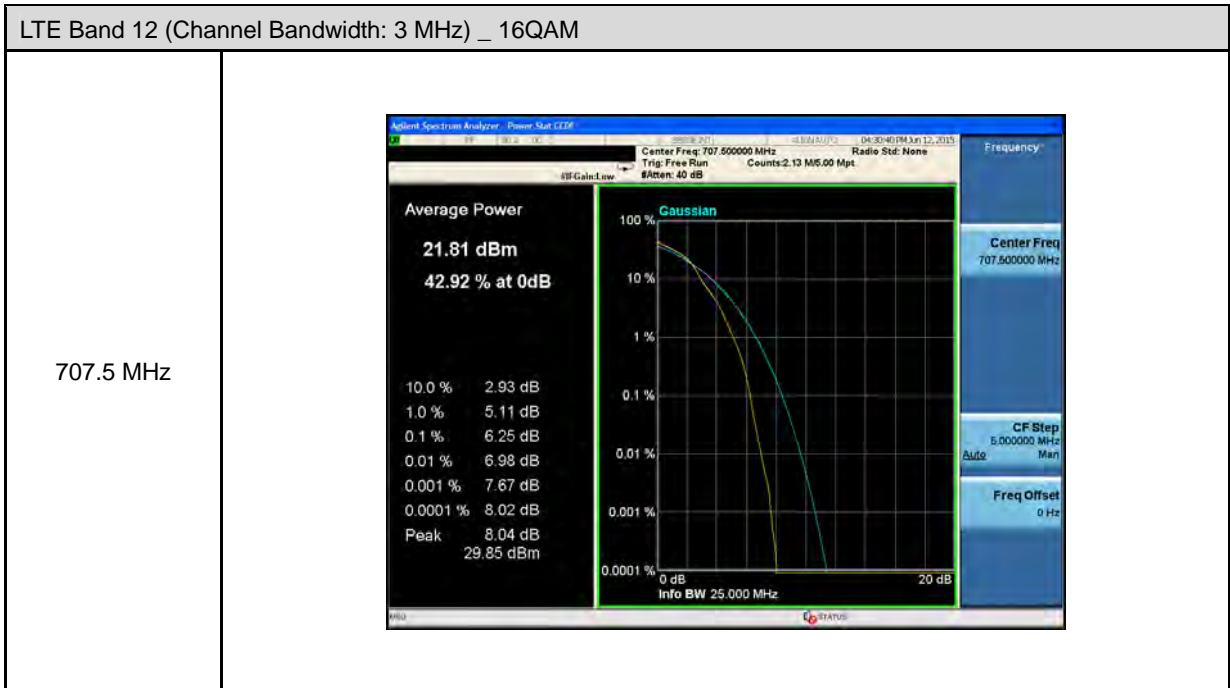
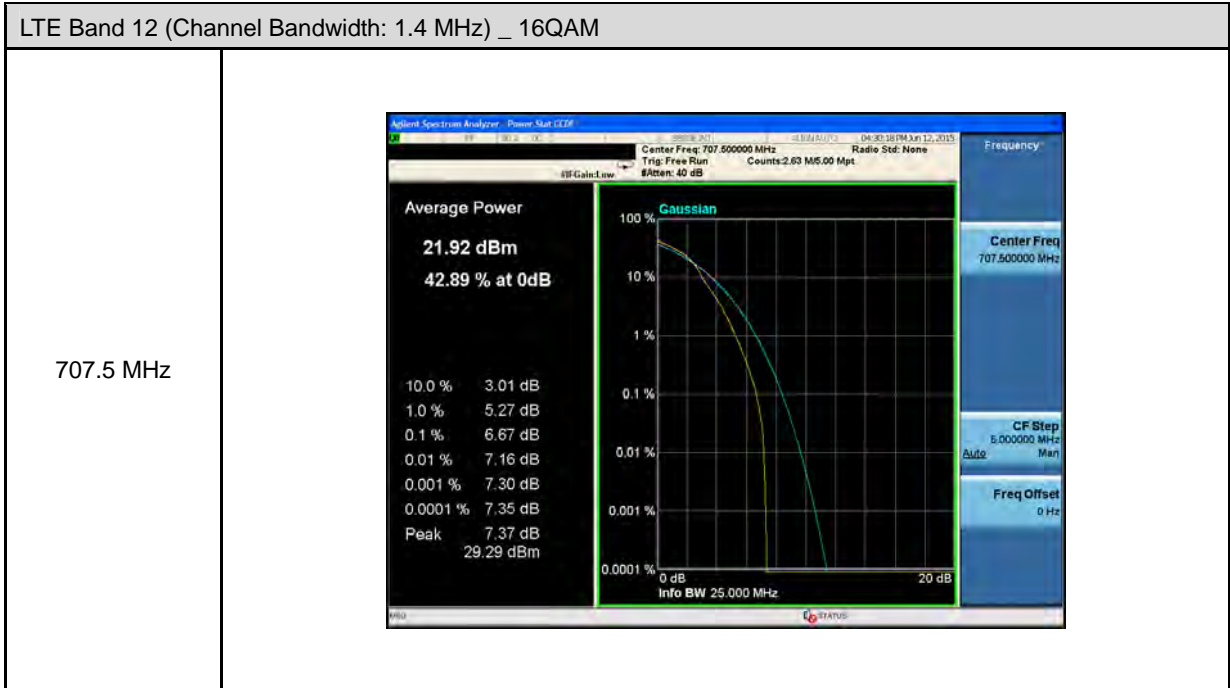

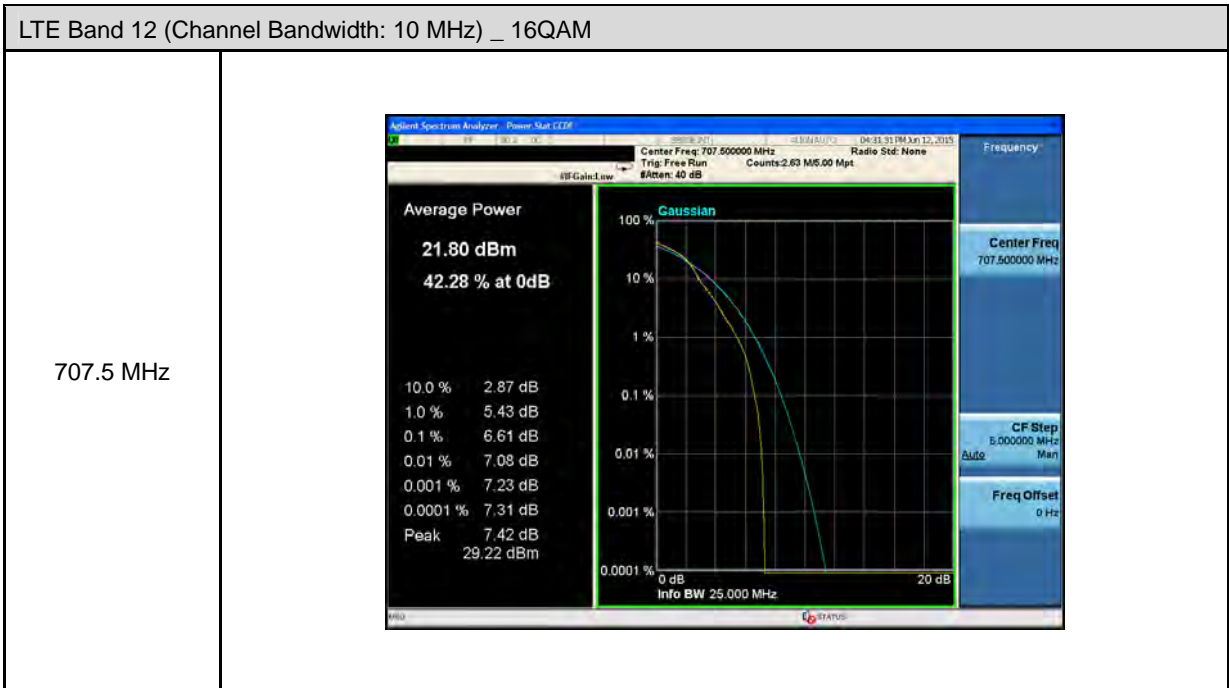
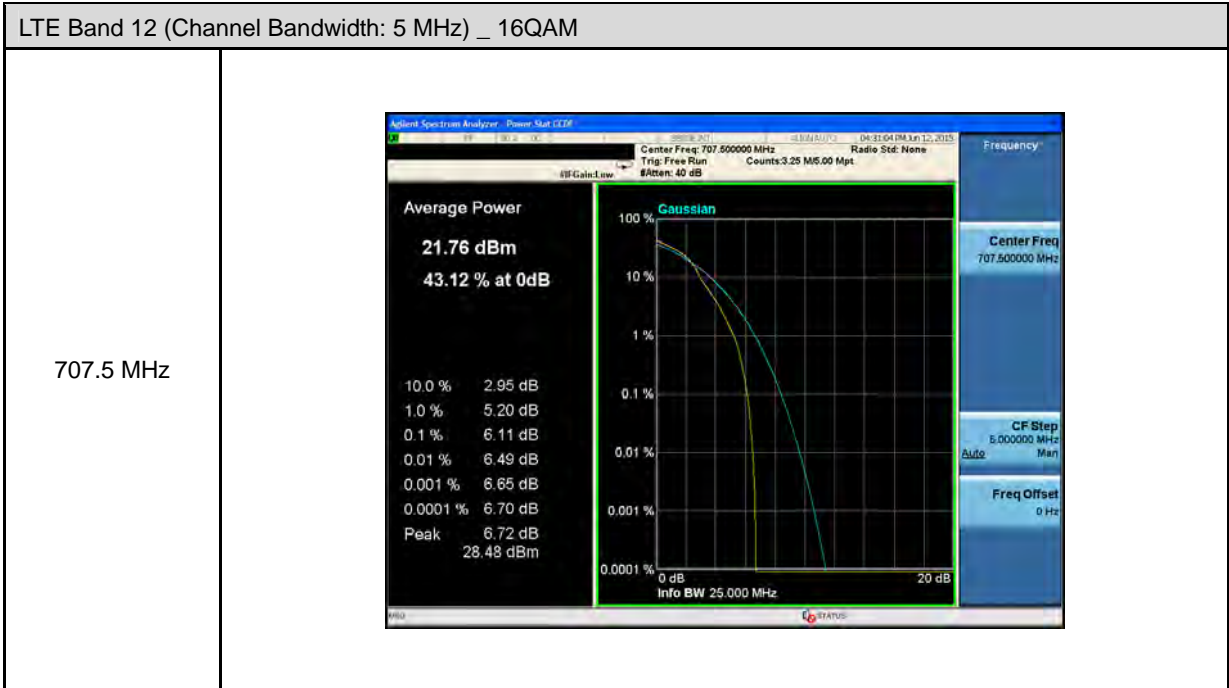

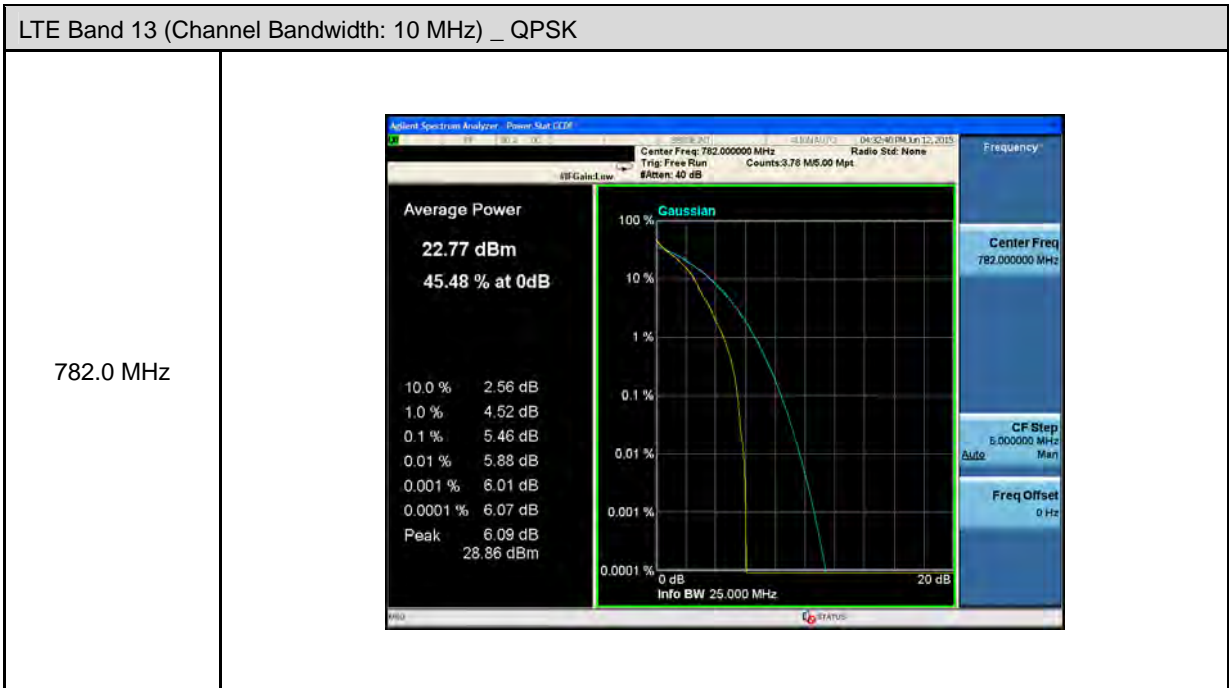
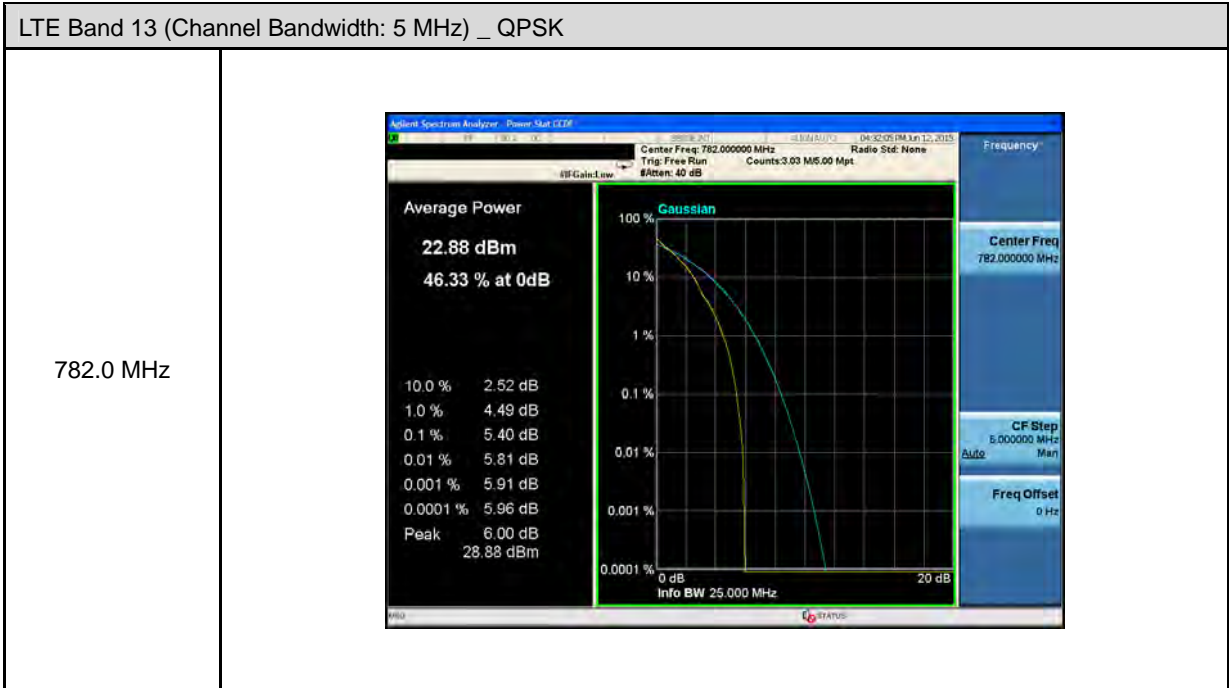

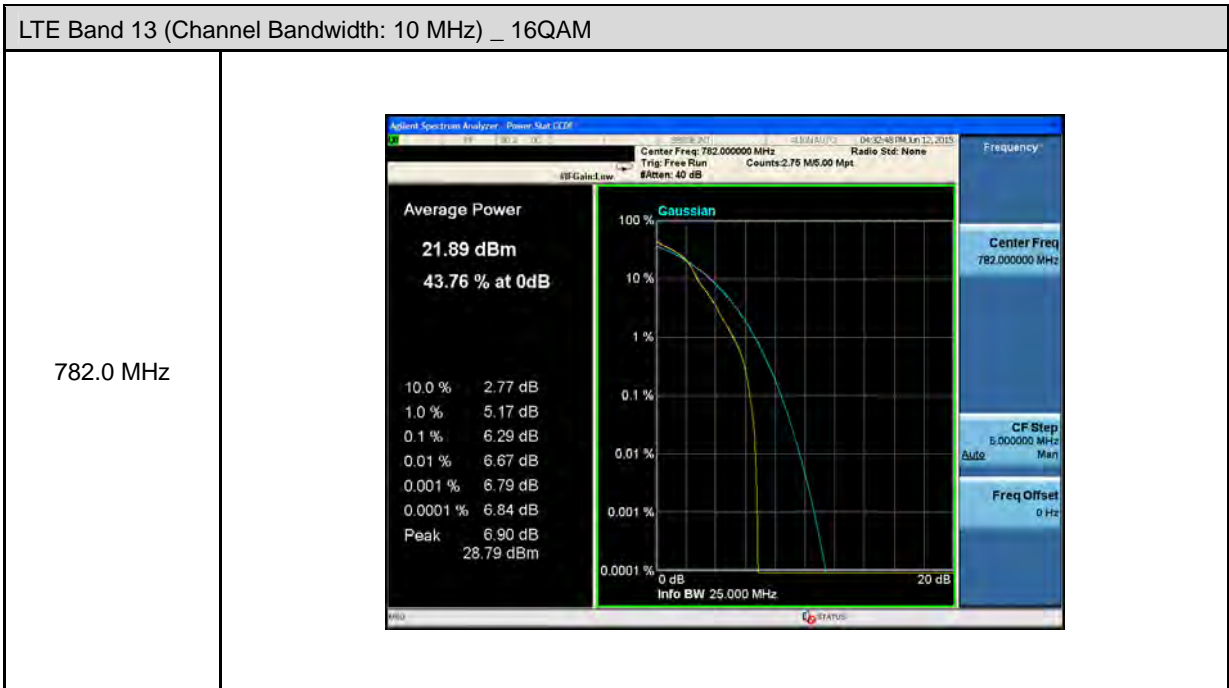
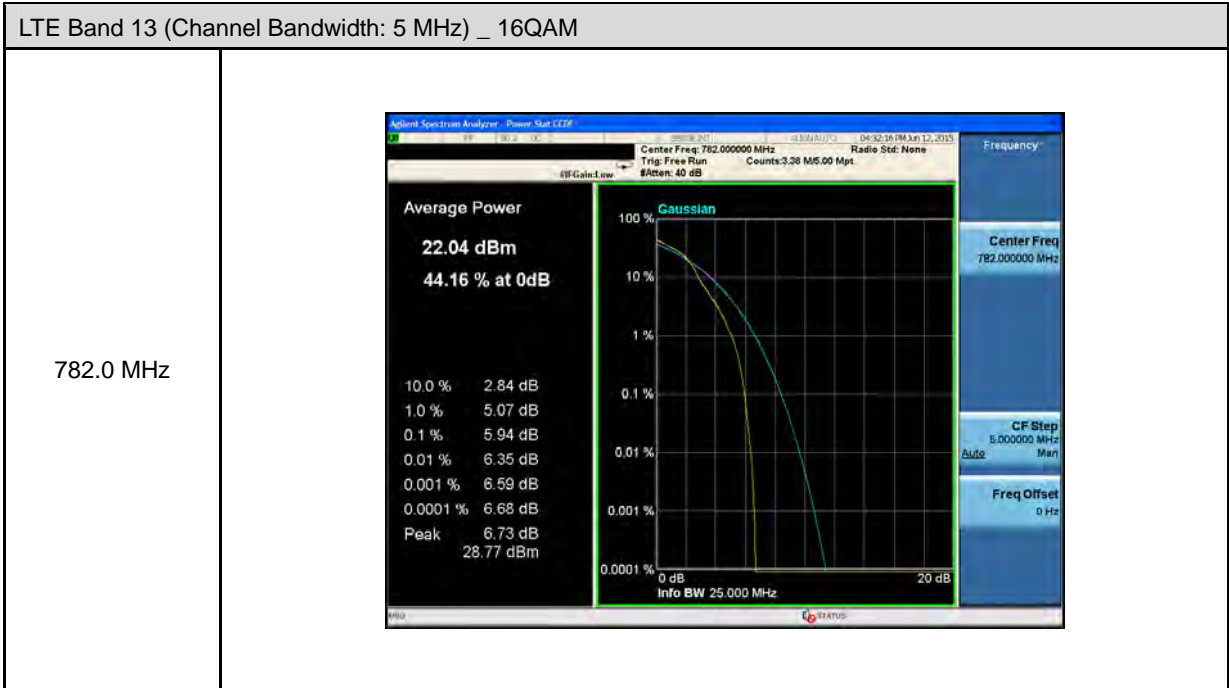

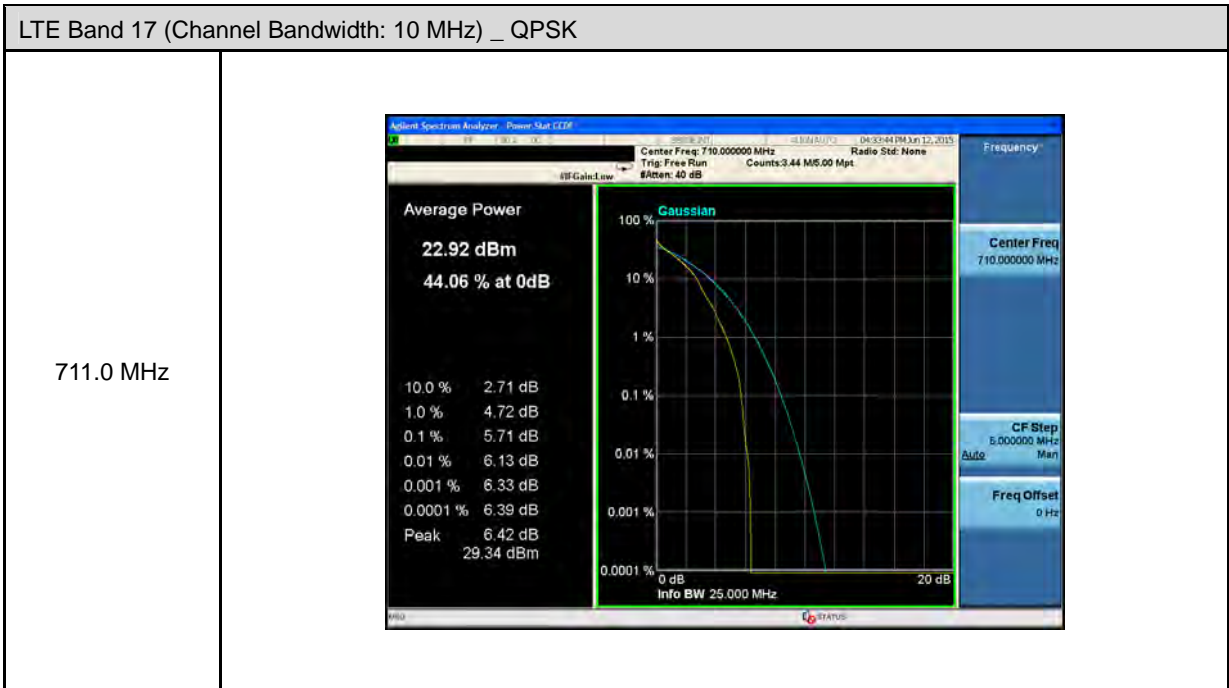
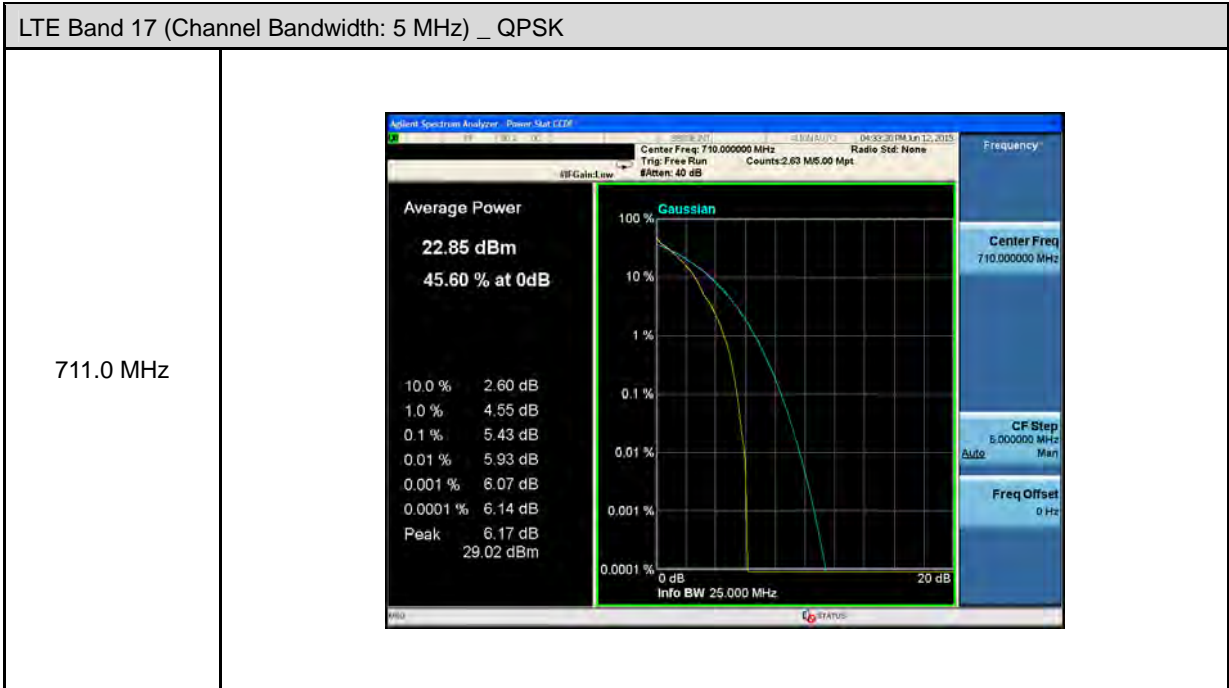

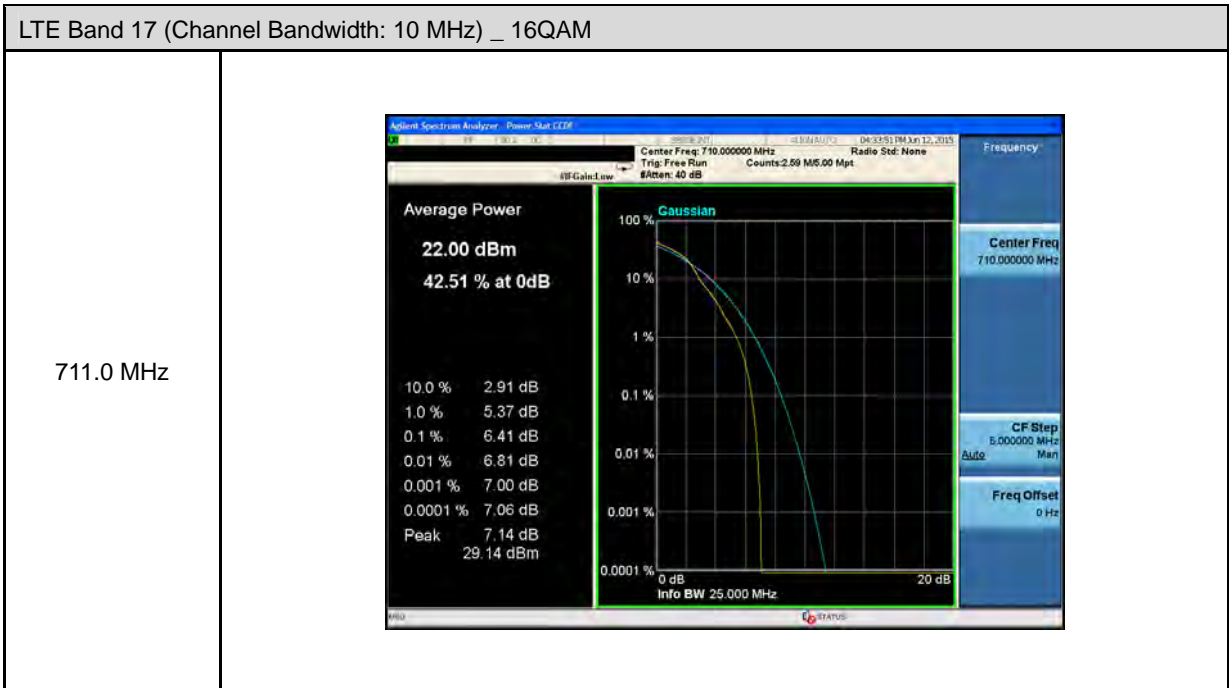
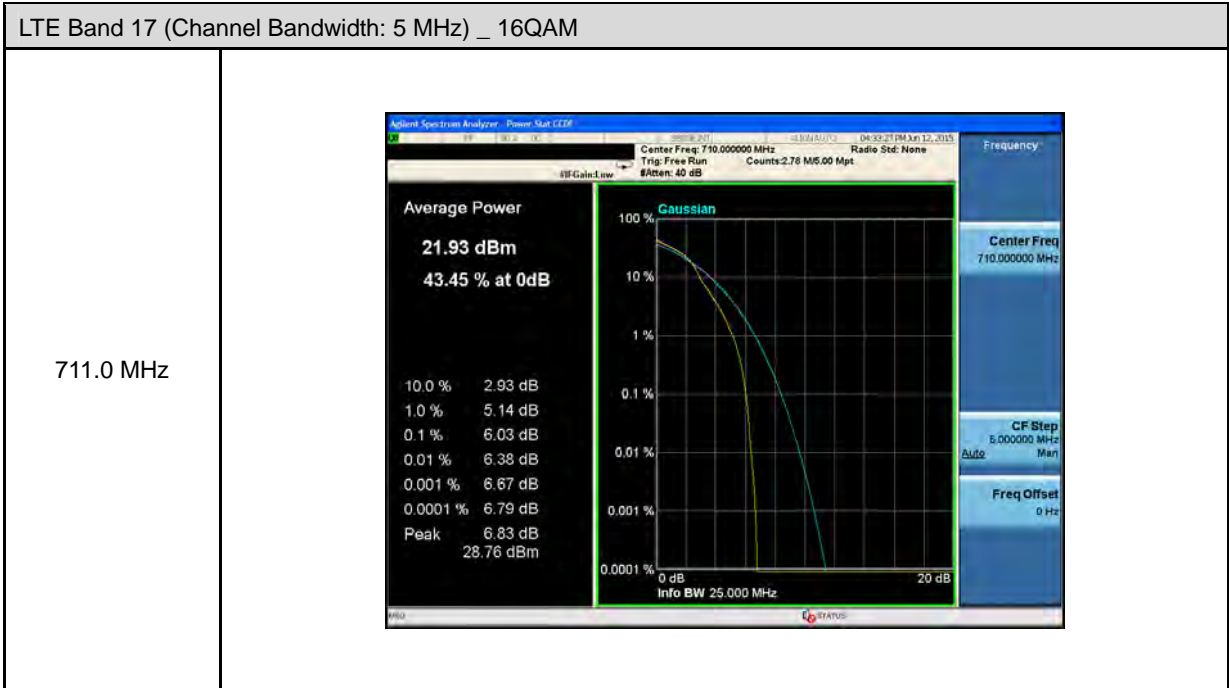

7 Band Edge Test

7.1. Limit

The Band Edge Limit:

§22.917(a), §24.238(a)

The power of any emission outside of the authorized operating frequency ranges must be attenuated below the transmitting power (P) by a factor of at least $43 + 10\log(P)$ dB.

§27.53(c)(2)

On any frequency outside the 777-787 MHz band, the power of any emission shall be attenuated outside the band below the transmitter power (P) by at least $43 + 10 \log (P)$ dB.

§27.53(c)(4)

On all frequencies between 763-775 MHz and 793-805 MHz, by a factor not less than $65 + 10 \log (P)$ dB in a 6.25 kHz band segment, for mobile and portable stations.

§27.53(g)

The power of any emission outside a licensee's frequency block shall be attenuated below the transmitter power (P) in watts by at least $43 + 10 \log_{10} (P)$ dB.

LTE Band 13_BW=5M				
Frequency (MHz)	RBW=10kHz Measurement (dBm)	RBW=6.25kHz Measurement (dBm)	Limit -35dBm/6.25kHz	Result
763 ~ 775	-51.728	-53.769	-35	PASS
793 ~ 805	-62.278	-64.319	-35	PASS

LTE Band 13_BW=10M				
Frequency (MHz)	RBW=10kHz Measurement (dBm)	RBW=6.25kHz Measurement (dBm)	Limit -35dBm/6.25kHz	Result
763 ~775	-48.597	-50.638	-35	PASS
793 ~805	-51.799	-53.840	-35	PASS

7.2. Test Instruments

Equipment	Manufacturer	Model No.	Serial No.	Cal. Date	Remark
Spectrum Analyzer	Agilent	E4445A	MY46181986	05/14/2015	(1)
Wideband Radio Communication Test	R & S	CMW500	103168	11/05/2014	(1)
Attenuator	RADIALL	R41572000	0603033073	N.C.R.	-----
Power divider	Agilent	87302C	3239A00760	N.C.R.	-----
Test Site	ATL	TE05	TE05	N.C.R.	-----

Remark: ⁽¹⁾ Calibration period 1 year. ⁽²⁾ Calibration period 2 years.

Note: N.C.R. = No Calibration Request.

7.3. Setup

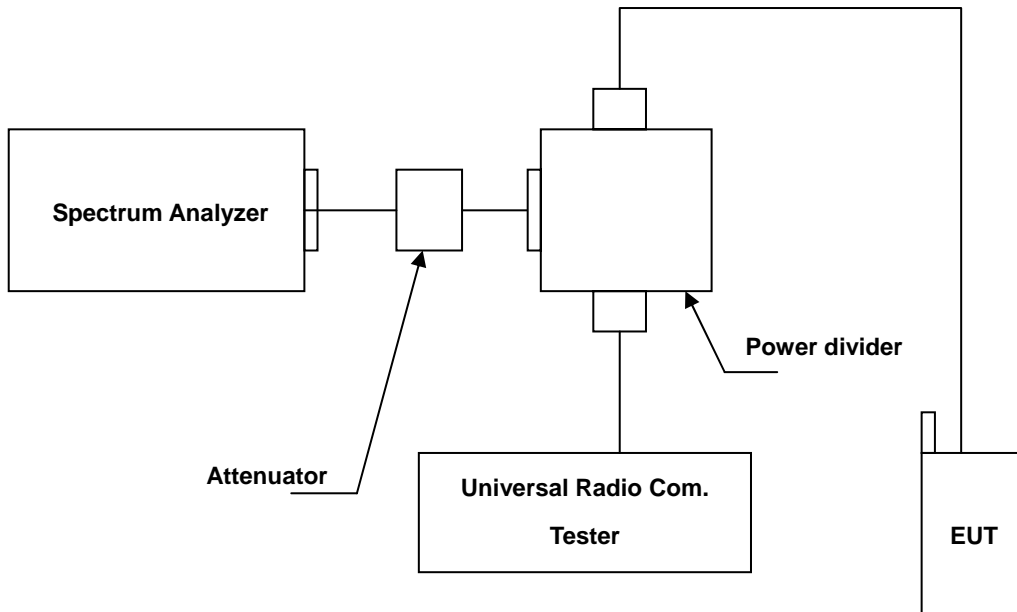

7.4. Test Procedure

The measurement is made according to FCC rules:

- a. The EUT was set up for the maximum peak power with LTE/WCDMA link data modulation. The power was measured with Spectrum Analyzer. All measurements were done at 2 channels (low and high operational frequency range.)
- b. The band edge measurement used the power splitter via EUT RF power connector between simulation base station and spectrum analyzer. This splitter loss and cable loss are the worst loss in the transmitted path track.
- c. The center frequency of spectrum is the band edge frequency and span is 10 MHz. RB of the resolution bandwidth of at least one percent of the emission bandwidth.
- d. Record the max trace plot into the test report.

7.5. Uncertainty

The measurement uncertainty is defined as for Conducted Power measurement is 1.2 dB.

7.6. Test Result

Frequency	LTE Band 2	Channel Bandwidth	1.4 MHz	RB Allocated	6
Lower Band Edge					
Higher Band Edge					

Frequency	LTE Band 2	Channel Bandwidth	3 MHz	RB Allocated	15
Lower Band Edge					
Higher Band Edge					

Frequency	LTE Band 2	Channel Bandwidth	5 MHz	RB Allocated	25
Lower Band Edge					
Higher Band Edge					

Frequency	LTE Band 2	Channel Bandwidth	10 MHz	RB Allocated	50
Lower Band Edge					
Higher Band Edge					

Frequency	LTE Band 2	Channel Bandwidth	15 MHz	RB Allocated	75
Lower Band Edge					
Higher Band Edge					

Frequency	LTE Band 2	Channel Bandwidth	20 MHz	RB Allocated	100
Lower Band Edge					
Higher Band Edge					

Frequency	LTE Band 4	Channel Bandwidth	1.4 MHz	RB Allocated	6
Lower Band Edge					
Higher Band Edge					

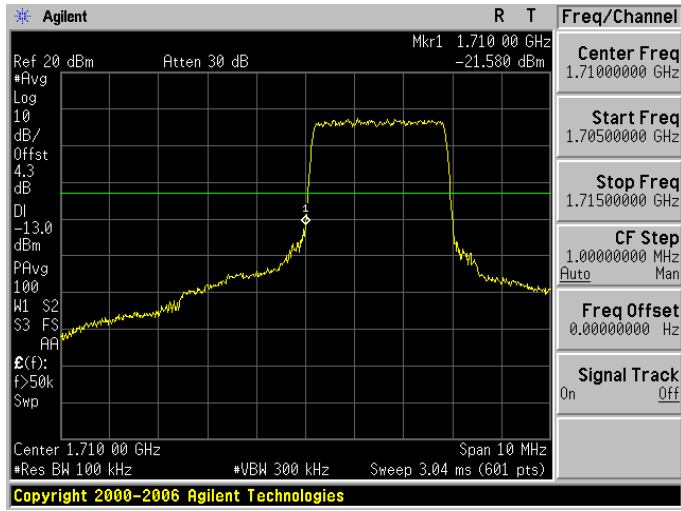
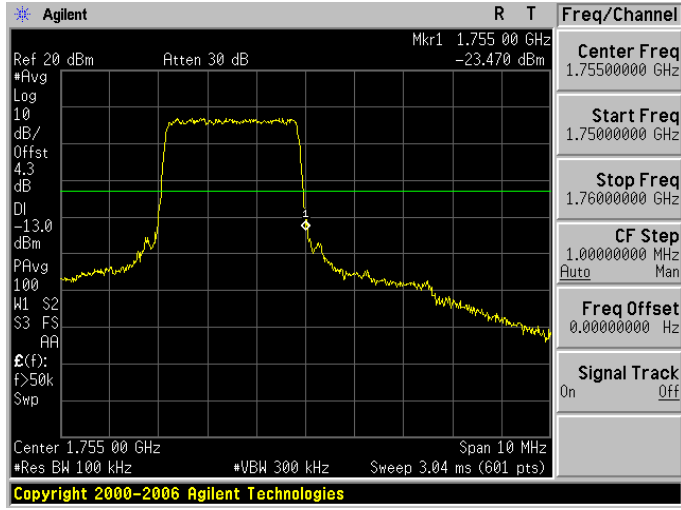
Frequency	LTE Band 4	Channel Bandwidth	3 MHz	RB Allocated	15
Lower Band Edge					
Higher Band Edge					

Frequency	LTE Band 4	Channel Bandwidth	5 MHz	RB Allocated	25
Lower Band Edge	<p>Agilent Spectrum Analyzer Screenshot: Lower Band Edge</p> <ul style="list-style-type: none"> Center Freq: 1.7100000 GHz Start Freq: 1.7050000 GHz Stop Freq: 1.7150000 GHz Mkr1: 1.710 00 GHz Level: -28.980 dBm Span: 10 MHz Res BW: 100 kHz VBW: 300 kHz Sweep: 3.04 ms (601 pts) 				
Higher Band Edge	<p>Agilent Spectrum Analyzer Screenshot: Higher Band Edge</p> <ul style="list-style-type: none"> Center Freq: 1.7550000 GHz Start Freq: 1.7500000 GHz Stop Freq: 1.7600000 GHz Mkr1: 1.755 00 GHz Level: -27.286 dBm Span: 10 MHz Res BW: 100 kHz VBW: 300 kHz Sweep: 3.04 ms (601 pts) 				

Frequency	LTE Band 4	Channel Bandwidth	10 MHz	RB Allocated	50
Lower Band Edge					
Higher Band Edge					

Frequency	LTE Band 4	Channel Bandwidth	15 MHz	RB Allocated	75
Lower Band Edge					
Higher Band Edge					

Frequency	LTE Band 4	Channel Bandwidth	20 MHz	RB Allocated	100
Lower Band Edge	<p>Agilent Spectrum Analyzer Screenshot: Lower Band Edge</p> <ul style="list-style-type: none"> Center Freq: 1.7100000 GHz Start Freq: 1.6900000 GHz Stop Freq: 1.7300000 GHz CF Step: 4.0000000 MHz Freq Offset: 0.0000000 Hz Signal Track: Off Ref: 20 dBm, Atten: 30 dB Mkr1: 1.710 00 GHz, -37.797 dBm Center: 1.710 00 GHz, Span: 40 MHz Res BW: 100 kHz, VBW: 300 kHz, Sweep: 12.12 ms (601 pts) 				
Higher Band Edge	<p>Agilent Spectrum Analyzer Screenshot: Higher Band Edge</p> <ul style="list-style-type: none"> Center Freq: 1.7550000 GHz Start Freq: 1.7350000 GHz Stop Freq: 1.7750000 GHz CF Step: 4.0000000 MHz Freq Offset: 0.0000000 Hz Signal Track: Off Ref: 20 dBm, Atten: 30 dB Mkr1: 1.755 00 GHz, -36.312 dBm Center: 1.755 00 GHz, Span: 40 MHz Res BW: 100 kHz, VBW: 300 kHz, Sweep: 12.12 ms (601 pts) 				

Frequency	LTE Band 5	Channel Bandwidth	1.4 MHz	RB Allocated	6
Lower Band Edge	<p>Agilent R T Freq/Channel</p> <p>Ref 20 dBm Atten 30 dB Mkr1 824.00 MHz -17.832 dBm</p> <p>Center Freq 824.000000 MHz</p> <p>Start Freq 819.000000 MHz</p> <p>Stop Freq 829.000000 MHz</p> <p>CF Step 1.00000000 MHz Auto Man</p> <p>Freq Offset 0.00000000 Hz</p> <p>Signal Track On Off</p> <p>Center 824.00 MHz Span 10 MHz</p> <p>#Res BW 100 kHz #VBW 300 kHz Sweep 3.04 ms (601 pts)</p> <p>Copyright 2000-2006 Agilent Technologies</p>				
Higher Band Edge	<p>Agilent R T Freq/Channel</p> <p>Ref 20 dBm Atten 30 dB Mkr1 849.00 MHz -20.571 dBm</p> <p>Center Freq 849.000000 MHz</p> <p>Start Freq 844.000000 MHz</p> <p>Stop Freq 854.000000 MHz</p> <p>CF Step 1.00000000 MHz Auto Man</p> <p>Freq Offset 0.00000000 Hz</p> <p>Signal Track On Off</p> <p>Center 849.00 MHz Span 10 MHz</p> <p>#Res BW 100 kHz #VBW 300 kHz Sweep 3.04 ms (601 pts)</p> <p>Copyright 2000-2006 Agilent Technologies</p>				

Frequency	LTE Band 5	Channel Bandwidth	3 MHz	RB Allocated	15
Lower Band Edge					
Higher Band Edge					

Frequency	LTE Band 5	Channel Bandwidth	5 MHz	RB Allocated	25
Lower Band Edge					
Higher Band Edge					

Frequency	LTE Band 5	Channel Bandwidth	10 MHz	RB Allocated	50
Lower Band Edge					
Higher Band Edge					

Frequency	LTE Band 12	Channel Bandwidth	1.4 MHz	RB Allocated	6
Lower Band Edge	<p>Agilent Spectrum Analyzer Screenshot: Lower Band Edge</p> <ul style="list-style-type: none"> Center Freq: 699.000000 MHz Start Freq: 694.000000 MHz Stop Freq: 704.000000 MHz CF Step: 1.00000000 MHz Freq Offset: 0.00000000 Hz Signal Track: Off Center: 699.00 MHz Span: 10 MHz Res BW: 100 kHz VBW: 300 kHz Sweep: 3.04 ms (601 pts) 				
Higher Band Edge	<p>Agilent Spectrum Analyzer Screenshot: Higher Band Edge</p> <ul style="list-style-type: none"> Center Freq: 716.000000 MHz Start Freq: 711.000000 MHz Stop Freq: 721.000000 MHz CF Step: 1.00000000 MHz Freq Offset: 0.00000000 Hz Signal Track: Off Center: 716.00 MHz Span: 10 MHz Res BW: 100 kHz VBW: 300 kHz Sweep: 3.04 ms (601 pts) 				

Frequency	LTE Band 12	Channel Bandwidth	3 MHz	RB Allocated	15
Lower Band Edge					
Higher Band Edge					

Frequency	LTE Band 12	Channel Bandwidth	5 MHz	RB Allocated	25
Lower Band Edge					
Higher Band Edge					

Frequency	LTE Band 12	Channel Bandwidth	10 MHz	RB Allocated	50
Lower Band Edge					
Higher Band Edge					

Frequency	LTE Band 13	Channel Bandwidth	5 MHz	RB Allocated	25
Res BW	100kHz				
Lower Band Edge					
Higher Band Edge					

Frequency	LTE Band 13	Channel Bandwidth	10 MHz	RB Allocated	50
Res BW	100kHz				
Lower Band Edge					
Higher Band Edge					

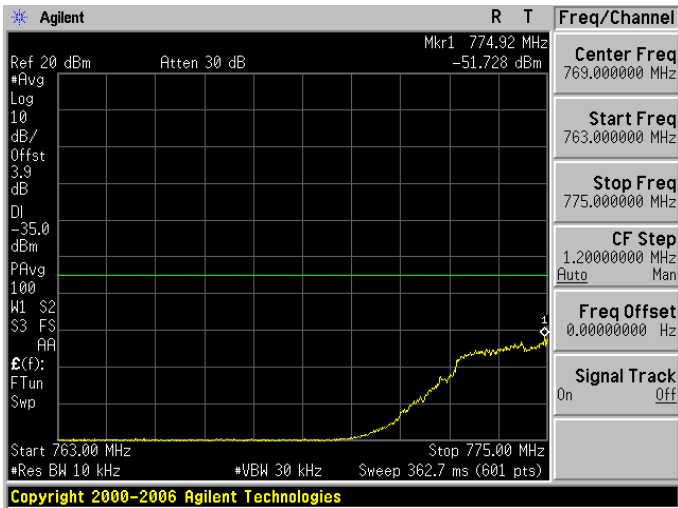
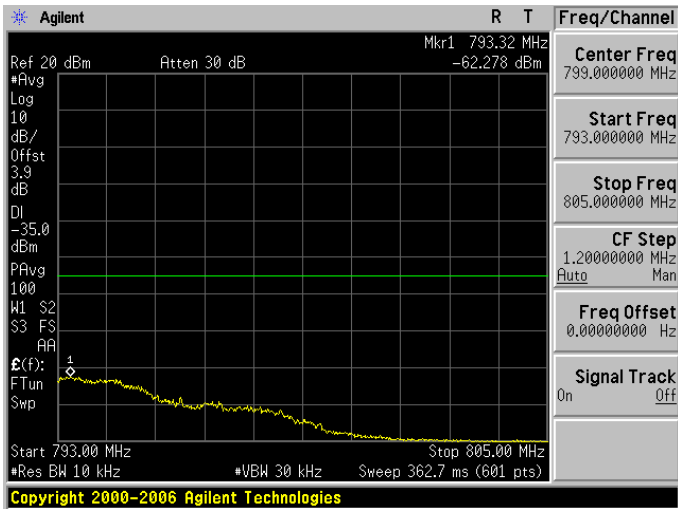
Frequency	LTE Band 13	Channel Bandwidth	5 MHz	RB Allocated	25
Res BW	10kHz				
Lower Band Edge					
Higher Band Edge					

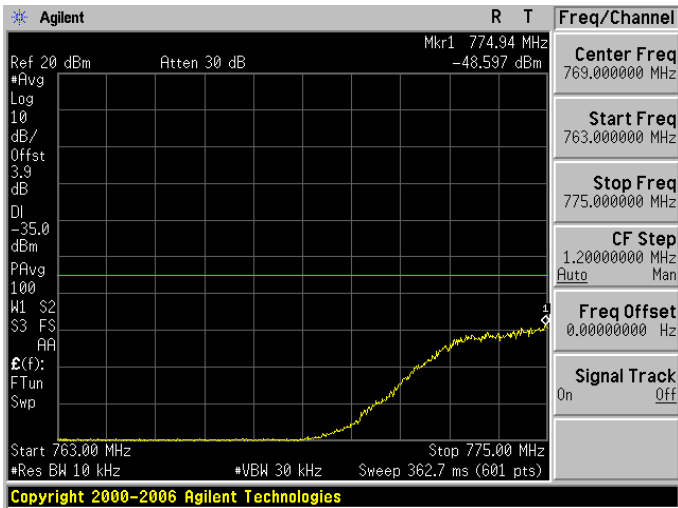
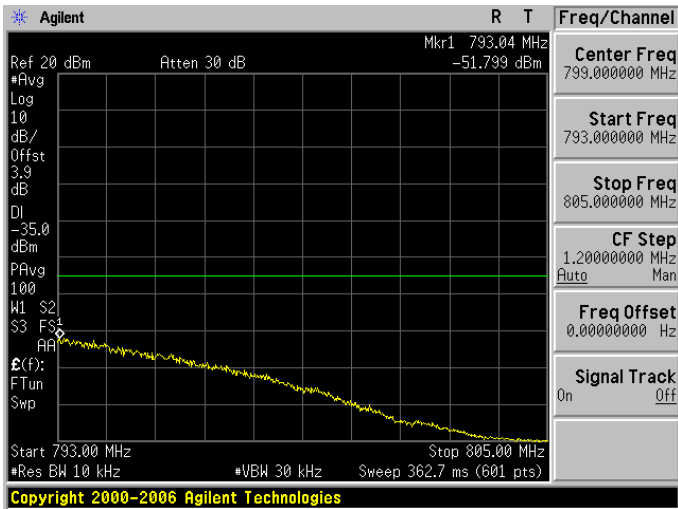
Frequency	LTE Band 13	Channel Bandwidth	10 MHz	RB Allocated	50
Res BW	10kHz				
Lower Band Edge					
Higher Band Edge					

Frequency	LTE Band 17	Channel Bandwidth	5 MHz	RB Allocated	25
Lower Band Edge					
Higher Band Edge					

Frequency	LTE Band 17	Channel Bandwidth	10 MHz	RB Allocated	50
Lower Band Edge	<p>Agilent R T Freq/Channel</p> <p>Ref 20 dBm #Atten 30 dB Mkr1 704.00 MHz -29.186 dBm</p> <p>#Avg Log 10 dB/Offst 3.9 dB DI -13.0 dBm PAvg 100 W1 S2 S3 FS AA</p> <p>Center 704.00 MHz Span 20 MHz #Res BW 100 kHz #VBW 300 kHz Sweep 6.08 ms (601 pts)</p> <p>Copyright 2000-2006 Agilent Technologies</p> <p>Center Freq 704.000000 MHz</p> <p>Start Freq 694.000000 MHz</p> <p>Stop Freq 714.000000 MHz</p> <p>CF Step 2.00000000 MHz Auto Man</p> <p>Freq Offset 0.00000000 Hz</p> <p>Signal Track On Off</p>				
Higher Band Edge	<p>Agilent R T Freq/Channel</p> <p>Ref 20 dBm #Atten 30 dB Mkr1 716.00 MHz -31.176 dBm</p> <p>#Avg Log 10 dB/Offst 3.9 dB DI -13.0 dBm PAvg 100 W1 S2 S3 FS AA</p> <p>Center 716.00 MHz Span 20 MHz #Res BW 100 kHz #VBW 300 kHz Sweep 6.08 ms (601 pts)</p> <p>Copyright 2000-2006 Agilent Technologies</p> <p>Center Freq 716.000000 MHz</p> <p>Start Freq 706.000000 MHz</p> <p>Stop Freq 726.000000 MHz</p> <p>CF Step 2.00000000 MHz Auto Man</p> <p>Freq Offset 0.00000000 Hz</p> <p>Signal Track On Off</p>				