

RF Test Report:

Airspan iRelay **FCC part 27 cellular**

FCC ID: O2J-IR460

SC_TR_183_C

Contents

1	Revision History	4
2	Purpose.....	4
3	Reference Documents	4
4	Test Information	5
4.1	Client and manufacturer.....	5
4.2	Test Locations.....	5
4.3	Test sample.....	5
5	Test Configuration	6
5.1	Test sample and Operating mode	6
5.2	Support equipment.....	6
5.3	Equipment arrangement.....	7
6	Summary of Tests performed	9
6.1	Comments on requirements in KDB 935210 D05 V01:	9
7	Determination of f_0	10
8	Transmit Power	11
8.1	Test method	11
8.2	Test results	11
9	Occupied bandwidth:	14
9.1	Test method	14
9.2	Test results	14
10	CSE inc. Band Edge	15
10.1	Requirement and test method.....	15
10.2	Test results: Bandedge	16
10.3	Test results: CSE except Bandedge.....	18
11	Radiated Spurious Emissions.....	21
11.1	Requirement and test method.....	21
11.2	Results	24
12	Part 15 emissions	25
12.1	Mains conducted emissions: 47CFR15.107.....	25
12.2	Radiated emissions: 47CFR15.109.....	26
13	Test equipment	27

Tables

Table 1: Equipment under test	6
Table 2: Support Equipment	6
Table 3: Summary of tests performed	9
Table 4: KDB 935210 D05 V01 tests not required	9
Table 5: Determination of F_0 and frequency range	10
Table 6: Transmit power	11
Table 7: Occupied bandwidth	14
Table 8: CSE Band edge results.....	16
Table 9: CSE except Band edge.....	18
Table 10: RSE substitution measurements	24
Table 11: Test Equipment.....	27

Figures

Figure 1: Test configuration: conducted measurements.....	7
Figure 2: Test configuration: RSE measurements	7
Figure 2: Test configuration: Part 15B measurements	8
Figure 3: Determination of f_0 for bands of operation.....	10
Figure 4: Power and Peak to Average (PAR) plots; 2500-2570 MHz band.....	12
Figure 5: Power and Peak to Average (PAR) plots; 2620-2690 MHz band.....	13
Figure 6: Input vs output plot	14
Figure 7: Band edge measurements.....	17
Figure 8: CSE except band edge.....	20
Figure 9: RSE pre-scan plots.....	23
Figure 10: RSE substitution plots.....	24

1 Revision History

Revision	Originator	Date	Comment
A	C Blackham	14 Jan 2016	1 st release
B	C Blackham	28 Jan 2016	Typo corrected in test date
C	C Blackham	08 Feb 2016	Figure references corrected

2 Purpose

This document details the Airspan iRelay operating in the 2500–2572 and 2620–2690 MHz band as per Part 27 of the FCC rules

3 Reference Documents

- | | | |
|-----|----------------------|---|
| [1] | 47CFR2 | Title 47 Code of Federal Regulations Part 2: frequency allocations and radio treaty matters; general rules and regulations |
| [2] | 47 CFR27 | Title 47 Code of Federal Regulations Part 27: Miscellaneous Communications Services |
| [3] | TIA-603-D | Land Mobile FM or PM – Communications Equipment – Measurement and Performance Standards |
| [4] | KDB 935210 D05 V01 | Federal Communications Commission Office of Engineering and Technology Laboratory Division; Measurement guidance for Industrial and Non-consumer signal booster, repeater and amplifier devices |
| [5] | KDB971168 DO1 v02r02 | Federal Communications Commission Office of Engineering and Technology Laboratory Division; Measurement guidance for certification of licensed digital transmitters. |

4 Test Information

4.1 *Client and manufacturer*

Airspan Communications Ltd
Capital Point,
33 Bath Road
Slough,
SL1 3UF
UK

4.2 *Test Locations*

Conducted Emissions (sections 7 to 10)

Testing was performed by Charlie Blackham of Sulis Consultants Ltd at Airspan Communications offices on 17 December 2015.

Radiated Spurious Emissions (section 11)

Testing was performed by Richard Pennell of Hursley EMC services Ltd, at their FCC Registered test facility, UK designation number UK0006, on 24th December 2015 under job 15J564.

Conducted and Radiated Emissions to 47CFR15B (Section 12)

Testing was performed by Luke March of Hursley EMC services Ltd, at their FCC Registered test facility, UK designation number UK0006, on 24th November 2015 under job 15J519.

4.3 *Test sample*

The results herein only refer to sample detailed in section 5.

5 Test Configuration

5.1 Test sample and Operating mode

The equipment under test (EUT) was:

Manufacturer	Name	Model Number	Serial Number
Airspan	iRelay	iR460-SPB-ST1-P-0	# 1

Table 1: Equipment under test

Modifications during test: None

Procedure:

- Set the system to the required gain using laptop and interface card
- Connect the signal generator to the amplifier and to the Spectrum Analyser and check the correct input power is set.
- Connect amplifier output to the RF input of the iRelay FEM
- Perform the required test.

Test modulations:

- The system supports operation with a number of wideband services, so testing was performed with AWGN signal as per KDB 935210 D05.

5.2 Support equipment

The following equipment shall be used, configured as shown in Figure 1:

Description	Manufacturer	Name	Serial Number
Laptop	Dell	Latitude	Airspan 005995
Interface card	National instruments	USB-8451	18E8F9C
Power supply	TTI	PL330TP	292589
Power supply	Weir	413D	8863
Laptop	Dell	Latitude	AIRN006065
POE injector		MIT-09G-24H	14C006606DRC05

Table 2: Support Equipment

5.3 Equipment arrangement

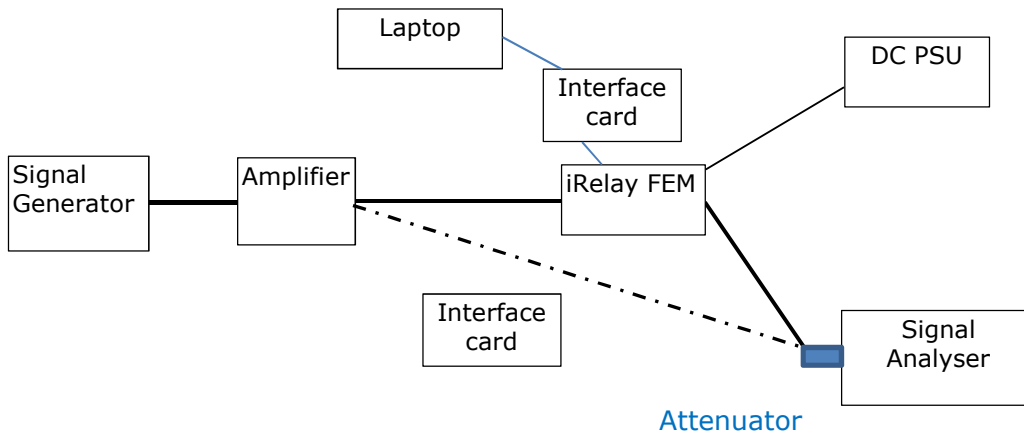

Figure 1: Test configuration: conducted measurements

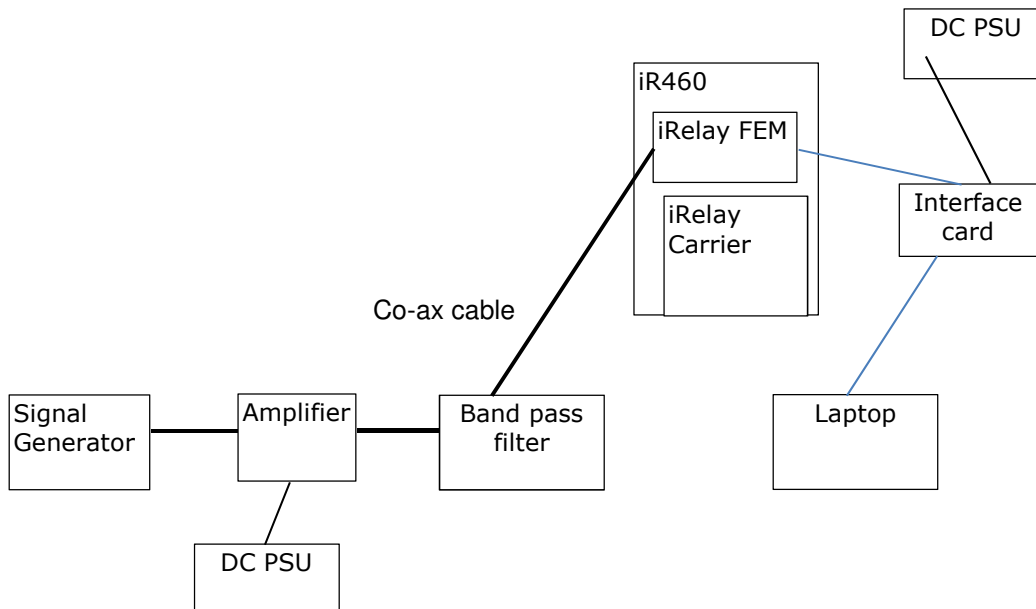

Figure 2: Test configuration: RSE measurements

Note:

- In normal operating mode the band switching of the FEM is done by iRelay Carrier PCBA under the control of network management software when the unit is deployed.
- In order to switch the FEM bands in test mode it was necessary to use an external National Instruments controller which could be controlled from the PC.
- This was left connected during testing as it had a quiet EMC profile and facilitates switching between high and low during testing

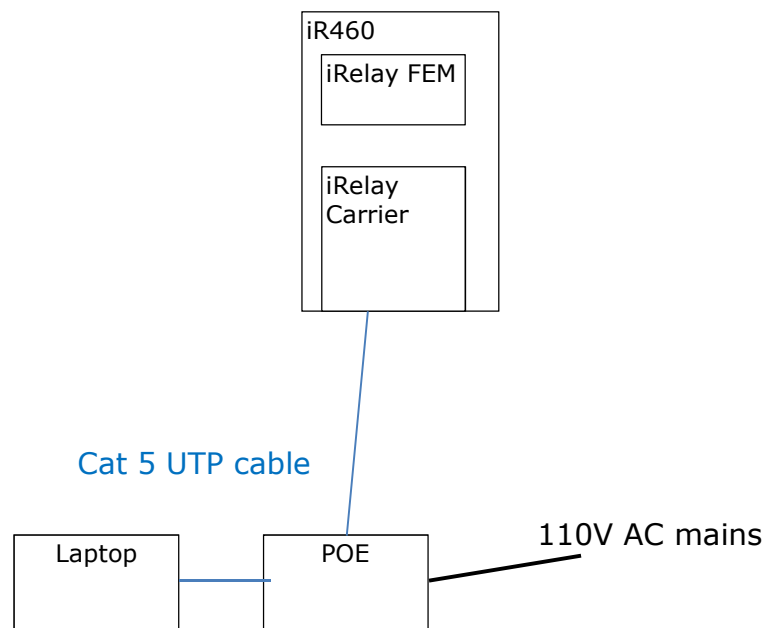

Figure 3: Test configuration: Part 15B measurements

Note:

- During this test the Laptop was running iPerf software to generate Ethernet traffic to and from the iRelay unit.
- The device acts as a backhaul to a basestation so is always transmitting and receiving. As such, in common with many basestations, it does not have a “non-intentional transmitter mode”, however it is host to a separate certified radio module so part 15 testing has been done.

6 Summary of Tests performed

Test	47 CFR Part	FCC limit	Section	Result
Determination of f_0	KDB 935210 D05 Section 3.3	None	7	N/A
Transmit Power	27.50(h)(2)	2 W ERP	8	Pass
Gain	KDB 935210 D05 Section 3.5	None	8	Pass
Occupied Bandwidth	2.1049 KDB 935210 D05 Section 3.4	None	9	Pass
Conducted Spurious Emissions	27.53(m)(2) 2,1051	-13dBm / 1 MHz	10	Pass
Radiated Spurious Emissions	27.53(m)(2) 2,1053	-13dBm / 1 MHz	11	Pass
Conducted and Radiated Emission	15.107 15.109	Class A	12	Pass

Table 3: Summary of tests performed

6.1 Comments on requirements in KDB 935210 D05 V01:

Section	Comment
3.1 General	The device is designed only to be connected to wideband LTE modems so only a wideband AWGN signal shall be used
3.2 Measuring the EUT AGC threshold	Not applicable "Devices intended to be directly connected to an RF source only need to be evaluated for any over-the-air transmit paths." There are no such over-the-air paths
Various, ref KDB response 130697	Increased input level test not required due to 3.2
3.6.1 Out-of-band/block emissions (including intermodulation products) shall be measured under each of the following two stimulus conditions: a) two adjacent test signals b) a single test signal,	The iR460 is designed to be connected to a single transmitter and therefore measurement of two adjacent channels is not required .
3.7 EUT frequency stability measurements	Not required as iR460 does not contain oscillator and therefore has no ability to change frequency.

Table 4: KDB 935210 D05 V01 tests not required

7 Determination of f_0

As per kDB 935210 D05 section 3.3,

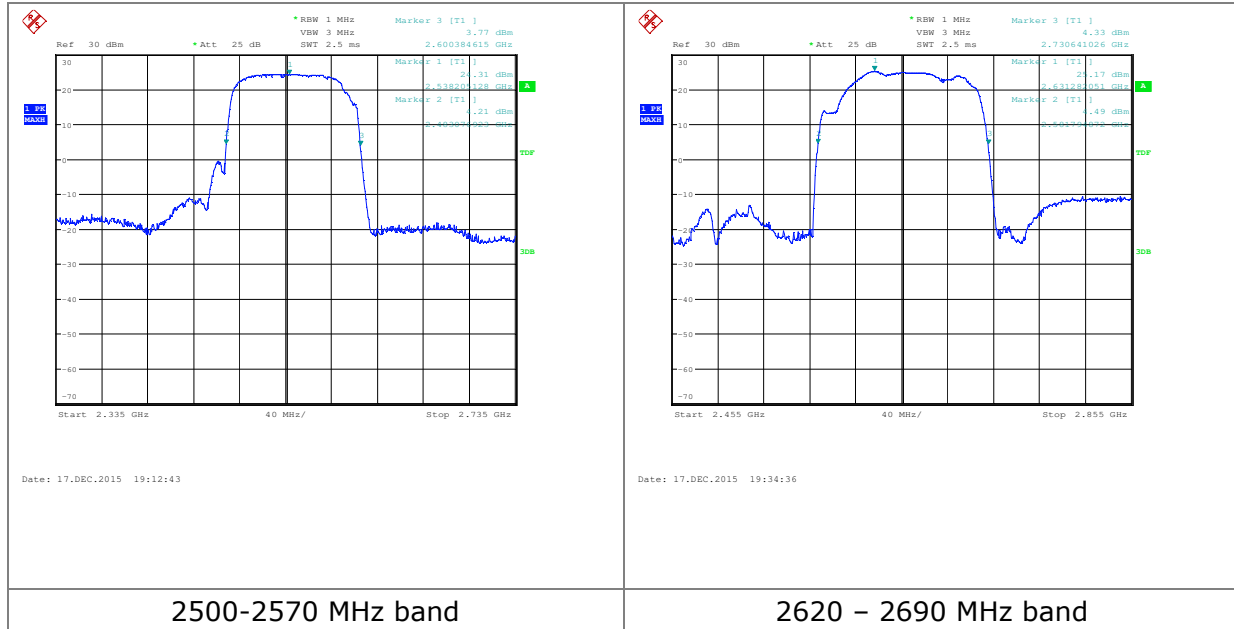

Figure 4: Determination of f_0 for bands of operation

Frequency band	Frequency point (MHz)		
	F_0	-20dBc low	-20 dBc high
2500 - 2570 MHz	2538.2	2483.1	2600.4
2620 – 2690 MHz	2631.3	2581.8	2730.6

Table 5: Determination of F_0 and frequency range

8 Transmit Power

8.1 Test method

The equipment was configured with maximum gain of -4dBm and connected as per figure 1.

Measurements were made in accordance with KDB 971168 D01 using an RMS detector and the Peak to Average ratio was measured using the CCDF function of the analyser.

Measurement was made using a AWGN signal

8.2 Test results

27.50(h) The following power limits shall apply in the BRS and EBS:

(2) *Mobile and other user stations.* Mobile stations are limited to 2.0 watts EIRP. All user stations are limited to 2.0 watts transmitter output power

Frequency	TX power (dBm)	TX power EIRP (dBm)	TX power EIRP (W)	Limit EIRP (W)	0.1% PAR	Result
2500-2570 MHz						
2538.2	19.7	32.7	1.86	2.0	6.51	Pass
2620 – 2690 MHz						
2631.3	19.77	32.8	1.91	2.0	6.44	Pass

Table 6: Transmit power

Plots may be seen in figures 5 and 6.

Peak to Average (PAR) ratio is related to the modulation waveform, and not the frequency of operation, so results presented for one channel cover all frequencies in these bands of operation.

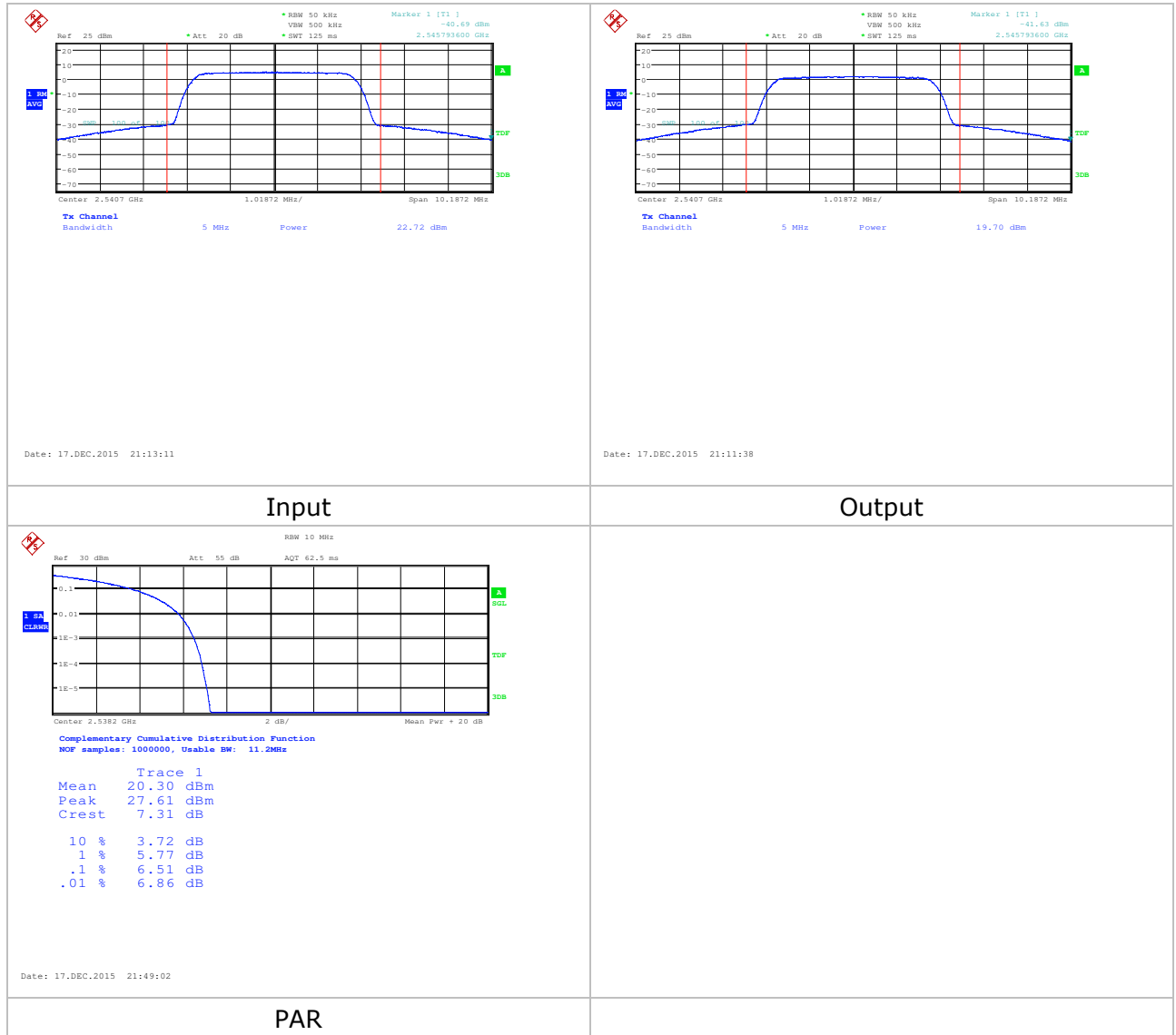

Figure 5: Power and Peak to Average (PAR) plots; 2500-2570 MHz band

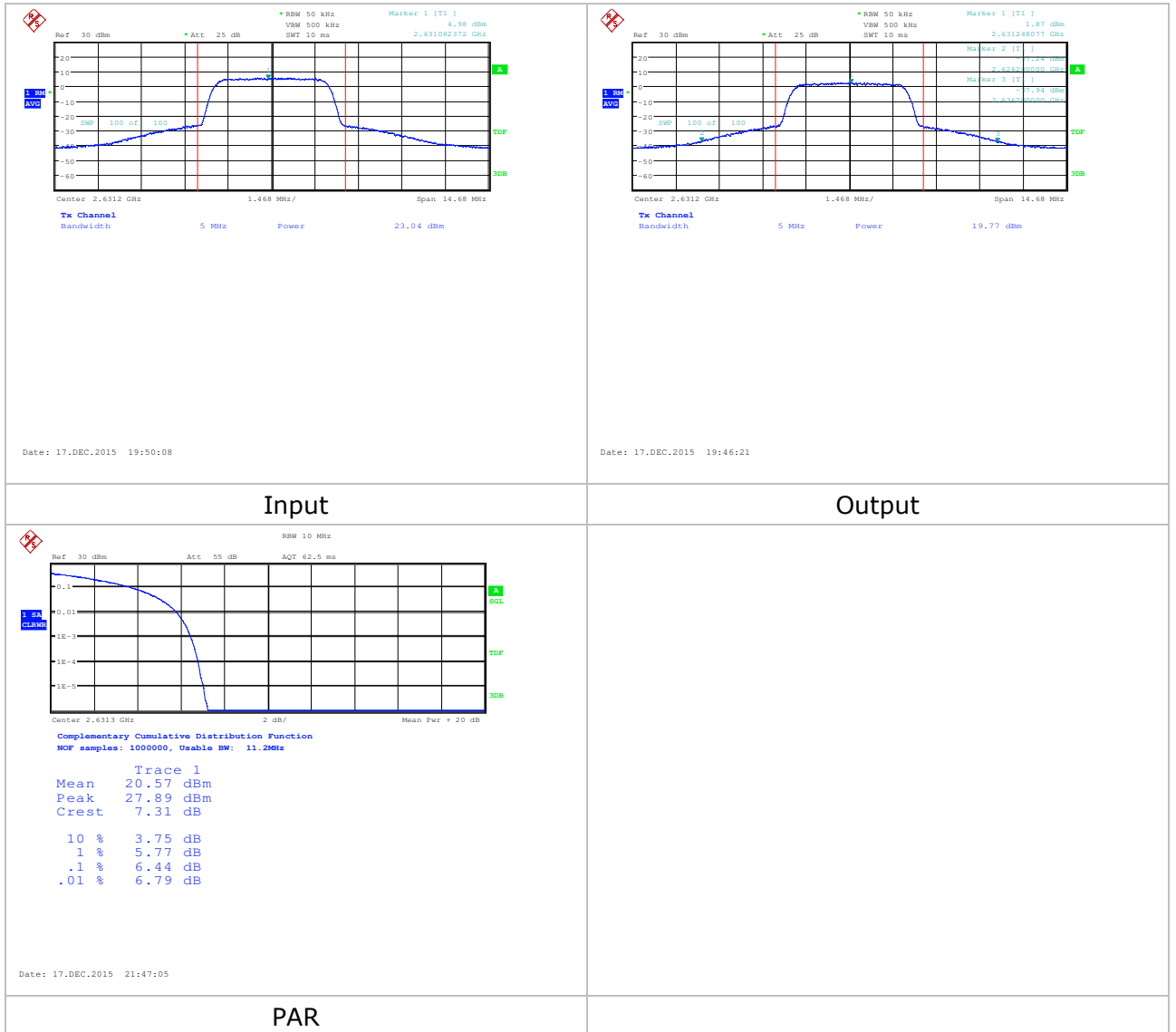

Figure 6: Power and Peak to Average (PAR) plots; 2620-2690 MHz band

9 Occupied bandwidth:

9.1 Test method

KDB 935210 D05 section 3.4

The occupied bandwidth was measured using the inbuilt function on the Signal Analyser set to measure the 99.5% emission bandwidth, using peak detector.

9.2 Test results

Freq	Input occupied bandwidth	Output occupied bandwidth
Low band	4.0545 MHz	4.0545 MHz
High band	4.0914 MHz	4.0914 MHz

Table 7: Occupied bandwidth

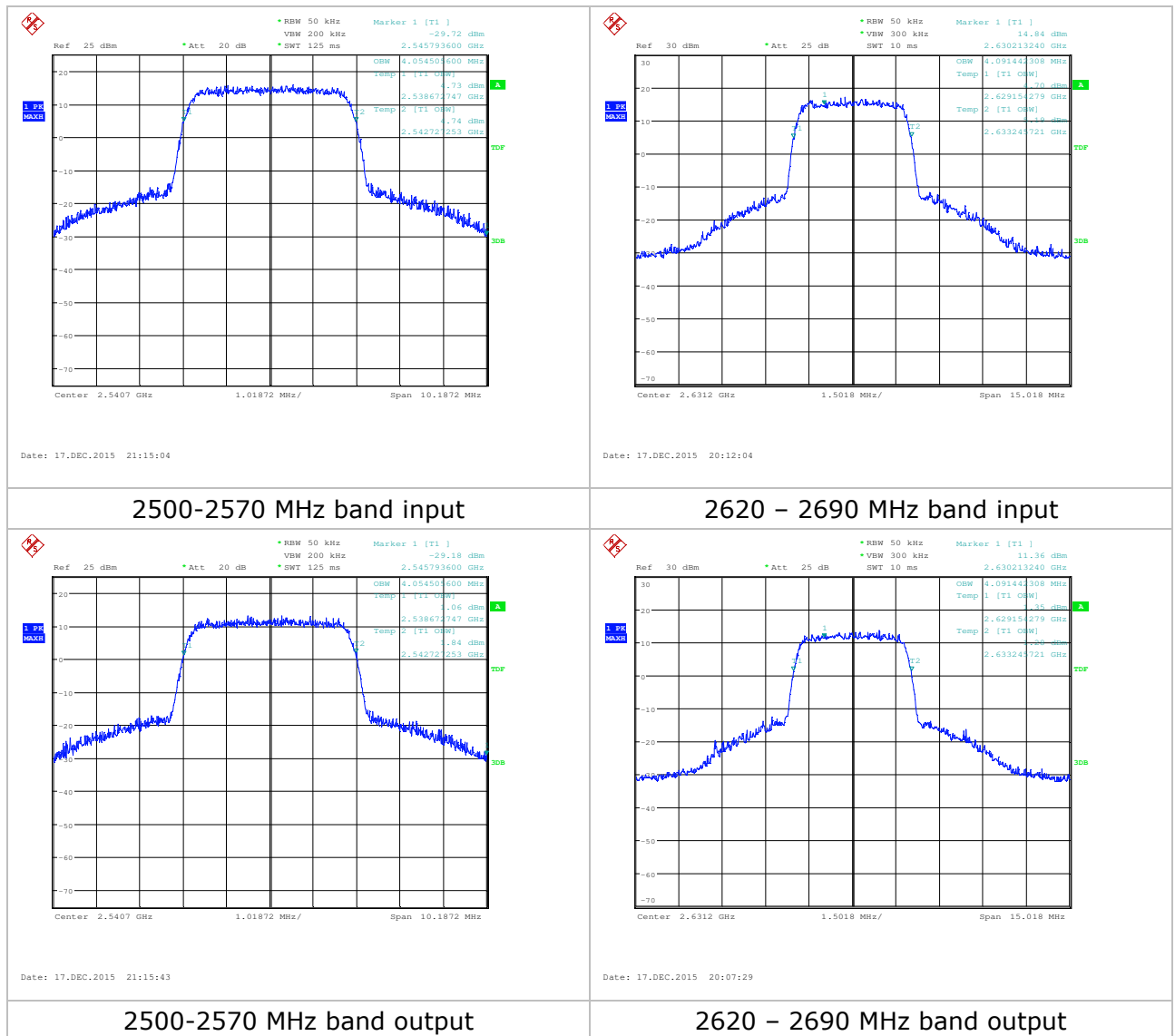

Figure 7: Input vs output plot

10 CSE inc. Band Edge

10.1 Requirement and test method

27.53 (m) For BRS and EBS stations, the power of any emissions outside the licensee's frequency bands of operation shall be attenuated below the transmitter power (P) measured in watts in accordance with the standards below. If a licensee has multiple contiguous channels, out-of-band emissions shall be measured from the upper and lower edges of the contiguous channels.

2) For digital base stations, the attenuation shall be not less than $43 + 10 \log (P)$ dB, unless a documented interference complaint is received from an adjacent channel licensee with an overlapping Geographic Service Area. Mobile Satellite Service licensees operating on frequencies below 2495 MHz may also submit a documented interference complaint against BRS licensees operating on channel BRS No. 1 on the same terms and conditions as adjacent channel BRS or EBS licensees. Provided that a documented interference complaint cannot be mutually resolved between the parties prior to the applicable deadline, then the following additional attenuation requirements shall apply:

(v) For all fixed digital user stations, the attenuation factor shall be not less than $43 + 10 \log (P)$ dB at the channel edge.

(6) *Measurement procedure.* Compliance with these rules is based on the use of measurement instrumentation employing a resolution bandwidth of 1 megahertz or greater. However, in the 1 MHz bands immediately outside and adjacent to the frequency block a resolution bandwidth of at least one percent of the emission bandwidth of the fundamental emission of the transmitter may be employed; for mobile digital stations, in the 1 megahertz bands immediately outside and adjacent to the frequency block a resolution bandwidth of at least two percent may be employed, except when the 1 megahertz band is 2495-2496 MHz, in which case a resolution bandwidth of at least one percent may be employed. A narrower resolution bandwidth is permitted in all cases to improve measurement accuracy provided the measured power is integrated over the full required measurement bandwidth (i.e. 1 megahertz or 1 percent of emission bandwidth, as specified; or 1 megahertz or 2 percent for mobile digital stations, except in the band 2495-2496 MHz). The emission bandwidth is defined as the width of the signal between two points, one below the carrier center frequency and one above the carrier center frequency, outside of which all emissions are attenuated at least 26 dB below the transmitter power. With respect to television operations, measurements must be made of the separate visual and aural operating powers at sufficiently frequent intervals to ensure compliance with the rules

Some emissions > 1 MHz from bandedge were measured using the spectrum analyser adjacent channel power function that integrated power from a lower resolution bandwidth into the 1 MHz required by the rule part.

10.2 Test results: Bandedge

Marker shows highest emission within 1 MHz of bandedge

Emissions between 1 and 3 MHz from bandedge measured using Adjacent Channel Power measurement function and the relative values on the plots converted to absolute values in the table:

Band	Band edge	Frequency under investigation (MHz)	Emission (dBm)	Limit (dBm)	Result
2500-2570 MHz	Lower	2499 - 2500	-35.57	-13.0	Pass
		2498 - 2499	-33.12	-13.0	Pass
		2497 - 2498	-36.40	-13.0	Pass
	Upper	2570 - 2571	-32.77	-13.0	Pass
		2571 - 2572	-31.11	-13.0	Pass
		2572 - 2573	-38.23	-13.0	Pass
2620 - 2690 MHz	Lower	2619 - 2620	-32.91	-13.0	Pass
		2618 - 2619	-31.27	-13.0	Pass
		2617 - 2618	-34.04	-13.0	Pass
	Upper	2690 - 2691	-29.84	-13.0	Pass
		2691 - 2692	-27.68	-13.0	Pass
		2692 - 2693	-31.32	-13.0	Pass

Table 8: CSE Band edge results

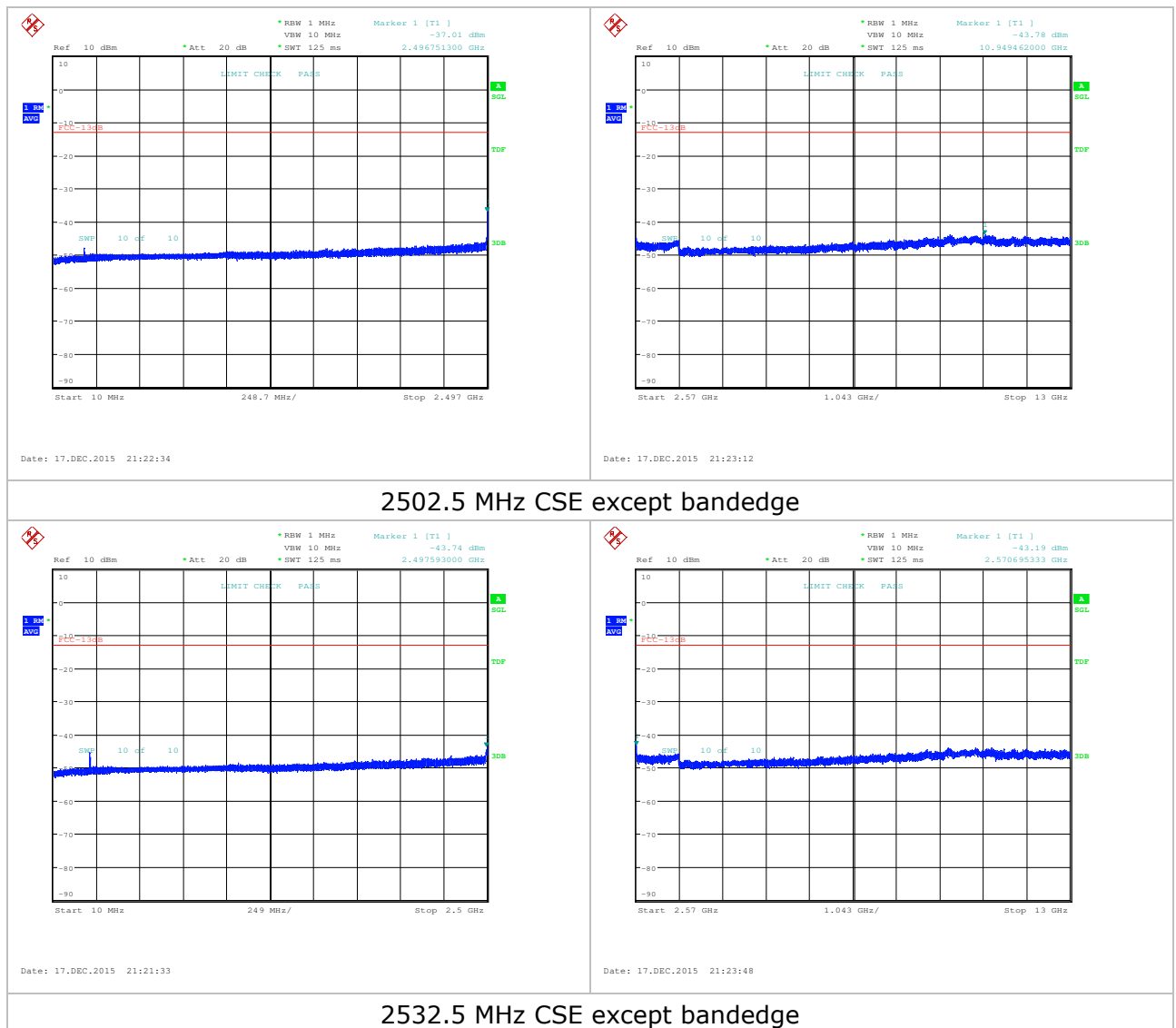

Figure 8: Band edge measurements

10.3 Test results: CSE except Bandedge

Band	Channel	Worst case emission (dBm)	Limit (dBm)	Result
2500-2570 MHz	Bottom	-37.01	-13.0	Pass
	Middle	-43.19	-13.0	Pass
	Top	-43.91	-13.0	Pass
2620 - 2690 MHz	Bottom	-36.17	-13.0	Pass
	Middle	-41.28	-13.0	Pass
	Top	-29.71	-13.0	Pass

Table 9: CSE except Band edge



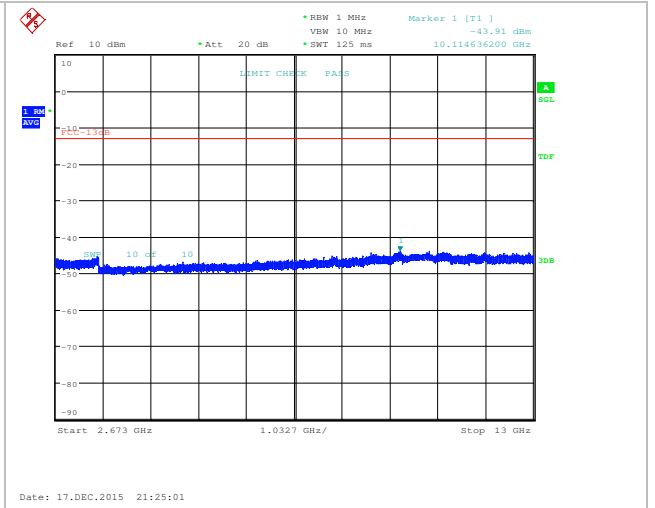
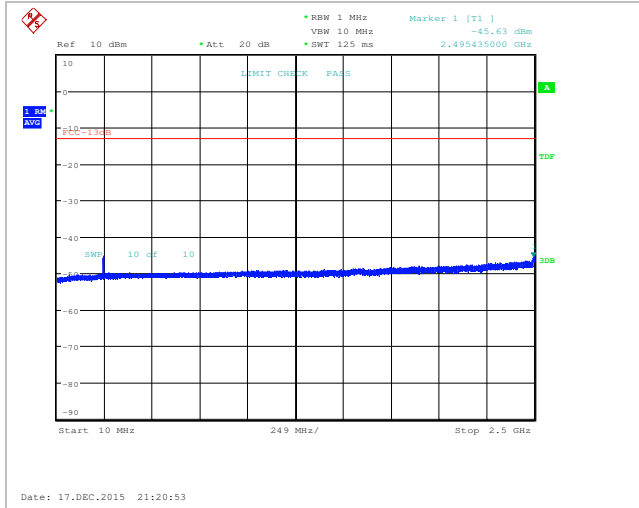

2567.5 MHz CSE except bandedge

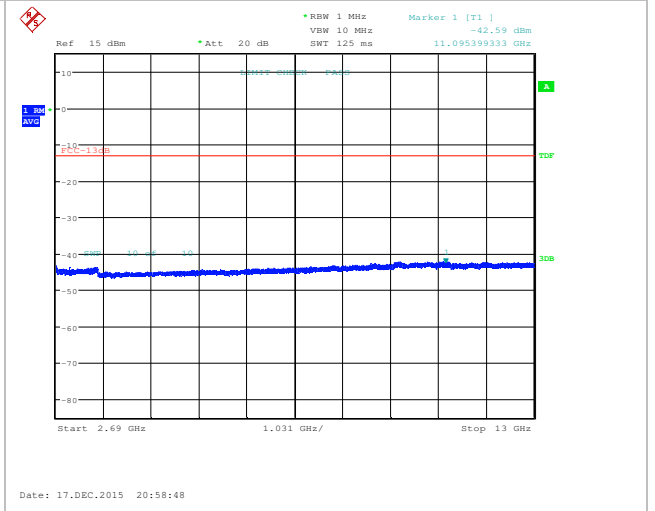
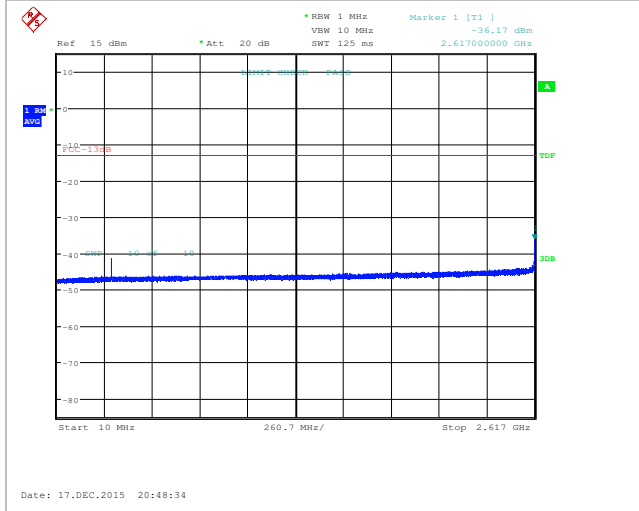

2622.5 MHz CSE except bandedge

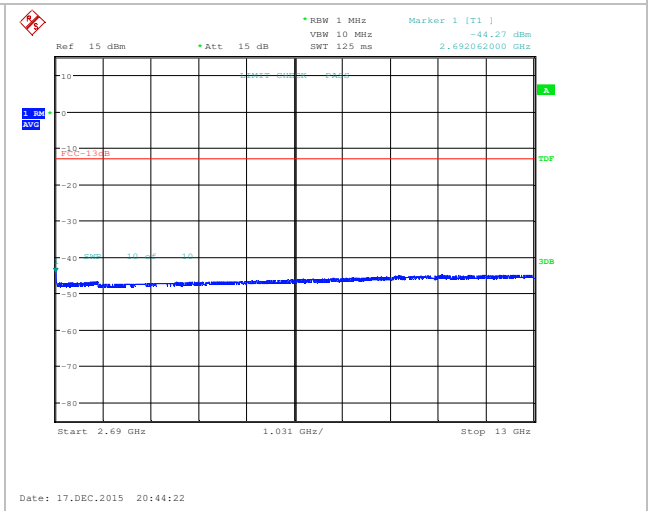
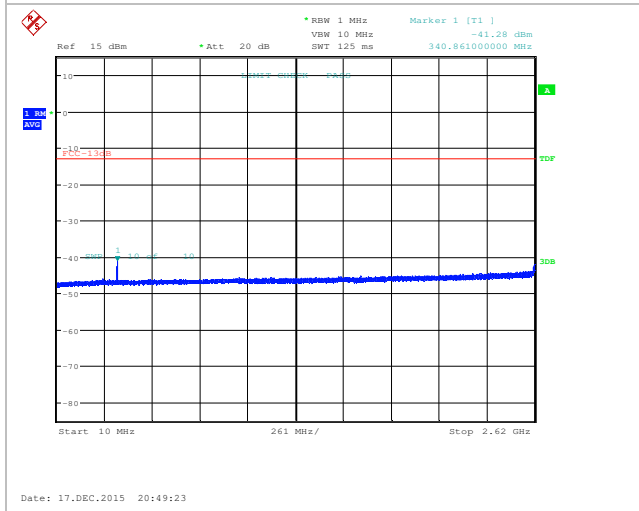

2655.0 MHz CSE except bandedge

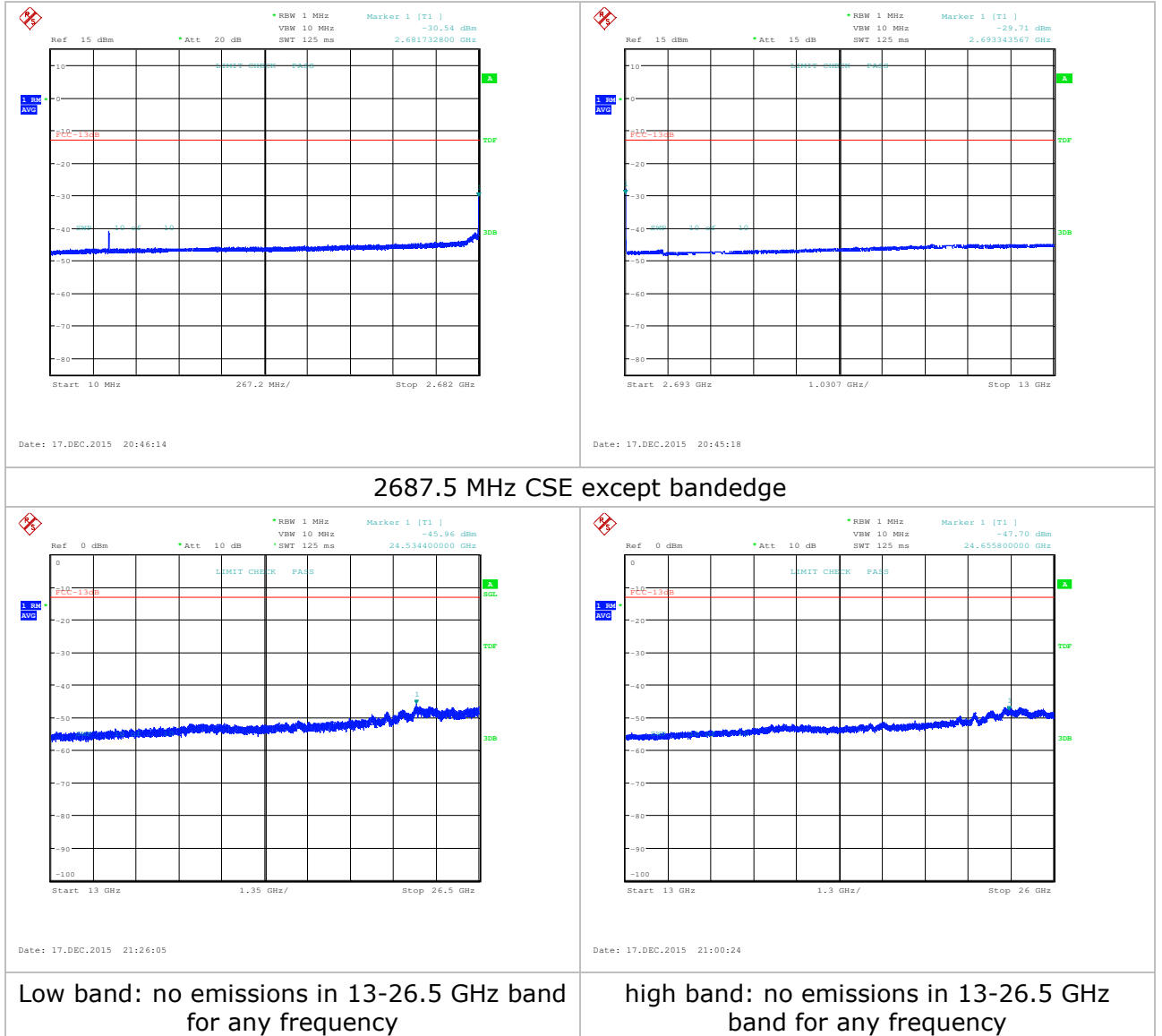

Figure 9: CSE except band edge

11 Radiated Spurious Emissions

11.1 Requirement and test method

Limits are the same as section 10.

Attenuation of $43+10\log(P)$ dBm equates to an absolute limit of -13dBm.

All measurements below 18 GHz were performed at 3m distance

Emissions above 18 GHz were measured at 1m.

Pre-scan measurements were performed with a spectrum analyser, using a peak detector with 100 kHz RBW for frequencies below 1 GHz and 1 MHz for frequencies above 1 GHz.

The cabinet radiation was performed with antenna port were terminated with a 50Ω load.

Initial pre-scan measurements were performed with limit determined by

$$E = \text{EIRP} - 20\log D + 104.8$$

Where pre-scans showed emissions within 20dB of the limit, final measurement was made using substitution method, with results presented in section 11.2.

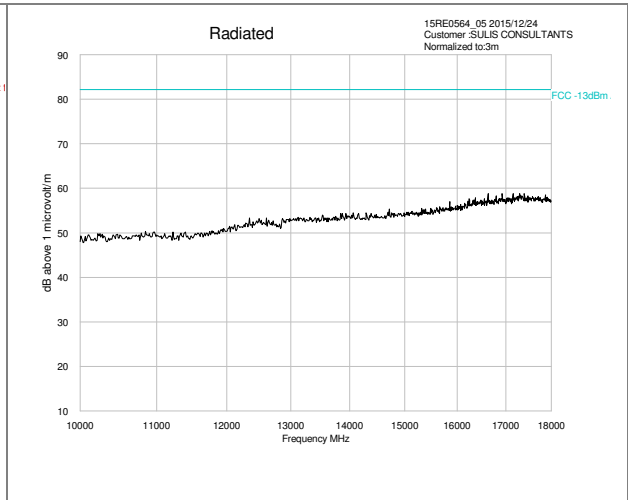
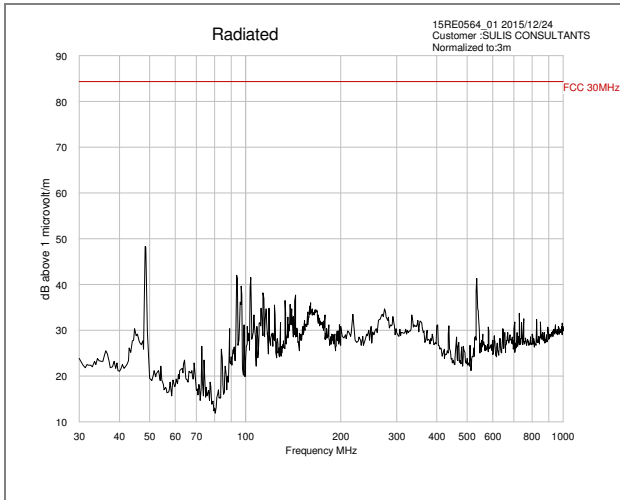

30 – 1000 MHz: both bands

10 – 18 GHz: Upper band worst case

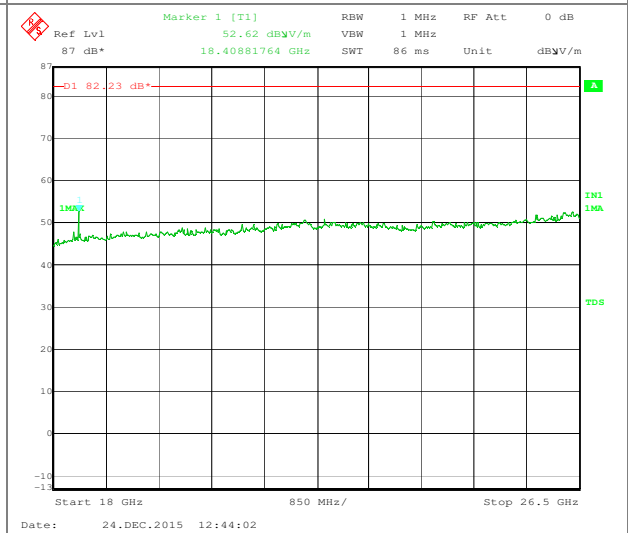
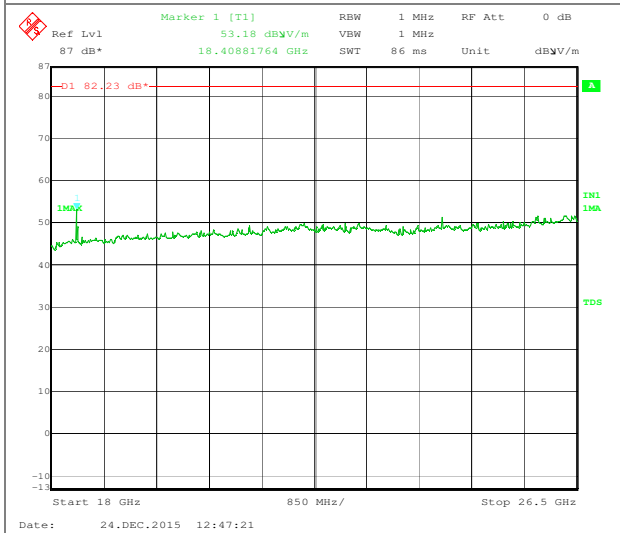

18 - 26 GHz, H: Upper band worst case

18 - 26 GHz, V: Upper band worst case

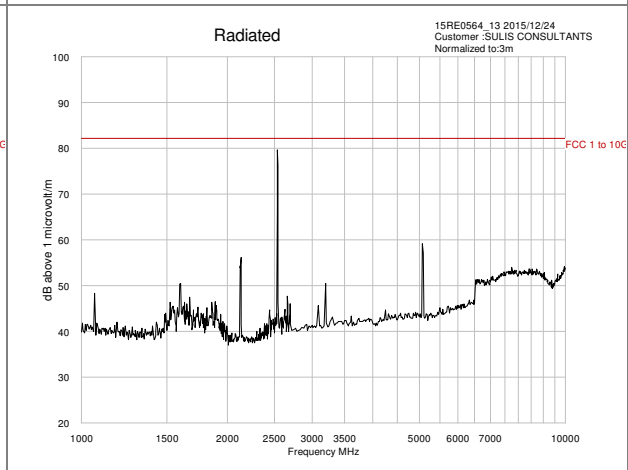
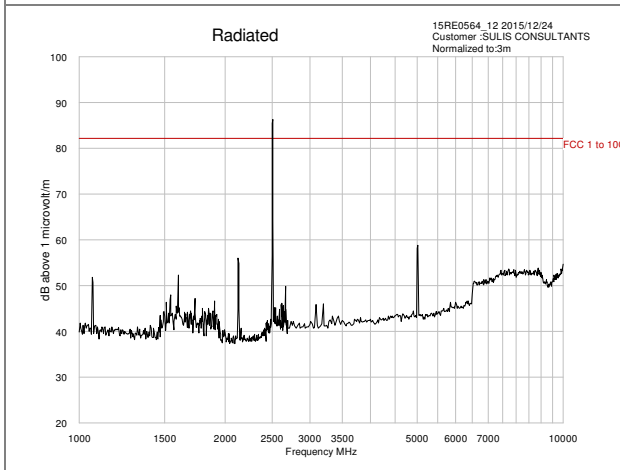

1 – 10 GHz: Low band; bottom

1 – 10 GHz: Low band; middle

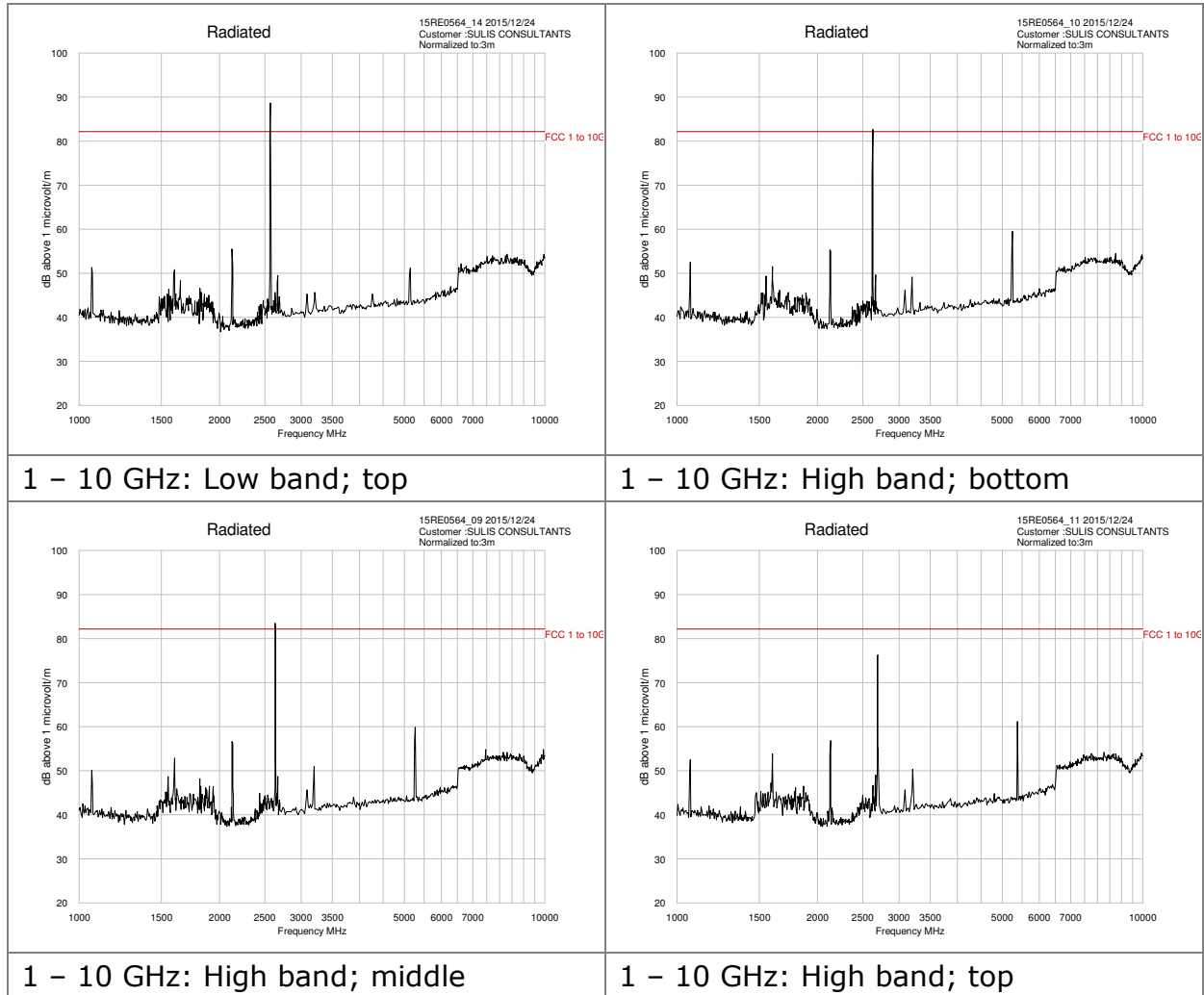

Figure 10: RSE pre-scan plots

With exception of the fundamental frequency, no emissions were within 20dB of the limit.

Band edge compliance is demonstrated in section 11.2 below.

11.2 Results

Substitution measurement test was performed for two worst case pre-scans:

Frequency (MHz)	Measurement bandwidth	Emission level (dBm)	Limit (dBm)	Result
2502.5	1 MHz	-21.90	-13.0	Pass
2502.5	100 kHz	-47.28	-13.0	Pass
2567.5	1 MHz	-23.45	-13.0	Pass
2567.5	100 kHz	-48.24	-13.0	Pass

Table 10: RSE substitution measurements

These worst case emissions were > 20dB below the limit so no further investigation was required.

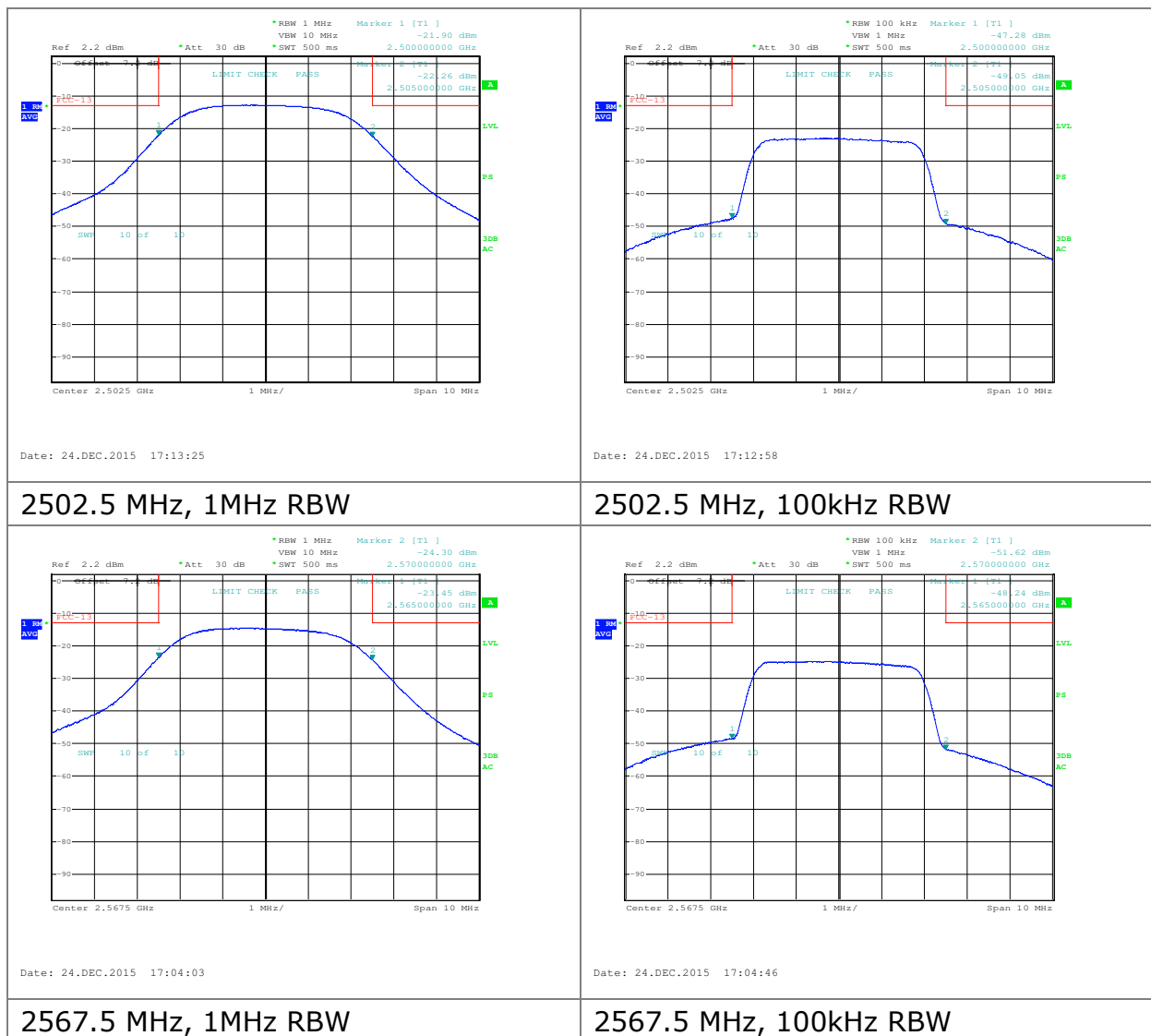

Figure 11: RSE substitution plots

12 Part 15 emissions

12.1 Mains conducted emissions: 47CFR15.107

A filtered supply was fed to the EUT via a 50Ω/50μH Artificial Mains Network (AMN). The AMN was bonded to a conductive ground plane. Line and neutral phases were measured separately.

A spectrum analyser was set to scan between 0.15 MHz and 30.0 MHz to record the emission profiles with quasi-peak and average detectors. Measurements made according to the EN 55022 test standard and Hursley EMC Services test procedure CON-02. The results are shown below:

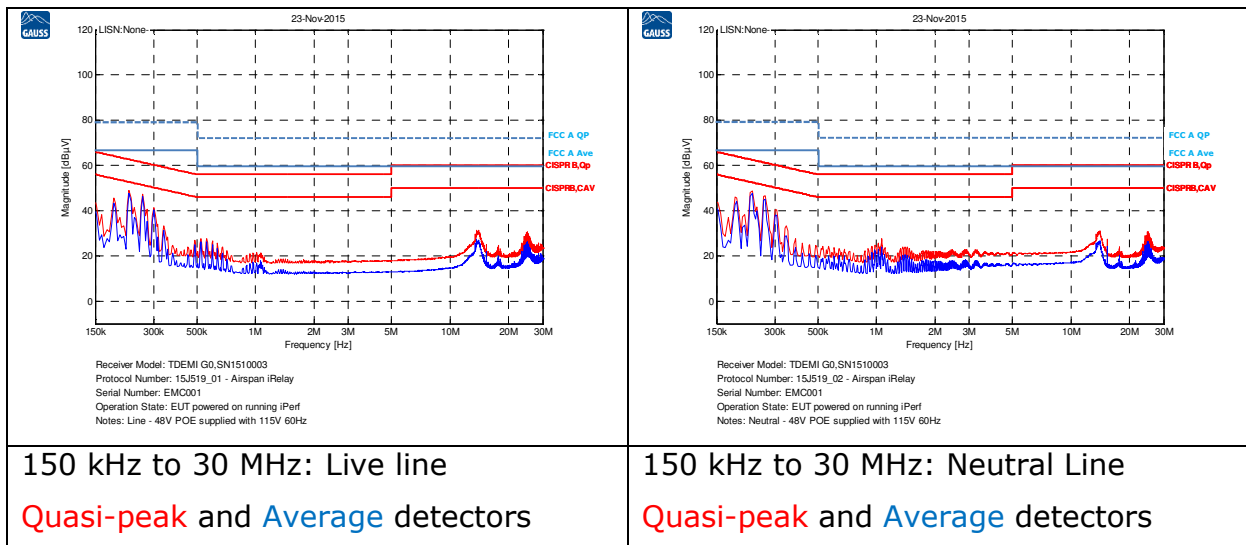

All measurements were > 18dB below the class A limits – worst case values reported in table below.

Line	Detector	Frequency	Magnitude (dBμV)	FCC Class A Limit (dBμV)	Difference	Result
Live	QP	224.113 kHz	48.97	79.0	30.03	Pass
	Average	224.113 kHz	47.62	66.0	18.38	Pass
Neutral	QP	228.882 kHz	48.72	79.0	30.28	Pass
	Average	228.882 kHz	47.70	66.0	18.30	Pass

12.2 Radiated emissions: 47CFR15.109

Radiated emissions pre-scan profile measurements were taken at a distance of three metres on eight azimuths of the EUT in both horizontal and vertical antenna polarities in a semi-anechoic chamber.

The EUT was scanned in a chamber with the supply voltage set to 110V/60Hz.

Using the pre-scan results as a guide, each emission from the EUT was maximised where required. Measurements were carried out a distance of three metres in a CISPR 16-1-4 compliant semi-anechoic chamber. Cable positions were then finally adjusted to produce the maximum emission levels. The worst-case CISPR results are recorded below.

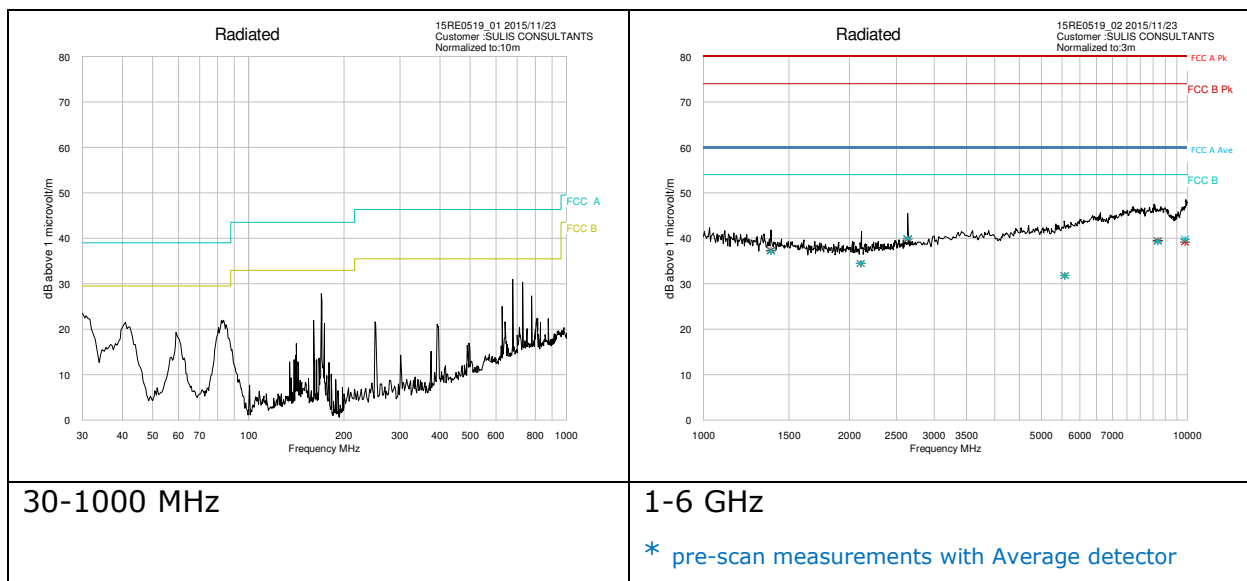

All emissions were at least 15dB below the class A limit so no further measurements were necessary.

13 Test equipment

Description	Manufacturer	Model	Serial Number	Calibration
Testing at Airspan				
Signal Analyser	Rohde & Schwarz	FSV 40	Airspan 005520	10-300314873 Due 16/02/2016
Signal Generator	Agilent	E4433B	Airspan 003614	Calibrated as part of test set-up
Cable	Utiflex	BUA01G	FA210A0009M30309	
Cable	Sucoflex	104	123383/4	
Cable	Sucoflex	104	123456/4	
Amplifier	Mini-circuits	ZHL-42	QA1215004	
Signal Generator	Rohde & Schwarz	SMJ100A	100156	
Attenuator	Mini-circuits	BW-N20W5	0315	Calibrated as part of test set-up at Hursley
Band pass filter	K&L	5BT-1200/2600-1-N/N	2 0624	
Testing at Hursley¹				
Pre-amplifier (30-1000MHz)	HP	8447D	1937A02341	Cal due 16/01/2016
Pre-amplifier (1.0-26.5GHz)	HP	8449B	3008A01077	Cal due 02/07/2016
Pink 30M-2G Antenna	CHASE	CBL 6141	4013	Cal due 01/10/2018
1-10GHz Horn	Schwarzbeck	BBHA 9120 571	571	Cal due 29/01/2016
Horn antenna (1-10GHz)	Schwarzbeck	BBHA9120B	237	Cal due 03/07/2016
2-18GHz Horn	Schwarzbeck	BBHA 9120 C	576	Cal due 28/07/2018
40GHz receiver	Rohde & Schwarz	ESIB 40 no.2	100262	Cal due 19/02/2016
CISPR 7GHz Receiver	Rohde & Schwarz	ESCI 7	100765	Cal due 12/06/2016
Spectrum analyser	HP	8593EM	3726U00203	Cal due 22/09/2016
Synthesized sweeper	HP	8341B	2819A1509	Cal due 14/10/2016
10dB pulse limiter	Rohde & Schwarz	ESH 3 Z2	08970	Cal due 26/02/2016
LISN / AMN	Rohde & Schwarz	ESH3Z5	831887/019	Cal due 11/11/2016
30MHz TD Receiver	Gauss	TDEIM30M	1506001	Cal due 19/10/2016

Table 11: Test Equipment

¹ Calibration data held by Hursley EMC Services Ltd under their UKAS accreditation, no. 1871