

PK-100N

PK-400N Service Manual

* This Service manual is subject to change according to improvement of PK-Series Portable Radio without notice.

* Version #1 (2004-11-20)

Read this information before using your product.

Acknowledging Special Precautions and the FCC Notice Cautions.

Modifications not expressly approved by the party responsible for compliance could void the user's authority to operate the equipment.

FCC compliance Information

This device complies with part 15 of FCC Rules.

Operation is subject to the following two conditions:

1. This device may not cause harmful interference, and
2. This device must accept any interference received.

Including interference that may cause undesired operation.

Information to User

This equipment has been tested and found to comply with the limits for a Class B digital device, Pursuant to part 15 of the FCC Rules. These limits are designed to provide reasonable protection against harmful interference in a residential installation.

This equipment generates, uses and can radiate radio Frequency energy and, if not installed and used in accordance with the instruction, may cause harmful interference to radio communications.

However, there is no guarantee that interference will not occur in a particular installation. If this equipment does cause harmful interference to radio or television reception, which can be determined by turning the equipment off and on, the user is encouraged to try to correct the interference by one or more of the following measures:

- > Reorient or relocate the receiving antenna.
- > Increase the separation between the equipment and receiver
- > Connect the equipment into an outlet on a circuit different from that to which the receiver is connected.

Consult the dealer or an experienced radio/TV technician for help.

1. RADIO FREQUENCY ENERGY SAFETY INFORMATION

This UNIMO transceiver has been tested and complies with the standards listed below, in regards to radio Frequency(RF) energy electromagnetic energy(EME) generated by the transceiver

- > FCC RF exposure limits for Occupational use only. RF exposure limits adopted by the FCC are generally based on recommendations from the national council on radiation protection and measurement, & the American National Standards Institute.
- > FCC OET Bulletin 65 Edition 97-01 Supplement C
- > American National Standards Institute(C95.1-1992)
- > American National Standards Institute(C95.3-1992)

WARNING

This UNIMO transceiver generates RF EME while transmitting. RF EME(Radio Frequency Electric & Magnetic Energy)has the potential to cause slight thermal, or heating effects to any part of your body less than the recommended distance from this radio transmitter's antenna.

RF energy exposure is determined primarily by the distance to and the power of the transmitting device. In general, RF exposure is minimized when the lowest possible power is used or transmission time is kept to the minimum required for consistent communications, and the greatest distance possible from the antenna to the body is maintain.

The transceiver has been designed for and is classified for Occupational use only. Occupational/controlled exposure limits are applicable to situations in which persons are exposed to RF energy as a consequence of their employment, and such persons have been made aware of the potential for exposure and can exercise control over their exposure.

This means you can use the transceiver only if you are aware of the hazards of operating a transceiver and are familiar in ways to minimize these hazards. This transceiver is not intended for use by the general public in uncontrolled environments.

Uncontrolled environment exposure limits are applicable to situations in which the general public may be exposed to RF energy ,or in which the persons who are exposed as a consequence of their employment may not be fully aware of the potential for exposure or cannot exercise control over their exposure

The following list provides you with the information required to ensure that you are aware of RF exposure and of how to operate this transceiver so that the FCC RF exposure limitations are not exceeded.

- > While transmitting(holding the PTT switch), always keep the antenna at least 2.5cm (1 inches) from your body or face ,as well as from any bystanders
- > Do not transmit for more than 50% of the total transceiver use time; transmitting over 50% of the total use time may exceed the limits in accordance to the FCC RF exposure requirements. Nominal transceiver operation is 5% transmission time,5% reception time, and 90% stand-by time
- > Use only the specified antenna for this transceiver; this may be either the antenna provided with the transceiver or another antenna authorized by UNIMO.

Use only UNIMO authorized accessories (antennas, battery packs, belt clips, Speaker/Mics or headsets etc.):

When worn on the body, always place the radio in a UNIMO recommended clip or carrying case meant for this product.

The use of other than recommended or approved body-worn accessories may result in RF exposure levels which exceed the FCC's occupational /controlled environment RF exposure limits.

CAUTION

To ensure that your exposure to RF EME is within the FCC limits for occupational use, you must observe and adhere to the above points.

Electromagnetic Interference Compatibility

Electronic devices are susceptible to electromagnetic interference(EMI)if they are not adequately shielded or designed for electromagnetic compatibility. Because this transceiver generates RF energy, it can cause interference to such equipment.

>Turn OFF your transceiver where signs are posted to do so. Hospitals and health care facilities use equipment that is sensitive to electromagnetic radiation.

> Turn OFF your transceiver while on board an aircraft when so instructed, Use of the transceiver must be in accordance with airline regulations and/or crew instructions.

2. Features

The features of PK-series are various as below. PK-series can be used under tough industrial environments as well as public places. PK series have following functions:

- PLL synthesizer method
- 256 channels and 16 groups are selectable.
- Call guard squelch of the standardized DCS/CTCSS
- Dual Tone Modulation Frequency (DTMF)
- 2/5-tone paging
- Channel interval: 12.5kHz
- Normal scanning and priority scanning
- Time-Out Timer (TOT)
- BCL/BCLO
- Paging
- Wide-band
- Easy cloning
- Various parameters and PC downloading methods
- Various accessories
- light and modern design antenna

1) Alphanumeric LCD Windows

Alphanumeric LCD Windows enable to represent any kind of expression on LCD Display.

2) Caller ID (Paging Feature)

PK-series have a Caller ID Function that is usually used in the TRS Radio to maximize communication efficiency and convenience. The caller's ID is displayed on the right bottom on screen..

3) Enhanced Functionality

The microprocessor has been installed to implement various Enhanced features allowing users to choose them through the menu.

4) Improved Convenience

The radio has been designed suitable for the professional users. Under the base of powerful speaker, it is possible to express clean sound. (PK-series: 127mm)

5) Window Display

The Window LCD of PK-series (Size 21 × 12mm) allows users to identify channels and other data easily under any working environment or condition.

6) 256 Channels and 16 Groups Selectable

Users can use various tones with 47 CTCSS and 83 DCS . 256 channels can be divided into 16 groups so that users can make group for other users and page each group.

7) Multi-functional Ear/MIC Jack

With multi-functional Ear/MIC Jack, it is possible to be used together with various accessories.

8) Cloning

For compatibility with current models of UNIMO, the data of those models (such as channels, tones, 5-tone ID, etc.) are cloned to another radio with Cloning cable. .

9) Improved Security

Security features like Key Lock and Password will prevent and avoid misuse of the radio by unqualified people in case the radio is stolen or lost.

1.1 Part Number Breakdown

The following is a breakdown of the part number used to identify this transceiver

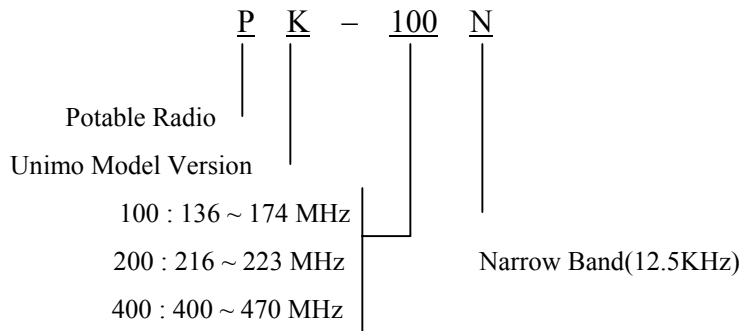

3. Appearance

3.1 Appearance of the PK-series Product

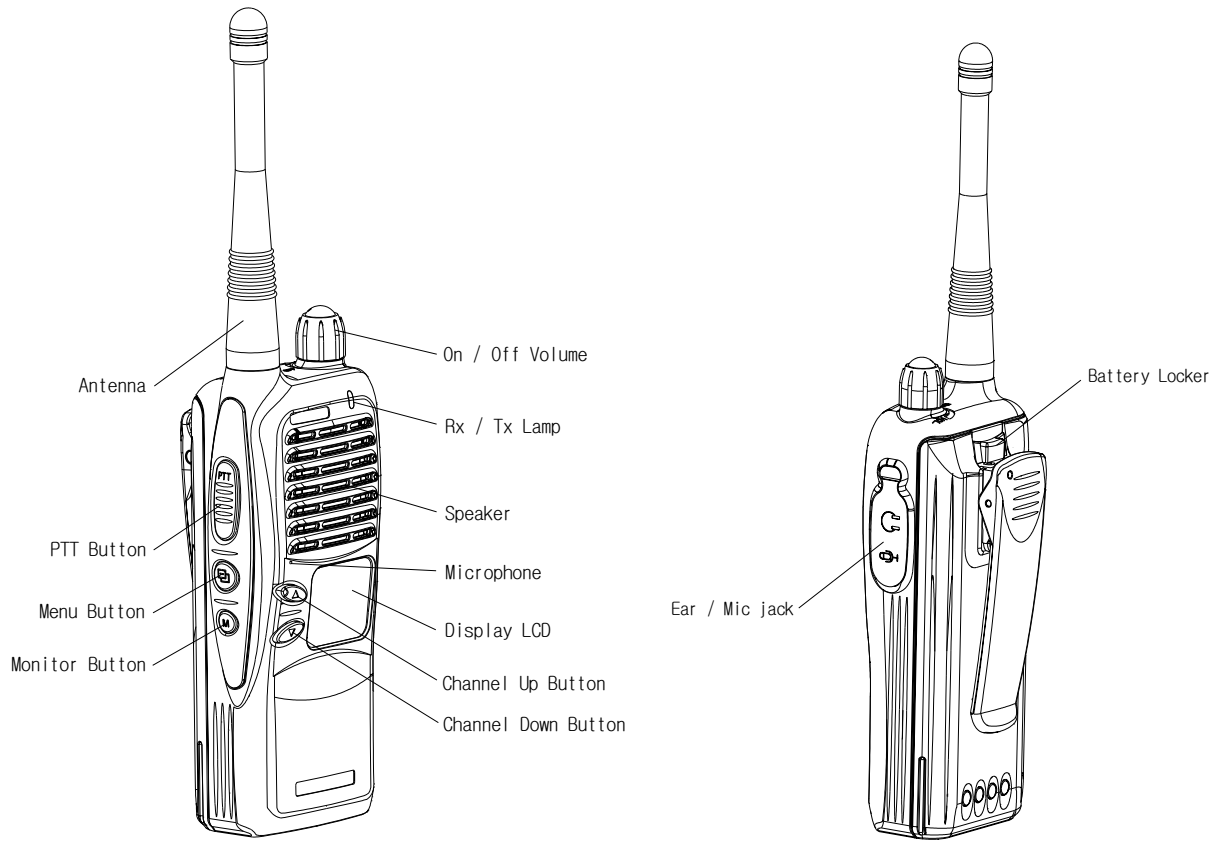

Figure 3.1. Appearance of the PK-series Product

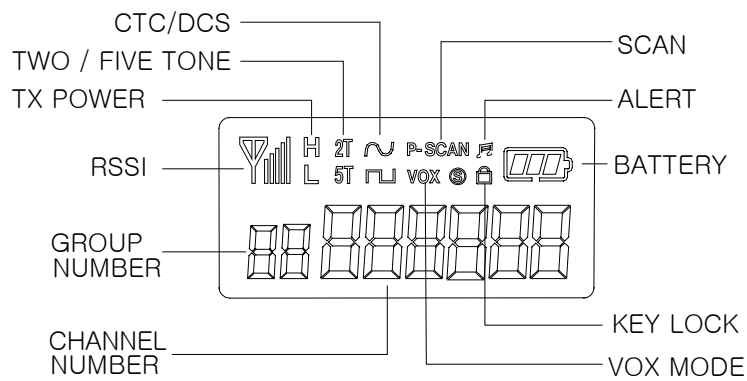

Figure 3.2. LCD of the PK-series Product

4. Basic Operation of PK-series Products

4.1 Installation and Removing the Antenna

1) Installation the Antenna

Insert the antenna screw into the antenna hole, and screw the antenna clockwise.

2) Removing the Antenna

To remove the antenna, screw the antenna counterclockwise.

4.2 Installation and Removing PK-series Batteries

1) Inserting and Removing the Battery

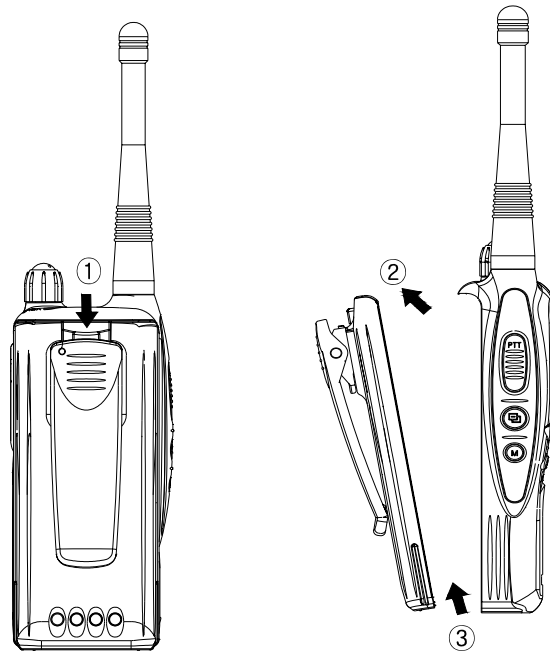

Figure 4.1. Installing and Removing PK-series Product Batteries

4.3 The Radio disassembling method

First, please remove the battery, Volume Knob and Antenna.

And please pull up Ear Phone Jack Cover with hands.

As showing picture as below, stick to the bottom holes by using Jig.

By moving up Jig and pull it to the direction of disassembling.

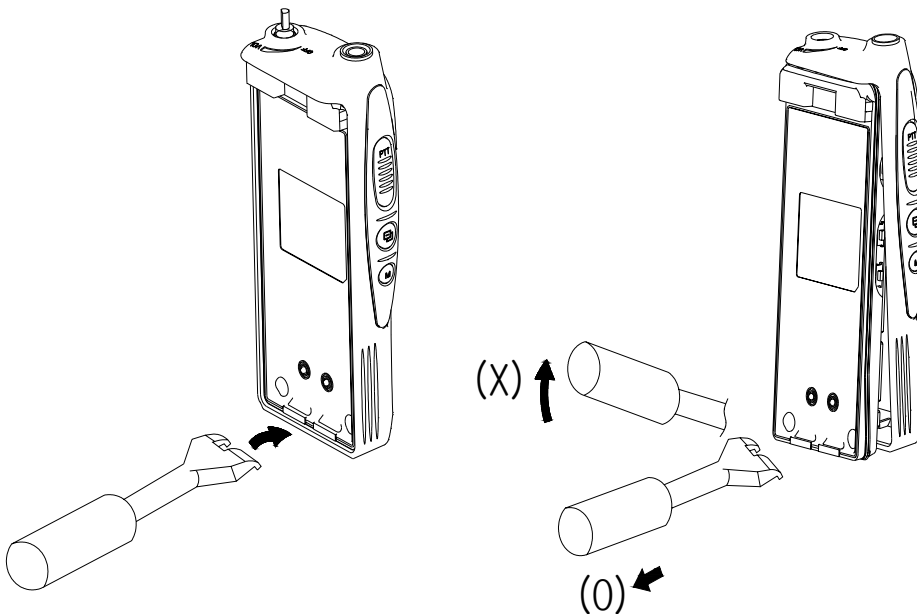

Figure 4.2. Radio disassembling method

4.4 Charging the Battery

1) Safety Notes

- 1) The radio of UNIMO Technology receives power from high-performance Li-ion battery (only for PK Series) or Ni-MH battery. The battery of UNIMO is safe, of high-performance, and highly reliable, and could be charged very fast. Correct using the battery will improve the efficiency and life of the battery.
- 2) Please charge the battery before using the radio for best performance and safety.
- 3) This battery has been designed suitable only for the chargers of UNIMO. So, please don't use for the other manufacturer's charger. Since it will result in damage of the battery and the radio.
- 4) When you charge the battery that is installed in the radio, please turn off the radio first to charge the battery.

⚠ Caution) Continued fast discharging (for example, when positive and negative poles of the battery are shorted by metallic objects) will result in critical damage in the battery or may lead to explosion of the battery or a fire.

2) The time of Charging

Low battery voltage will make the radio less coverage and also make worse the performance. Please charge the battery in case of following:

- ① When the battery has lower performance after being used around 6 ~ 8 hours
- ② When the red lamp on the front panel blinks (every 0.5 second) during transmission or reception
- ③ When the battery icon blinks
- ④ When “beep” sound is generated every 10 seconds while the radio is in use

3) How to Charge

- ① As soon as power is supplied to the charger, two lamps will be turned on and off soon.
- ② Before charging the battery with the radio, turn off the radio and then insert the radio into the charger.
- ③ In case of Dual Charger (CH-200NW): The front slot has the priority. While the battery in the front slot is being charged, the other battery in the rear slot will stand by and will be fast-charged only after the battery in the front lost is fully charged. If the user removes a battery being charged from the charger, the other battery in standby state will start to be fast-charged.
- ④ Although the green lamp is on after the battery is fully charged, the microprocessor keeps checking the battery status and charges the battery, if necessary.

4) Charger

The charger shown in the following figure is only for PK Series built in microprocessors:

CHK-170FB(Li-ion) / CHJ-165FB (NiMH)



Figure 4.2. Appearance of CHK-170FB/ CHJ-165FB Charger For PK Series

Input Voltage	Adapter DC 12V 1000mA
Battery	PBJ-6165NB
Fast Charging Time	In 100 minutes / In 10 hours
Operating Temperature	0℃ ~ +40℃
Size	110 (W) x 110 (D) x 41 (H) m/m
Charging Current	1000mA

5. Operating Instructions of PK-Series Radio

5.1 Power On/Off

Turn Power switch clockwise. As soon as power is supplied, the backlight will be turned on. If the user had set up the user ID and the name, they will be displayed on the LCD and the radio will enter into the latest state as a signal sound is generated.

⚠ Caution) When turning (power) on the radio by pressing a button on it, the radio may enter into a special modes like a program mode, tune mode or clone mode in which transmission and reception is impossible. Please don't turn on the radio by above way.

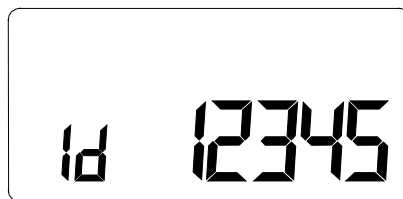

Figure 5.1 User ID and Name

5.2 Transmission Method

For transmission, press PTT button on the left side of the radio. As soon as the user presses keys according to the setting, DTMF or 5-tone ID will be transmitted, and during this time, voice communication will be interrupted for several seconds. Then, red LEDs for transmission and reception will be turned on. It is recommended to talk 5 ~ 10cm away from the microphone for the best voice communication.

⚠ Note: If the user makes transmission for more than a certain time while BCLO or TOT feature is on, transmission will be forcefully disconnected for other users.

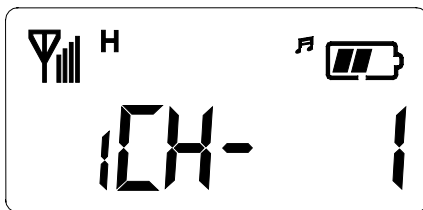

Figure 5.2 Reception Screen

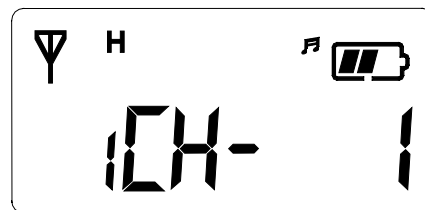

Figure 5.3 Transmission Screen

5.3 Reception Method

The user should not press PTT button during the reception. The user can adjust the volume by Power (Volume) switch, and during reception, the green LED will be turned on. Depending on conditions of the transmitting radio, DTMF or 5-tone sound is generated, and sometimes, the caller's name is displayed. (Refer to Caller ID Mode [Paging mode.]) Also, an antenna-shaped symbol is displayed on the LCD to show the Received Signal Strength

Indicator (RSSI). If the communication conditions is poor or the tone (CTCSS/DCS) is not the same even though the frequency is the same, the user needs to press Monitor button (M) on the left side of the radio to receive all signals of the current channel. However, if the user presses Monitor button (M) under normal circumstances, the user will only hear noise. To keep this feature on, the user needs to presses Monitor button for a while (2 seconds). Then, “beep” sound will be generated and the function will be activated. To cancel this function, the user needs to press Monitor button (M) shortly.

5.4 Changing Channels

Channel buttons (▲ and ▼) are to change channels. Press Up button (▲). Then, “beep” sound will be generated and the channel number will be increased. Or press Down button (▼) to decrease the channel. If the user presses Up or Down button while only one channel is set, the channel will not be changed and a different sound from “beep” will be generated. For fast increase or decrease channel numbers, press Channel buttons (▲ and ▼) for a while. In this case, however, “beep” sound will not be generated.

5.5 Adjusting the Transmission Power

The user can change the transmission power – High Power or Low Power. By pressing Up button (▲) while PTT button is being pressed, the user can select “H” (High Power), or by pressing Down button (▼), the user can select “L” (Low Power). By selecting Low power under good communication conditions, the user can extend the battery use time.



Figure 5.4 High Power

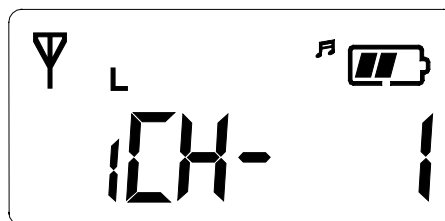

Figure 5.5 Low Power

5.6 Scan

By pressing “Menu” and “▼” buttons in order within 0.5 second in Standby mode, the user can activate Scan function. After Scan function is activated, the radio will automatically search channels and detect a channel corresponding to the frequency. To deactivate Scan function, press “M” button once.

5.7 Key Lock

Press “Menu” button and press Up key (▲) within 0.8 second. Then, the key will be locked. Or to unlock the key, press “Menu” button and Up key (▲) within 0.8 second.

5.8 Selective Call (Paging)

In Selective Call mode (Paging mode), the user can call individuals and groups through the 5-tone ID. Each Selective Call memory (paging memory) stores up to 30 IDs and names. The user should set the paging memory and the 5-tone environment in the PC program. To enter into Selective Call (Paging mode), press “Menu” and “M” button , and to go back to Normal mode, press “Menu” button for two seconds in Selective Call (Paging mode). By pressing Channel buttons (▲ and ▼) in Selective mode (Paging mode), the user can view the number of the currently available channel.

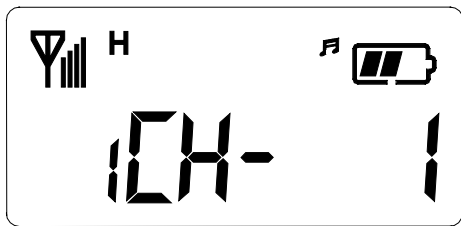

Figure 5.6 Normal Mode

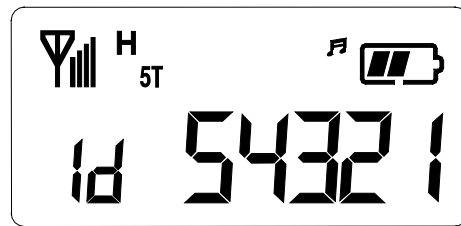

Figure 5.7 Paging Mode

1) One-to-one (1:1) Selective Call Mode (Paging Mode)

- ① Enter into Selective Call (Paging mode) by pressing press “Menu” and “M” button for a while in Normal mode.
- ② Select the other person’s tone number by pressing Channel buttons (▲ and ▼). For example, if TOMMY wants to call JOHN, TOMMY needs to select JOHN’s tone number by pressing Channel buttons (▲ and ▼) in Selective Call Mode (JOHN’s tone number : 12345, TOMMY’s tone number : 54321).
- ③ And then if TOMMY presses “Menu” button , JOHN will be called. At the same time, on John’s radio, his number will be displayed. Although John’s radio is in Normal mode, it will enter into paging mode automatically as soon as a call arrives.

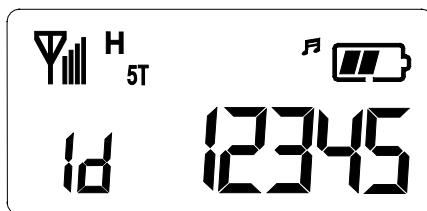

Figure 5.8 TOMMY Calling JOHN

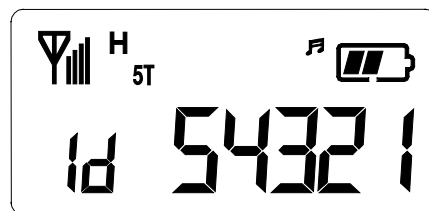

Figure 5.9 JHON Receiving the Call

2) One-to-one (1:1) Calling in Selective Call Model (Paging Mode)

- ① After entering into Selective Call (Paging mode), select the other person’s name to call by pressing Channel buttons (▲ and ▼).
- ② Press transmission PTT button to send the other person’s ID first.

- ③ Only the radio which is in the status of selective call and receive the same ID with its own could receive the audio signal

3) Group (1:N) Call in Selective Call Mode (Paging Mode)

- ① To call a group in Selective Call Mode (Paging mode), the user needs to set the group in the PC program as follows:
- ② If JOHN (13579) and JANE (12468) belong to one group, allocate a paging number (1AAAA) and a name (COMPANY) to the group. (“A” represents All and can be any number.)
- ③ For example, if JOHN calls all people in COMPANY group, he needs to select “COMPANY” and “1AAAA” on his radio and press “Menu” button. In this case, on a receiver’s radio transceiver, “COMPANY” and “1AAAA” will be displayed. In other words, during group paging, the group name and the group number will be displayed on the called party’s radio.

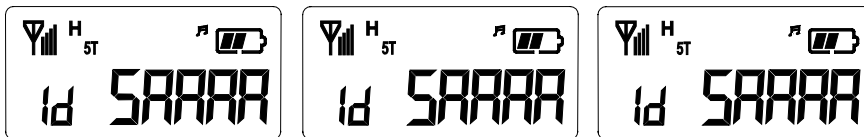

Figure 5.10 Group Paging

4) Group (1:N) Calling in Selective Call Mode (Paging Mode)

Group calling in Paging mode is possible in the same way as group paging.

5.9 Cloning

Cloning function is to clone the data such as frequency, tones, and scanning of one radio to the other radios.

* Cloning Method

- ① Prepare a Cloning cable (PFCLONA) which is manufactured by UNIMO Technology.
(* Available in branch offices and sales agencies of UNIMO.)
- ② Turn on the radio while pressing PTT button, and turn on the target radio while pressing “Menu” button.
- ③ “Clone Mode” will be displayed on the radio while “Program Mode” will be displayed on the target radio .
- ④ Connect the cloning cable to Ear/MIC jacks of two radios.
- ⑤ Press “Menu” button of the radio to start to clone the data. After cloning the data, disconnect the cable and turn off two radio and turn them on again. Check if cloning has been made successfully before operating two radios.

⚠ Caution) Cloning the data to an unauthorized radio is subject to a penalty by Radio Waves Act.

5.10 Menu Description

Enter into Menu mode by pressing “Menu” button for two seconds. There are nine menus. By setting menus according to user’s preference, the user can operate the radio more conveniently.

⚠ Notes) In Menu mode, transmission and reception is not possible. Please quickly select a menu when the radio

is not used.

5.11 Change Groups

The radio of UNIMO have total 256 channels with 16 groups, and the user can set each group and channel by the PC program or by the menus.

- ① Enter into Menu mode.
- ② Select “Group” by pressing Channel buttons (▲ and ▼), and press “Menu”. Then, the message of the selected group will be displayed.
- ③ Change the group by pressing Channel buttons (▲ and ▼), and save the changed group by pressing “Menu” button.
- ④ Exit Menu mode by pressing “M”s button.

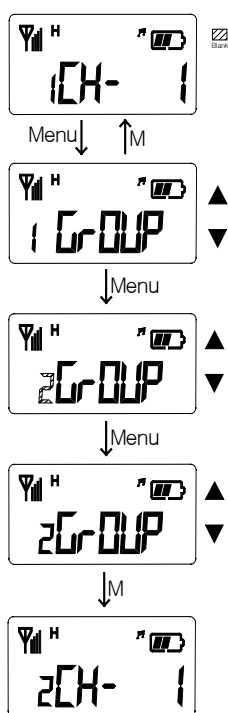

Figure 5.12 Change Group

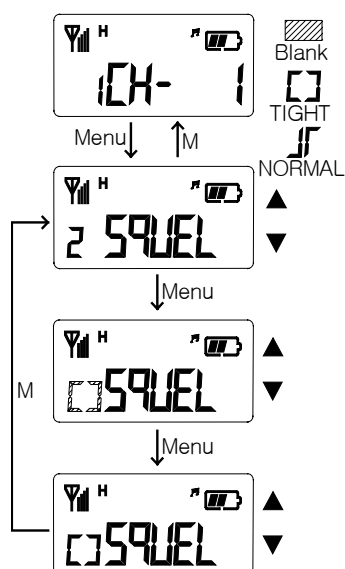

Figure 5.13 Set Squelch

5.12 Set Squelch

Select the squelch sensitivity – Normal or Tight – in order to control feeble reception signals and noise.

- ① Enter into Menu mode.
- ② Select “Squelch” by pressing Channel buttons (▲ and ▼), and press “Menu” button. Then, the message of the squelch sensitivity will be displayed.
- ③ Select the squelch sensitivity – Normal or Tight – by pressing Channel buttons (▲ and ▼), and save the selected sensitivity by pressing “Menu” button.
- ④ Exit Menu mode by pressing “M”s button.

5.13 ID Display

ID Display function is to send the caller's ID and it display Caller's ID on the called person's radio. The ID is mainly divided into DTMF and 5 tones. Especially, 5 tones are to send the caller's ID to the other person's radio and display the caller's ID on the called person's radio for convenient and efficient use of the radio.

- ① Enter into Menu mode.
- ② Select "Id" by pressing Channel buttons (▲ and ▼) and press "Menu" button. Then, the DTMF ANI("d-tone") or 5-tone ANI ("5-tone") by pressing Channel buttons (▲ and ▼) and press "Menu" button.
- ③ Select On or Off by pressing Channel buttons (▲ and ▼) and save the selected status by pressing "Menu" button.
- ④ Exit Menu mode by pressing "E"s button.

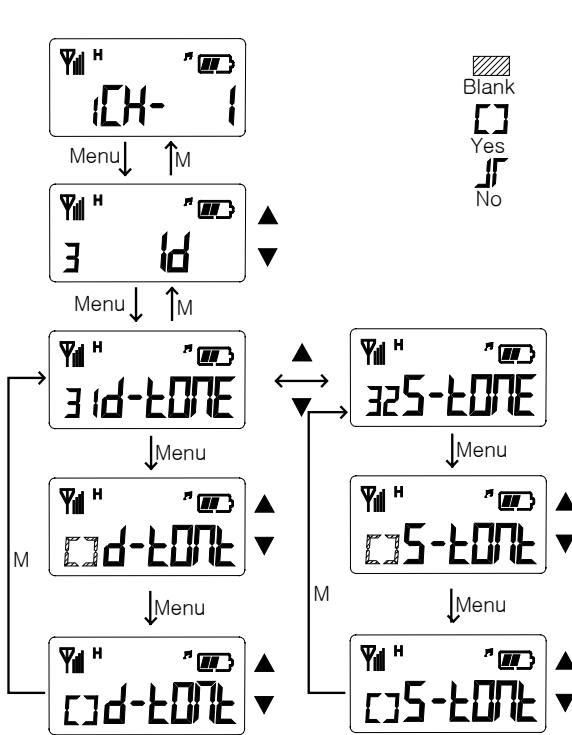

Figure 5.14 ID ANI

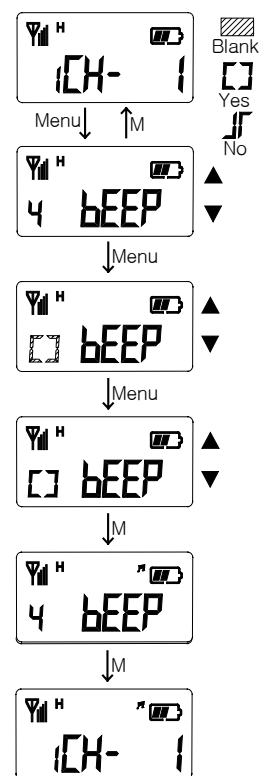

Figure 5.15

KET TONE

5.14 Set Key Tone

Set Key Tone menu is to decide whether to generate sound or not when the user presses four buttons on the front side of the radio

- ① Enter into Menu mode.
- ② Select "Beep" by pressing Channel buttons (▲ and ▼) and press "Menu". Then, Key Pressing Sound message will be displayed.
- ③ Select On or Off by pressing Channel buttons (▲ and ▼), and save the selected status by pressing "Menu" button.

- ④ Exit Menu mode by pressing “M”s button. Select “Off”. Then, the bell symbol will disappear on the LCD.

5.15 Scan

Scan is to search channels registered in the scan list and let the radio select the channel automatically in which a signal is received. To use Scan menu, the user first needs to set the scanning feature for the corresponding channel in the PC program:

- ① Enter into Menu mode.
- ② Select “Scan” by pressing Channel buttons (▲ and ▼) and press “Menu” button. Then, the scan list and Priority Channel message will be displayed.
- ③ Select the scan list by pressing Channel buttons (▲ and ▼) and “Menu” button. After the user selects the scan list, all channels of the communication groups will be displayed.
- ④ In default, “O” (Scan) is set in all channels. By pressing “M”, the user can delete a channel from the scan list, and in this case, “No” will be changed into “/”.
- ⑤ After setting a scan list, press “M”. Then, the scan list and Prior Channel message will be displayed.
- ⑥ Select a priority channel by pressing Channel buttons (▲ and ▼) and press “Menu” button. The user can select two higher channels as priority channels. After “P - CH” is displayed, press “Menu” button. Select a channel by pressing Channel buttons and press “Menu” button. Then, “P1” will be displayed next to the corresponding button. Or to delete the channel, press “Menu” again. Then, “P1” will disappear.
- ⑦ Select a channel in the same way as Priority Channel 1. After selecting the priority channel, press “PTT” button. Then, “P2” will be displayed. Exit the menu mode by pressing “M” button.

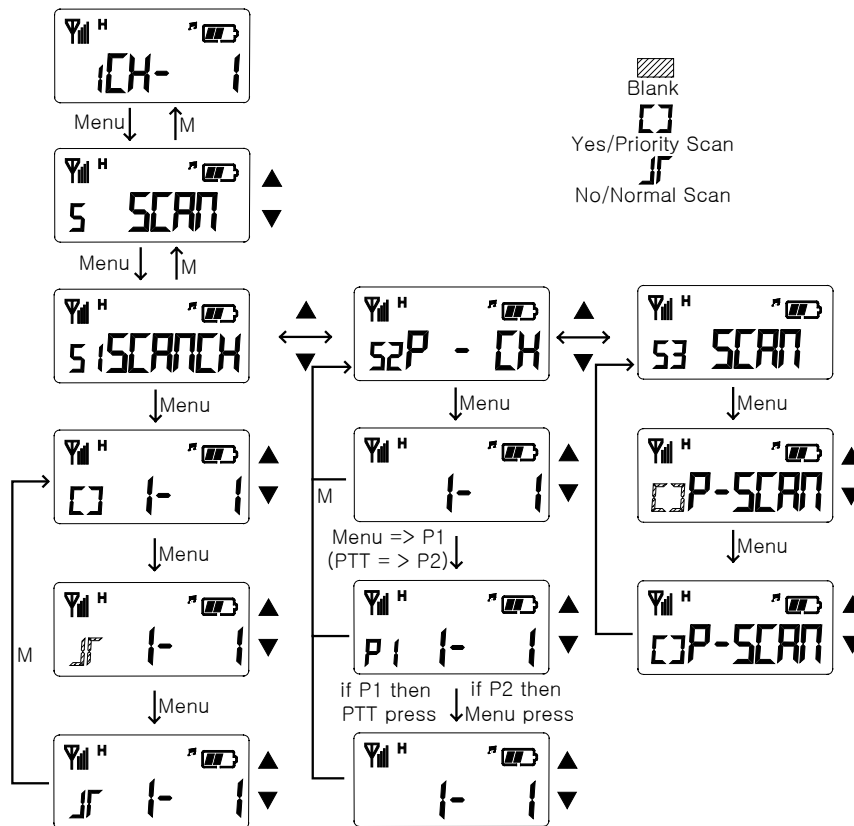

Figure 5.16 SET SCAN

5.16 Set Key Lock

Set Key Lock menu avoids 3 buttons(Menu, ▲ and ▼) is functioned by undesired pressing.

After setting Key Lock menu, all buttons will not be functioned by pressing buttons.

- ① Enter into Menu mode.
- ② Select “Lock” by pressing Channel buttons (▲ and ▼) and press “Menu”. Then, Key Pressing Lock message will be displayed.
- ③ Select On or Off by pressing Channel buttons (▲ and ▼), and save the selected status by pressing “Menu” button.
- ④ Exit Menu mode by pressing “M”s button. Select “Off”. Then, the bell symbol will disappear on the LCD.

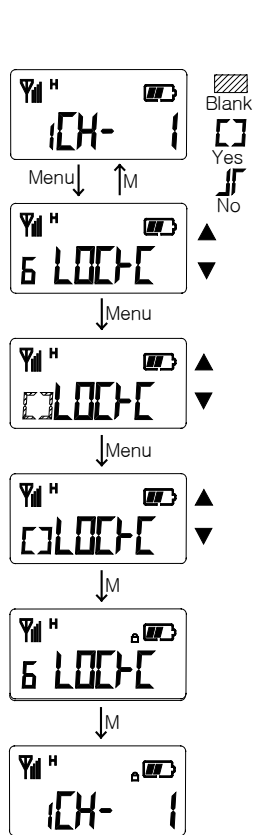

Figure 5.18 SET Key Lock

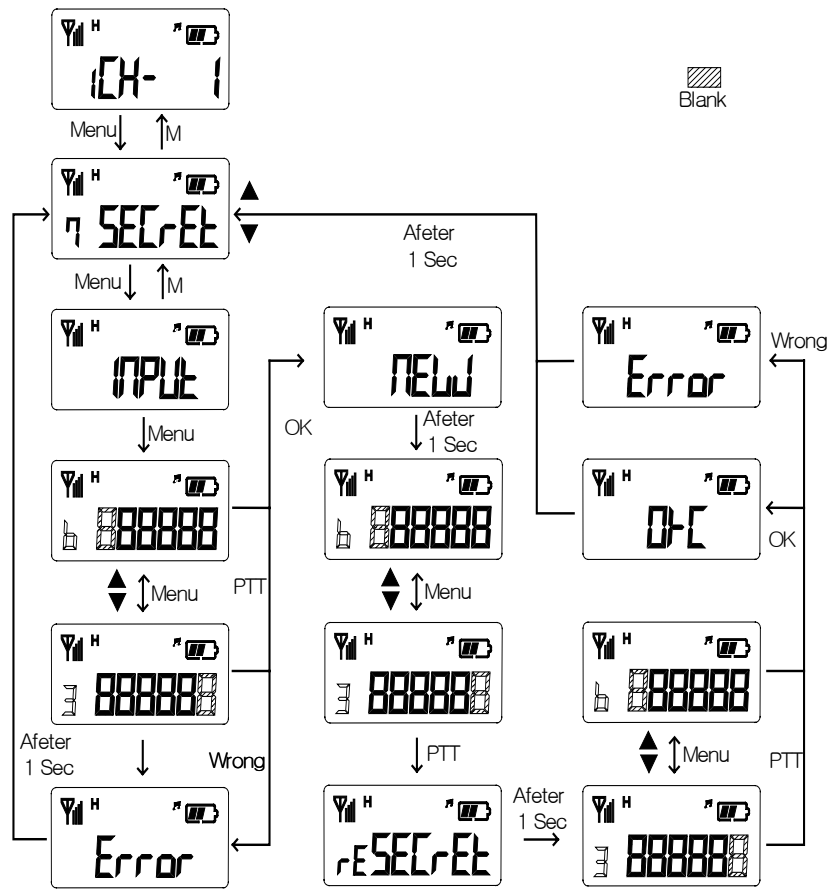

Figure 5.18 SET PASSW

5.17 Set Password

Set Password is to prevent the other people from using the radio by setting a password. The user should type in the correct password to use the radio.

- ① Enter into Menu mode.
 - ② Select “Secret” by pressing Channel buttons (▲ and ▼) and press “**Menu**” button. Then, “New Password” will be displayed. Or if the user had set the password already, Password will be displayed. The user can set a password in maximum 6 digits by using four buttons(▲, ▼, **PTT**, **Menu**)
 - ③ When the user presses a button, “**8**” will be displayed. After pressing the password, press Monitor button on left side of the radio. If the password is of 6 digits, the user must press “**PTT**” button after pressing the password.
 - ④ If “Confirm the password” is displayed, type in the new password again. If the users types in a wrong password, “Error” will be displayed and user’s password input will be cancelled.
 - ⑤ If the user had set the password, the user can change the password only after typing in the correct password.
 - ⑥ When “New Password” is displayed while the user is trying to delete the password, press “**PTT**” button on left side of the radio twice.
 - ⑦ Exit Menu mode by pressing “**M**” button after typing in the password.
- ⚠Caution) If the user forgot the password, the user cannot use the radio and need to contact the service center of Unimo. Do not forget the password.

5.18 Forbid Tx

Forbid Tx is to forbid transmission forcefully and allow the radio only to receive calls.

- ① Enter into Menu mode.
- ② Select “Forbid” by pressing Channel buttons (▲ and ▼) and press “**Menu**” button
- ③ Select the status – On or Off – by pressing Channel buttons (▲ and ▼).

5.19 Set VOX

Set VOX is to enable users to make transmission for VOX without pressing PTT button. (This function could be available with Ear Mic [External VOX]).

- ① Enter into Menu mode.
- ② Select “VOX” by pressing Channel buttons (▲ and ▼) and press “**Menu**”. Then, two menus – VOX and Sense – will be displayed.
- ③ Select “VOX” by pressing Channel buttons (▲ and ▼). Press “**Menu**” button. Then, the user can decide whether to turn on the VOX mode or not. Select “On” by pressing Channel buttons (▲ and ▼). Then, the menu by pressing “**Menu**” . exit “**M**” buttons. The radio transceiver will operate in the VOX mode.
- ④ To set the VOX sensitivity, enter into Menu mode and select “Sense”. Then, select the VOX sensitivity by pressing Channel buttons, and then, the menu by pressing “**Menu**” . exit “**M**” buttons.

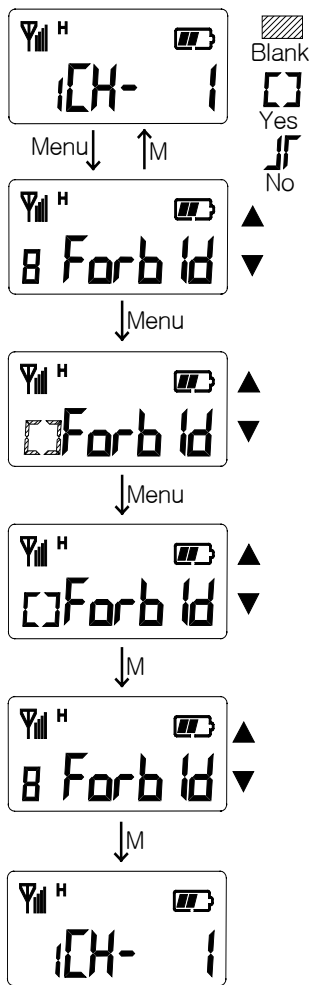

Figure 5.18 SET Forbid Tx

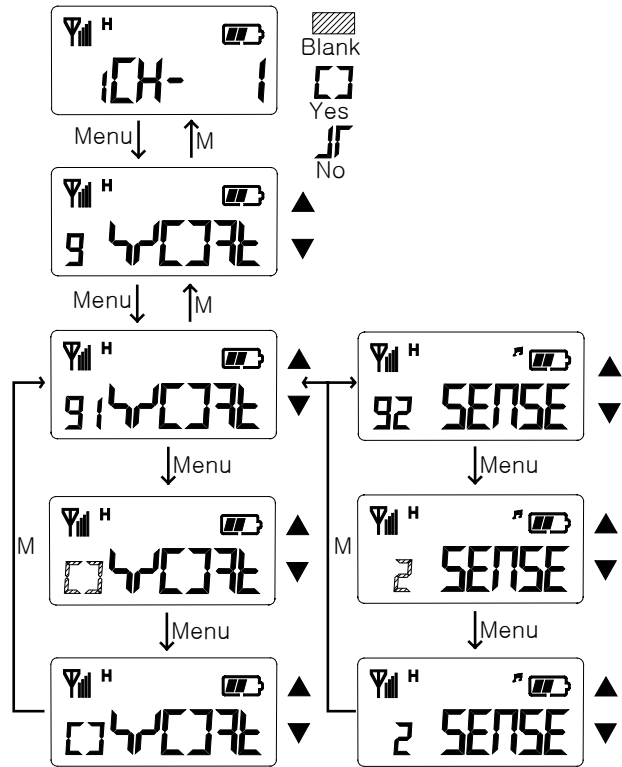

Figure 5.18 SET VOX

6. Sub-tone Table

6.1 CTCSS Frequency Table

No.	Frequency	No.	Frequency	No.	Frequency
001	67.0	017	118.8	033	210.7
002	71.9	018	123.0	034	218.1
003	74.4	019	127.3	035	225.7
004	77.0	020	131.8	036	233.6
005	79.7	021	136.5	037	241.8
006	82.5	022	141.3	038	250.3
007	85.4	023	146.2	039	69.3
008	88.5	024	151.4	040	159.8
009	91.5	025	156.7	041	183.5
010	94.8	026	162.2	042	189.9
011	97.4	027	167.9	043	196.6
012	100.0	028	173.8	044	199.5
013	103.5	029	179.9	045	206.5
014	107.2	030	186.2	046	229.1
015	110.9	031	192.8	047	254.1
016	114.8	032	203.5		

Table 6-1. CTCSS Frequency Table

6.2 DCS Tone Table

No.	DCS Code	No.	DCS Code	No.	DCS Code
01	023	29	174	57	445
02	025	30	205	58	464
03	026	31	223	59	465
04	031	32	226	60	466
05	032	33	243	61	503
06	043	34	244	62	506
07	047	35	245	63	516
08	051	36	251	64	532
09	054	37	261	65	546
10	065	38	263	66	565
11	071	39	265	67	606
12	072	40	271	68	612
13	073	41	306	69	624
14	074	42	311	70	627
15	114	43	315	71	631
16	115	44	331	72	632

17	116	45	343	73	654
18	125	46	346	74	662
19	131	47	351	75	664
20	132	48	364	76	703
21	134	49	365	77	712
22	143	50	371	78	723
23	152	51	411	79	731
24	155	52	412	80	732
25	156	53	413	81	734
26	162	54	423	82	743
27	165	55	431	83	754
28	172	56	432		

Table 6-2. CDCSS Frequency Table

6.3 5-tone Table

CODE	ZVEI	CCIR	EEA	PZVEI	DZVEI	PCCIR	PDZVEI	NATAL
0	2400	1981	1981	2400	2200	1981	2200	1633
1	1060	1124	1124	1060	970	1124	970	631
2	1160	1197	1197	1160	1060	1197	1060	697
3	1270	1275	1275	1270	1160	1275	1160	770
4	1400	1358	1358	1400	1270	1358	1270	852
5	1530	1446	1446	1530	1400	1446	1400	941
6	1670	1540	1540	1670	1530	1540	1530	1040
7	1830	1640	1640	1830	1670	1640	1670	1209
8	2000	1747	1747	2000	1830	1747	1830	1336
9	2200	1860	1860	2200	2000	1860	2000	1477
A	2800	2400	2400	970	2600	1050	825	2600
B	810	930	930	810	886	930	886	1995
C	970	2247	2247	2800	586	2400	2600	2205
D	886	991	991	886	810	991	856	2400
E	2600	2110	2110	2600	2400	2110	2400	1805

Table 6-3. 5-tone Frequency Table

7. Specification

7.1 PK-100N

Operating Mode	Conventional (non-trunked) only
Frequency Range	VHF: 136 ~ 174 MHz
Frequency Stability	±2.5PPM (-30 to +60 °C)
Programmable Channels	128 Channels/16 Group
Channel Spacing	Dual Channel Spacing 12.5KHz
Dimensions	111mm (H)×54mm (W)×37mm (D)
Weight	347g (with Battery pack & Antenna)
Power Source	7.5V DC rechargeable Ni-MH 1650mA battery pack 7.5V DC rechargeable Li-ion 1700mA battery pack
Current Drain (maximum)	Receive mode, rated audio out - 340mA (Audio Max) Transmit mode - 1.8AH Standby mode - 55mAH

General

Sensitivity	.282uV 12 dB SINAD
Squelch Sensitivity	.25uV 10dB SINAD
Selectivity	60dB (12.5KHz)
Spurious and Harmonic Rejection	70dB
Inter-modulation	60dB
FM Hum and Noise	40dB
Maximum Frequency Spread	38MHz
Audio Output Power	1 Watt across an 16-ohm load
Audio Distortion	Less than 5% at rated output
Audio Response	+1, -3 dB from 6dB per octave de-emphasis Characteristic from 300 ~ 3000Hz
Speaker Impedance	16 ohms
IF Frequencies	21.4MHz and 455KHz
Input Impedance	50 ohms

Receiver

Transmitter

RF Power Output	5/1Watt
Spurious and Harmonic	65dB
FM Hum and Noise	40dB
Audio Distortion	5% maximum with 1KHz modulation
Audio Frequency Response	+1, -3dB from 6dB per octave pre-emphasis Characteristic from 300 ~ 3000Hz
Maximum Channel Spread	38MHz
Output Impedance	50 ohms

7.2 PK-400N

Operating Mode	Conventional (non-trunked) only
Frequency Range	UHF: 400 ~ 470 MHz
Frequency Stability	±2.5PPM (-30 to +60°C)
Programmable Channels	128 Channels/16 Group
Channel Spacing	Dual Channel Spacing 12.5KHz
Dimensions	111mm (H)×54mm (W)×37mm (D)
Weight	347g (with Battery pack & Antenna)
Power Source	7.5V DC rechargeable Ni-MH 1650mA battery pack
]	7.5V DC rechargeable Li-ion 1700mA battery pack
Current Drain (maximum)	Receive mode, rated audio out - 340mA (Audio Max)
	Transmit mode - 1.8AH
	Standby mode - 55mAH

General

Receiver

Sensitivity	.282uV 12 dB SINAD
Squelch Sensitivity	.25uV 10dB SINAD
Selectivity	60dB
Spurious and Harmonic Rejection	70dB
Inter-modulation	60dB
FM Hum and Noise	40dB
Maximum Frequency Spread	40MHz
Audio Output Power	1 Watt across an 16-ohm load
Audio Distortion	Less than 5% at rated output
Audio Response	+1, -3 dB from 6dB per octave de-emphasis Characteristic from 300 ~ 3000Hz
Speaker Impedance	16 ohms
IF Frequencies	45.3MHz and 455KHz
Input Impedance	50 ohms

Transmitter

RF Power Output	4/1Watt
Spurious and Harmonic	65dB
FM Hum and Noise	40dB
Audio Distortion	5% maximum with 1KHz modulation
Audio Frequency Response	+1, -3dB from 6dB per octave pre-emphasis Characteristic from 300 ~ 3000Hz
Maximum Channel Spread	40MHz
Output Impedance	50 ohms

8. Troubleshooting Flow

8.1 Reception Trouble

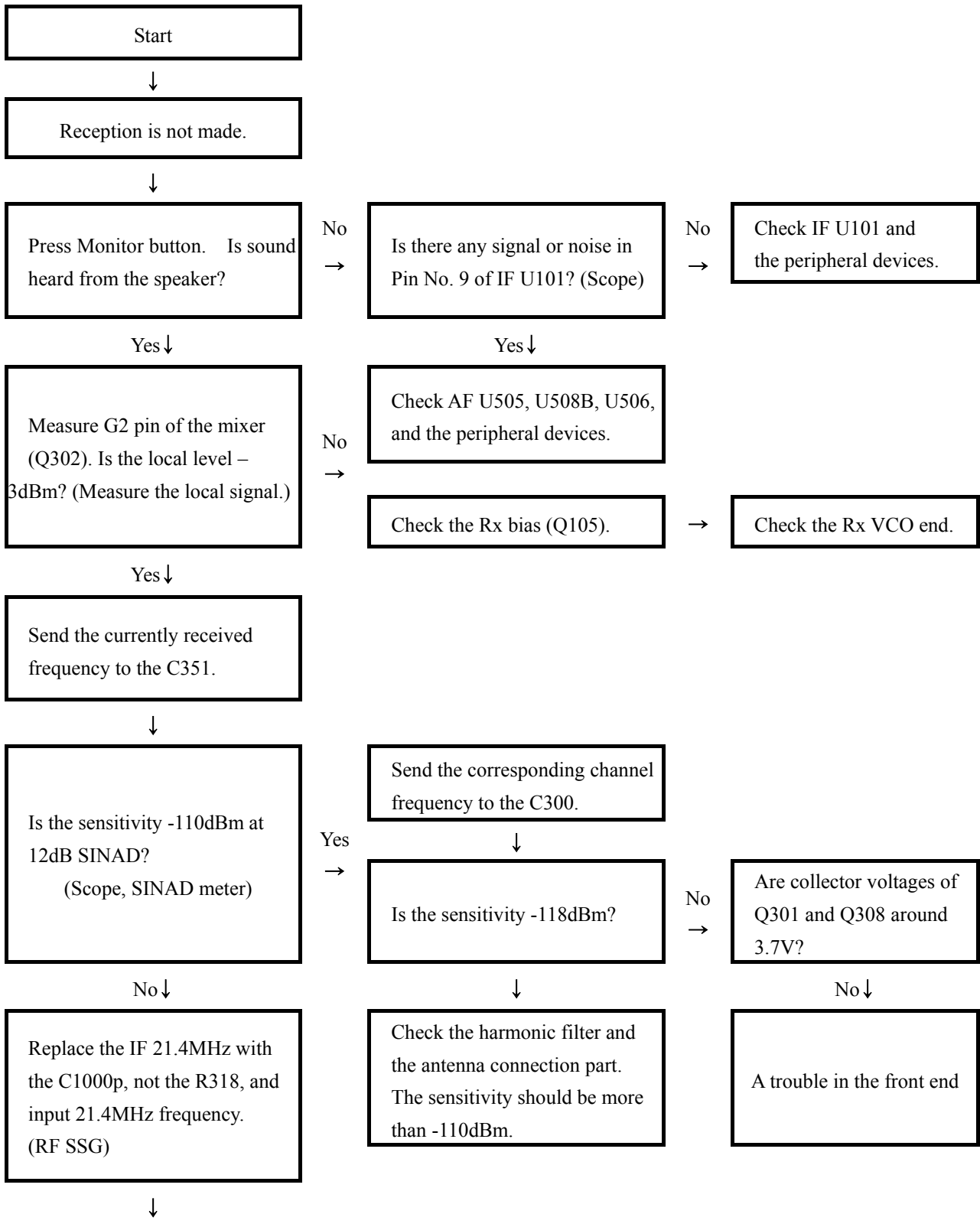

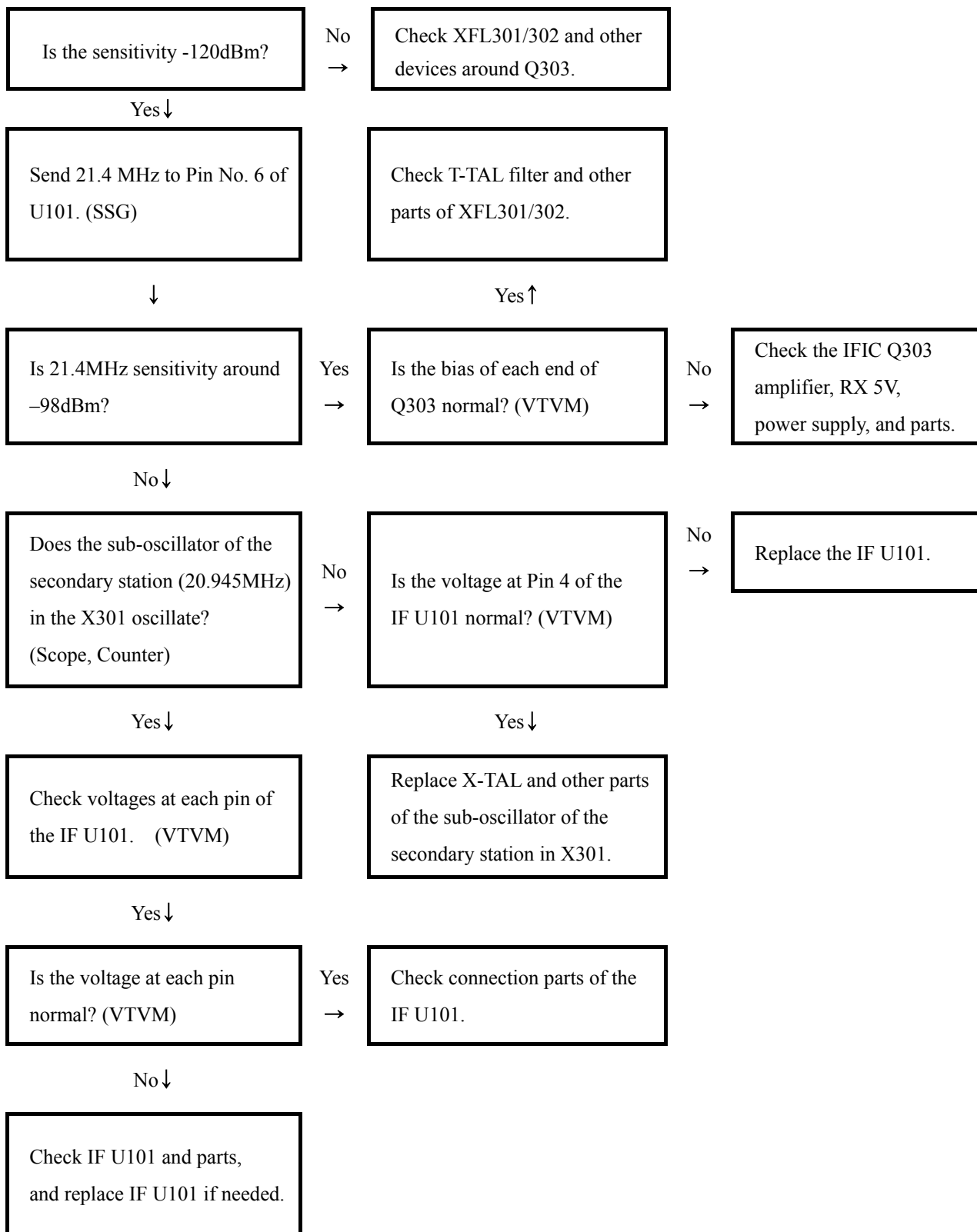

8.2 Transmission Trouble

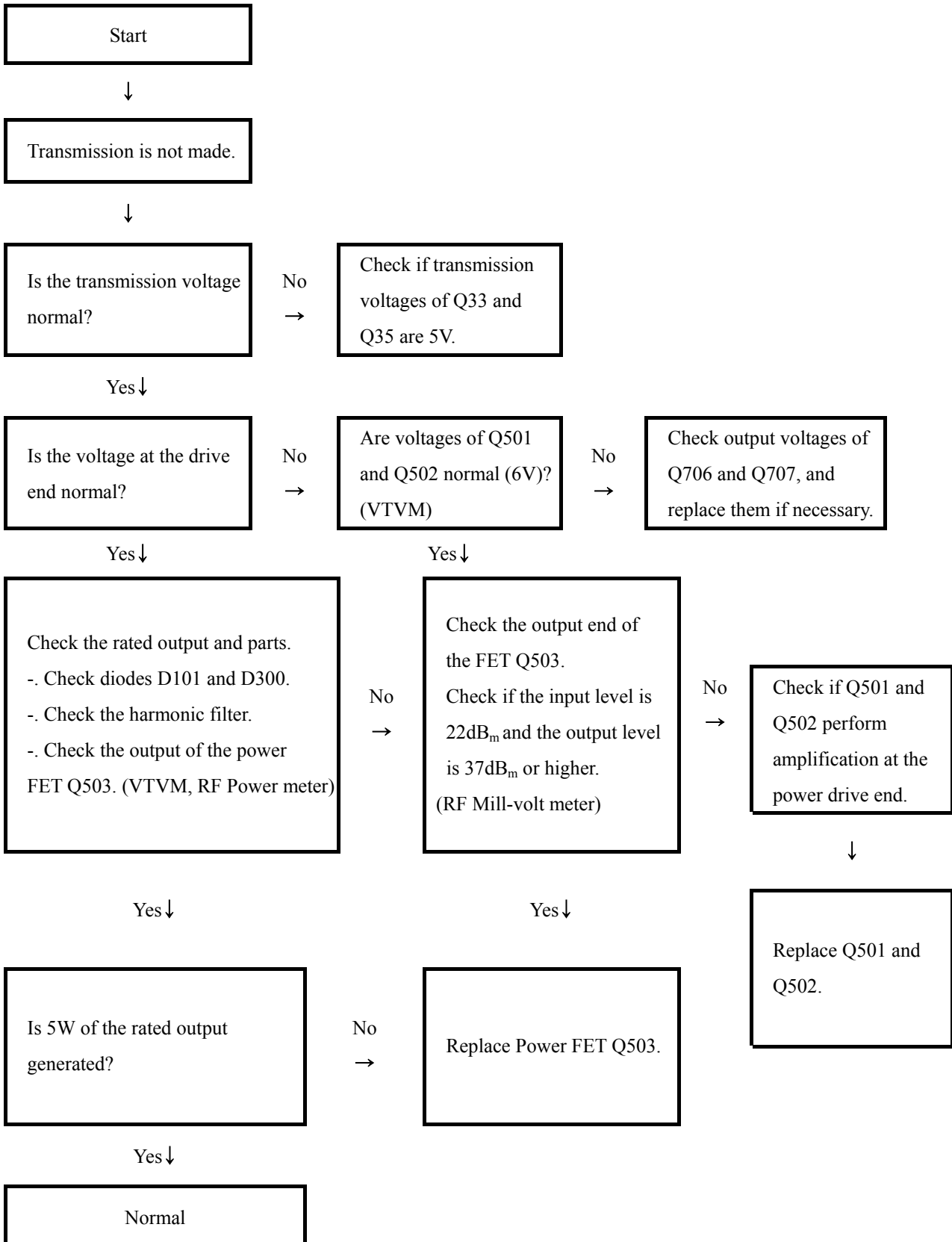

8.3 VCO Trouble

Rx VCO

Check the VCO control voltage (L151) when the VCO output (C148) level is low or zero.



Carefully disassemble the VCO shield can, and perform visual inspection. Is the VCO shield can normal?

No
→

Take proper actions.

Yes ↓

Are bias voltages of Q102 and Q104 normal?

No
→

Check parts of the power supply circuits of Q33 and Q34.

Yes ↓

Check if the bias voltage of the C130 is 5V. (VTVM)

No
→

Check devices around Q33, Q34, and U601.

Yes ↓

Is the control input voltage (L151) of PF-100NW between 0.3 and 4.4V? (VTVM)

Yes ↓

No ↓

Normal

Adjust the C123 and the C132 to maintain the voltage.

TX VCO

Check the VCO control voltage (L152) when the transmission output (C148) level is low or zero.



Carefully disassemble the VCO shield can, and perform visual inspection. Is the VCO shield can normal?

No
←

Yes ↓

Are bias voltages of Q103 and Q104 normal?

No
←

Yes ↓

Check if the bias voltage of the C140 is 5V. (VTVM)

No
←

Yes ↓

Is the control input voltage (L152) of PF-100NW between 0.3 and 4.4V? (VTVM)

↓ No

Yes ↓

Normal

8.4 When Modulation Is Not Made

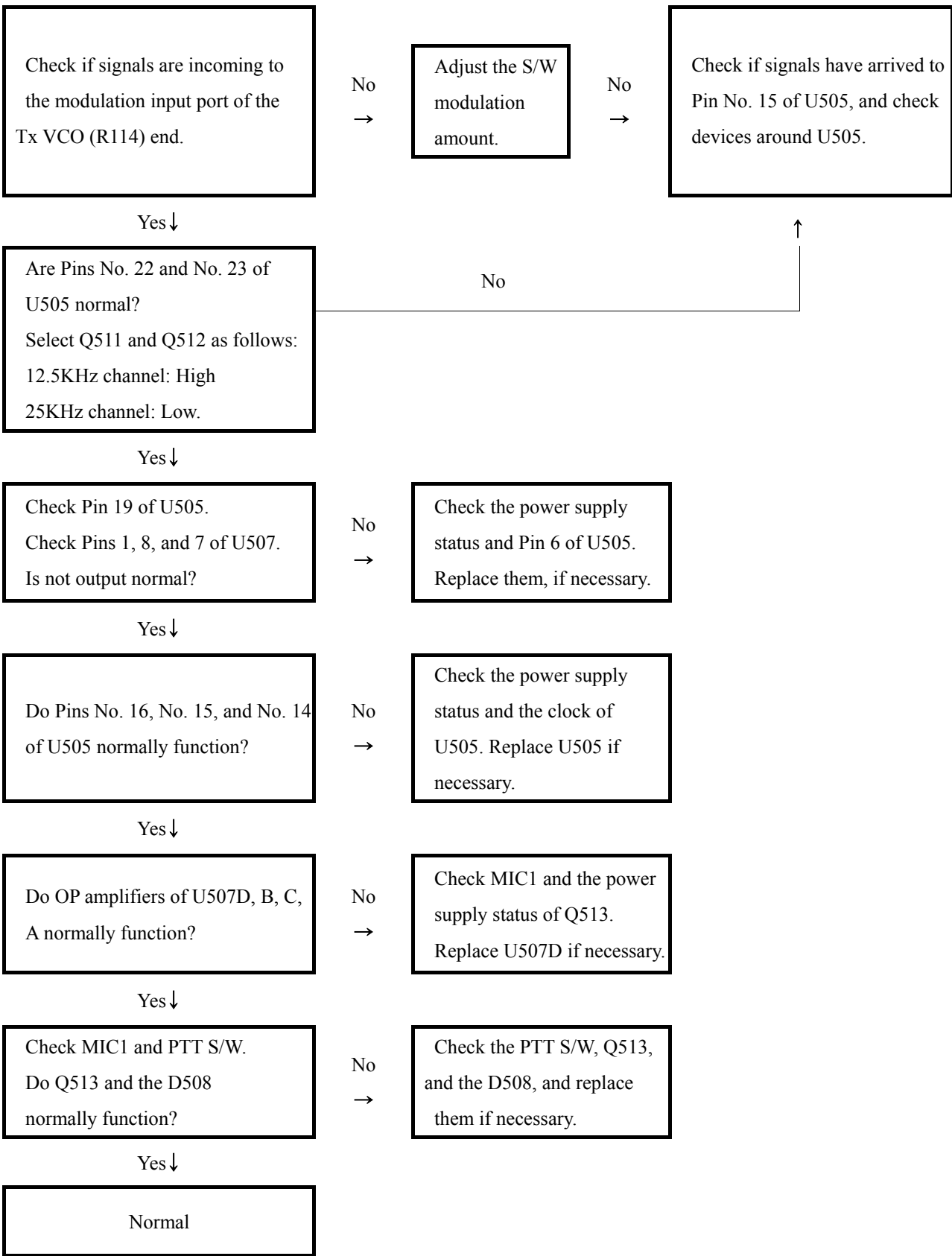

8.5 Frequency Synthesizer Trouble

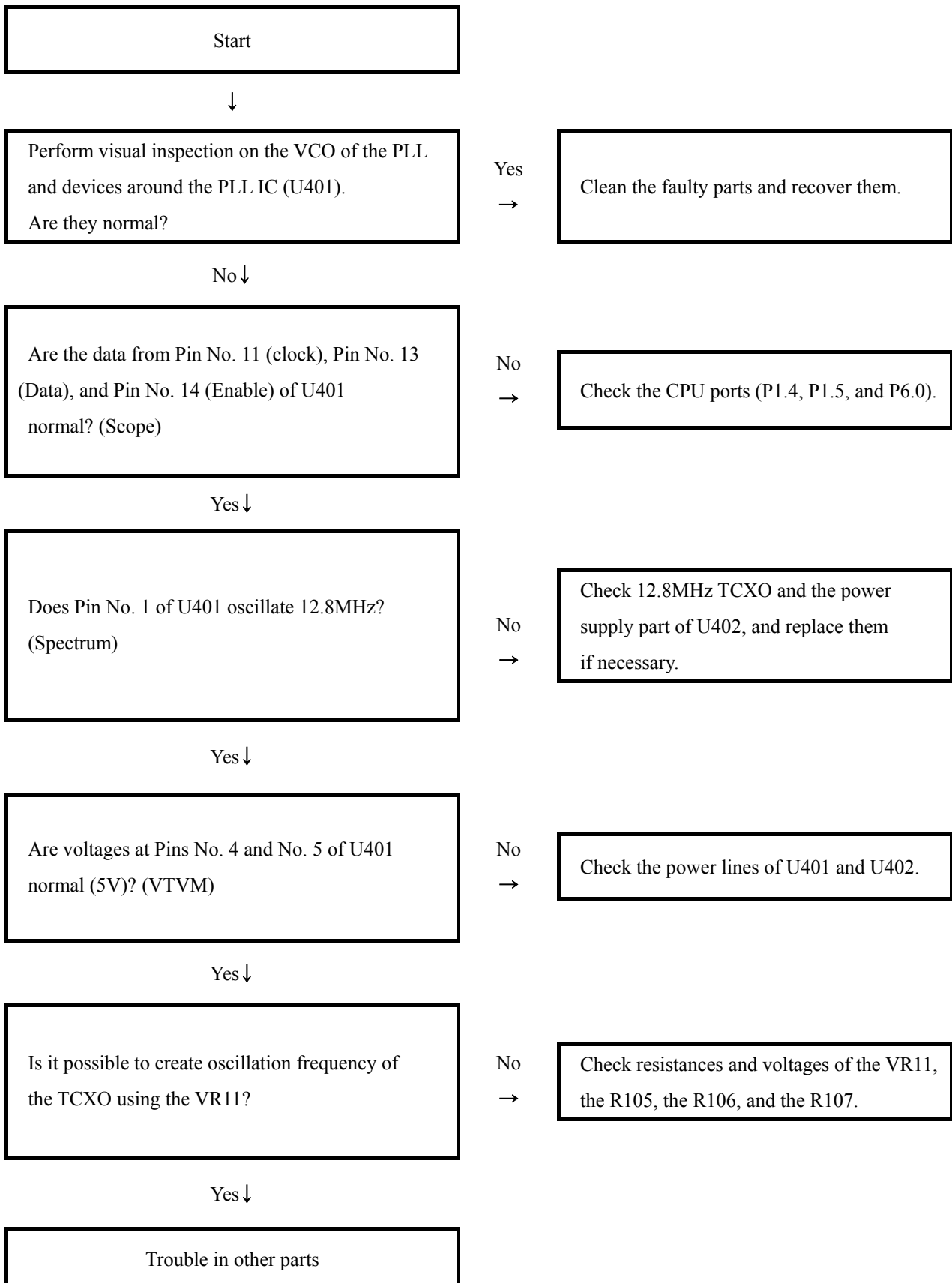

8.6 CPU (Microprocessor) Trouble

