

SAR TEST REPORT

Product:	Rugged Smart Phone
Model No:	MobileMapper50_4G
Additinoal Model:	N/A
Trade Mark:	Spectra Precision
FCC ID:	NZI-10900300
Report No:	WT-1605-0008
Issued Date:	Aug 11,2016

Issued for:
TRIMBLE EUROPE B.V.
European Regional Fulfilment Centre Meerheide,45 5521DZ Eersel THE
NETHERLANDS

Issued By:

Inventec Appliances(Jiangning) Corporation Testing Laboratory
Address: 133, Jiang-Jun Road, Jiangning Economic and Technological
Development Zone, Nanjing , P.R.C China
Tel:025-52262313 Fax: 025-52787690

TABLE OF CONTENTS

1. Test Certification.....	3
2. Test Result Summary	4
3. EUT Description	5
4. SAR Measurement System Configuration.....	6
5. Measurement Procedure.....	15
6. Hotspot mode evaluation procedure	17
7. Conducted Output Power	18
8. SAR Test Results Summary	25
9. Test Standards and Configuration	36
10. System Check Results.....	38
11. SAR TEST DATA	58
Appendix A: EUT Photos	298
Appendix B: Test Setup Photos.....	299
APPENDIX C: PROBE CALIBRATION CERTIFICATE	302
APPENDIX D: DIPOLE CALIBRATION REPORT.....	320

1. TEST CERTIFICATION

Product:	Rugged Smart Phone
Model No.:	MobileMapper50_4G
Additional Model:	N/A
Trade Mark:	Spectra Precision
Applicant:	TRIMBLE EUROPE B.V.
Address:	European Regional Fulfilment Centre Meerheide,45 5521DZ Eersel THE NETHERLANDS
Manufacturer:	TRIMBLE EUROPE B.V.
Address:	European Regional Fulfilment Centre Meerheide,45 5521DZ Eersel THE NETHERLANDS
Date of Test:	Jul 1 –Jul 15, 2016
SAR Max. Values:	0.73W/Kg (1g) for Body; 0.69W/Kg (1g) for Head
Applicable Standards:	FCC 47 CFR Parts 1&2,ANSI C95.1-2005,IEEE 1528-2013 RSS-102

Tested By: Zhang Shuguo Date: 2016.8.1

Reviewed By: Ji Jianlin Date: 2016.8.11

Approved By: [Signature] Date: 2016.8.11

2. TEST RESULT SUMMARY

The maximum results of Specific Absorption Rate (SAR) found during test as bellows:

<Highest Reported standalone SAR Summary>

Exposure Position	Frequency Band	Reported 1g SAR (W/kg)	Equipment Class	Highest Reported 1g SAR (W/kg)
Head	GSM850	0.69	PCE	0.69
	GSM1900	0.29		
	WCDMA BAND2	0.35		
	WCDMA BAND5	0.38		
	LTE BAND4	0.48		
	WIFI 2.4G	0.02	DTS	
Body (10mm Gap)	GSM850	0.64	PCE	0.73
	GSM1900	0.57		
	WCDMA BAND2	0.73		
	WCDMA BAND5	0.27		
	LTE BAND4	0.57		
	WIFI 2.4G	0.08	DTS	

3. EUT DESCRIPTION

Product Name:	Rugged Smart Phone
Model :	MobileMapper50_4G
Additional Model:	N/A
Trade Mark:	Spectra Precision
Hardware Version:	MM50.4G_V1.0
Software Version:	MM50.4G.16.22.39
Power Supply:	Rechargeable Li-ion Battery DC3.7V
2G	
Operation Band:	GSM850, GSM1900
Supported type:	GSM/GPRS/EDGE
Power Class:	GSM850:Power Class 5; GSM1900:Power Class 0
Modulation Type:	GMSK for GSM/GPRS/EDGE
GSM Release Version:	VOICE
GPRS Multi-slot Class:	Class8-One up
GPRS Multi-slot Class:	Class12-Four up
EDGE Multi-slot Class:	8psk
3G	
Operation Band:	WCDMA BAND2/WCDMA BAND5
Power Class:	MAX POWER
Modulation Type:	RMC/HSDPA/HSUPA
4G	
Operation Band:	LTE BAND4
Modulation Type:	QPSK/16QAM
WIFI	
Supported type:	802.11b/802.11g/802.11n
Modulation:	802.11b: DSSS 802.11g/802.11n:OFDM
Operation frequency:	802.11b/802.11g/802.11n(HT20):2412MHz~2472MHz;
Channel number:	1CH/6CH/11CH
Channel separation:	5MHz
BT	
Bluetooth Version:	BT4.0(BR/EDR+BLE)
3GPP Version:	Release 8
EUT Production stage:	Production unit

4. SAR MEASUREMENT SYSTEM CONFIGURATION

4.1 Measurement Set-up

The OPENSAR system for performing compliance tests consist of the following items: A standard high precision 6-axis robot (KUKA) with controller and software. KUKA Control Panel (KCP) A dosimetric probe, i.e., an isotropic E-field probe optimized and calibrated for usage in tissue simulating liquid. The probe is equipped with a Video Positioning System (VPS).The stress sensor is composed with mechanical and electronic when the electronic part detects a change on the electro-mechanical switch; it sends an “Emergency signal” to the robot controller that to stop robot’s moves A computer operating Windows XP. OPENSAR software Remote control with teaches pendant and additional circuitry for robot safety such as warning lamps, etc. The SAM phantom enabling testing left-hand right-hand and body usage. The Position device for handheld EUT Tissue simulating liquid mixed according to the given recipes. System validation dipoles to validate the proper functioning of the system.

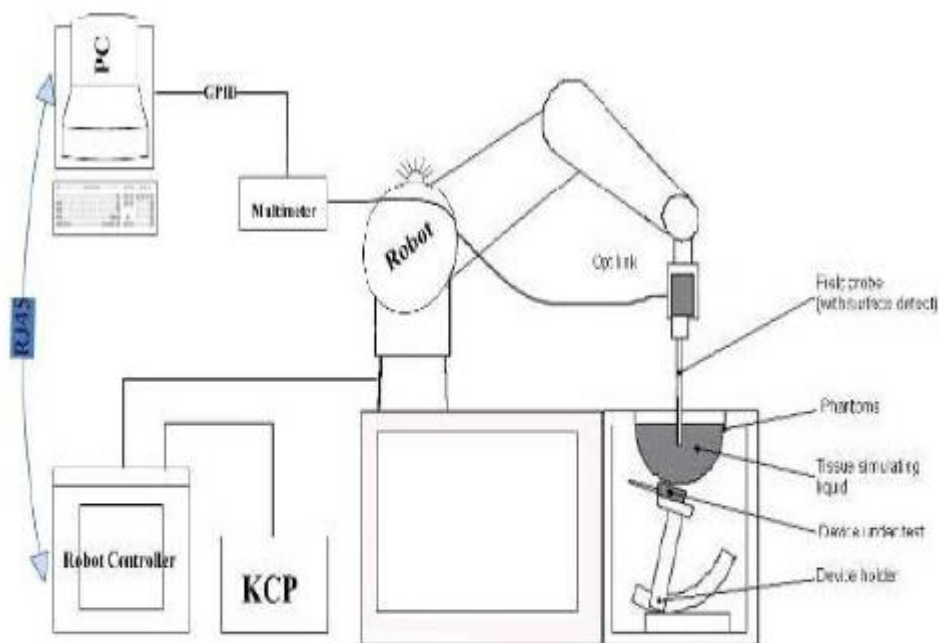

KUKA SAR Test System Configuration

4.2 E-field Probe

The SAR measurement is conducted with the dosimetric probe (manufactured by SATIMO). The probe is specially designed and calibrated for use in liquid with high permittivity. The dosimetric probe has special calibration in liquid at different frequency. This probe has a built in optical surface detection system to prevent from collision with phantom.

Probe Specification

Construction Symmetrical design with triangular core Interleaved sensors Built-in shielding against static charges PEEK enclosure material (resistant to organic solvents, e.g., DGBE) Calibration ISO/IEC 17025 calibration service available.

Device Type	COMOSAR DOSIMETRIC E FIELD PROBE
Manufacturer	Satimo
Model	SSE5
Serial Number	SN 18/11 EP121
Frequency Range of Probe	0.7 GHz-3GHz
Resistance of Three Dipoles at Connector	Dipole 1:R1=0.180MΩ Dipole 2:R2=0.191MΩ Dipole 3:R3=0.179MΩ



Figure 1 – Satimo COMOSAR Dosimetric E field Dipole

Device Type	COMOSAR DOSIMETRIC E FIELD PROBE
Manufacturer	Satimo
Model	SSE5
Serial Number	SN 35/11 EP131
Frequency Range of Probe	0.7 GHz-3GHz
Resistance of Three Dipoles at Connector	Dipole 1: R1=0.999 MΩ Dipole 2: R2=1.244 MΩ Dipole 3: R3=1.253 MΩ



Figure 1 – Satimo COMOSAR Dosimetric E field Dipole

4.3 Phantom

The SAM Phantom SAM72/ SAM73 is constructed of a fiberglass shell integrated in a wooden table. The shape of the shell is in compliance with the specification set in IEEE 1528 and CENELEC EN62209-1, EN62209-2:2010.

The phantom enables the dosimetric evaluation of left and right hand phone usage as well as body mounted usage at the flat phantom region.

A cover prevents the evaporation of the liquid.

Reference markings on the Phantom allow the complete setup of all predefined phantom positions and measurement grids by manually teaching three points in the robot.

System checking was performed using the flat section, whilst Head SAR tests used the left and right head profile sections.

Body SAR testing also used the flat section between the head profiles.

Name: COMOSAR IEEE SAM PHANTOM

S/N:3909 SAM 72 / 3909 SAM 73

Manufacture: SATIMO



Name: COMOSAR IEEE SAM PHANTOM

S/N: SN 3909 ELLI16

Manufacture: SATIMO

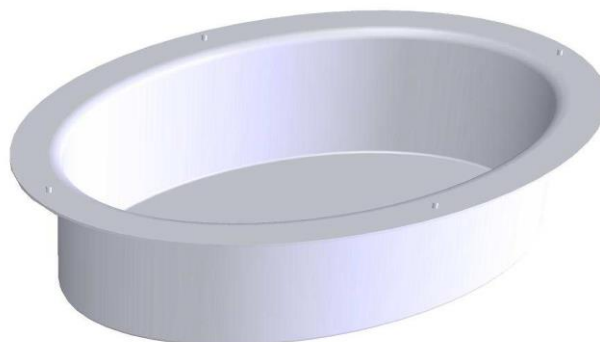

4.4 Device holder

The SAR value is approximatively inversely proportional to the square of the distance between the source and the internal surface of the phantom .For a source at 5 mm distance, a positioning uncertainty of 0.5 mm would produce a SAR uncertainty of 20 % .An accurate device positioning is therefore essential for accurate and repeatable measurements.

This Positioning system allows the translation of the mobile phone along the X, Y and Z axis, as well as the required rotation around the phantom ear, for the 2 positions defined by standards (0° “cheek” position and 15°“tilt” position).

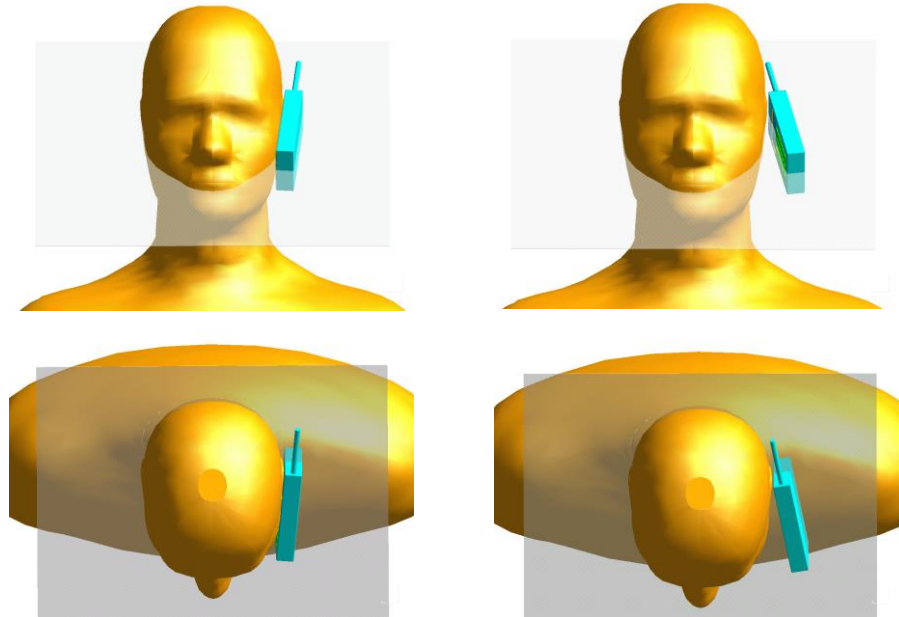
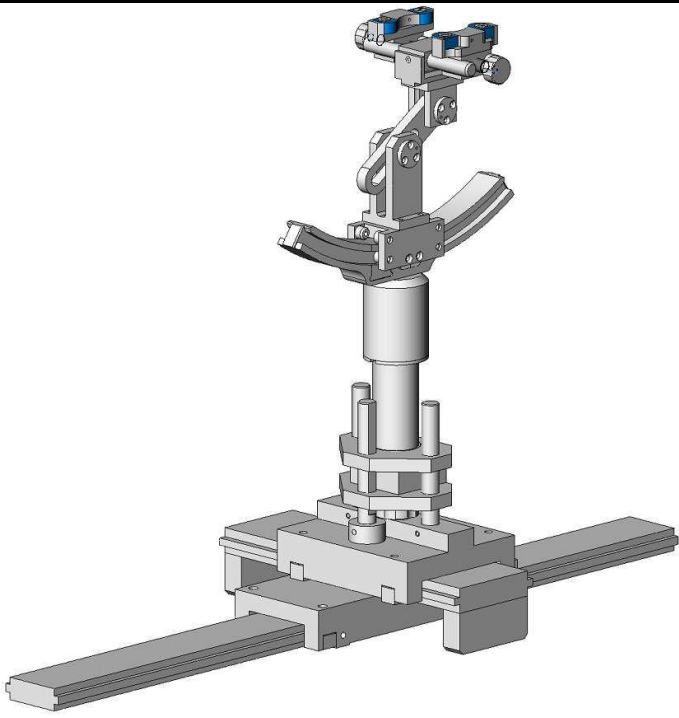

Fig1:Cheek and Tilt positions requested by CENELEC and IEEE

Mobile phone positioning system characteristics

	<p>Totally metal-free design</p> <p>Rotation point on ear opening</p> <p>Translation to lock the device under test under the flat part or under the left or right ear</p> <p>High repeatability with rotation point external adjustment</p> <p>Easy and accurate position according to all standards</p> <p>Compliance with mobile phone, PMR or PDA dimensions</p>
-----------------------------------------------------------------------------------	---------------------------------------------------------------------------------------------------------------------------------------------------------------------------------------------------------------------------------------------------------------------------------------------------------------------------------------------------------------------

X translation	700 mm
Y translation	250 mm
Z translation	100 mm

The correct position can be easily defined thanks to an additional tool with a pointer. With this tool, the top part of the system, above the curved rail, can be fixed definitively, so that the subsequent adjustments just concern the angle or the X, Y or Z axis.

It simplifies the positioning of the acoustic output of the telephone on the cross section of the phantom, before rolling the system underneath the phantom. Moreover, it improves the accuracy and repeatability of the positioning with a tolerance ≤ 0.5 mm.

4.5 Tissue Dielectric Parameters

According to IEEE 1528, the liquid parameters for head are the same as body requirements. For SAR measurement of the field distribution inside the phantom, the phantom must be filled with homogeneous tissue simulating liquid a depth of at least 15cm, For head SAR testing, the liquid height from the ear reference point (ERP) of the phantom to the liquid top surface is larger than 10cm, For body SAR testing, the liquid height from the center of the flat phantom to the liquid top surface is larger than 15cm.

TYPICAL COMPOSITION OF INGREDIENTS FOR LIQUID TISSUE PHANTOMS

Ingredients (% by weight)	Frequency (MHz)									
	450		835		915		1900		2450	
Tissue Type	Head	Body	Head	Body	Head	Body	Head	Body	Head	Body
Water	38.56	51.16	41.45	52.4	41.05	56.0	54.9	40.4	62.7	73.2
Salt (NaCl)	3.95	1.49	1.45	1.4	1.35	0.76	0.18	0.5	0.5	0.04
Sugar	56.32	46.78	56.0	45.0	56.5	41.76	0.0	58.0	0.0	0.0
HEC	0.98	0.52	1.0	1.0	1.0	1.21	0.0	1.0	0.0	0.0
Bactericide	0.19	0.05	0.1	0.1	0.1	0.27	0.0	0.1	0.0	0.0
Triton X-100	0.0	0.0	0.0	0.0	0.0	0.0	0.0	0.0	36.8	0.0
DGBE	0.0	0.0	0.0	0.0	0.0	0.0	44.92	0.0	0.0	26.7
Dielectric Constant	43.42	58.0	42.54	56.1	42.0	56.8	39.9	54.0	39.8	52.5
Conductivity (S/m)	0.85	0.83	0.91	0.95	1.0	1.07	1.42	1.45	1.88	1.78

Salt: 99% Pure Sodium Chloride Sugar: 98% Pure Sucrose
 Water: De-ionized, 16 MΩ resistivity HEC: Hydroxyethyl Cellulose
 DGBE: 99% Di(ethylene glycol) butyl ether, [2-(2-butoxyethoxy)ethanol]
 Triton X-100 (ultra pure): Polyethylene glycol mono [4-(1,1, 3, 3-tetramethylbutyl)phenyl]ether

Target Frequency (MHz)	Head		Body	
	ϵ_r	σ (S/m)	ϵ_r	σ (S/m)
150	52.3	0.76	61.9	0.80
300	45.3	0.87	58.2	0.92
450	43.5	0.87	56.7	0.94
835	41.5	0.90	55.2	0.97
900	41.5	0.97	55.0	1.05
915	41.5	0.98	55.0	1.06
1450	40.5	1.20	54.0	1.30
1610	40.3	1.29	53.8	1.40
1800 – 2000	40.0	1.40	53.3	1.52
2450	39.2	1.80	52.7	1.95
3000	38.5	2.40	52.0	2.73
5800	35.3	5.27	48.2	6.00

(ϵ_r = relative permittivity, σ = conductivity and $\rho = 1000 \text{ kg/m}^3$)

4.6 Tissue-equivalent Liquid-Head Properties

Frequency (MHz)	Test Date	Temp °C	Measured Dielectric Parameters		Target Dielectric Parameters		Limit (Within±5%)	
			ϵ_r	σ (s/m)	ϵ_r	σ (s/m)	Dev ϵ_r (%)	Dev σ (%)
835	2/7/2016	22.5	41.1	0.92	41.5	0.90	-1.0	2.2
1800	1/7/2016	22.5	39.7	1.38	40.0	1.40	-0.8	-1.4
1900	1/7/2016	22.5	39.0	1.45	40.0	1.40	-2.5	3.6
2000	1/7/2016	22.5	39.5	1.43	40.0	1.40	-1.3	2.1
2450	8/7/2016	22.5	38.2	1.83	39.2	1.80	-2.6	1.7

4.7 Tissue-equivalent Liquid-Body Properties

Frequency (MHz)	Test Date	Temp °C	Measured Dielectric Parameters		Target Dielectric Parameters		Limit (Within±5%)	
			ϵ_r	σ (s/m)	ϵ_r	σ (s/m)	Dev ϵ_r (%)	Dev σ (%)
835	5/7/2016	22.5	53.4	0.96	55.2	0.97	-3.2	-1.0
1800	7/7/2016	22.5	52.8	1.47	53.3	1.52	-0.9	-3.5
1900	7/7/2016	22.5	53.9	1.45	53.3	1.52	1.1	-4.4
2000	7/7/2016	22.5	53.9	1.52	53.3	1.52	1.1	0.1
2450	8/7/2016	22.5	53.1	1.95	52.7	1.95	0.7	-0.2

4.8 System Check

System validation has to be performed with the below input power measurement test setup described in IEEE 1528. The SAR system must be validated against its performance specifications before it is deployed. When SAR probe and system component or software are changed, upgraded or recalibrated, these must be validated with the SAR system(s) that operates with such component. Reference dipoles are used with the required tissue-equivalent media for system validation.

System check results have to be equal or near the values determined during dipole calibration with the relevant liquids and test system ($\pm 10\%$).

System check is performed regularly on all frequency bands where tests are performed with the OPENSAR system.

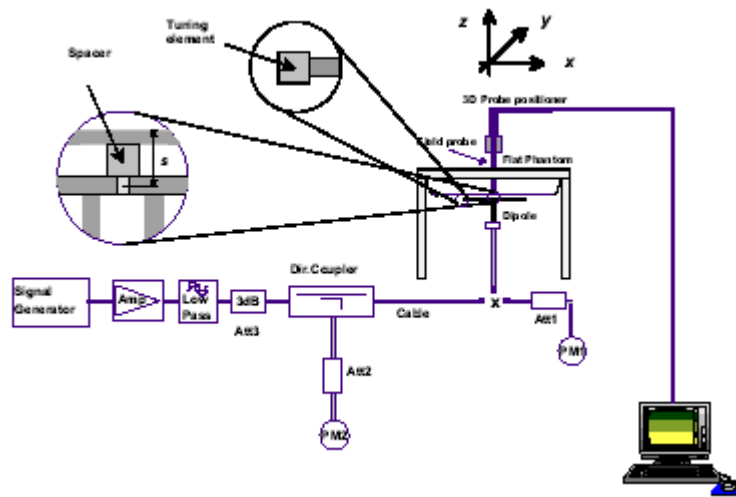

System Validation is used for verifying the accuracy of the probe and readout electronics, and performance of the software.

System Check Set-up

Verification Results (Head)	Frequency (MHz)	Measured Value in 10dBm (W/kg)		Normalized to 1W (W/kg)		Target Value Frequency (W/kg)		Deviation (%)	
		1 g Average	10 g Average	1 g Average	10 g Average	1 g Average	10 g Average	1 g Average	10 g Average
		835	0.098	0.066	9.80	6.60	9.50	6.20	3.2
1800	0.391	0.213	39.10	21.30	38.10	19.80	2.6	7.5	
1900	0.388	0.202	38.80	20.20	39.70	20.50	-2.2	-1.4	
2000	0.387	0.220	38.70	22.00	41.10	21.10	-5.8	4.2	
2450	0.507	0.236	50.70	23.60	52.40	24.00	-3.2	-1.6	

Verification Results (Body)	Frequency (MHz)	Measured Value in 20dBm (W/kg)		Normalized to 1W (W/kg)		Target Value Frequency (W/kg)		Deviation (%)	
		1 g Average	10 g Average	1 g Average	10 g Average	1 g Average	10 g Average	1 g Average	10 g Average

	835	0.976	0.634	9.76	6.34	9.56	6.22	2.1	1.9
	1800	3.517	1.967	35.17	19.67	38.4	20.1	-8.4	-2.1
	1900	4.197	2.214	41.97	22.14	39.7	20.5	5.7	8.0
	2000	4.172	2.154	41.72	21.54	41.1	21.1	1.5	2.1
	2450	4.909	2.335	49.09	23.35	52.4	24.0	-6.3	-2.7

Comparing to the original SAR value provided by SATIMO, the verification data should be within its specification of 10%. Below table shows the target SAR and measured SAR after normalized to 1W input power. The table as below indicates the system performance check can meet the variation criterion and the plots can be referred to Section 10 of this report.

5. MEASUREMENT PROCEDURE

5.1 Measurement Process Diagram

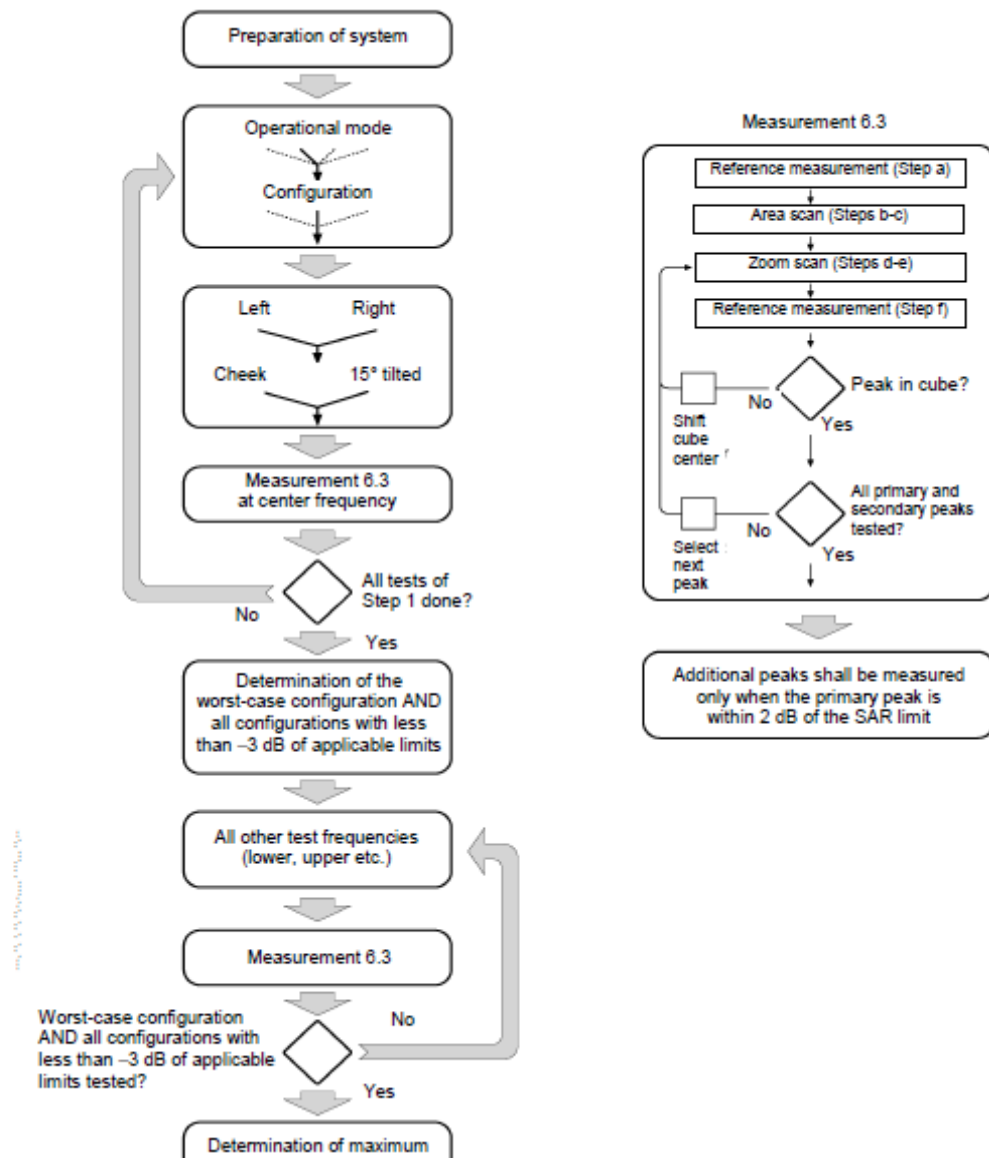

5.2 Measurement Procedure

5.2.1 Setup a Call Connection

Establish a call in handset at the maximum power level with a base station simulator via air interface, or make the EUT estimate by itself in testing band.

5.2.2 Power Reference Measurement

The reference and drift jobs are useful jobs for monitoring the power drift of the device under test in the batch process. Both jobs measure the field at a specified reference position, at selectable distance from the phantom surface. The reference position can be either the selected section's grid reference point or a user point in this section. The reference job projects the selected point onto the phantom surface, orients the probe perpendicularly to the surface, and approaches the surface using the selected detection method.

5.2.3 Area Scan

Area scans are defined prior to the measurement process being executed with a user defined variable spacing between each measurement point (integral) allowing low uncertainty measurements to be conducted. Scans defined for FCC applications utilize a 10mm² step integral, with 1mm interpolation used to locate the peak SAR area used for zoom scan assessments.

When an Area Scan has measured all reachable points, it computes the field maxima found in the scanned area, within a range of the global maximum. The range (in dB) is specified in the standards for compliance testing. For example, a 2 dB range is required in IEEE 1528-2013, EN 50361 and IEC 62209 standards, whereby 3 dB is a requirement when compliance is assessed in accordance with the ARIB standard.

5.2.4 Zoom Scan

Zoom scans are used to assess the peak spatial SAR values within a cubic averaging volume containing 1 g and 10 g of simulated tissue. The default zoom scan measures 5 x 5 x 4 points within a cube whose base faces are centered around the maximum found in a preceding area scan job within the same procedure. If the preceding Area Scan job indicates more than one maximum, the number of Zoom Scans has to be enlarged accordingly (The default number inserted is 1).

5.2.5 Power Drift measurement

The drift job measures the field at the same location as the most recent reference job within the same procedure, and with the same settings. The drift measurement gives the field difference in dB from the reading conducted within the last reference measurement. Several drift measurements are possible for one reference measurement. This allows a user to monitor the power drift of the device under test within a batch process.

In the properties of the Drift job, the user can specify a limit for the drift and have OPENSAR software stop the measurements if this limit is exceeded.

If the power drifts more than 5%, the SAR will be retested.

6. HOTSPOT MODE EVALUATION PROCEDURE

The SAR evaluation procedures for Portable Devices with Wireless Router function is according to KDB 941225 D06 Hot Spot SAR v01r01.

SAR must be tested for all surfaces and edges (side) with a transmitting antenna with in 2.5cm from that surface or edge, at a test separation distance of 10mm, in the wireless mode that support wireless routing.

Edge configurations:



7. CONDUCTED OUTPUT POWER

GSM							
Band		CH No.	Avg Power (dBm)	Band		CH No.	Avg Power (dBm)
850	GSM (VOICE)	128	32.1	1900	GSM (VOICE)	512	28.9
		190	32.3			661	29.0
		251	32.3			810	28.7
	GSM+GPRS (4up1down)	128	32.2		GSM+GPRS (4up1down)	512	28.9
		190	32.3			661	29.0
		251	32.3			810	28.7
	GSM+GPRS (3up1down)	128	30.2		GSM+GPRS (3up1down)	512	26.7
		190	30.2			661	26.6
		251	30.2			810	27.0
	GSM+GPRS (2up1down)	128	32.2		GSM+GPRS (2up1down)	512	28.5
		190	32.0			661	28.7
		251	31.9			810	28.7
	GSM+GPRS (1up1down)	128	32.1		GSM+GPRS (1up1down)	512	28.8
		190	32.2			661	29.0
		251	32.3			810	28.7
	GSM+EDGE (1up1down)	128	27.2		GSM+EDGE (1up1down)	512	27.8
		190	27.3			661	27.8
		251	27.4			810	27.8
	GSM+EDGE (1up2down)	128	27.3		GSM+EDGE (1up2down)	512	27.6
		190	27.3			661	27.6
		251	27.3			810	27.6
	GSM+EDGE (1up3down)	128	27.2		GSM+EDGE (1up3down)	512	27.6
		190	27.2			661	27.7
		251	27.2			810	27.6
GSM+EDGE (1up4down)	128	27.2	GSM+EDGE (1up4down)	512	27.7		
	190	27.3		661	27.7		
	251	27.3		810	27.3		
GSM+EDGE (2up2down)	128	27.1	GSM+EDGE (2up2down)	512	27.7		
	190	27.3		661	27.7		
	251	27.2		810	27.8		

WCDMA Band2	Max Power (dBm)		
Channel	9262CH	9400CH	9538CH
RMC 12.2Kbps	24.8	24.9	24.8
HSDPA Subtest-1	24.4	24.8	24.5

HSDPA Subtest-2	24.0	24.7	24.7
HSDPA Subtest-3	23.9	24.3	24.2
HSDPA Subtest-4	24.0	24.2	24.2
HSUPA Subtest-1	23.8	24.6	24.2
HSUPA Subtest-2	23.1	23.3	23.4
HSUPA Subtest-3	23.4	23.8	23.8
HSUPA Subtest-4	23.8	24.4	24.2
HSUPA Subtest-5	24.1	24.3	24.4

WCDMA Band5	Max Power (dBm)		
Channel	4132CH	4182CH	4233CH
RMC 12.2Kbps	23.8	23.9	23.7
HSDPA Subtest-1	22.9	23.0	22.8
HSDPA Subtest-2	23.1	23.0	22.8
HSDPA Subtest-3	22.5	22.5	22.3
HSDPA Subtest-4	22.3	22.5	22.4
HSUPA Subtest-1	22.1	23.4	23.2
HSUPA Subtest-2	21.6	22.1	22.4
HSUPA Subtest-3	21.2	21.7	22.1
HSUPA Subtest-4	21.7	23.1	22.6
HSUPA Subtest-5	22.0	23.0	22.1

LTE					
Band4	Uplink Channel Number	BW (MHz)	RB Size	Mod	Maximum Avg Power(dBm)
Low	19957	1.4	1	QPSK	24.3
			3	QPSK	24.3
			6	QPSK	23.4
			1	16-QAM	23.6
			6	16-QAM	23.9
	19965	3	1	QPSK	24.1
			15	QPSK	23.4
			1	16-QAM	23.5
			15	16-QAM	23.4
	19975	5	1	QPSK	24.0
			25	QPSK	23.4
			1	16-QAM	23.4

			25	16-QAM	23.4
	20000	10	1	QPSK	24.4
			25	QPSK	23.5
			50	QPSK	23.7
			1	16-QAM	23.9
			50	16-QAM	23.9
Middle	20175	1.4	1	QPSK	24.2
			3	QPSK	24.4
			6	QPSK	23.5
			1	16-QAM	23.9
			6	16-QAM	23.5
		3	1	QPSK	24.3
			15	QPSK	23.6
			15	16-QAM	23.4
		5	1	QPSK	23.9
			25	QPSK	23.5
			1	16-QAM	23.6
			25	16-QAM	23.4
		10	1	QPSK	24.1
			25	QPSK	23.4
			50	QPSK	23.3
			1	16-QAM	23.3
50	16-QAM		22.3		
High	20393	1.4	1	QPSK	23.6
			3	QPSK	23.8
			6	QPSK	23.8
			1	16-QAM	23.8
			6	16-QAM	23.7
	20385	3	1	QPSK	23.9
			15	QPSK	23.8
			1	16-QAM	23.7
			15	16-QAM	23.6
	20375	5	1	QPSK	23.9
			25	QPSK	23.8
			1	16-QAM	23.9
			25	16-QAM	23.8
	20350	10	1	QPSK	24.1
			25	QPSK	23.9
			50	QPSK	23.9
1			16-QAM	23.4	
50			16-QAM	23.5	
<p>The following tests were conducted according to the test requirements outlined in section 6.2 of the 3GPP TS36.101 specification.</p> <p>UE Power Class:3(23+/-2dBm).The allowed Maximum Power Reduction(MPR) for the</p>					

maximum output power due to higher order modulation and transmit bandwidth configuration (resource blocks) is specified in Table 6.2.3-1 of the 3GPP TS36.101.

Table 6.2.3-1: Maximum Power Reduction (MPR) for Power Class 3

Modulation	Channel bandwidth / Transmission bandwidth (RB)						MPR (dB)
	1.4 MHz	3.0 MHz	5 MHz	10 MHz	15 MHz	20 MHz	
QPSK	> 5	> 4	> 8	> 12	> 16	> 18	≤ 1
16 QAM	≤ 5	≤ 4	≤ 8	≤ 12	≤ 16	≤ 18	≤ 1
16 QAM	> 5	> 4	> 8	> 12	> 16	> 18	≤ 2

The allowed A-MPR values specified below in Table 6.2.4-1 of 3GPP TS36.101 are in addition to the allowed MPR requirements. All the measurements below were performed with A-MPR disabled, by using Network Signalling Value of "NS_01".3

Table 6.2.4-1: Additional Maximum Power Reduction (A-MPR)

Network Signalling value	Requirements (sub-clause)	E-UTRA Band	Channel bandwidth (MHz)	Resources Blocks (N_{RB})	A-MPR (dB)
NS_01	6.6.2.1.1	Table 5.5-1	1.4, 3, 5, 10, 15, 20	Table 5.6-1	NA
NS_03	6.6.2.2.1	2, 4, 10, 23, 25, 35, 36	3	>5	≤ 1
			5	>6	≤ 1
			10	>6	≤ 1
			15	>8	≤ 1
			20	>10	≤ 1
NS_04	6.6.2.2.2	41	5	>6	≤ 1
			10, 15, 20	See Table 6.2.4-4	
NS_05	6.6.3.3.1	1	10, 15, 20	≥ 50	≤ 1
NS_06	6.6.2.2.3	12, 13, 14, 17	1.4, 3, 5, 10	Table 5.6-1	n/a
NS_07	6.6.2.2.3	13	10	Table 6.2.4-2	Table 6.2.4-2
	6.6.3.3.2				
NS_08	6.6.3.3.3	19	10, 15	> 44	≤ 3
NS_09	6.6.3.3.4	21	10, 15	> 40	≤ 1
				> 55	≤ 2
NS_10		20	15, 20	Table 6.2.4-3	Table 6.2.4-3
NS_11	6.6.2.2.1	23 ¹	1.4, 3, 5, 10	Table 6.2.4-5	Table 6.2.4-5
..					
NS_32	-	-	-	-	-

Note 1: Applies to the lower block of Band 23, i.e. a carrier placed in the 2000-2010 MHz region.

7.1 WIFI 802.11b

Mode	1CH	6CH	11CH
11b LONG 1Mbps	13.7dBm	13.7dBm	13.6dBm
11b LONG 2Mbps	13.7dBm	13.6dBm	13.5dBm
11b LONG 5.5Mbps	13.7dBm	13.6dBm	13.5dBm
11b LONG 11Mbps	13.7dBm	13.7dBm	13.7dBm
11b SHORT 2 Mbps	13.6dBm	13.6dBm	13.6dBm
11b SHORT 5.5Mbps	13.6dBm	13.6dBm	13.5dBm
11b SHORT 11 Mbps	13.7dBm	13.7dBm	13.6dBm

7.2 WIFI 802.11g

Mode	1CH	6CH	11CH
11g 6Mbps	9.23dBm	9.12dBm	9.57dBm
11g 9Mbps	8.63dBm	9.03dBm	9.24dBm
11g 12Mbps	8.39dBm	8.05dBm	8.35dBm
11g 18Mbps	8.42dBm	8.60dBm	8.33dBm
11g 24Mbps	9.15dBm	8.85dBm	8.85dBm
11g 36Mbps	9.13dBm	9.21dBm	9.55dBm
11g 48Mbps	9.07dBm	9.24dBm	9.16dBm
11g 54Mbps	9.63dBm	9.04dBm	9.14dBm

7.3 WIFI 802.11n

Mode	1CH	6CH	11CH
MCS0 6.5Mbps	6.16dBm	6.83dBm	7.06dBm
MCS1 13Mbps	6.86dBm	7.04dBm	7.34dBm
MCS2 19.5Mbps	6.81dBm	6.94dBm	7.16dBm
MCS3 26Mbps	6.75dBm	7.17dBm	7.25dBm
MCS4 39Mbps	6.70dBm	6.57dBm	7.05dBm
MCS5 52Mbps	6.74dBm	7.96dBm	7.37dBm
MCS6 58.5Mbps	6.65dBm	7.33dBm	6.54dBm
MCS7 65Mbps	6.90dBm	6.42dBm	6.90dBm
MCS0 MM SG 7.2Mbps	6.65dBm	7.00dBm	7.44dBm
MCS1 MM SG 14.4Mbps	6.45dBm	7.15dBm	7.10dBm

MCS2 MM SG 21.7Mbps	6.37dBm	7.14dBm	6.81dBm
MCS3 MM SG 28.9Mbps	6.72dBm	7.12dBm	6.64dBm
MCS4 MM SG 43.3Mbps	6.66dBm	7.35dBm	6.53dBm
MCS5 MM SG 57.8Mbps	6.84dBm	7.37dBm	7.42dBm
MCS6 MM SG 65Mbps	6.38dBm	7.38dBm	7.14dBm
MCS7 MM SG 72.2Mbps	6.32dBm	7.48dBm	6.64dBm

7.4 Bluetooth

Band	Mode	CH#	Frequency (MHz)	Output Power (dBm)
BT	BT4.0(BR/EDR) GFSK	0	2402	8.35
		39	2441	7.66
		78	2480	5.36
	BT4.0(BR/EDR) $\pi/4$ -DQPSK	0	2402	8.69
		39	2441	7.56
		78	2480	7.56
	BT4.0(BR/EDR) 8-DPSK	0	2402	8.75
		39	2441	8.05
		78	2480	5.68
	BT4.0(BLE)	0	2402	-0.74
		19	2440	-0.71
		39	2480	-3.72

Note: 1. According to output power of WiFi, SAR is required 802.11b-11b LONG 11Mbps mode
 2. According to KDB 447498, the SAR test for Bluetooth is exclusion.

8. SAR TEST RESULTS SUMMARY

8.1 Head SAR 1g Value

Band	Mode	Position	CH.	Freq. (MHz)	SAR 1g (W/Kg)	Scaling Factor	Scaled SAR1g (W/Kg)	
GSM850	VOICE	Left cheek	190	836	0.40	1.05	0.42	
		Left Tilt	190	836	0.18		0.19	
		Right cheek	190	836	0.39		0.41	
		Right Tilt	190	836	0.20		0.21	
	GPRS (4up1down)	Left cheek	190	836	0.69	1.05	0.73	
		Left Tilt	190	836	0.24		0.25	
		Right cheek	190	836	0.66		0.69	
		Right Tilt	190	836	0.32		0.34	
		Right cheek	128	824	0.54	1.07	0.58	
		Right cheek	251	848	0.68	1.05	0.71	
	EDGE (1up1down)	Left cheek	190	836	0.11	1.05	0.12	
		Left Tilt	190	836	0.07		0.07	
		Right cheek	190	836	0.08		0.08	
		Right Tilt	190	836	0.05		0.05	
	GSM1900	VOICE	Left cheek	661	1880	0.26	1.12	0.29
			Left Tilt	661	1880	0.11		0.12
Right cheek			661	1880	0.14	0.16		
Right Tilt			661	1880	0.09	0.10		
GPRS (4up1down)		Left cheek	661	1880	0.29	1.12	0.33	
		Left Tilt	661	1880	0.14		0.16	
		Left cheek	512	1850	0.28	1.15	0.32	
		Left cheek	810	1909	0.23	1.20	0.28	
		Right cheek	661	1880	0.21	1.12	0.24	
		Right Tilt	661	1880	0.10		0.11	
EDGE (1up1down)		Left cheek	661	1880	0.08	1.17	0.09	
		Left Tilt	661	1880	0.03		0.04	
		Right cheek	661	1880	0.06		0.07	
		Right Tilt	661	1880	0.04		0.05	

Band	Mode	Position	CH.	Freq. (MHz)	SAR 1g (W/Kg)	Scaling Factor	Scaled SAR1g (W/Kg)
WCDMA BAND2	RMC	Left cheek	9400	1880	0.35	1.02	0.36
		Left Tilt	9400	1880	0.15		0.15
		Right cheek	9400	1880	0.24		0.25
		Right Tilt	9400	1880	0.13		0.13
	HSDPA/HS UPA	Left cheek	9262	1852	0.35	1.05	0.37
		Left cheek	9538	1907	0.31	1.05	0.33
		Left cheek	9400	1880	0.24	1.05	0.25
		Left Tilt	9400	1880	0.10		0.11
		Right cheek	9400	1880	0.17		0.18
		Right Tilt	9400	1880	0.10		0.11
WCDMA BAND5	RMC	Left cheek	4182	836	0.34	1.35	0.46
		Left Tilt	4182	836	0.15		0.20
		Right cheek	4182	836	0.38		0.51
		Right cheek	4132	826	0.30		0.41
		Right cheek	4233	846	0.32	1.32	0.42
		Right Tilt	4182	836	0.16	1.35	0.22
	HSDPA/HS UPA	Left cheek	4182	836	0.27	1.45	0.39
		Left Tilt	4182	836	0.17		0.25
		Right cheek	4182	836	0.27		0.39
		Right Tilt	4182	836	0.11		0.16

Band	Mode	Position	CH.	Freq. (MHz)	SAR 1g (W/Kg)	Scaling Factor	Scaled SAR1g (W/Kg)
LTE BAND4	BW:1.4MHz (RB:3)	Left cheek	20175	1732.5	0.44	1.15	0.51
		Left cheek	19957	1710.7	0.37	1.15	0.43
		Left cheek	20393	1754.3	0.45	1.15	0.52
		Left Tilt	20175	1732.5	0.29	1.15	0.33
		Right cheek	20175	1732.5	0.27		0.31
		Right Tilt	20175	1732.5	0.20		0.23
WIFI	802.11b 11b LONG 11Mbps	Left cheek	2412	1CH	0.02	1.07	0.02
		Right cheek		1CH	0.02		0.02
		Left cheek	2437	6CH	0.01	1.07	0.01
		Right cheek		6CH	0.02		0.02
		Left cheek	2462	11CH	0.01	1.07	0.01
		Right cheek		11CH	0.01		0.01

8.2 Body-Worn 1g SAR

Band	Mode	Position	CH.	Freq. (MHz)	SAR1g (W/Kg)	Scaling Factor	Scaled SAR1g (W/Kg)
GSM850	VOICE	Front	190	836	0.42	1.05	0.44
		back	190	836	0.37		0.39
		Left	190	836	0.30		0.32
		Right	190	836	0.29		0.31
		Bottom	190	836	0.06		0.06
	GPRS (4up1down)	Front	190	836	0.64	1.05	0.67
		Front	128	824	0.60	1.07	0.64
		Front	251	836	0.61	1.05	0.64
		back	190	836	0.60	1.07	0.64
		Left	190	836	0.50		0.54
		Right	190	836	0.45		0.48
		Bottom	190	836	0.10		0.11
	EDGE (1up1down)	Front	190	836	0.10	1.05	0.11
		back	190	836	0.09		0.10
		Left	190	836	0.06		0.06
		Right	190	836	0.07		0.07
		Bottom	190	836	0.01		0.01
GSM1900	VOICE	Front	661	1880	0.57	1.12	0.64
		back	661	1880	0.23		0.26
		Left	661	1880	0.08		0.09
		Right	661	1880	0.08		0.09
		Bottom	661	1880	0.17		0.19
	GPRS (4up1down)	Front	661	1880	0.45	1.12	0.50
		Front	512	1850	0.42	1.15	0.48
		Front	810	1909	0.41	1.20	0.49
		back	661	1880	0.27	1.12	0.30
		Left	661	1880	0.01		0.01
		Right	661	1880	0.10		0.11
Bottom	661	1880	0.18	0.20			

	EDGE (1up1down)	Front	661	1880	0.17	1.17	0.20
		back	661	1880	0.08		0.09
		Left	661	1880	0.02		0.02
		Right	661	1880	0.03		0.04
		Bottom	661	1880	0.05		0.06

Band	Mode	Position	CH.	Freq. (MHz)	SAR1g (W/Kg)	Scaling Factor	Scaled SAR1g (W/Kg)	
WCDMA BAND2	RMC	Front	9400	1880	0.73	1.02	0.75	
		Front	9262	1852	0.70	1.05	0.74	
		Front	9538	1907	0.72	1.05	0.76	
		back	9400	1880	0.35	1.05	0.37	
		Left	9400	1880	0.11		0.12	
		Right	9400	1880	0.14		0.15	
		Bottom	9400	1880	0.25		0.26	
	HSDPA/HS UPA	Front	9400	1880	0.51	1.05	0.54	
		back	9400	1880	0.25		0.26	
		Left	9400	1880	0.09		0.10	
		Right	9400	1880	0.10		0.11	
		Bottom	9400	1880	0.17		0.18	
	WCDMA BAND5	RMC	Front	4182	836	0.27	1.35	0.37
			Front	4132	826	0.26	1.32	0.34
			Front	4233	846	0.25	1.32	0.33
back			4182	836	0.28	1.35	0.38	
Left			4182	836	0.24		0.32	
Right			4182	836	0.22		0.30	
Bottom			4182	836	0.05		0.07	
HSDPA/HS UPA		Front	4182	836	0.23	1.45	0.33	
		back	4182	836	0.22		0.32	
		Left	4182	836	0.16		0.23	
		Right	4182	836	0.16		0.23	
		Bottom	4182	836	0.02		0.03	
LTE		BW:	Front	20175	1732.5	0.57	1.15	0.66

BAND4	1.4MHz(RB: 3)	Front	19957	1710.7	0.34	1.15	0.39
		Front	20393	1754.3	0.29	1.15	0.33
		back	20175	1732.5	0.31	1.15	0.36
		Left	20175	1732.5	0.28		0.32
		Right	20175	1732.5	0.21		0.24
		Bottom	20175	1732.5	0.06		0.07
WIFI	802.11b 11b LONG 11Mbps	Front	1	2412	0.03	1.07	0.03
		back	1	2412	0.05		0.05
		Left	1	2412	0.07		0.08
		Right	1	2412	0.02		0.02
		Bottom	1	2412	0.02		0.02
		Front	6	2437	0.03	1.07	0.03
		back	6	2437	0.05		0.05
		Left	6	2437	0.08		0.09
		Right	6	2437	0.02		0.02
		Bottom	6	2437	0.04		0.04
		Front	11	2462	0.03	1.07	0.03
		back	11	2462	0.02		0.02
		Left	11	2462	0.07		0.08
		Right	11	2462	0.01		0.01
		Bottom	11	2462	0.07		0.08

Note:

1. Body-worn SAR testing was performed at 10mm separation, and this distance is determined by the handset manufacturer that there will be body-worn accessories that users may acquire at the time of equipment certification, to enable users to purchase aftermarket body-worn accessories with the required minimum separation.
2. Determination of the worst-case configuration and all configurations with less than 3 dB of applicable limits.
4. When the 1g SAR for the mid-band channel or the channel with the highest output power satisfy the following conditions, testing of the other channels in the band is not required.(Per KDB 447498 D01 General RF Exposure Guidance)
5. Per FCC Publication 447498, if the reported (scaled) SAR measured at the middle channel or highest output power channel for each test configuration is $\leq 0.8W/Kg$ then testing at the other channels is not required for such test configurations. When the Maximum output power variation across the required test channels is 1/2 dB, instead of the middle channel, the highest output power channel was used.
- 6.

Scaling Factor calculation

Band	Tune-up power tolerance (dBm)	SAR test channel Power (dBm)	Scaling Factor
GSM850 VOCIE	PCL=5, PWR=32±0.5	32.3	1.05
GSM850 GPRS	PCL=5, PWR=32±0.5(4slots)	32.3	1.05
GSM850 EDGE	PCL=5, PWR=27±0.5(4slots)	27.3	1.05
GSM1900 VOICE	PCL=0, PWR=29±0.5(4slots)	29.0	1.12
GSM1900 GPRS	PCL=0, PWR=29±0.5	29.0	1.12
GSM1900 EDGE	PCL=0, PWR=28±0.5(4slots)	27.8	1.17
WCDMA BAND2	Max output power=24(+1,-3)	24.9	1.02
WCDMA BAND5	Max output power=24(+1,-3)	23.7	1.35
LTE BAND4	Max output power=23±2	24.4	1.15
WiFi802.11b	Max output power=13±1.0	13.7	1.07
BT4.0(BR/EDR) 8-DPSK	Max output power=8±1.0	8.75	1.06

8.3 Applicable Multiple Scenario Evaluation

Test Position	Main Ant. SAR Max (W/Kg)	WiFi SAR Max (W/Kg)	Σ 1g SAR Max(W/Kg)
Head SAR	0.69	0.02	0.71
Body SAR	0.73	0.08	0.81

This device is in compliance with Specific Absorption Rate (SAR) for general population/uncontrolled exposure limits (1.6W/kg) specified in FCC 47 CFR part 2(2.1093) and ANSI/IEEE C95.1 and had been tested in accordance with the measurement methods and procedures specified in IEEE 1528-2013

8.4 Measurement Uncertainty (450MHz-3GHz)

UNCERTAINTY EVALUATION FOR HANDSET SAR TEST									
a	b	c	d	e= f(d,k)	f	g	h= cxf/e	i= cxg/e	k
Uncertainty Component	Sec.	Tol. (± %)	Prob. Dist.	Div.	c_i (1 g)	c_i (10 g)	1 g u_i (± %)	10 g u_i (± %)	v_i
Measurement System									
Probe Calibration	E.2.1.	6	N	1	1	1	6	6	∞
Axial Isotropy	E.2.2.	3	R	$\sqrt{3}$	$(1-c_p)^{1/2}$	$(1-c_p)^{1/2}$	1,22474	1,22474	∞
Hemispherical Isotropy	E.2.2.	4	R	$\sqrt{3}$	$\sqrt{c_p}$	$\sqrt{c_p}$	1,63299	1,63299	∞
Boundary Effect	E.2.3.	1	R	$\sqrt{3}$	1	1	0,57735	0,57735	∞
Linearity	E.2.4.	5	R	$\sqrt{3}$	1	1	2,88675	2,88675	∞
System Detection Limits	E.2.5.	1	R	$\sqrt{3}$	1	1	0,57735	0,57735	∞
Readout Electronics	E.2.6.	0,5	N	1	1	1	0,5	0,5	∞
Response Time	E.2.7.	0,2	R	$\sqrt{3}$	1	1	0,11547	0,11547	∞
Integration Time	E.2.8.	2	R	$\sqrt{3}$	1	1	1,1547	1,1547	∞
RF Ambient Conditions	E.6.1.	3	R	$\sqrt{3}$	1	1	1,73205	1,73205	∞
Probe Positioner Mechanical Tolerance	E.6.2.	2	R	$\sqrt{3}$	1	1	1,1547	1,1547	∞
Probe Positioning with respect to Phantom Shell	E.6.3.	1	R	$\sqrt{3}$	1	1	0,57735	0,57735	∞
Extrapolation, interpolation and Integration Algorithms for Max. SAR Evaluation	E.5.2.	1,5	R	$\sqrt{3}$	1	1	0,86603	0,86603	∞
Test sample Related									
Test Sample Positioning	E.4.2.1.	1,5	N	1	1	1	1,5	1,5	N-1
Device Holder Uncertainty	E.4.1.1.	5	N	1	1	1	5	5	N-1
Output Power Variation - SAR drift measurement	6.6.2.	3	R	$\sqrt{3}$	1	1	1,73205	1,73205	∞
Phantom and Tissue Parameters									
Phantom Uncertainty (shape and thickness tolerances)	E.3.1.	4	R	$\sqrt{3}$	1	1	2,3094	2,3094	∞
Liquid Conductivity - deviation from target values	E.3.2.	5	R	$\sqrt{3}$	0,64	0,43	1,84752	1,2413	∞
Liquid Conductivity - measurement uncertainty	E.3.3.	2,5	N	1	0,64	0,43	1,6	1,075	M
Liquid Permittivity - deviation from target values	E.3.2.	3	R	$\sqrt{3}$	0,6	0,49	1,03923	0,8487	∞
Liquid Permittivity - measurement uncertainty	E.3.3.	2,5	N	1	0,6	0,49	1,5	1,225	M
Combined Standard Uncertainty			RSS				9,66051	9,52428	
Expanded Uncertainty (95% CONFIDENCE INTERVAL)			k				18,9346	18,6676	

UNCERTAINTY FOR SYSTEM PERFORMANCE CHECK

a	b	c	d	e= f(d,k)	f	g	h= cxf/e	i= cxg/e	k
Uncertainty Component	Sec.	Tol. (± %)	Prob. Dist.	Div.	c _i (1 g)	c _i (10 g)	1 g u _i (± %)	10 g u _i (± %)	v _i
Measurement System									
Probe Calibration	E.2.1.	6	N	1	1	1	6	6	∞
Axial Isotropy	E.2.2.	3	R	√3	(1-c _p) ^{1/2}	(1-c _p) ^{1/2}	1,22474	1,22474	∞
Hemispherical Isotropy	E.2.2.	5	R	√3	√c _p	√c _p	2,04124	2,04124	∞
Boundary Effect	E.2.3.	1	R	√3	1	1	0,57735	0,57735	∞
Linearity	E.2.4.	5	R	√3	1	1	2,88675	2,88675	∞
System Detection Limits	E.2.5.	1	R	√3	1	1	0,57735	0,57735	∞
Readout Electronics	E.2.6.	0,5	N	1	1	1	0,5	0,5	∞
Response Time	E.2.7.	0,2	R	√3	1	1	0,11547	0,11547	∞
Integration Time	E.2.8.	2	R	√3	1	1	1,1547	1,1547	∞
RF Ambient Conditions	E.6.1.	3	R	√3	1	1	1,73205	1,73205	∞
Probe Positioner Mechanical Tolerance	E.6.2.	2	R	√3	1	1	1,1547	1,1547	∞
Probe Positioning with respect to Phantom Shell	E.6.3.	1	R	√3	1	1	0,57735	0,57735	∞
Extrapolation, interpolation and Integration Algorithms for Max. SAR Evaluation	E.5.2.	1,5	R	√3	1	1	0,86603	0,86603	∞
Dipole									
Dipole Axis to Liquid Distance	8, E.4.2.	1	N	√3	1	1	0,57735	0,57735	N-1
Input Power and SAR drift measurement	8, 6.6.2.	2	R	√3	1	1	1,1547	1,1547	∞
Phantom and Tissue Parameters									
Phantom Uncertainty (shape and thickness tolerances)	E.3.1.	4	R	√3	1	1	2,3094	2,3094	∞
Liquid Conductivity - deviation from target values	E.3.2.	5	R	√3	0,64	0,43	1,84752	1,2413	∞
Liquid Conductivity - measurement uncertainty	E.3.3.	2,5	N	1	0,64	0,43	1,6	1,075	M
Liquid Permittivity - deviation from target values	E.3.2.	3	R	√3	0,6	0,49	1,03923	0,8487	∞
Liquid Permittivity - measurement uncertainty	E.3.3.	2,5	N	1	0,6	0,49	1,5	1,225	M
Combined Standard Uncertainty			RSS				8,09272	7,9296	
Expanded Uncertainty (95% CONFIDENCE INTERVAL)			k				15,8617	15,542	

8.5 Test Equipment List

Test Equipment	Manufacturer	Model	Serial Number	Calibration	
				Calibration Date	Calibration Due
Multimeter	Keithley	MiltiMeter2000	1247155	2016/02/27	2017/02/28
Network Analyzer	Agilent	8753E	MY40000219	2015/11/27	2016/11/28
Radio tester	R & S	CMU200	112824	2015/11/29	2016/11/28
Radio tester	R & S	CMW500	129747	2015/11/06	2016/11/07
Power meter with USB connection to PC/Software	R & S	NRP-Z23	100129	2016/06/17	2017/06/16
Signal Generator	Agilent	E4432B	GB38450323	2016/04/09	2017/04/08
E-Field PROBE	SATIMO	SSE5	18/11	2014/09/22	2017/09/22
E-Field PROBE	SATIMO	SSE5	35/11	2014/09/22	2017/09/22
DIPOLE 835	SATIMO	DIPC117	39/09	2016/07/01	2018/07/01
DIPOLE 900	SATIMO	DIPD118	39/09	2016/07/01	2018/07/01
DIPOLE 1800	SATIMO	DIPF119	39/09	2016/07/01	2018/07/01
DIPOLE 1900	SATIMO	DIPG120	39/09	2016/07/01	2018/07/01
DIPOLE 2000	SATIMO	DIP1121	39/09	2016/07/01	2018/07/01
DIPOLE 2450	SATIMO	DIPJ122	39/09	2016/07/01	2018/07/01
Communication Antenna	SATIMO	ANTA29	39/09	N/A	N/A
Mobile Phone Position Device	SATIMO	MSH60	39/09	N/A	N/A
SAM PHANTOM	SATIMO	SAM72/SAM73	39/09	N/A	N/A
SAM PHANTOM	SATIMO	ELLI16	39/09	N/A	N/A
6 AXIS ROBOT	KUKA	KR5	949009	N/A	N/A

Note:

N/A means this equipment no need to calibrate

The OPENSAR System calibration period was 3 years. In this period our lab is performing verification every six months.

9. TEST STANDARDS AND CONFIGURATION

9.1 Test Standards

Leading reference documents for testing:

No.	Identity	Document Title
1	47 CFR§2.1093	Radio Frequency Radiation Exposure Evaluation: Portable Devices
2	ANSI C95.1-2005	IEEE Standard for Safety Levels with Respect to human Exposure to Radio Frequency Electromagnetic Fields, 3kHz to 300GHz
3	IEEE 1528-2013	Recommended Practice for Determining the Peak Spatial-Average Specific Absorption Rate (SAR) in the Human Head from Wireless Communications Devices: Measurement Techniques.
4	KDB 447498 D01	General RF Exposure Guidance v06: Mobile and Portable Devices RF Exposure Procedures and Equipment Authorization Policies.
5	KDB 941225 D01	SAR Test for 3G devices v03r01: SAR Measurement Procedures for 3G Devices
6	KDB 648474 D04	Handset SAR v01r03: SAR Evaluation Considerations for Wireless Handsets.
7	KDB941225 D05	SAR for LTE Devices v02r05: SAR Evaluation Considerations for LTE Devices
8	KDB941225 D05A	LTE Rel.10 KDB Inquiry Sheet v01r02: REL. 10 LTE SAR TEST GUIDANCE AND KDB INQUIRIES
9	KDB941225 D06	Hotspot Mode SAR v02r01: SAR Evaluation Procedures for Portable Devices with Wireless Router Capabilities
10	KDB248227 D01	802.11 Wi-Fi SAR v02r02: SAR GUIDANCE FOR IEEE 802.11 (Wi-Fi) TRANSMITTERS
11	KDB865664 D01	SAR measurement 100 MHz to 6 GHz v01r04: SAR Measurement Requirements for 100 MHz to 6 GHz.
12	KDB865664 D02	RF Exposure Reporting v01r02: RF Exposure Compliance Reporting and Documentation Considerations

9.2 Device Category and SAR Limits

Controlled Environments are defined as locations where there is exposure that may be incurred by persons who are aware of the potential for exposure(i.e. as a result of employment or occupation). In general, occupational/controlled exposure limits are applicable to situations in which persons are exposed as a consequence of their employment, who have been made fully aware of the potential for exposure and can exercise control over their exposure. The exposure category is also applicable when the exposure is of a transient nature due to incidental passage through a location where the exposure levels may be higher than the general population/uncontrolled limits, but the exposed person is fully aware of the potential for exposure and can exercise control over his or her exposure by leaving the area or by some other appropriate means.

Limits for occupational/controlled Exposure(W/kg)

Whole-Body	Partial-Body	Hands, Wrists, Feet and Ankles
0.4	8.0	20.0

Limits for General population/Uncontrolled Exposure(W/kg)

Whole-Body	Partial-Body	Hands, Wrists, Feet and Ankles
0.08	1.60	4.00

This device belongs to portable device category because its radiating structure is allowed to be used within 20 centimeters of the body of the user. Limit for General Population/Uncontrolled exposure should be applied for this device, it is 1.6 W/kg as averaged over any 1 gram of tissue.

10. SYSTEM CHECK RESULTS

Date of measurement: 2016/07/02

Phantom: Validation plane

SAR Probe: SN_18/11_EP121

Input Power:10dBm

Dipole Model: CW835

Area Scan	<u>dx=8mm dy=8mmh= 5.00 mm</u>
ZoomScan	<u>7x7x7,dx=5mm dy=5mm dz=5mm,</u> <u>dx=8mm dy=8mm, h= 5.00 mm</u>
Phantom	<u>Validation plane</u>
Device Position	<u>Dipole</u>
Band	<u>CW835</u>
Channels	<u>Middle</u>
Signal	<u>CW (Crest factor: 1.0)</u>
Frequency (MHz)	835.000000
Relative permittivity (real part)	41.100000
Relative permittivity (imaginary part)	19.400000
Conductivity (S/m)	0.919944
Variation (%)	-0.620000

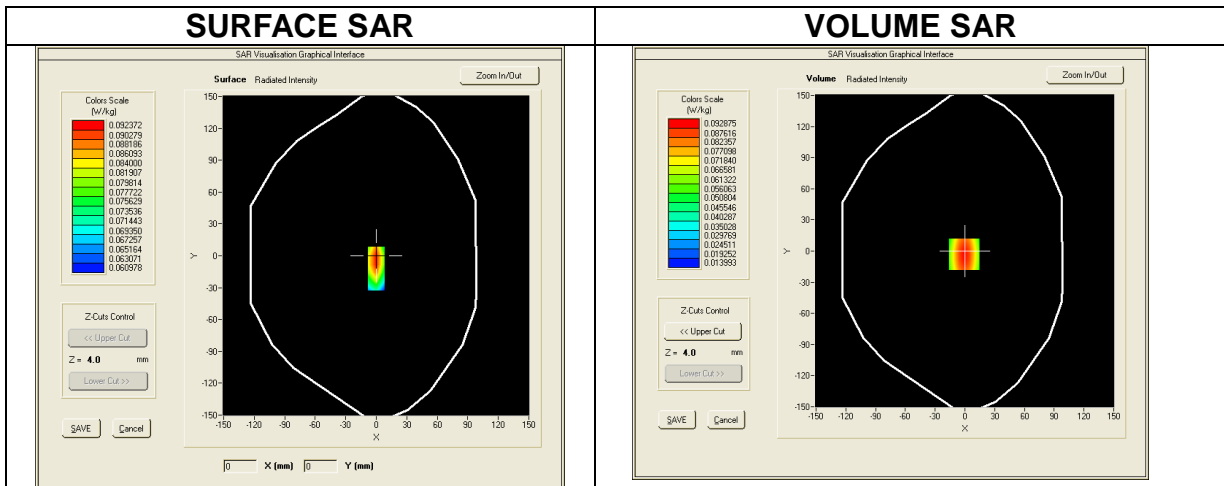

Maximum location: X=-1.00, Y=-3.00

SAR Peak: 0.13 W/kg

SAR 10g (W/Kg)	0.066207
SAR 1g (W/Kg)	0.097517

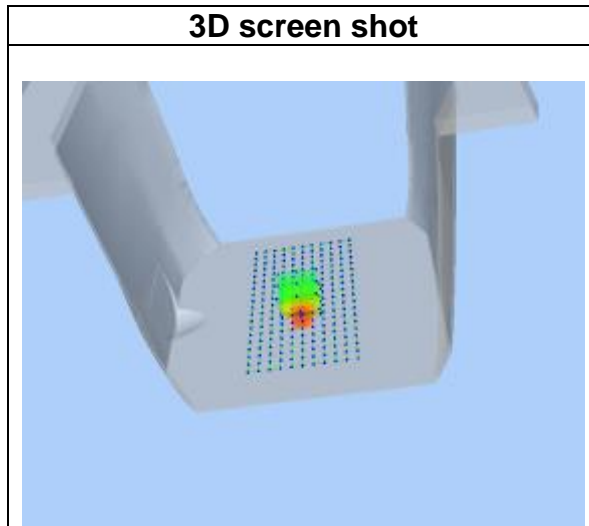
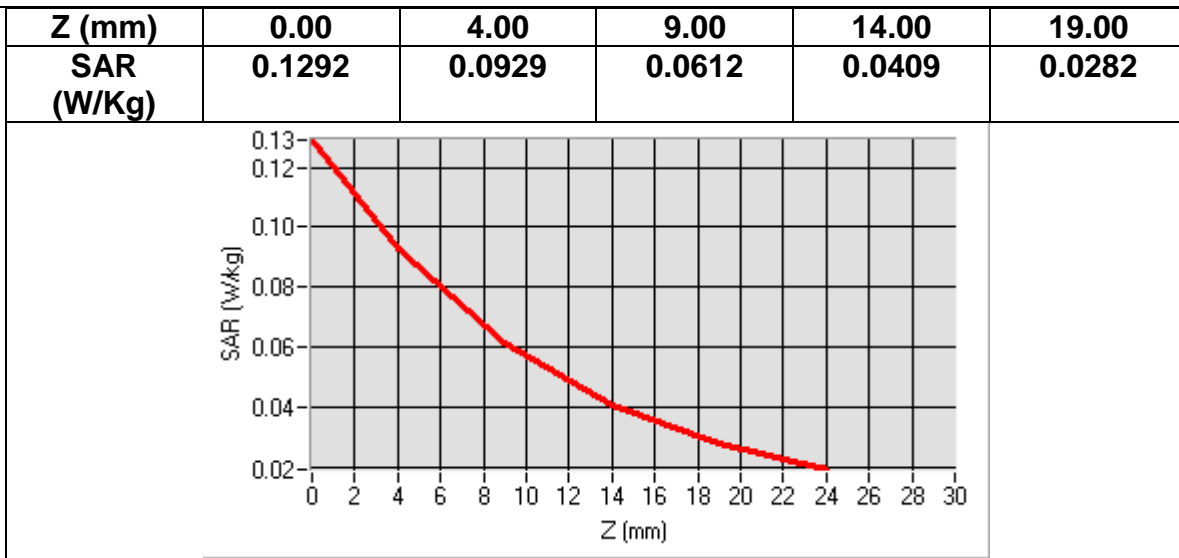

Date of measurement: 2016/07/01

Phantom: Validation plane

SAR Probe: SN_35/11_EP131

Input Power:10dBm

Dipole Model: 1800

Area Scan	<u>dx=8mm dy=8mmh= 5.00 mm</u>
ZoomScan	<u>7x7x7,dx=5mm dy=5mm dz=5mm, dx=8mm dy=8mm, h= 5.00 mm</u>
Phantom	<u>Validation plane</u>
Device Position	<u>Dipole</u>
Band	<u>CW1800</u>
Channels	<u>Middle</u>
Signal	<u>CW (Crest factor: 1.0)</u>
Frequency (MHz)	1800.000000
Relative permittivity (real part)	39.700000
Relative permittivity (imaginary part)	14.000000
Conductivity (S/m)	1.380000
Variation (%)	-0.460000

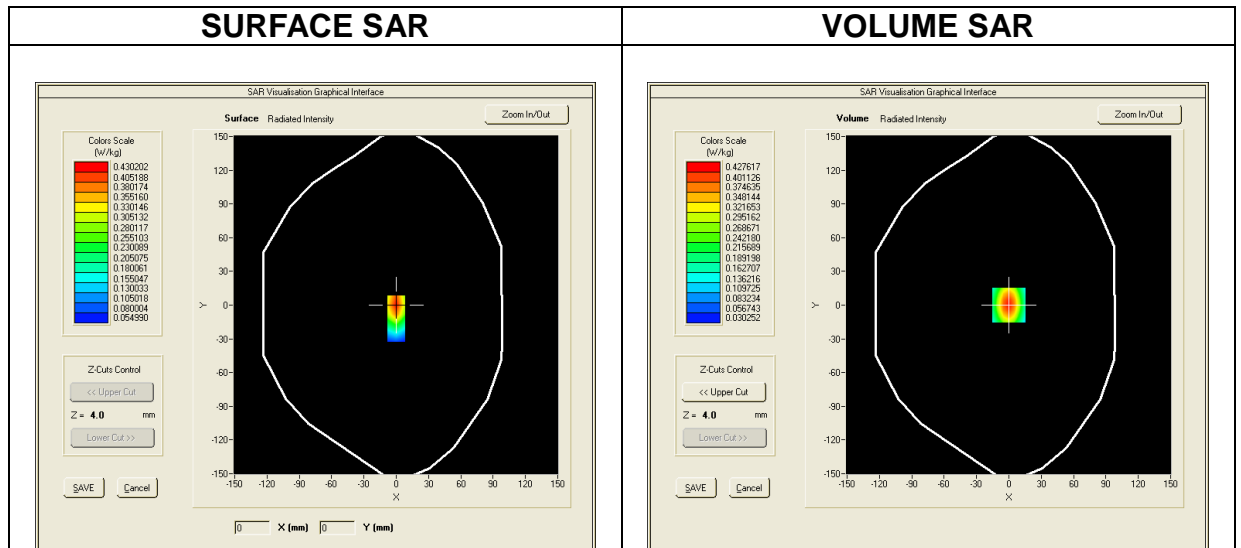

Maximum location: X=0.00, Y=0.00
SAR Peak: 0.66 W/kg

SAR 10g (W/Kg)	0.213295
SAR 1g (W/Kg)	0.390663

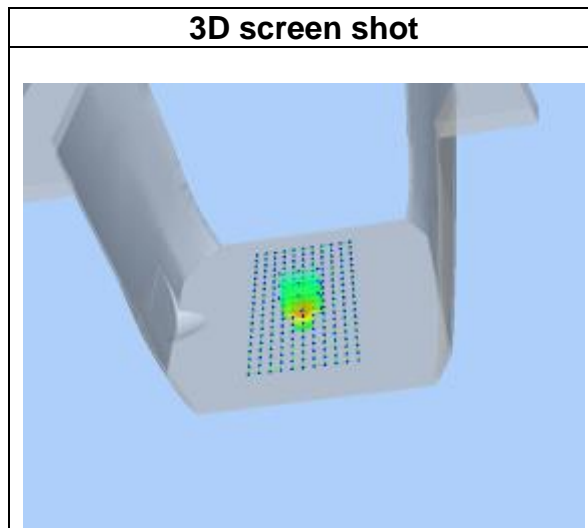
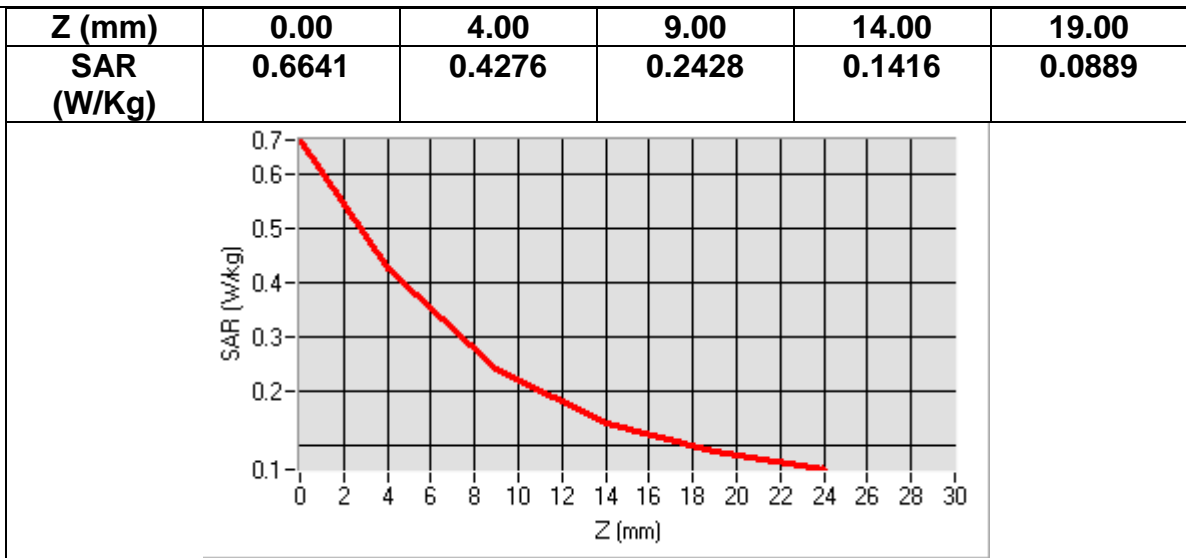

Date of measurement: 2016/07/01

Phantom: Validation plane

SAR Probe: SN_35/11_EP131

Input Power:10dBm

Dipole Model: 1900

Area Scan	<u>dx=8mm dy=8mmh= 5.00 mm</u>
ZoomScan	<u>7x7x7,dx=5mm dy=5mm dz=5mm, dx=8mm dy=8mm, h= 5.00 mm</u>
Phantom	<u>Validation plane</u>
Device Position	<u>Dipole</u>
Band	<u>CW1900</u>
Channels	<u>Middle</u>
Signal	<u>CW (Crest factor: 1.0)</u>
Frequency (MHz)	1900.000000
Relative permittivity (real part)	39.011199
Relative permittivity (imaginary part)	13.709900
Conductivity (S/m)	1.447156
Variation (%)	0.100000

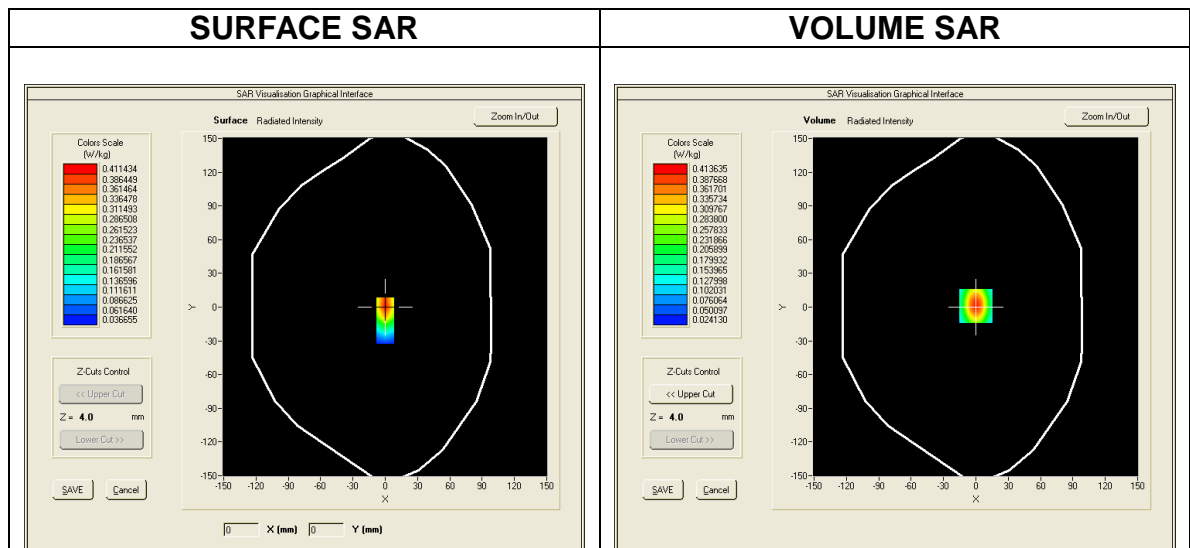

Maximum location: X=0.00, Y=1.00
SAR Peak: 0.66 W/kg

SAR 10g (W/Kg)	0.202414
SAR 1g (W/Kg)	0.387940

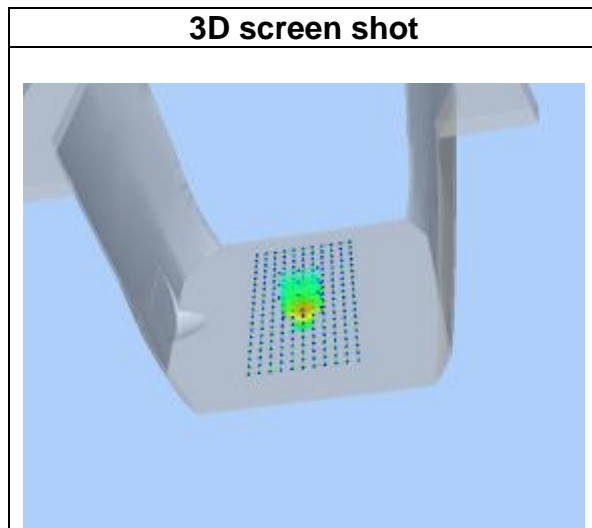
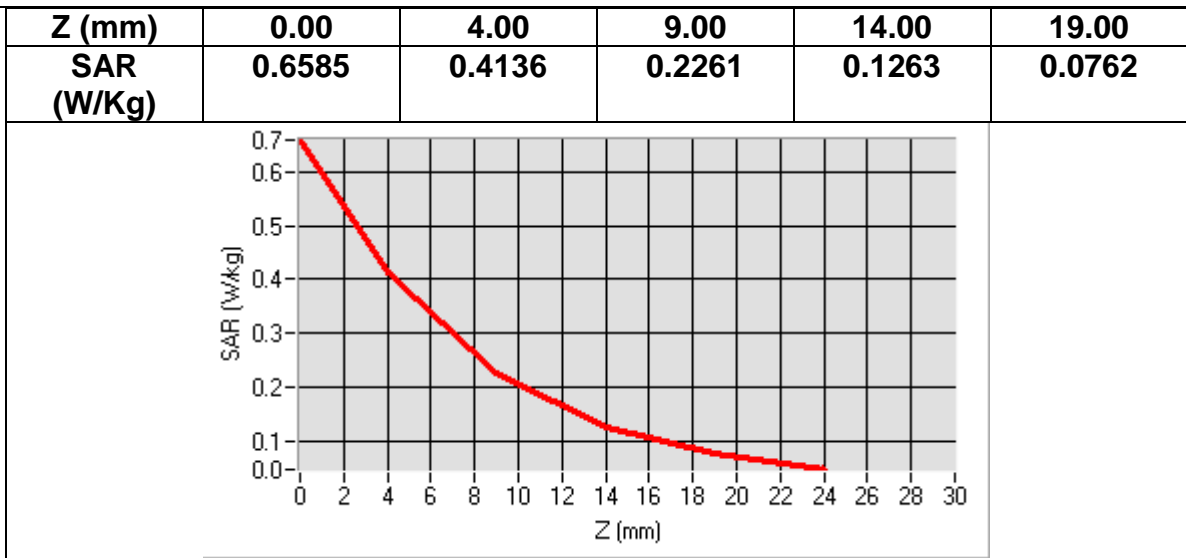

Date of measurement: 2016/07/01

Phantom: Validation plane

SAR Probe: SN_35/11_EP131

Input Power:10dBm

Dipole Model: 2000

Area Scan	<u>dx=8mm dy=8mmh= 5.00 mm</u>
ZoomScan	<u>7x7x7,dx=5mm dy=5mm dz=5mm, dx=8mm dy=8mm, h= 5.00 mm</u>
Phantom	<u>Validation plane</u>
Device Position	<u>Dipole</u>
Band	<u>CW2000</u>
Channels	<u>Middle</u>
Signal	<u>CW (Crest factor: 1.0)</u>
Frequency (MHz)	2000.000000
Relative permittivity (real part)	39.522998
Relative permittivity (imaginary part)	13.160700
Conductivity (S/m)	1.432300
Variation (%)	1.820000

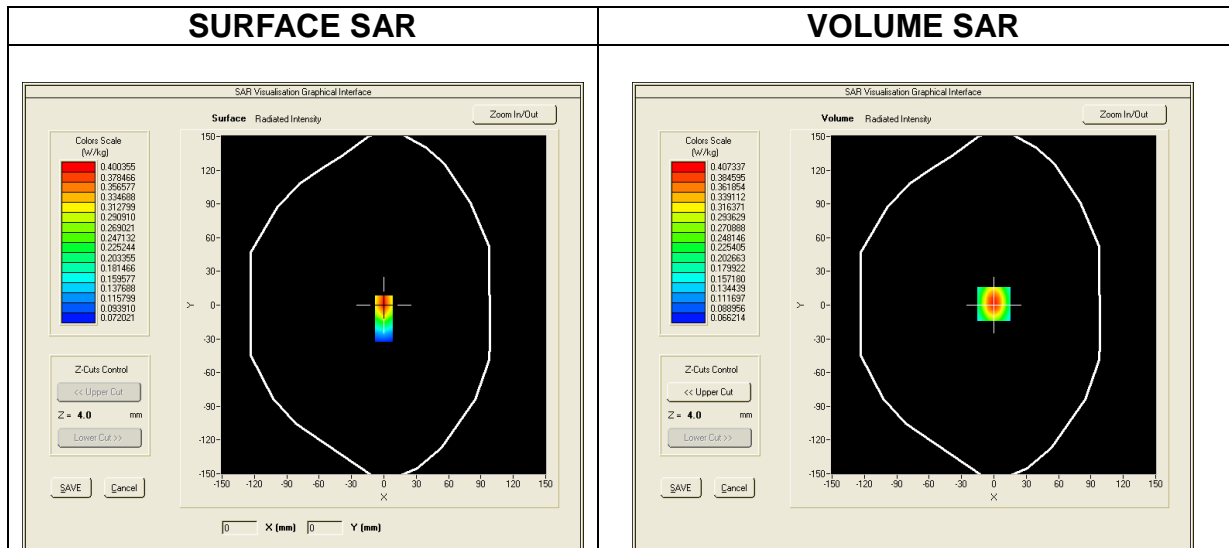

Maximum location: X=0.00, Y=1.00

SAR Peak: 0.61 W/kg

SAR 10g (W/Kg)	0.220569
SAR 1g (W/Kg)	0.386965

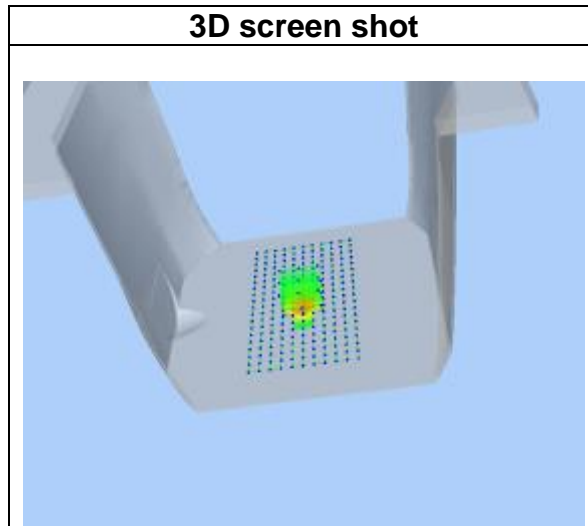
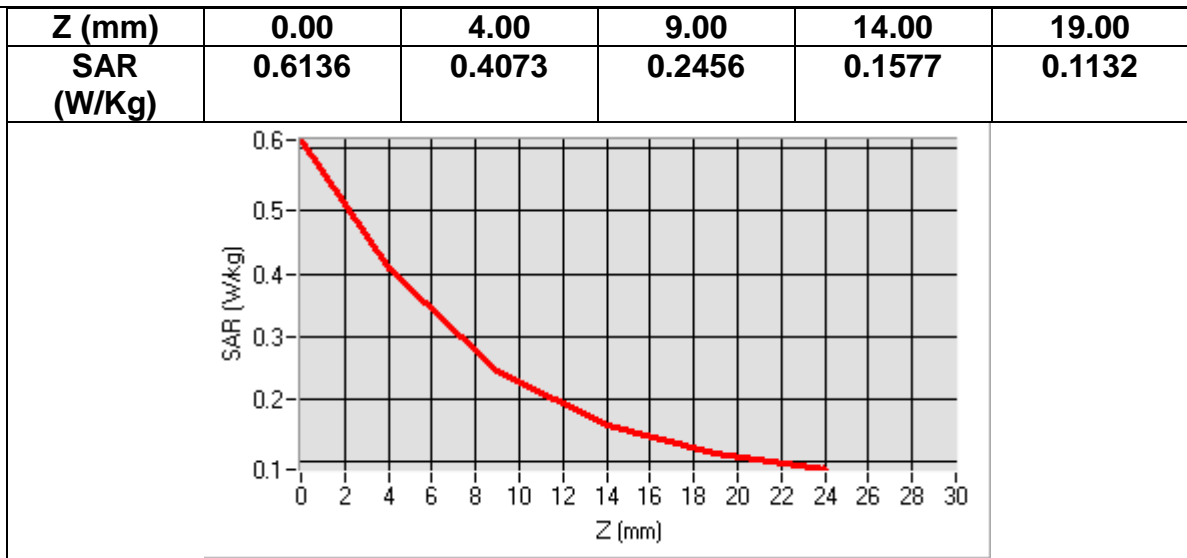

Date of measurement: 2016/07/08

Phantom: Validation plane

SAR Probe: SN_35/11_EP131

Input Power:10dBm

Dipole Model: 2450

<u>Area Scan</u>	<u>dx=8mm dy=8mmh= 5.00 mm</u>
<u>ZoomScan</u>	<u>7x7x7,dx=5mm dy=5mm dz=5mm, dx=8mm dy=8mm, h= 5.00 mm</u>
<u>Phantom</u>	<u>Validation plane</u>
<u>Device Position</u>	<u>Dipole</u>
<u>Band</u>	<u>CW2450</u>
<u>Channels</u>	<u>Middle</u>
<u>Signal</u>	<u>CW (Crest factor: 1.0)</u>
<u>Frequency (MHz)</u>	2450.000000
<u>Relative permittivity (real part)</u>	38.200001
<u>Relative permittivity (imaginary part)</u>	13.220000
<u>Conductivity (S/m)</u>	1.832389
<u>Variation (%)</u>	0.560000

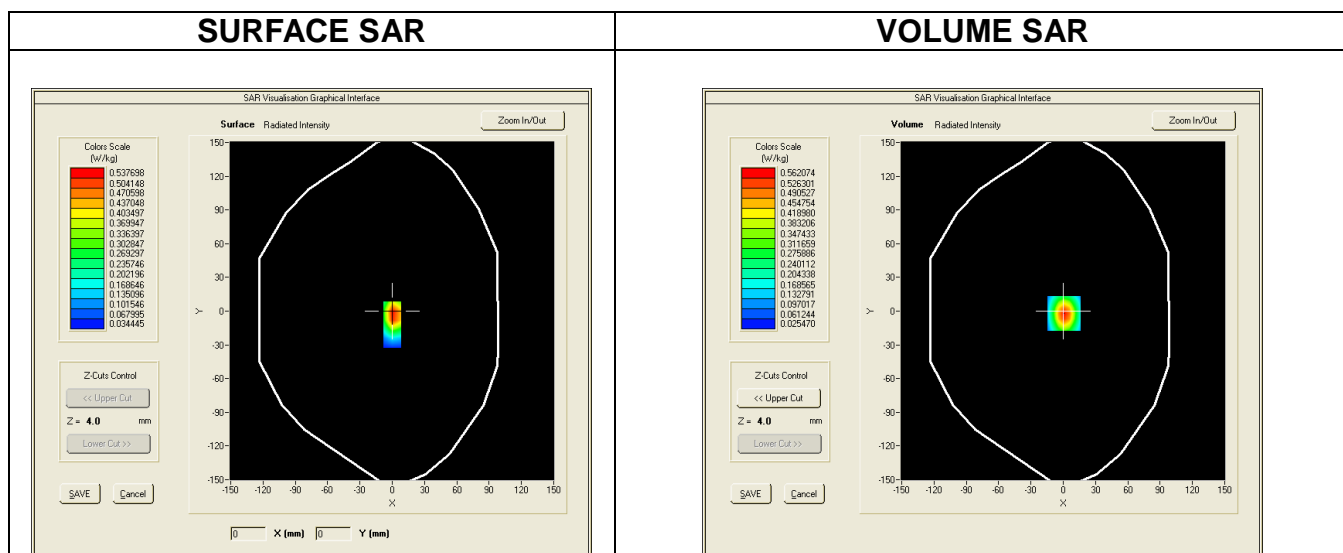

Maximum location: X=1.00, Y=-2.00

SAR Peak: 0.99 W/kg

SAR 10g (W/Kg)	0.235625
SAR 1g (W/Kg)	0.507325

Z (mm)	0.00	4.00	9.00	14.00	19.00
SAR (W/Kg)	0.9928	0.5621	0.2617	0.1241	0.0678

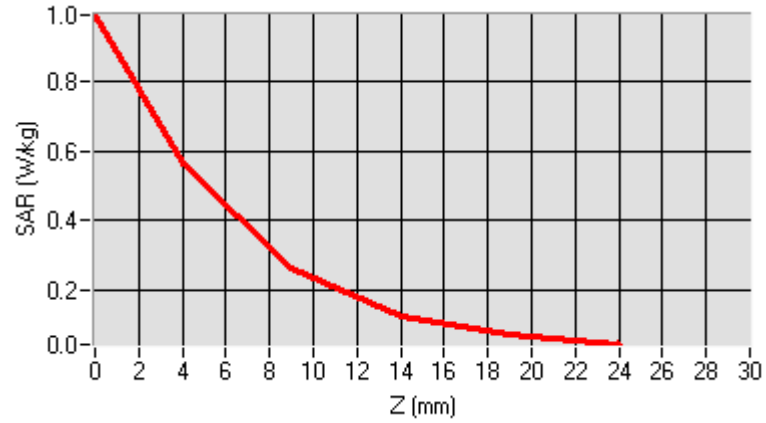

3D screen shot

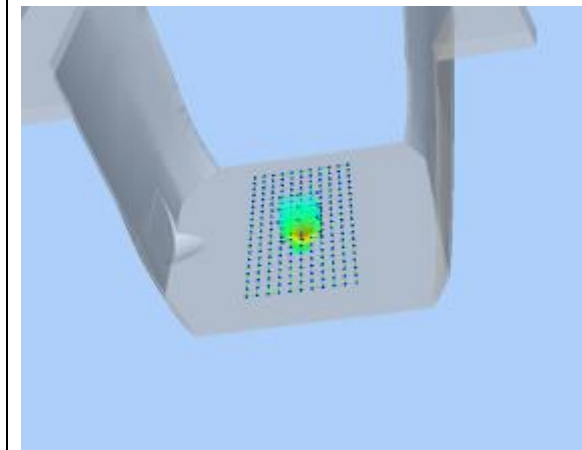

Date of measurement: 2016/07/05

Phantom: ELLI16

SAR Probe: SN_18/11_EP121

Input Power:20dBm

Dipole Model: CW835

<u>Area Scan</u>	<u>dx=8mm dy=8mmh= 5.00 mm</u>
<u>ZoomScan</u>	<u>7x7x7,dx=5mm dy=5mm dz=5mm, dx=8mm dy=8mm, h= 5.00 mm</u>
<u>Phantom</u>	<u>ELLI16</u>
<u>Device Position</u>	<u>Dipole</u>
<u>Band</u>	<u>CW835</u>
<u>Channels</u>	<u>Middle</u>
<u>Signal</u>	<u>CW (Crest factor: 1.0)</u>
Frequency (MHz)	835.000000
Relative permittivity (real part)	53.405901
Relative permittivity (imaginary part)	20.503599
Conductivity (S/m)	0.961139
Variation (%)	-0.250000

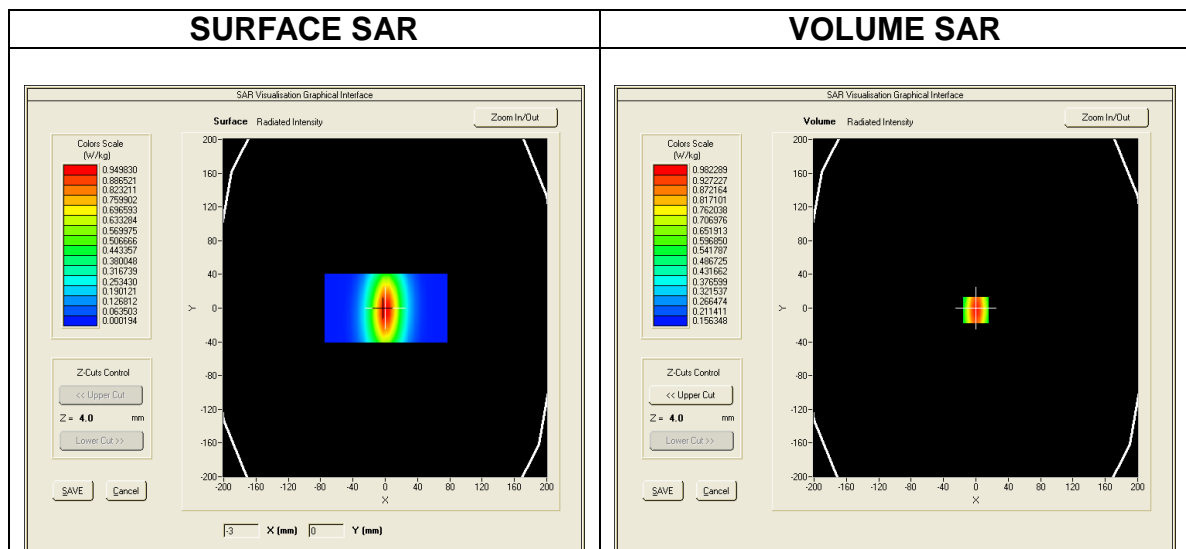

Maximum location: X=0.00, Y=-2.00
SAR Peak: 1.42 W/kg

SAR 10g (W/Kg)			0.634428		
SAR 1g (W/Kg)			0.975989		
Z (mm)	0.00	4.00	9.00	14.00	19.00
SAR (W/Kg)	1.3404	0.9823	0.6643	0.4556	0.3203

Z (mm)	SAR (W/kg)
0	1.3404
4	0.9823
9	0.6643
14	0.4556
19	0.3203

3D screen shot	Hot spot position

Date of measurement: 2016/07/07

Phantom: ELLI16

SAR Probe: SN_35/11_EP131

Input Power:20dBm

Dipole Model: 1800

<u>Area Scan</u>	<u>dx=8mm dy=8mmh= 5.00 mm</u>
<u>ZoomScan</u>	<u>7x7x7,dx=5mm dy=5mm dz=5mm, dx=8mm dy=8mm, h= 5.00 mm</u>
<u>Phantom</u>	<u>ELLI16</u>
<u>Device Position</u>	<u>Dipole</u>
<u>Band</u>	<u>CW1800</u>
<u>Channels</u>	<u>Middle</u>
<u>Signal</u>	<u>CW (Crest factor: 1.0)</u>
<u>Frequency (MHz)</u>	1800.000000
<u>Relative permittivity (real part)</u>	52.799999
<u>Relative permittivity (imaginary part)</u>	15.200000
<u>Conductivity (S/m)</u>	1.470000
<u>Variation (%)</u>	-0.470000

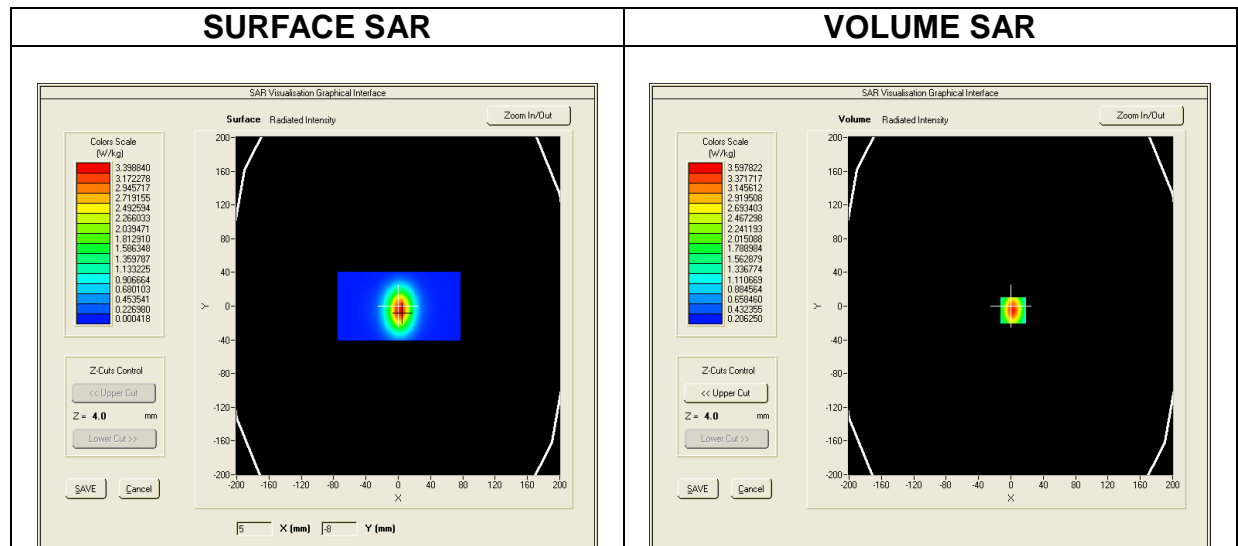

Maximum location: X=3.00, Y=-5.00
 SAR Peak: 5.69 W/kg

SAR 10g (W/Kg)			1.967121		
SAR 1g (W/Kg)			3.517022		
Z (mm)	0.00	4.00	9.00	14.00	19.00
SAR (W/Kg)	5.3304	3.5978	2.1729	1.3308	0.8479

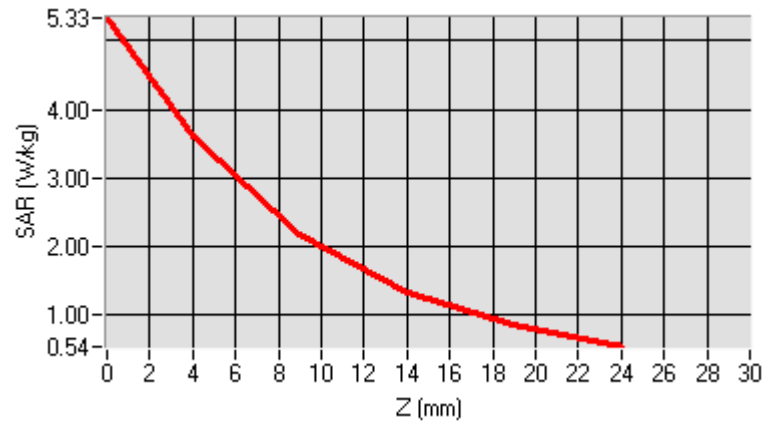

3D screen shot	Hot spot position

Date of measurement: 2016/07/07

Phantom: ELLI16

SAR Probe: SN_35/11_EP131

Input Power:20dBm

Dipole Model: 1900

<u>Area Scan</u>	<u>dx=8mm dy=8mmh= 5.00 mm</u>
<u>ZoomScan</u>	<u>7x7x7,dx=5mm dy=5mm dz=5mm, dx=8mm dy=8mm, h= 5.00 mm</u>
<u>Phantom</u>	<u>ELLI16</u>
<u>Device Position</u>	<u>Dipole</u>
<u>Band</u>	<u>CW1900</u>
<u>Channels</u>	<u>Middle</u>
<u>Signal</u>	<u>CW (Crest factor: 1.0)</u>
<u>Frequency (MHz)</u>	1900.000000
<u>Relative permittivity (real part)</u>	53.899999
<u>Relative permittivity (imaginary part)</u>	14.400000
<u>Conductivity (S/m)</u>	1.450000
<u>Variation (%)</u>	0.490000

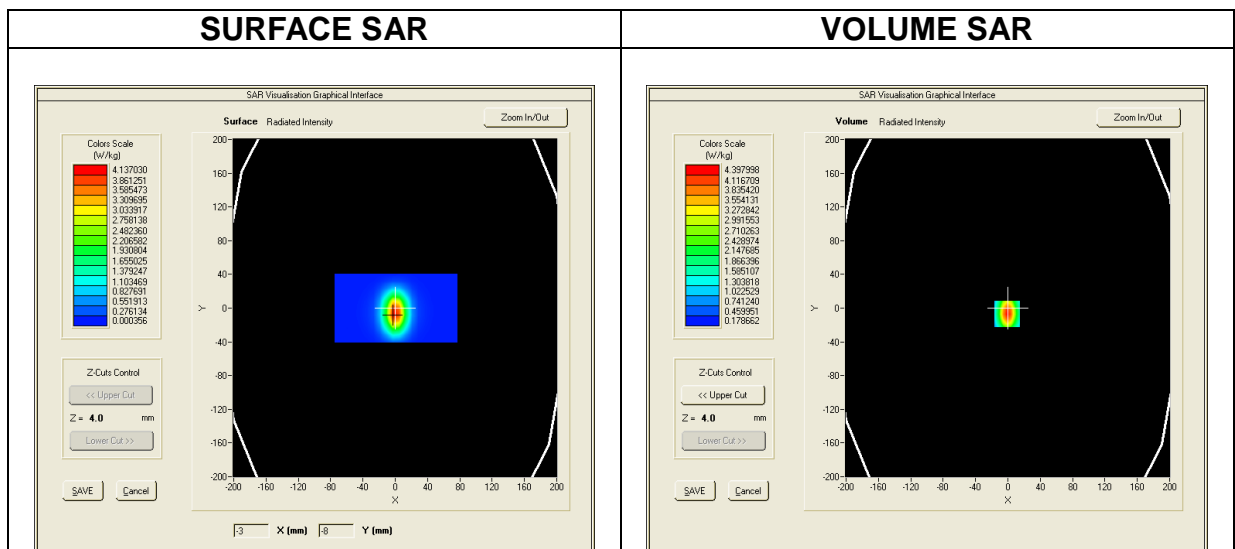

Maximum location: X=-1.00, Y=-7.00
SAR Peak: 7.14 W/kg

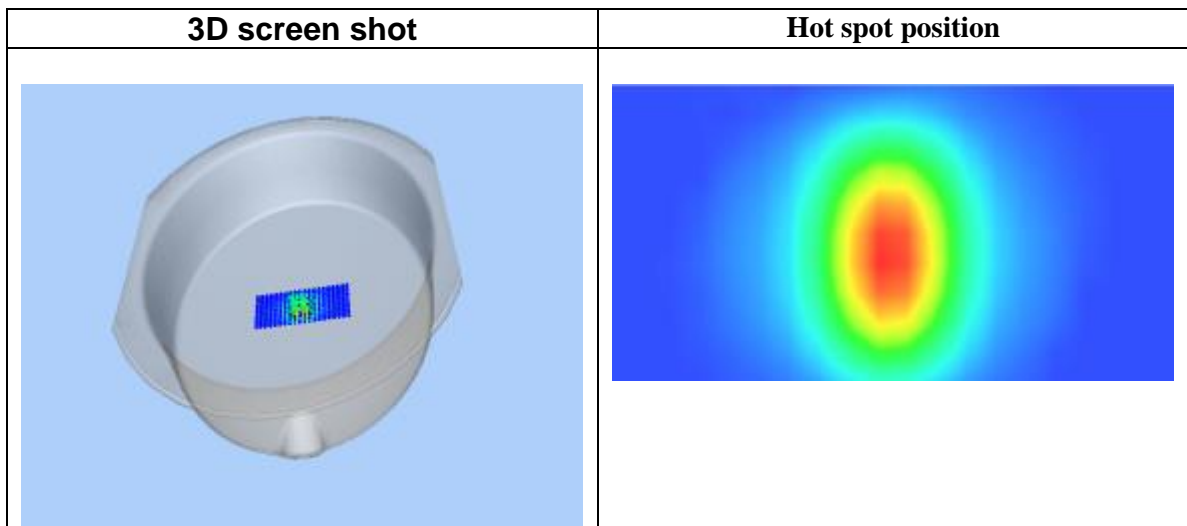
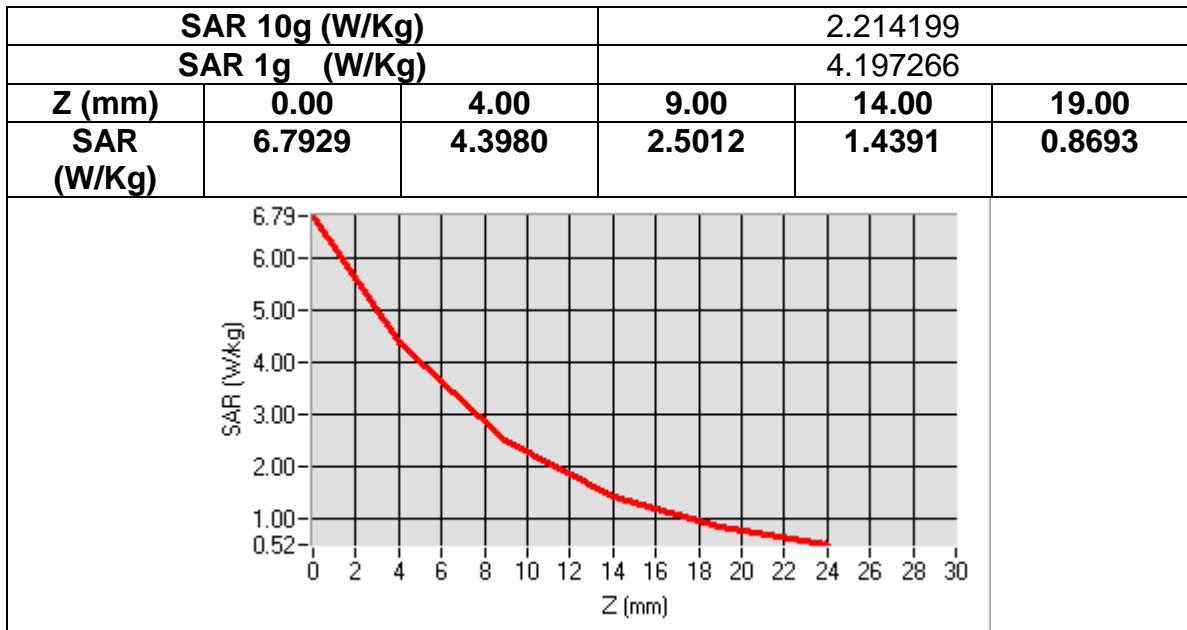

Date of measurement: 2016/07/07

Phantom: ELLI16

SAR Probe: SN_35/11_EP131

Input Power:20dBm

Dipole Model: 2000

<u>Area Scan</u>	<u>dx=8mm dy=8mmh= 5.00 mm</u>
<u>ZoomScan</u>	<u>7x7x7,dx=5mm dy=5mm dz=5mm, dx=8mm dy=8mm, h= 5.00 mm</u>
<u>Phantom</u>	<u>ELLI16</u>
<u>Device Position</u>	<u>Dipole</u>
<u>Band</u>	<u>CW2000</u>
<u>Channels</u>	<u>Middle</u>
<u>Signal</u>	<u>CW (Crest factor: 1.0)</u>
<u>Frequency (MHz)</u>	2000.000000
<u>Relative permittivity (real part)</u>	53.879999
<u>Relative permittivity (imaginary part)</u>	13.680000
<u>Conductivity (S/m)</u>	1.520000
<u>Variation (%)</u>	-0.170000

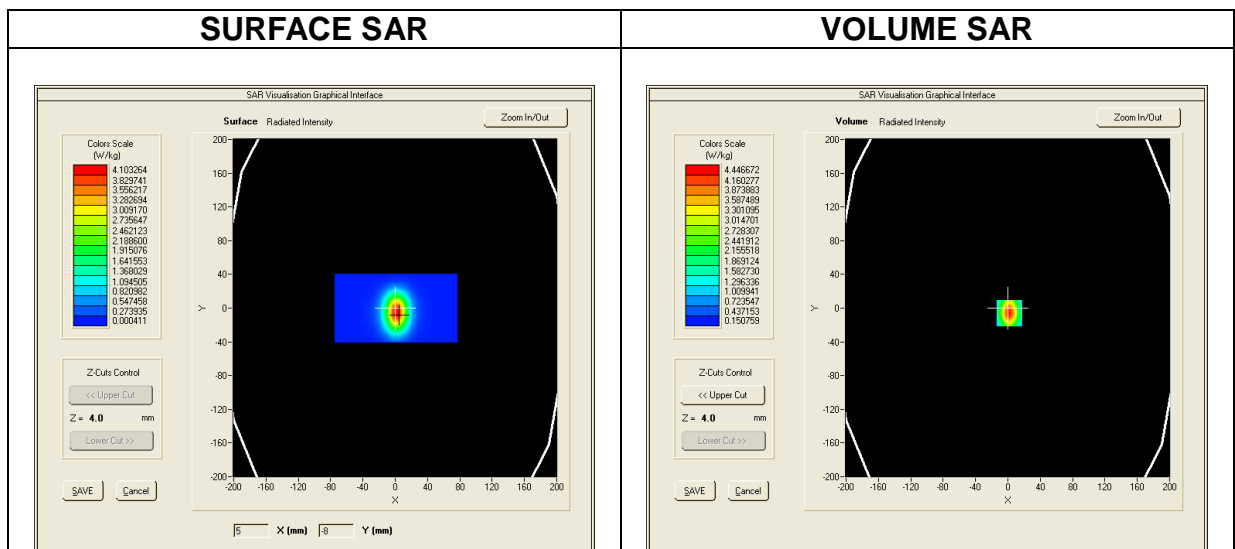

Maximum location: X=2.00, Y=-6.00
SAR Peak: 7.25 W/kg

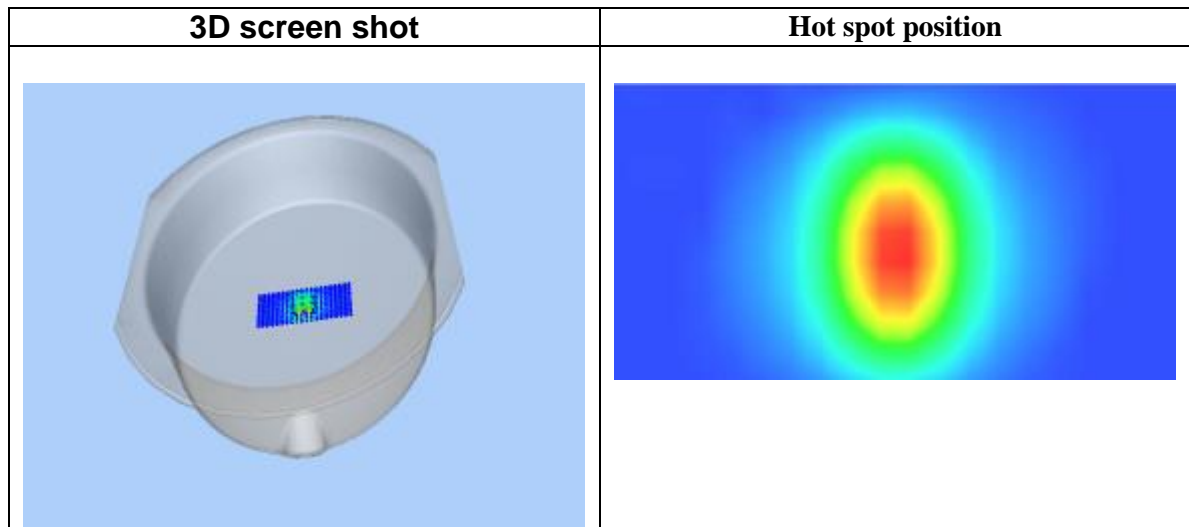
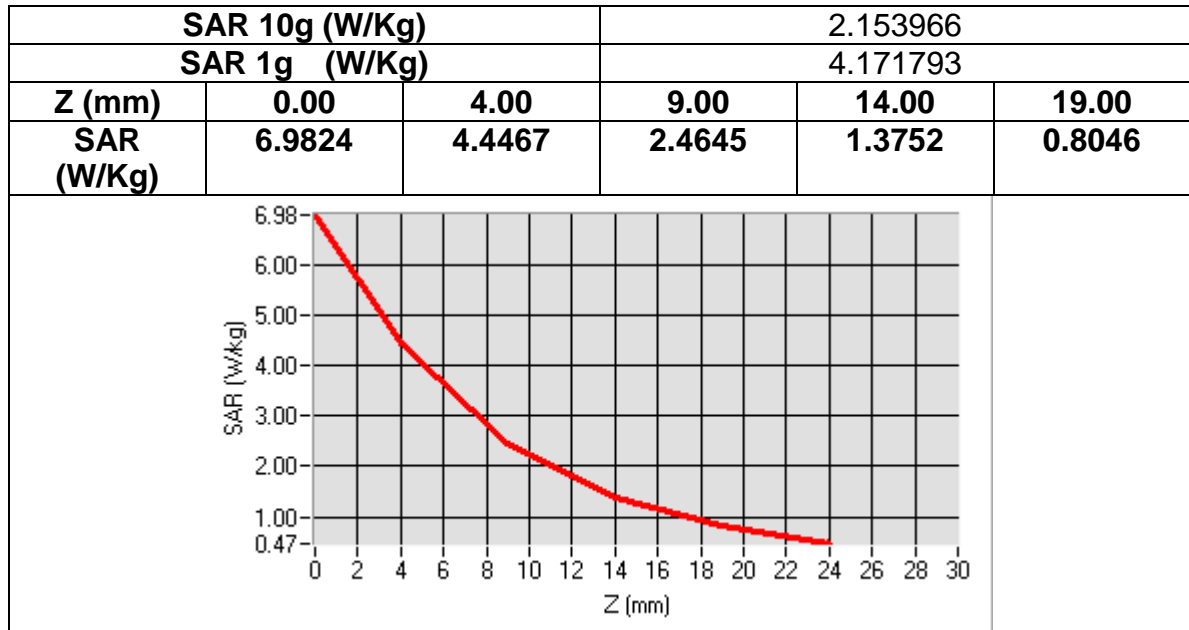

Date of measurement: 2016/07/08

Phantom: ELLI16

SAR Probe: SN_35/11_EP131

Input Power:20dBm

Dipole Model: 2450

<u>Area Scan</u>	<u>dx=8mm dy=8mmh= 5.00 mm</u>
<u>ZoomScan</u>	<u>7x7x7,dx=5mm dy=5mm dz=5mm, dx=8mm dy=8mm, h= 5.00 mm</u>
<u>Phantom</u>	<u>ELLI16</u>
<u>Device Position</u>	<u>Dipole</u>
<u>Band</u>	<u>CW2450</u>
<u>Channels</u>	<u>Middle</u>
<u>Signal</u>	<u>CW (Crest factor: 1.0)</u>
<u>Frequency (MHz)</u>	2450.000000
<u>Relative permittivity (real part)</u>	53.100001
<u>Relative permittivity (imaginary part)</u>	14.330000
<u>Conductivity (S/m)</u>	1.950472
<u>Variation (%)</u>	0.140000

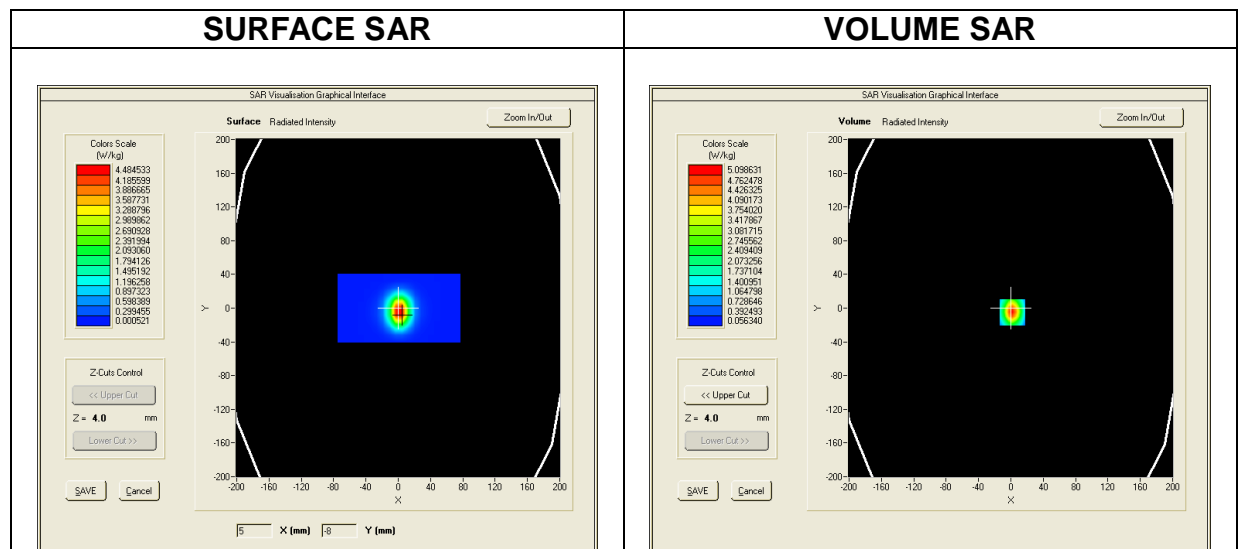

Maximum location: X=2.00, Y=-5.00
SAR Peak: 8.98W/kg

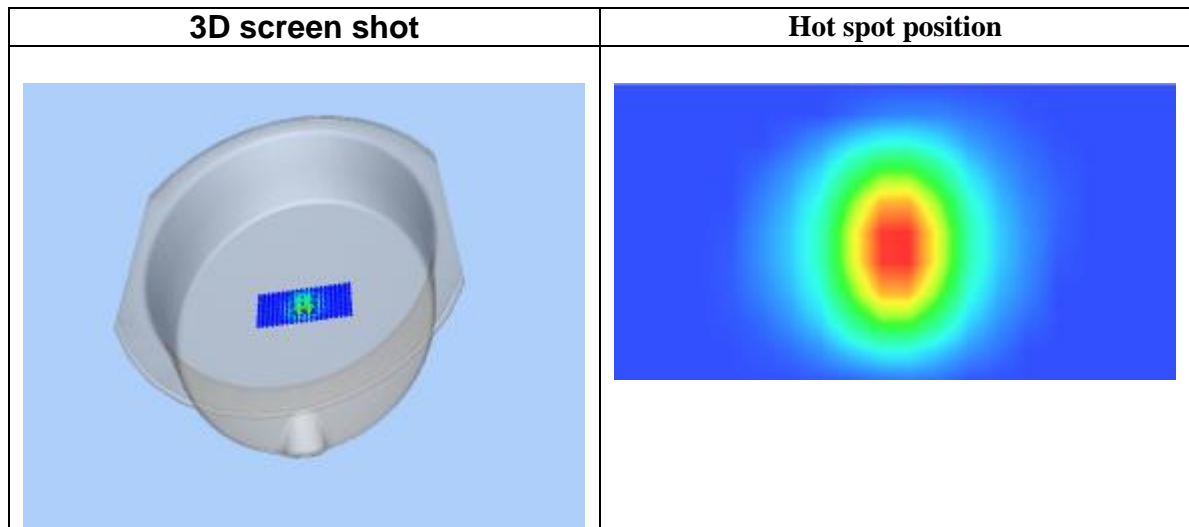
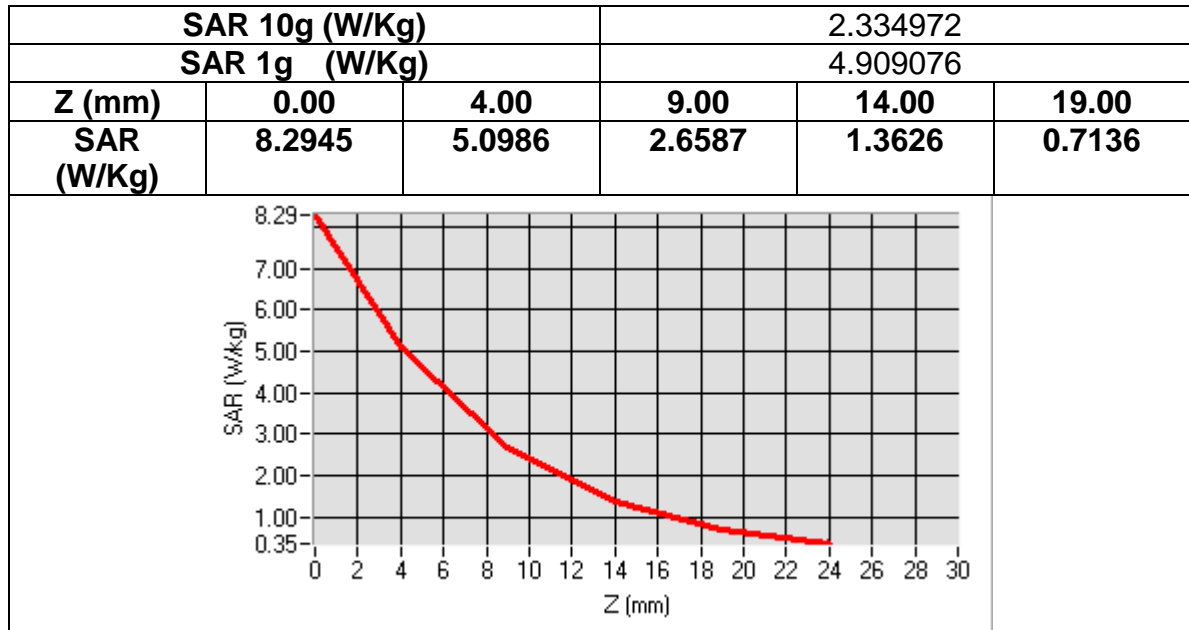

11. SAR TEST DATA

GSM850

MEASUREMENT 1
 Date of measurement: 2016/07/02

Area Scan	sam_direct_droit2_surf8mm.txt, h= 5.00 mm
Zoom Scan	7x7x7,dx=5mm dy=5mm dz=5mm, sam_direct_droit2_surf8mm.txt, h= 5.00 mm
Phantom	Right head
Device Position	Cheek
Band	GSM850+EDGE(1up1down)
Channels	Middle
Signal	TDMA (Crest factor: 8.0)

Frequency (MHz)	836.599976
Relative permittivity (real part)	41.500000
Relative permittivity (imaginary part)	19.400000
Conductivity (S/m)	0.901669
Variation (%)	1.480000

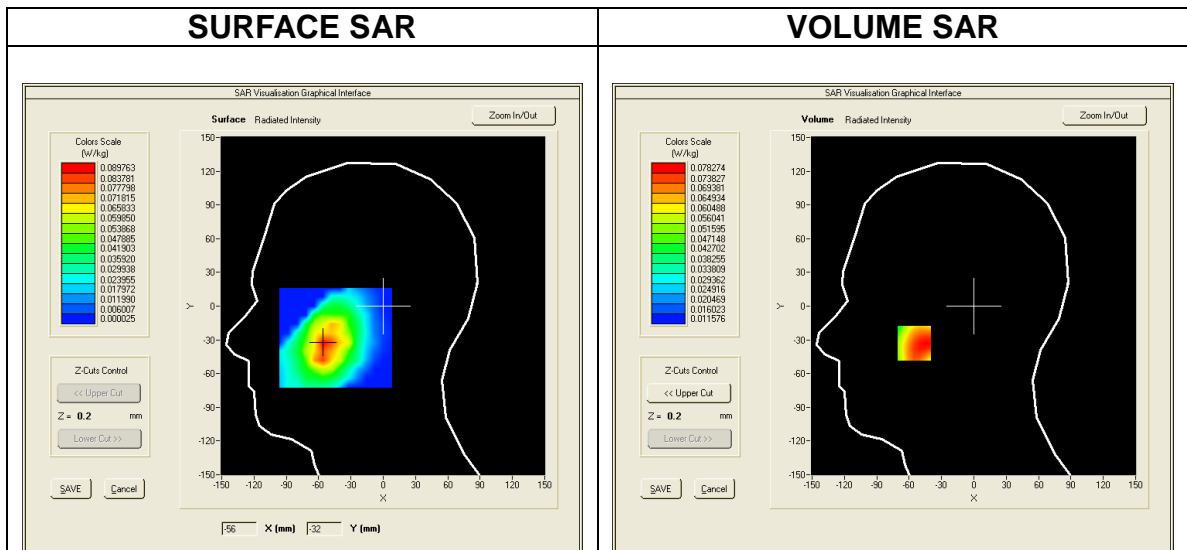

Maximum location: X=-55.00, Y=-33.00
SAR Peak: 0.10 W/kg

SAR 10g (W/Kg)	0.054973
SAR 1g (W/Kg)	0.075107

Z (mm)	0.00	4.00	9.00	14.00	19.00
SAR (W/Kg)	0.0915	0.0740	0.0574	0.0456	0.0374

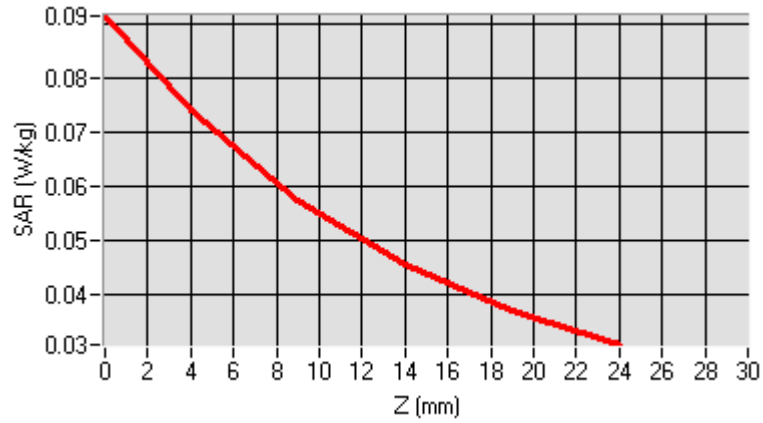

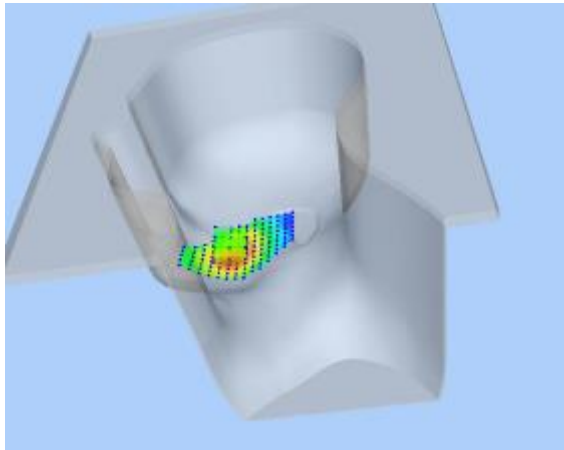
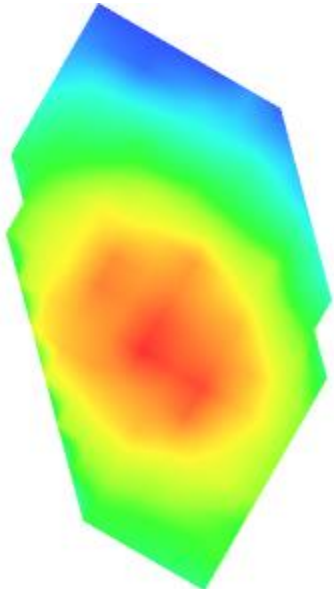
3D screen shot	Hot spot position
	

MEASUREMENT 2
Date of measurement: 2016/07/02

<u>Area Scan</u>	<u>sam_direct_droit2_surf8mm.txt, h= 5.00</u> <u>mm</u>
<u>Zoom Scan</u>	<u>7x7x7,dx=5mm dy=5mm dz=5mm,</u> <u>sam_direct_droit2_surf8mm.txt, h= 5.00</u> <u>mm</u>
<u>Phantom</u>	<u>Right head</u>
<u>Device Position</u>	<u>Cheek</u>
<u>Band</u>	<u>GSM850+GPRS(4up1down)</u>
<u>Channels</u>	<u>Middle</u>
<u>Signal</u>	<u>TDMA (Crest factor: 2.0)</u>

Frequency (MHz)	836.599976
Relative permittivity (real part)	41.500000
Relative permittivity (imaginary part)	19.400000
Conductivity (S/m)	0.901669
Variation (%)	-0.240000

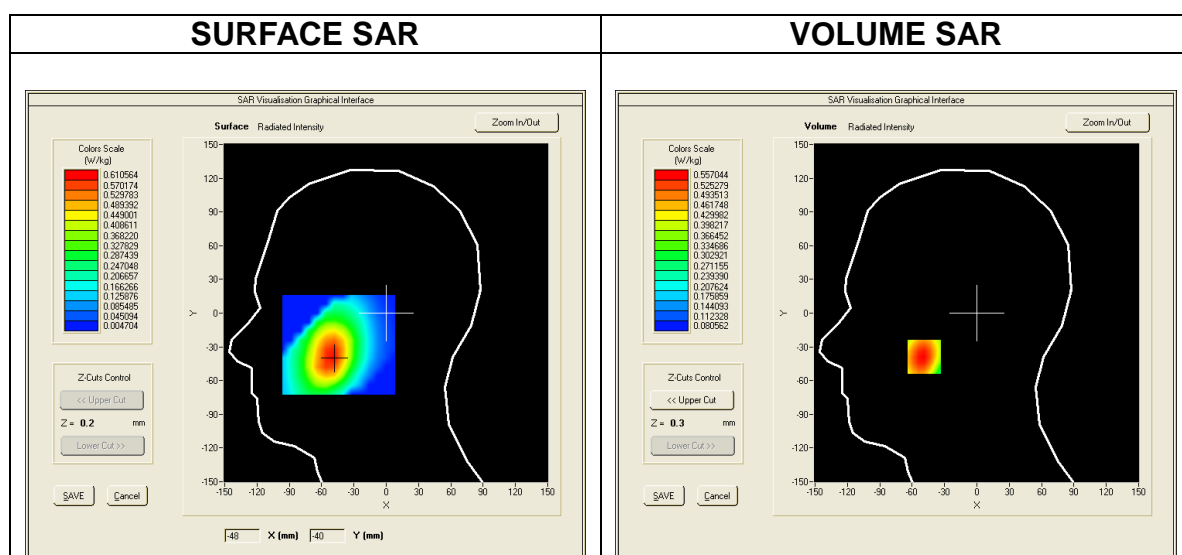

Maximum location: X=-49.00, Y=-39.00
SAR Peak: 0.71 W/kg

SAR 10g (W/Kg)	0.380958
-----------------------	----------

SAR 1g (W/Kg)	0.536970
----------------------	----------

Z (mm)	0.00	4.00	9.00	14.00	19.00
SAR (W/Kg)	0.7054	0.5570	0.4164	0.3161	0.2446

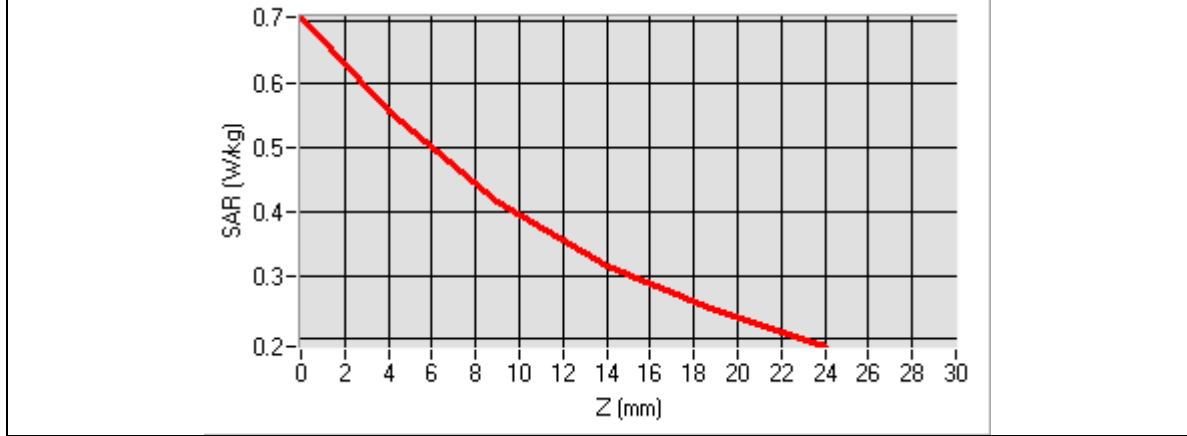

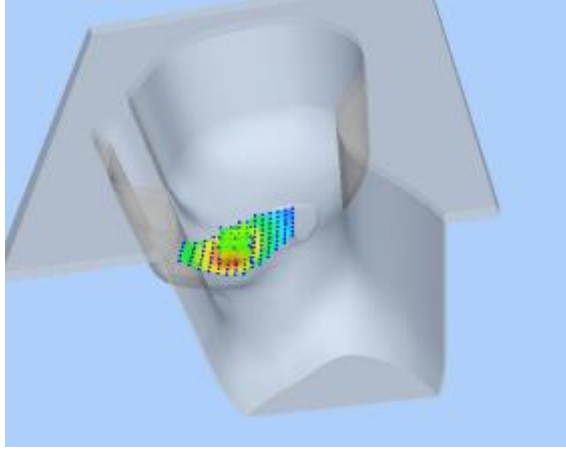
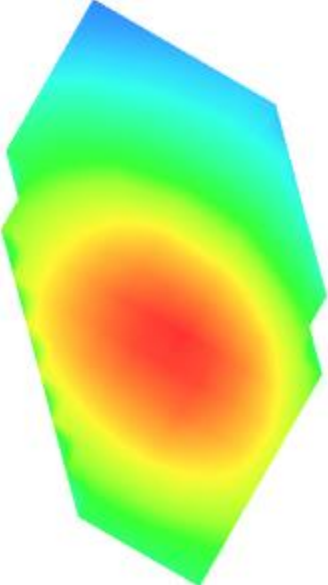
3D screen shot	Hot spot position
	

MEASUREMENT 3
 Date of measurement: 2016/07/02

Area Scan	<u>sam_direct_droit2_surf8mm.txt, h= 5.00 mm</u>
Zoom Scan	<u>7x7x7,dx=5mm dy=5mm dz=5mm, sam_direct_droit2_surf8mm.txt, h= 5.00 mm</u>
Phantom	<u>Right head</u>
Device Position	<u>Cheek</u>
Band	<u>GSM850+VOICE</u>
Channels	<u>Middle</u>
Signal	<u>TDMA (Crest factor: 8.0)</u>

Frequency (MHz)	836.599976
Relative permittivity (real part)	41.500000
Relative permittivity (imaginary part)	19.400000
Conductivity (S/m)	0.901669
Variation (%)	1.550000

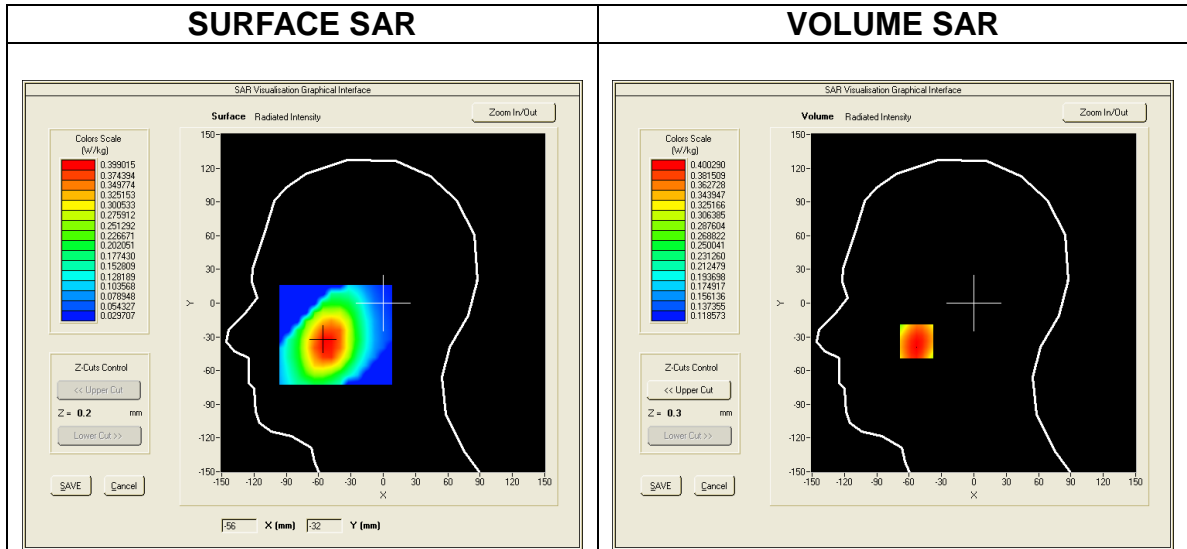

Maximum location: X=-53.00, Y=-34.00
SAR Peak: 0.49 W/kg

SAR 10g (W/Kg)	0.307696
SAR 1g (W/Kg)	0.392135

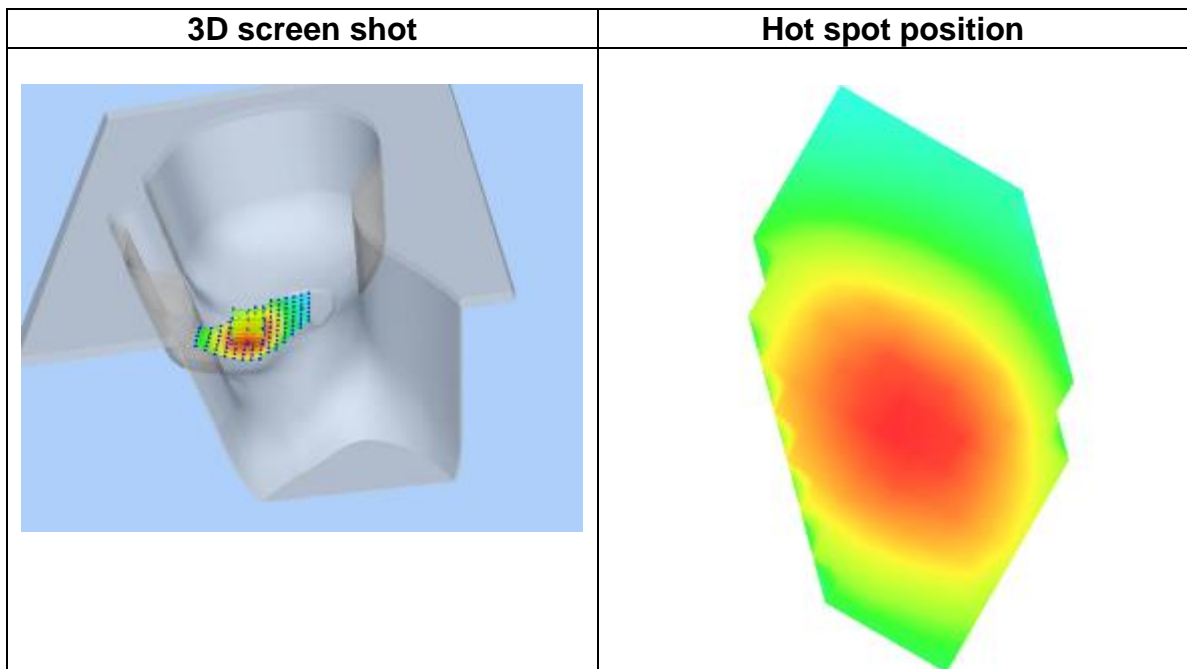
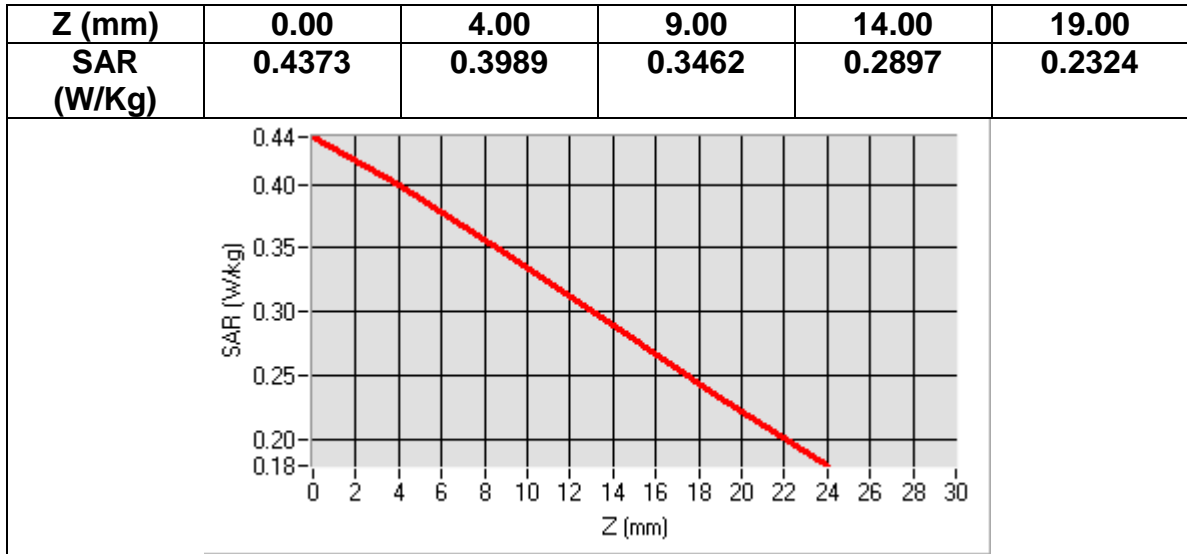

MEASUREMENT 4
 Date of measurement: 2016/07/02

Area Scan	<u>sam_direct_droit2_surf8mm.txt, h= 5.00 mm</u>
Zoom Scan	<u>7x7x7,dx=5mm dy=5mm dz=5mm, sam_direct_droit2_surf8mm.txt, h= 5.00 mm</u>
Phantom	<u>Right head</u>
Device Position	<u>Tilt</u>
Band	<u>GSM850+EDGE(1up1down)</u>
Channels	<u>Middle</u>
Signal	<u>TDMA (Crest factor: 8.0)</u>

Frequency (MHz)	836.599976
Relative permittivity (real part)	41.500000
Relative permittivity (imaginary part)	19.400000
Conductivity (S/m)	0.901669
Variation (%)	1.690000

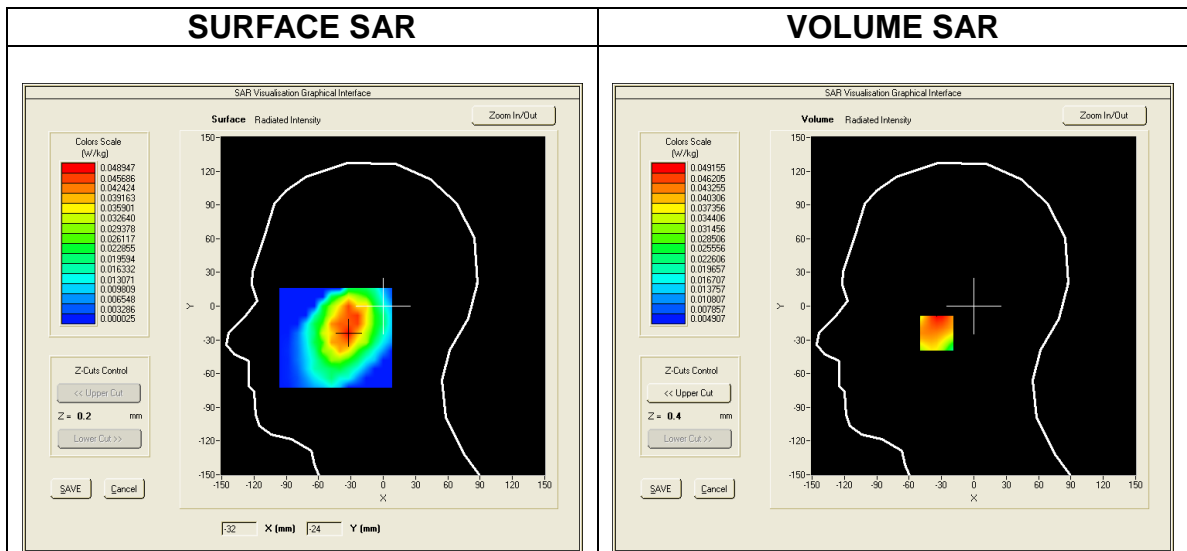

Maximum location: X=-32.00, Y=-24.00
SAR Peak: 0.07 W/kg

SAR 10g (W/Kg)	0.031719
SAR 1g (W/Kg)	0.046075

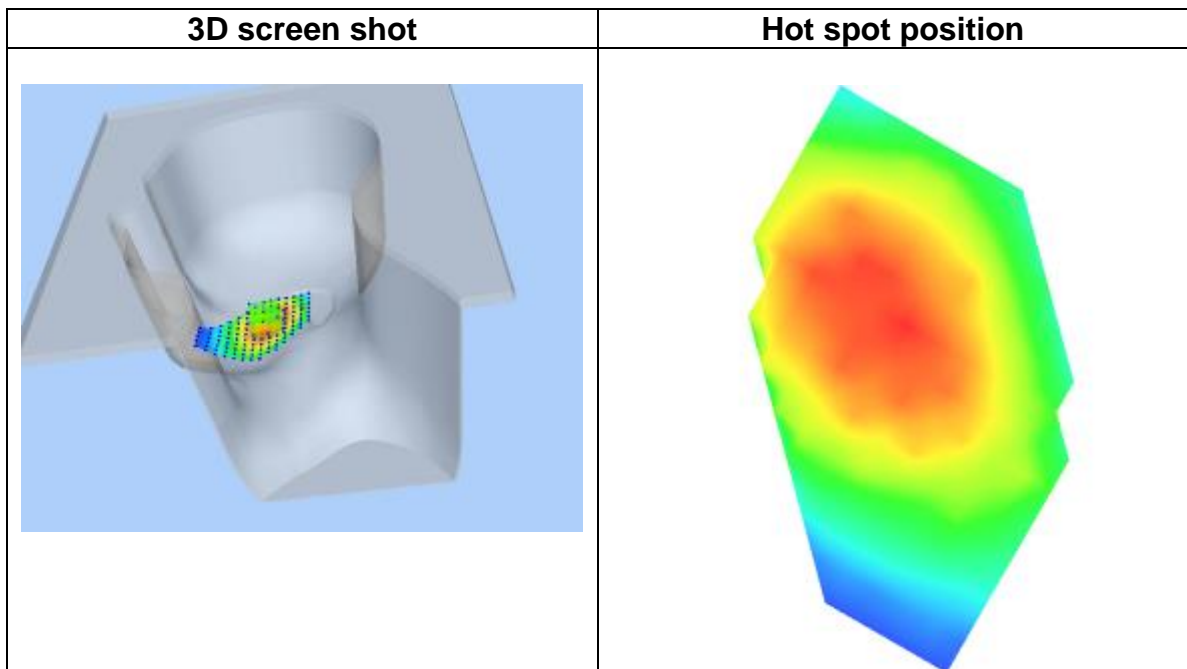
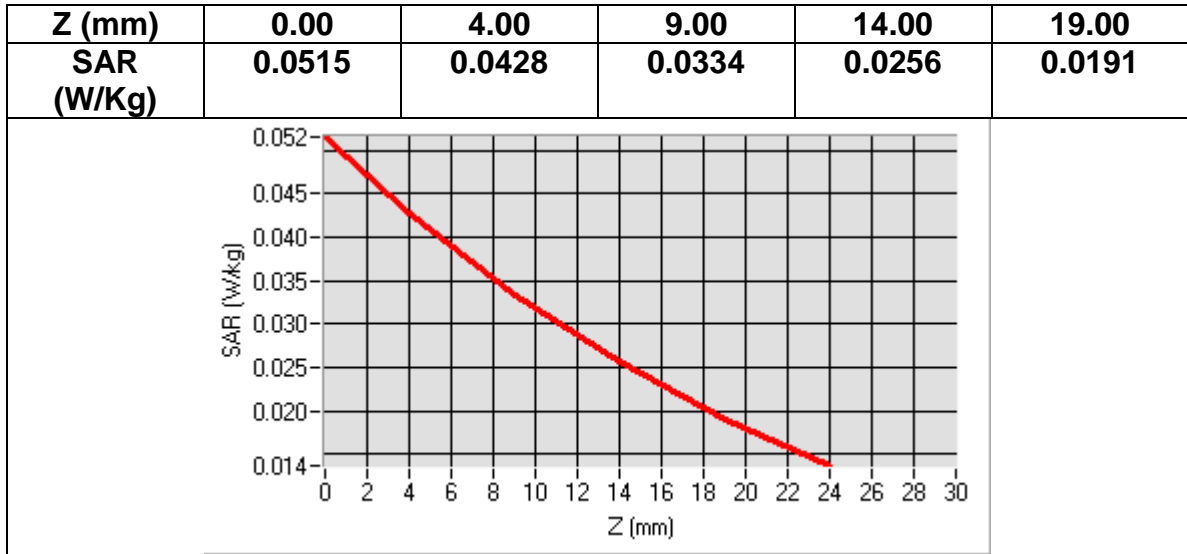

MEASUREMENT 5
Date of measurement: 2016/07/02

Area Scan	<u>sam_direct_droit2_surf8mm.txt, h= 5.00 mm</u>
Zoom Scan	<u>7x7x7,dx=5mm dy=5mm dz=5mm, sam_direct_droit2_surf8mm.txt, h= 5.00 mm</u>
Phantom	<u>Right head</u>
Device Position	<u>Tilt</u>
Band	<u>GSM850+GPRS(4up1down)</u>
Channels	<u>Middle</u>
Signal	<u>TDMA (Crest factor: 2.0)</u>

Frequency (MHz)	836.599976
Relative permittivity (real part)	41.500000
Relative permittivity (imaginary part)	19.400000
Conductivity (S/m)	0.901669
Variation (%)	1.120000

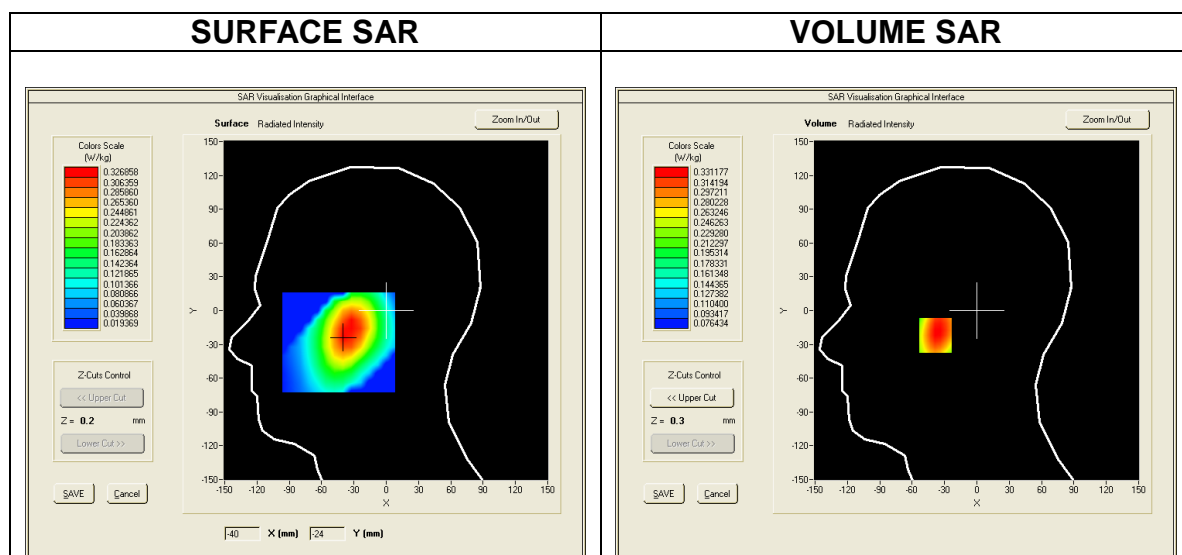

Maximum location: X=-38.00, Y=-22.00
SAR Peak: 0.42 W/kg

SAR 10g (W/Kg)	0.235332
SAR 1g (W/Kg)	0.320788

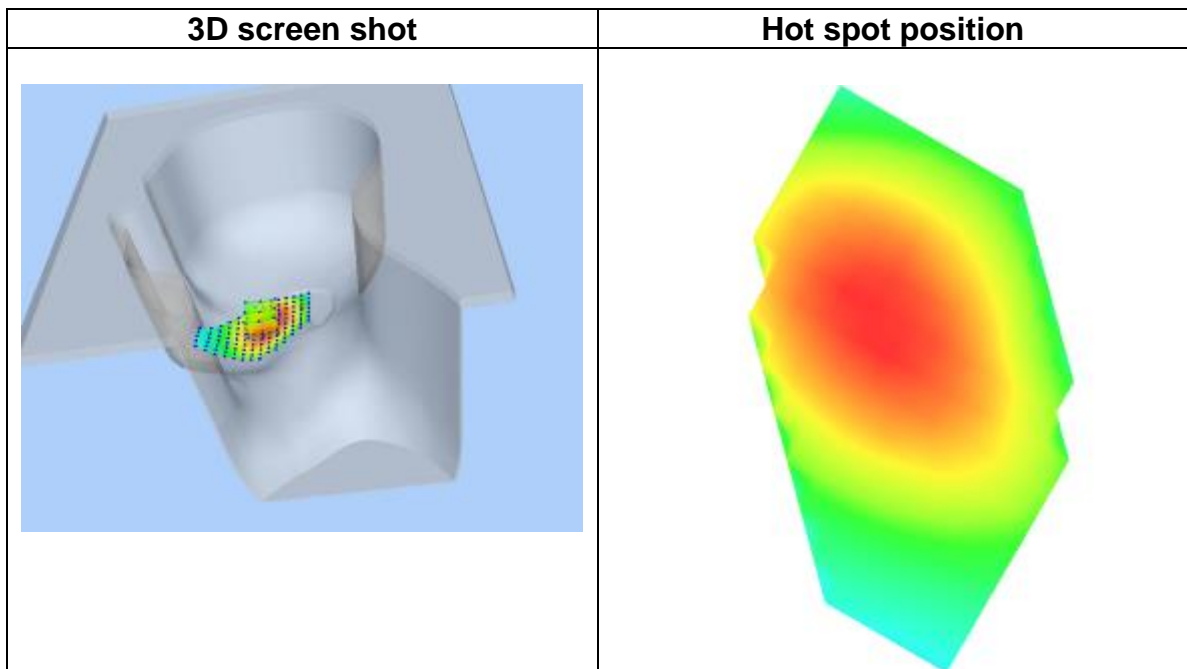
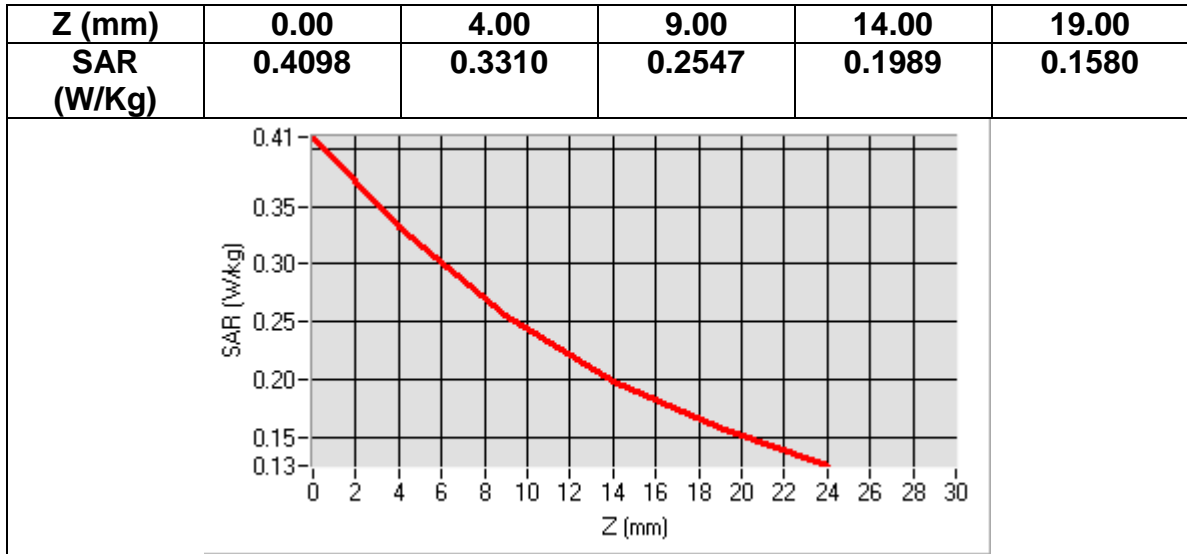

MEASUREMENT 6
 Date of measurement: 2016/07/02

<u>Area Scan</u>	<u>sam_direct_droit2_surf8mm.txt, h= 5.00 mm</u>
<u>Zoom Scan</u>	<u>7x7x7,dx=5mm dy=5mm dz=5mm, sam_direct_droit2_surf8mm.txt, h= 5.00 mm</u>
<u>Phantom</u>	<u>Right head</u>
<u>Device Position</u>	<u>Tilt</u>
<u>Band</u>	<u>GSM850+VOICE</u>
<u>Channels</u>	<u>Middle</u>
<u>Signal</u>	<u>TDMA (Crest factor: 8.0)</u>

Frequency (MHz)	836.599976
Relative permittivity (real part)	41.500000
Relative permittivity (imaginary part)	19.400000
Conductivity (S/m)	0.901669
Variation (%)	2.290000

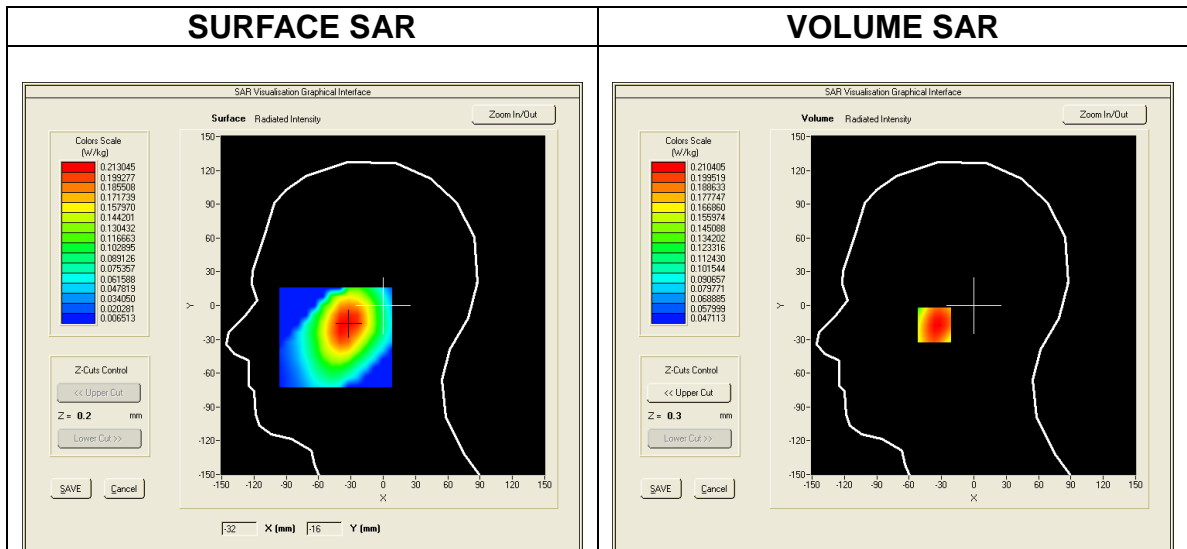

Maximum location: X=-36.00, Y=-17.00
SAR Peak: 0.25 W/kg

SAR 10g (W/Kg)	0.153208
SAR 1g (W/Kg)	0.203843

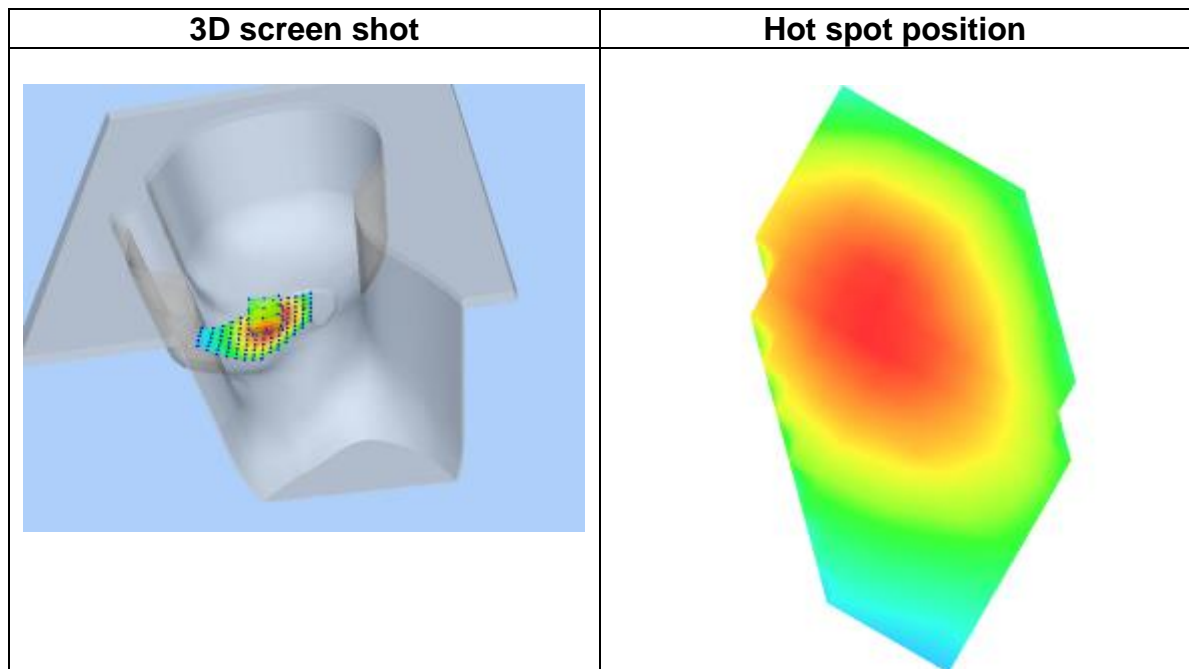
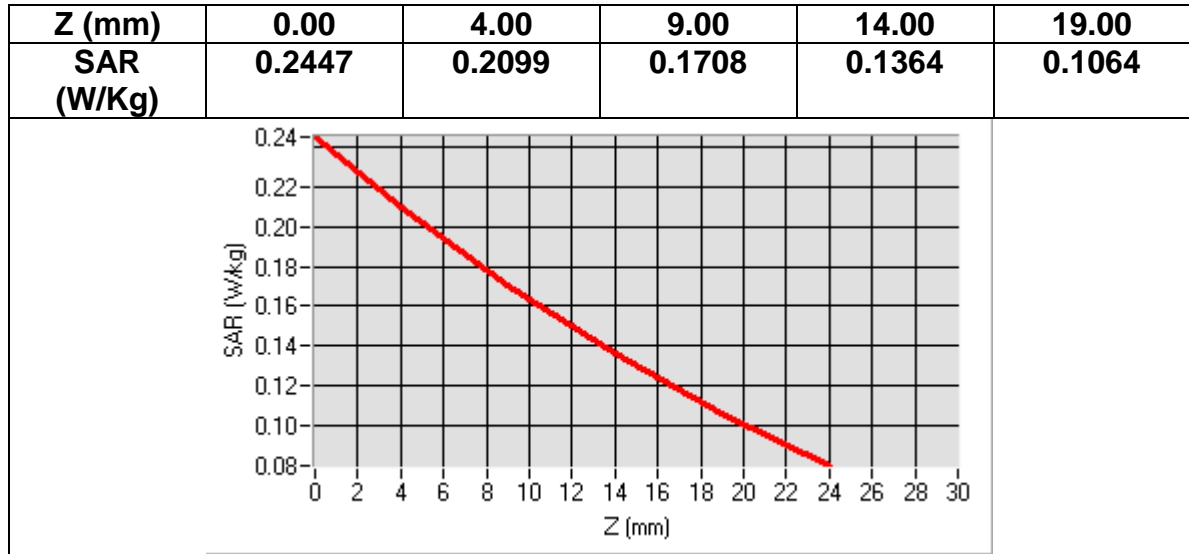

MEASUREMENT 7
Date of measurement: 2016/07/02

Area Scan	<u>sam_direct_droit2_surf8mm.txt, h= 5.00 mm</u>
Zoom Scan	<u>7x7x7,dx=5mm dy=5mm dz=5mm, sam_direct_droit2_surf8mm.txt, h= 5.00 mm</u>
Phantom	<u>Left head</u>
Device Position	<u>Cheek</u>
Band	<u>GSM850+EDGE(1up1down)</u>
Channels	<u>Middle</u>
Signal	<u>TDMA (Crest factor: 8.0)</u>

Frequency (MHz)	836.599976
Relative permittivity (real part)	41.500000
Relative permittivity (imaginary part)	19.400000
Conductivity (S/m)	0.901669
Variation (%)	4.570000

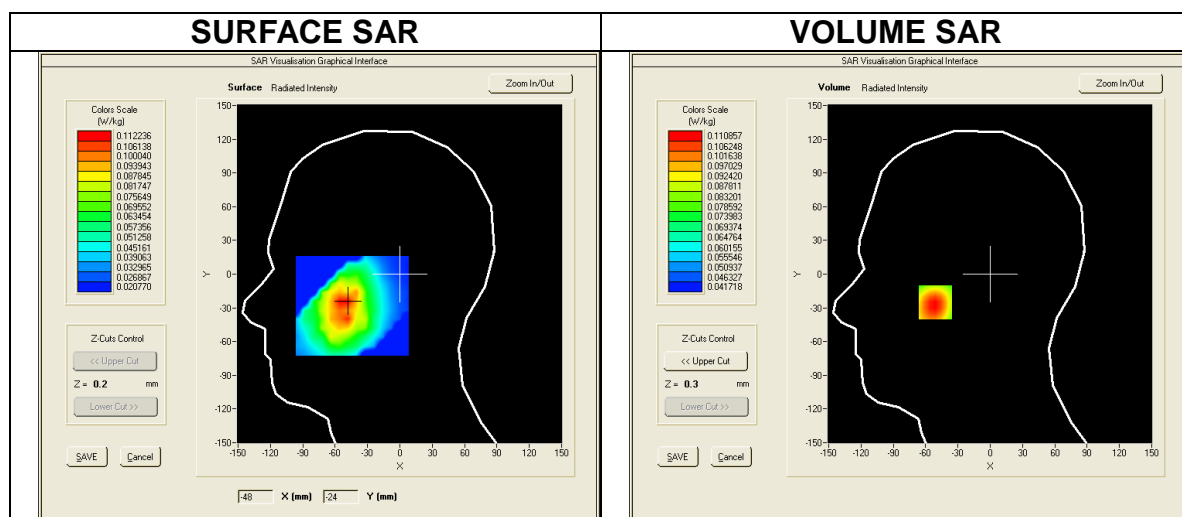

Maximum location: X=-51.00, Y=-25.00
SAR Peak: 0.14 W/kg

SAR 10g (W/Kg)	0.083328
SAR 1g (W/Kg)	0.107266

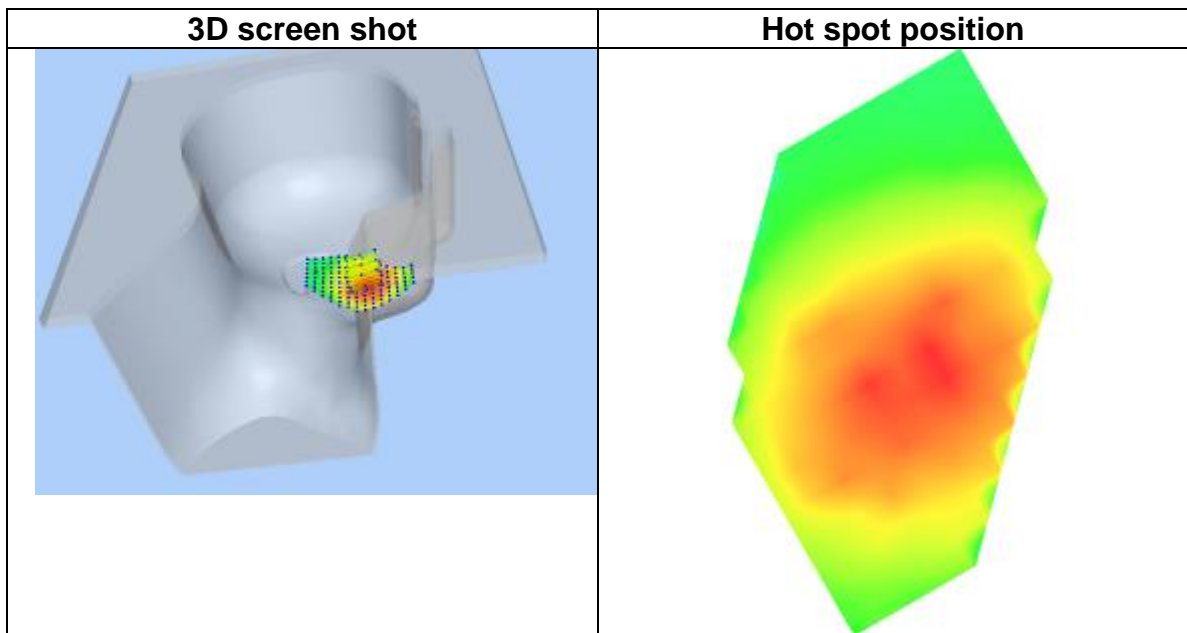
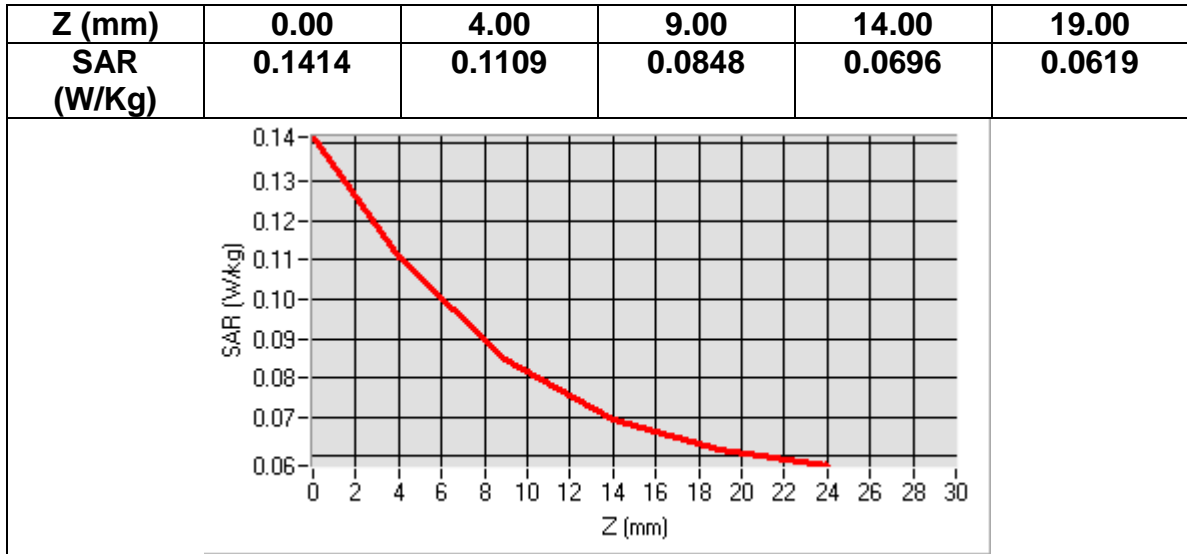

MEASUREMENT 8
Date of measurement: 2016/07/02

Area Scan	<u>sam_direct_droit2_surf8mm.txt, h= 5.00 mm</u>
Zoom Scan	<u>7x7x7,dx=5mm dy=5mm dz=5mm, sam_direct_droit2_surf8mm.txt, h= 5.00 mm</u>
Phantom	<u>Left head</u>
Device Position	<u>Cheek</u>
Band	<u>GSM850+GPRS(4up1down)</u>
Channels	<u>Middle</u>
Signal	<u>TDMA (Crest factor: 2.0)</u>

Frequency (MHz)	836.599976
Relative permittivity (real part)	41.500000
Relative permittivity (imaginary part)	19.400000
Conductivity (S/m)	0.901669
Variation (%)	-0.010000

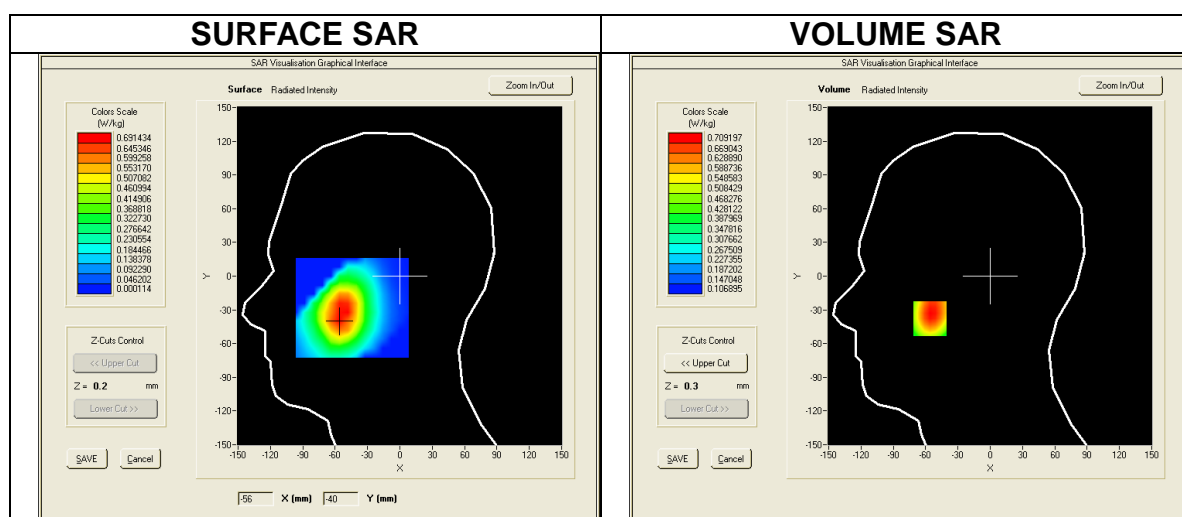

Maximum location: X=-56.00, Y=-38.00
SAR Peak: 0.93 W/kg

SAR 10g (W/Kg)	0.472578
SAR 1g (W/Kg)	0.678015

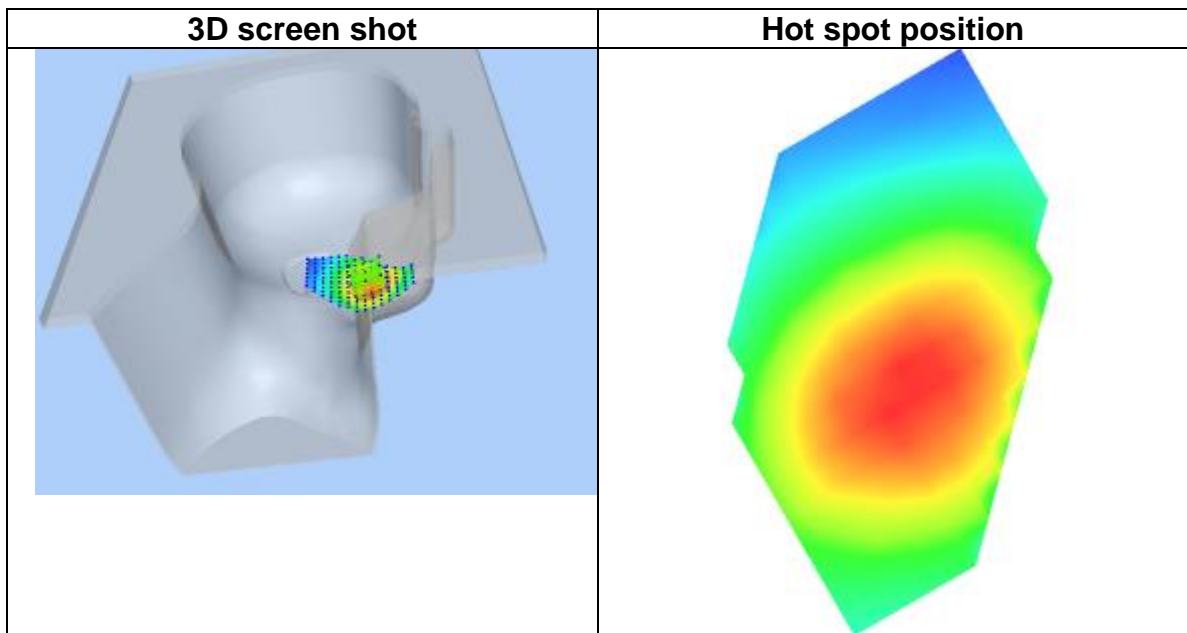
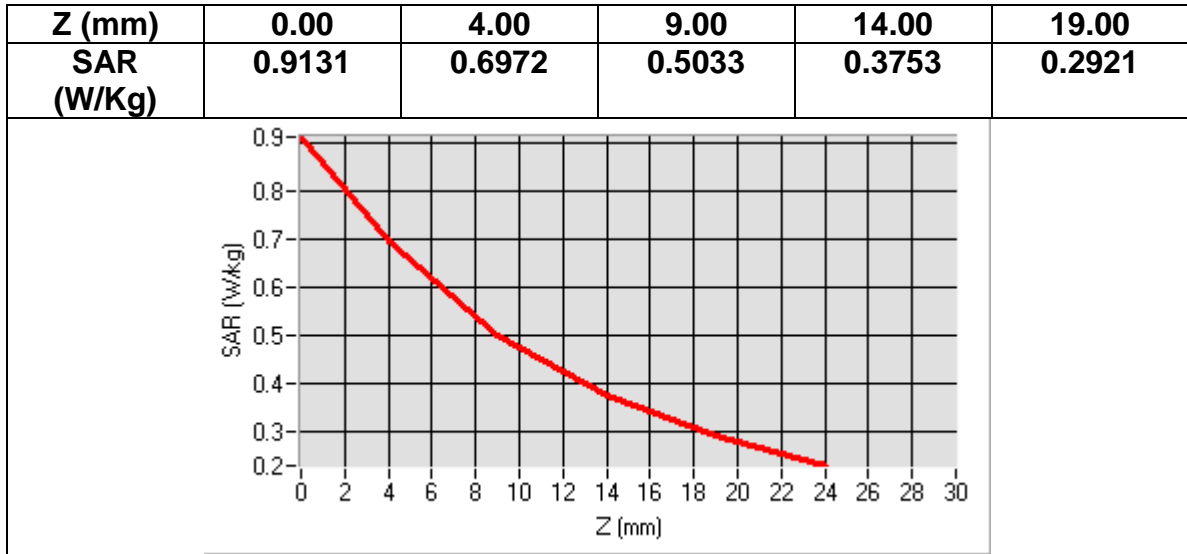

MEASUREMENT 9
Date of measurement: 2016/07/02

Area Scan	<u>sam_direct_droit2_surf8mm.txt, h= 5.00 mm</u>
Zoom Scan	<u>7x7x7,dx=5mm dy=5mm dz=5mm, sam_direct_droit2_surf8mm.txt, h= 5.00 mm</u>
Phantom	<u>Left head</u>
Device Position	<u>Cheek</u>
Band	<u>GSM850+VOICE</u>
Channels	<u>Middle</u>
Signal	<u>TDMA (Crest factor: 8.0)</u>

Frequency (MHz)	836.599976
Relative permittivity (real part)	41.500000
Relative permittivity (imaginary part)	19.400000
Conductivity (S/m)	0.901669
Variation (%)	-1.210000

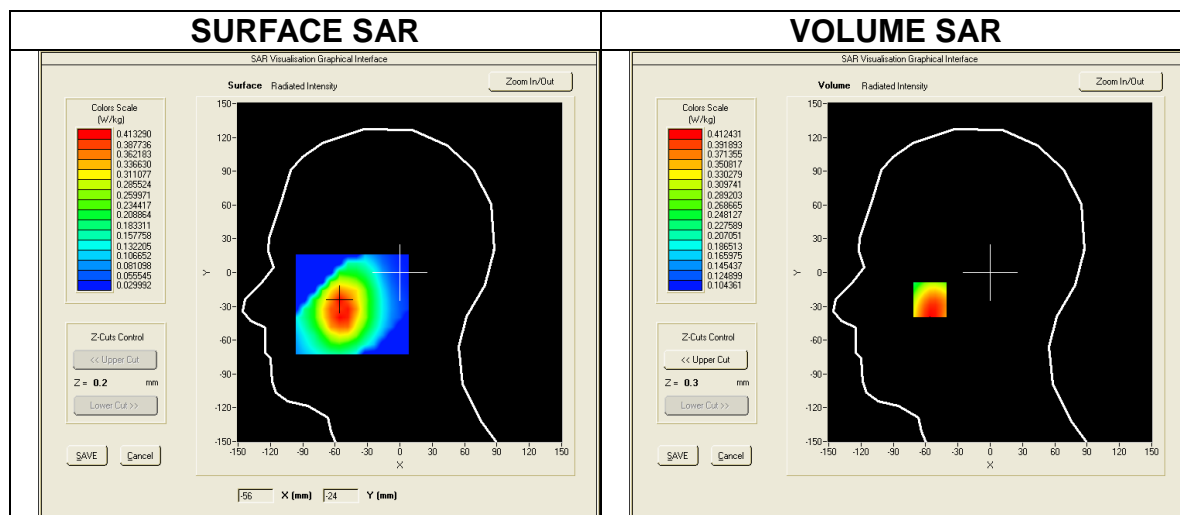

Maximum location: X=-56.00, Y=-24.00
SAR Peak: 0.50 W/kg

SAR 10g (W/Kg)	0.305118
SAR 1g (W/Kg)	0.395534

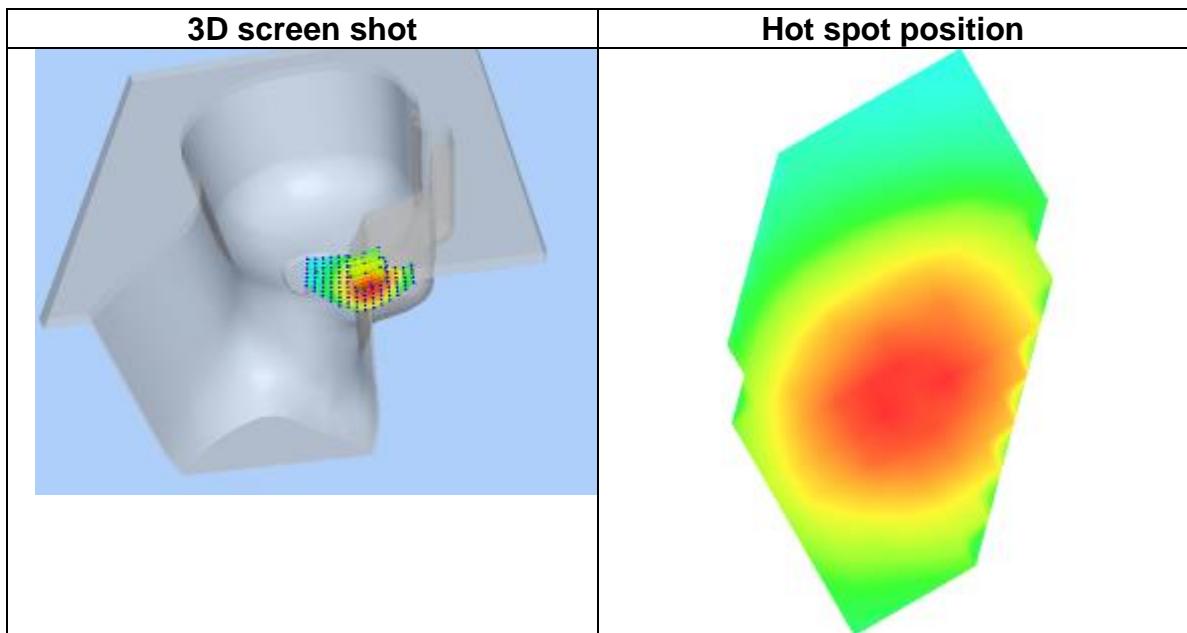
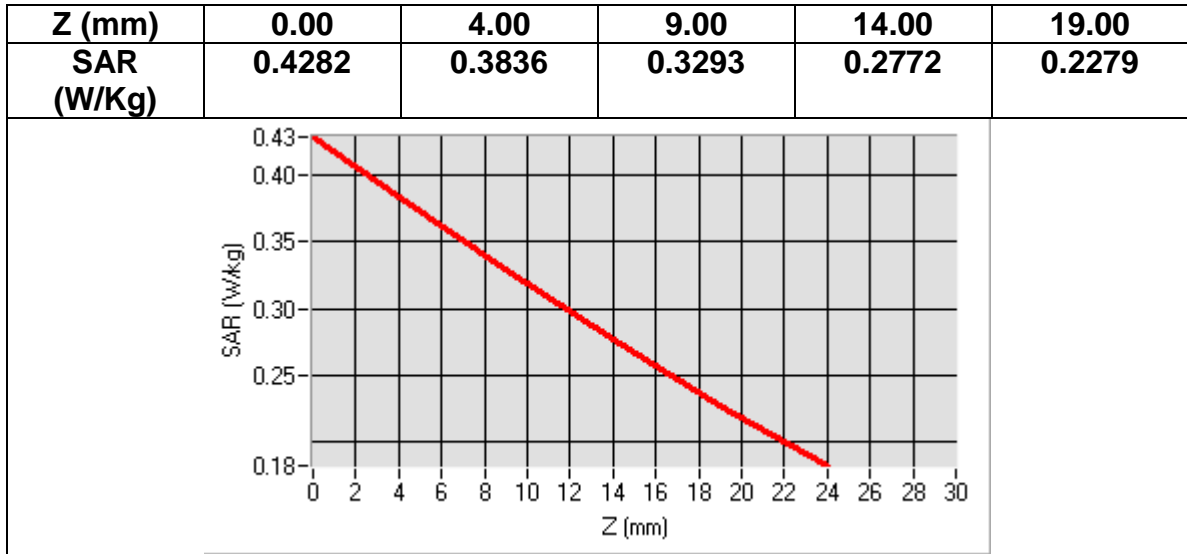

MEASUREMENT 10
Date of measurement: 2016/07/02

<u>Area Scan</u>	<u>sam_direct_droit2_surf8mm.txt, h= 5.00 mm</u>
<u>Zoom Scan</u>	<u>7x7x7,dx=5mm dy=5mm dz=5mm, sam_direct_droit2_surf8mm.txt, h= 5.00 mm</u>
<u>Phantom</u>	<u>Left head</u>
<u>Device Position</u>	<u>Tilt</u>
<u>Band</u>	<u>GSM850+EDGE(1up1down)</u>
<u>Channels</u>	<u>Middle</u>
<u>Signal</u>	<u>TDMA (Crest factor: 8.0)</u>

Frequency (MHz)	836.599976
Relative permittivity (real part)	41.500000
Relative permittivity (imaginary part)	19.400000
Conductivity (S/m)	0.901669
Variation (%)	1.330000

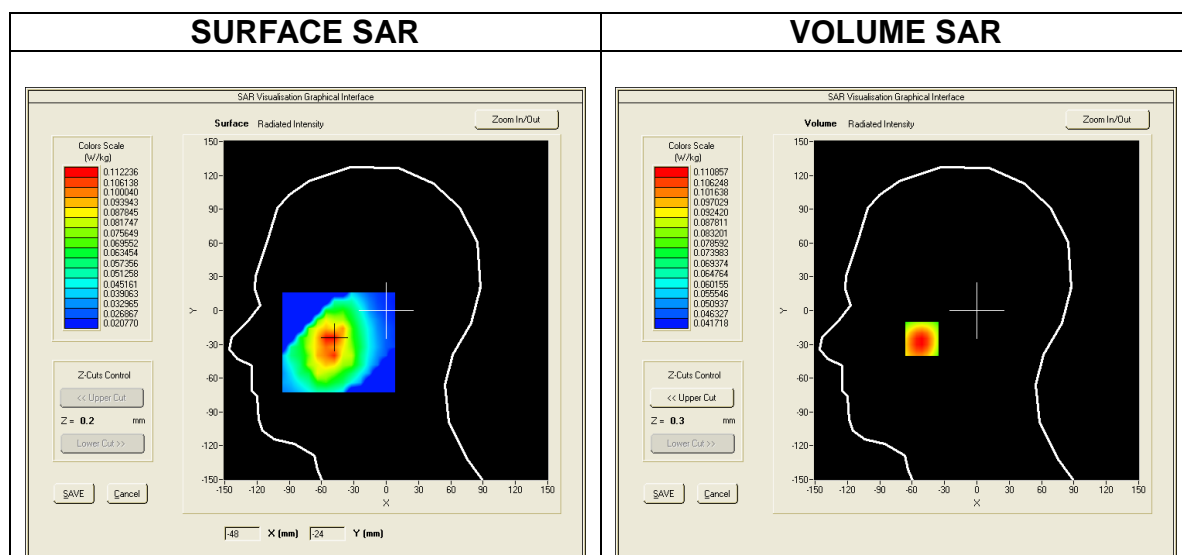

Maximum location: X=-49.00, Y=-25.00
SAR Peak: 0.13 W/kg

SAR 10g (W/Kg)	0.056259
SAR 1g (W/Kg)	0.074227

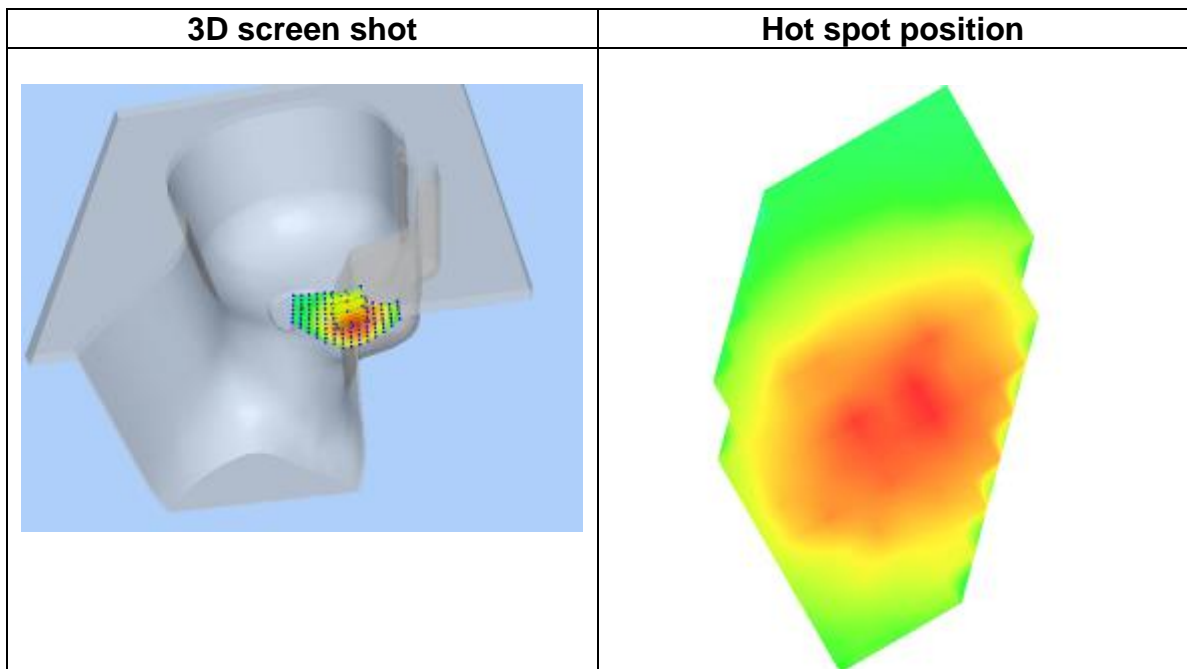
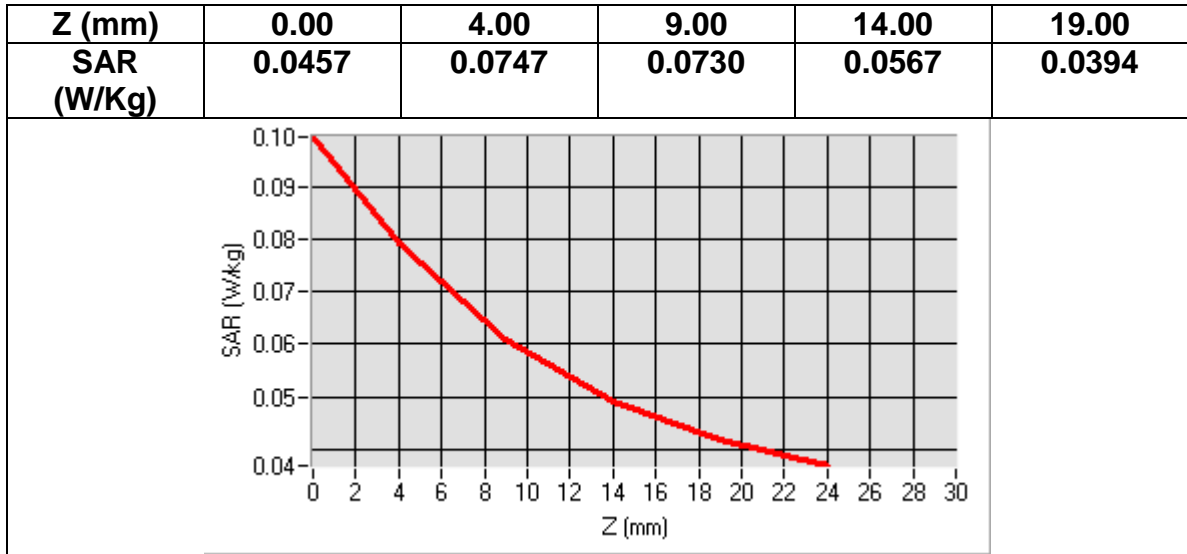

MEASUREMENT 11
Date of measurement: 2016/07/02

Area Scan	<u>sam_direct_droit2_surf8mm.txt, h= 5.00 mm</u>
Zoom Scan	<u>7x7x7,dx=5mm dy=5mm dz=5mm, sam_direct_droit2_surf8mm.txt, h= 5.00 mm</u>
Phantom	<u>Left head</u>
Device Position	<u>Tilt</u>
Band	<u>GSM850+GPRS(4up1down)</u>
Channels	<u>Middle</u>
Signal	<u>TDMA (Crest factor: 2.0)</u>

Frequency (MHz)	836.599976
Relative permittivity (real part)	41.500000
Relative permittivity (imaginary part)	19.400000
Conductivity (S/m)	0.901669
Variation (%)	-2.860000

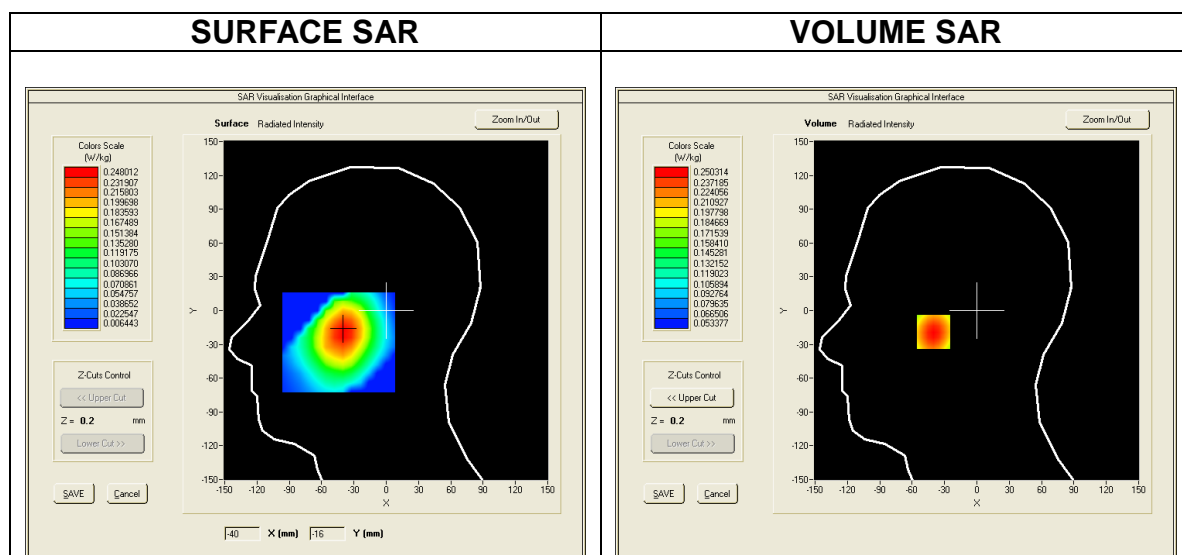

Maximum location: X=-40.00, Y=-19.00
SAR Peak: 0.31 W/kg

SAR 10g (W/Kg)	0.174416
SAR 1g (W/Kg)	0.239574

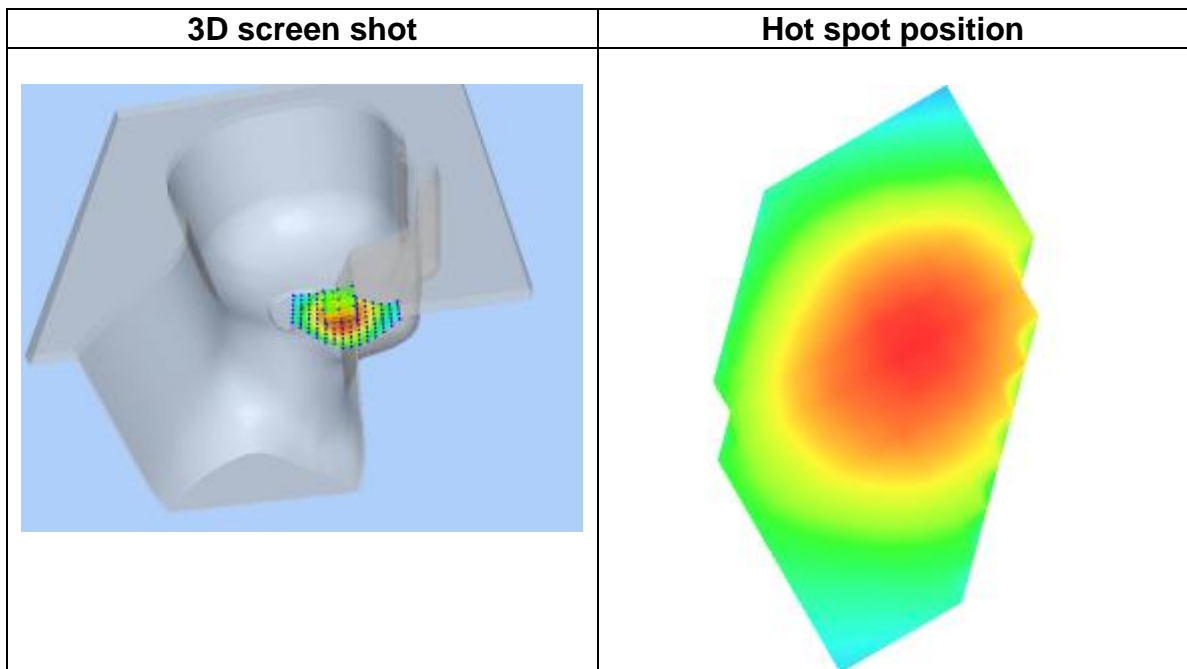
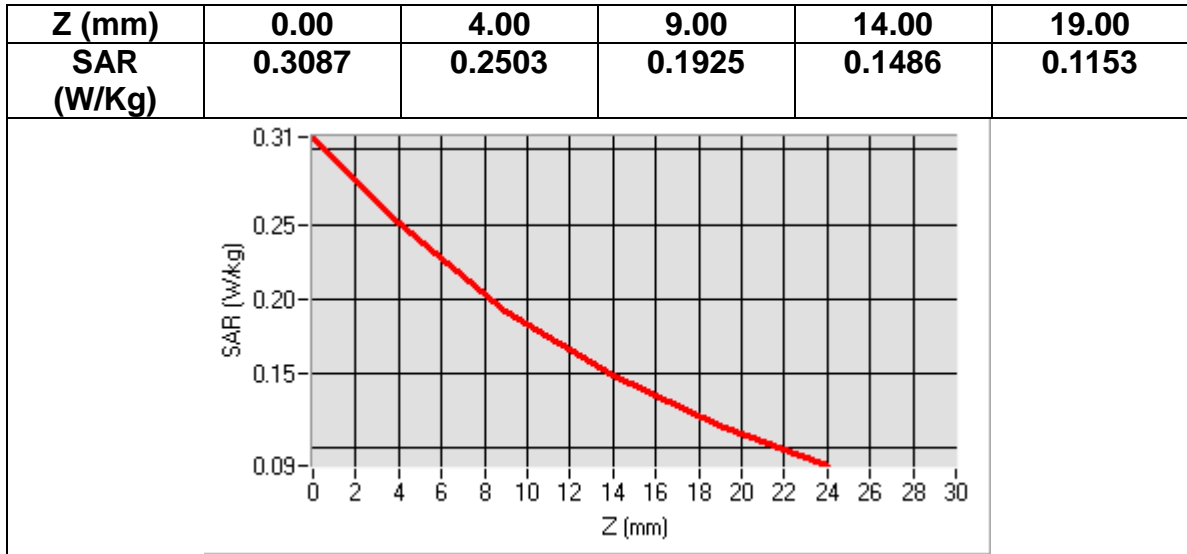

MEASUREMENT 12
Date of measurement: 2016/07/02

Area Scan	<u>sam_direct_droit2_surf8mm.txt, h= 5.00 mm</u>
Zoom Scan	<u>7x7x7,dx=5mm dy=5mm dz=5mm, sam_direct_droit2_surf8mm.txt, h= 5.00 mm</u>
Phantom	<u>Left head</u>
Device Position	<u>Tilt</u>
Band	<u>GSM850+VOICE</u>
Channels	<u>Middle</u>
Signal	<u>TDMA (Crest factor: 8.0)</u>

Frequency (MHz)	836.599976
Relative permittivity (real part)	41.500000
Relative permittivity (imaginary part)	19.400000
Conductivity (S/m)	0.901669
Variation (%)	0.520000

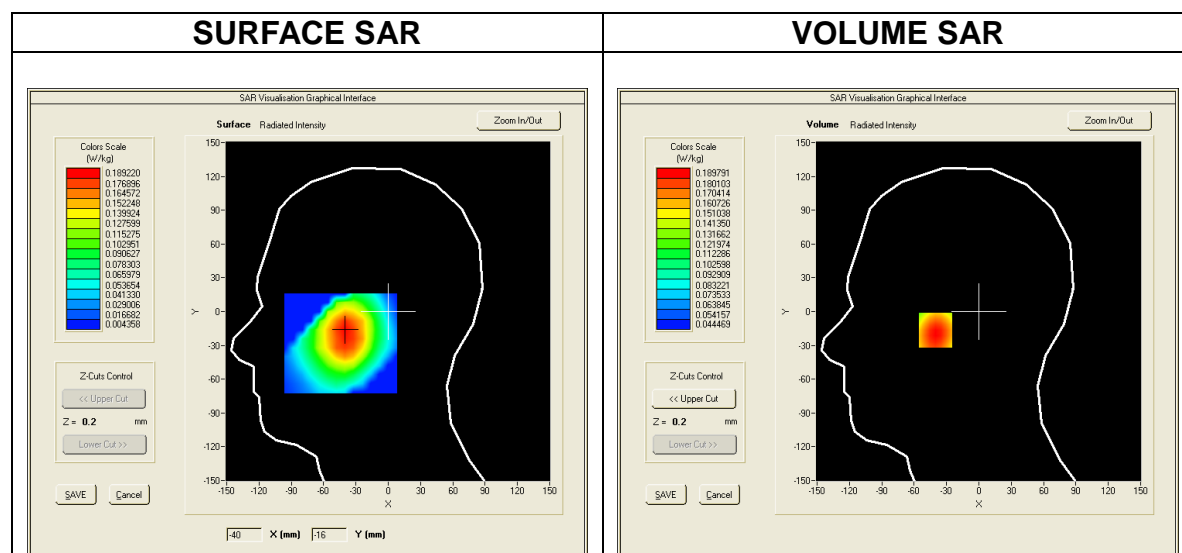

Maximum location: X=-40.00, Y=-16.00
SAR Peak: 0.22 W/kg

SAR 10g (W/Kg)	0.138394
SAR 1g (W/Kg)	0.182937

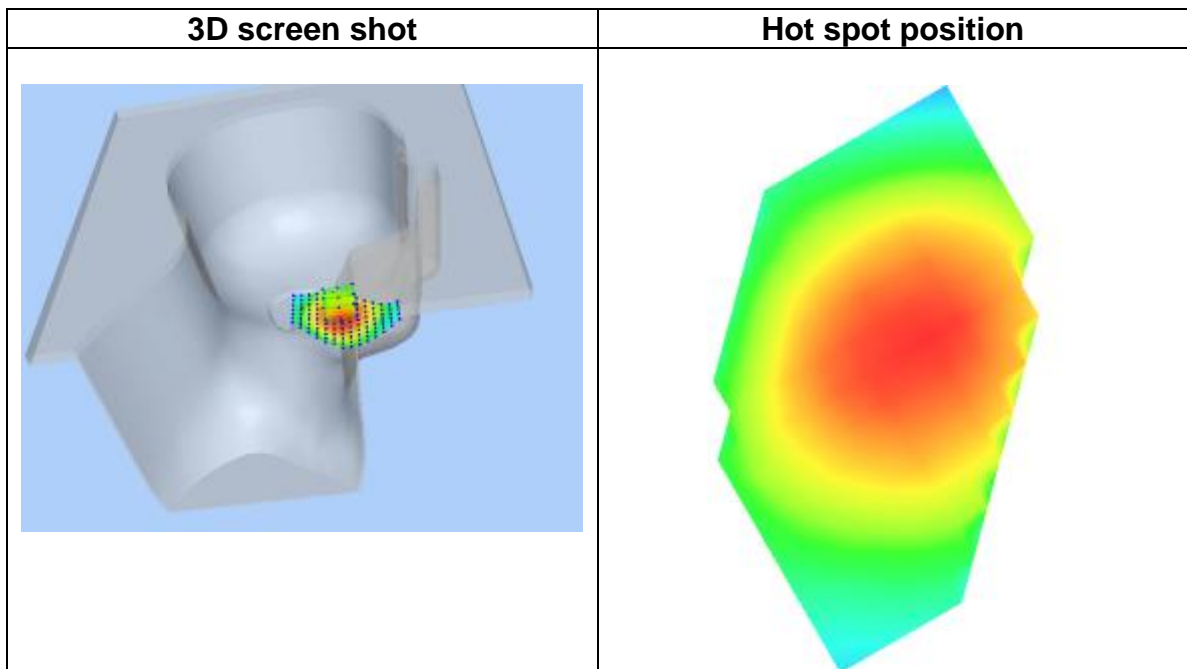
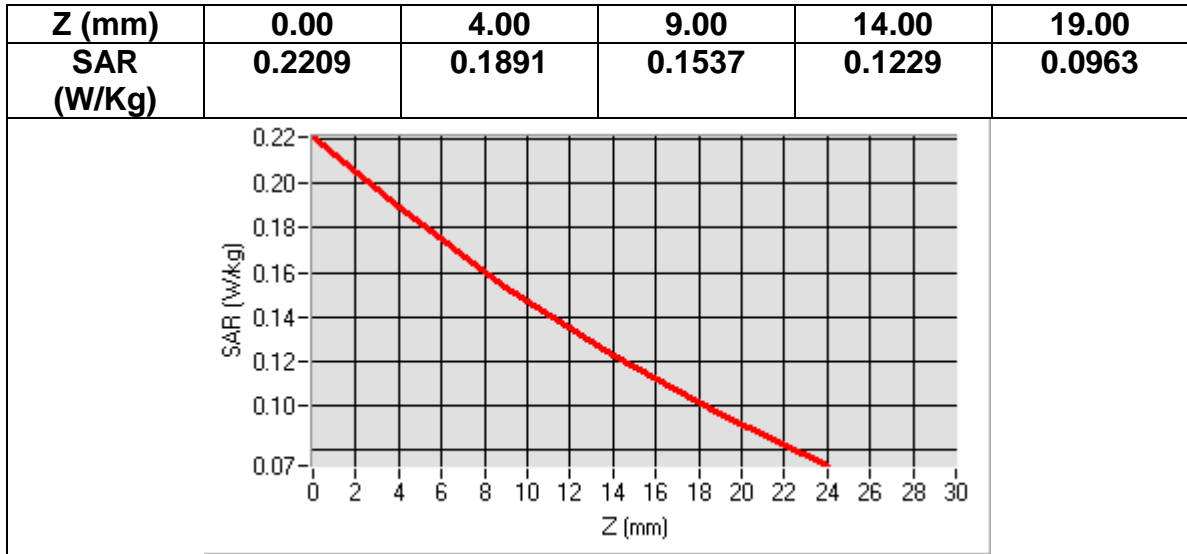

MEASUREMENT 13
Date of measurement: 2016/07/05

Area Scan	<u>dx=8mm dy=8mmh= 5.00 mm</u>
Zoom Scan	<u>7x7x7,dx=5mm dy=5mm dz=5mm, dx=8mm dy=8mm, h= 5.00 mm</u>
Phantom	<u>ELLI16</u>
Device Position	<u>Bottom</u>
Band	<u>GSM850+EDGE(1up1down)</u>
Channels	<u>Middle</u>
Signal	<u>TDMA (Crest factor: 8.0)</u>

Frequency (MHz)	836.599976
Relative permittivity (real part)	55.195076
Relative permittivity (imaginary part)	20.912214
Conductivity (S/m)	0.971953
Variation (%)	-3.180000

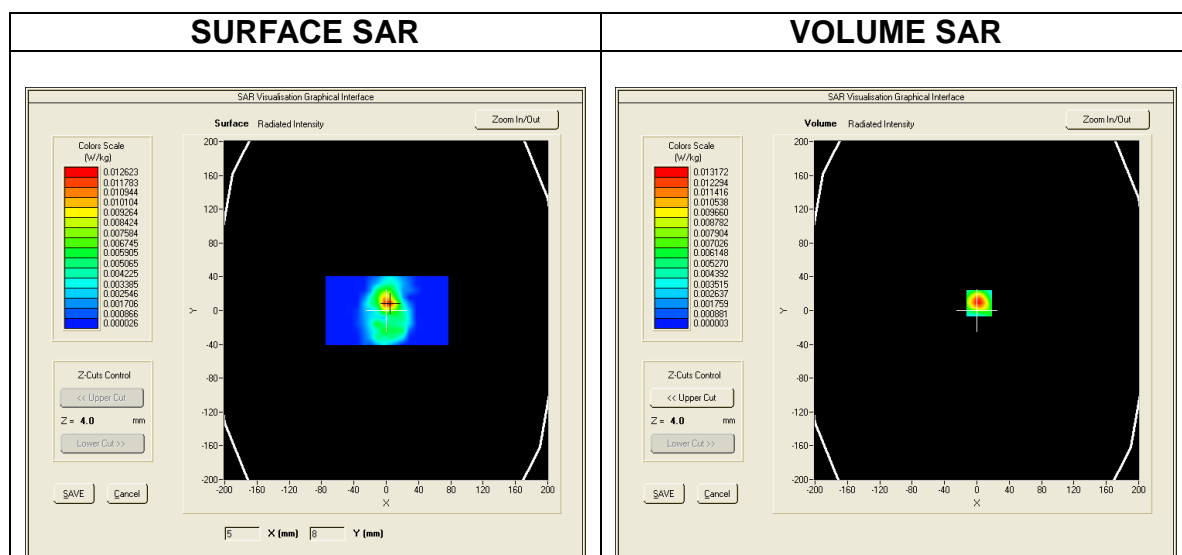

Maximum location: X=5.00, Y=1.00
SAR Peak: 0.04 W/kg

SAR 10g (W/Kg)	0.005132
SAR 1g (W/Kg)	0.011354

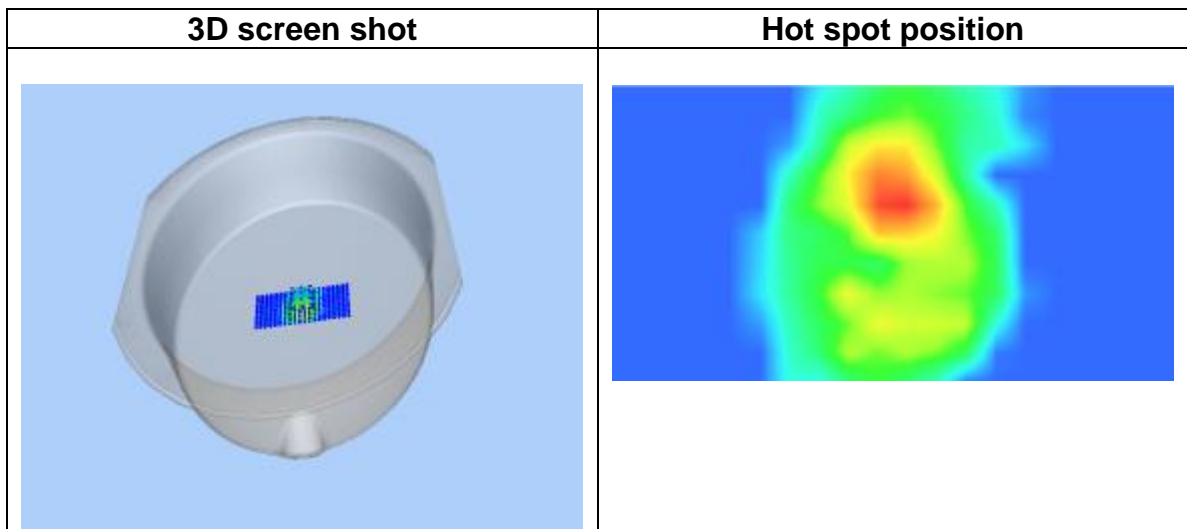
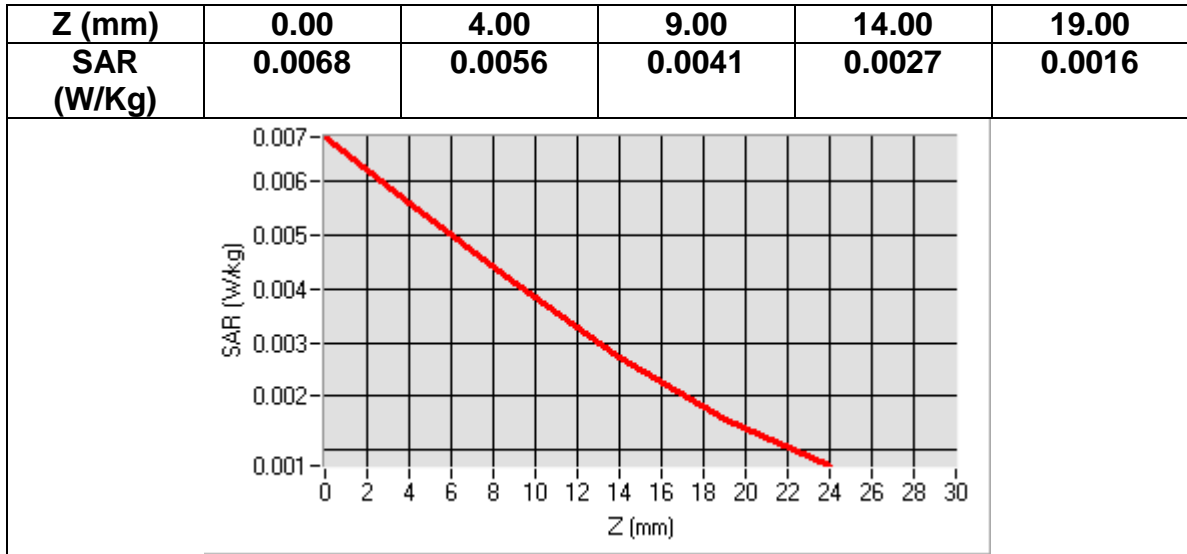

MEASUREMENT 14
Date of measurement: 2016/07/05

Area Scan	<u>dx=8mm dy=8mmh= 5.00 mm</u>
Zoom Scan	<u>7x7x7,dx=5mm dy=5mm dz=5mm, dx=8mm dy=8mm, h= 5.00 mm</u>
Phantom	<u>ELLI16</u>
Device Position	<u>Front</u>
Band	<u>GSM850+EDGE(1up1down)</u>
Channels	<u>Middle</u>
Signal	<u>TDMA (Crest factor: 8.0)</u>

Frequency (MHz)	836.599976
Relative permittivity (real part)	55.195076
Relative permittivity (imaginary part)	20.912214
Conductivity (S/m)	0.971953
Variation (%)	-1.660000

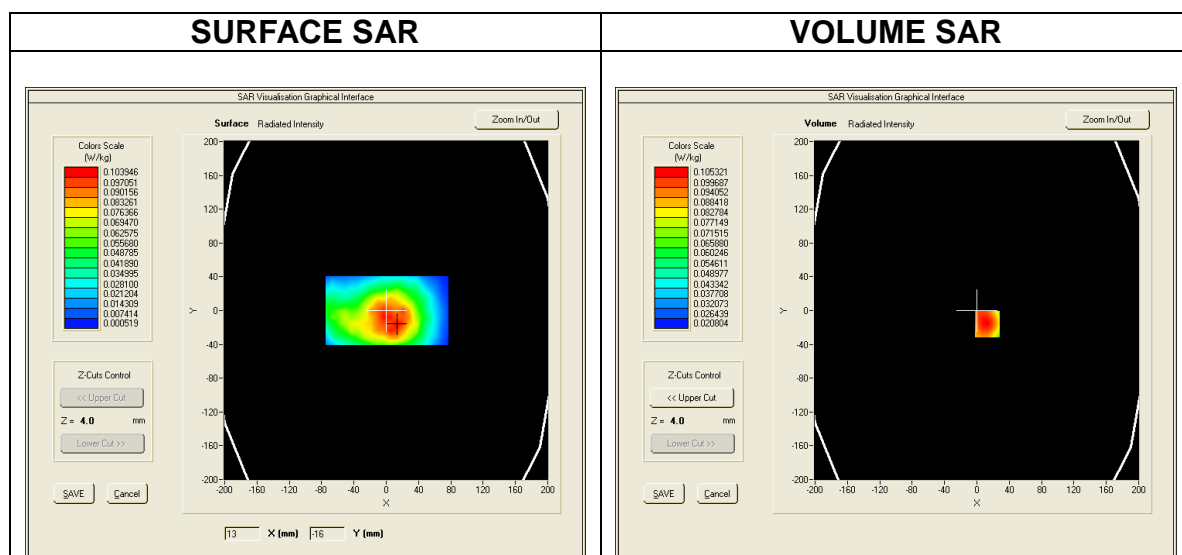

Maximum location: X=-2.00, Y=-16.00
SAR Peak: 0.13 W/kg

SAR 10g (W/Kg)	0.077758
SAR 1g (W/Kg)	0.099270

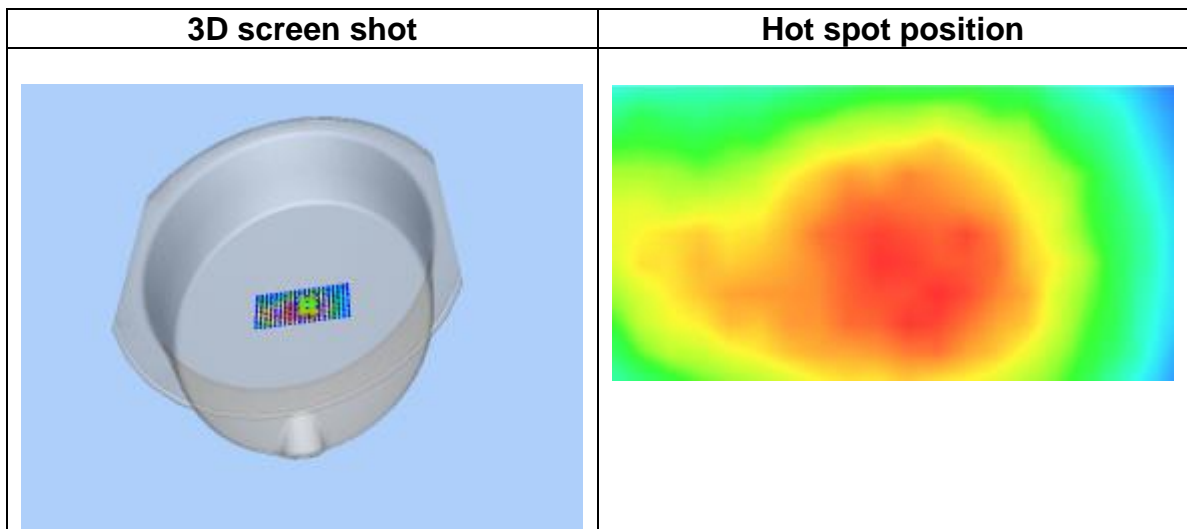
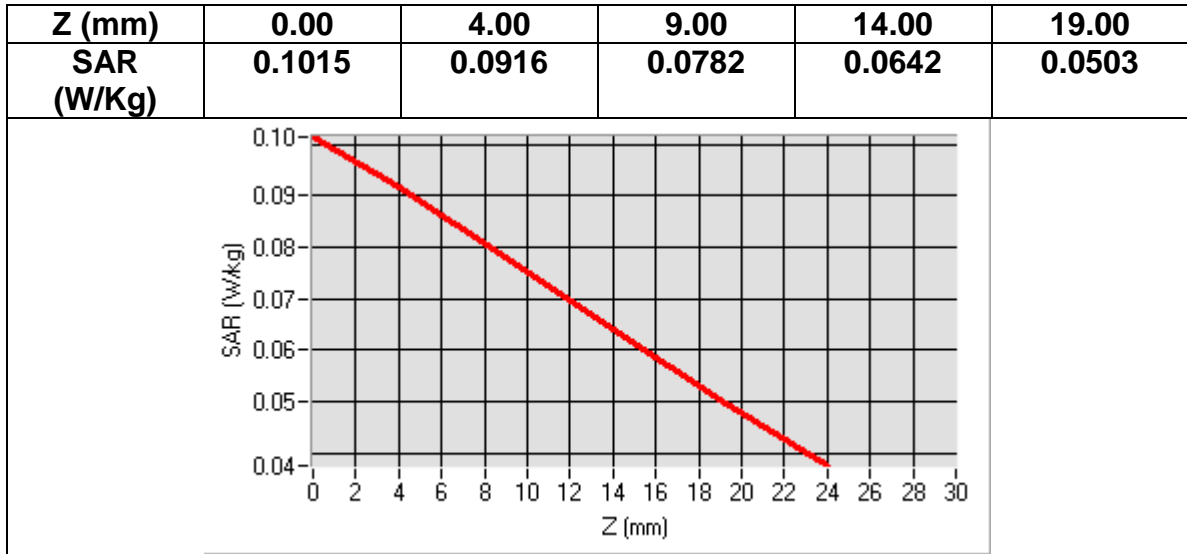

MEASUREMENT 15
Date of measurement: 2016/07/05

Area Scan	<u>dx=8mm dy=8mmh= 5.00 mm</u>
Zoom Scan	<u>7x7x7,dx=5mm dy=5mm dz=5mm, dx=8mm dy=8mm, h= 5.00 mm</u>
Phantom	<u>ELLI16</u>
Device Position	<u>Left</u>
Band	<u>GSM850+EDGE(1up1down)</u>
Channels	<u>Middle</u>
Signal	<u>TDMA (Crest factor: 8.0)</u>

Frequency (MHz)	836.599976
Relative permittivity (real part)	55.195076
Relative permittivity (imaginary part)	20.912214
Conductivity (S/m)	0.971953
Variation (%)	3.280000

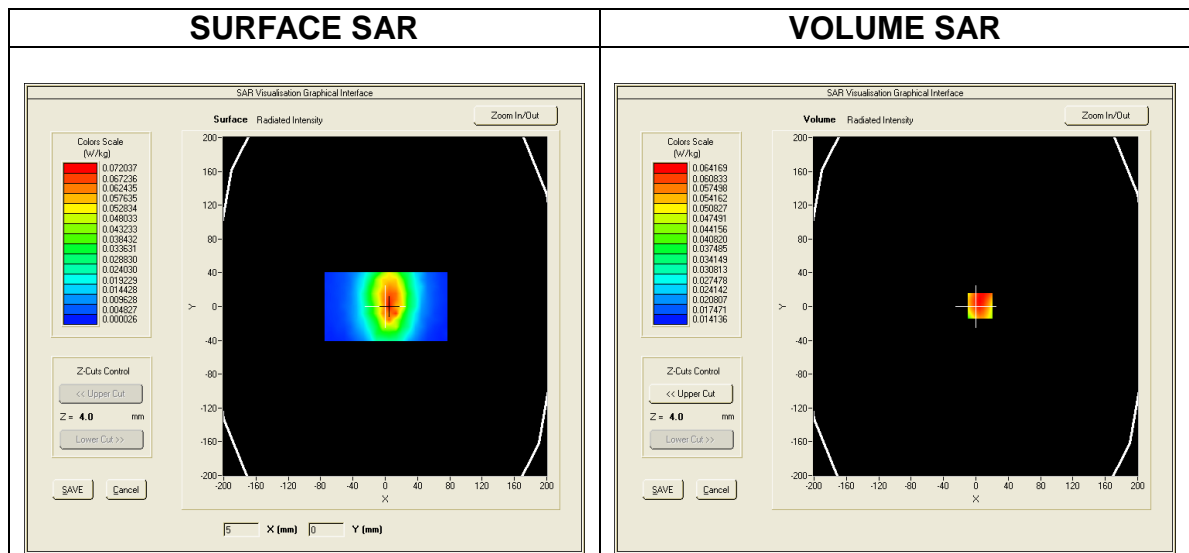

Maximum location: X=-3.00, Y=-23.00
SAR Peak: 0.06 W/kg

SAR 10g (W/Kg)	0.025416
SAR 1g (W/Kg)	0.038249

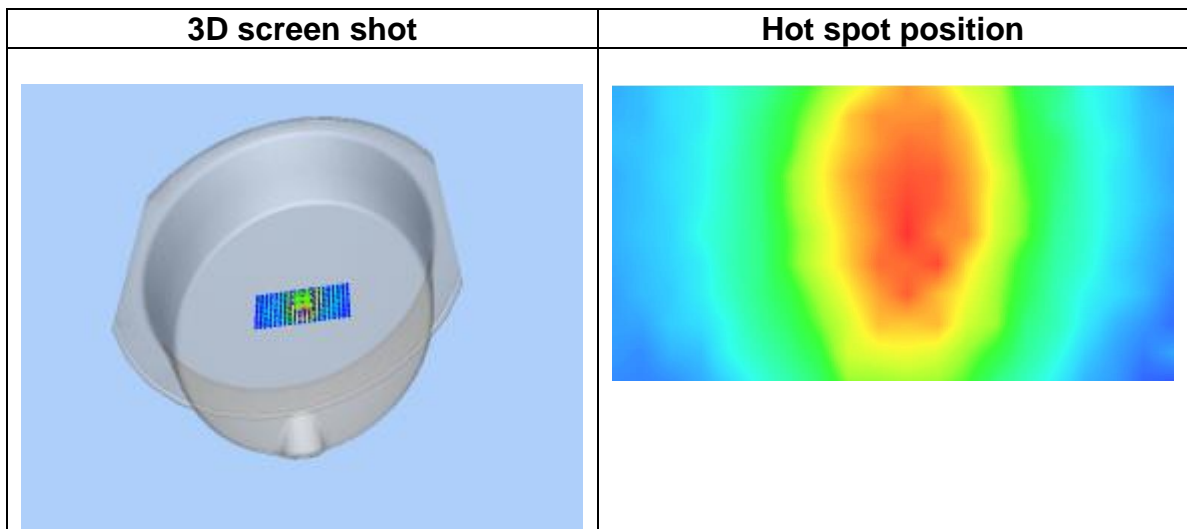
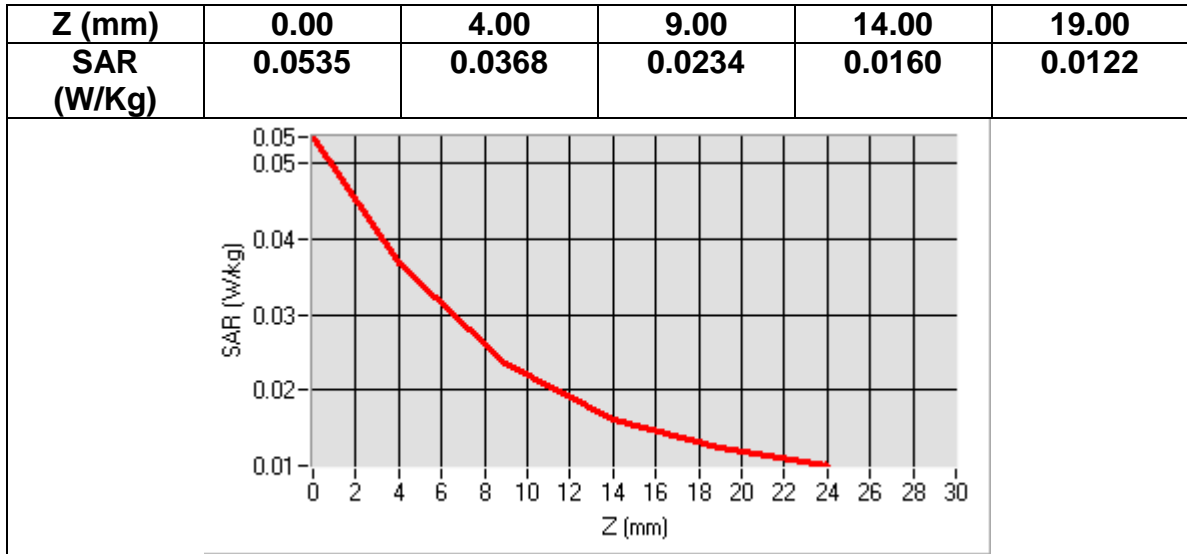

MEASUREMENT 16
Date of measurement: 2016/07/05

Area Scan	<u>dx=8mm dy=8mmh= 5.00 mm</u>
Zoom Scan	<u>7x7x7,dx=5mm dy=5mm dz=5mm, dx=8mm dy=8mm, h= 5.00 mm</u>
Phantom	<u>ELLI16</u>
Device Position	<u>Right</u>
Band	<u>GSM850+EDGE(1up1down)</u>
Channels	<u>Middle</u>
Signal	<u>TDMA (Crest factor: 8.0)</u>

Frequency (MHz)	836.599976
Relative permittivity (real part)	55.195076
Relative permittivity (imaginary part)	20.912214
Conductivity (S/m)	0.971953
Variation (%)	3.650000

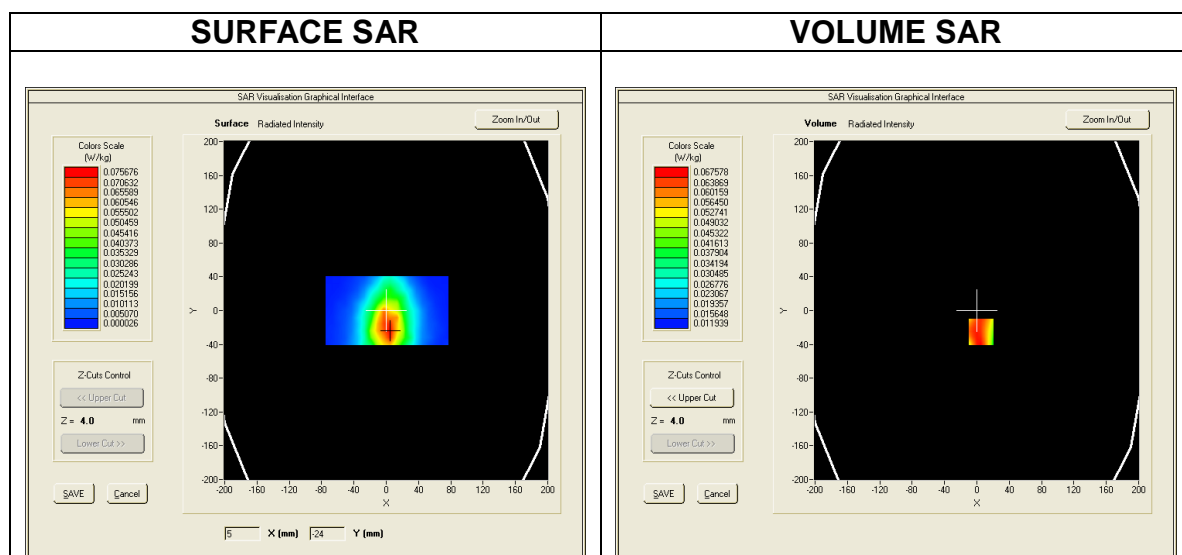

Maximum location: X=5.00, Y=-8.00
SAR Peak: 0.09 W/kg

SAR 10g (W/Kg)	0.045989
SAR 1g (W/Kg)	0.065056

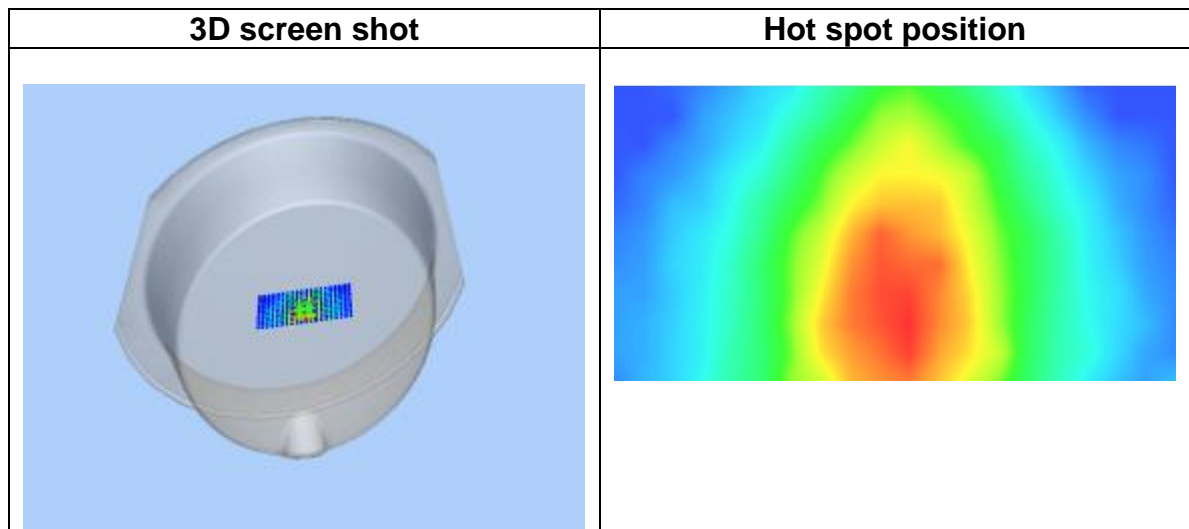

MEASUREMENT 17
Date of measurement: 2016/07/05

<u>Area Scan</u>	<u>dx=8mm dy=8mmh= 5.00 mm</u>
<u>Zoom Scan</u>	<u>7x7x7,dx=5mm dy=5mm dz=5mm, dx=8mm dy=8mm, h= 5.00 mm</u>
<u>Phantom</u>	<u>ELLI16</u>
<u>Device Position</u>	<u>Left</u>
<u>Band</u>	<u>GSM850+GPRS(4up1down)</u>
<u>Channels</u>	<u>Middle</u>
<u>Signal</u>	<u>TDMA (Crest factor:2.0)</u>

Frequency (MHz)	836.599976
Relative permittivity (real part)	55.195076
Relative permittivity (imaginary part)	20.912214
Conductivity (S/m)	0.971953
Variation (%)	-3.730000

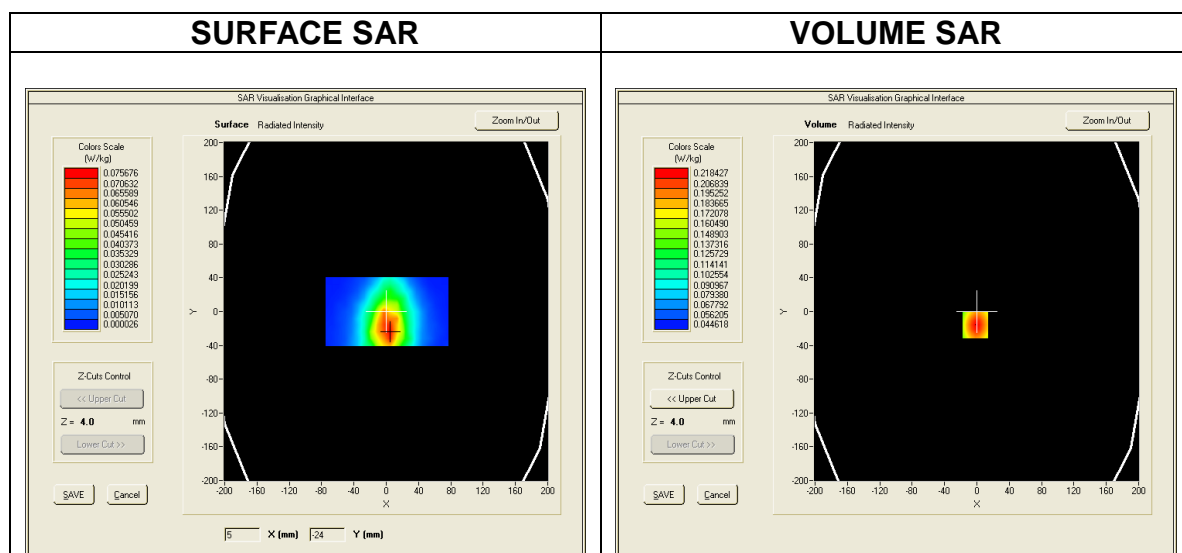

Maximum location: X=-2.00, Y=-16.00
SAR Peak: 0.33 W/kg

SAR 10g (W/Kg)	0.150342
SAR 1g (W/Kg)	0.224381

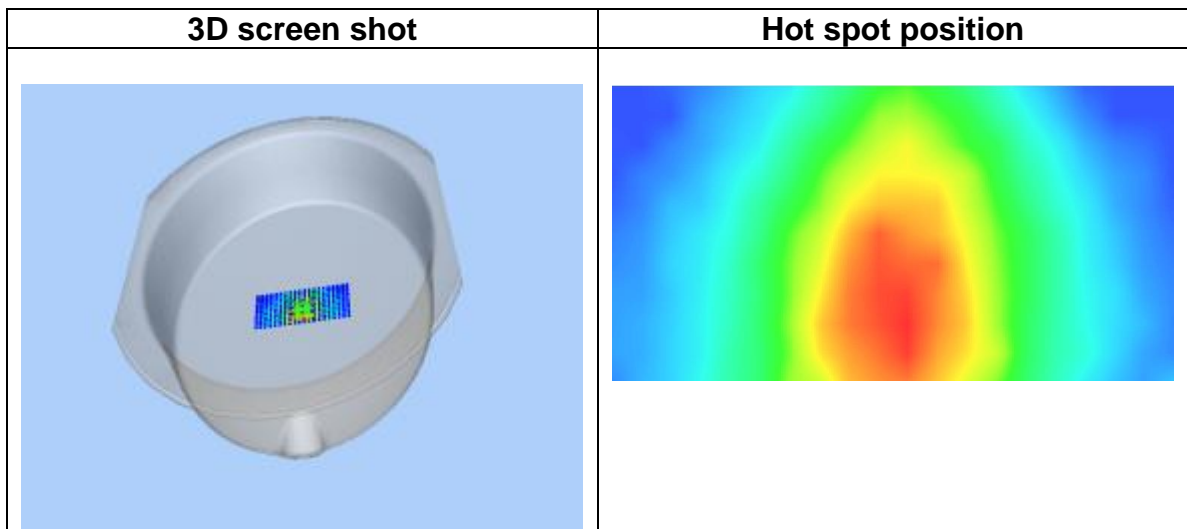
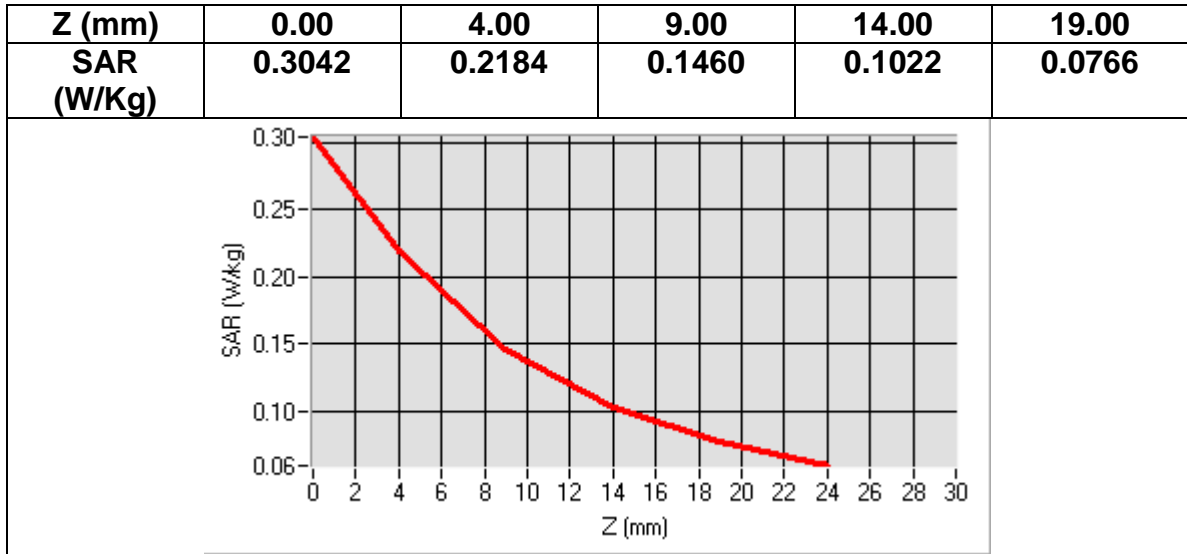

MEASUREMENT 18
Date of measurement: 2016/07/05

<u>Area Scan</u>	<u>dx=8mm dy=8mmh= 5.00 mm</u>
<u>Zoom Scan</u>	<u>7x7x7,dx=5mm dy=5mm dz=5mm, dx=8mm dy=8mm, h= 5.00 mm</u>
<u>Phantom</u>	<u>ELLI16</u>
<u>Device Position</u>	<u>Bottom</u>
<u>Band</u>	<u>GSM850+GPRS(4up1down)</u>
<u>Channels</u>	<u>Middle</u>
<u>Signal</u>	<u>TDMA (Crest factor: 2.0)</u>

Frequency (MHz)	836.599976
Relative permittivity (real part)	55.195076
Relative permittivity (imaginary part)	20.912214
Conductivity (S/m)	0.971953
Variation (%)	-2.130000

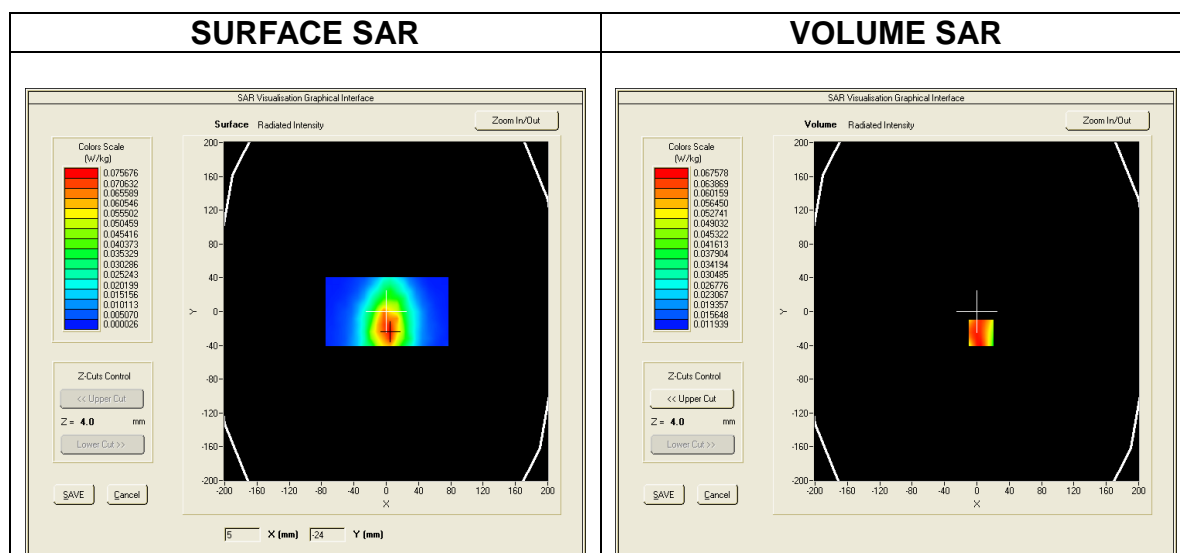

Maximum location: X=-1.00, Y=14.00
SAR Peak: 0.10 W/kg

SAR 10g (W/Kg)	0.033850
SAR 1g (W/Kg)	0.056423

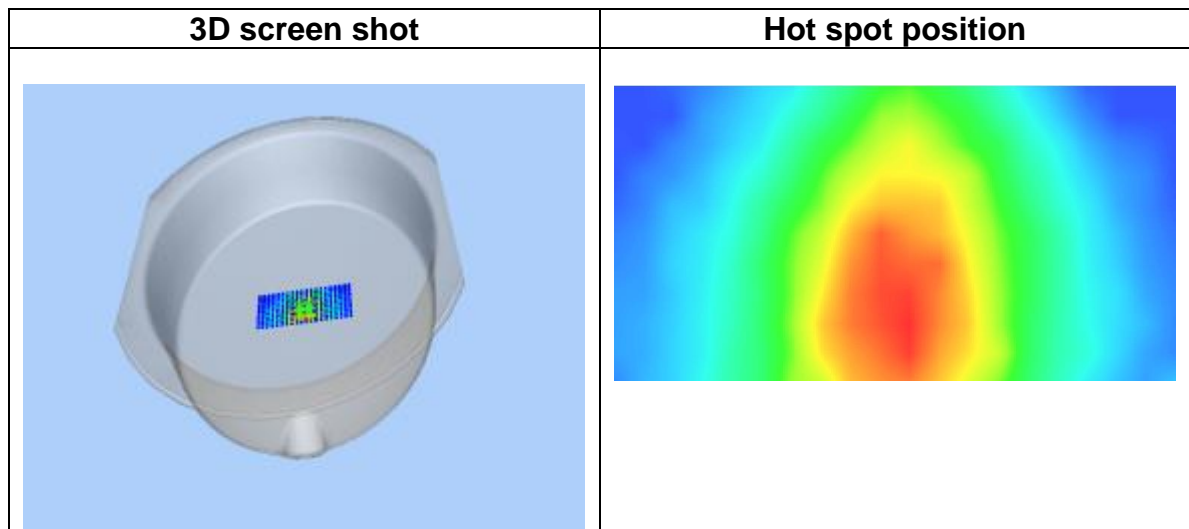
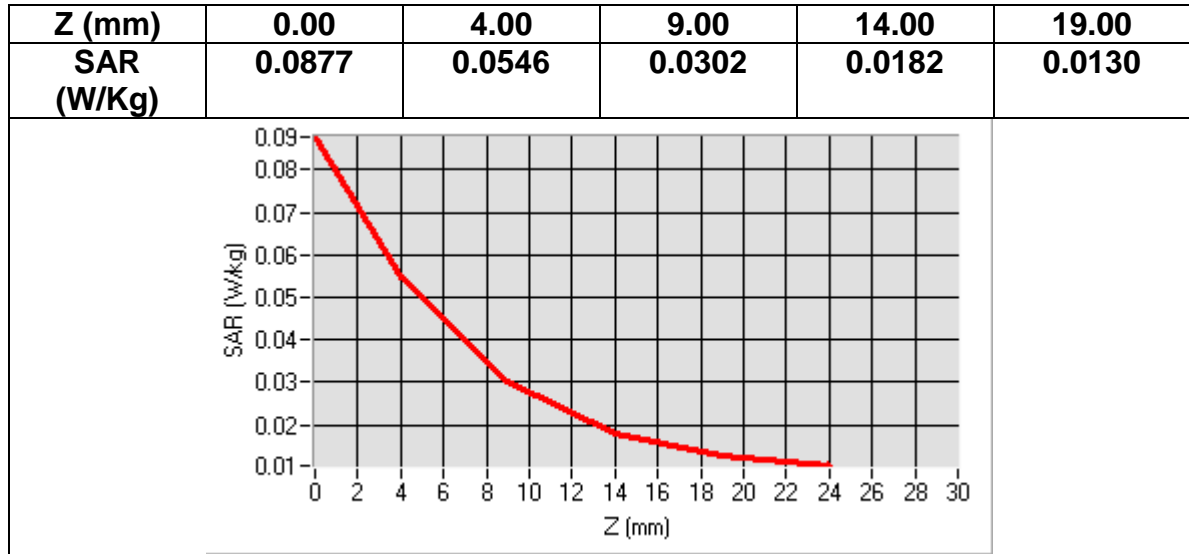

MEASUREMENT 19
Date of measurement: 2016/07/05

Area Scan	<u>dx=8mm dy=8mmh= 5.00 mm</u>
Zoom Scan	<u>7x7x7,dx=5mm dy=5mm dz=5mm, dx=8mm dy=8mm, h= 5.00 mm</u>
Phantom	<u>ELLI16</u>
Device Position	<u>Front</u>
Band	<u>GSM850+GPRS(4up1down)</u>
Channels	<u>Middle</u>
Signal	<u>TDMA (Crest factor: 2.0)</u>

Frequency (MHz)	836.599976
Relative permittivity (real part)	55.195076
Relative permittivity (imaginary part)	20.912214
Conductivity (S/m)	0.971953
Variation (%)	-0.510000

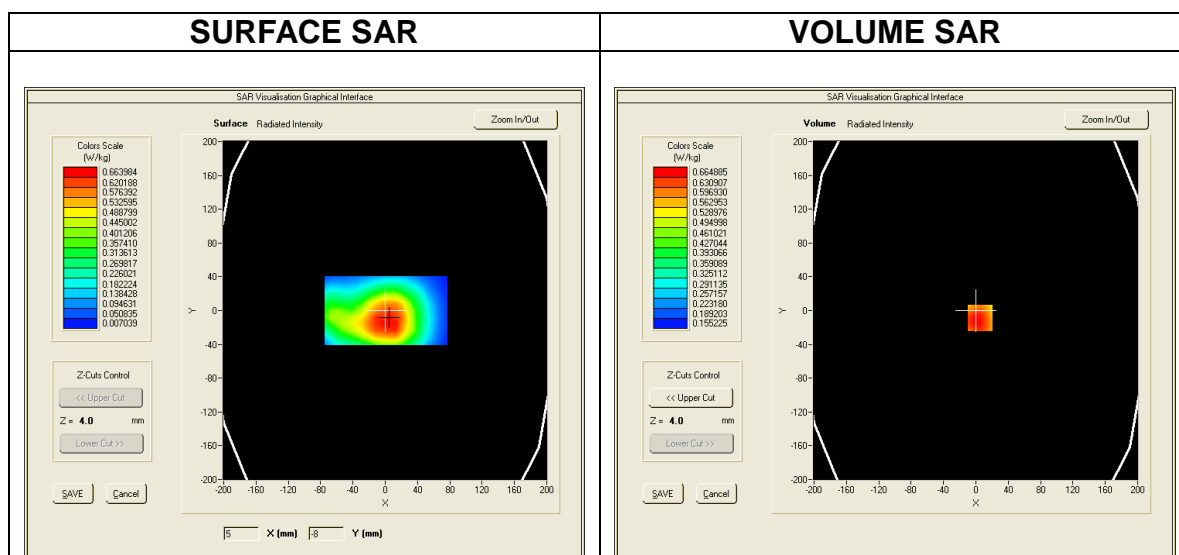

Maximum location: X=13.00, Y=-8.00
SAR Peak: 1.07 W/kg

SAR 10g (W/Kg)	0.587667
SAR 1g (W/Kg)	0.807400

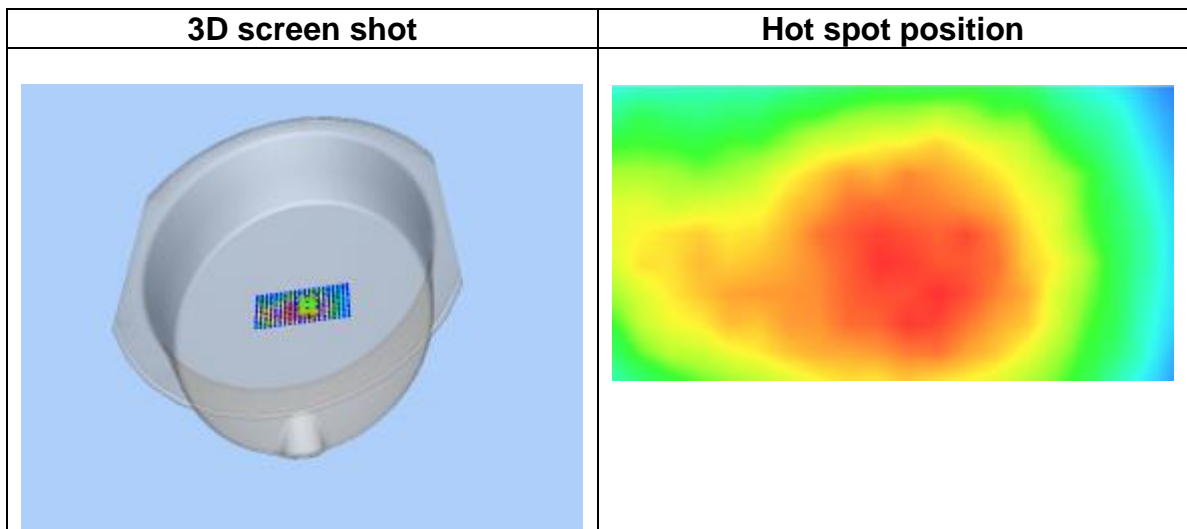
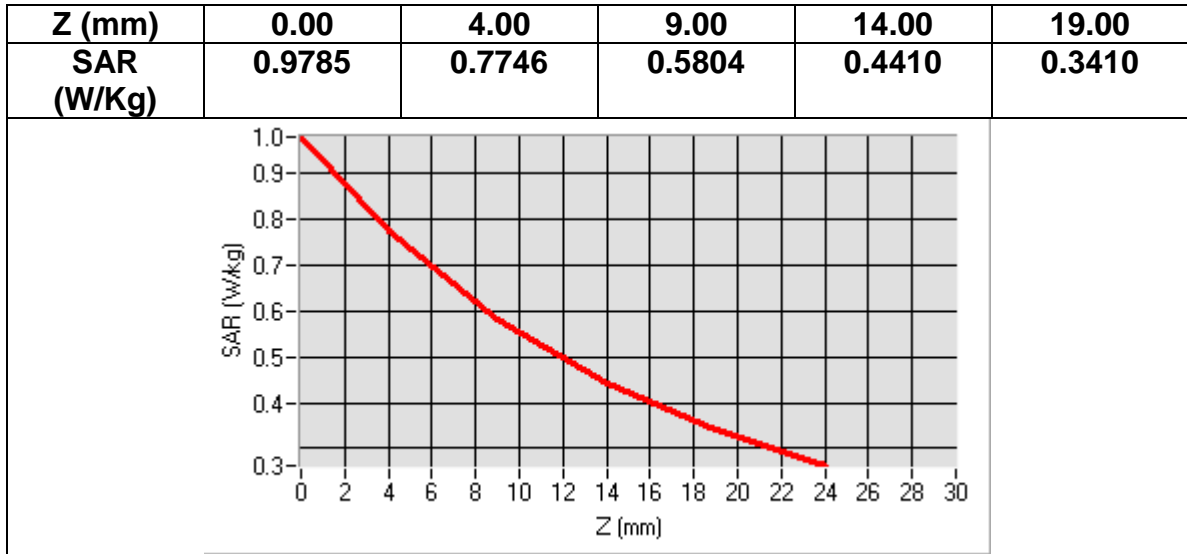

MEASUREMENT 20
Date of measurement: 2016/07/05

Area Scan	<u>dx=8mm dy=8mmh= 5.00 mm</u>
Zoom Scan	<u>7x7x7,dx=5mm dy=5mm dz=5mm, dx=8mm dy=8mm, h= 5.00 mm</u>
Phantom	<u>ELL16</u>
Device Position	<u>Right</u>
Band	<u>GSM850+GPRS(4up1down)</u>
Channels	<u>Middle</u>
Signal	<u>TDMA (Crest factor: 2.0)</u>

Frequency (MHz)	836.599976
Relative permittivity (real part)	55.195076
Relative permittivity (imaginary part)	20.912214
Conductivity (S/m)	0.971953
Variation (%)	0.040000

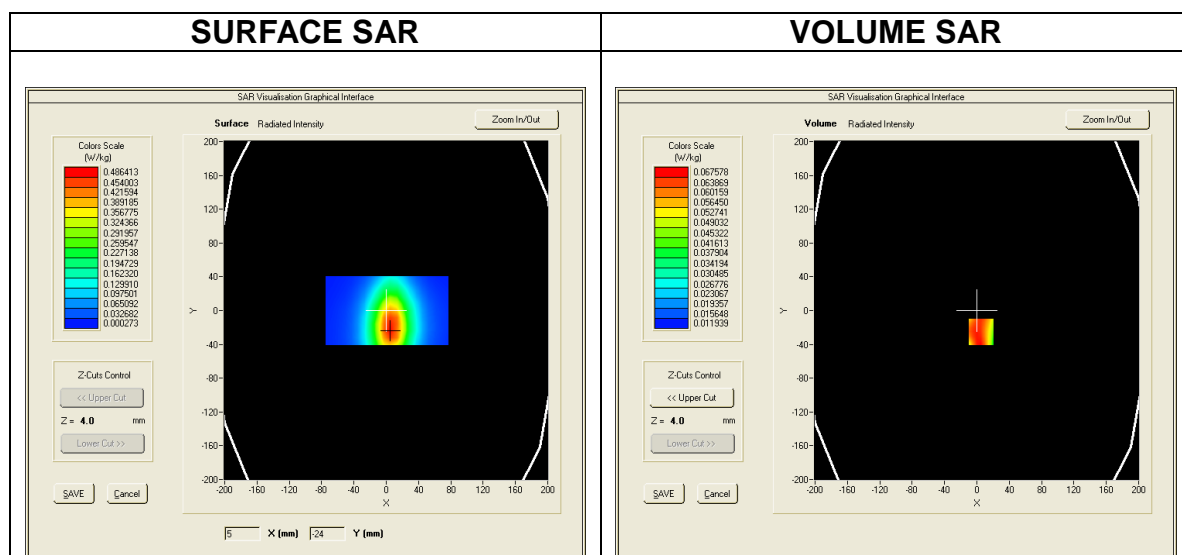

Maximum location: X=5.00, Y=-9.00
SAR Peak: 0.60 W/kg

SAR 10g (W/Kg)	0.277469
SAR 1g (W/Kg)	0.415659

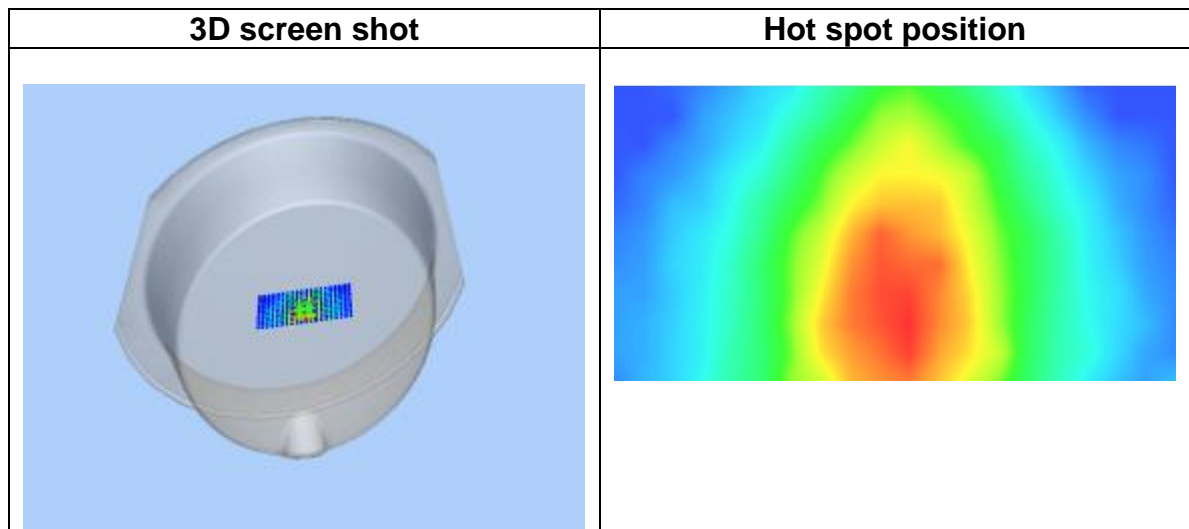
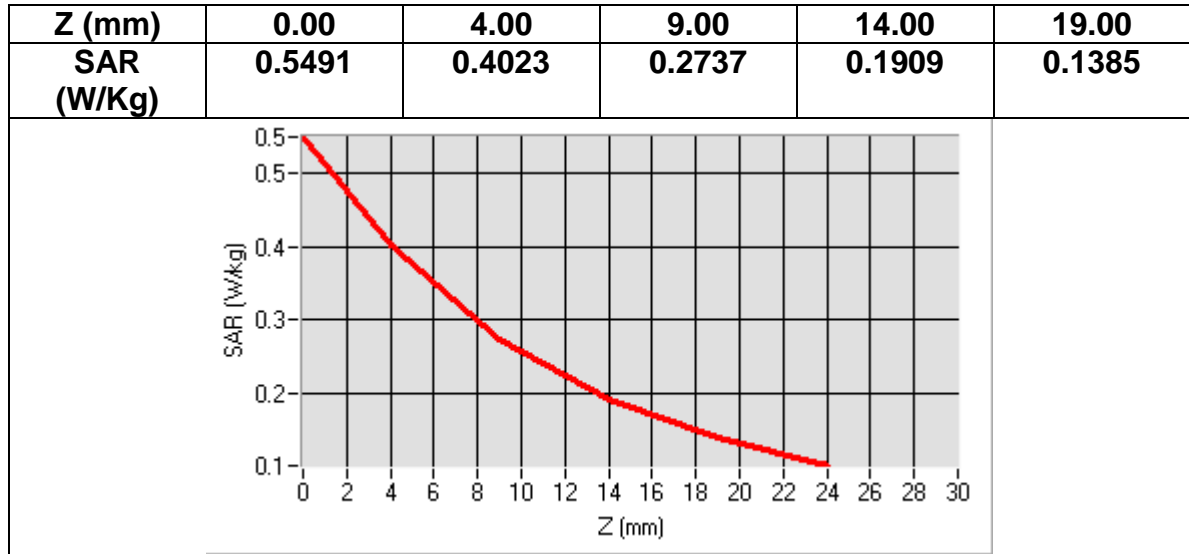

MEASUREMENT 21
Date of measurement: 2016/07/05

Area Scan	<u>dx=8mm dy=8mmh= 5.00 mm</u>
Zoom Scan	<u>7x7x7,dx=5mm dy=5mm dz=5mm, dx=8mm dy=8mm, h= 5.00 mm</u>
Phantom	<u>ELLI16</u>
Device Position	<u>Bottom</u>
Band	<u>GSM850+VOICE</u>
Channels	<u>Middle</u>
Signal	<u>TDMA (Crest factor: 8.0)</u>

Frequency (MHz)	836.599976
Relative permittivity (real part)	55.195076
Relative permittivity (imaginary part)	20.912214
Conductivity (S/m)	0.971953
Variation (%)	-2.660000

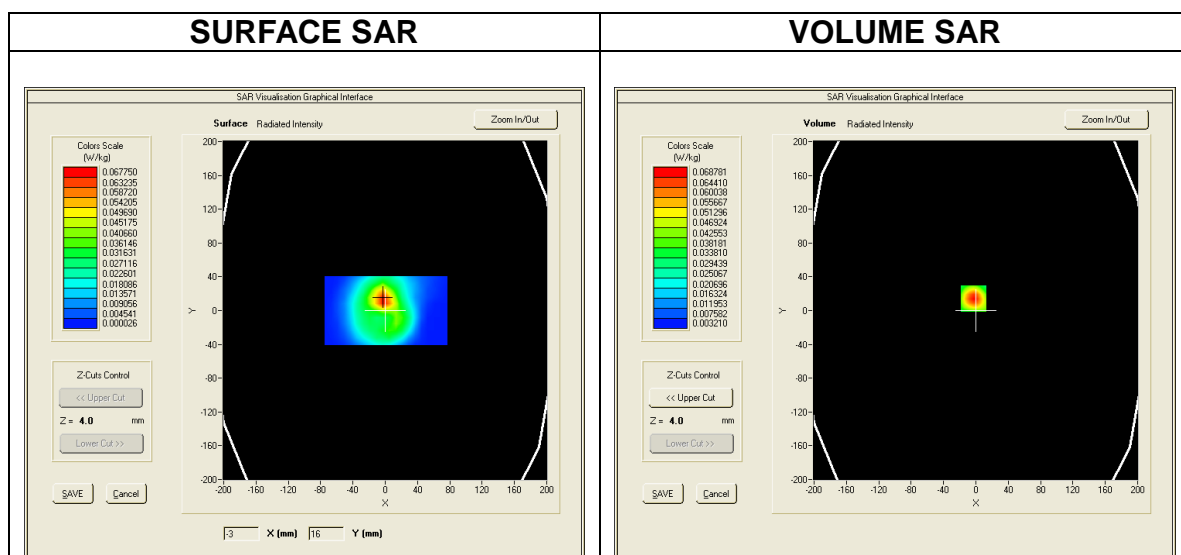

Maximum location: X=3.00, Y=14.00
SAR Peak: 0.07 W/kg

SAR 10g (W/Kg)	0.026899
SAR 1g (W/Kg)	0.043102

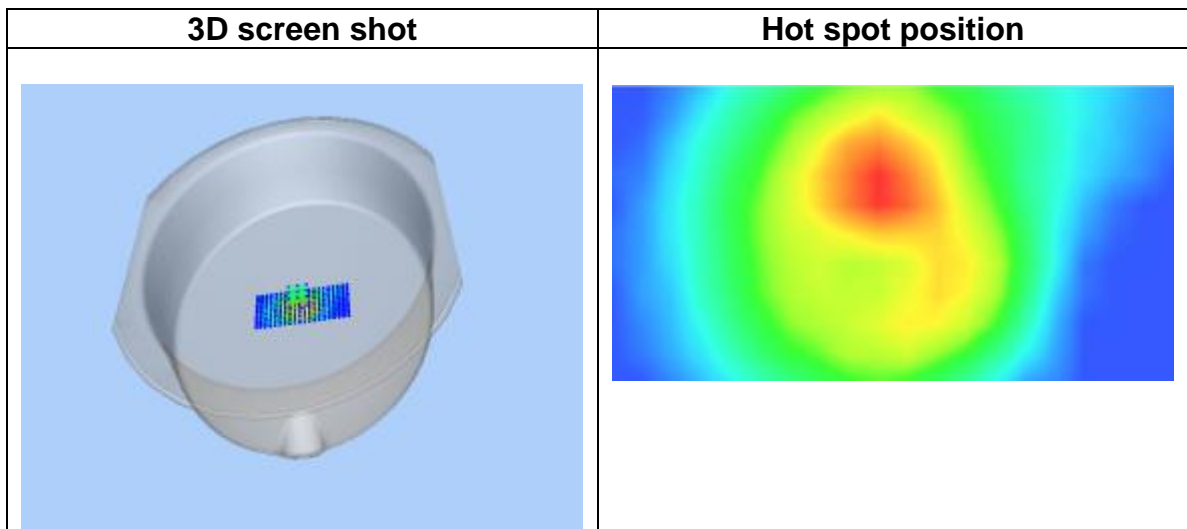
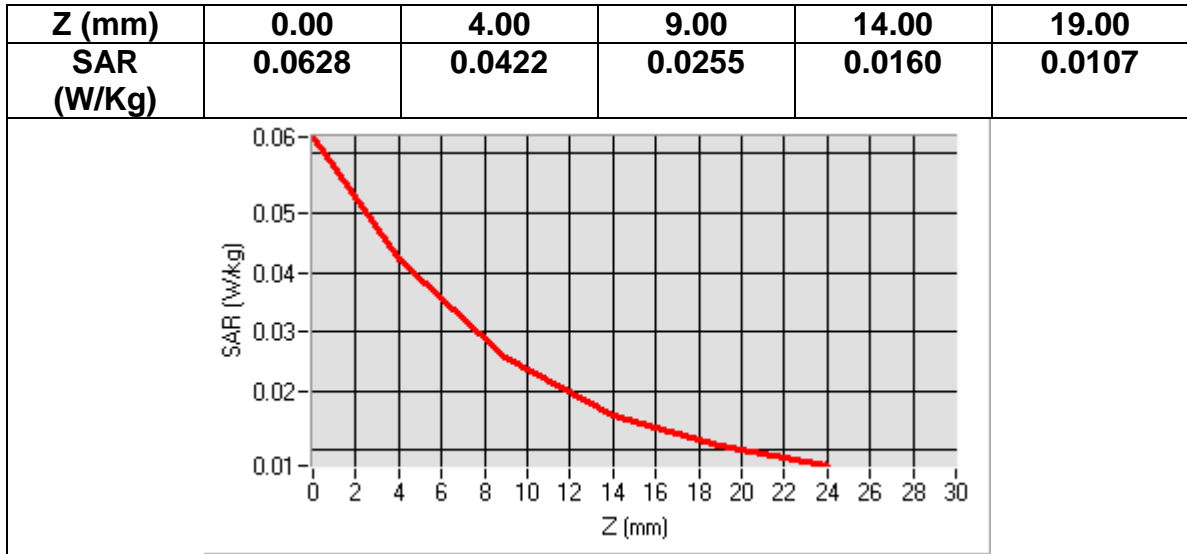

MEASUREMENT 22
Date of measurement: 2016/07/05

Area Scan	<u>dx=8mm dy=8mmh= 5.00 mm</u>
Zoom Scan	<u>7x7x7,dx=5mm dy=5mm dz=5mm, dx=8mm dy=8mm, h= 5.00 mm</u>
Phantom	<u>ELL16</u>
Device Position	<u>Front</u>
Band	<u>GSM850+VOICE</u>
Channels	<u>Middle</u>
Signal	<u>TDMA (Crest factor: 8.0)</u>

Frequency (MHz)	836.599976
Relative permittivity (real part)	55.195076
Relative permittivity (imaginary part)	20.912214
Conductivity (S/m)	0.971953
Variation (%)	-2.480000

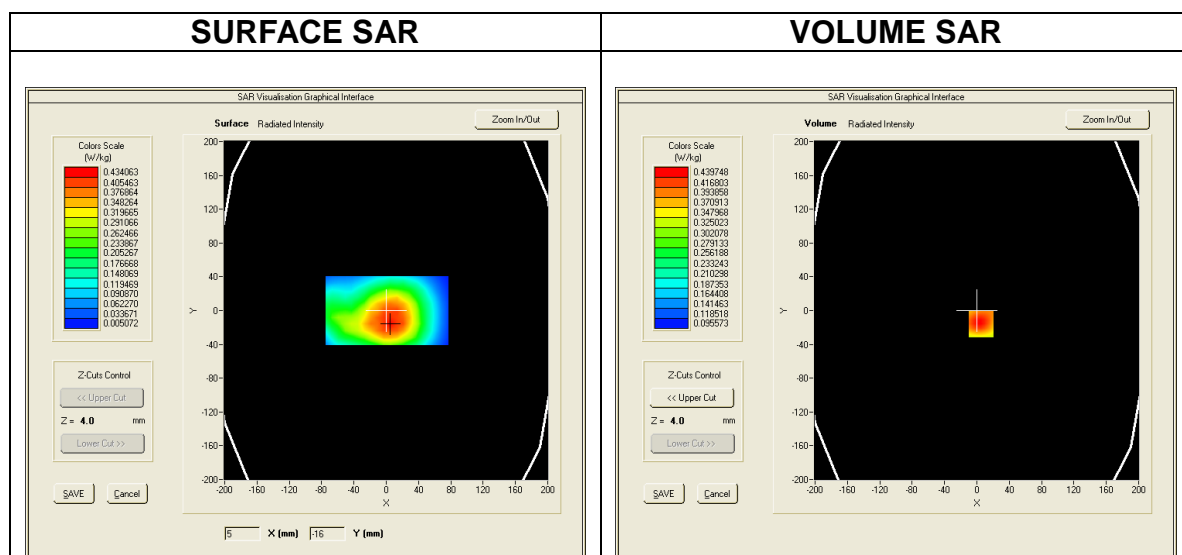

Maximum location: X=8.00, Y=-15.00
SAR Peak: 0.54 W/kg

SAR 10g (W/Kg)	0.328632
SAR 1g (W/Kg)	0.428514

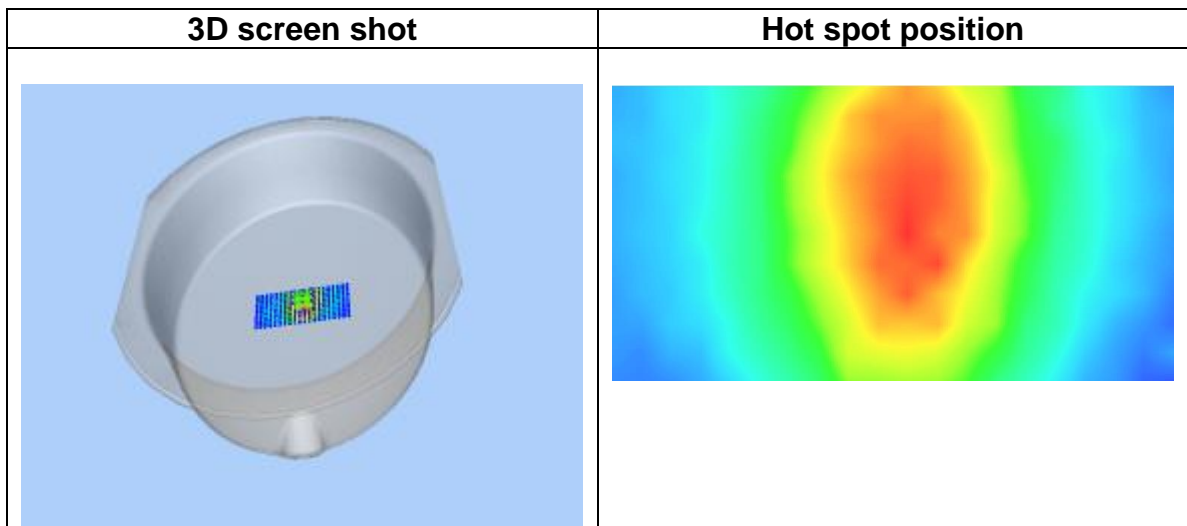

MEASUREMENT 23
 Date of measurement: 2016/07/05

Area Scan	<u>dx=8mm dy=8mmh= 5.00 mm</u>
Zoom Scan	<u>7x7x7,dx=5mm dy=5mm dz=5mm, dx=8mm dy=8mm, h= 5.00 mm</u>
Phantom	<u>ELL16</u>
Device Position	<u>Left</u>
Band	<u>GSM850+VOICE</u>
Channels	<u>Middle</u>
Signal	<u>TDMA (Crest factor: 8.0)</u>

Frequency (MHz)	836.599976
Relative permittivity (real part)	55.195076
Relative permittivity (imaginary part)	20.912214
Conductivity (S/m)	0.971953
Variation (%)	-2.420000

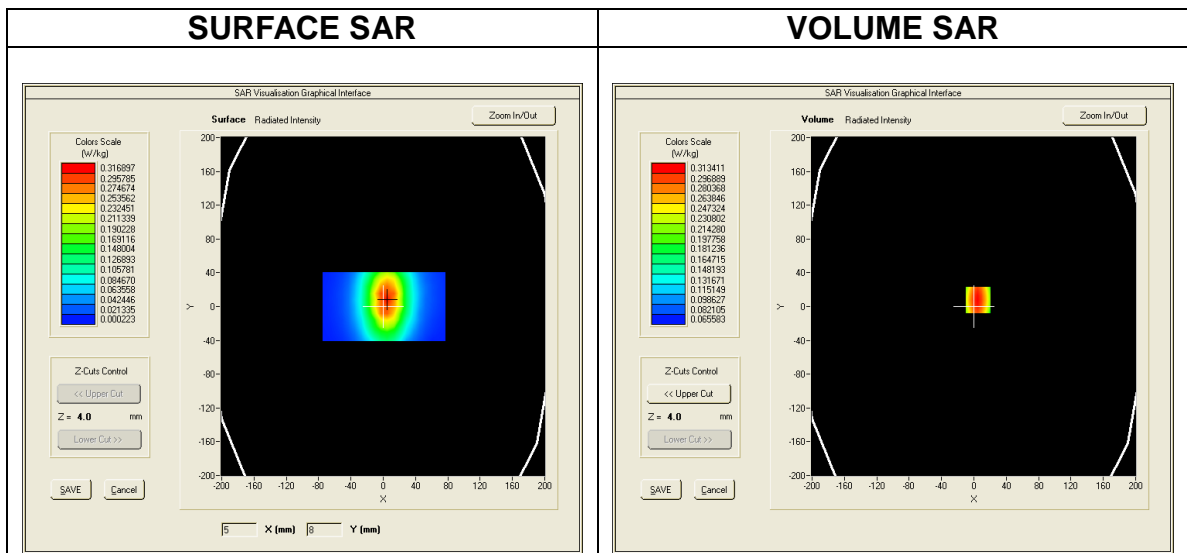

Maximum location: X=-2.00, Y=-31.00
SAR Peak: 0.20 W/kg

SAR 10g (W/Kg)	0.104807
SAR 1g (W/Kg)	0.146569

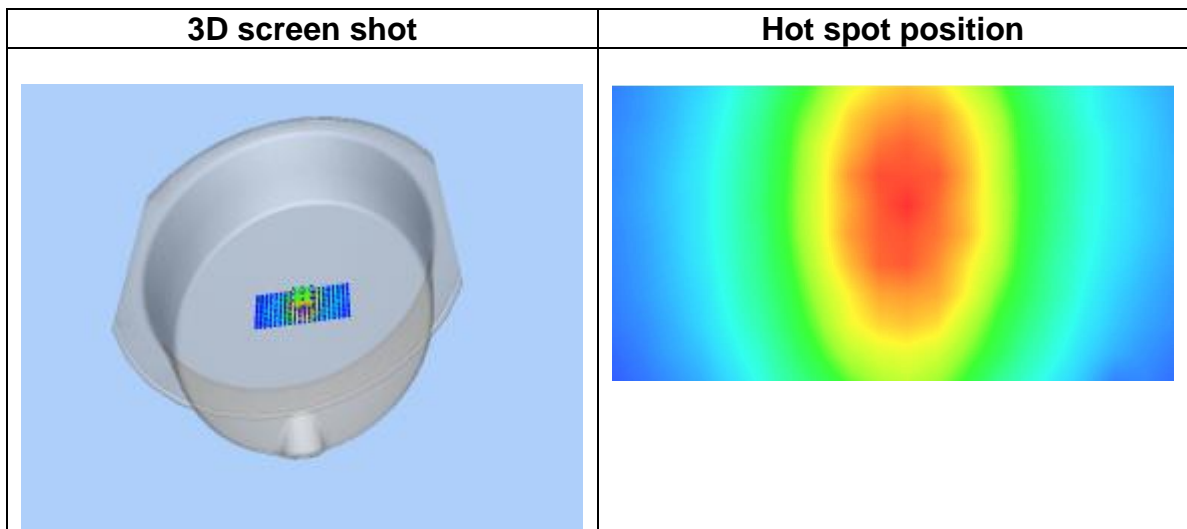
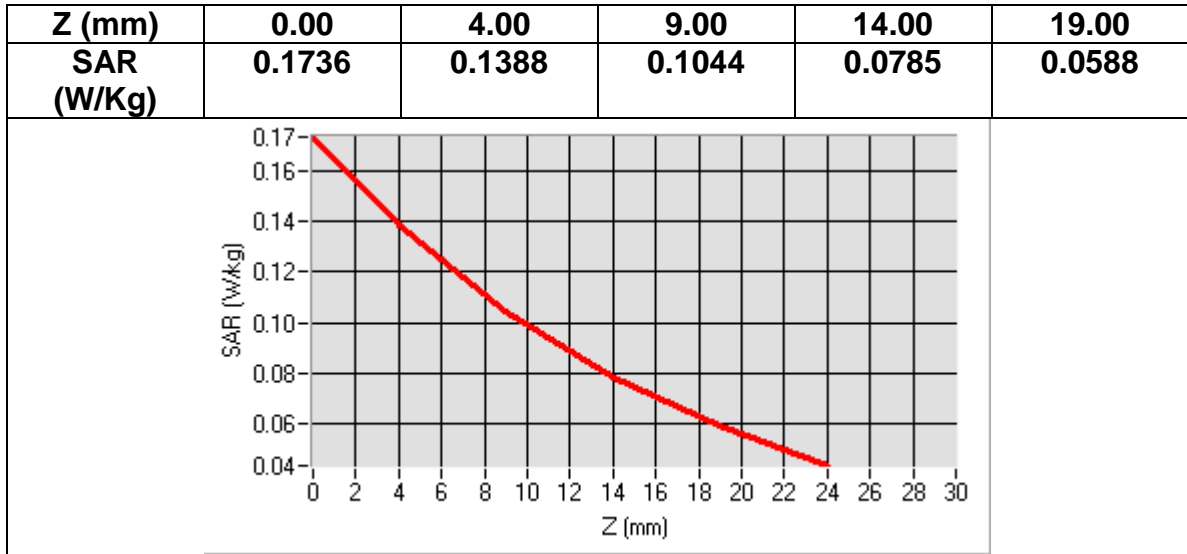

MEASUREMENT 24
Date of measurement: 2016/07/05

Area Scan	<u>dx=8mm dy=8mmh= 5.00 mm</u>
Zoom Scan	<u>7x7x7,dx=5mm dy=5mm dz=5mm, dx=8mm dy=8mm, h= 5.00 mm</u>
Phantom	<u>ELL16</u>
Device Position	<u>Right</u>
Band	<u>GSM850+VOICE</u>
Channels	<u>Middle</u>
Signal	<u>TDMA (Crest factor: 8.0)</u>

Frequency (MHz)	836.599976
Relative permittivity (real part)	55.195076
Relative permittivity (imaginary part)	20.912214
Conductivity (S/m)	0.971953
Variation (%)	1.430000

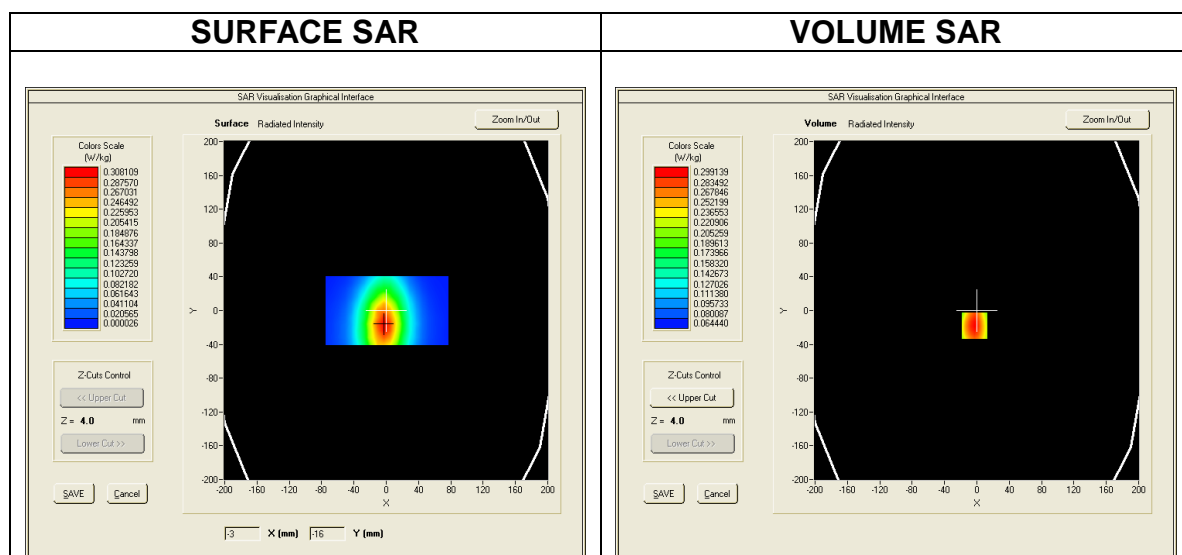

Maximum location: X=5.00, Y=-5.00
SAR Peak: 0.38 W/kg

SAR 10g (W/Kg)	0.193585
SAR 1g (W/Kg)	0.275246

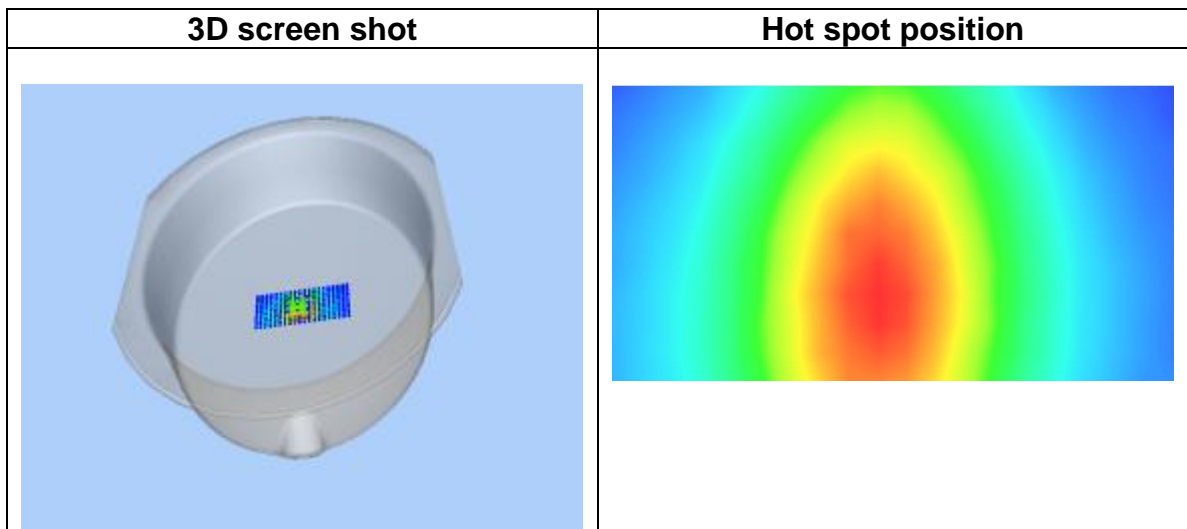
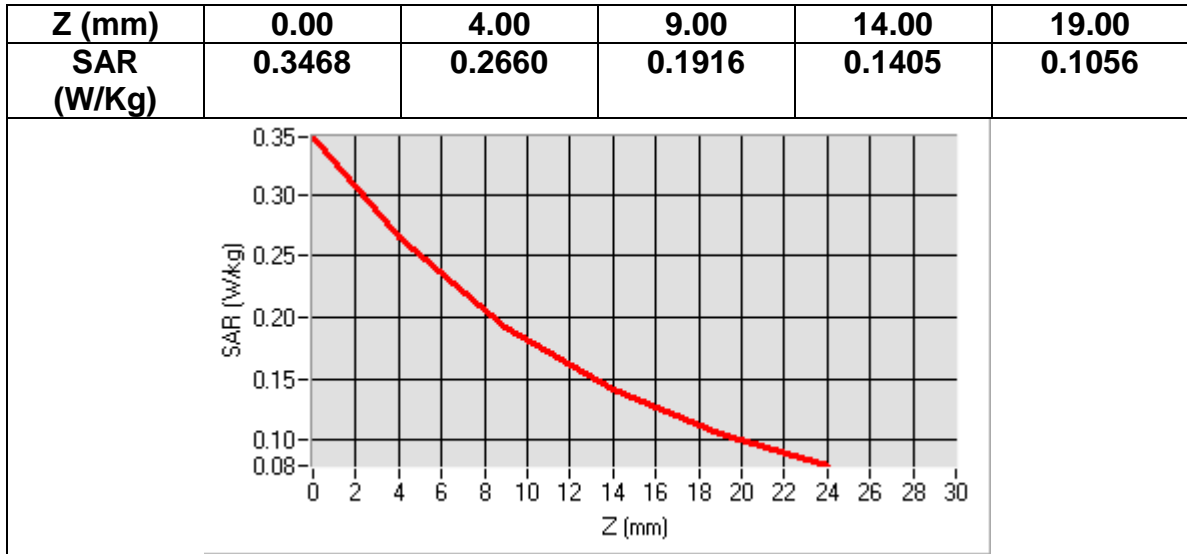

MEASUREMENT 25
Date of measurement: 2016/07/05

Area Scan	<u>dx=8mm dy=8mmh= 5.00 mm</u>
Zoom Scan	<u>7x7x7,dx=5mm dy=5mm dz=5mm, dx=8mm dy=8mm, h= 5.00 mm</u>
Phantom	<u>ELLI16</u>
Device Position	<u>Back</u>
Band	<u>GSM850+EDGE(1up1down)</u>
Channels	<u>Middle</u>
Signal	<u>TDMA (Crest factor: 8.0)</u>

Frequency (MHz)	836.599976
Relative permittivity (real part)	55.195076
Relative permittivity (imaginary part)	20.912214
Conductivity (S/m)	0.971953
Variation (%)	1.610000

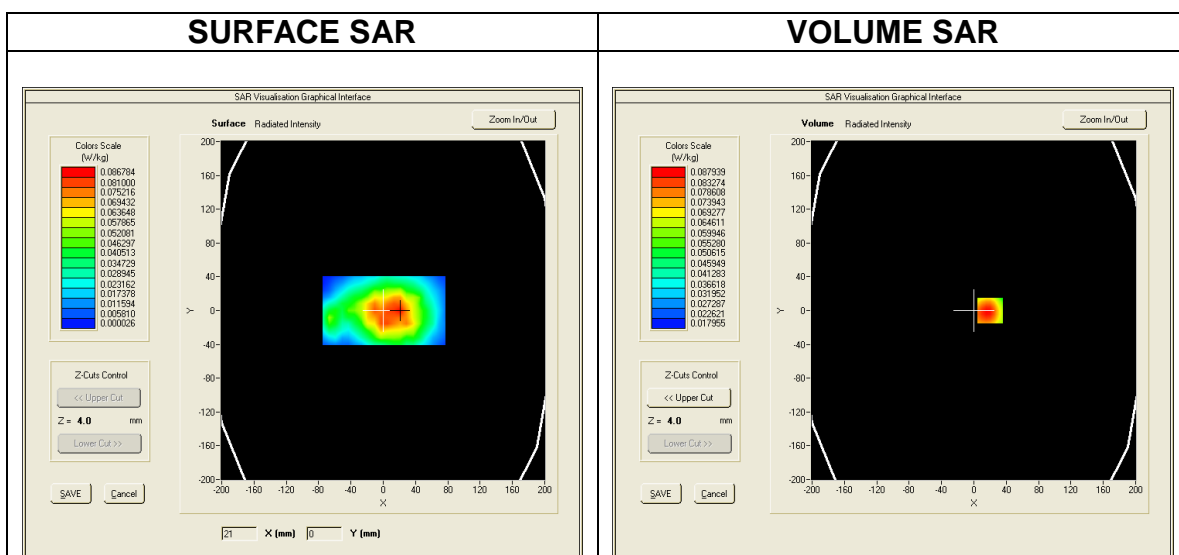

Maximum location: X=6.00, Y=0.00
SAR Peak: 0.11 W/kg

SAR 10g (W/Kg)	0.059720
SAR 1g (W/Kg)	0.082649

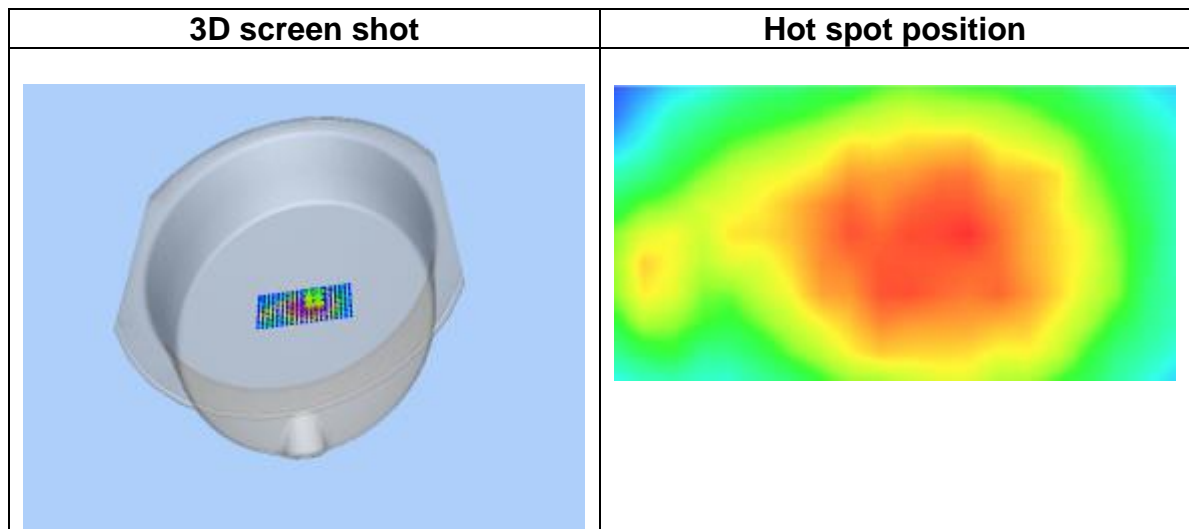
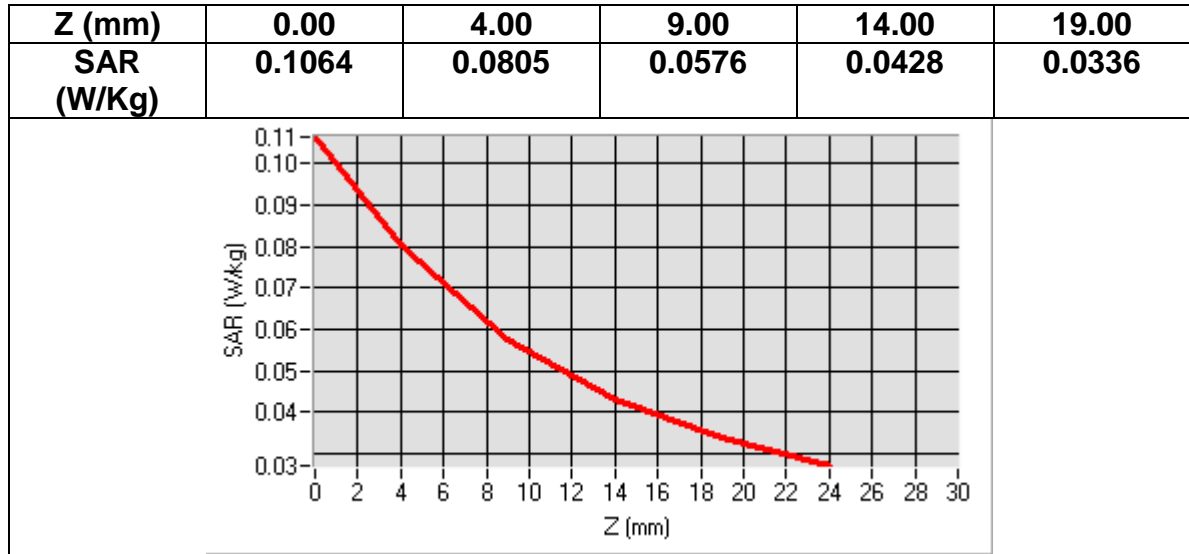

MEASUREMENT 26
Date of measurement: 2016/07/05

<u>Area Scan</u>	<u>dx=8mm dy=8mmh= 5.00 mm</u>
<u>Zoom Scan</u>	<u>7x7x7,dx=5mm dy=5mm dz=5mm, dx=8mm dy=8mm, h= 5.00 mm</u>
<u>Phantom</u>	<u>ELLI16</u>
<u>Device Position</u>	<u>Back</u>
<u>Band</u>	<u>GSM850+GPRS(4up1down)</u>
<u>Channels</u>	<u>Middle</u>
<u>Signal</u>	<u>TDMA (Crest factor: 2.0)</u>

Frequency (MHz)	836.599976
Relative permittivity (real part)	55.195076
Relative permittivity (imaginary part)	20.912214
Conductivity (S/m)	0.971953
Variation (%)	-1.640000

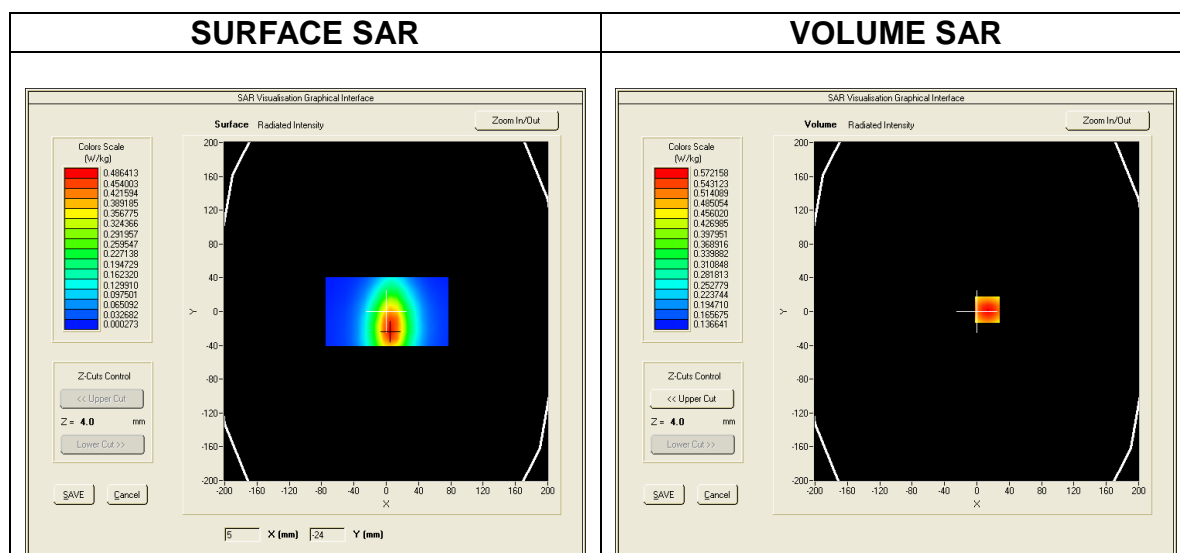

Maximum location: X=13.00, Y=2.00
SAR Peak: 0.81 W/kg

SAR 10g (W/Kg)	0.416526
SAR 1g (W/Kg)	0.590187

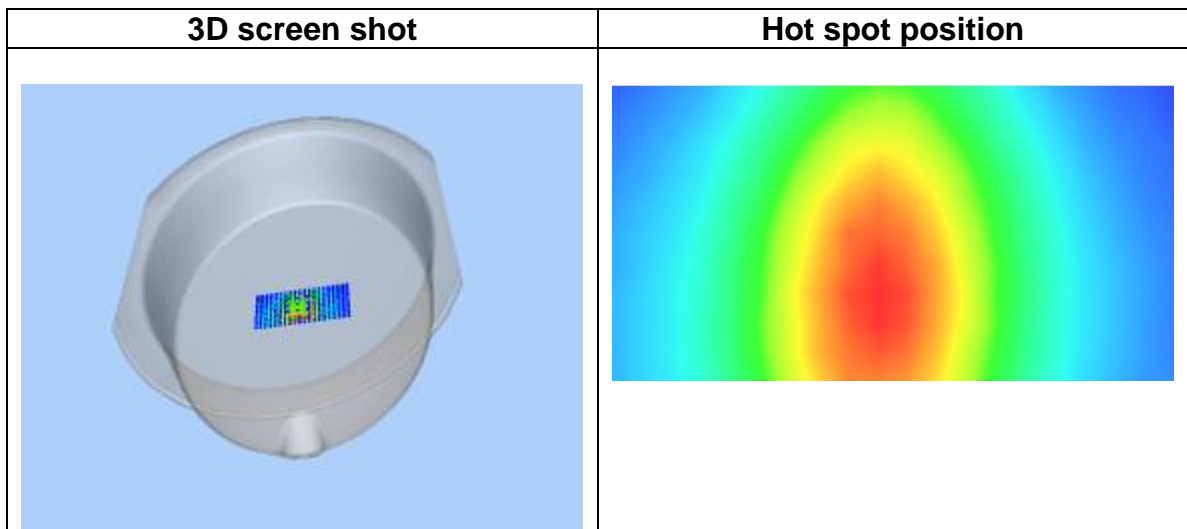
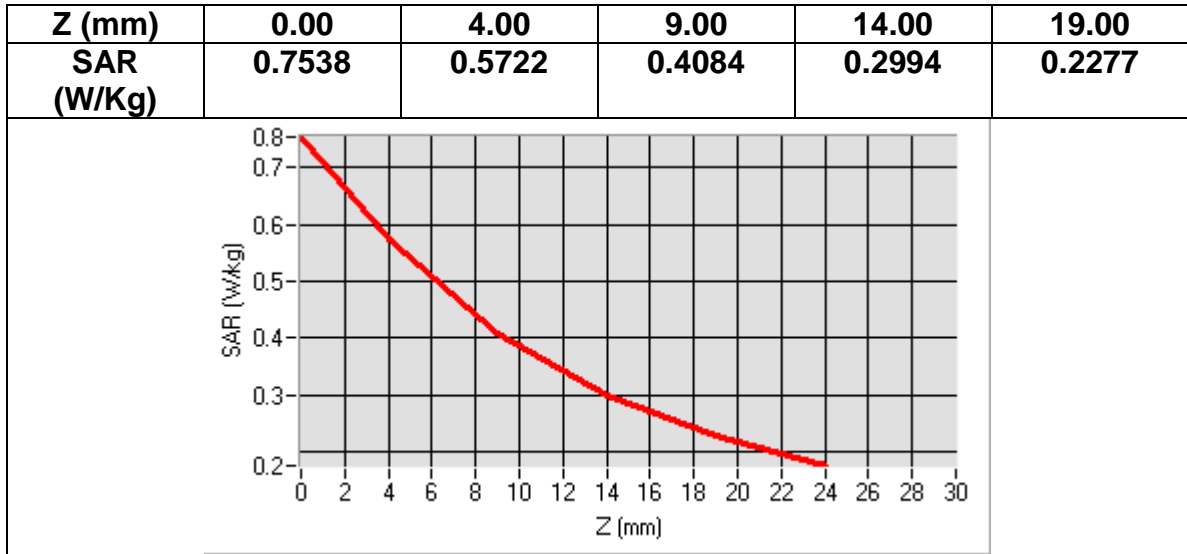

MEASUREMENT 27
Date of measurement: 2016/07/05

Area Scan	<u>dx=8mm dy=8mmh= 5.00 mm</u>
Zoom Scan	<u>7x7x7,dx=5mm dy=5mm dz=5mm, dx=8mm dy=8mm, h= 5.00 mm</u>
Phantom	<u>ELLI16</u>
Device Position	<u>Back</u>
Band	<u>GSM850+VOICE</u>
Channels	<u>Middle</u>
Signal	<u>TDMA (Crest factor: 8.0)</u>

Frequency (MHz)	836.599976
Relative permittivity (real part)	55.195076
Relative permittivity (imaginary part)	20.912214
Conductivity (S/m)	0.971953
Variation (%)	0.580000

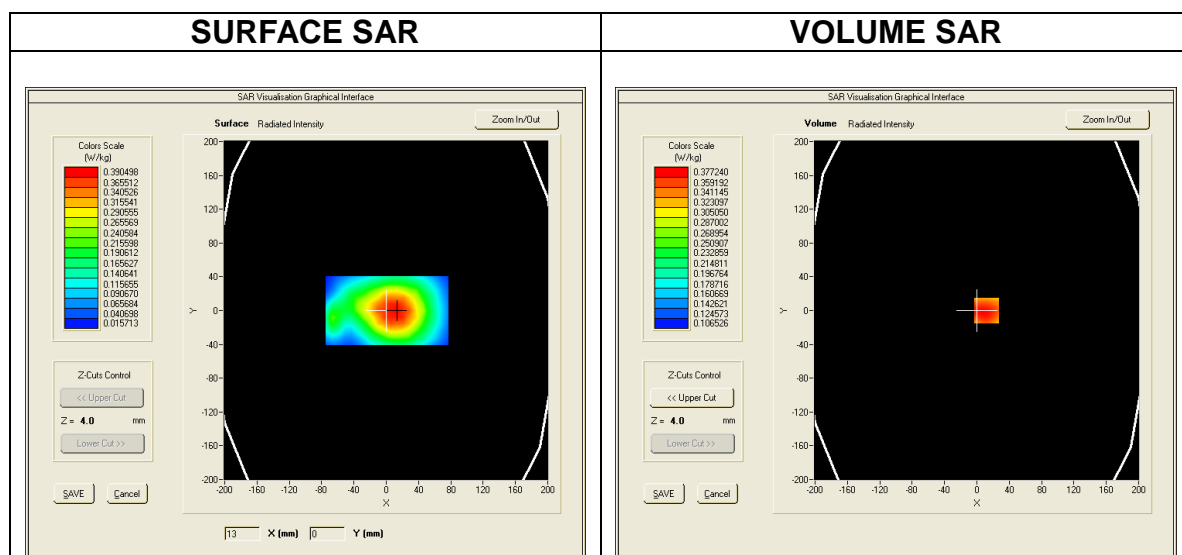

Maximum location: X=5.00, Y=0.00
SAR Peak: 0.45 W/kg

SAR 10g (W/Kg)	0.256368
SAR 1g (W/Kg)	0.343143

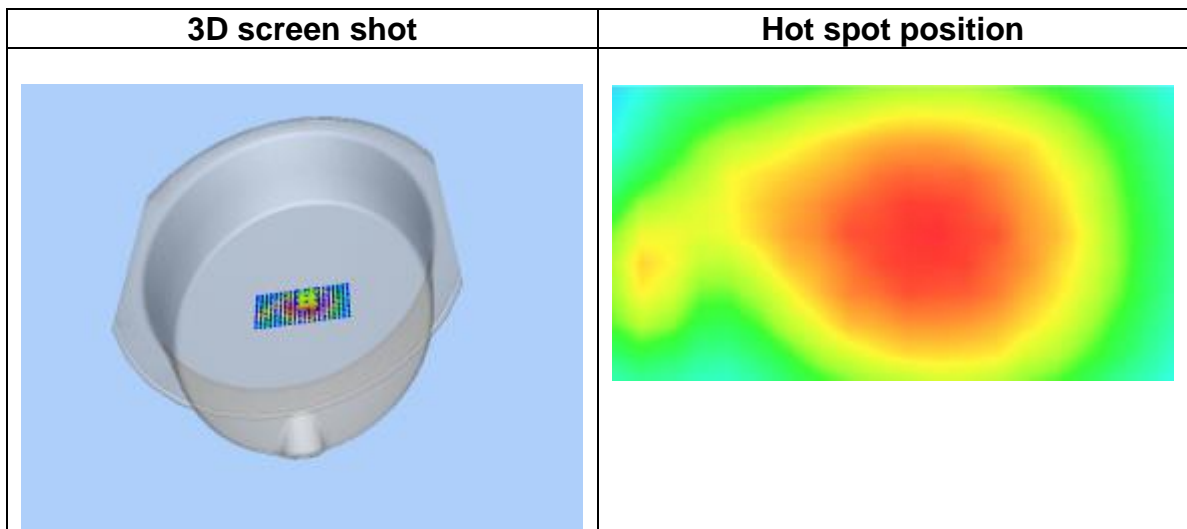
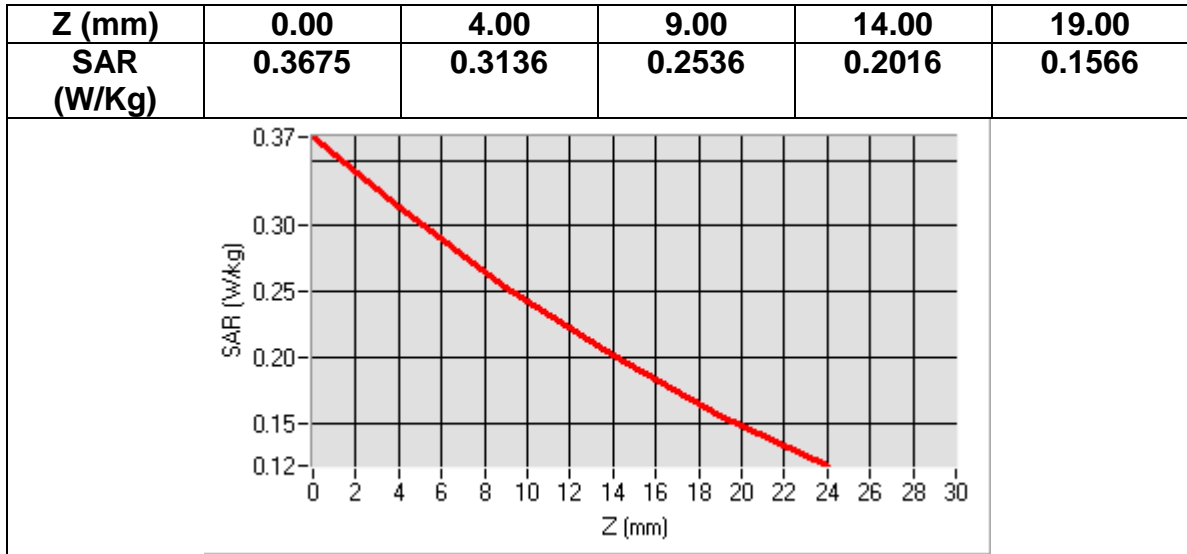

GSM1900

MEASUREMENT 1
 Date of measurement: 2016/07/01

Area Scan	<u>sam_direct_droit2_surf8mm.txt, h= 5.00 mm</u>
Zoom Scan	<u>7x7x7,dx=5mm dy=5mm dz=5mm, sam_direct_droit2_surf8mm.txt, h= 5.00 mm</u>
Phantom	<u>Right head</u>
Device Position	<u>Cheek</u>
Band	<u>GSM1900+EDGE(1up1down)</u>
Channels	<u>Middle</u>
Signal	<u>TDMA (Crest factor: 8.0)</u>

Frequency (MHz)	1880.000000
Relative permittivity (real part)	40.000000
Relative permittivity (imaginary part)	13.408000
Conductivity (S/m)	1.400391
Variation (%)	2.760000

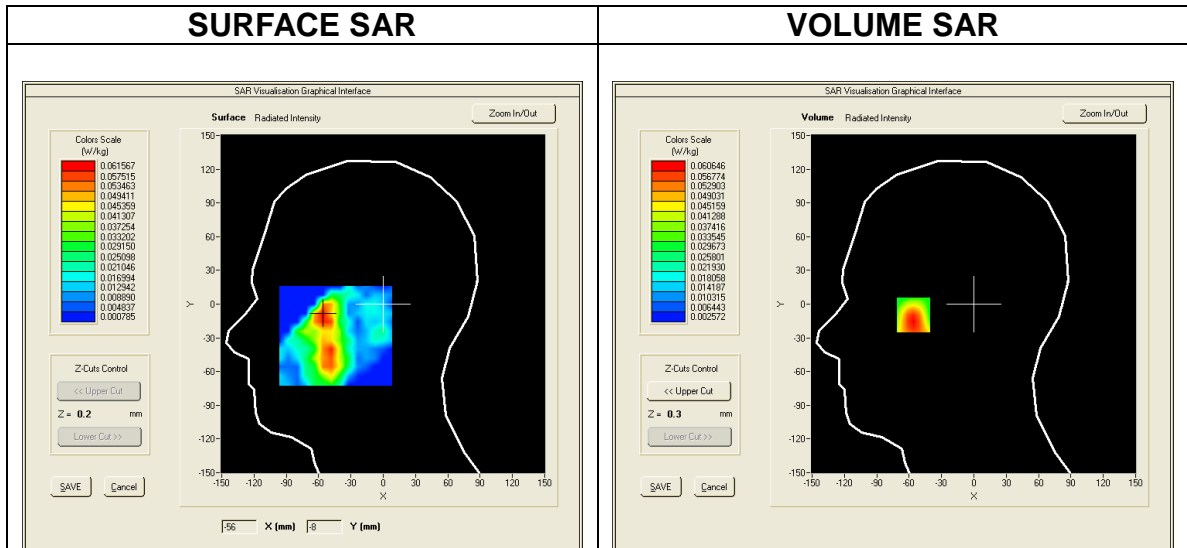

Maximum location: X=-56.00, Y=-9.00
SAR Peak: 0.09 W/kg

SAR 10g (W/Kg)	0.033711
SAR 1g (W/Kg)	0.057565

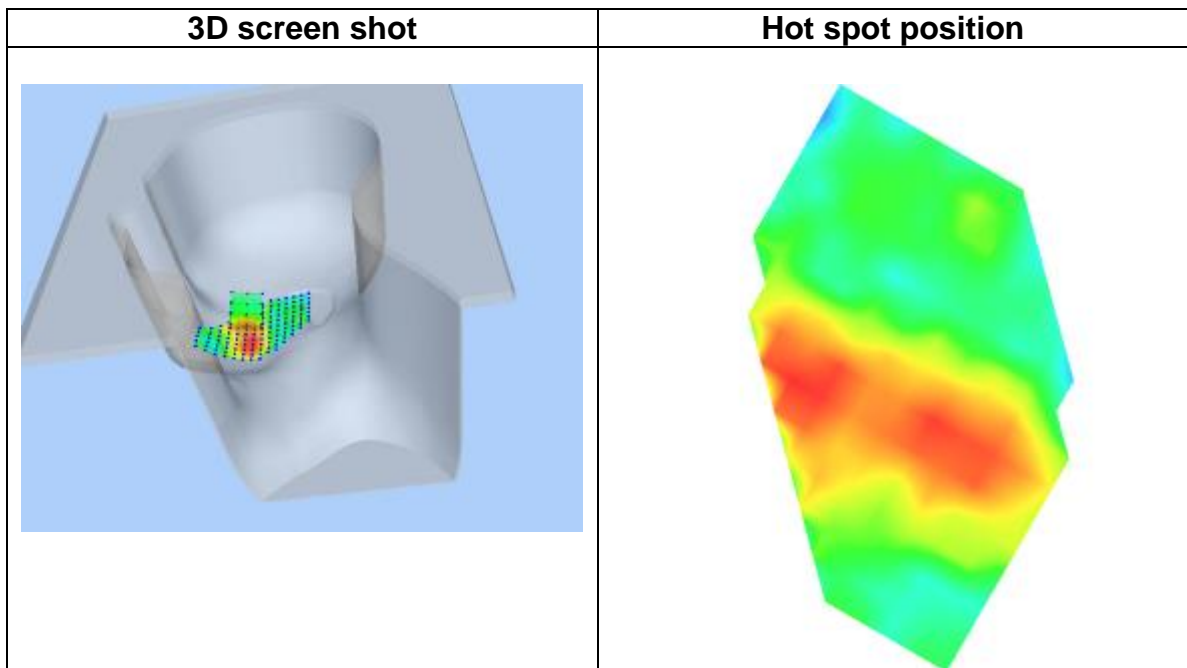
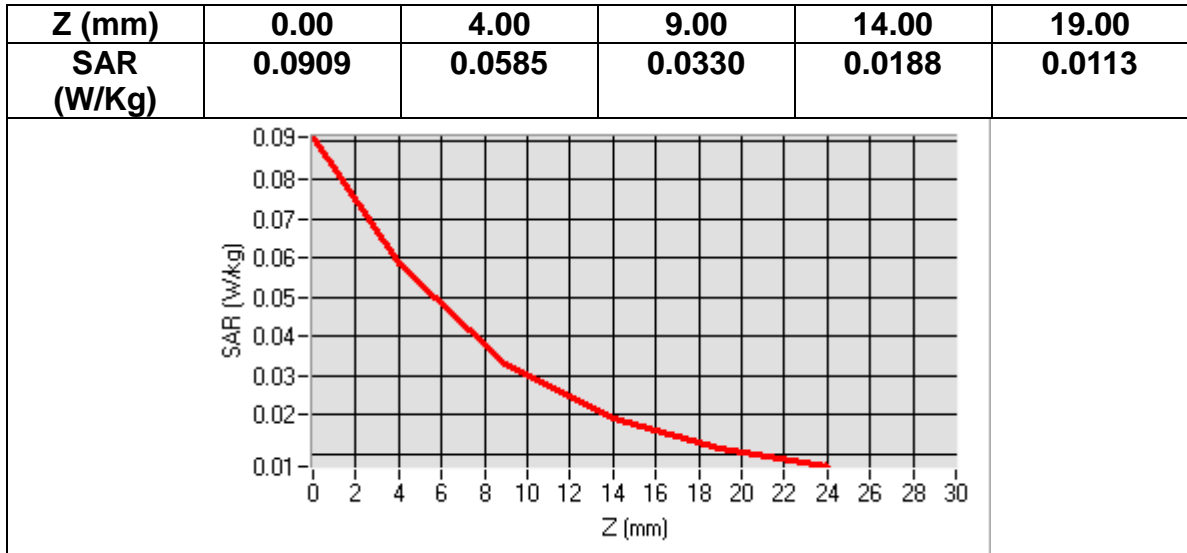

MEASUREMENT 2
Date of measurement: 2016/07/01

Area Scan	<u>sam_direct_droit2_surf8mm.txt, h= 5.00 mm</u>
Zoom Scan	<u>7x7x7,dx=5mm dy=5mm dz=5mm, sam_direct_droit2_surf8mm.txt, h= 5.00 mm</u>
Phantom	<u>Right head</u>
Device Position	<u>Cheek</u>
Band	<u>GSM1900+GPRS(4up1down)</u>
Channels	<u>Middle</u>
Signal	<u>TDMA (Crest factor: 2.0)</u>

Frequency (MHz)	1880.000000
Relative permittivity (real part)	40.000000
Relative permittivity (imaginary part)	13.408000
Conductivity (S/m)	1.400391
Variation (%)	-1.180000

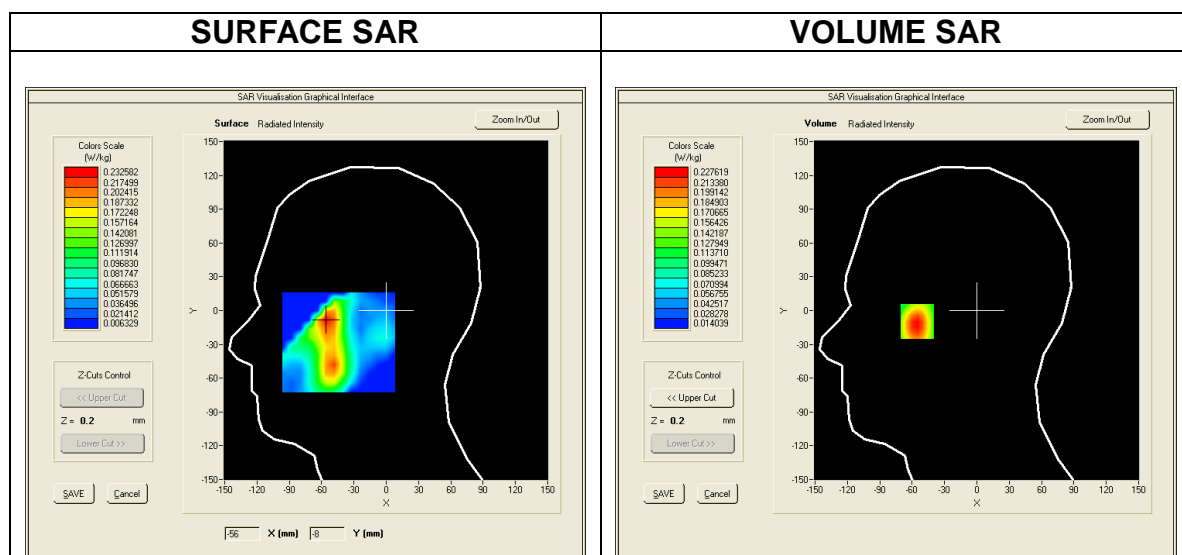

Maximum location: X=-55.00, Y=-9.00
SAR Peak: 0.33 W/kg

SAR 10g (W/Kg)	0.130131
SAR 1g (W/Kg)	0.214380

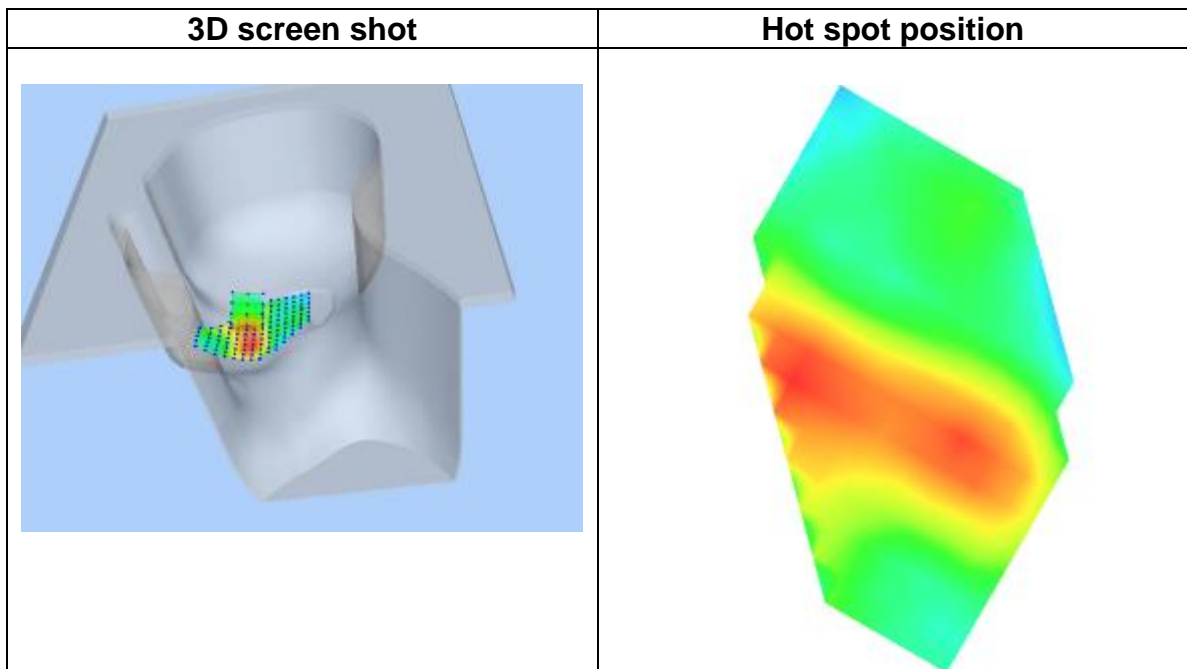
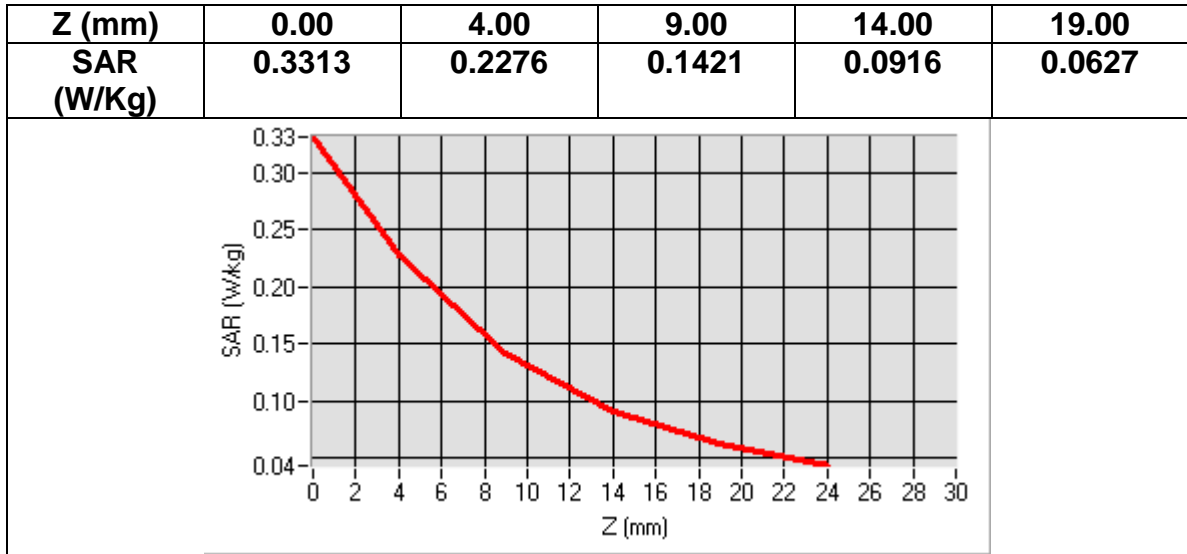

MEASUREMENT 3
Date of measurement: 2016/07/01

<u>Area Scan</u>	<u>sam_direct_droit2_surf8mm.txt, h= 5.00 mm</u>
<u>Zoom Scan</u>	<u>7x7x7,dx=5mm dy=5mm dz=5mm, sam_direct_droit2_surf8mm.txt, h= 5.00 mm</u>
<u>Phantom</u>	<u>Right head</u>
<u>Device Position</u>	<u>Cheek</u>
<u>Band</u>	<u>GSM1900+VOICE</u>
<u>Channels</u>	<u>Middle</u>
<u>Signal</u>	<u>TDMA (Crest factor: 8.0)</u>

Frequency (MHz)	1880.000000
Relative permittivity (real part)	40.000000
Relative permittivity (imaginary part)	13.408000
Conductivity (S/m)	1.400391
Variation (%)	-0.140000

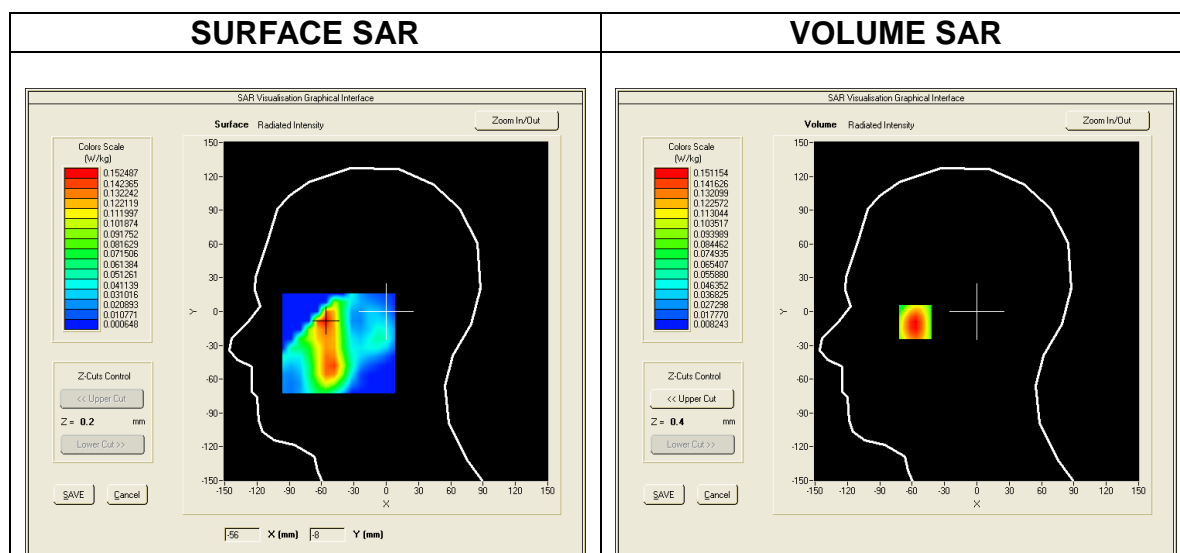

Maximum location: X=-57.00, Y=-8.00
SAR Peak: 0.21 W/kg

SAR 10g (W/Kg)	0.088507
SAR 1g (W/Kg)	0.142283

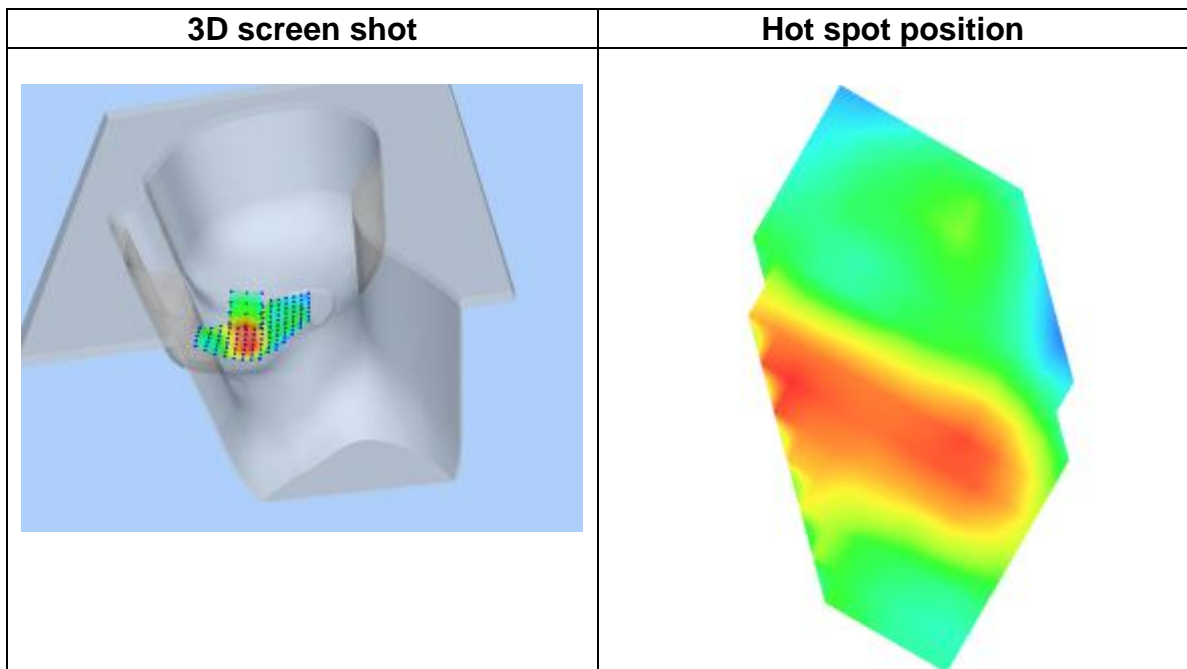
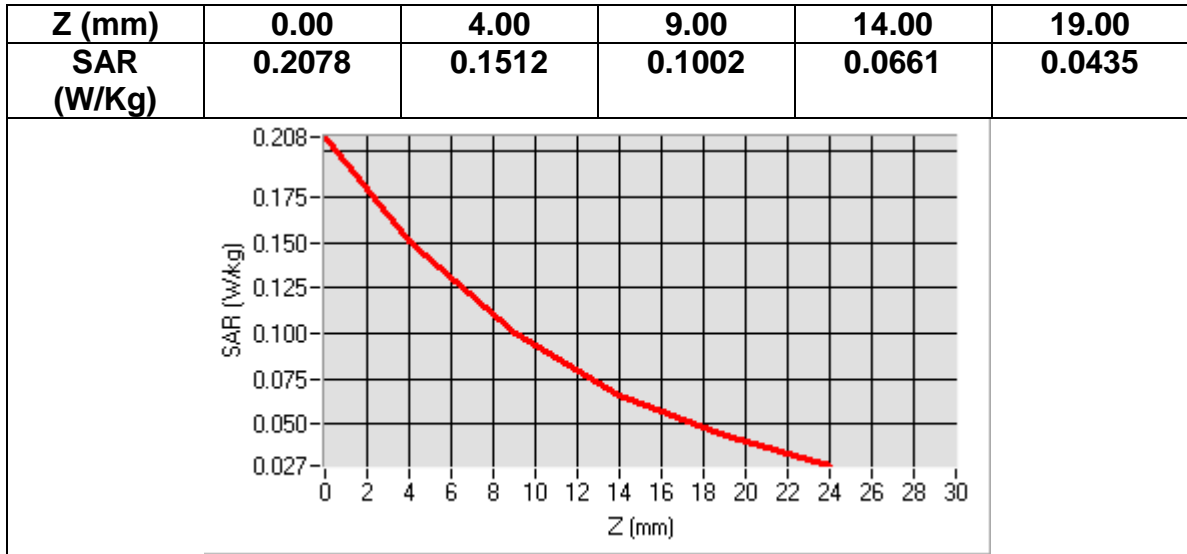

MEASUREMENT 4
Date of measurement: 2016/07/01

Area Scan	<u>sam_direct_droit2_surf8mm.txt, h= 5.00 mm</u>
Zoom Scan	<u>7x7x7,dx=5mm dy=5mm dz=5mm, sam_direct_droit2_surf8mm.txt, h= 5.00 mm</u>
Phantom	<u>Right head</u>
Device Position	<u>Tilt</u>
Band	<u>GSM1900+EDGE(1up1down)</u>
Channels	<u>Middle</u>
Signal	<u>TDMA (Crest factor: 8.0)</u>

Frequency (MHz)	1880.000000
Relative permittivity (real part)	40.000000
Relative permittivity (imaginary part)	13.408000
Conductivity (S/m)	1.400391
Variation (%)	-0.900000

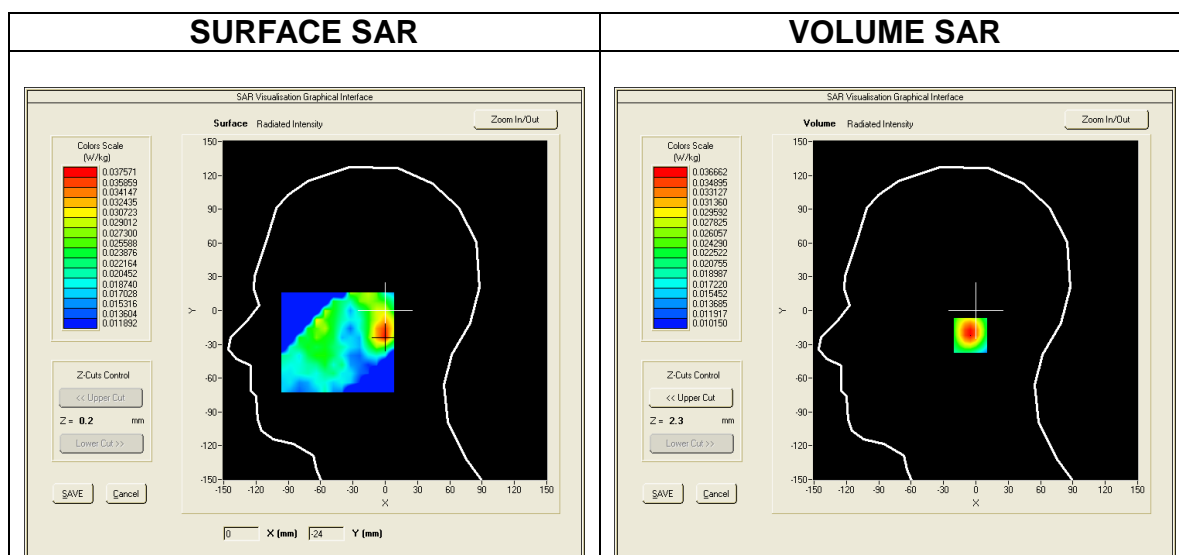

Maximum location: X=1.00, Y=-22.00
SAR Peak: 0.05 W/kg

SAR 10g (W/Kg)	0.024210
SAR 1g (W/Kg)	0.035024

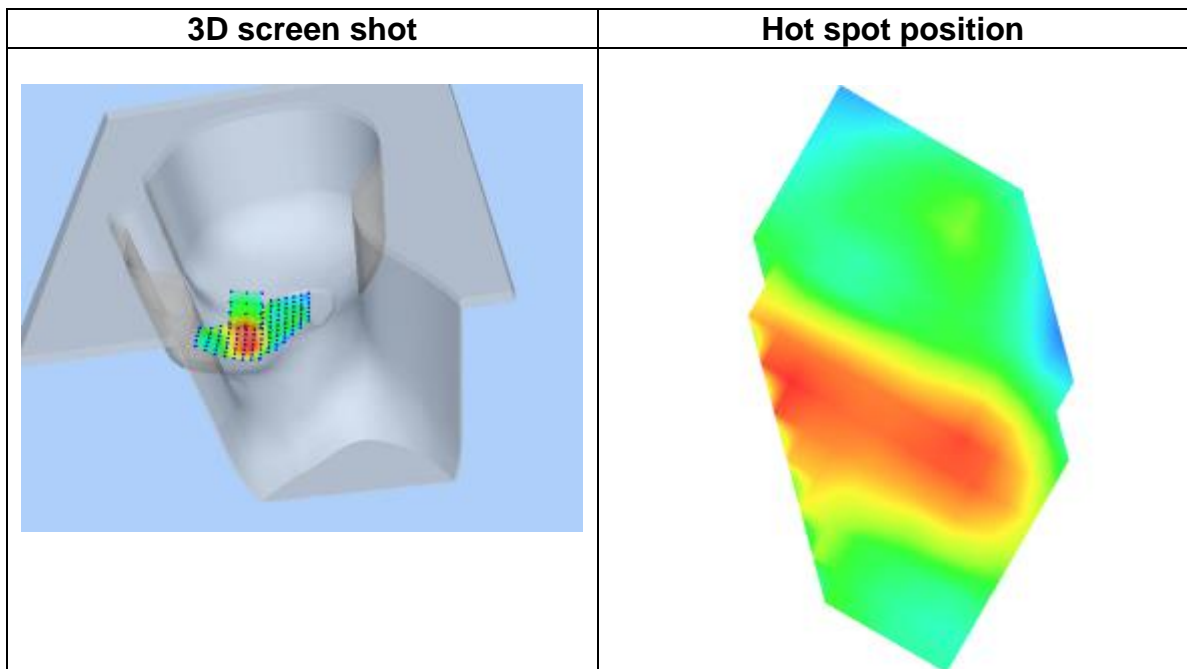
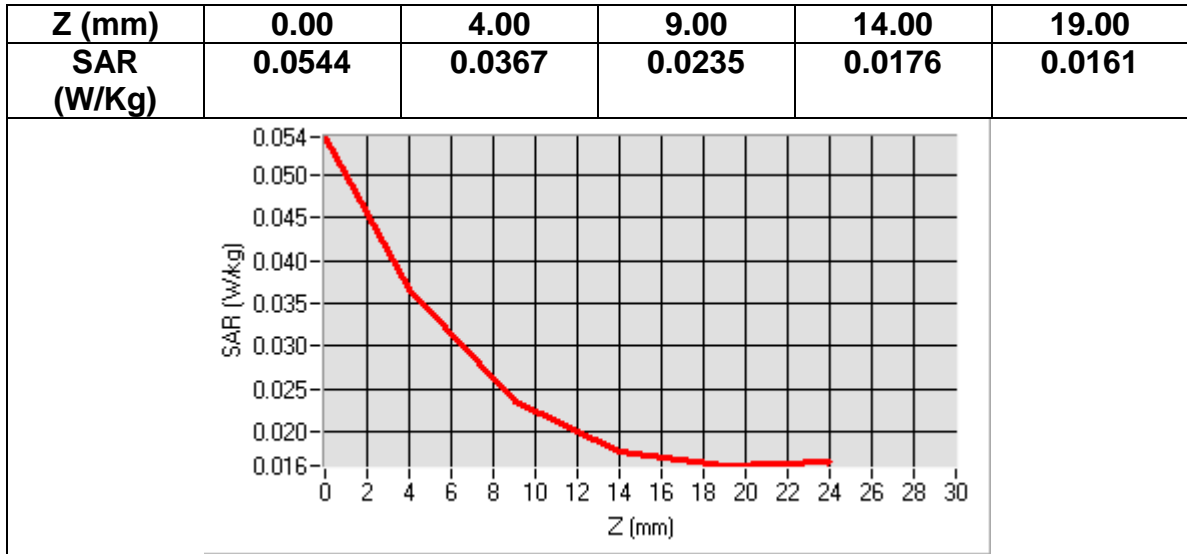

MEASUREMENT 5
Date of measurement: 2016/07/01

Area Scan	<u>sam_direct_droit2_surf8mm.txt, h= 5.00 mm</u>
Zoom Scan	<u>7x7x7,dx=5mm dy=5mm dz=5mm, sam_direct_droit2_surf8mm.txt, h= 5.00 mm</u>
Phantom	<u>Right head</u>
Device Position	<u>Tilt</u>
Band	<u>GSM1900+GPRS(4up1down)</u>
Channels	<u>Middle</u>
Signal	<u>TDMA (Crest factor: 2.0)</u>

Frequency (MHz)	1880.000000
Relative permittivity (real part)	40.000000
Relative permittivity (imaginary part)	13.408000
Conductivity (S/m)	1.400391
Variation (%)	-2.820000

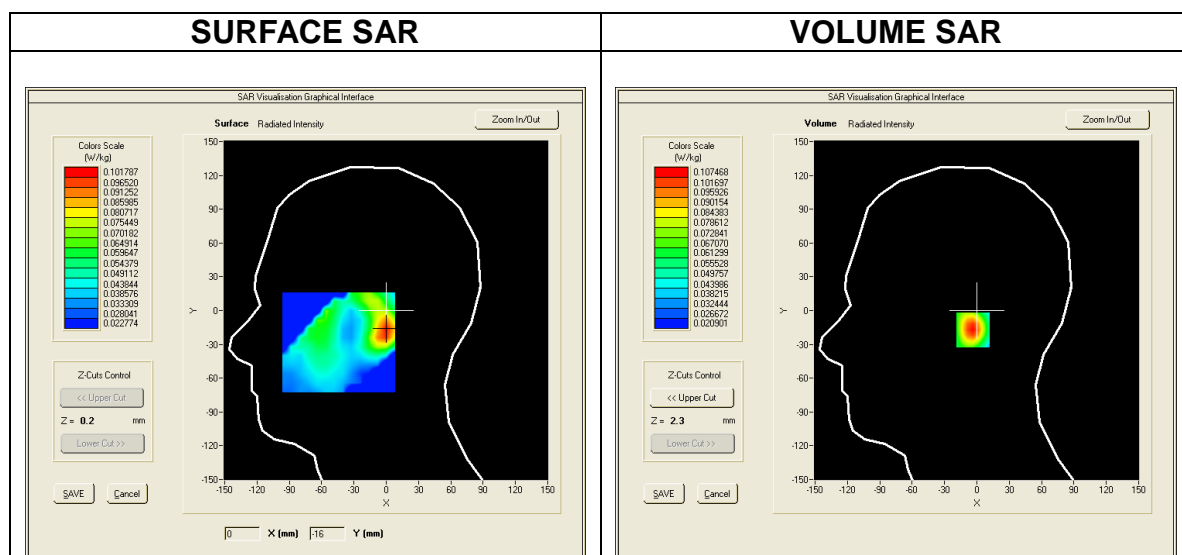

Maximum location: X=0.00, Y=-17.00
SAR Peak: 0.15 W/kg

SAR 10g (W/Kg)	0.063471
SAR 1g (W/Kg)	0.099655

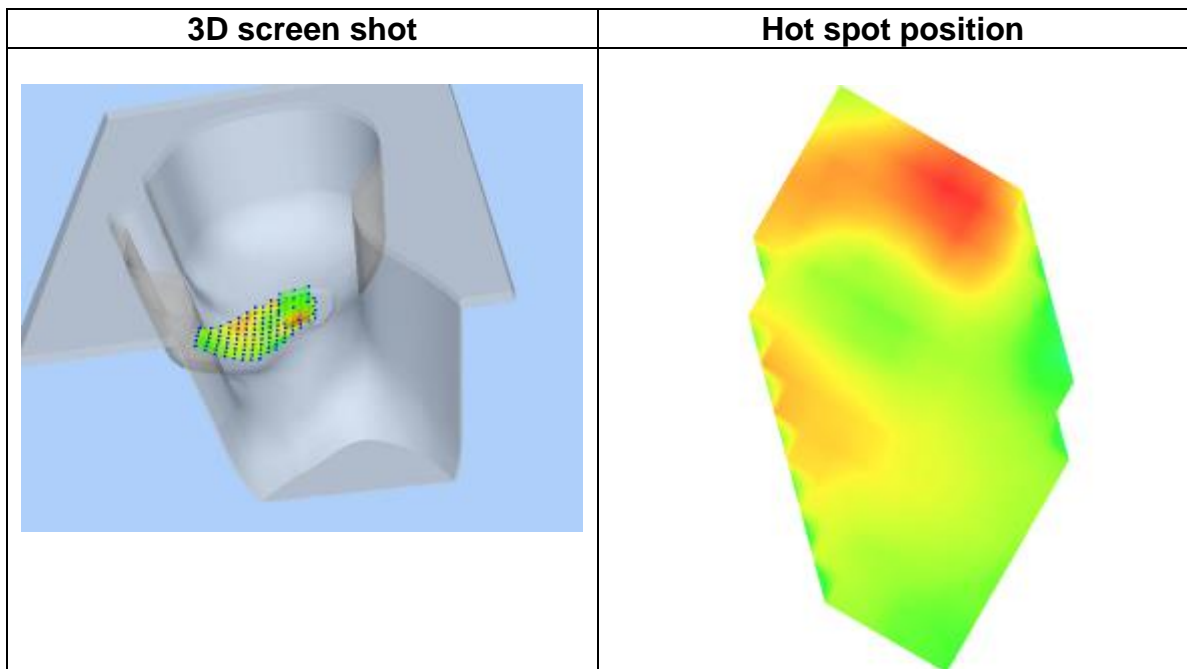
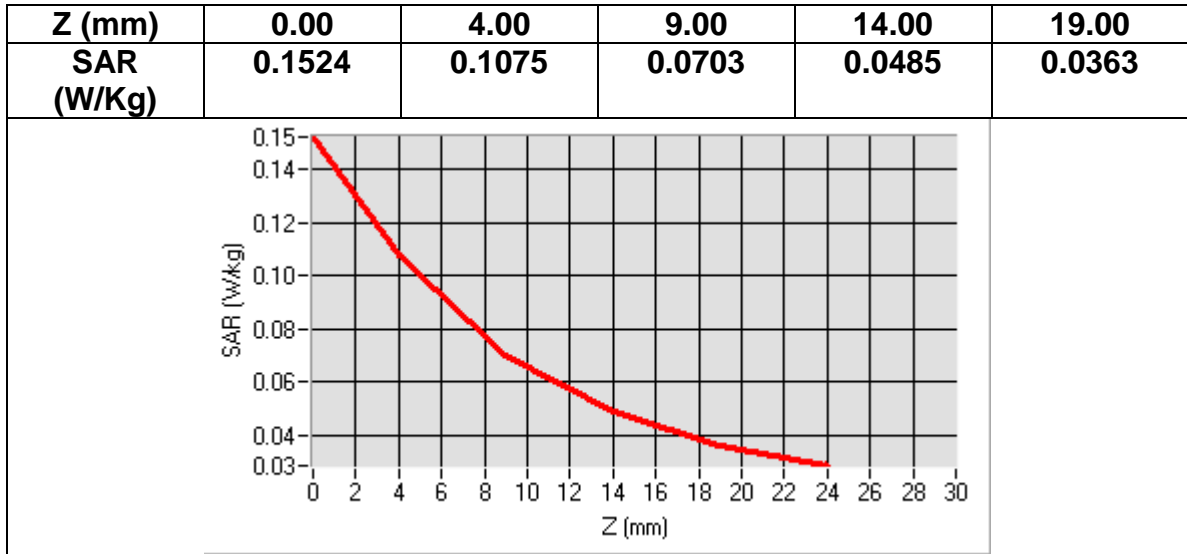

MEASUREMENT 6
 Date of measurement: 2016/07/01

<u>Area Scan</u>	<u>sam_direct_droit2_surf8mm.txt, h= 5.00 mm</u>
<u>Zoom Scan</u>	<u>7x7x7,dx=5mm dy=5mm dz=5mm, sam_direct_droit2_surf8mm.txt, h= 5.00 mm</u>
<u>Phantom</u>	<u>Right head</u>
<u>Device Position</u>	<u>Tilt</u>
<u>Band</u>	<u>GSM1900+VOICE</u>
<u>Channels</u>	<u>Middle</u>
<u>Signal</u>	<u>TDMA (Crest factor: 8.0)</u>

Frequency (MHz)	1880.000000
Relative permittivity (real part)	40.000000
Relative permittivity (imaginary part)	13.408000
Conductivity (S/m)	1.400391
Variation (%)	-2.150000

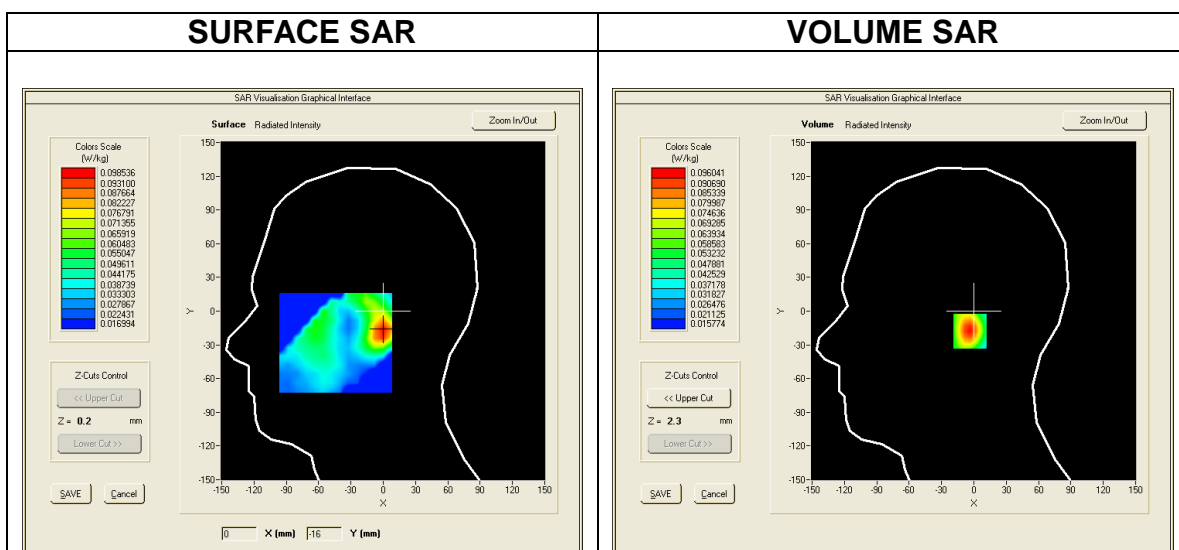

Maximum location: X=0.00, Y=-18.00
SAR Peak: 0.13 W/kg

SAR 10g (W/Kg)	0.057698
-----------------------	----------

SAR 1g (W/Kg)	0.089216
----------------------	----------

Z (mm)	0.00	4.00	9.00	14.00	19.00
SAR (W/Kg)	0.1275	0.0960	0.0670	0.0470	0.0332

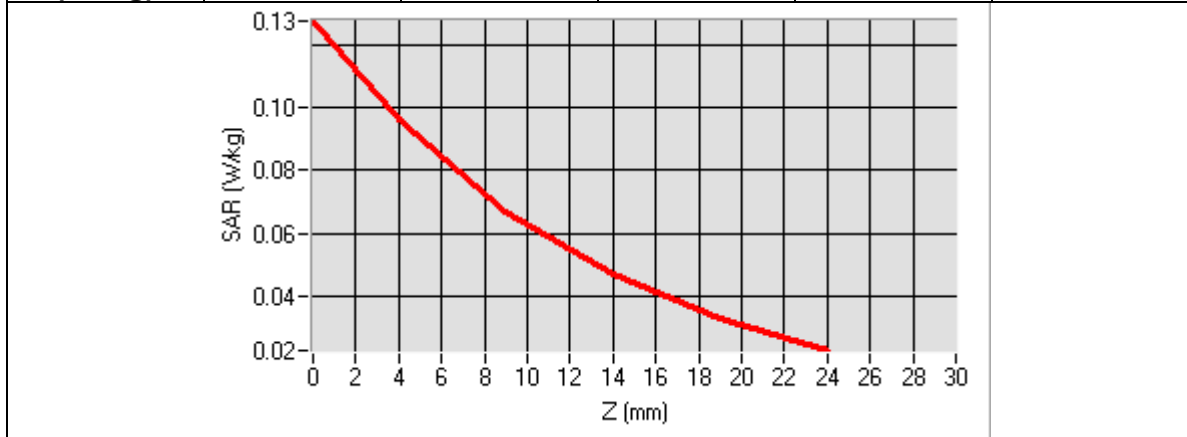

3D screen shot	Hot spot position

MEASUREMENT 7
Date of measurement: 2016/07/01

Area Scan	<u>sam_direct_droit2_surf8mm.txt, h=5.00mm</u>
Zoom Scan	<u>7x7x7,dx=5mm dy=5mm dz=5mm, sam_direct_droit2_surf8mm.txt, h= 5.00mm</u>
Phantom	<u>Left head</u>
Device Position	<u>Cheek</u>
Band	<u>GSM1900+EDGE(1up1down)</u>
Channels	<u>Middle</u>
Signal	<u>TDMA (Crest factor: 8.0)</u>

Frequency (MHz)	1880.000000
Relative permittivity (real part)	40.000000
Relative permittivity (imaginary part)	13.408000
Conductivity (S/m)	1.400391
Variation (%)	-3.750000

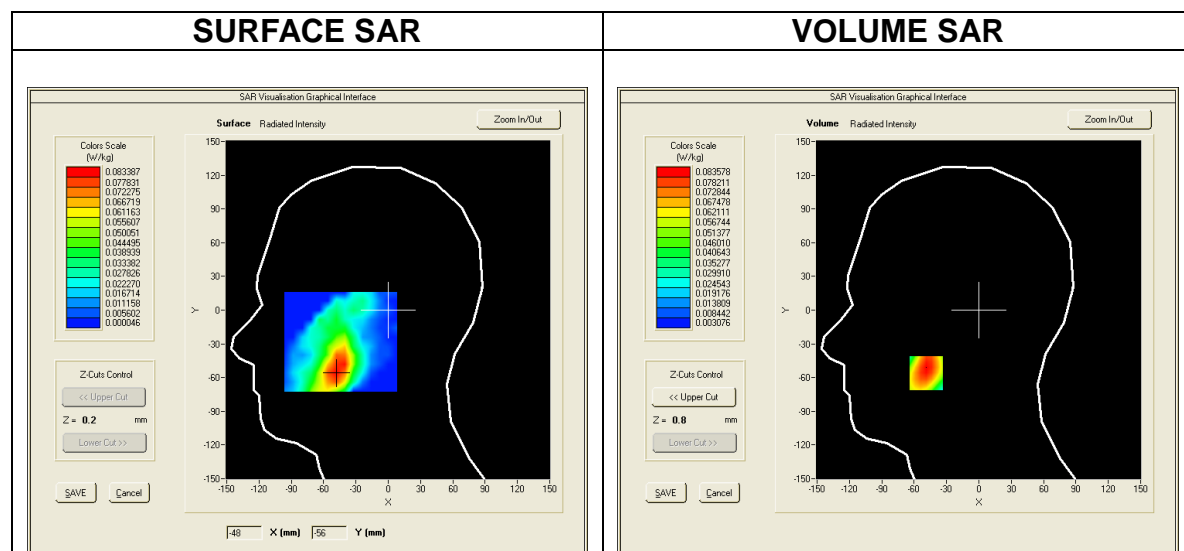

Maximum location: X=-49.00, Y=-56.00
SAR Peak: 0.11 W/kg

SAR 10g (W/Kg)	0.048031
SAR 1g (W/Kg)	0.078365

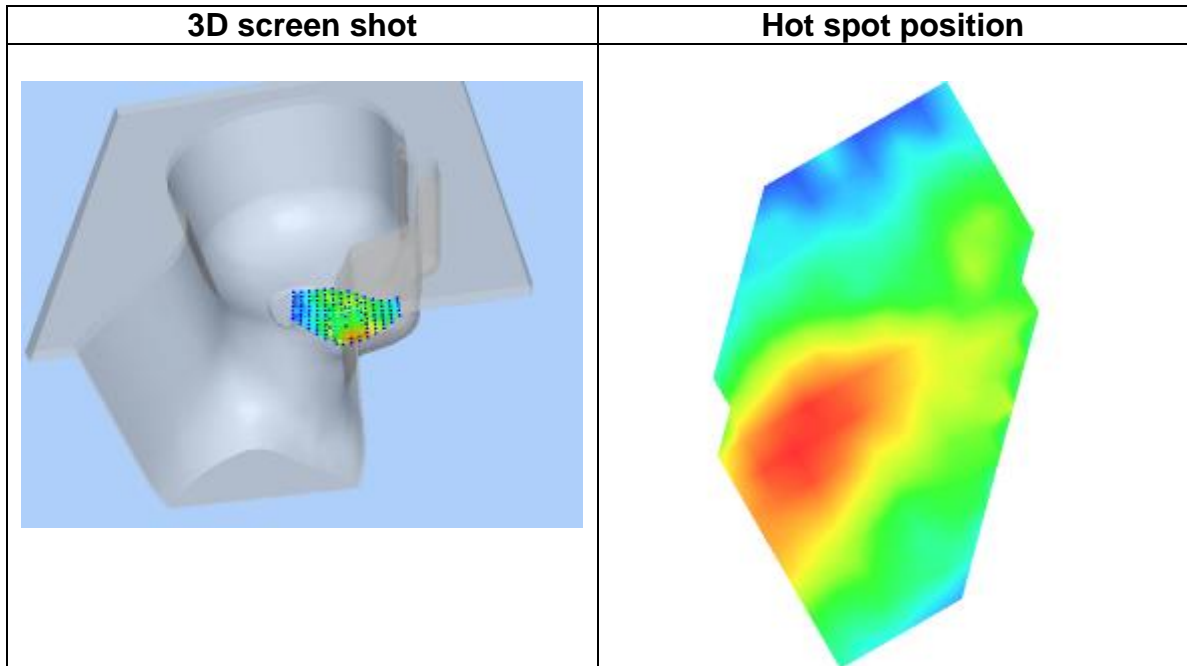
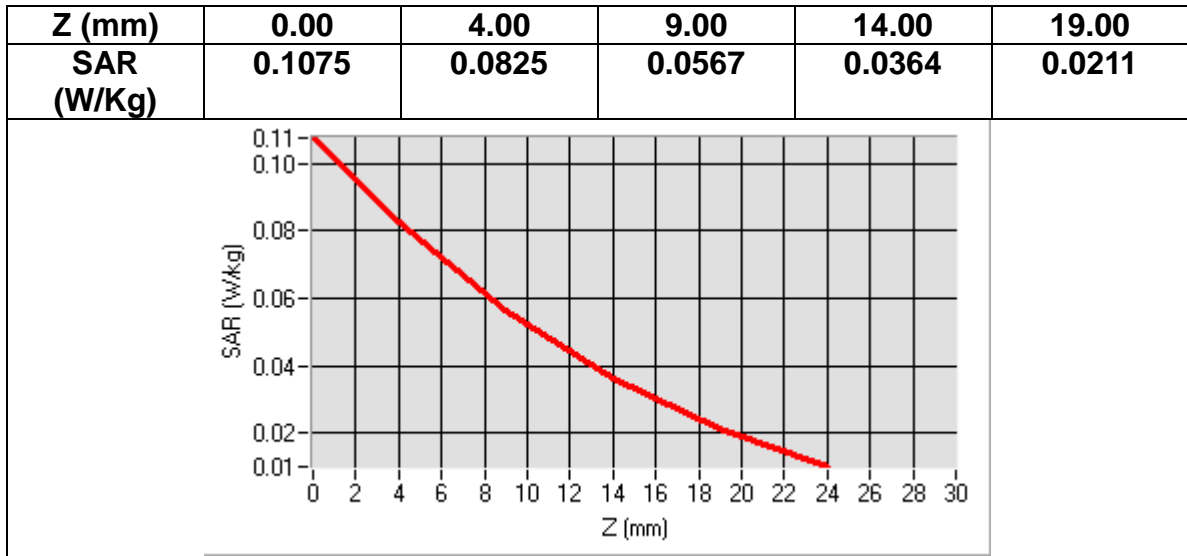

MEASUREMENT 8
Date of measurement: 2016/07/01

Area Scan	<u>sam_direct_droit2_surf8mm.txt, h= 5.00 mm</u>
Zoom Scan	<u>7x7x7,dx=5mm dy=5mm dz=5mm, sam_direct_droit2_surf8mm.txt, h= 5.00 mm</u>
Phantom	<u>Left head</u>
Device Position	<u>Cheek</u>
Band	<u>GSM1900+GPRS(4up1down)</u>
Channels	<u>Middle</u>
Signal	<u>TDMA (Crest factor: 2.0)</u>

Frequency (MHz)	1880.000000
Relative permittivity (real part)	40.000000
Relative permittivity (imaginary part)	13.408000
Conductivity (S/m)	1.400391
Variation (%)	-3.670000

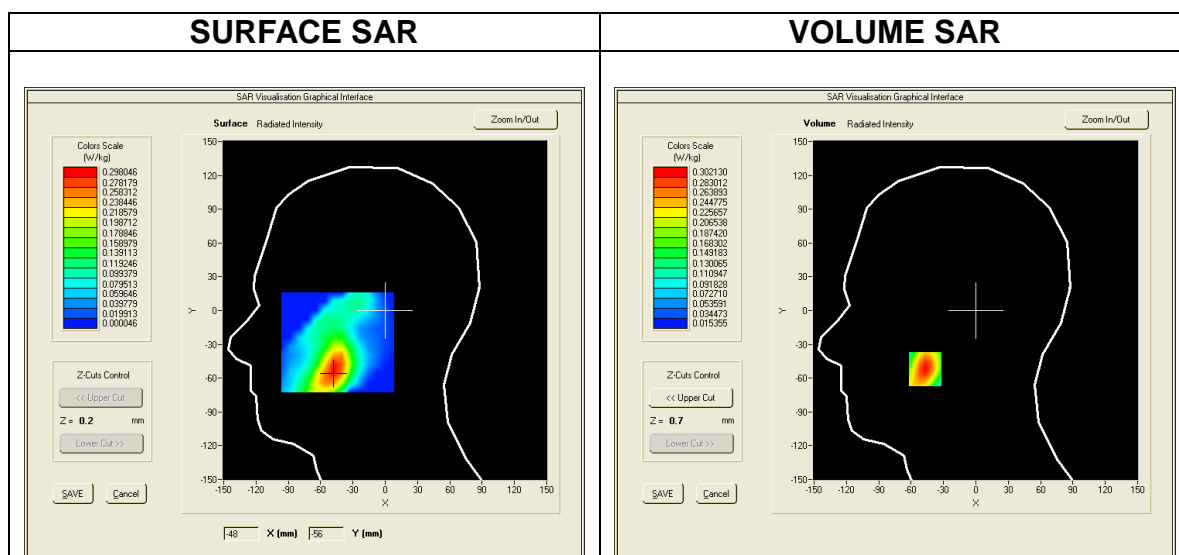

Maximum location: X=-47.00, Y=-52.00
SAR Peak: 0.43 W/kg

SAR 10g (W/Kg)	0.166386
SAR 1g (W/Kg)	0.280770

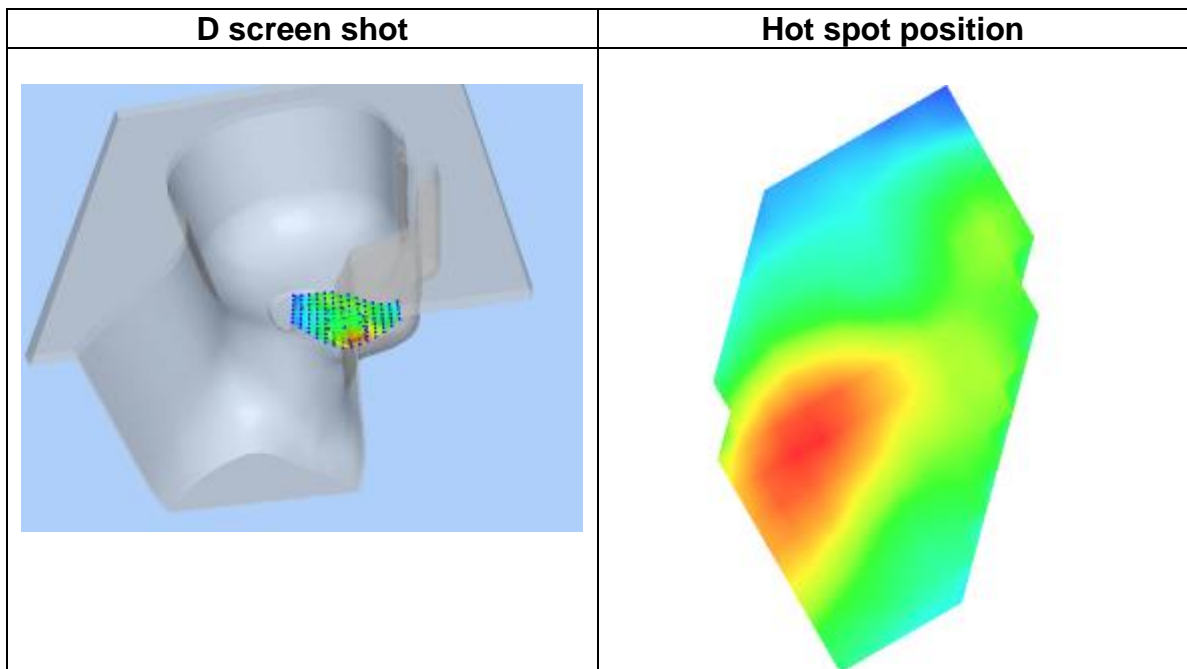
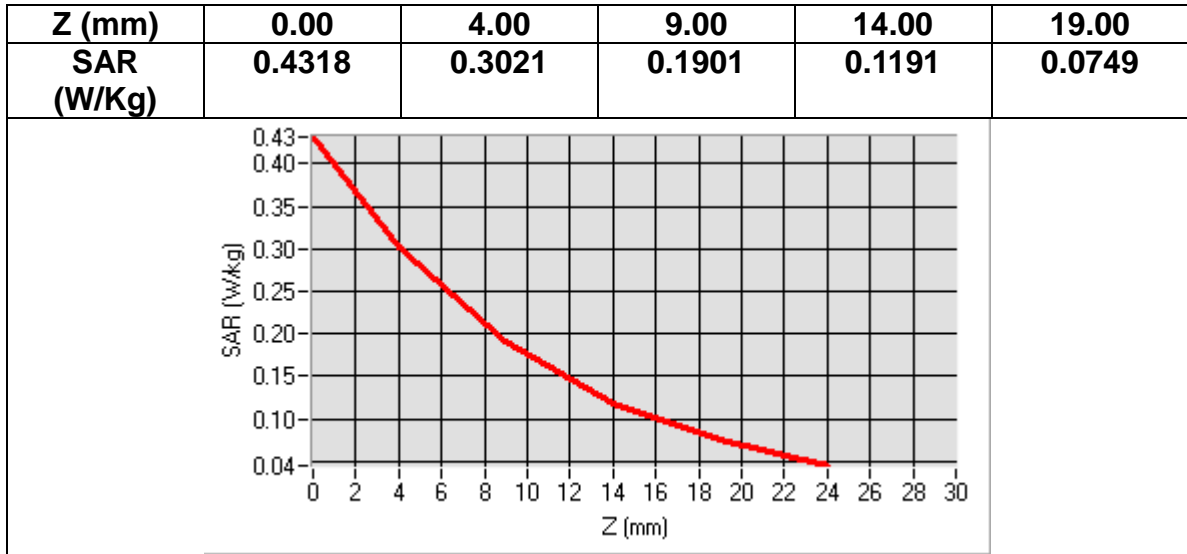

MEASUREMENT 9
Date of measurement: 2016/07/01

<u>Area Scan</u>	<u>sam_direct_droit2_surf8mm.txt, h= 5.00 mm</u>
<u>Zoom Scan</u>	<u>7x7x7,dx=5mm dy=5mm dz=5mm, sam_direct_droit2_surf8mm.txt, h= 5.00 mm</u>
<u>Phantom</u>	<u>Left head</u>
<u>Device Position</u>	<u>Cheek</u>
<u>Band</u>	<u>GSM1900+VOICE</u>
<u>Channels</u>	<u>Middle</u>
<u>Signal</u>	<u>TDMA (Crest factor: 8.0)</u>

Frequency (MHz)	1880.000000
Relative permittivity (real part)	40.000000
Relative permittivity (imaginary part)	13.408000
Conductivity (S/m)	1.400391
Variation (%)	-3.920000

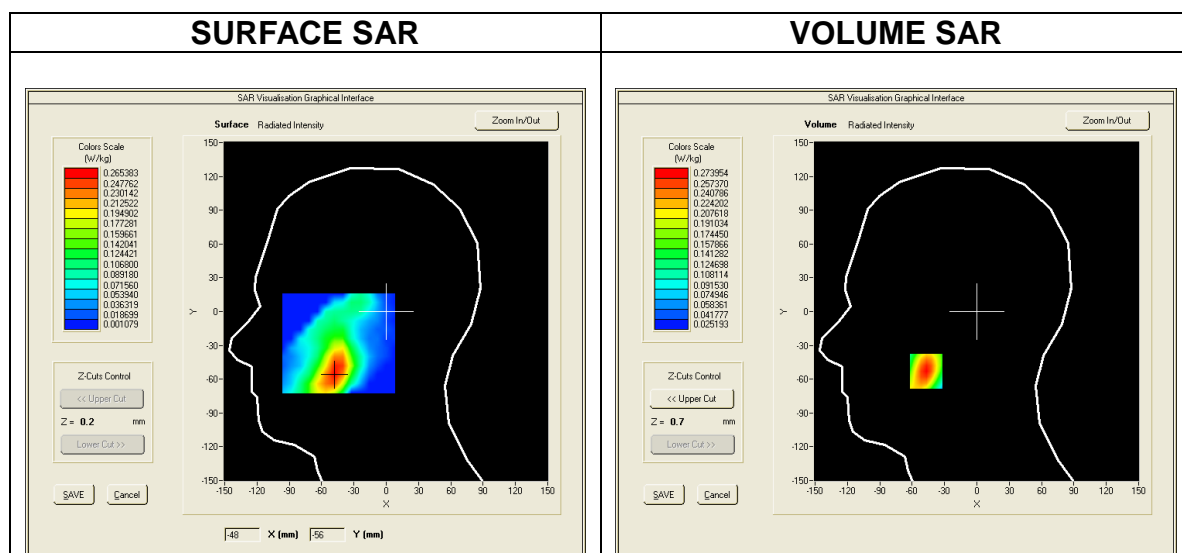

Maximum location: X=-47.00, Y=-53.00
SAR Peak: 0.40 W/kg

SAR 10g (W/Kg)	0.154855
SAR 1g (W/Kg)	0.254909

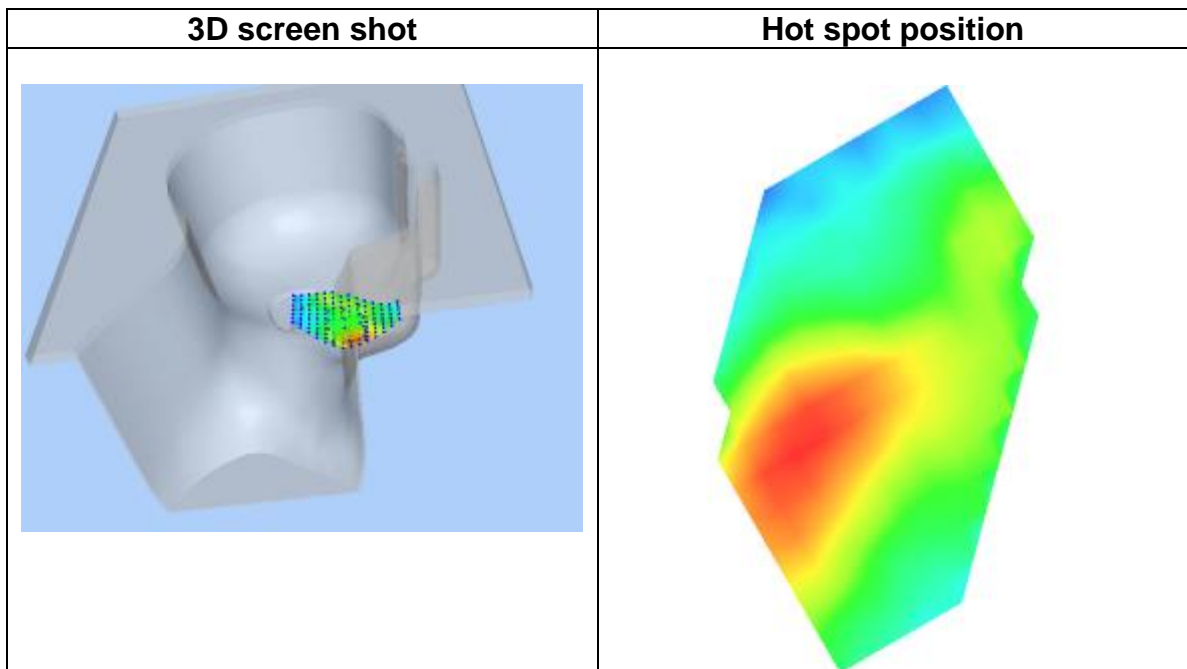
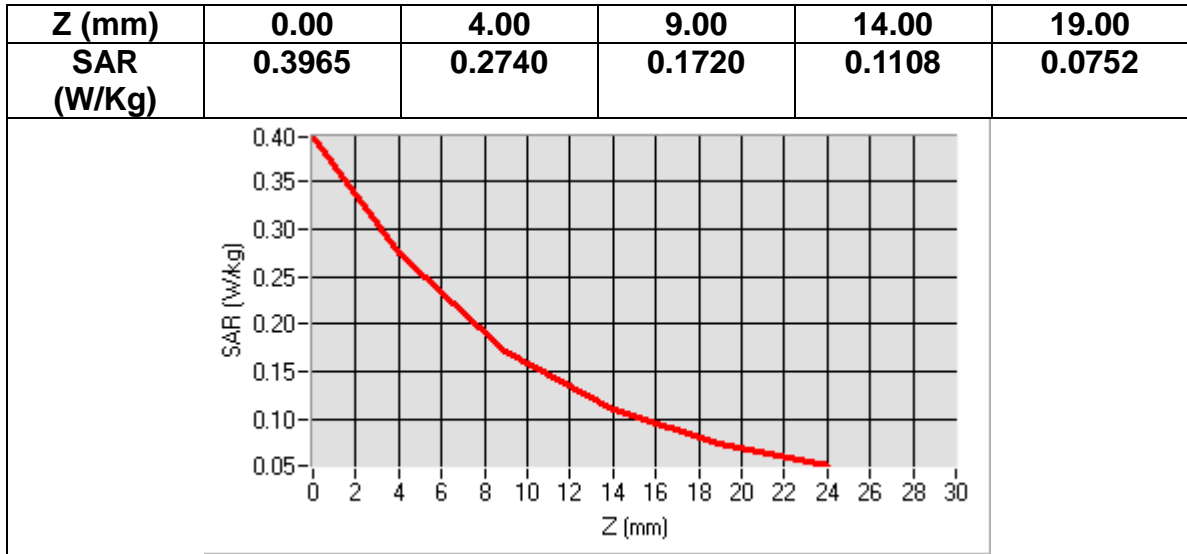

MEASUREMENT 10
Date of measurement: 2016/07/01

Area Scan	<u>sam_direct_droit2_surf8mm.txt, h= 5.00 mm</u>
Zoom Scan	<u>7x7x7,dx=5mm dy=5mm dz=5mm, sam_direct_droit2_surf8mm.txt, h= 5.00 mm</u>
Phantom	<u>Left head</u>
Device Position	<u>Tilt</u>
Band	<u>GSM1900+EDGE(1up1down)</u>
Channels	<u>Middle</u>
Signal	<u>TDMA (Crest factor: 8.0)</u>

Frequency (MHz)	1880.000000
Relative permittivity (real part)	40.000000
Relative permittivity (imaginary part)	13.408000
Conductivity (S/m)	1.400391
Variation (%)	-2.410000

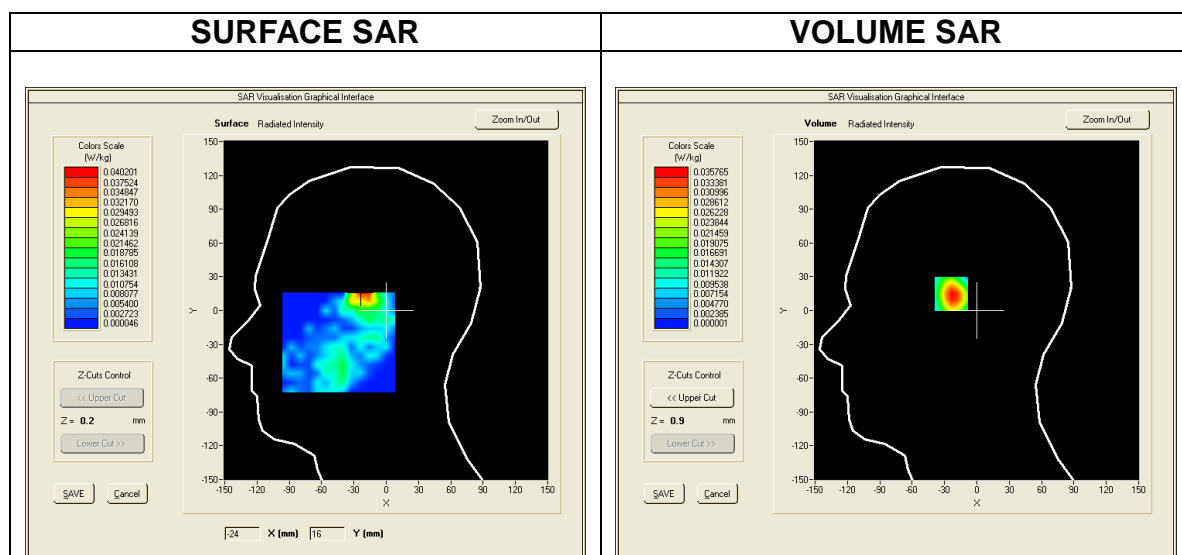

Maximum location: X=-23.00, Y=16.00
SAR Peak: 0.05/kg

SAR 10g (W/Kg)	0.018860
SAR 1g (W/Kg)	0.033320

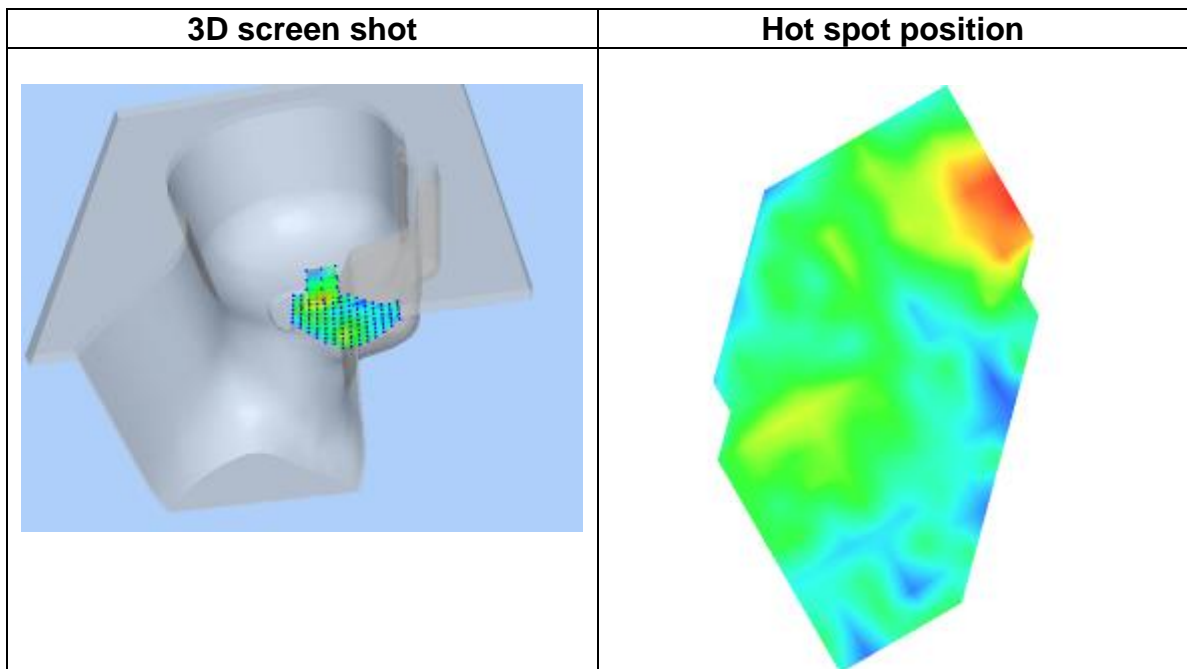
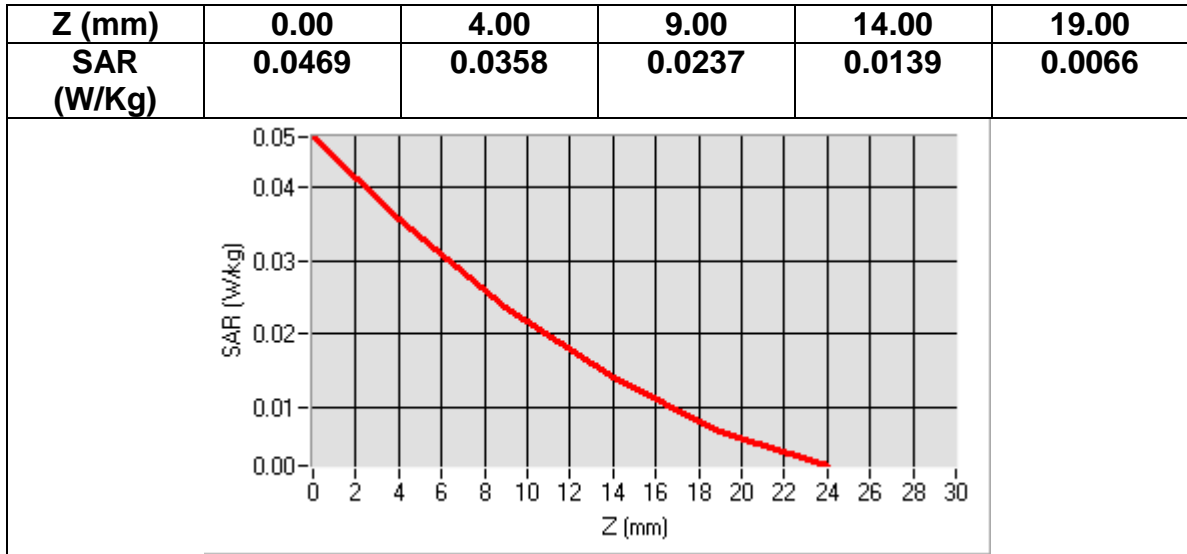

MEASUREMENT 11
 Date of measurement: 2016/07/01

Area Scan	<u>sam_direct_droit2_surf8mm.txt, h= 5.00 mm</u>
Zoom Scan	<u>7x7x7,dx=5mm dy=5mm dz=5mm, sam_direct_droit2_surf8mm.txt, h= 5.00 mm</u>
Phantom	<u>Left head</u>
Device Position	<u>Tilt</u>
Band	<u>GSM1900+GPRS(4up1down)</u>
Channels	<u>Middle</u>
Signal	<u>TDMA (Crest factor: 2.0)</u>

Frequency (MHz)	1880.000000
Relative permittivity (real part)	40.000000
Relative permittivity (imaginary part)	13.408000
Conductivity (S/m)	1.400391
Variation (%)	-3.600000

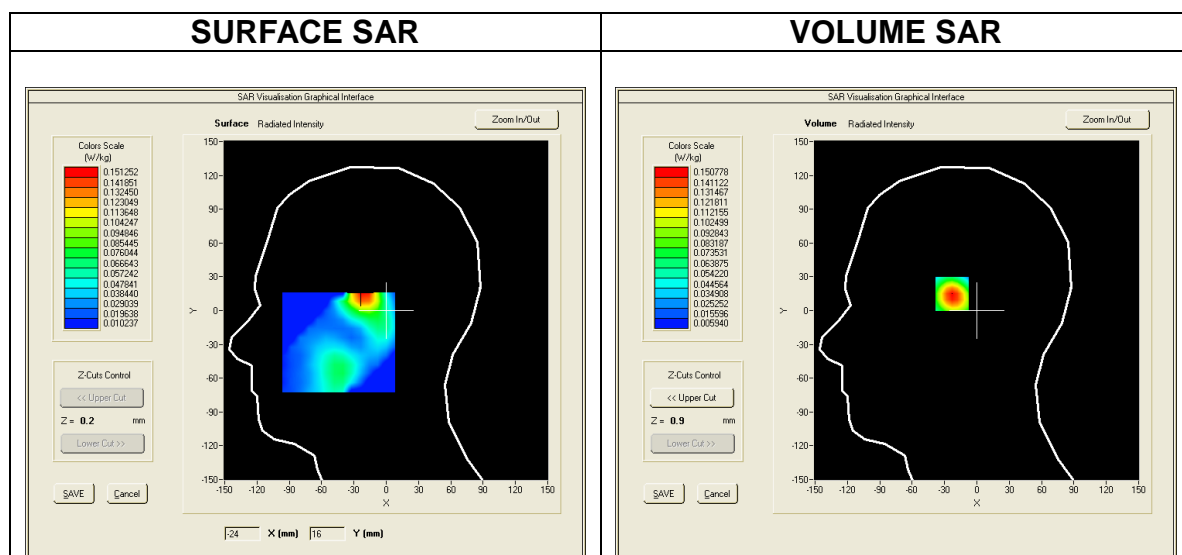

Maximum location: X=-22.00, Y=16.00
SAR Peak: 0.22 W/kg

SAR 10g (W/Kg)	0.079154
SAR 1g (W/Kg)	0.138798

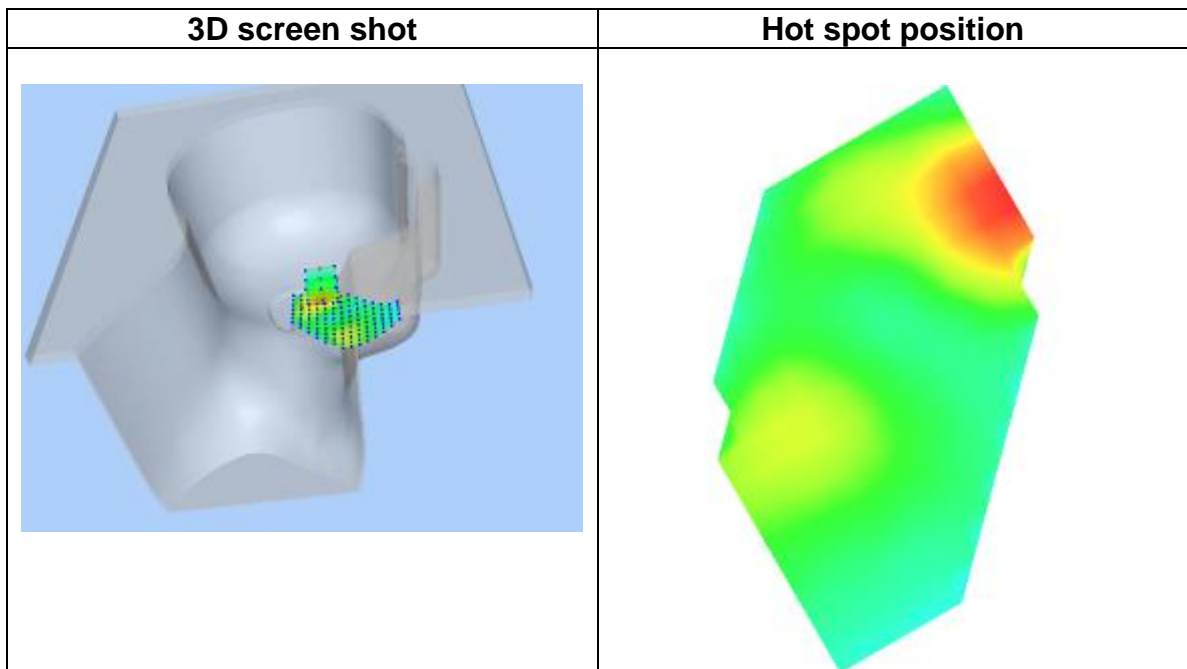
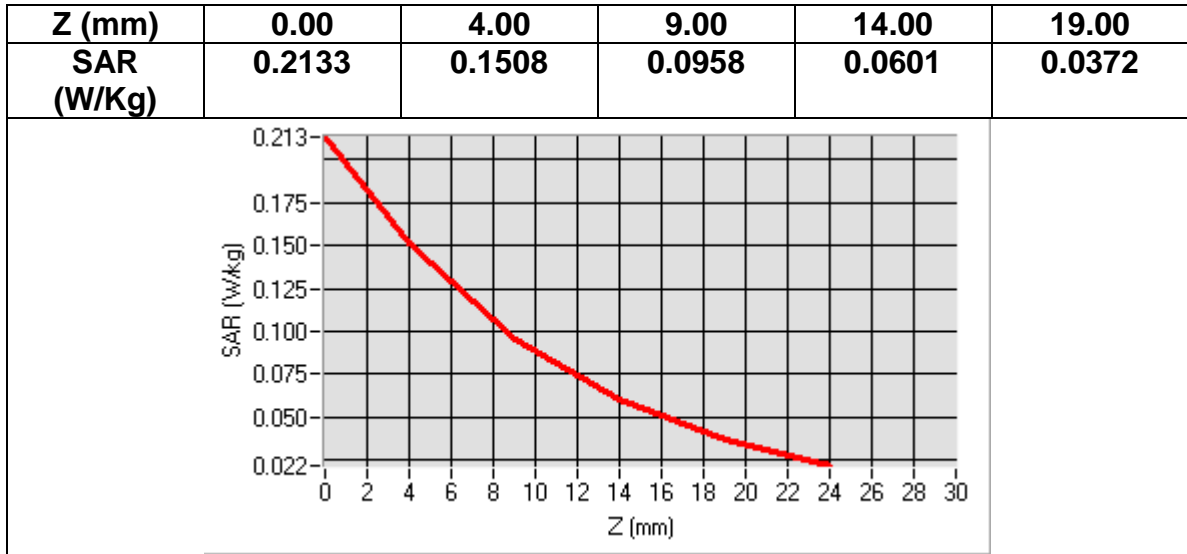

MEASUREMENT 12
Date of measurement: 2016/07/01

<u>Area Scan</u>	<u>sam_direct_droit2_surf8mm.txt, h= 5.00 mm</u>
<u>Zoom Scan</u>	<u>7x7x7,dx=5mm dy=5mm dz=5mm, sam_direct_droit2_surf8mm.txt, h= 5.00 mm</u>
<u>Phantom</u>	<u>Left head</u>
<u>Device Position</u>	<u>Tilt</u>
<u>Band</u>	<u>GSM1900+VOICE</u>
<u>Channels</u>	<u>Middle</u>
<u>Signal</u>	<u>TDMA (Crest factor: 8.0)</u>

Frequency (MHz)	1880.000000
Relative permittivity (real part)	40.000000
Relative permittivity (imaginary part)	13.408000
Conductivity (S/m)	1.400391
Variation (%)	-1.670000

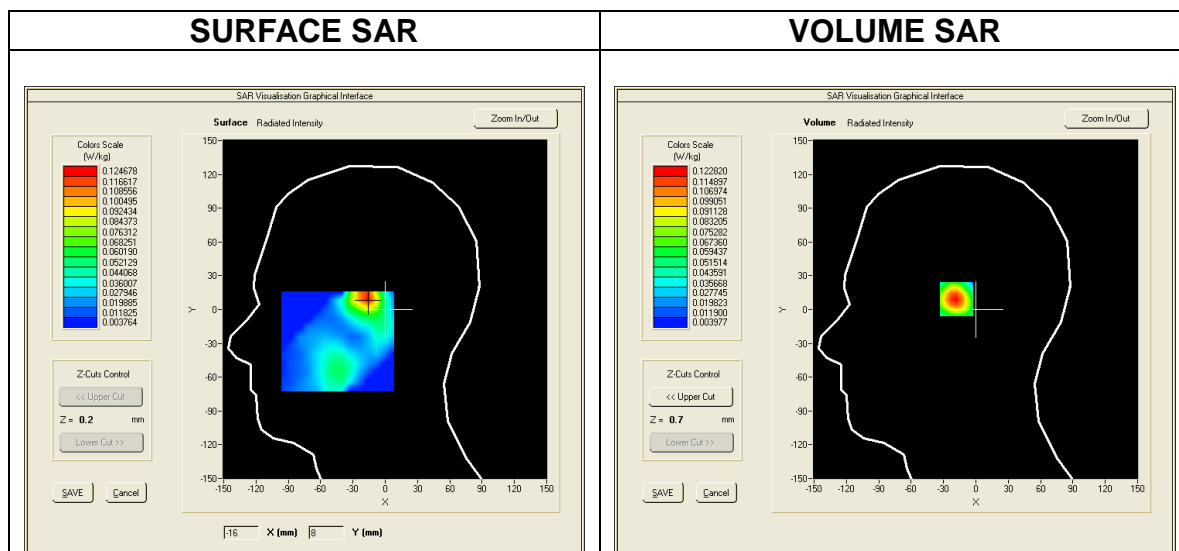

Maximum location: X=-17.00, Y=10.00
SAR Peak: 0.17 W/kg

SAR 10g (W/Kg)	0.064123
SAR 1g (W/Kg)	0.112321

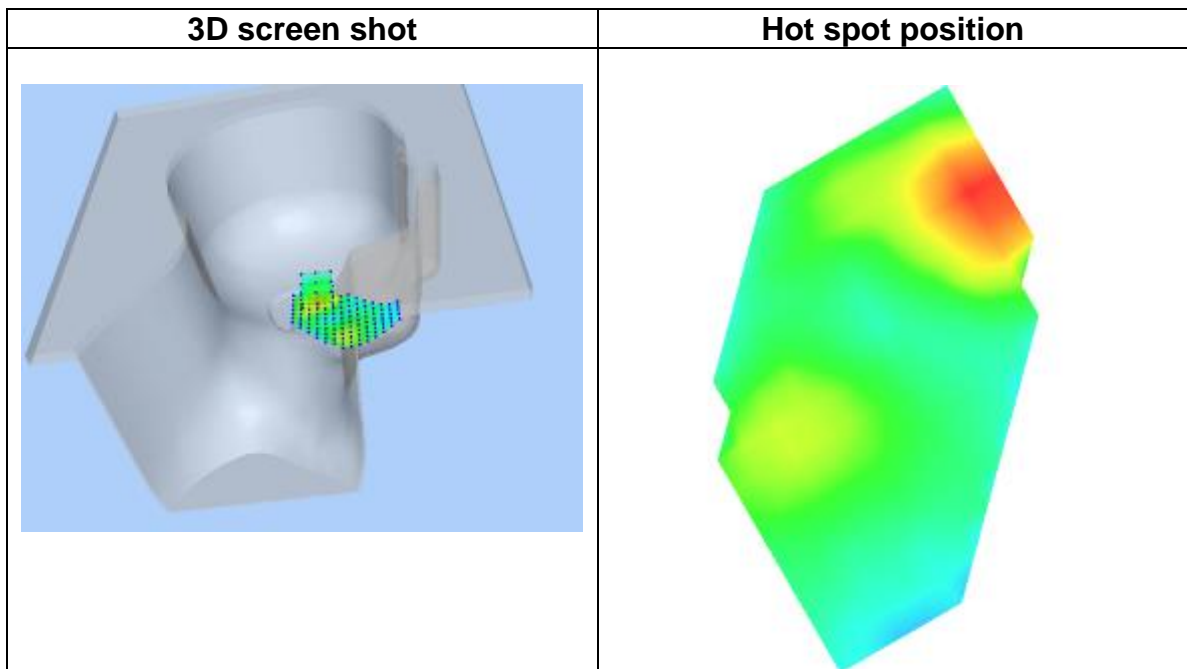
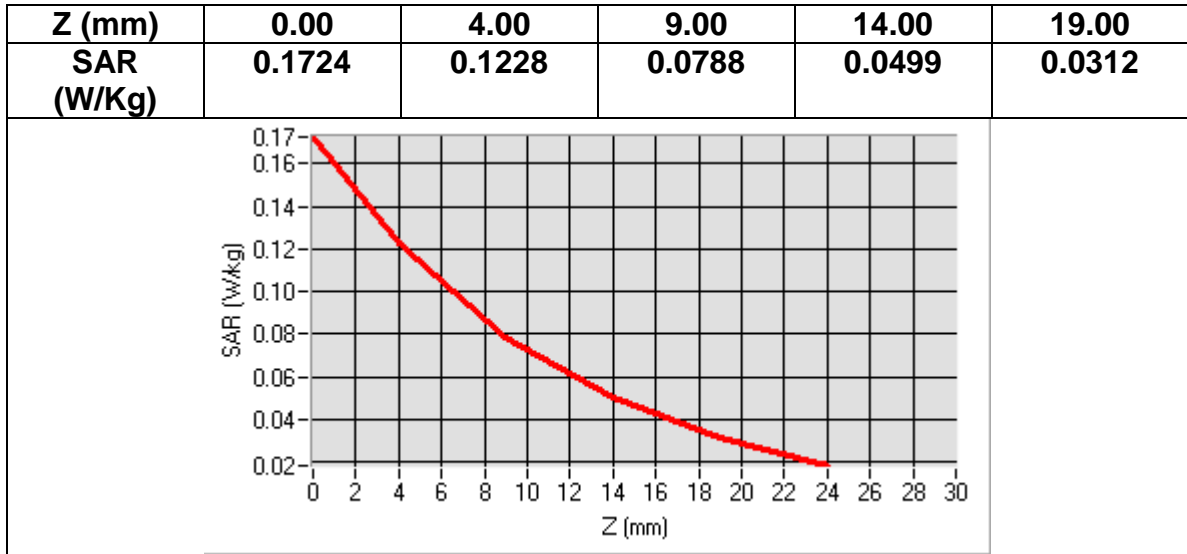

MEASUREMENT 13
Date of measurement: 2016/07/07

Area Scan	<u>dx=8mm dy=8mmh= 5.00 mm</u>
Zoom Scan	<u>7x7x7,dx=5mm dy=5mm dz=5mm, dx=8mm dy=8mm, h= 5.00 mm</u>
Phantom	<u>ELLI16</u>
Device Position	<u>BOTTOM</u>
Band	<u>GSM1900+GPRS(4up1down)</u>
Channels	<u>Middle</u>
Signal	<u>TDMA (Crest factor: 2.0)</u>

Frequency (MHz)	1880.000000
Relative permittivity (real part)	53.299999
Relative permittivity (imaginary part)	14.560000
Conductivity (S/m)	1.520711
Variation (%)	0.070000

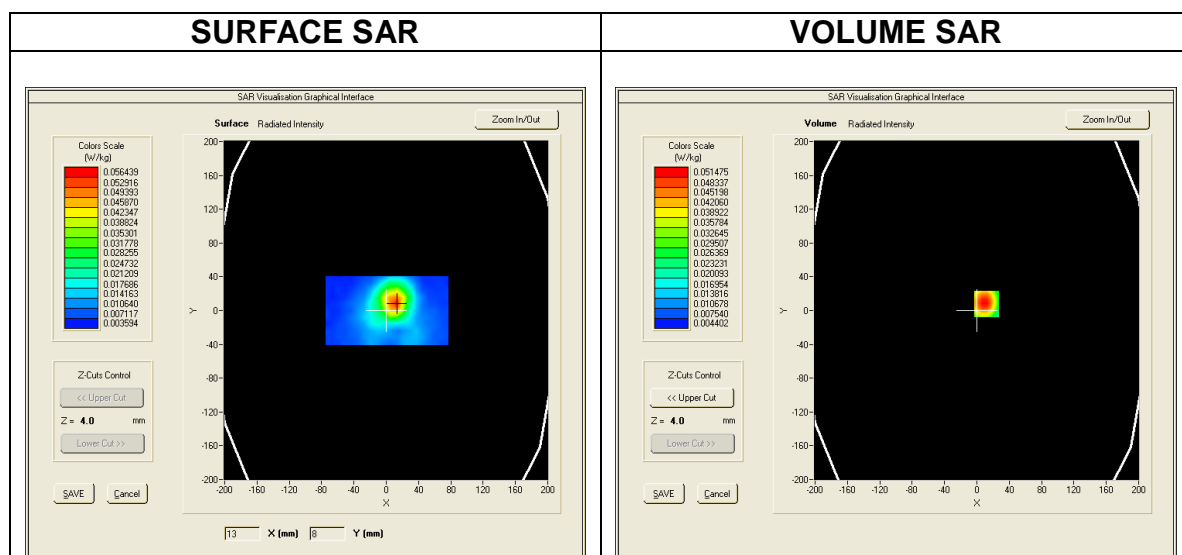

Maximum location: X=-3.00, Y=1.00
SAR Peak: 0.06 W/kg

SAR 10g (W/Kg)	0.031848
SAR 1g (W/Kg)	0.044302

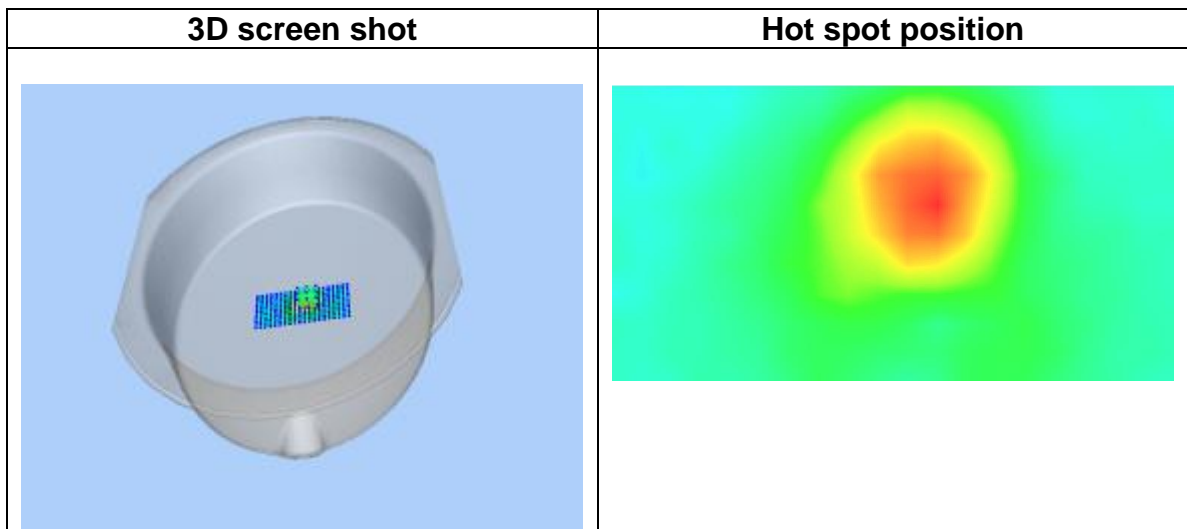
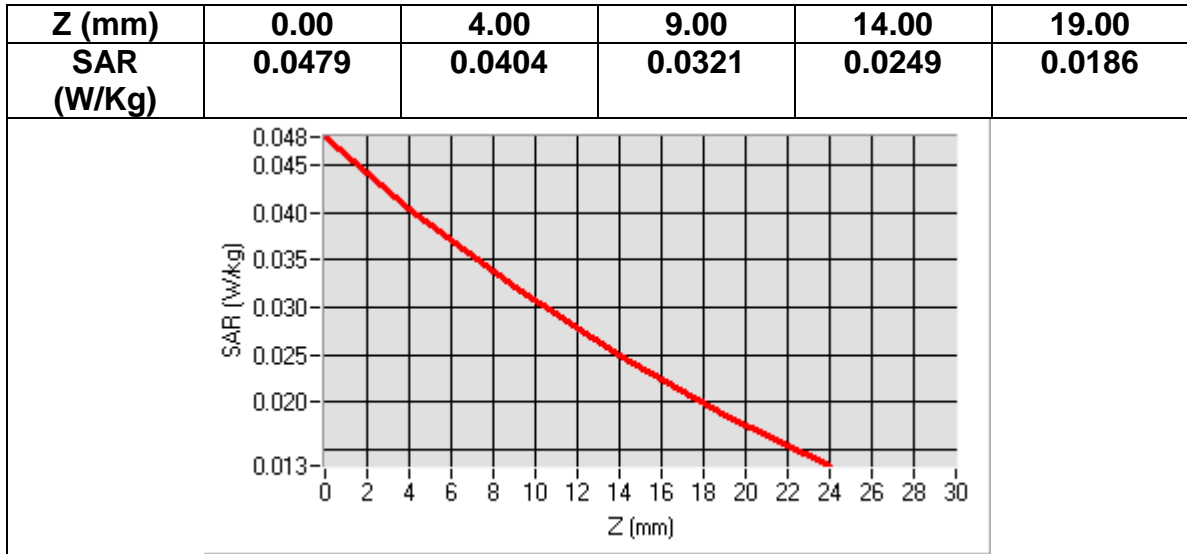

MEASUREMENT 14
Date of measurement: 2016/07/07

Area Scan	<u>dx=8mm dy=8mmh= 5.00 mm</u>
Zoom Scan	<u>7x7x7,dx=5mm dy=5mm dz=5mm, dx=8mm dy=8mm, h= 5.00 mm</u>
Phantom	<u>ELLI16</u>
Device Position	<u>Left</u>
Band	<u>GSM1900+GPRS(4up1down)</u>
Channels	<u>Middle</u>
Signal	<u>TDMA (Crest factor: 2.0)</u>

Frequency (MHz)	1880.000000
Relative permittivity (real part)	53.299999
Relative permittivity (imaginary part)	14.560000
Conductivity (S/m)	1.520711
Variation (%)	-4.690000

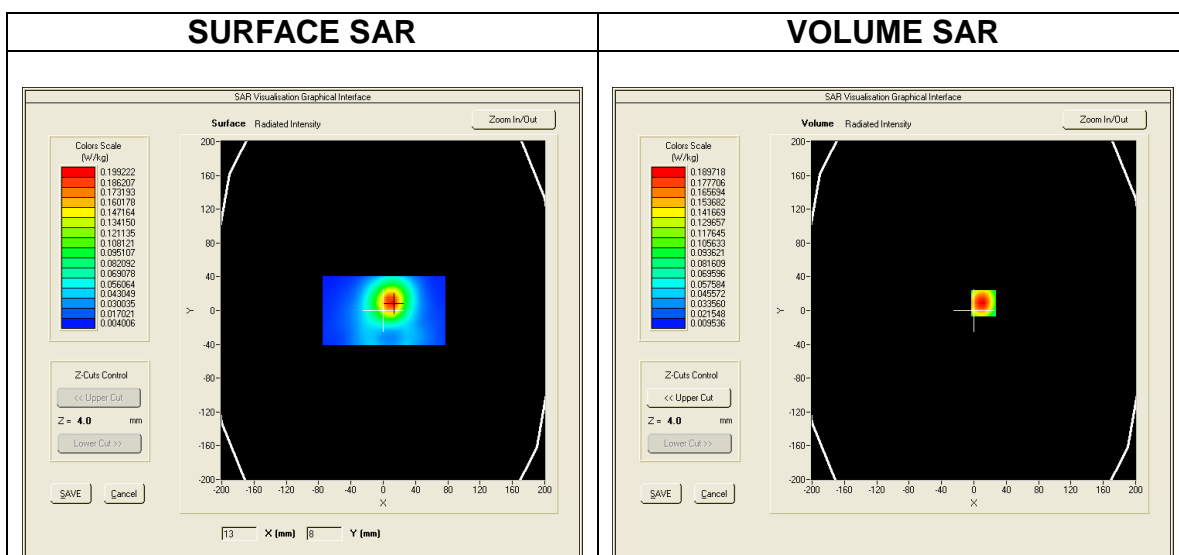

Maximum location: X=3.00, Y=-16.00
SAR Peak: 0.38 W/kg

SAR 10g (W/Kg)	0.147049
SAR 1g (W/Kg)	0.240607

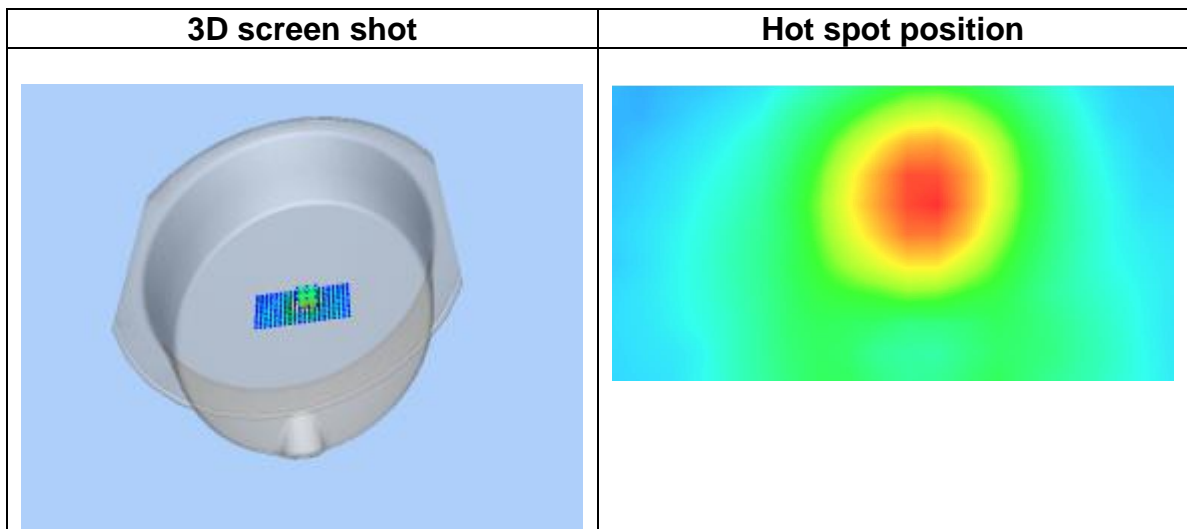
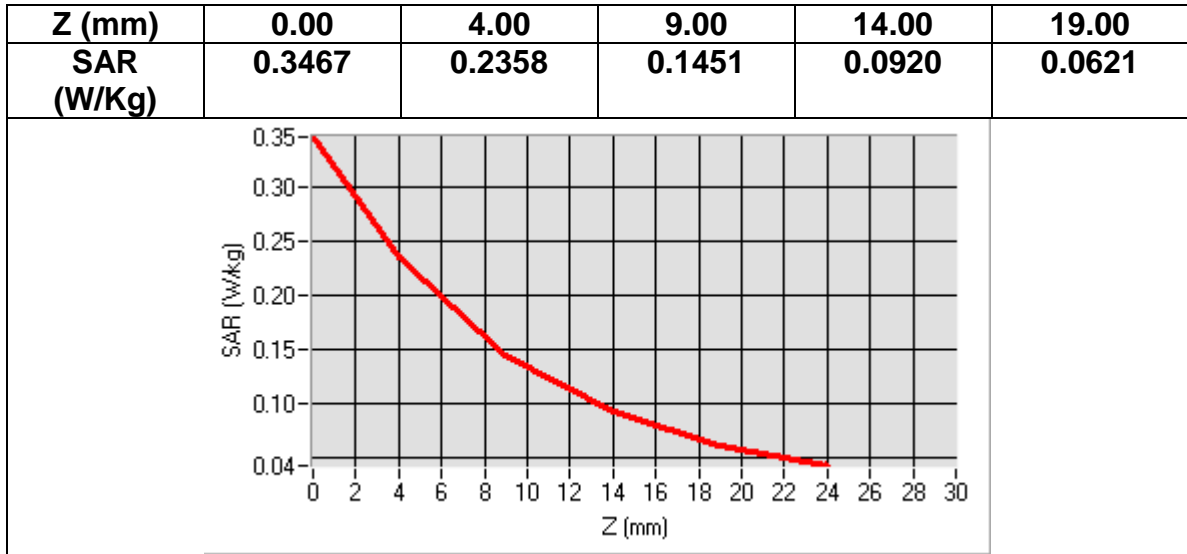

MEASUREMENT 15
Date of measurement: 2016/07/07

Area Scan	<u>dx=8mm dy=8mmh= 5.00 mm</u>
Zoom Scan	<u>7x7x7,dx=5mm dy=5mm dz=5mm, dx=8mm dy=8mm, h= 5.00 mm</u>
Phantom	<u>ELLI16</u>
Device Position	<u>Right</u>
Band	<u>GSM1900+GPRS(4up1down)</u>
Channels	<u>Middle</u>
Signal	<u>TDMA (Crest factor: 2.0)</u>

Frequency (MHz)	1880.000000
Relative permittivity (real part)	53.299999
Relative permittivity (imaginary part)	14.560000
Conductivity (S/m)	1.520711
Variation (%)	-3.530000

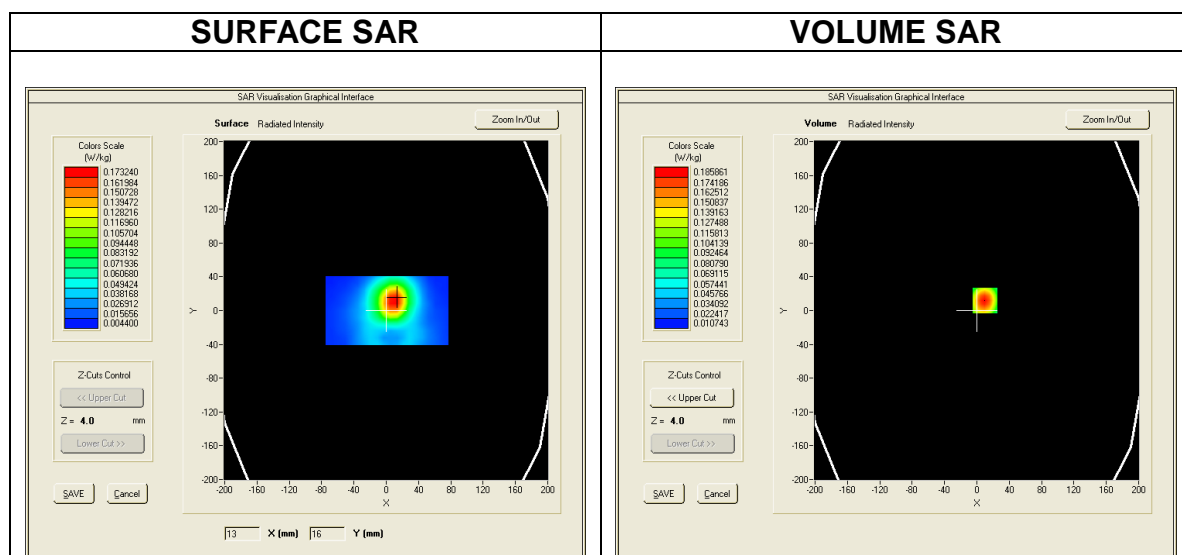

Maximum location: X=2.00, Y=12.00
SAR Peak: 0.22 W/kg

SAR 10g (W/Kg)	0.091843
SAR 1g (W/Kg)	0.146106

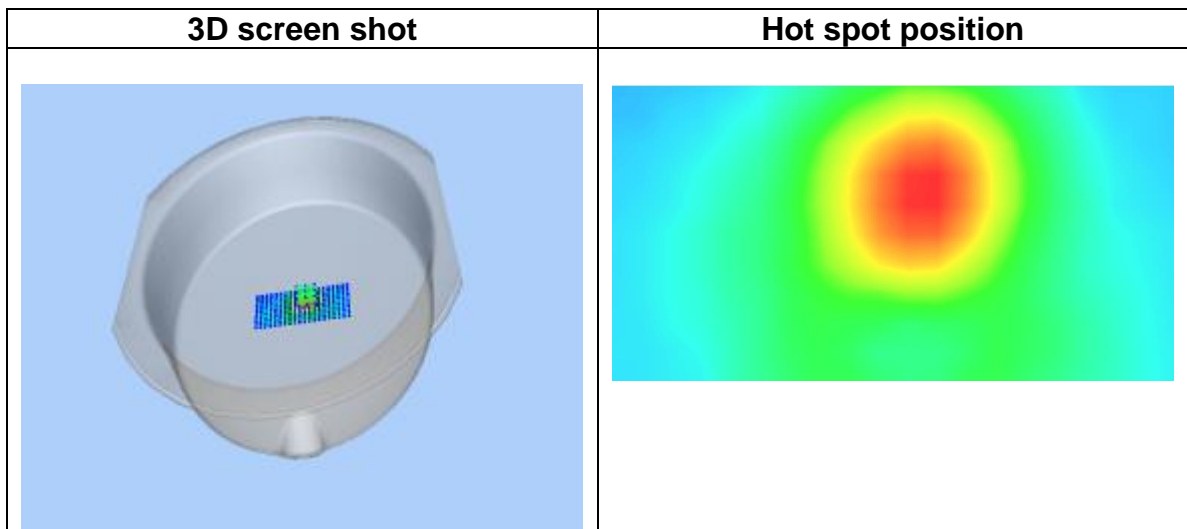
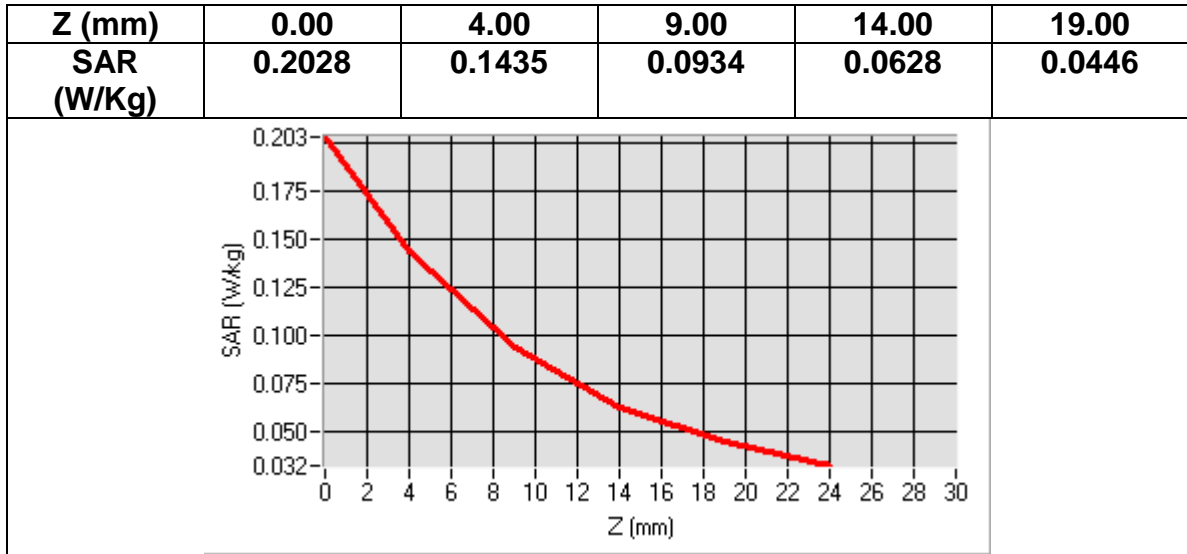

MEASUREMENT 16
 Date of measurement: 2016/07/07

Area Scan	<u>dx=8mm dy=8mmh= 5.00 mm</u>
Zoom Scan	<u>7x7x7,dx=5mm dy=5mm dz=5mm, dx=8mm dy=8mm, h= 5.00 mm</u>
Phantom	<u>ELLI16</u>
Device Position	<u>Bottom</u>
Band	<u>GSM1900+EDGE(1up1down)</u>
Channels	<u>Middle</u>
Signal	<u>TDMA (Crest factor: 8.0)</u>

Frequency (MHz)	1880.000000
Relative permittivity (real part)	53.299999
Relative permittivity (imaginary part)	14.560000
Conductivity (S/m)	1.520711
Variation (%)	4.530000

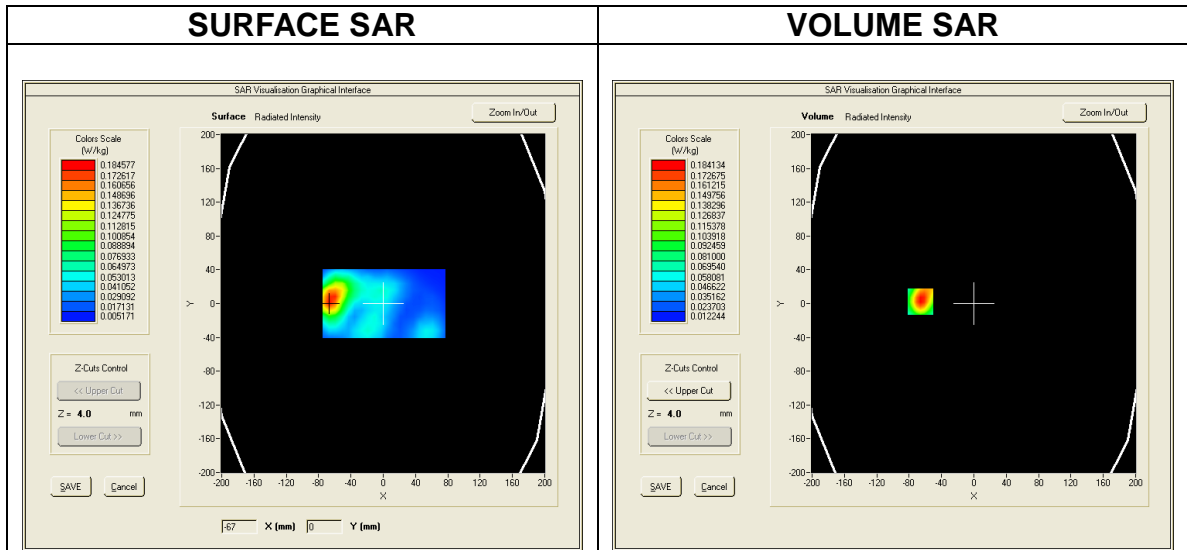

Maximum location: X=-5.00, Y=14.00
SAR Peak: 0.06 W/kg

SAR 10g (W/Kg)	0.030019
SAR 1g (W/Kg)	0.040779

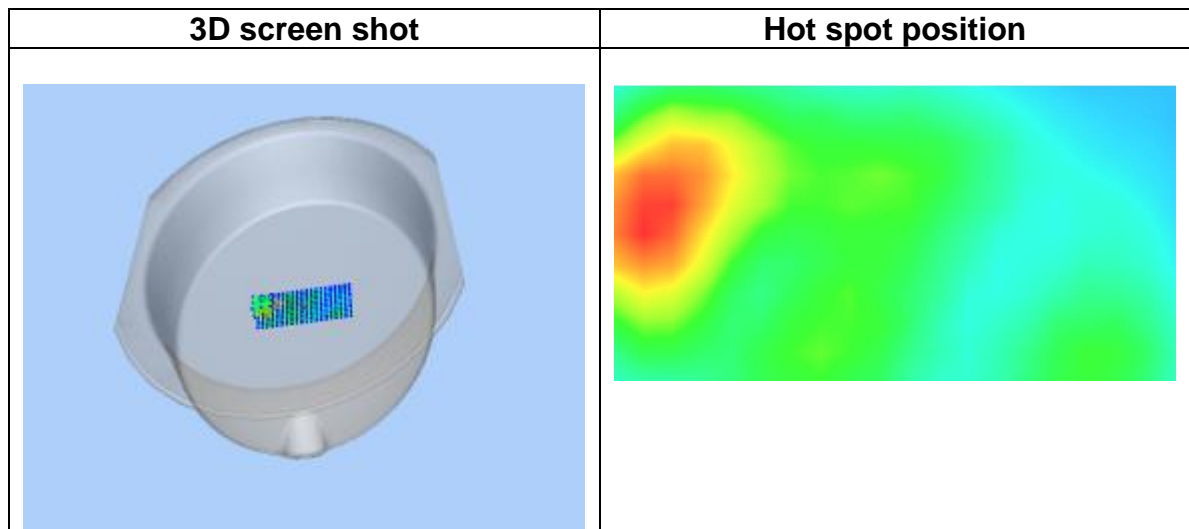
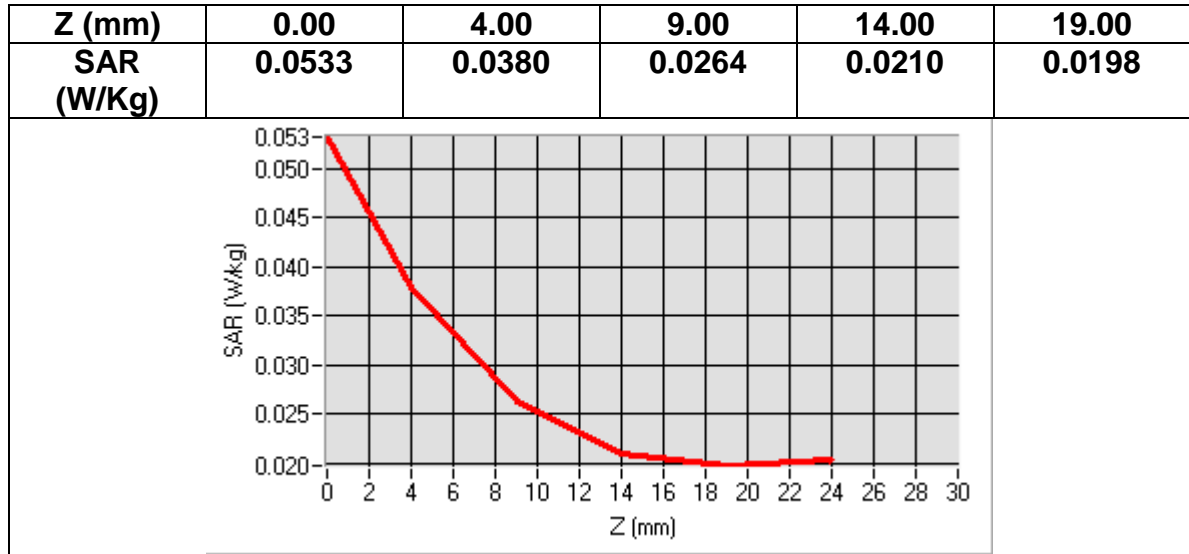

MEASUREMENT 17
Date of measurement: 2016/07/07

Area Scan	<u>dx=8mm dy=8mmh= 5.00 mm</u>
Zoom Scan	<u>7x7x7,dx=5mm dy=5mm dz=5mm, dx=8mm dy=8mm, h= 5.00 mm</u>
Phantom	<u>ELLI16</u>
Device Position	<u>Left</u>
Band	<u>GSM1900+EDGE(1up1down)</u>
Channels	<u>Middle</u>
Signal	<u>TDMA (Crest factor: 8.0)</u>

Frequency (MHz)	1880.000000
Relative permittivity (real part)	53.299999
Relative permittivity (imaginary part)	14.560000
Conductivity (S/m)	1.520711
Variation (%)	2.350000

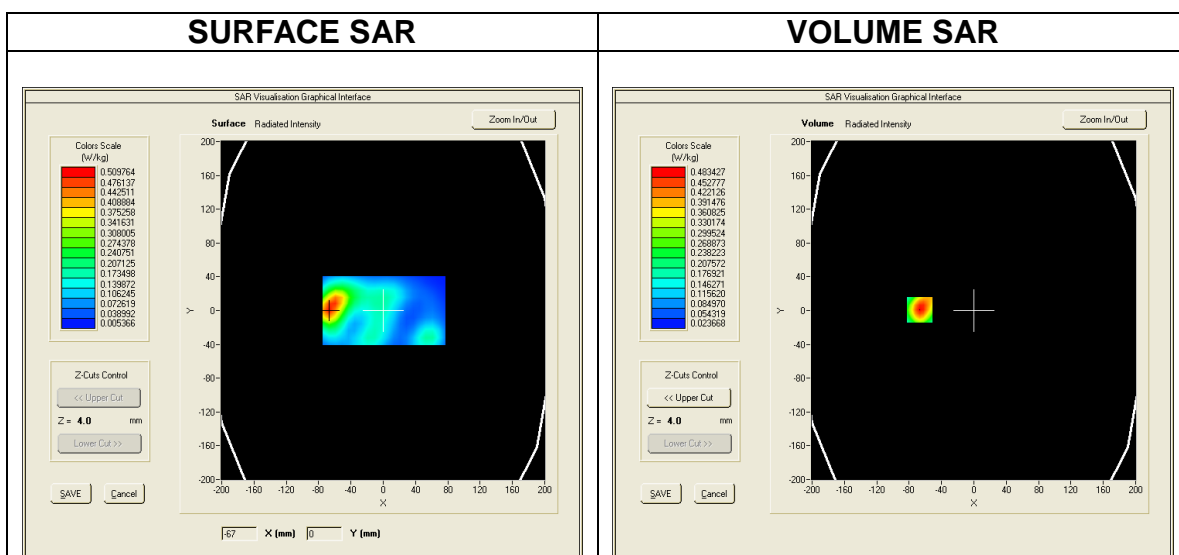

Maximum location: X=-1.00, Y=-15.00
SAR Peak: 0.11 W/kg

SAR 10g (W/Kg)	0.051616
SAR 1g (W/Kg)	0.075487

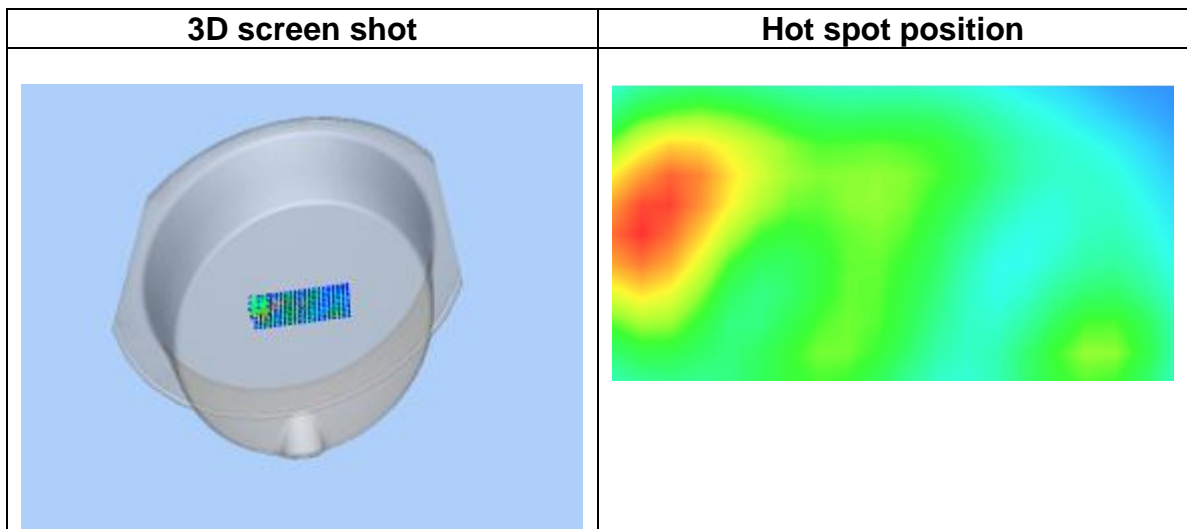
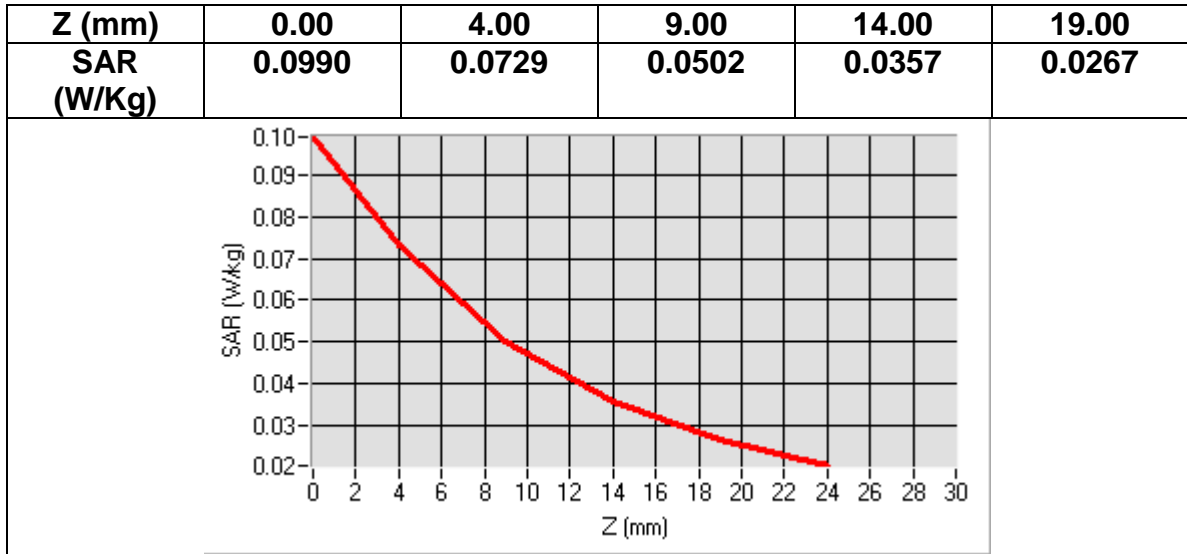

MEASUREMENT 18
 Date of measurement: 2016/07/07

Area Scan	<u>dx=8mm dy=8mmh= 5.00 mm</u>
Zoom Scan	<u>7x7x7,dx=5mm dy=5mm dz=5mm, dx=8mm dy=8mm, h= 5.00 mm</u>
Phantom	<u>ELLI16</u>
Device Position	<u>Right</u>
Band	<u>GSM1900+EDGE(1up1down)</u>
Channels	<u>Middle</u>
Signal	<u>TDMA (Crest factor: 8.0)</u>

Frequency (MHz)	1880.000000
Relative permittivity (real part)	53.299999
Relative permittivity (imaginary part)	14.560000
Conductivity (S/m)	1.520711
Variation (%)	3.260000

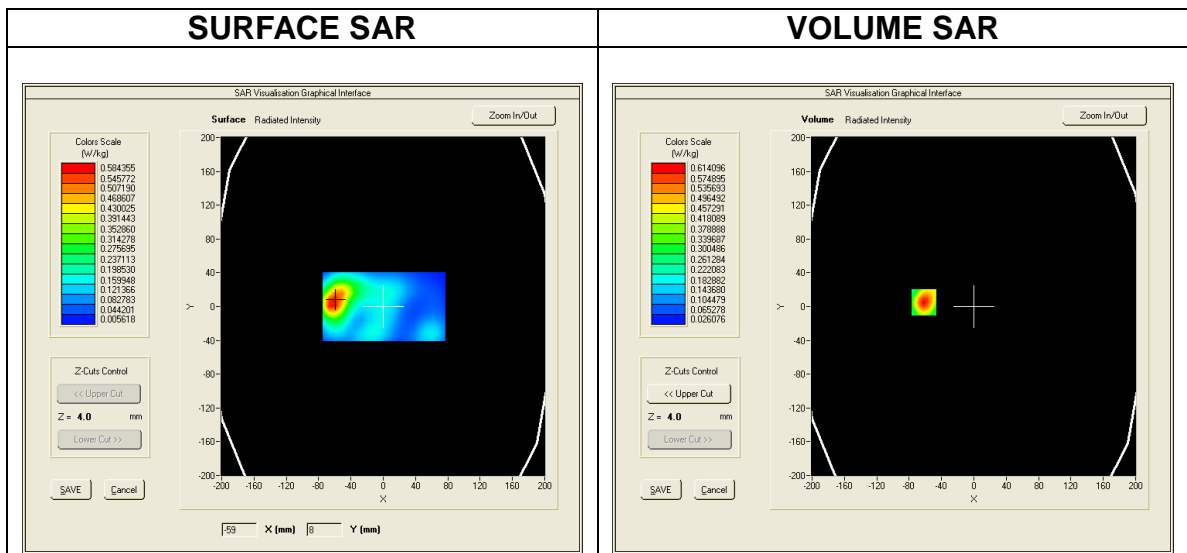

Maximum location: X=3.00, Y=16.00
SAR Peak: 0.09 W/kg

SAR 10g (W/Kg)	0.039843
SAR 1g (W/Kg)	0.058955

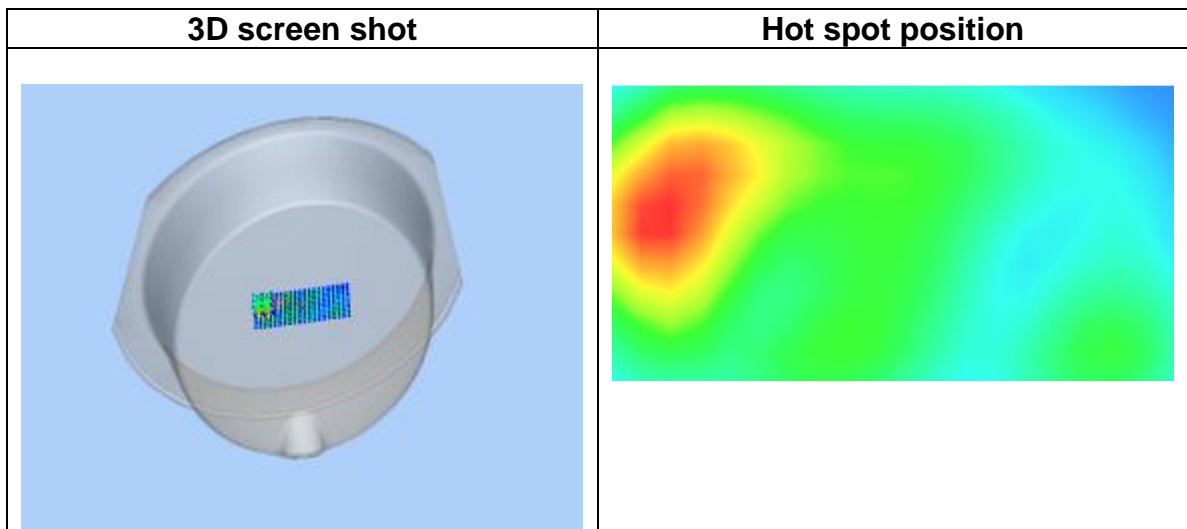
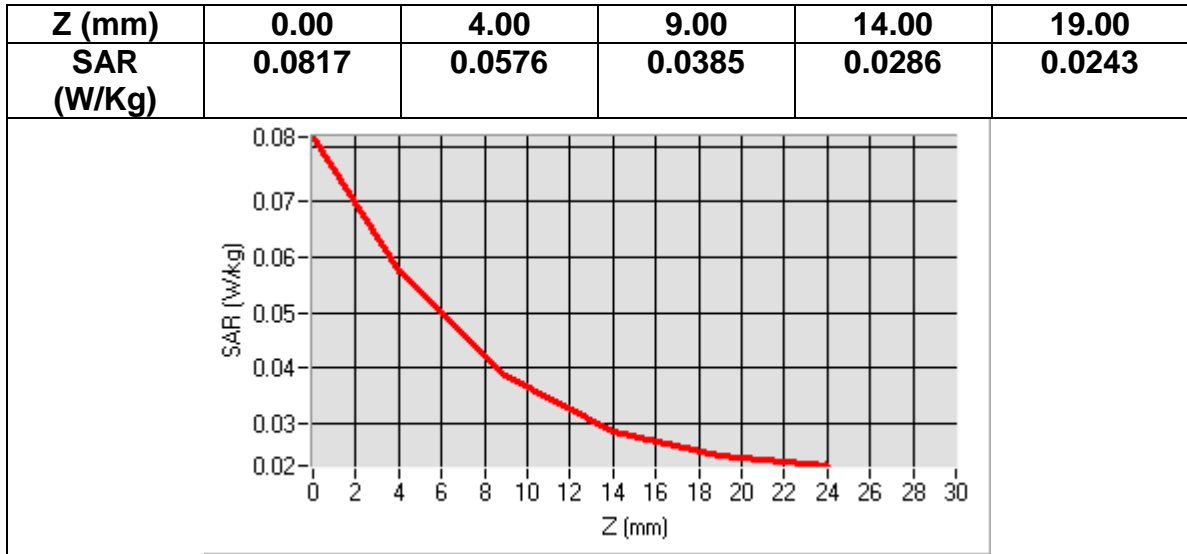

MEASUREMENT 19
Date of measurement: 2016/07/07

Area Scan	<u>dx=8mm dy=8mmh= 5.00 mm</u>
Zoom Scan	<u>7x7x7,dx=5mm dy=5mm dz=5mm, dx=8mm dy=8mm, h= 5.00 mm</u>
Phantom	<u>ELL16</u>
Device Position	<u>Front</u>
Band	<u>GSM1900+GPRS(4up1down)</u>
Channels	<u>Middle</u>
Signal	<u>TDMA (Crest factor: 2.0)</u>

Frequency (MHz)	1880.000000
Relative permittivity (real part)	51.181801
Relative permittivity (imaginary part)	14.969100
Conductivity (S/m)	1.563439
Variation (%)	-1.510000

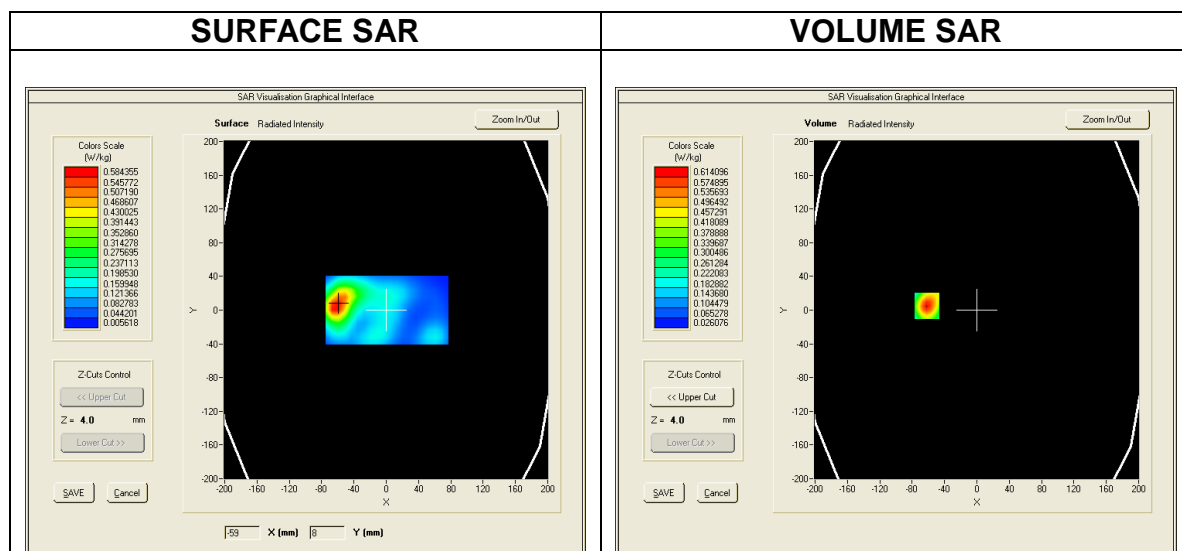

Maximum location: X=-58.00, Y=7.00
SAR Peak: 2.05 W/kg

SAR 10g (W/Kg)	0.610041
SAR 1g (W/Kg)	1.158622

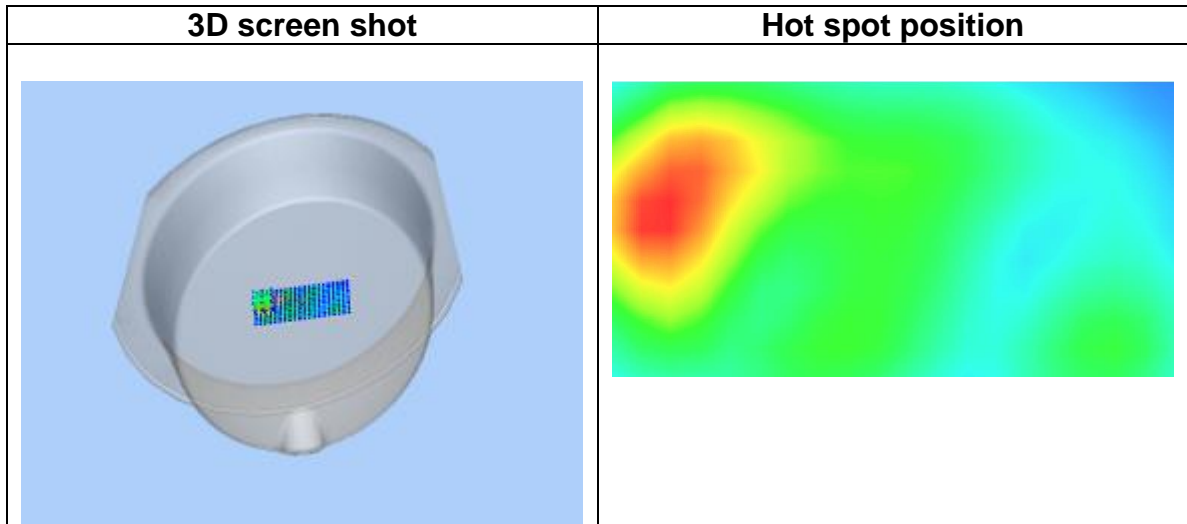
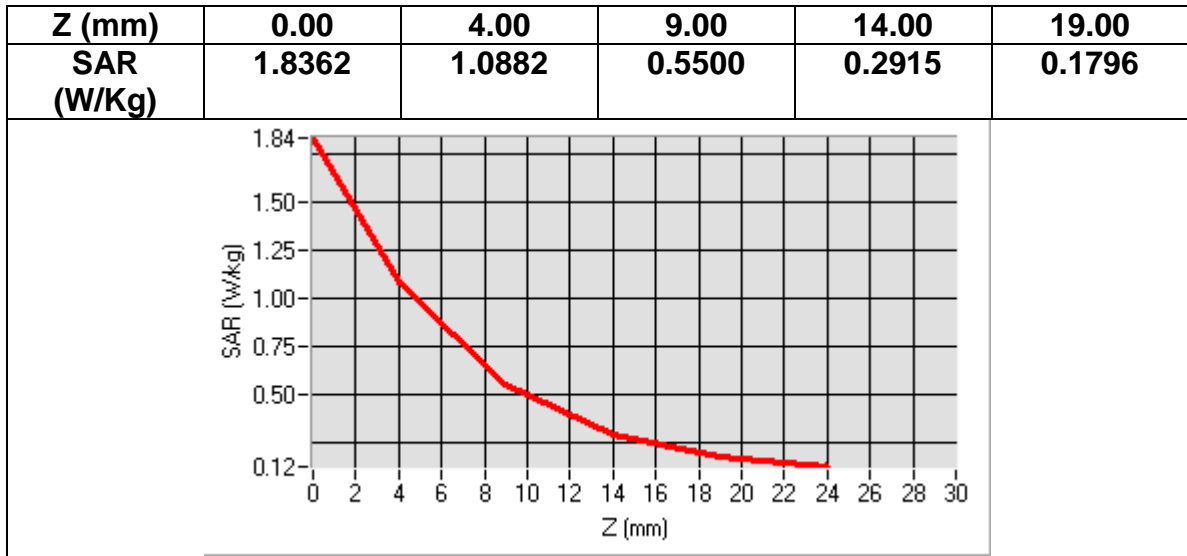

MEASUREMENT 20
 Date of measurement: 2016/07/07

Area Scan	<u>dx=8mm dy=8mmh= 5.00 mm</u>
Zoom Scan	<u>7x7x7,dx=5mm dy=5mm dz=5mm, dx=8mm dy=8mm, h= 5.00 mm</u>
Phantom	<u>ELL16</u>
Device Position	<u>Front</u>
Band	<u>GSM1900+EDGE(1up1down)</u>
Channels	<u>Middle</u>
Signal	<u>TDMA (Crest factor: 8.0)</u>

Frequency (MHz)	1880.000000
Relative permittivity (real part)	51.181801
Relative permittivity (imaginary part)	14.969100
Conductivity (S/m)	1.563439
Variation (%)	2.960000

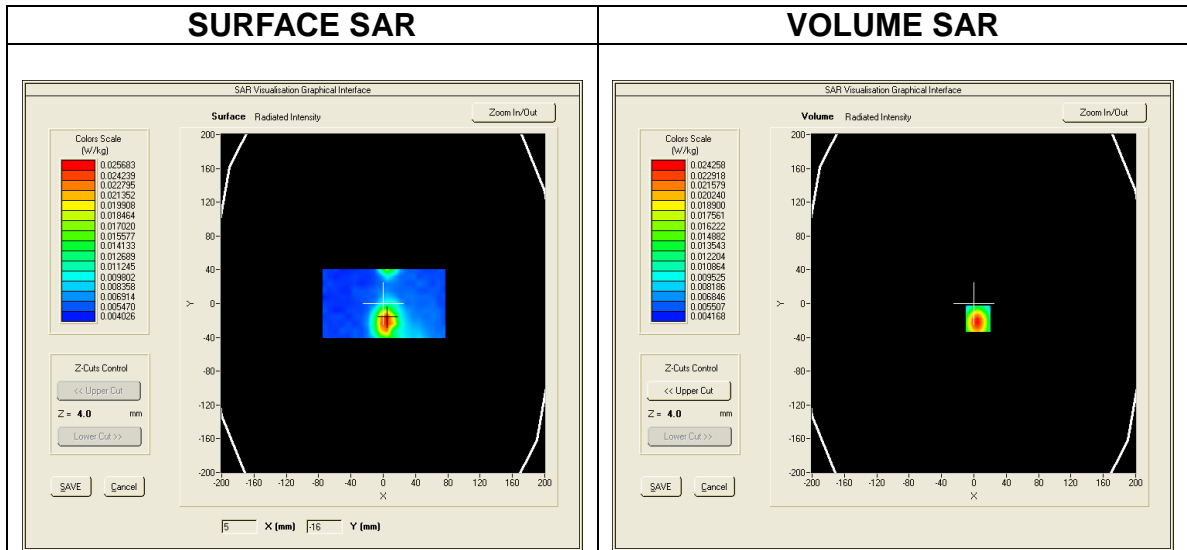

Maximum location: X=-58.00, Y=2.00
SAR Peak: 0.40 W/kg

SAR 10g (W/Kg)	0.155860
SAR 1g (W/Kg)	0.257741