

**FCC PART 15E TEST REPORT FOR CERTIFICATION
On Behalf of**

Winstars Technology Limited

WiFi 6E Tri-Band AX5400 PCI-E Adapter

Model Number: WS-WN675X3

**Addition Model: WL-WN675X3, WS-WN675X3M, WL-WN675X3M,
PAX2235-WIFI-6E-CARD**

FCC ID: NZ3-WN0006

Applicant :	Winstars Technology Limited
Address:	1-5F, NO.5, Taisong Industrial Zone, Dalang Calang Community, Dalang Street, Longhua District, Shenzhen, China
Prepared By:	EST Technology Co., Ltd.
	Chilingxiang, Qishantou, Santun, Houjie, Dongguan, Guangdong, China
	Tel: 86-769-83081888-808



Report Number:	ESTE-R2312166
Date of Test:	Oct. 08 ~ Dec. 22, 2023
Date of Report:	Dec. 25, 2023

TABLE OF CONTENTS

Description	Page
TEST REPORT VERIFICATION.....	3
1. GENERAL INFORMATION.....	5
1.1. Description of Device (EUT).....	5
1.2. The antenna information for EUT.....	6
1.3. Information of RF Cable.....	6
2. SUMMARY OF TEST.....	7
2.1. Summary of test result.....	7
2.2. Test Facilities.....	8
2.3. Measurement uncertainty for EST Technology Co., Ltd.....	9
2.4. Assistant equipment used for test.....	9
2.5. Block Diagram.....	9
2.6. Test Mode.....	10
2.7. Channel List.....	13
2.8. Power Setting of Test Software.....	14
2.9. Duty Cycle of Test Signal.....	14
2.10. Test Equipment List.....	15
3. 6DB BANDWIDTH & 26DB BANDWIDTH & 99% OCCUPIED BANDWIDTH.....	17
3.1. Limit.....	17
3.2. Test Setup.....	17
3.3. Spectrum Analyzer Setting.....	17
3.4. Test Procedure.....	18
3.5. Test Result.....	18
4. MAXIMUM CONDUCTED OUTPUT POWER.....	19
4.1. Limit.....	19
4.2. Test Setup.....	19
4.3. Spectrum Analyzer Setting.....	19
4.4. Test Procedure.....	19
4.5. Test Result.....	20
5. PEAK POWER SPECTRAL DENSITY.....	20
5.1. Limit.....	20
5.2. Test Setup.....	20
5.3. Spectrum Analyzer Setting.....	20
5.4. Test Procedure.....	20
5.5. Test Result.....	21
6. UNWANTED EMISSIONS AND BAND EDGE.....	21
6.1. Limit.....	21
6.2. Test Setup.....	22
6.3. Spectrum Analyzer Setting.....	23
6.4. Test Procedure.....	24
6.5. Test Result.....	25
7. FREQUENCY STABILITY.....	44
7.1. Limit.....	44
7.2. Test Setup.....	44

- 7.3. Spectrum Analyzer Setting 44
- 7.4. Test Procedure 45
- 7.5. Test Result 45
- 8. AC POWER LINE CONDUCTED EMISSIONS 46
 - 8.1. Limit 46
 - 8.2. Test Setup 46
 - 8.3. Spectrum Analyzer Setting 46
 - 8.4. Test Procedure 46
 - 8.5. Test Result 47
- 9. ANTENNA REQUIREMENTS 49
 - 9.1. Limit 49
 - 9.2. Test Result 49
- 10. APPENDIX 50
- 11. TEST SETUP PHOTO 228
- 12. EUT PHOTO 230

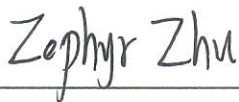
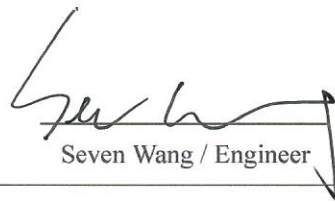
EST Technology Co., Ltd.

Applicant:	Winstars Technology Limited		
Address:	1-5F, NO.5, Taisong Industrial Zone, Dalang Community, Dalang Street, Longhua District, Shenzhen, China		
Manufacturer:	Winstars Technology Limited		
Address:	1-5F, NO.5, Taisong Industrial Zone, Dalang Community, Dalang Street, Longhua District, Shenzhen, China		
Factory:	Winstars Technology Limited		
Address:	1-5F, NO.5, Taisong Industrial Zone, Dalang Community, Dalang Street, Longhua District, Shenzhen, China		
E.U.T:	WiFi 6E Tri-Band AX5400 PCI-E Adapter		
Model Number:	WS-WN675X3		
Addition Model:	WL-WN675X3, WS-WN675X3M, WL-WN675X3M, PAX2235-WIFI-6E-CARD		
Power Supply:	DC 5V		
Trade Name:	-----	Serial No.:	-----
Date of Receipt:	Oct. 08, 2023	Date of Test:	Oct. 08 ~ Dec. 22, 2023
Test Specification:	FCC Part 15 Subpart E 15.407 ANSI C63.10:2013 FCC KDB 789033 D02 General UNII Test Procedures New Rules v02r01 FCC KDB 662911 D01 Multiple Transmitter Output v02r01		
Test Result:	The device described above is tested by EST Technology Co., Ltd. The measurement results were contained in this test report and EST Technology Co., Ltd. was assumed full responsibility for the accuracy and completeness of these measurements. Also, this report shows that the EUT to be technically compliance with the FCC Rules and Regulations Part 15 Subpart E requirements. This report applies to above tested sample only and shall not be reproduced in part without written approval of EST Technology Co., Ltd. <p style="text-align: right;">Date: Dec. 25, 2023</p>		
Prepared by:	Reviewed by:	Approved by:	
 _____ Zephyr Zhu / Assistant	 _____ Seven Wang / Engineer	 _____ Iceman Hu / Manager	
Other Aspects:	None.		
Abbreviations: OK/P=passed fail/F=failed n.a/N=not applicable E.U.T=equipment under tested			
This test report is based on a single evaluation of one sample of above mentioned products ,It is not permitted to be duplicated in extracts without written approval of EST Technology Co., Ltd.			

1.2. The antenna information for EUT

Ant No.	Brand	Model Name	Antenna Type	Connector	Gain (dBi)
1	-	-	External	-	-0.56
2	-	-	External	-	-0.56
Directional	-	-	External	-	2.45

Remark:

- (1) After pre-test all antenna configurations, the worst case configuration as list below.
- (2) The antenna gain is declared by the customer and the laboratory is not responsible for the accuracy of the antenna gain.
- (3) The test results of this report only apply to the sample as received.

ANT No. TX Mode	SISO Configuration	MIMO Configuration
IEEE 802.11a	ANT 1	/
IEEE 802.11n HT20	/	ANT1+ANT2
IEEE 802.11n HT40	/	ANT1+ANT2
IEEE 802.11ac VHT20	/	ANT1+ANT2
IEEE 802.11ac VHT40	/	ANT1+ANT2
IEEE 802.11ac VHT80	/	ANT1+ANT2
IEEE 802.11ax HE20	/	ANT1+ANT2
IEEE 802.11ax HE40	/	ANT1+ANT2
IEEE 802.11ax HE80	/	ANT1+ANT2

1.3. Information of RF Cable

Cable Loss(dB)	Provided by
1.0	Winstars Technology Limited
Note: 1.The customer declared the loss value of the RF Cable. and the test results of this report only apply to the sample as received. 2.The laboratory is not responsible for the accuracy of the cable loss.	

2. SUMMARY OF TEST

2.1. Summary of test result

No.	Description of Test Item	FCC Standard Section	Results
1	6dB Bandwidth & 26dB Bandwidth & 99% Occupied Bandwidth	15.407(a) 15.407(e)	PASS
2	Maximum Conducted Output Power	15.407(a)	PASS
3	Peak Power Spectral Density	15.407(a)	PASS
4	Unwanted Emissions and Band Edge	15.205 15.209 15.407(b)	PASS
5	Frequency Stability	15.407(g)	PASS
6	AC Power Line Conducted Emissions	15.207 15.407(b)(9)	PASS
7	Antenna Requirement	15.203	PASS

Note: "N/A" denotes test is not applicable in this test report.

2.2. Test Facilities

- EMC Lab : Accredited by CNAS, CHINA
Registration No.: L5288
This Accreditation is valid until: November 12, 2029
- Recognized by FCC, USA
Designation Number: CN1215
This Recognition is valid until: January 31, 2024
- Accredited by A2LA, USA
Registration No.: 4366.01
This Accreditation is valid until: January 31, 2024
- Recognized by Industry Canada
CAB identifier No.: CN0035
This Recognition is valid until: January 31, 2024
- Recognized by VCCI, Japan
Registration No.: C-14103; T-20073; R-13663;
R-20103; G-20097
Date of registration: Apr. 20, 2020
This Recognition is valid until: Apr. 19, 2026
- Recognized by TUV Rheinland, Germany
Registration No.: UA 50413872 0001
Date of registration: July 31, 2018
- Recognized by Intertek
Registration No.: 2011-RTL-L2-64
Date of registration: November 08, 2018
- Name of Firm : EST Technology Co., Ltd.
- Site Location : Chilingxiang, Qishantou, Santun, Houjie, Dongguan, Guangdong, China

2.3. Measurement uncertainty for EST Technology Co., Ltd.

Test Item	Uncertainty
Uncertainty for Conduction emission test	2.54dB
Uncertainty for spurious emissions test (Below 30MHz)	±1.62 dB
Uncertainty for Radiation Emission test (30MHz-1GHz)	3.62
Uncertainty for Radiation Emission test (1GHz to 18GHz)	4.86
Uncertainty for spurious emissions test (18GHz to 40GHz)	4.67
Uncertainty for radio frequency	7×10-8
Uncertainty for conducted RF Power	1.08dB
Uncertainty for Power density test	0.26dB
Temperature	±0.6°C
Humidity	±4.0 %
Volatage DC	±1.0%
Volatage (AC, <10KHz)	±1.5%

Note: This uncertainty represents an expanded uncertainty expressed at approximately the 95% confidence level using a coverage factor of k=2.

2.4. Assistant equipment used for test

Item	Equipment	Brand	Model Name/Type No.	FCC ID	Series No.
-	-	-	-	-	-

Item	Shielded Type	Ferrite Core	Length	Note
1	NO	NO	1.5m	AC Cable

2.5. Block Diagram

For radiated emissions test: EUT was placed on a turn table, which is 0.8 (or 1.5) meter high above ground.

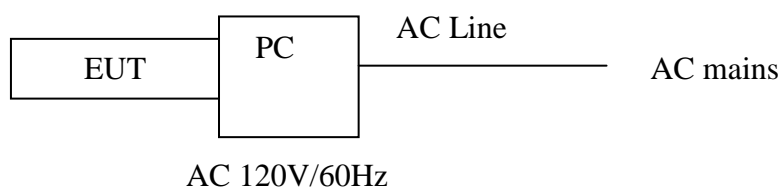

(EUT: WiFi 6E Tri-Band AX5400 PCI-E Adapter)

2.6. Test Mode

Pre-scan has been combined all possible modulations and data rates to determine the worst case test mode, the worst case test mode was selected for the final test as listed below.

Test Item	Test Mode	Channel	Modulation	Data rate
6dB Bandwidth	IEEE 802.11a	149/157/165	OFDM	6Mbps
	IEEE 802.11n HT20	149/157/165	OFDM	MCS0
	IEEE 802.11n HT40	151/159	OFDM	MCS0
	IEEE 802.11ac VHT20	149/157/165	OFDM	MCS0
	IEEE 802.11ac VHT40	151/159	OFDM	MCS0
	IEEE 802.11ac VHT80	155	OFDM	MCS0
	IEEE 802.11ax HE20	149/157/165	OFDMA	MCS0
	IEEE 802.11ax HE40	151/159	OFDMA	MCS0
	IEEE 802.11ax HE80	155	OFDMA	MCS0
26dB Bandwidth	IEEE 802.11a	36/40/48/52/60/64/100/116/140	OFDM	6Mbps
	IEEE 802.11n HT20	36/40/48/52/60/64/100/116/140	OFDM	MCS0
	IEEE 802.11n HT40	38/46/54/62/102/118/134	OFDM	MCS0
	IEEE 802.11ac VHT20	36/40/48/52/60/64/100/116/140	OFDM	MCS0
	IEEE 802.11ac VHT40	38/46/54/62/102/118/134	OFDM	MCS0
	IEEE 802.11ac VHT80	42/58/106/122	OFDM	MCS0
	IEEE 802.11ax HE20	36/40/48/52/60/64/100/116/140	OFDMA	MCS0
	IEEE 802.11ax HE40	38/46/54/62/102/118/134	OFDMA	MCS0
	IEEE 802.11ax HE80	42/58/106/122	OFDMA	MCS0

Test Item	Test Mode	Channel	Modulation	Data rate
99% Occupied Bandwidth	IEEE 802.11a	36/40/48/52/60/64/100/116/140/ 149/157/165	OFDM	6Mbps
	IEEE 802.11n HT20	36/40/48/52/60/64/100/116/140/ 149/157/165	OFDM	MCS0
	IEEE 802.11n HT40	38/46/54/62/102/118/134/151/1 59	OFDM	MCS0
	IEEE 802.11ac VHT20	36/40/48/52/60/64/100/116/140/ 149/157/165	OFDM	MCS0
	IEEE 802.11ac VHT40	38/46/54/62/102/118/134/151/ 159	OFDM	MCS0
	IEEE 802.11ac VHT80	42/58/106/122/155	OFDM	MCS0
	IEEE 802.11ax HE20	36/40/48/52/60/64/100/116/140	OFDMA	MCS0
	IEEE 802.11ax HE40	38/46/54/62/102/118/134	OFDMA	MCS0
	IEEE 802.11ax HE80	42/58/106/122	OFDMA	MCS0
Maximum Conducted Output Power	IEEE 802.11a	36/40/48/52/60/64/100/116/140/ 149/157/165	OFDM	6Mbps
	IEEE 802.11n HT20	36/40/48/52/60/64/100/116/140/ 149/157/165	OFDM	MCS0
	IEEE 802.11n HT40	38/46/54/62/102/118/134/151/1 59	OFDM	MCS0
	IEEE 802.11ac VHT20	36/40/48/52/60/64/100/116/140/ 149/157/165	OFDM	MCS0
	IEEE 802.11ac VHT40	38/46/54/62/102/118/134/151/ 159	OFDM	MCS0
	IEEE 802.11ac VHT80	42/58/106/122/155	OFDM	MCS0
	IEEE 802.11ax HE20	36/40/48/52/60/64/100/116/140	OFDMA	MCS0
	IEEE 802.11ax HE40	38/46/54/62/102/118/134	OFDMA	MCS0
	IEEE 802.11ax HE80	42/58/106/122	OFDMA	MCS0

Peak Power Spectral Density	IEEE 802.11a	36/40/48/52/60/64/100/116/140 /149/157/165	OFDM	6Mbps
	IEEE 802.11n HT20	36/40/48/52/60/64/100/116/140 /149/157/165	OFDM	MCS0
	IEEE 802.11n HT40	38/46/54/62/102/118/134/151/1 59	OFDM	MCS0
	IEEE 802.11ac VHT20	36/40/48/52/60/64/100/116/140 /149/157/165	OFDM	MCS0
	IEEE 802.11ac VHT40	38/46/54/62/102/118/134/151/ 159	OFDM	MCS0
	IEEE 802.11ac VHT80	42/58/106/122/155	OFDM	MCS0
	IEEE 802.11ax HE20	36/40/48/52/60/64/100/116/140	OFDMA	MCS0
	IEEE 802.11ax HE40	38/46/54/62/102/118/134	OFDMA	MCS0
	IEEE 802.11ax HE80	42/58/106/122	OFDMA	MCS0
Unwanted Emissions and Band Edge(Above 1GHz)	IEEE 802.11a	36/40/48/52/60/64/100/116/140 /149/157/165	OFDM	6Mbps
	IEEE 802.11n HT20	36/40/48/52/60/64/100/116/140 /149/157/165	OFDM	MCS0
	IEEE 802.11n HT40	38/46/54/62/102/118/134/151/1 59	OFDM	MCS0
	IEEE 802.11ac VHT20	36/40/48/52/60/64/100/116/140 /149/157/165	OFDM	MCS0
	IEEE 802.11ac VHT40	38/46/54/62/102/118/134/151/ 159	OFDM	MCS0
	IEEE 802.11ac VHT80	42/58/106/122/155	OFDM	MCS0
Unwanted Emissions Below 1GHz	IEEE 802.11a	100	OFDM	6Mbps
Frequency Stability	Unmodulation	36/64/100/149	N/A	N/A
AC Power Line Conducted Emissions	IEEE 802.11a	100	OFDM	6Mbps

Note: In radiated measurement, the EUT had been pre-scan on the positioned of each 3 axis(X,Y,Z), the worst case was found when positioned on **X-plane**.

2.7. Channel List

Band	Mode	Channel	Frequency (MHz)
U-NII-1	IEEE 802.11a & n HT20 & ac VHT20 & ax HE20	36	5180
		40	5200
		44	5220
		48	5240
	IEEE 802.11n HT40 & ac VHT40 & ax HE40	38	5190
		46	5230
	IEEE 802.11ac VHT80 & ax HE80	42	5210
U-NII-3	IEEE 802.11a & n HT20 & ac VHT20 & ax HE20	149	5745
		153	5765
		157	5785
		161	5805
		165	5825
	IEEE 802.11n HT40 & ac VHT40 & ax HE40	151	5755
		159	5795
	IEEE 802.11ac VHT80 & ax HE80	155	5775

2.8. Power Setting of Test Software

Software Name	DRTU		
U-NII-1			
Frequency(MHz)	5180	5200	5240
IEEE 802.11a Setting	15,15	15,15	15,15
IEEE 802.11n HT20 Setting	11,11	11,11	11,11
IEEE 802.11ac VHT20 Setting	11,11	11,11	11,11
IEEE 802.11ax HE20 Setting	11,11	11,11	11,11
Frequency(MHz)	5190	5230	
IEEE 802.11n HT40 Setting	11,11	11,11	
IEEE 802.11ac VHT40 Setting	11,11	11,11	
IEEE 802.11ax HE40 Setting	11,11	11,11	
Frequency(MHz)	5210		
IEEE 802.11ac VHT80 Setting	11,11		
IEEE 802.11ax HE80 Setting	11,11		
U-NII-3			
Frequency(MHz)	5745	5785	5825
IEEE 802.11a Setting	18,18	18,18	18,18
IEEE 802.11n HT20 Setting	15,15	15,15	15,15
IEEE 802.11ac VHT20 Setting	15,15	15,15	15,15
IEEE 802.11ax HE20 Setting	15,15	15,15	15,15
Frequency(MHz)	5755	5795	
IEEE 802.11n HT40 Setting	15,15	15,15	
IEEE 802.11ac VHT40 Setting	15,15	15,15	
Frequency(MHz)	5775		
IEEE 802.11ac VHT80 Setting	15,15		

Note: This information is provided by the applicant.

2.9. Duty Cycle of Test Signal

Refer to section 10: Appendix A

Note:

1. Duty Cycle=On Time/Total Time×100%.
2. Duty Factor=10×LOG(1/Duty Cycle).
3. If duty cycle <98 %, the conducted average output power and average power spectral density should be add duty factor.
4. If duty cycle ≥98 %,the EUT is consider to be transmitting continuously,the conducted average output power and average power spectral density no need to add duty factor.
5. The on-time time is transmission duration(T).
6. The VBW Setting is use for RMS measurement in Unwanted Emissions and Band Edge(Above 1GHz) Test.

2.10. Test Equipment List

For AC power conducted emissions test						
Equipment	Manufacturer	Model No.	Serial No.	Calibration Body	Last Cal.	Next Cal.
EMI Test Receiver	Rohde & Schwarz	ESHS30	EST-E001	LISAI	June 12,23	1 Year
Artificial Mains Network	Rohde & Schwarz	ENV216	EST-E002	LISAI	June 12,23	1 Year
Pulse Limiter	Rohde & Schwarz	ESH3-Z2	EST-E078	LISAI	June 12,23	1 Year
Test Software	Audix	e3-6.111221a	N/A	N/A	N/A	N/A

For radiated emissions test(9KHz-30MHz)						
Equipment	Manufacturer	Model No.	Serial No.	Calibration Body	Last Cal.	Next Cal.
EMI Test Receiver	Rohde & Schwarz	ESR7	EST-E047	LISAI	June 12,23	1 Year
Active Loop Antenna	SCHWARZB ECK	FMZB 1519B	EST-E054	LISAI	June 12,23	1 Year
Test Software	Audix	e3-6.111221a	N/A	N/A	N/A	N/A
9kHz-30MHz Cable	N/A	EST-001	N/A	N/A	N/A	N/A

For radiated emissions test(30MHz-1000MHz)						
Equipment	Manufacturer	Model No.	Serial No.	Calibration Body	Last Cal.	Next Cal.
EMI Test Receiver	Rohde & Schwarz	ESR7	EST-E047	LISAI	June 12,23	1 Year
Bilog Antenna	Teseq	CBL 6111D	EST-E034	LISAI	June 12,23	1 Year
Test Software	Audix	e3-6.111221a	N/A	N/A	N/A	N/A
30-1000MHz Cable	N/A	EST-002	N/A	N/A	N/A	N/A

For radiated emission test(Above 1000MHz)						
Equipment	Manufacturer	Model No.	Serial No.	Calibration Body	Last Cal.	Next Cal.
Horn Antenna	SCHWARZB ECK	BBHA9120D	EST-E144	LISAI	June 12,23	1 Year
Horn Antenna	Com-Power	AHA-840	EST-E133	LISAI	June 12,23	1 Year
Low Noise Amplifier	RF	TRLA-01018 0G45N	EST-E142	LISAI	June 12,23	1 Year
Spectrum Analyzer	Rohde &Schwarz	FSV40	EST-E069	LISAI	June 12,23	1 Year
Test Software	Audix	e3-6.111221a	N/A	N/A	N/A	N/A
Above 1GHz Cable	N/A	EST-003	N/A	N/A	N/A	N/A

For connect EUT antenna terminal test						
Equipment	Manufacturer	Model No.	Serial No.	Calibration Body	Last Cal.	Next Cal.
TS 1120	Tonscend	/	/	/	/	/
Test Software	Tonscend	TS1120-3	3.3.38	/	/	/
RF Control Unit	Tonscend	JS0806-2	EST-E134	LISAI	June 12,23	1 Year
Signal and Spectrum Analyzer	Keysight	N9010B	EST-E141	LISAI	June 12,23	1 Year

3. 6dB BANDWIDTH & 26dB BANDWIDTH & 99% OCCUPIED BANDWIDTH

3.1. Limit

Band	Frequency (MHz)	Test Item	Limit
U-NII-1	5150-5250	26dB Bandwidth&99% Occupied Bandwidth	N/A
U-NII-2A	5250-5350	26dB Bandwidth&99% Occupied Bandwidth	N/A
U-NII-2C	5470-5725	26dB Bandwidth&99% Occupied Bandwidth	N/A
U-NII-3	5725-5850	6dB Bandwidth&99% Occupied Bandwidth	6dB Bandwidth \geq 500KHz

3.2. Test Setup



3.3. Spectrum Analyzer Setting

6dB Bandwidth	
Spectrum Parameters	Setting
RBW	100KHz
VBW	300KHz
Span	40MHz(20MHz Bandwidth mode) 60MHz(40MHz Bandwidth mode) 120MHz(80MHz Bandwidth mode)
Sweep Time	Auto
Detector	Peak
Trace Mode	Max Hold

26dB Bandwidth	
Spectrum Parameters	Setting
RBW	approximately 1% of the emission bandwidth
VBW	>RBW
Span	40MHz(20MHz Bandwidth mode) 60MHz(40MHz Bandwidth mode) 120MHz(80MHz Bandwidth mode)
Sweep Time	Auto
Detector	Peak
Trace Mode	Max Hold

99% Occupied Bandwidth	
Spectrum Parameters	Setting
RBW	1% to 5% of the OBW
VBW	approximately three times the RBW
Span	between 1.5 times and 5.0 times the OBW
Sweep Time	Auto
Detector	Peak
Trace Mode	Max Hold

3.4. Test Procedure

For 26dB Bandwidth Measurement :

- Connect EUT antenna terminal to the spectrum analyzer with RF cable.
- Spectrum analyzer setting parameters in accordance with section 3.3.
- Set the EUT transmit continuously with maximum output power.
- Allow trace to stabilize, measure the maximum width of the emission that is 26 dB down from the peak of the emission. Compare this with the RBW setting of the instrument. Readjust RBW and repeat measurement as needed until the RBW/EBW ratio is approximately 1%.
- Repeat above procedures until all modes and channels were measured.
- Record the results in the test report.

For 6dB Bandwidth Measurement :

- Connect EUT antenna terminal to the spectrum analyzer with RF cable.
- Spectrum analyzer setting parameters in accordance with section 3.3.
- Set the EUT transmit continuously with maximum output power.
- Allow trace to stabilize, measure the maximum width of the emission that is constrained by the frequencies associated with the two outermost amplitude points (upper and lower frequencies) that are attenuated by 6 dB relative to the maximum level measured in the fundamental emission.
- Repeat above procedures until all modes and channels were measured.
- Record the results in the test report.

For 99% Occupied Bandwidth Measurement :

- Connect EUT antenna terminal to the spectrum analyzer with RF cable.
- Spectrum analyzer setting parameters in accordance with section 3.3.
- Set the EUT transmit continuously with maximum output power.
- Allow trace to stabilize, use the 99% power bandwidth function to measure bandwidth.
- Repeat above procedures until all modes and channels were measured.
- Record the results in the test report.

3.5. Test Result

Refer to section 10: Appendix B/C/D

4. MAXIMUM CONDUCTED OUTPUT POWER

4.1. Limit

Band	EUT Type	Limit
U-NII-1	Outdoor Access Point	1W(30dBm) (Max. e.i.r.p \leq 125mW at any elevation angle above 30 degrees as measured from the horizon)
	Indoor Access Point	1W(30dBm)
	Fixed point-to-point Access Point	1W(30dBm)
	Mobile and Portable Client Device	250mW(23.98dBm)
U-NII-2A	All Device	250mW(23.98dBm) or 11dBm+10 log B, Which is lesser. (B is 26dB Bandwidth in MHz)
U-NII-2C	All Device	250mW(23.98dBm) or 11dBm+10 log B, Which is lesser. (B is 26dB Bandwidth in MHz)
U-NII-3	All Device	1W(30dBm)

Note: For the Band U-NII-2A and U-NII-2C, the maximum conducted output power limit calculate result refer to section 3.5.

4.2. Test Setup



4.3. Spectrum Analyzer Setting

Spectrum Parameters	Setting
RBW	1MHz
VBW	3MHz
Span	40MHz(20MHz Bandwidth mode) 80MHz(40MHz Bandwidth mode) 160MHz(80MHz Bandwidth mode)
Sweep Time	Auto
Detector	RMS
Trace Mode	Max Hold

4.4. Test Procedure

- a. Connect EUT antenna terminal to the spectrum analyzer with RF cable.
- b. Spectrum analyzer setting parameters in accordance with section 4.3.
- c. Set the EUT transmit continuously with maximum output power.
- d. Use the channel power function to measure maximum peak output power, allow trace to stabilize, save test pictures.
- e. Repeat above procedures until all modes and channels were measured.
- f. Record the results in the test report.

4.5. Test Result

Refer to section 10: Appendix E

5. PEAK POWER SPECTRAL DENSITY

5.1. Limit

Band	EUT Type	Limit
U-NII-1	Outdoor Access Point	17dBm/MHz
	Indoor Access Point	17dBm/MHz
	Fixed point-to-point Access Point	17dBm/MHz
	Mobile and Portable Client Device	11dBm/MHz
U-NII-2A	All Device	11dBm/MHz
U-NII-2C	All Device	11dBm/MHz
U-NII-3	All Device	30dBm/500KHz

5.2. Test Setup

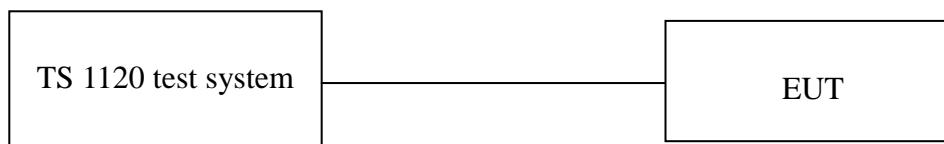

5.3. Spectrum Analyzer Setting

Spectrum Parameters	Setting
RBW	1MHz(For U-NII-1&U-NII-2A&U-NII-2C) 500KHz(For U-NII-3)
VBW	3MHz(For U-NII-1&U-NII-2A&U-NII-2C) 2MHz(For U-NII-3)
Span	encompass the entire 26 dB EBW or 99% OBW of the signal
Sweep Time	Auto
Number of Sweep Point	$\geq 2 \times \text{SPAN/RBW}$
Detector	RMS(power averaging)
Trace Average	≥ 100 traces

5.4. Test Procedure

- a. Connect EUT antenna terminal to the spectrum analyzer with RF cable.
- b. Spectrum analyzer setting parameters in accordance with section 5.3.
- c. Set the EUT transmit continuously with maximum output power.
- d. Allow trace to stabilize, use the marker-to-peak function to set the marker to the average of the emission.
- e. If the duty cycle of test signal $< 98\%$, the result = max measured value + $10 \times \log(1/\text{duty cycle})$;
If the duty cycle of test signal $\geq 98\%$, the result = max measured value.
- f. Repeat above procedures until all modes and channels were measured.
- g. Record the results in the test report.

5.5. Test Result

Refer to section 10: Appendix F

6. UNWANTED EMISSIONS AND BAND EDGE

6.1. Limit

The maximum emissions outside of the frequency bands of operation shall be attenuated in accordance with the following limits:

- (1) For transmitters operating in the 5.15-5.25 GHz band: All emissions outside of the 5.15-5.35 GHz band shall not exceed an e.i.r.p. of -27 dBm/MHz.
- (2) For transmitters operating in the 5.25-5.35 GHz band: All emissions outside of the 5.15-5.35 GHz band shall not exceed an e.i.r.p. of -27 dBm/MHz.
- (3) For transmitters operating in the 5.47-5.725 GHz band: All emissions outside of the 5.47-5.725 GHz band shall not exceed an e.i.r.p. of -27 dBm/MHz.
- (4) For transmitters operating in the 5.725-5.85 GHz band: All emissions shall be limited to a level of -27 dBm/MHz at 75 MHz or more above or below the band edge increasing linearly to 10 dBm/MHz at 25 MHz above or below the band edge, and from 25 MHz above or below the band edge increasing linearly to a level of 15.6 dBm/MHz at 5 MHz above or below the band edge, and from 5 MHz above or below the band edge increasing linearly to a level of 27 dBm/MHz at the band edge.

The unwanted emissions which fall in Restricted bands shall not exceed the field strength levels specified in the following table:

15.209 Radiated emission limits

Frequency (MHz)	Field Strength(μV/m)	Distance(m)
0.009-0.490	2400/F(kHz)	300
0.490-1.705	24000/F(kHz)	30
1.705-30	30	30
30-88	100	3
88-216	150	3
216-960	200	3
Above 960	500	3

15.205 Restricted frequency band

MHz	MHz	MHz	GHz
0.090 - 0.110	16.42 - 16.423	399.9 - 410	4.5 - 5.15
¹ 0.495 - 0.505	16.69475 - 16.69525	608 - 614	5.35 - 5.46
2.1735 - 2.1905	16.80425 - 16.80475	960 - 1240	7.25 - 7.75
4.125 - 4.128	25.5 - 25.67	1300 - 1427	8.025 - 8.5
4.17725 - 4.17775	37.5 - 38.25	1435 - 1626.5	9.0 - 9.2
4.20725 - 4.20775	73 - 74.6	1645.5 - 1646.5	9.3 - 9.5
6.215 - 6.218	74.8 - 75.2	1660 - 1710	10.6 - 12.7
6.26775 - 6.26825	108 - 121.94	1718.8 - 1722.2	13.25 - 13.4
6.31175 - 6.31225	123 - 138	2200 - 2300	14.47 - 14.5
8.291 - 8.294	149.9 - 150.05	2310 - 2390	15.35 - 16.2
8.362 - 8.366	156.52475 - 156.52525	2483.5 - 2500	17.7 - 21.4
8.37625 - 8.38675	156.7 - 156.9	2690 - 2900	22.01 - 23.12
8.41425 - 8.41475	162.0125 - 167.17	3260 - 3267	23.6 - 24.0
12.29 - 12.293	167.72 - 173.2	3332 - 3339	31.2 - 31.8
12.51975 - 12.52025	240 - 285	3345.8 - 3358	36.43 - 36.5
12.57675 - 12.57725	322 - 335.4	3600 - 4400	(²)

Note:

1. $\text{dB}\mu\text{V}/\text{m} = 20\text{Log}(\mu\text{V}/\text{m})$
2. Above 1GHz the formula is used to convert the EIRP to field strength

$$E[\text{dB}\mu\text{V}/\text{m}] = \text{EIRP}[\text{dBm}] - 20 \log (d[\text{m}]) + 104.77,$$
 where E is field strength and d is distance at which the field strength limit is specified in the applicable requirements.
 for example, 3m field strength $(\text{dB}\mu\text{V}/\text{m}) = \text{EIRP} - 20\text{log}(3) + 104.77 = \text{EIRP} + 95.2$

6.2. Test Setup

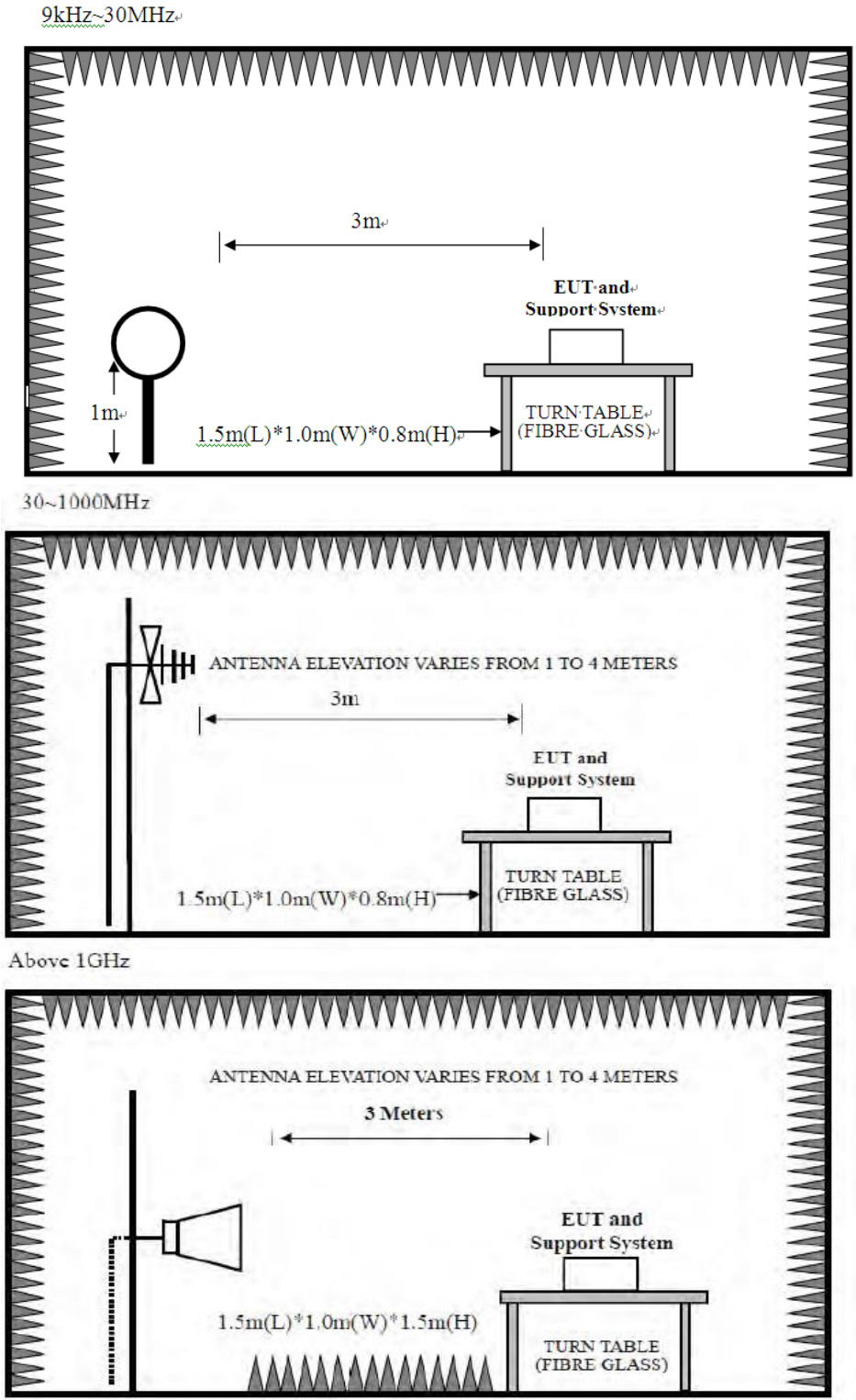

6.3. Spectrum Analyzer Setting

For 9KHz-150KHz

Spectrum Parameters	Setting
RBW	300Hz(for Peak&AVG)/CISPR 200Hz(for QP)
VBW	300Hz(for Peak&AVG)/CISPR 200Hz(for QP)
Start frequency	9KHz
Stop frequency	150KHz
Sweep Time	Auto
Detector	PEAK/QP/AVG
Trace Mode	Max Hold

Note : For 9KHz-90KHz&110KHz-150KHz,the detector is average,other frequency is CISPR QP detector.

For 150KHz-30MHz

Spectrum Parameters	Setting
RBW	9KHz
VBW	9KHz
Start frequency	150KHz
Stop frequency	30MHz
Sweep Time	Auto
Detector	QP
Trace Mode	Max Hold

Note : For 150KHz-490KHz,the detector is average,other frequency is CISPR QP detector.

For 30MHz-1GHz

Spectrum Parameters	Setting
RBW	120KHz
VBW	300KHz
Start frequency	30MHz
Stop frequency	1GHz
Sweep Time	Auto
Detector	QP
Trace Mode	Max Hold

For Above 1GHz

Spectrum Parameters	Setting
RBW	1MHz
VBW	PEAK Measurement
	AVG Measurement Duty cycle $\geq 98\%$, VBW=10Hz Duty cycle $< 98\%$, VBW $\geq 1/T$ Video bandwidth mode=RMS (power averaging)
Start frequency	1GHz
Stop frequency	40GHz
Sweep Time	Auto
Detector	PEAK
Trace Mode	Max Hold

Note : T is the on-time time of the duty cycle,when EUT transmit continuously with maximum output power,unit is seconds. reference section 2.7 for the on-time time.

6.4. Test Procedure

- a. EUT was placed on a turn table, which is 0.8 meter high above ground for below 1GHz test, and which is 1.5 meter high above ground for above 1GHz test.
- b. EUT is set 3 meters away from the receiving antenna, which is mounted on a antenna tower.
- c. Set the EUT transmit continuously with maximum output power.
- d. The turn table can rotate 360 degrees to determine the position of the maximum emission level.
- e. The antenna can be moved up and down between 1 meter and 4 meters to find out the maximum emission level. Both horizontal and vertical polarization of the antenna are set on test.
- f. Spectrum analyzer setting parameters in accordance with section 6.3.
- g. Repeat above procedures until all channels were measured.
- h. Record the results in the test report.
- i. IEEE 802.11a, IEEE 802.11n HT20, IEEE 802.11n HT40, IEEE 802.11ac VHT20, IEEE 802.11ac VHT40, IEEE 802.11ac VHT80 all have been tested, only worst case 802.11ac VHT20 is recorded.

6.5. Test Result

Radiated Emissions Below 1GHz

EST Technology

Chilingxiang, Qishantou, Santun,
Houjie, Dongguan, Guangdong, China
Tel: +86-769-83081888
Fax: +86-769-83081878

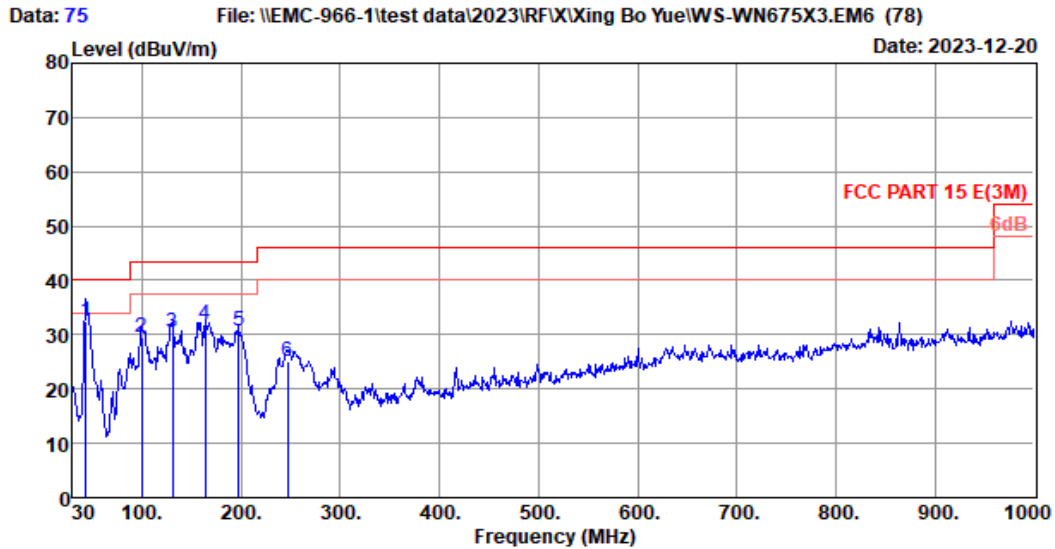

Site no. : 1# 966 Chamber Data no. : 75
 Dis. / Ant. : 3m 37062 Ant. pol. : VERTICAL
 Limit : FCC PART 15 E(3M)
 Env. / Ins. : Temp:21.7°C.Humi:58%;Press:101.1KPa
 Engineer : DCY
 EUT : WiFi 6E Tri-Band AX5400 PCI-E Adapter
 Power : AC 120V/60Hz
 M/N : WS-WN675X3
 Test Mode : TX Mode

	Freq. (MHz)	ANT Factor (dB/m)	Cable Loss (dB)	Reading (dBuV)	Emission Level (dBuV/m)	Limit (dBuV/m)	Margin (dB)	Remark
1	43.58	11.80	0.88	19.85	32.53	40.00	7.47	QP
2	99.84	10.00	1.41	18.20	29.61	43.50	13.89	QP
3	130.88	11.80	1.63	17.11	30.54	43.50	12.96	QP
4	163.86	11.00	1.84	18.92	31.76	43.50	11.74	QP
5	197.81	9.00	2.04	19.67	30.71	43.50	12.79	QP
6	247.28	12.18	2.30	10.73	25.21	46.00	20.79	QP

Remarks: 1. Emission Level= Antenna Factor + Cable Loss + Reading.
 2. Margin= Limit - Emission Level.
 3. The emission levels that are 20dB below the official limit are not reported.

EST Technology

Chilingxiang, Qishantou, Santun,
Houjie, Dongguan, Guangdong, China
Tel: +86-769-83081888
Fax: +86-769-83081878

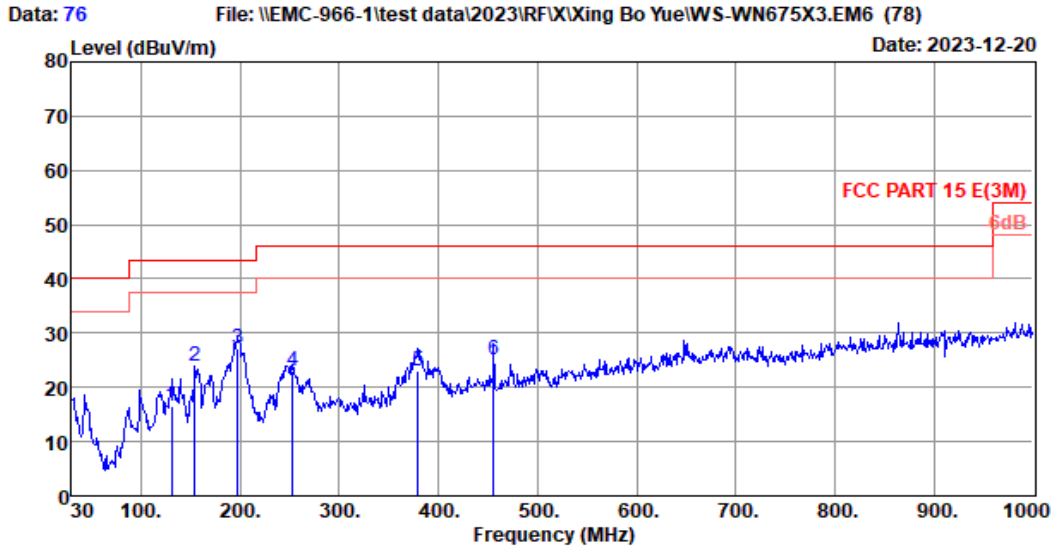

Site no. : 1# 966 Chamber Data no. : 76
 Dis. / Ant. : 3m 37062 Ant. pol. : HORIZONTAL
 Limit : FCC PART 15 E(3M)
 Env. / Ins. : Temp:21.7°C.Humi:58%;Press:101.1KPa
 Engineer : DCY
 EUT : WiFi 6E Tri-Band AX5400 PCI-E Adapter
 Power : AC 120V/60Hz
 M/N : WS-WN675X3
 Test Mode : TX Mode

	Freq. (MHz)	ANT Factor (dB/m)	Cable Loss (dB)	Reading (dBuV)	Emission Level (dBuV/m)	Limit (dBuV/m)	Margin (dB)	Remark
1	130.88	11.80	1.63	3.24	16.67	43.50	26.83	QP
2	154.16	11.80	1.78	10.28	23.86	43.50	19.64	QP
3	197.81	9.00	2.04	16.21	27.25	43.50	16.25	QP
4	253.10	13.38	2.34	7.36	23.08	46.00	22.92	QP
5	379.20	16.12	2.97	4.05	23.14	46.00	22.86	QP
6	455.83	18.20	3.26	3.51	24.97	46.00	21.03	QP

Remarks: 1. Emission Level= Antenna Factor + Cable Loss + Reading.
 2. Margin= Limit - Emission Level.
 3. The emission levels that are 20dB below the official limit are not reported.

Note:

1. The amplitude of 9KHz to 30MHz spurious emission that is attenuated by more than 20dB below the permissible limit has no need to be reported.
2. All channels had been pre-test, only the worst case was reported.



Radiated Emissions Above 1G

EST Technology

Chilingxiang, Qishantou, Santun,
Houjie, Dongguan, Guangdong, China
Tel: +86-769-83081888
Fax: +86-769-83081878

Data: 87 File: \\EMC-966-1\test data\2023\RF\Xing Bo Yue\WS-WN675X3.EM6 (144) Date: 2023-12-16

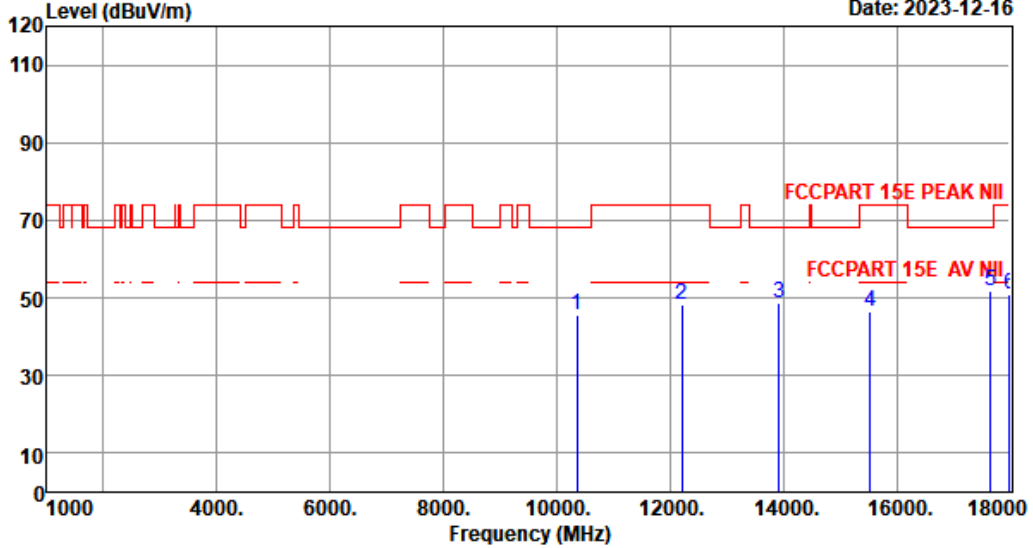

Site no. : 1# 966 Chamber Data no. : 87
 Dis. / Ant. : 3m BBHA9120D-2667 Ant. pol. : VERTICAL
 Limit : FCCPART 15E PEAK NII
 Env. / Ins. : Temp:19.5°C;Humi:50%;Press:101.55kPa
 Engineer : QQZ
 EUT : WiFi 6E Tri-Band AX5400 PCI-E Adapter
 Power : AC 120V/60Hz
 M/N : WS-WN675X3
 Test Mode : IEEE 802.11a TX 5180MHz

	Freq. (MHz)	Ant. Factor (dB/m)	Cable Loss (dB)	Amp Factor (dB)	Reading (dBuV)	Emission Level (dBuV/m)	Limits (dBuV/m)	Margin (dB)	Remark
1	10360.00	38.45	7.95	43.50	42.71	45.61	68.20	22.59	Peak
2	12203.00	38.98	8.92	41.92	42.22	48.20	74.00	25.80	Peak
3	13920.00	39.98	9.73	40.80	39.79	48.70	68.20	19.50	Peak
4	15540.00	38.58	10.46	43.73	41.10	46.41	74.00	27.59	Peak
5	17660.00	40.48	12.15	43.21	42.29	51.71	68.20	16.49	Peak
6	18000.00	41.60	12.45	42.70	39.36	50.71	74.00	23.29	Peak

Remarks: 1. Emission Level= Antenna Factor + Cable Loss - Amp Factor + Reading.
 2. Margin= Limit - Emission Level.
 3. The emission levels that are 20dB below the official limit are not reported.



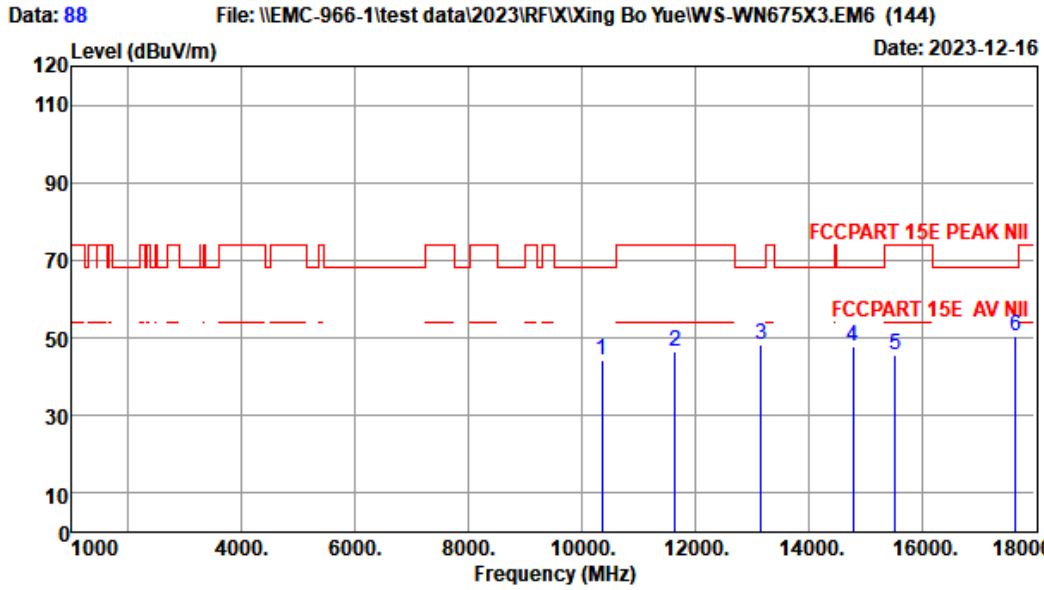

Site no. : 1# 966 Chamber Data no. : 88
 Dis. / Ant. : 3m BBHA9120D-2667 Ant. pol. : HORIZONTAL
 Limit : FCCPART 15E PEAK NII
 Env. / Ins. : Temp:19.5°C;Humi:50%;Press:101.55kPa
 Engineer : QQZ
 EUT : WiFi 6E Tri-Band AX5400 PCI-E Adapter
 Power : AC 120V/60Hz
 M/N : WS-WN675X3
 Test Mode : IEEE 802.11a TX 5180MHz

	Freq. (MHz)	Ant. Factor (dB/m)	Cable Loss (dB)	Amp Factor (dB)	Reading (dBuV)	Emission Level (dBuV/m)	Limits (dBuV/m)	Margin (dB)	Remark
1	10360.00	38.45	7.95	43.50	41.53	44.43	68.20	23.77	Peak
2	11642.00	38.84	8.63	42.48	41.66	46.65	74.00	27.35	Peak
3	13172.00	39.75	9.35	40.80	39.91	48.21	68.20	19.99	Peak
4	14787.00	39.61	10.14	42.75	40.96	47.96	68.20	20.24	Peak
5	15540.00	38.58	10.46	43.73	40.13	45.44	74.00	28.56	Peak
6	17660.00	40.48	12.15	43.21	41.08	50.50	68.20	17.70	Peak

Remarks: 1. Emission Level= Antenna Factor + Cable Loss - Amp Factor + Reading.
 2. Margin= Limit - Emission Level.
 3. The emission levels that are 20dB below the official limit are not reported.

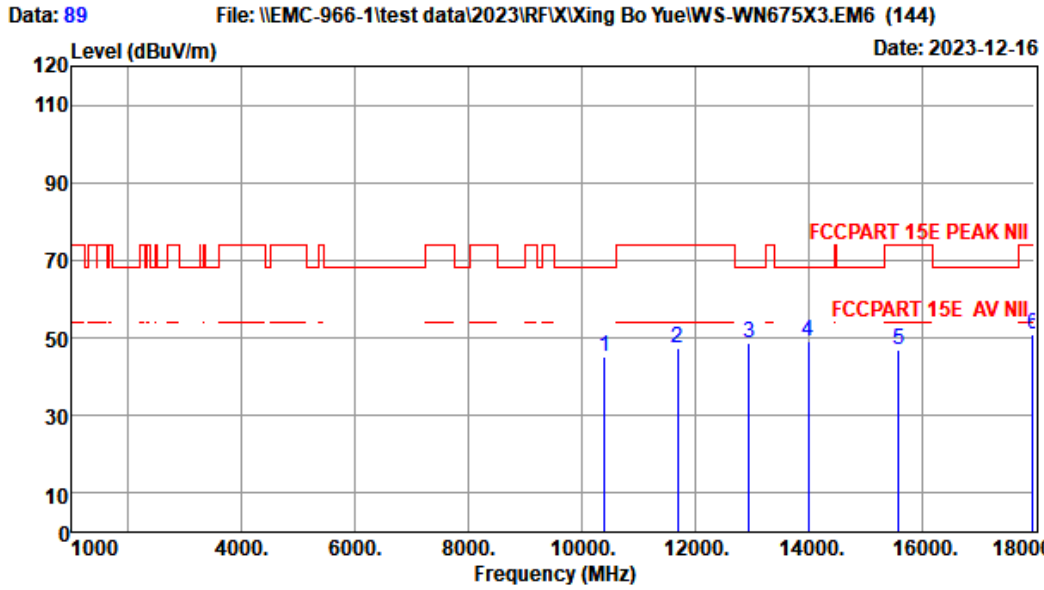

Site no. : 1# 966 Chamber Data no. : 89
 Dis. / Ant. : 3m BBHA9120D-2667 Ant. pol. : HORIZONTAL
 Limit : FCCPART 15E PEAK NII
 Env. / Ins. : Temp:19.5°C;Humi:50%;Press:101.55kPa
 Engineer : QQZ
 EUT : WiFi 6E Tri-Band AX5400 PCI-E Adapter
 Power : AC 120V/60Hz
 M/N : WS-WN675X3
 Test Mode : IEEE 802.11a TX 5200MHz

	Freq. (MHz)	Ant. Factor (dB/m)	Cable Loss (dB)	Amp Factor (dB)	Reading (dBuV)	Emission Level (dBuV/m)	Limits (dBuV/m)	Margin (dB)	Remark
1	10400.00	38.48	7.97	43.47	42.33	45.31	68.20	22.89	Peak
2	11693.00	38.83	8.66	42.44	42.54	47.59	74.00	26.41	Peak
3	12951.00	39.66	9.24	40.87	40.85	48.88	68.20	19.32	Peak
4	14005.00	40.00	9.77	40.80	39.97	48.94	68.20	19.26	Peak
5	15600.00	38.48	10.49	43.78	41.92	47.11	74.00	26.89	Peak
6	17966.00	41.49	12.42	42.75	39.55	50.71	74.00	23.29	Peak

Remarks: 1. Emission Level= Antenna Factor + Cable Loss - Amp Factor + Reading.
 2. Margin= Limit - Emission Level.
 3. The emission levels that are 20dB below the official limit are not reported.

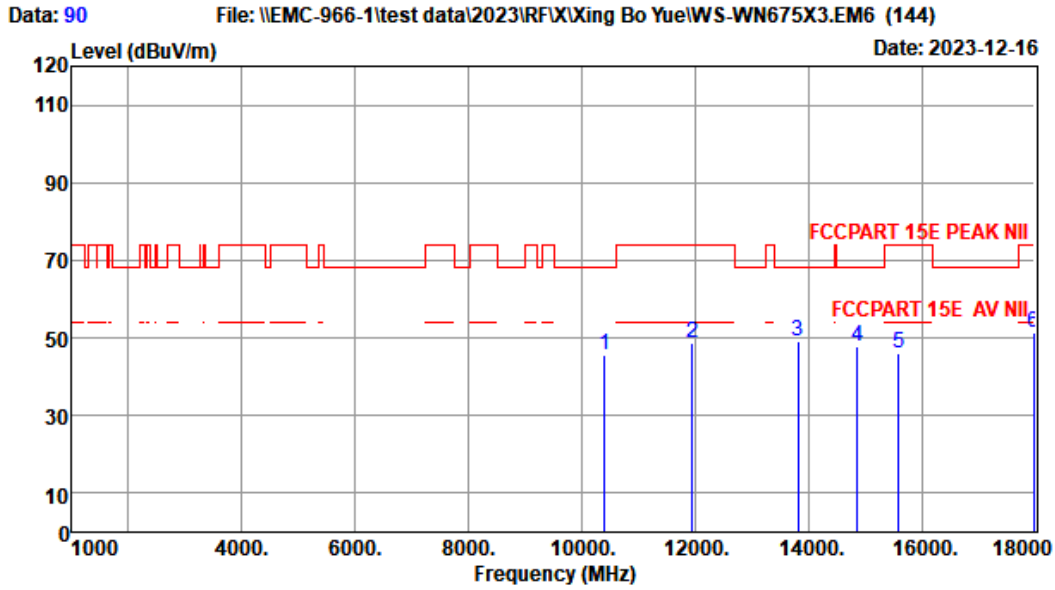

Site no. : 1# 966 Chamber Data no. : 90
 Dis. / Ant. : 3m BBHA9120D-2667 Ant. pol. : VERTICAL
 Limit : FCCPART 15E PEAK NII
 Env. / Ins. : Temp:19.5°C;Humi:50%;Press:101.55kPa
 Engineer : QQZ
 EUT : WiFi 6E Tri-Band AX5400 PCI-E Adapter
 Power : AC 120V/60Hz
 M/N : WS-WN675X3
 Test Mode : IEEE 802.11a TX 5200MHz

	Freq. (MHz)	Ant. Factor (dB/m)	Cable Loss (dB)	Amp Factor (dB)	Reading (dBuV)	Emission Level (dBuV/m)	Limits (dBuV/m)	Margin (dB)	Remark
1	10400.00	38.48	7.97	43.47	42.84	45.82	68.20	22.38	Peak
2	11948.00	38.81	8.80	42.24	43.12	48.49	74.00	25.51	Peak
3	13818.00	39.95	9.67	40.80	40.52	49.34	68.20	18.86	Peak
4	14872.00	39.56	10.18	42.96	41.26	48.04	68.20	20.16	Peak
5	15600.00	38.48	10.49	43.78	40.83	46.02	74.00	27.98	Peak
6	17983.00	41.54	12.44	42.73	40.31	51.56	74.00	22.44	Peak

Remarks: 1. Emission Level= Antenna Factor + Cable Loss - Amp Factor + Reading.
 2. Margin= Limit - Emission Level.
 3. The emission levels that are 20dB below the official limit are not reported.

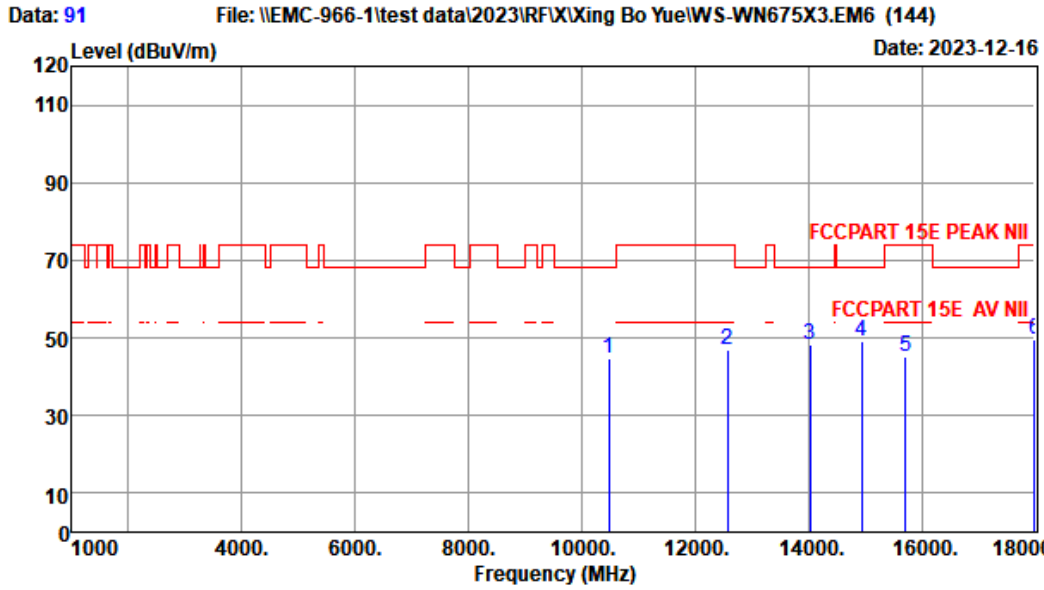

Site no. : 1# 966 Chamber Data no. : 91
 Dis. / Ant. : 3m BBHA9120D-2667 Ant. pol. : VERTICAL
 Limit : FCCPART 15E PEAK NII
 Env. / Ins. : Temp:19.5°C;Humi:50%;Press:101.55kPa
 Engineer : QQZ
 EUT : WiFi 6E Tri-Band AX5400 PCI-E Adapter
 Power : AC 120V/60Hz
 M/N : WS-WN675X3
 Test Mode : IEEE 802.11a TX 5240MHz

	Freq. (MHz)	Ant. Factor (dB/m)	Cable Loss (dB)	Amp Factor (dB)	Reading (dBuV)	Emission Level (dBuV/m)	Limits (dBuV/m)	Margin (dB)	Remark
1	10480.00	38.54	8.01	43.41	41.75	44.89	68.20	23.31	Peak
2	12577.00	39.32	9.08	41.39	40.10	47.11	74.00	26.89	Peak
3	14039.00	39.98	9.79	40.88	39.44	48.33	68.20	19.87	Peak
4	14940.00	39.53	10.22	43.13	42.56	49.18	68.20	19.02	Peak
5	15720.00	38.28	10.53	43.88	40.45	45.38	74.00	28.62	Peak
6	18000.00	41.60	12.45	42.70	38.34	49.69	74.00	24.31	Peak

Remarks: 1. Emission Level= Antenna Factor + Cable Loss - Amp Factor + Reading.
 2. Margin= Limit - Emission Level.
 3. The emission levels that are 20dB below the official limit are not reported.

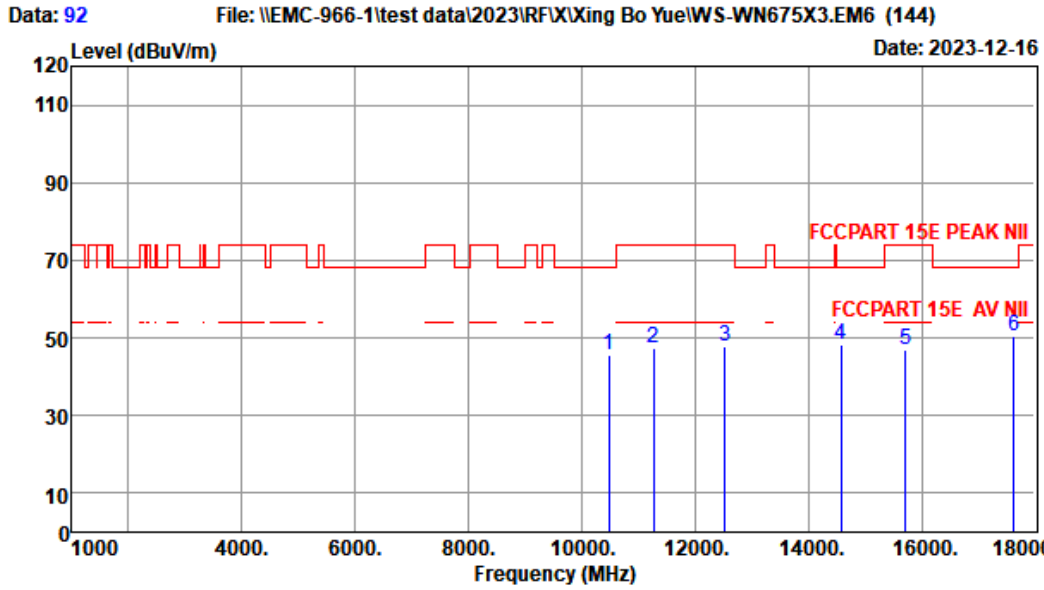

Site no. : 1# 966 Chamber Data no. : 92
 Dis. / Ant. : 3m BBHA9120D-2667 Ant. pol. : HORIZONTAL
 Limit : FCCPART 15E PEAK NII
 Env. / Ins. : Temp:19.5°C;Humi:50%;Press:101.55kPa
 Engineer : QQZ
 EUT : WiFi 6E Tri-Band AX5400 PCI-E Adapter
 Power : AC 120V/60Hz
 M/N : WS-WN675X3
 Test Mode : IEEE 802.11a TX 5240MHz

	Freq. (MHz)	Ant. Factor (dB/m)	Cable Loss (dB)	Amp Factor (dB)	Reading (dBuV)	Emission Level (dBuV/m)	Limits (dBuV/m)	Margin (dB)	Remark
1	10480.00	38.54	8.01	43.41	42.50	45.64	68.20	22.56	Peak
2	11268.00	38.87	8.41	42.78	43.09	47.59	74.00	26.41	Peak
3	12526.00	39.27	9.06	41.46	41.06	47.93	74.00	26.07	Peak
4	14583.00	39.71	10.05	42.24	40.91	48.43	68.20	19.77	Peak
5	15720.00	38.28	10.53	43.88	42.11	47.04	74.00	26.96	Peak
6	17626.00	40.37	12.12	43.26	41.30	50.53	68.20	17.67	Peak

Remarks: 1. Emission Level= Antenna Factor + Cable Loss - Amp Factor + Reading.
 2. Margin= Limit - Emission Level.
 3. The emission levels that are 20dB below the official limit are not reported.

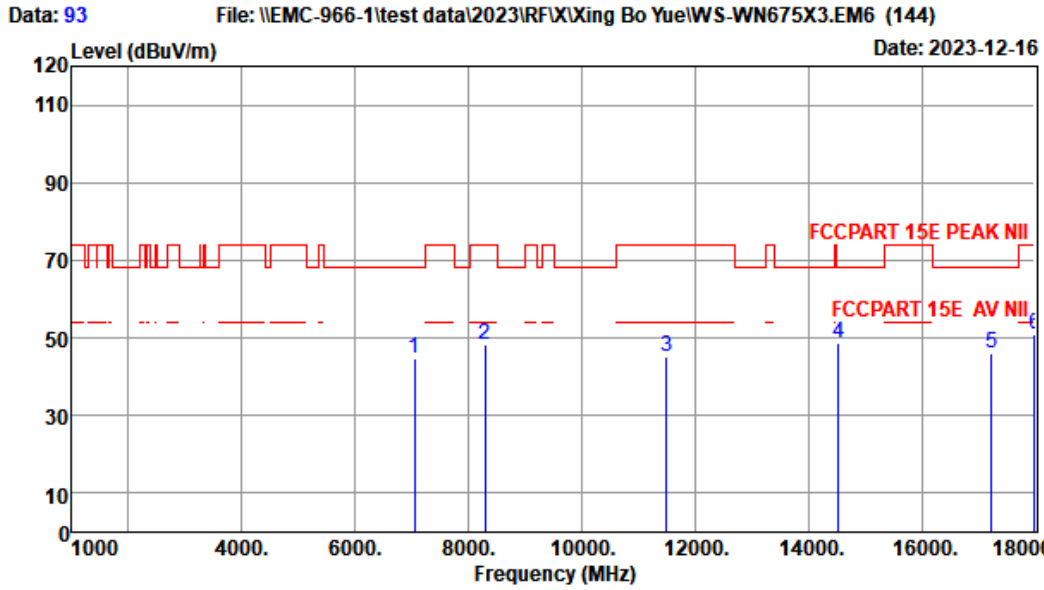

Site no. : 1# 966 Chamber Data no. : 93
 Dis. / Ant. : 3m BBHA9120D-2667 Ant. pol. : HORIZONTAL
 Limit : FCCPART 15E PEAK NII
 Env. / Ins. : Temp:19.5°C;Humi:50%;Press:101.55kPa
 Engineer : QQZ
 EUT : WiFi 6E Tri-Band AX5400 PCI-E Adapter
 Power : AC 120V/60Hz
 M/N : WS-WN675X3
 Test Mode : IEEE 802.11a TX 5745MHz

	Freq. (MHz)	Ant. Factor (dB/m)	Cable Loss (dB)	Amp Factor (dB)	Reading (dBuV)	Emission Level (dBuV/m)	Limits (dBuV/m)	Margin (dB)	Remark
1	7052.00	36.04	6.62	44.09	45.95	44.52	68.20	23.68	Peak
2	8293.00	37.15	7.17	43.83	47.88	48.37	74.00	25.63	Peak
3	11490.00	38.85	8.54	42.61	40.50	45.28	74.00	28.72	Peak
4	14532.00	39.73	10.02	42.11	41.03	48.67	68.20	19.53	Peak
5	17235.00	39.08	11.78	43.84	39.06	46.08	68.20	22.12	Peak
6	18000.00	41.60	12.45	42.70	39.56	50.91	74.00	23.09	Peak

Remarks: 1. Emission Level= Antenna Factor + Cable Loss - Amp Factor + Reading.
 2. Margin= Limit - Emission Level.
 3. The emission levels that are 20dB below the official limit are not reported.

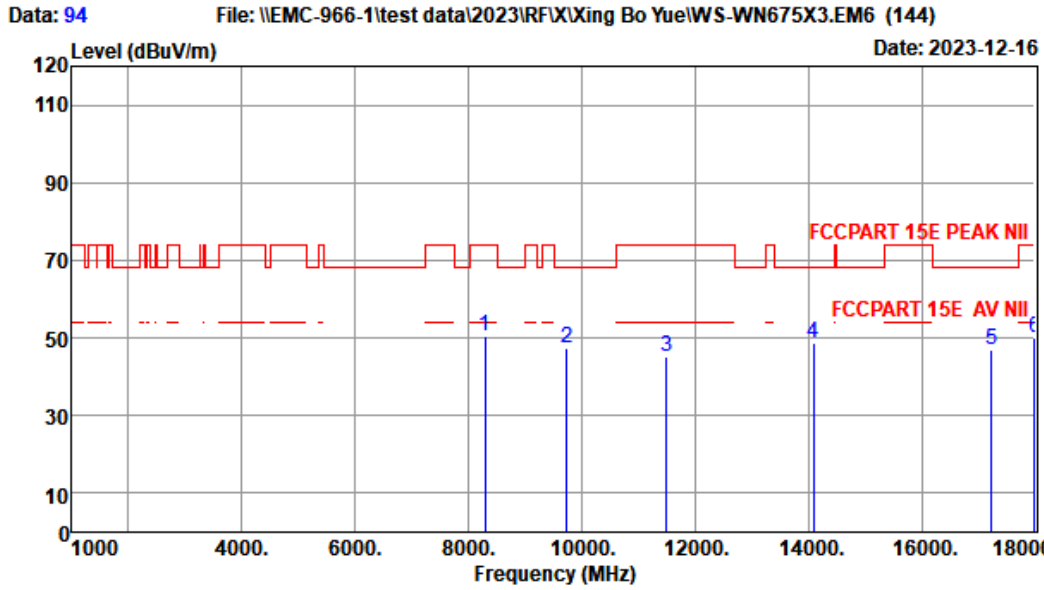

Site no. : 1# 966 Chamber Data no. : 94
 Dis. / Ant. : 3m BBHA9120D-2667 Ant. pol. : VERTICAL
 Limit : FCCPART 15E PEAK NII
 Env. / Ins. : Temp:19.5°C;Humi:50%;Press:101.55kPa
 Engineer : QQZ
 EUT : WiFi 6E Tri-Band AX5400 PCI-E Adapter
 Power : AC 120V/60Hz
 M/N : WS-WN675X3
 Test Mode : IEEE 802.11a TX 5745MHz

	Freq. (MHz)	Ant. Factor (dB/m)	Cable Loss (dB)	Amp Factor (dB)	Reading (dBuV)	Emission Level (dBuV/m)	Limits (dBuV/m)	Margin (dB)	Remark
1	8293.00	37.15	7.17	43.83	50.16	50.65	74.00	23.35	Peak
2	9738.00	38.15	7.77	43.70	45.27	47.49	68.20	20.71	Peak
3	11490.00	38.85	8.54	42.61	40.32	45.10	74.00	28.90	Peak
4	14090.00	39.96	9.81	41.01	40.00	48.76	68.20	19.44	Peak
5	17235.00	39.08	11.78	43.84	39.77	46.79	68.20	21.41	Peak
6	18000.00	41.60	12.45	42.70	38.76	50.11	74.00	23.89	Peak

Remarks: 1. Emission Level= Antenna Factor + Cable Loss - Amp Factor + Reading.
 2. Margin= Limit - Emission Level.
 3. The emission levels that are 20dB below the official limit are not reported.

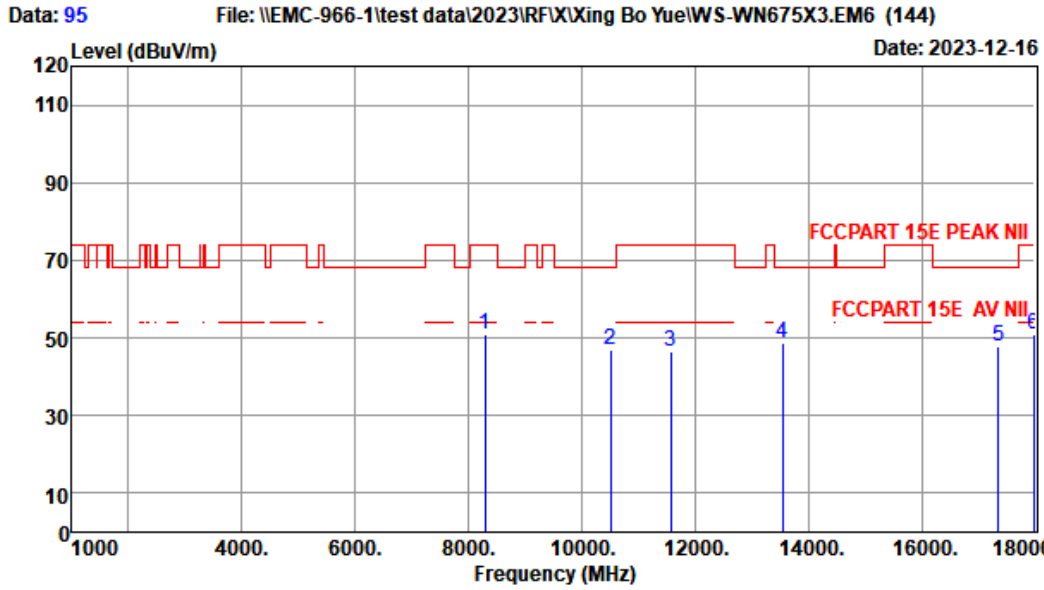

Site no. : 1# 966 Chamber Data no. : 95
 Dis. / Ant. : 3m BBHA9120D-2667 Ant. pol. : VERTICAL
 Limit : FCCPART 15E PEAK NII
 Env. / Ins. : Temp:19.5°C;Humi:50%;Press:101.55kPa
 Engineer : QQZ
 EUT : WiFi 6E Tri-Band AX5400 PCI-E Adapter
 Power : AC 120V/60Hz
 M/N : WS-WN675X3
 Test Mode : IEEE 802.11a TX 5785MHz

	Freq. (MHz)	Ant. Factor (dB/m)	Cable Loss (dB)	Amp Factor (dB)	Reading (dBuV)	Emission Level (dBuV/m)	Limits (dBuV/m)	Margin (dB)	Remark
1	8293.00	37.15	7.17	43.83	50.57	51.06	74.00	22.94	Peak
2	10503.00	38.55	8.02	43.39	43.71	46.89	68.20	21.31	Peak
3	11570.00	38.84	8.59	42.54	41.52	46.41	74.00	27.59	Peak
4	13546.00	39.86	9.54	40.80	40.31	48.91	68.20	19.29	Peak
5	17355.00	39.47	11.88	43.67	40.20	47.88	68.20	20.32	Peak
6	17983.00	41.54	12.44	42.73	39.56	50.81	74.00	23.19	Peak

Remarks: 1. Emission Level= Antenna Factor + Cable Loss - Amp Factor + Reading.
 2. Margin= Limit - Emission Level.
 3. The emission levels that are 20dB below the official limit are not reported.

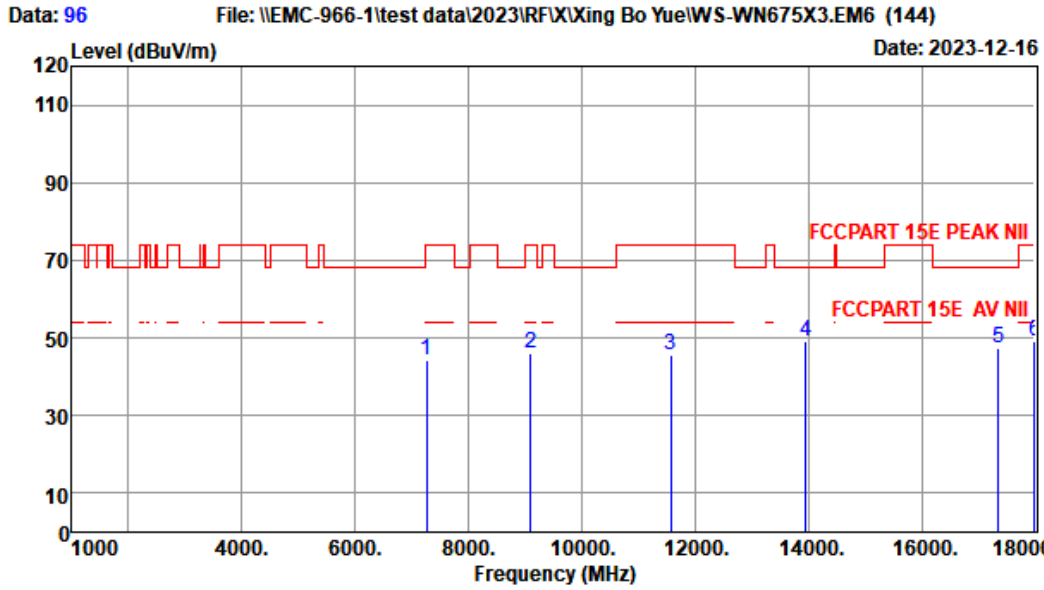

Site no. : 1# 966 Chamber Data no. : 96
 Dis. / Ant. : 3m BBHA9120D-2667 Ant. pol. : HORIZONTAL
 Limit : FCCPART 15E PEAK NII
 Env. / Ins. : Temp:19.5°C;Humi:50%;Press:101.55kPa
 Engineer : QQZ
 EUT : WiFi 6E Tri-Band AX5400 PCI-E Adapter
 Power : AC 120V/60Hz
 M/N : WS-WN675X3
 Test Mode : IEEE 802.11a TX 5785MHz

	Freq. (MHz)	Ant. Factor (dB/m)	Cable Loss (dB)	Amp Factor (dB)	Reading (dBuV)	Emission Level (dBuV/m)	Limits (dBuV/m)	Margin (dB)	Remark
1	7256.00	36.20	6.68	44.07	45.36	44.17	74.00	29.83	Peak
2	9092.00	38.02	7.78	43.43	43.71	46.08	74.00	27.92	Peak
3	11570.00	38.84	8.59	42.54	40.50	45.39	74.00	28.61	Peak
4	13954.00	39.99	9.74	40.80	40.40	49.33	68.20	18.87	Peak
5	17355.00	39.47	11.88	43.67	39.68	47.36	68.20	20.84	Peak
6	18000.00	41.60	12.45	42.70	38.00	49.35	74.00	24.65	Peak

Remarks: 1. Emission Level= Antenna Factor + Cable Loss - Amp Factor + Reading.
 2. Margin= Limit - Emission Level.
 3. The emission levels that are 20dB below the official limit are not reported.

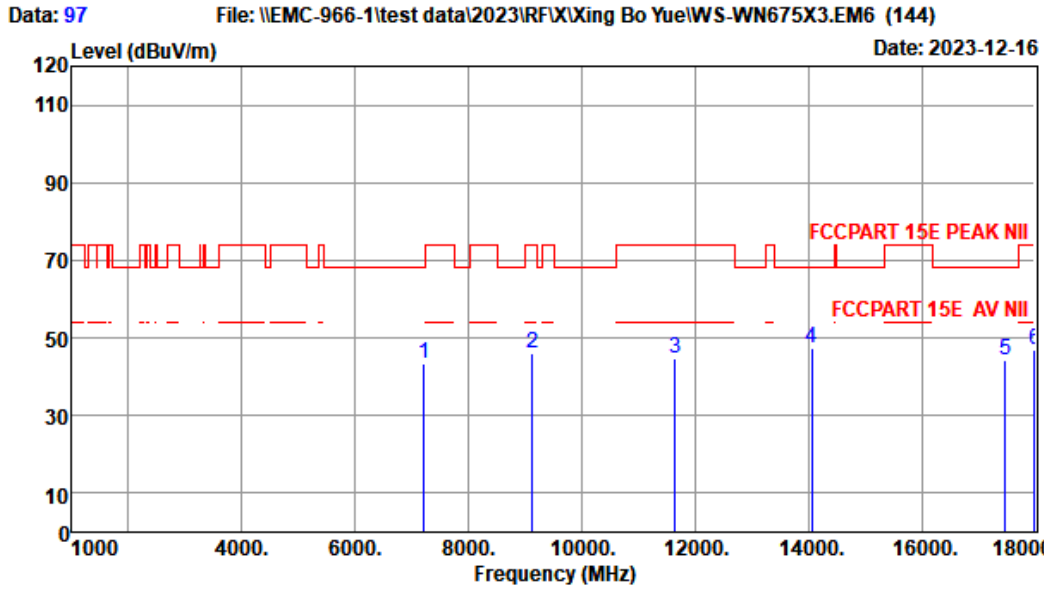

Site no. : 1# 966 Chamber Data no. : 97
 Dis. / Ant. : 3m BBHA9120D-2667 Ant. pol. : HORIZONTAL
 Limit : FCCPART 15E PEAK NII
 Env. / Ins. : Temp:19.5°C;Humi:50%;Press:101.55kPa
 Engineer : QQZ
 EUT : WiFi 6E Tri-Band AX5400 PCI-E Adapter
 Power : AC 120V/60Hz
 M/N : WS-WN675X3
 Test Mode : IEEE 802.11a TX 5825MHz

	Freq. (MHz)	Ant. Factor (dB/m)	Cable Loss (dB)	Amp Factor (dB)	Reading (dBuV)	Emission Level (dBuV/m)	Limits (dBuV/m)	Margin (dB)	Remark
1	7222.00	36.18	6.67	44.08	44.69	43.46	68.20	24.74	Peak
2	9126.00	38.03	7.78	43.45	43.88	46.24	74.00	27.76	Peak
3	11650.00	38.83	8.63	42.48	39.77	44.75	74.00	29.25	Peak
4	14056.00	39.97	9.79	40.93	38.63	47.46	68.20	20.74	Peak
5	17475.00	39.87	11.99	43.49	35.76	44.13	68.20	24.07	Peak
6	18000.00	41.60	12.45	42.70	35.58	46.93	74.00	27.07	Peak

Remarks: 1. Emission Level= Antenna Factor + Cable Loss - Amp Factor + Reading.
 2. Margin= Limit - Emission Level.
 3. The emission levels that are 20dB below the official limit are not reported.

EST Technology

Chilingxiang, Qishantou, Santun,
Houjie, Dongguan, Guangdong, China
Tel: +86-769-83081888
Fax: +86-769-83081878

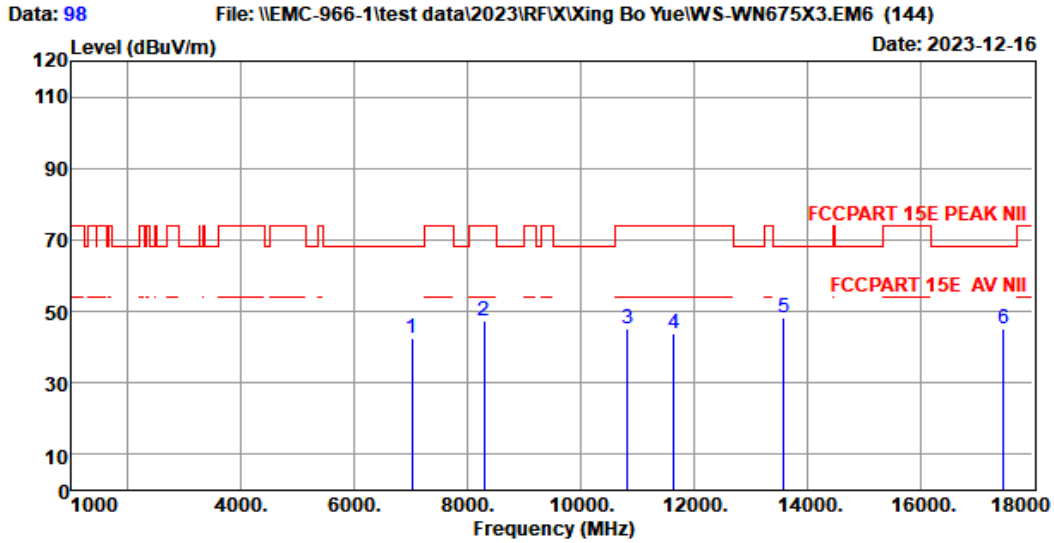

Site no. : 1# 966 Chamber Data no. : 98
 Dis. / Ant. : 3m BBHA9120D-2667 Ant. pol. : VERTICAL
 Limit : FCCPART 15E PEAK NII
 Env. / Ins. : Temp:19.5°C;Humi:50%;Press:101.55kPa
 Engineer : QQZ
 EUT : WiFi 6E Tri-Band AX5400 PCI-E Adapter
 Power : AC 120V/60Hz
 M/N : WS-WN675X3
 Test Mode : IEEE 802.11a TX 5825MHz

	Freq. (MHz)	Ant. Factor (dB/m)	Cable Loss (dB)	Amp Factor (dB)	Reading (dBuV)	Emission Level (dBuV/m)	Limits (dBuV/m)	Margin (dB)	Remark
1	7018.00	36.01	6.61	44.10	44.04	42.56	68.20	25.64	Peak
2	8293.00	37.15	7.17	43.83	46.77	47.26	74.00	26.74	Peak
3	10826.00	38.78	8.18	43.14	41.55	45.37	74.00	28.63	Peak
4	11650.00	38.83	8.63	42.48	38.85	43.83	74.00	30.17	Peak
5	13597.00	39.88	9.56	40.80	39.78	48.42	68.20	19.78	Peak
6	17475.00	39.87	11.99	43.49	36.99	45.36	68.20	22.84	Peak

Remarks: 1. Emission Level= Antenna Factor + Cable Loss - Amp Factor + Reading.
 2. Margin= Limit - Emission Level.
 3. The emission levels that are 20dB below the official limit are not reported.

Note:

1. The amplitude of 18GHz to 40GHz spurious emission that is attenuated by more than 20dB below the permissible limit has no need to be reported.
2. All test mode had been pre-test, only Low/Middle/High Channel of the worst case modulation mode was reported



Band Edge

EST Technology

Chilingxiang, Qishantou, Santun,
Houjie, Dongguan, Guangdong, China
Tel: +86-769-83081888
Fax: +86-769-83081878

Data: 99 File: \\EMC-966-1\test data\2023\RF\Xing Bo Yue\WS-WN675X3.EM6 (144) Date: 2023-12-16

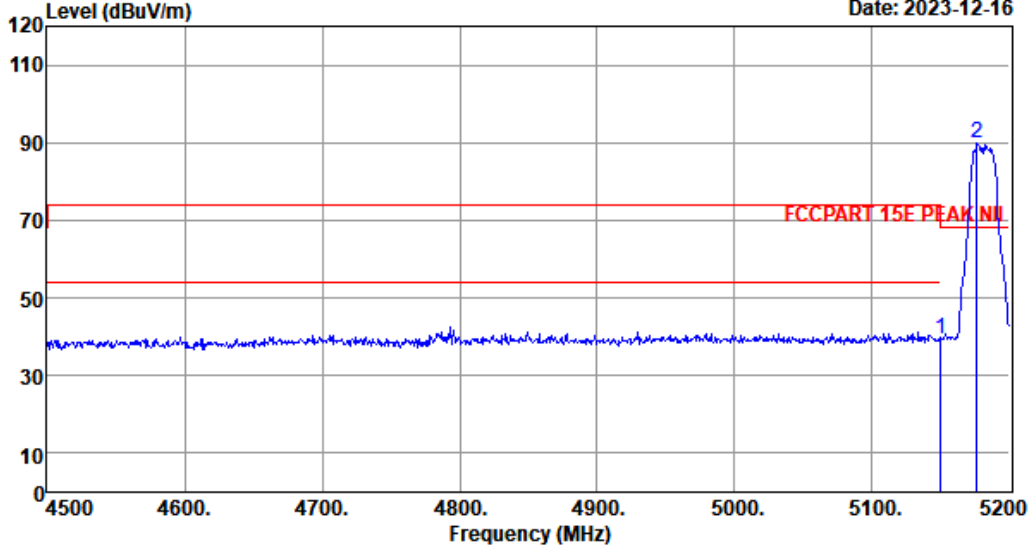

Site no. : 1# 966 Chamber Data no. : 99
 Dis. / Ant. : 3m BBHA9120D-2667 Ant. pol. : VERTICAL
 Limit : FCCPART 15E PEAK NII
 Env. / Ins. : Temp:19.5°C;Humi:50%;Press:101.55kPa
 Engineer : QQZ
 EUT : WiFi 6E Tri-Band AX5400 PCI-E Adapter
 Power : AC 120V/60Hz
 M/N : WS-WN675X3
 Test Mode : IEEE 802.11a TX 5180MHz

	Freq. (MHz)	Ant. Factor (dB/m)	Cable Loss (dB)	Amp Factor (dB)	Reading (dBuV)	Emission Level (dBuV/m)	Limits (dBuV/m)	Margin (dB)	Remark
1	5150.00	32.97	5.52	44.27	45.37	39.59	68.20	28.61	Peak
2	5176.20	32.99	5.55	44.26	95.65	89.93	68.20	-21.73	Peak

Remarks: 1. Emission Level= Antenna Factor + Cable Loss - Amp Factor + Reading.
 2. Margin= Limit - Emission Level.
 3. The emission levels that are 20dB below the official limit are not reported.

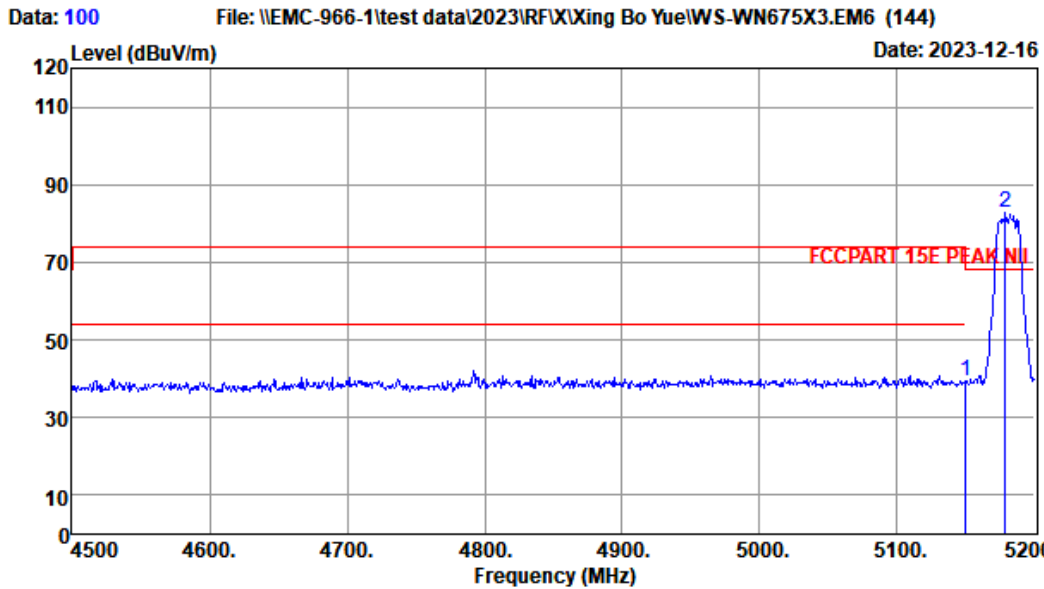

Site no. : 1# 966 Chamber Data no. : 100
 Dis. / Ant. : 3m BBHA9120D-2667 Ant. pol. : HORIZONTAL
 Limit : FCCPART 15E PEAK NII
 Env. / Ins. : Temp:19.5°C;Humi:50%;Press:101.55kPa
 Engineer : QQZ
 EUT : WiFi 6E Tri-Band AX5400 PCI-E Adapter
 Power : AC 120V/60Hz
 M/N : WS-WN675X3
 Test Mode : IEEE 802.11a TX 5180MHz

	Freq. (MHz)	Ant. Factor (dB/m)	Cable Loss (dB)	Amp Factor (dB)	Reading (dBuV)	Emission Level (dBuV/m)	Limits (dBuV/m)	Margin (dB)	Remark
1	5150.00	32.97	5.52	44.27	45.32	39.54	68.20	28.66	Peak
2	5178.30	33.00	5.55	44.26	88.43	82.72	68.20	-14.52	Peak

Remarks: 1. Emission Level= Antenna Factor + Cable Loss - Amp Factor + Reading.
 2. Margin= Limit - Emission Level.
 3. The emission levels that are 20dB below the official limit are not reported.

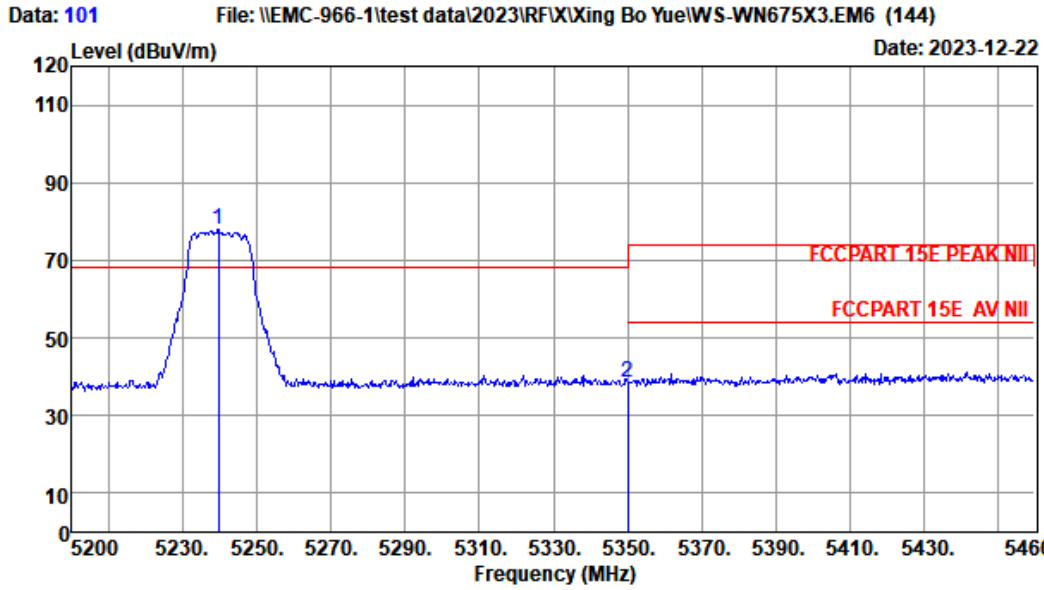

```

Site no.      : 1# 966 Chamber           Data no.   : 101
Dis. / Ant.   : 3m BBHA9120D-2667      Ant. pol.  : HORIZONTAL
Limit        : FCCPART 15E PEAK NII
Env. / Ins.   : Temp:19.5°C;Humi:50%;Press:101.55kPa
Engineer     : QQZ
EUT          : WiFi 6E Tri-Band AX5400 PCI-E Adapter
Power        : AC 120V/60Hz
M/N         : WS-WN675X3
Test Mode    : IEEE 802.11a TX 5240MHz
    
```

	Freq. (MHz)	Ant. Factor (dB/m)	Cable Loss (dB)	Amp Factor (dB)	Reading (dBuV)	Emission Level (dBuV/m)	Limits (dBuV/m)	Margin (dB)	Remark
1	5239.52	33.06	5.59	44.25	83.54	77.94	68.20	-9.74	Peak
2	5350.00	33.19	5.68	44.23	43.98	38.62	68.20	29.58	Peak

Remarks: 1. Emission Level= Antenna Factor + Cable Loss - Amp Factor + Reading.
 2. Margin= Limit - Emission Level.
 3. The emission levels that are 20dB below the official limit are not reported.

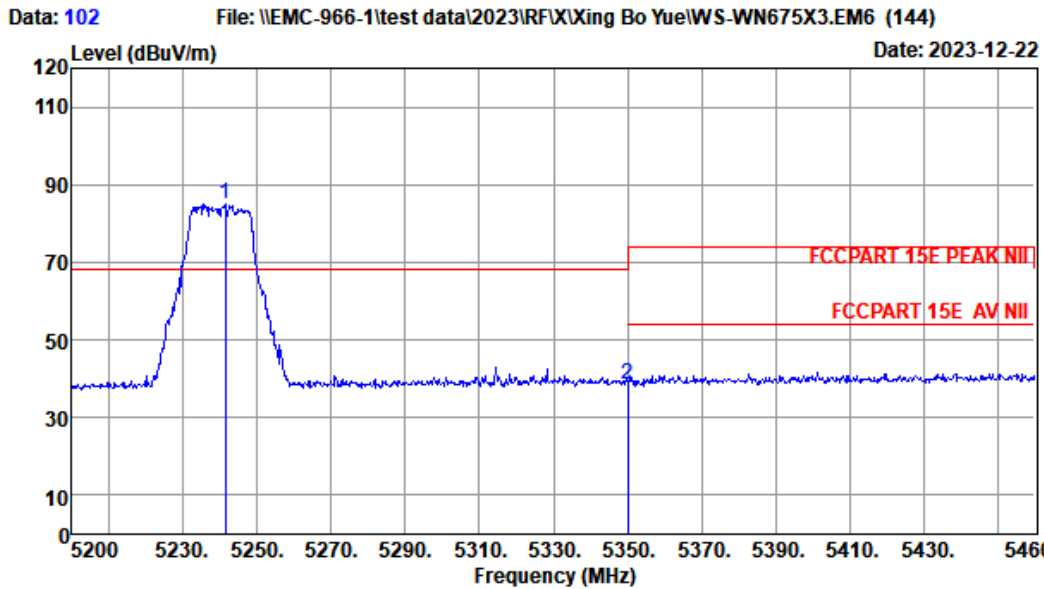

Site no. : 1# 966 Chamber Data no. : 102
 Dis. / Ant. : 3m BBHA9120D-2667 Ant. pol. : VERTICAL
 Limit : FCCPART 15E PEAK NII
 Env. / Ins. : Temp:19.5°C;Humi:50%;Press:101.55kPa
 Engineer : QQZ
 EUT : WiFi 6E Tri-Band AX5400 PCI-E Adapter
 Power : AC 120V/60Hz
 M/N : WS-WN675X3
 Test Mode : IEEE 802.11a TX 5240MHz

	Freq. (MHz)	Ant. Factor (dB/m)	Cable Loss (dB)	Amp Factor (dB)	Reading (dBuV)	Emission Level (dBuV/m)	Limits (dBuV/m)	Margin (dB)	Remark
1	5241.34	33.07	5.59	44.25	90.49	84.90	68.20	-16.70	Peak
2	5350.00	33.19	5.68	44.23	43.95	38.59	68.20	29.61	Peak

Remarks: 1. Emission Level= Antenna Factor + Cable Loss - Amp Factor + Reading.
 2. Margin= Limit - Emission Level.
 3. The emission levels that are 20dB below the official limit are not reported.

18000MHz-40000MHz

Pass

Note: The amplitude of spurious emission that is attenuated by more than 20dB below the permissible limit has no need to be reported.

7. FREQUENCY STABILITY

7.1. Limit

Manufacturers of U-NII devices are responsible for ensuring frequency stability such that an emission is maintained within the band of operation under all conditions of normal operation as specified in the operational description.

7.2. Test Setup

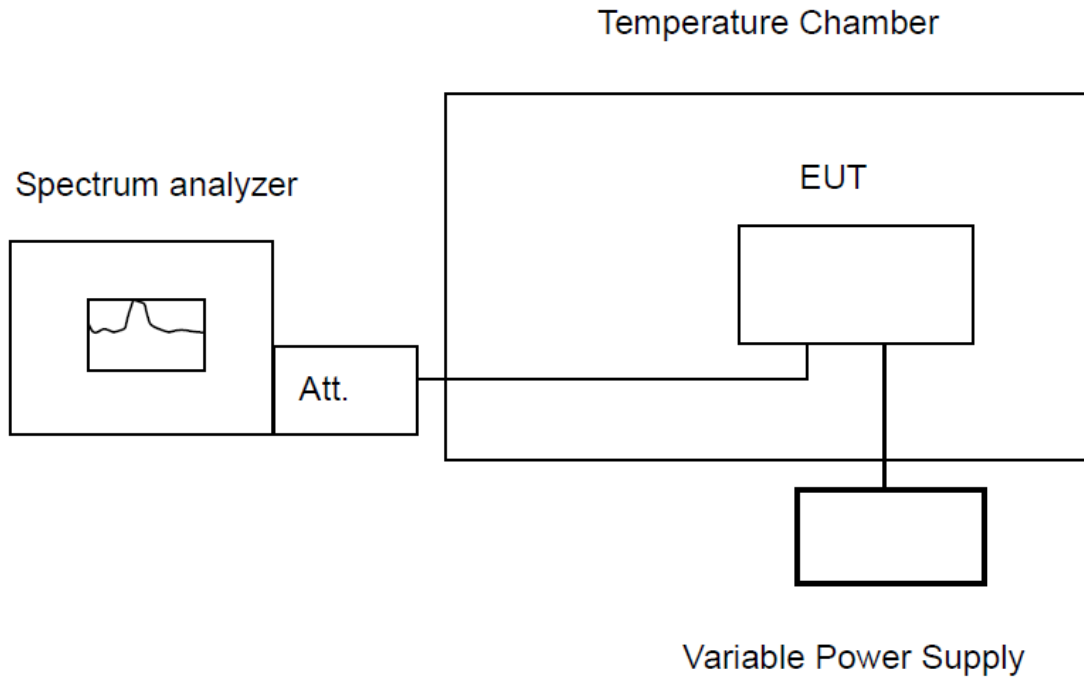

7.3. Spectrum Analyzer Setting

Spectrum Parameters	Setting
RBW	10KHz
VBW	10KHz
Span	200KHz
Sweep Time	Auto
Detector	PEAK
Trace Mode	Max Hold

7.4. Test Procedure

For measurement frequency stability under temperature variation :

- a. Supply the EUT with a nominal ac voltage or install a new or fully charged battery in the EUT.
- b. Turn the EUT OFF and place it inside the environmental temperature chamber.
- c. Connect EUT antenna terminal to the spectrum analyzer with RF cable.
- d. Spectrum analyzer setting parameters in accordance with section 7.3.
- e. Set the temperature control on the chamber to the Specified temperature and allow the oscillator heater and the chamber temperature to stabilize.
- f. Turn the EUT ON with the rated voltage, and the EUT transmit continuously with maximum output power.
- g. Record the operating frequency at startup, and at 2 minutes, 5 minutes, and 10 minutes after the EUT is energized.
- h. Repeat step d through step f to measured the temperature form -20°C to $+50^{\circ}\text{C}$ in 10°C steps.

For frequency stability under voltage variation:

- a. Supply the EUT with a nominal ac voltage or install a new or fully charged battery in the EUT.
- b. Turn the EUT OFF and place it inside the environmental temperature chamber.
- c. Connect EUT antenna terminal to the spectrum analyzer with RF cable.
- d. Spectrum analyzer setting parameters in accordance with section 7.3.
- e. Unless otherwise specified, set the temperature control on the chamber to the ambient room temperature ($+15^{\circ}\text{C}$ to $+25^{\circ}\text{C}$) and allow the oscillator heater and the chamber temperature to stabilize.
- f. Turn the EUT ON with the rated voltage, and the EUT transmit continuously with maximum output power.
- g. Record the operating frequency.
- h. Repeat step d through step f to measured the varied from 85% to 115% of the rated voltage.

7.5. Test Result

Refer to section 10: Appendix H

8. AC POWER LINE CONDUCTED EMISSIONS

8.1. Limit

Frequency			Maximum RF Line Voltage	
			Quasi-Peak Level dB(μV)	Average Level dB(μV)
150kHz	~	500kHz	66 ~ 56*	56 ~ 46*
500kHz	~	5MHz	56	46
5MHz	~	30MHz	60	50

Notes:

- * Decreasing linearly with logarithm of frequency.
- The lower limit shall apply at the transition frequencies.

8.2. Test Setup

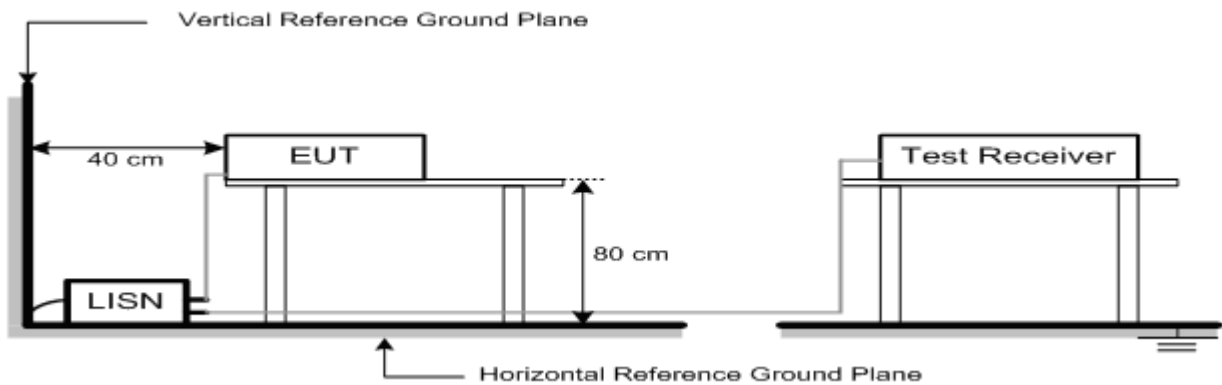

8.3. Spectrum Analyzer Setting

Spectrum Parameters	Setting
RBW	9KHz
VBW	9KHz
Start frequency	150KHz
Stop frequency	30MHz
Sweep Time	Auto
Detector	QP/AVG
Trace Mode	Max Hold

8.4. Test Procedure

- The EUT was placed on a non-metallic table, 80cm above the ground plane.
- The EUT Power connected to the power mains through a line impedance stabilization network.
- Provides a 50 ohm coupling impedance for the EUT (Please refer the block diagram of the test setup and photographs).
- Set the EUT transmit continuously with maximum output power.
- Spectrum analyzer setting parameters in accordance with section 8.3.
- The AC line are checked to find out the maximum conducted emission. In order to find the maximum emission levels, the relative positions of equipment and all of the interface cables shall be changed according to ANSI C63.10: 2013 on Conducted Emission Test.
- Record the results in the test report.

8.5. Test Result

EST Technology

Chilingxiang, Qishantou, Santun,
Houjie, Dongguan, Guangdong, China
Tel: +86-769-83081888
Fax: +86-769-83081878

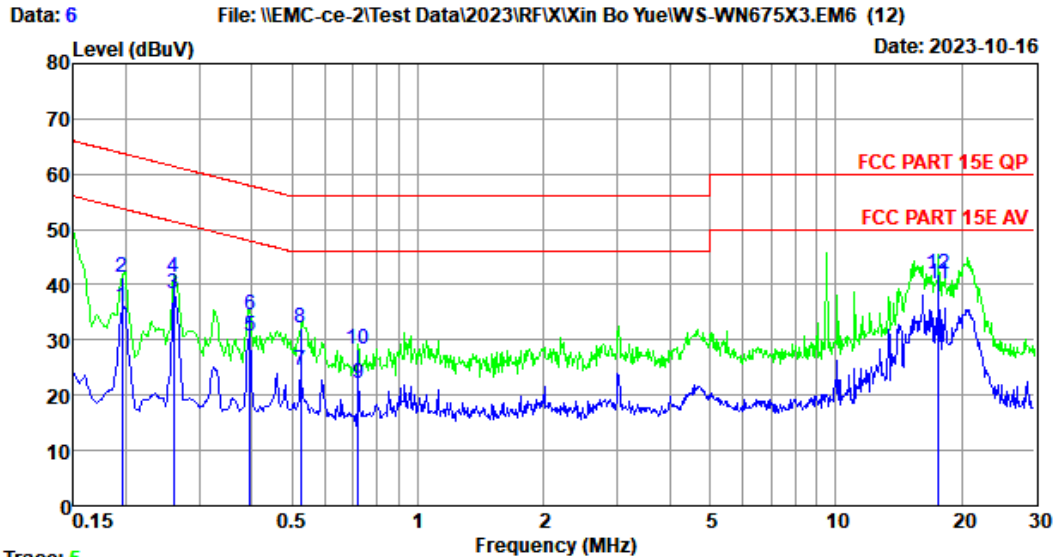

Trace: 5
 Site no : 2#CE Shield Room Data no. : 6
 Env. / Ins. : Temp:24.8°C Humi:55% Press:101.50kPa LINE Phase : NEUTRAL
 Limit : FCC PART 15E QP
 Engineer : XJF
 EUT : WiFi 6E Tri- Band AX5400 PCI-E Adapter
 Power : AC 120V/60Hz
 M/N : WS-WN675X3
 Test Mode : TX Mode

	Freq. (MHz)	LISN Factor (db)	Cable Loss (db)	Reading dBuV	Emission Level (dBuV)	Limits (dBuV)	Margin (dB)	Remark
1	0.195	10.14	9.93	15.95	36.02	53.80	17.78	Average
2	0.195	10.14	9.93	21.26	41.33	63.80	22.47	QP
3	0.260	10.16	9.95	18.33	38.44	51.42	12.98	Average
4	0.260	10.16	9.95	21.24	41.35	61.42	20.07	QP
5	0.396	10.06	9.90	10.71	30.67	47.95	17.28	Average
6	0.396	10.06	9.90	14.66	34.62	57.95	23.33	QP
7	0.524	9.99	9.95	4.49	24.43	46.00	21.57	Average
8	0.524	9.99	9.95	12.36	32.30	56.00	23.70	QP
9	0.720	10.02	10.00	2.15	22.17	46.00	23.83	Average
10	0.720	10.02	10.00	8.21	28.23	56.00	27.77	QP
11	17.661	10.53	10.18	19.32	40.03	50.00	9.97	Average
12	17.661	10.53	10.18	21.33	42.04	60.00	17.96	QP

Remarks: 1. Emission Level= LISN Factor + Cable Loss + Reading.
 2. Margin= Limit - Emission Level.
 3. If the average limit is met when using a quasi-peak detector, the EUT shall be deemed to meet both limits and measurement with average detector is unnecessary.



Data: 8 File: \\EMC-ce-2\Test Data\2023\RF\Xin Bo Yue\WS-WN675X3.EM6 (12) Date: 2023-10-16

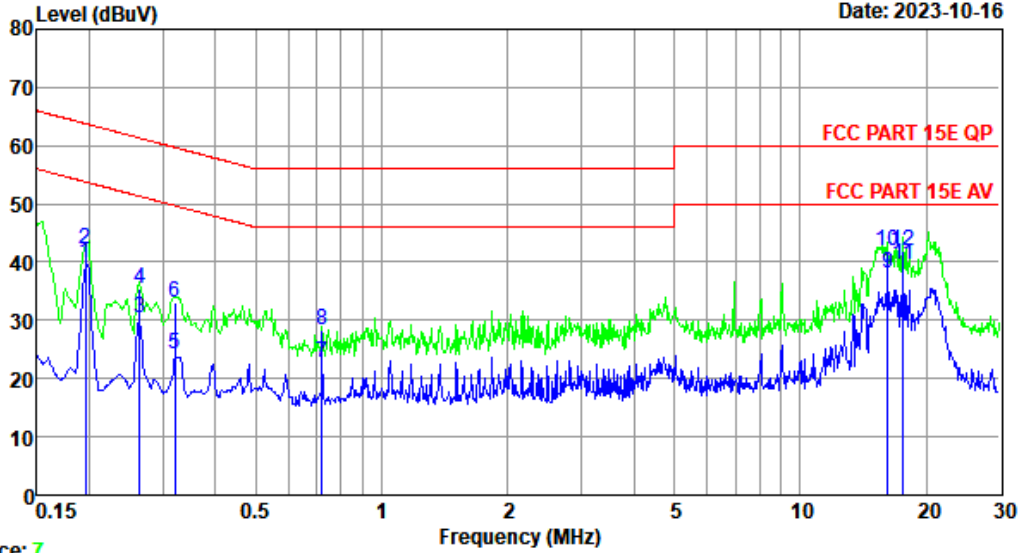

Trace: 7
 Site no : 2#CE Shield Room Data no. : 8
 Env. / Ins. : Temp:24.8°C Humi:55% Press:101.50kPa LINE Phase : LINE
 Limit : FCC PART 15E QP
 Engineer : XJF
 EUT : WiFi 6E Tri- Band AX5400 PCI-E Adapter
 Power : AC 120V/60Hz
 M/N : WS-WN675X3
 Test Mode : TX Mode

	Freq. (MHz)	LISN Factor (db)	Cable Loss (db)	Reading (dBuV)	Emission Level (dBuV)	Limits (dBuV)	Margin (dB)	Remark
1	0.195	10.16	9.93	19.75	39.84	53.80	13.96	Average
2	0.195	10.16	9.93	22.15	42.24	63.80	21.56	QP
3	0.264	10.15	9.91	10.35	30.41	51.29	20.88	Average
4	0.264	10.15	9.91	15.25	35.31	61.29	25.98	QP
5	0.320	10.15	9.87	4.25	24.27	49.71	25.44	Average
6	0.320	10.15	9.87	13.12	33.14	59.71	26.57	QP
7	0.720	10.02	10.00	2.64	22.66	46.00	23.34	Average
8	0.720	10.02	10.00	8.25	28.27	56.00	27.73	QP
9	16.226	10.52	10.11	17.54	38.17	50.00	11.83	Average
10	16.226	10.52	10.11	21.25	41.88	60.00	18.12	QP
11	17.661	10.59	10.18	18.83	39.60	50.00	10.40	Average
12	17.661	10.59	10.18	21.26	42.03	60.00	17.97	QP

Remarks: 1. Emission Level= LISN Factor + Cable Loss + Reading.
 2. Margin= Limit - Emission Level.
 3. If the average limit is met when using a quasi-peak detector, the EUT shall be deemed to meet both limits and measurement with average detector is unnecessary.

9. ANTENNA REQUIREMENTS

9.1. Limit

An intentional radiator shall be designed to ensure that no antenna other than that furnished by the responsible party shall be used with the device. The use of a permanently attached antenna or of an antenna that uses a unique coupling to the intentional radiator shall be considered sufficient to comply with the provisions of this section. The manufacturer may design the unit so that a broken antenna can be replaced by the user, but the use of a standard antenna jack or electrical connector is prohibited. This requirement does not apply to carrier current devices or to devices operated under the provisions of §§15.211, 15.213, 15.217, 15.219, 15.221, or §15.236. Further, this requirement does not apply to intentional radiators that must be professionally installed, such as perimeter protection systems and some field disturbance sensors, or to other intentional radiators which, in accordance with §15.31(d), must be measured at the installation site. However, the installer shall be responsible for ensuring that the proper antenna is employed so that the limits in this part are not exceeded.

9.2. Test Result

The antennas used for this product is Internal antenna, so compliance with antenna requirements.
(Please refer to the EUT photo for details)

10. APPENDIX

Appendix A: Duty Cycle Test Result

Test Mode	Antenna	Frequency[MHz]	Transmission Duration [ms]	Transmission Period [ms]	Duty Cycle [%]
11A	Ant1	5180	1.36	2.61	52.11
	Ant2	5180	1.36	2.61	52.11
	Ant1	5200	1.36	2.61	52.11
	Ant2	5200	1.36	2.61	52.11
	Ant1	5240	1.36	2.62	51.91
	Ant2	5240	1.36	2.62	51.91
	Ant1	5745	1.36	2.61	52.11
	Ant2	5745	1.36	2.61	52.11
	Ant1	5785	1.36	2.62	51.91
	Ant2	5785	1.36	2.61	52.11
	Ant1	5825	1.36	2.62	51.91
	Ant2	5825	1.36	2.61	52.11
11N20MIMO	Ant1	5180	1.15	2.41	47.72
	Ant2	5180	1.15	2.40	47.92
	Ant1	5200	1.15	2.40	47.92
	Ant2	5200	1.15	2.41	47.72
	Ant1	5240	1.15	2.41	47.72
	Ant2	5240	1.15	2.40	47.92
	Ant1	5745	1.15	2.40	47.92
	Ant2	5745	1.15	2.40	47.92
	Ant1	5785	1.15	2.40	47.92
	Ant2	5785	1.14	2.40	47.50
	Ant1	5825	1.14	2.40	47.50
	Ant2	5825	1.15	2.40	47.92
11N40MIMO	Ant1	5190	0.57	1.82	31.32
	Ant2	5190	0.57	1.82	31.32
	Ant1	5230	0.57	1.82	31.32
	Ant2	5230	0.57	1.83	31.15
	Ant1	5755	0.58	1.83	31.69
	Ant2	5755	0.58	1.83	31.69
	Ant1	5795	0.57	1.83	31.15
	Ant2	5795	0.57	1.82	31.32
11AC20MIMO	Ant1	5180	1.15	2.41	47.72
	Ant2	5180	1.15	2.40	47.92
	Ant1	5200	1.15	2.41	47.72
	Ant2	5200	1.15	2.41	47.72
	Ant1	5240	1.16	2.41	48.13
	Ant2	5240	1.16	2.41	48.13
	Ant1	5745	1.15	2.40	47.92
	Ant2	5745	1.15	2.41	47.72
	Ant1	5785	1.15	2.40	47.92
	Ant2	5785	1.16	2.41	48.13
	Ant1	5825	1.15	2.41	47.72
	Ant2	5825	1.15	2.41	47.72
11AC40MIMO	Ant1	5190	0.57	1.83	31.15
	Ant2	5190	0.58	1.83	31.69
	Ant1	5230	0.58	1.83	31.69
	Ant2	5230	0.58	1.83	31.69
	Ant1	5755	0.57	1.83	31.15
	Ant2	5755	0.57	1.83	31.15
	Ant1	5795	0.58	1.83	31.69
	Ant2	5795	0.58	1.83	31.69

11AC80MIMO	Ant1	5210	0.29	1.54	18.83	
	Ant2	5210	0.29	1.54	18.83	
	Ant1	5775	0.28	1.54	18.18	
	Ant2	5775	0.29	1.54	18.83	
11AX20MIMO	Ant1	5180	0.99	2.24	44.20	
	Ant2	5180	0.99	2.25	44.00	
	Ant1	5200	0.99	2.24	44.20	
	Ant2	5200	0.99	2.25	44.00	
	Ant1	5240	0.99	2.25	44.00	
	Ant2	5240	0.99	2.24	44.20	
	Ant1	5745	0.99	2.25	44.00	
	Ant2	5745	0.99	2.24	44.20	
	Ant1	5785	0.99	2.24	44.20	
	Ant2	5785	0.99	2.24	44.20	
	Ant1	5825	0.99	2.24	44.20	
	Ant2	5825	0.99	2.25	44.00	
	11AX40MIMO	Ant1	5190	0.52	1.77	29.38
		Ant2	5190	0.52	1.78	29.21
Ant1		5230	0.52	1.77	29.38	
Ant2		5230	0.52	1.77	29.38	
Ant1		5755	0.52	1.77	29.38	
Ant2		5755	0.52	1.78	29.21	
Ant1		5795	0.52	1.78	29.21	
Ant2		5795	0.52	1.78	29.21	
11AX80MIMO	Ant1	5210	0.28	1.53	18.30	
	Ant2	5210	0.28	1.54	18.18	
	Ant1	5775	0.28	1.53	18.30	
	Ant2	5775	0.28	1.54	18.18	

Test Graphs

