

**KDB 680106 D01 V02**  
**47 C.F.R. Part 1, Subpart I, Section 1.1310**  
**47 C.F.R. Part 1, Subpart I, Section 1.1307**  
**47 C.F.R. Part 2, Subpart J, Section 2.1093**

## **RF Exposure Test Report**

**For**

**Wireless Charging System**

**Model: SYECLWPC1801**

**Trade Name: HYUNDAI, KIA**

*Issued to*

**SEOYON ELECTRONICS Co.,Ltd**  
**100, Saneop-ro 156beon-gil, Gwonseon-gu, Suwon-si, Gyeonggi-do, Korea 16648**

*Issued by*

**Compliance Certification Services Inc.**  
**Tainan Laboratory**  
**No.8, Jiucengling, Xinhua Dist., Tainan City 712, Taiwan (R.O.C.)**  
**<http://www.ccsrf.com>**  
**[service@ccsrf.com](mailto:service@ccsrf.com)**  
**Issued Date: October 17, 2017**



---

## Revision History

Rev.	Issue Date	Revisions	Effect Page	Revised By
00	2017/10/17	Initial Issue	ALL	Jerry Chung
01	2017/11/16	1. Modify operating frequency.	P.4	Angel Cheng

## TABLE OF CONTENTS

1. EUT Specification .....	4
2. Test limit.....	5
3. Test Method .....	6
4. Test Results .....	8
5. Equipment List.....	9
6. EUT Photo .....	10
7. Setup Photo .....	11

**1. EUT Specification****Equipment under Test:** Wireless Charging System**Trade Name:** HYUNDAI, KIA**Model Number:** SYECLWPC1801**Operating Frequency:** 110 KHz ~ 115 KHz**Date of Test:** October 11, 2017

<b>Applicable Standards</b>
KDB 680106 D01 V02 47 C.F.R. Part 1, Subpart I, Section 1.1310 47 C.F.R. Part 1, Subpart I, Section 1.1307 47 C.F.R. Part 2, Subpart J, Section 2.1093
<b>Test Result</b>
Pass

The test results in this report apply only to the tested sample of the stated device/equipment. Other similar device/equipment will not necessarily produce the same results due to production tolerance and measurement uncertainties.

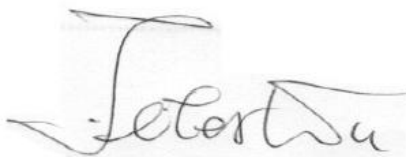
**Approved by:**

---

Jeter Wu  
Assistant Manager  
Compliance Certification Services Inc.

**Tested by:**

---

Jerry Chung  
SAR Engineer  
Compliance Certification Services Inc.

**2. Test limit**

FCC Rules and Regulations Part 1 Section 1.1310 and KDB 680106 D01 v02

§1.1310 : The criteria listed in the following table shall be used to evaluate the environment impact of human exposure to radio frequency (RF) radiation as specified in §1.1307(b), except in the case of portable devices which shall be evaluated according to the provisions of FCC part 2.1093 of this chapter.

Table 1 – Limits for Maximum Permissible Exposure (MPE)  
Limits for General Population/Uncontrolled Exposure

Frequency Range (MHz)	Electric Field Strength (E) (V/m)	Magnetic Field Strength (H) (A/m)	Power Density (S) (mW/cm <sup>2</sup> )	Averaging Time (Minutes)
0.3-1.34	614	1.63	*(100)	30
1.34-30	824/f	2.19/f	*(180/f <sup>2</sup> )	30
30-300	27.5	0.073	0.2	30
300-1500			f/500	30
1500-100,000			1.0	30

f = frequency in MHz

\* = Plane-wave equivalent power density

Note to Table 1 : General population/uncontrolled exposures apply in situations in which the general public may be exposed, or in which persons that are exposed as a consequence of their employment may not be fully aware of the potential for exposure or can not exercise control over their exposure.

### 3. Test Method

#### Test setup

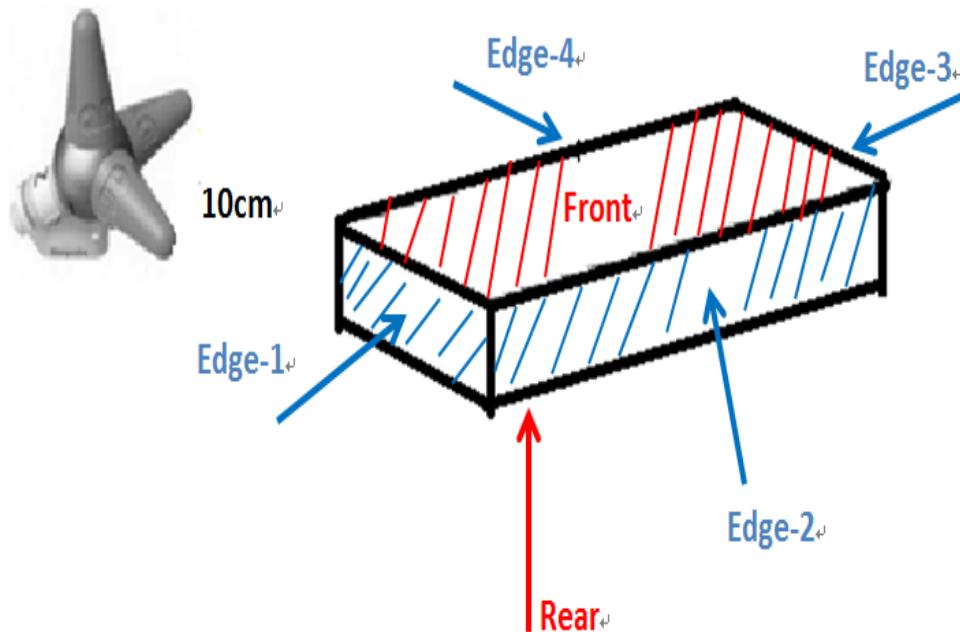

- a) The measurement probe was placed at test distance as 10cm which is between the edge of the charger and the probe.
- b) The highest emission level was recorded and compared with the limit as soon as measurement of each point (Edge 1, Edge 2, Edge 3, Edge 4, Rear, and Front) was completed.

## H-Field

## Loop Ant

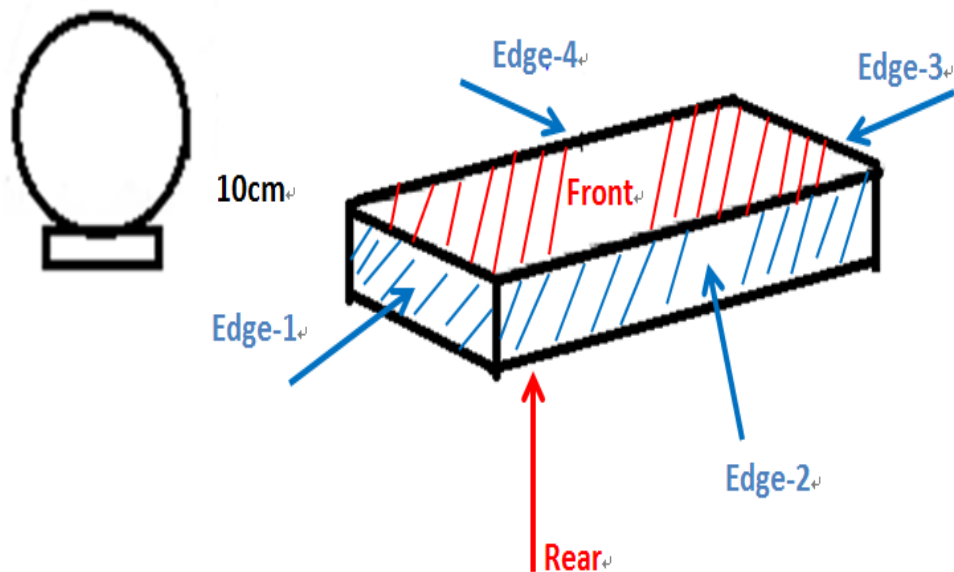

- The measurement probe was placed at test distance as 10cm which is between the edge of the charger and the probe.
- The highest emission level was recorded and compared with the limit as soon as measurement of each point (Edge 1, Edge 2, Edge 3, Edge 4, Rear and Front) was completed.

**4. Test Results**

E-Field Strength

Test Distance (cm)	Test Position	Test result (V/m)	FCC Limit (V/m)
10 cm	Edge 1	0.44	614
	Edge 2	0.45	614
	Edge 3	0.49	614
	Edge 4	0.45	614
	Front	13.23	614
	Rear	6.69	614

H-Field Strength

Test Distance (cm)	Test Position	Test result (A/m)	FCC Limit (A/m)
10 cm	Edge 1	0.003113	1.63
	Edge 2	0.003193	1.63
	Edge 3	0.003459	1.63
	Edge 4	0.003193	1.63
	Front	0.009313	1.63
	Rear	0.004789	1.63



**5. Equipment List**

<b>Name of Equipment</b>	<b>Manufacturer</b>	<b>Model</b>	<b>Serial Number</b>	<b>Calibration Due Date</b>
Laser Powered Field Probe	AR	FL7006	0433723	2018/08/31
Loop Antenna	COM-POWER	AL-130	121051	2018/03/01
Spectrum Analyzer	Agilent	E4446A	US42510268	2018/02/09

Note: The calibration period equipment is 1 year.

**6. EUT Photo**

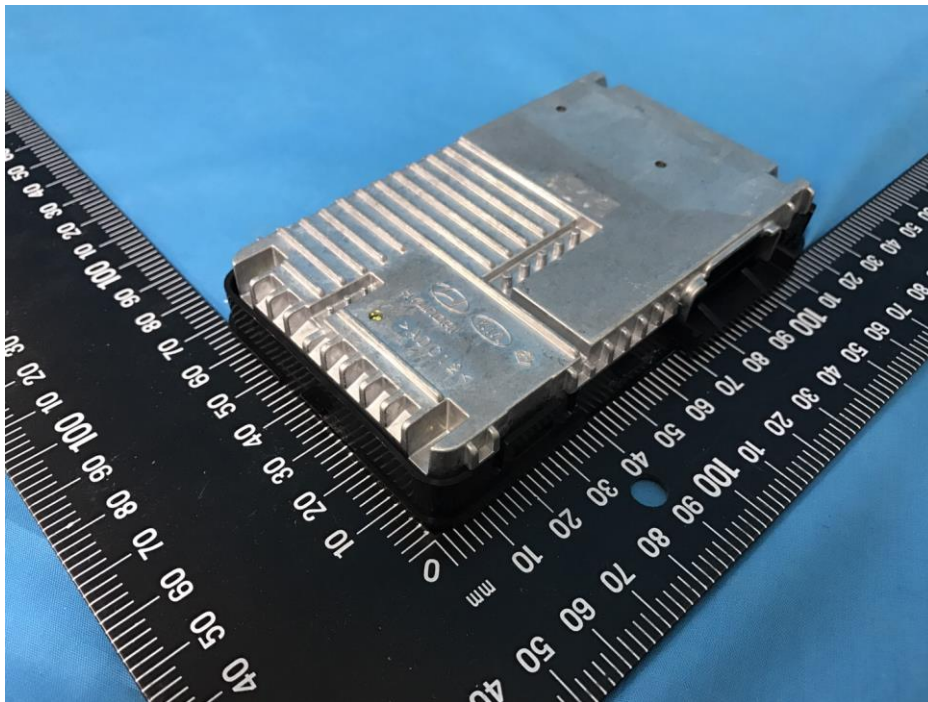
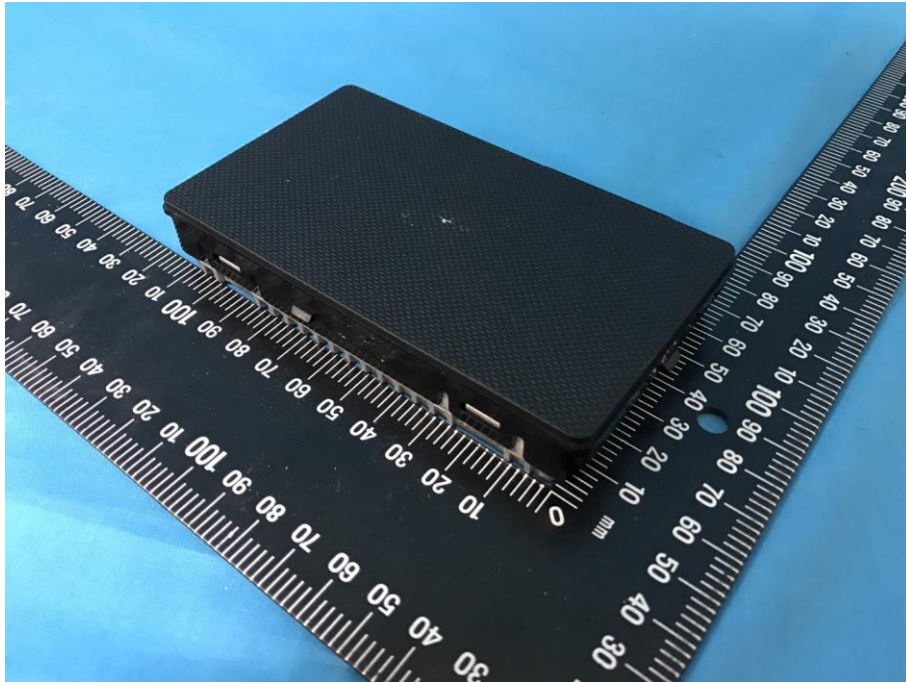

## 7. Setup Photo

E-Field

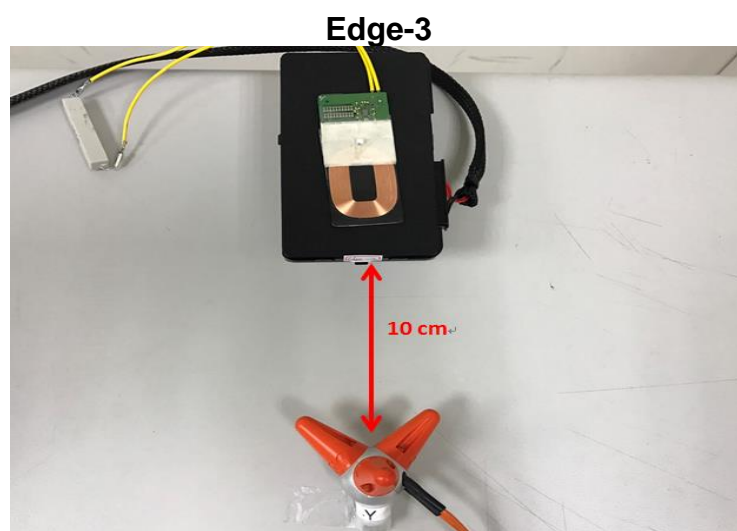
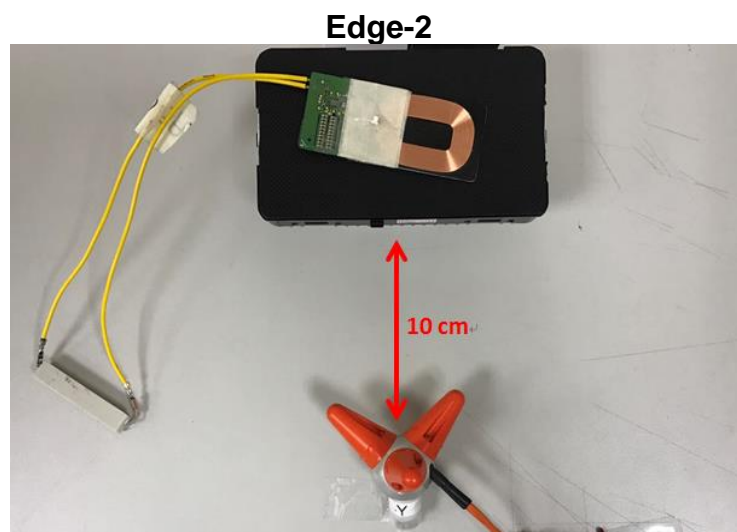
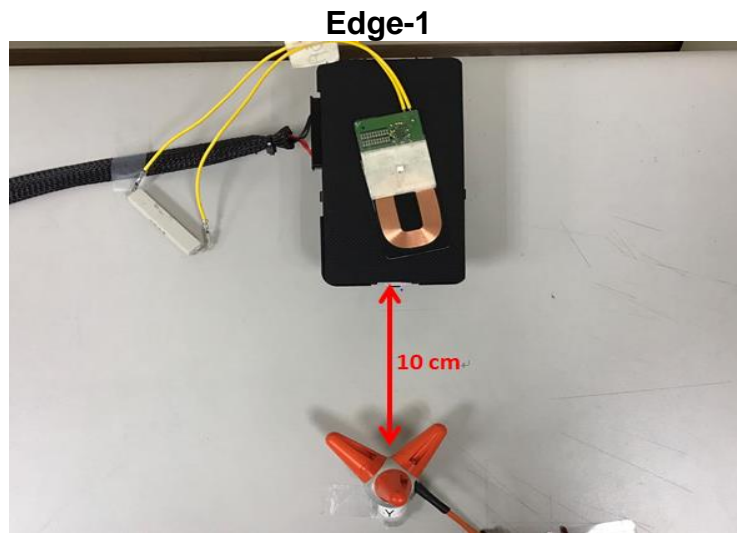

**Edge-4**

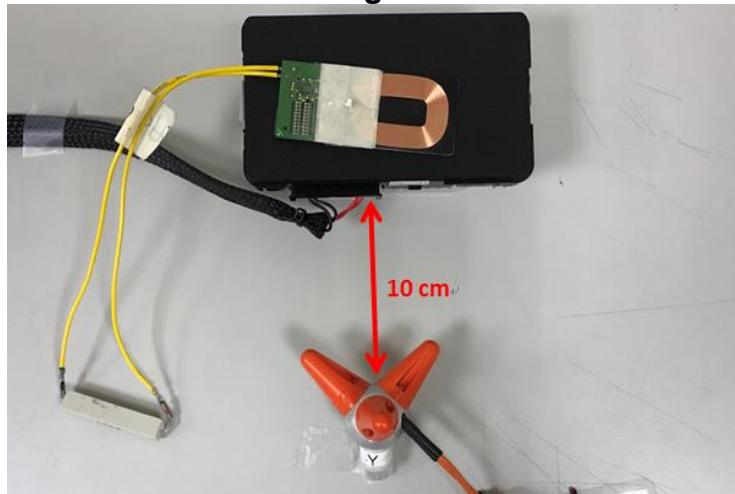

**Front**

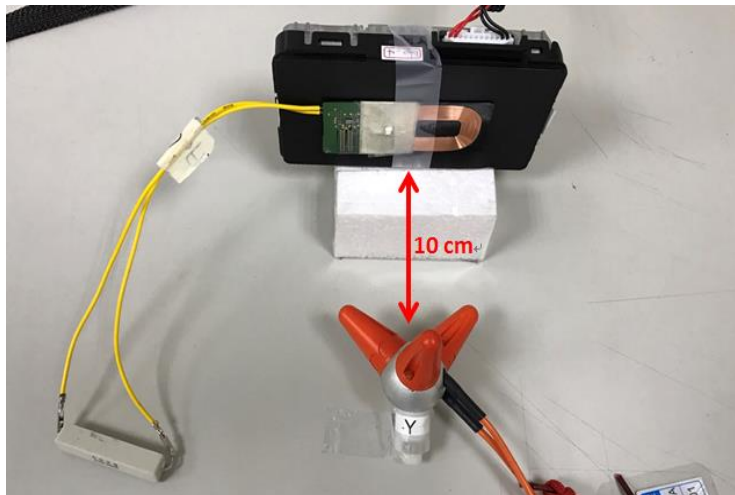

**Rear**

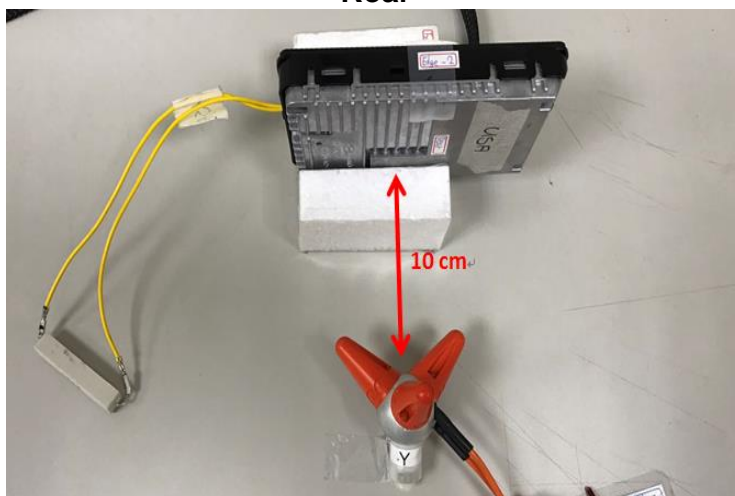

H-Field

Edge-1

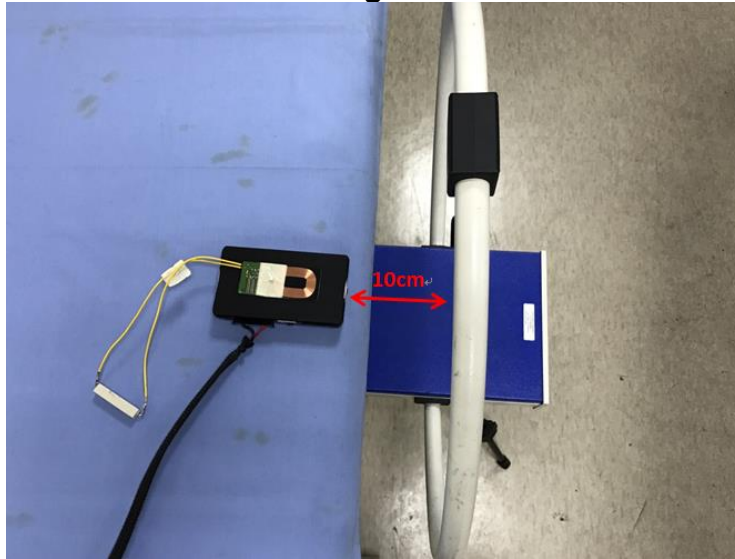

**Edge-2**

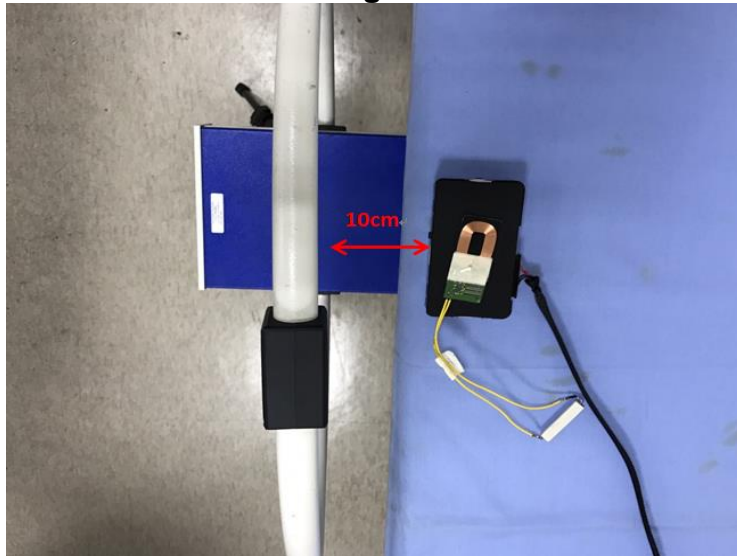

**Edge-3**

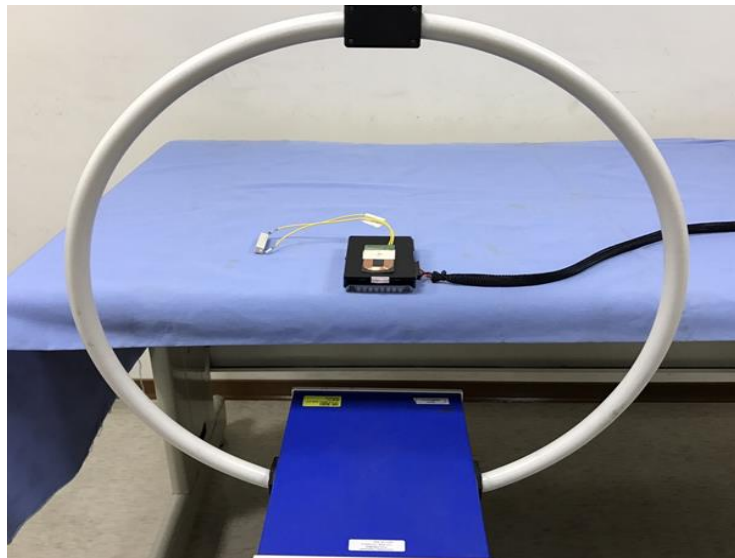
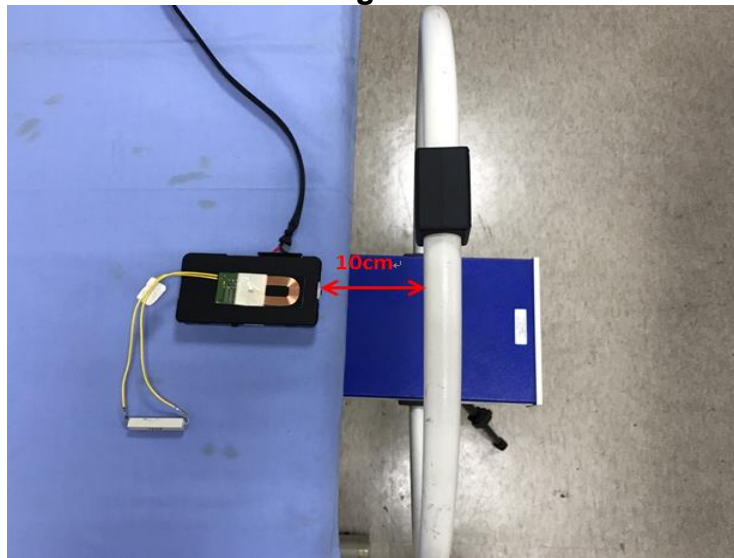

**Edge-4**

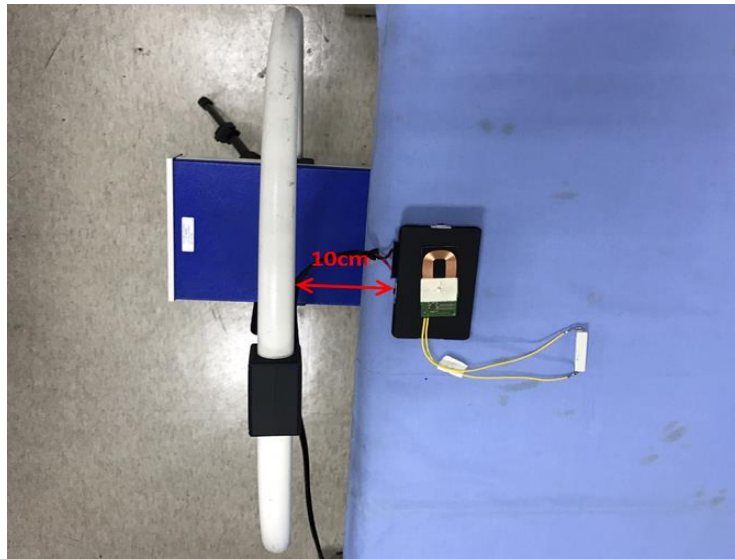



**Front**

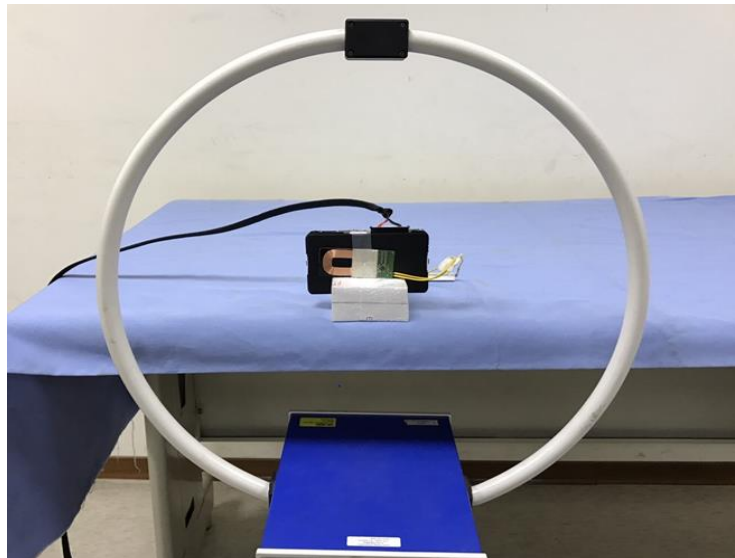

**Rear**

