



SIMATIC Ident

RFID systems
SIMATIC RF600



System Manual

Introduction	1
Safety Information	2
System overview of SIMATIC RF600	3
RF600 system planning	4
Readers	5
Antennas	6
Transponder	7
Integration into networks	8
System diagnostics	9
Accessories	10
Appendix	A

Legal information

Warning notice system

This manual contains notices you have to observe in order to ensure your personal safety, as well as to prevent damage to property. The notices referring to your personal safety are highlighted in the manual by a safety alert symbol, notices referring only to property damage have no safety alert symbol. These notices shown below are graded according to the degree of danger.

 DANGER
indicates that death or severe personal injury will result if proper precautions are not taken.
 WARNING
indicates that death or severe personal injury may result if proper precautions are not taken.
 CAUTION
indicates that minor personal injury can result if proper precautions are not taken.
NOTICE
indicates that property damage can result if proper precautions are not taken.

If more than one degree of danger is present, the warning notice representing the highest degree of danger will be used. A notice warning of injury to persons with a safety alert symbol may also include a warning relating to property damage.

Qualified Personnel

The product/system described in this documentation may be operated only by **personnel qualified** for the specific task in accordance with the relevant documentation, in particular its warning notices and safety instructions. Qualified personnel are those who, based on their training and experience, are capable of identifying risks and avoiding potential hazards when working with these products/systems.

Proper use of Siemens products

Note the following:

 WARNING
Siemens products may only be used for the applications described in the catalog and in the relevant technical documentation. If products and components from other manufacturers are used, these must be recommended or approved by Siemens. Proper transport, storage, installation, assembly, commissioning, operation and maintenance are required to ensure that the products operate safely and without any problems. The permissible ambient conditions must be complied with. The information in the relevant documentation must be observed.

Trademarks

All names identified by ® are registered trademarks of Siemens AG. The remaining trademarks in this publication may be trademarks whose use by third parties for their own purposes could violate the rights of the owner.

Disclaimer of Liability

We have reviewed the contents of this publication to ensure consistency with the hardware and software described. Since variance cannot be precluded entirely, we cannot guarantee full consistency. However, the information in this publication is reviewed regularly and any necessary corrections are included in subsequent editions.

Table of contents

1	Introduction	13
1.1	Preface.....	13
1.2	Abbreviations and naming conventions	14
2	Safety Information	15
2.1	General safety instructions	15
2.2	Safety instructions for third-party antennas as well as for modifications to the RF600 system.....	19
2.3	Safety distance to transmitter antenna	20
2.3.1	Safety distance between transmitter antenna and personnel	20
2.3.2	Minimum distance to antenna in accordance with ETSI	21
2.3.3	Minimum distance to antenna in accordance with FCC	22
3	System overview of SIMATIC RF600	25
3.1	Application areas of RF600	26
3.2	System components	27
3.3	Features	30
4	RF600 system planning	33
4.1	Overview	33
4.2	Possible system configurations	33
4.2.1	Intralogistics scenario	33
4.2.2	Scenario for workpiece identification	36
4.2.3	Goods tracking scenario	37
4.2.4	Scenario incoming goods, distribution of goods and outgoing goods	38
4.3	Antenna configurations	39
4.3.1	Antenna configuration example	40
4.3.2	Possibilities and application areas for antenna configurations	41
4.3.3	Transponder orientation in space	45
4.3.4	Specified minimum and maximum spacing of antennas	46
4.3.5	Reciprocal influence of read points.....	47
4.3.6	Read and write range.....	48
4.3.7	Static/dynamic mode.....	49
4.3.8	Operation of several readers within restricted space	50
4.3.8.1	Using more than one reader	50
4.3.8.2	Optimization of robustness of tag data accesses for readers that are operated simultaneously	50
4.3.8.3	Frequency hopping	51
4.3.9	Guidelines for selecting RFID UHF antennas.....	51
4.3.9.1	Note safety information.....	51
4.3.9.2	Preconditions for selecting RFID UHF antennas	51
4.3.9.3	General application planning	52

4.3.9.4	Types of antenna	53
4.3.9.5	Antenna cables	53
4.4	Minimum distances and maximum ranges	55
4.4.1	Configurations of antenna and transponder	55
4.4.2	Effects of the materials of the mounting surfaces on the range	58
4.4.3	Maximum read/write ranges of transponders	59
4.4.4	Minimum distances between antennas and transponders	65
4.4.5	Influence of electrically conductive walls on the range	65
4.5	Environmental conditions for transponders	66
4.6	The response of electromagnetic waves in the UHF band	66
4.6.1	The effect of reflections and interference	66
4.6.2	Influence of metals	67
4.6.3	Influence of liquids and non-metallic substances	68
4.6.4	Influence of external components	68
4.7	Planning and installation of UHF read points.....	69
4.7.1	Technical basics.....	69
4.7.2	Implementation of UHF RFID installations.....	72
4.7.2.1	Preparation phase.....	72
4.7.2.2	Test phase	73
4.7.2.3	Setting up read points	74
4.7.3	Dealing with field disturbances	77
4.7.3.1	Types and approaches to solutions	77
4.7.3.2	Measures for eliminating field disturbances.....	78
4.8	Chemical resistance of the readers and transponders	80
4.8.1	Readers.....	80
4.8.1.1	Overview of the readers and their housing materials	80
4.8.1.2	Pocan CF2200	81
4.8.2	Transponder	83
4.8.2.1	Overview of the transponders and their housing materials	83
4.8.2.2	Acrylonitrile/butadiene/styrene (ABS)	83
4.8.2.3	Polyamide 12 (PA12)	84
4.8.2.4	Polyamide 6.6 (PA 6.6)	86
4.8.2.5	Polyamide 6.6 GF (PA 6.6 GF)	87
4.8.2.6	Polyethylene terephthalate (PET)	89
4.8.2.7	Polypropylene (PP)	91
4.8.2.8	Polyphenylene sulfide (PPS)	95
4.8.2.9	Polyvinyl chloride (PVC)	96
4.9	Regulations applicable to frequency bands	97
4.10	Guidelines for electromagnetic compatibility (EMC)	97
4.10.1	Overview	97
4.10.2	What does EMC mean?	98
4.10.3	Basic rules.....	99
4.10.4	Propagation of electromagnetic interference	100
4.10.5	Equipotential bonding	102
4.10.6	Cable shielding.....	103

5	Readers	105
5.1	Overview	105
5.2	SIMATIC RF610R	107
5.2.1	Description	107
5.2.1.1	Overview	107
5.2.1.2	Ordering data	108
5.2.1.3	Pin assignment of the power supply interface (X80 24VDC).....	109
5.2.1.4	Pin assignment of the Industrial Ethernet interface (X1 P1).....	110
5.2.1.5	Ground connection.....	110
5.2.2	Planning operation	110
5.2.2.1	Internal antenna	110
5.2.2.2	Interpretation of radiation patterns	115
5.2.3	Installation / mounting	115
5.2.4	Configuration/integration.....	116
5.2.5	Technical specifications	117
5.2.6	Dimension drawing	120
5.2.7	Certificates and approvals	121
5.2.7.1	CE mark	121
5.2.7.2	Country-specific certifications	121
5.2.7.3	FCC information.....	122
5.2.7.4	IC-FCB information	123
5.2.7.5	Other certificates and approvals	123
5.3	SIMATIC RF615R	124
5.3.1	Description	124
5.3.1.1	Overview	124
5.3.1.2	Ordering data	125
5.3.1.3	Pin assignment of the DI/DQ interface (X10 DI/DQ)	126
5.3.1.4	Switching scheme for the DI/DQ interface.....	126
5.3.1.5	Pin assignment of the power supply interface (X80 24VDC).....	128
5.3.1.6	Pin assignment of the Industrial Ethernet interface (X1 P1).....	129
5.3.1.7	Ground connection.....	129
5.3.2	Planning operation	130
5.3.2.1	Internal antenna	130
5.3.2.2	External antenna.....	135
5.3.3	Installing/mounting	136
5.3.4	Configuration/integration.....	137
5.3.5	Technical specifications	138
5.3.6	Dimension drawing	141
5.3.7	Certificates and approvals	142
5.3.7.1	CE mark	142
5.3.7.2	Country-specific certifications	142
5.3.7.3	FCC information.....	143
5.3.7.4	IC-FCB information	144
5.3.7.5	Other certificates and approvals	144
5.4	SIMATIC RF650R	145
5.4.1	Description	145
5.4.1.1	Overview	145
5.4.1.2	Ordering data	146
5.4.1.3	Pin assignment of the DI/DQ interface (X10 DI/DQ)	147
5.4.1.4	Switching scheme for the DI/DQ interface.....	148

5.4.1.5	Pin assignment of the power supply interface (X80 24VDC).....	153
5.4.1.6	Pin assignment of the Industrial Ethernet interface (X1 P1).....	155
5.4.1.7	Grounding connection.....	155
5.4.2	Planning operation.....	156
5.4.2.1	Antenna/read point configurations.....	156
5.4.3	Installation/mounting.....	157
5.4.4	Configuration/integration.....	161
5.4.5	Technical specifications.....	162
5.4.6	Dimension drawing.....	165
5.4.7	Certificates and approvals.....	166
5.4.7.1	FCC information.....	168
5.4.7.2	IC-FCB information.....	169
5.5	SIMATIC RF680R.....	170
5.5.1	Description.....	170
5.5.1.1	Overview.....	170
5.5.1.2	Ordering data.....	171
5.5.1.3	Pin assignment of the DI/DQ interface (X10 DI/DQ).....	172
5.5.1.4	Switching scheme for the DI/DQ interface.....	173
5.5.1.5	Pin assignment of the power supply interface (X80 24VDC).....	178
5.5.1.6	Pin assignment of the Industrial Ethernet interface (X1 P1; X1 P2).....	180
5.5.1.7	Grounding connection.....	180
5.5.2	Planning operation.....	181
5.5.2.1	Antenna/read point configurations.....	181
5.5.3	Installation/mounting.....	182
5.5.3.1	Mounting/Installation.....	183
5.5.4	Configuration/integration.....	186
5.5.5	Technical specifications.....	187
5.5.6	Dimension drawing.....	190
5.5.7	Certificates and approvals.....	191
5.5.7.1	FCC information.....	193
5.5.7.2	IC-FCB information.....	194
5.6	SIMATIC RF685R.....	195
5.6.1	Description.....	195
5.6.1.1	Overview.....	195
5.6.1.2	Ordering data.....	196
5.6.1.3	Pin assignment of the DI/DQ interface (X10 DI/DQ).....	197
5.6.1.4	Switching scheme for the DI/DQ interface.....	198
5.6.1.5	Pin assignment of the power supply interface (X80 24VDC).....	203
5.6.1.6	Pin assignment of the Industrial Ethernet interface (X1 P1; X1 P2).....	205
5.6.1.7	Grounding connection.....	205
5.6.2	Planning operation.....	206
5.6.2.1	Internal antenna.....	206
5.6.2.2	External antenna.....	215
5.6.3	Installation/mounting.....	216
5.6.4	Configuration/integration.....	220
5.6.5	Technical specifications.....	221
5.6.6	Dimension drawing.....	224
5.6.7	Certificates and approvals.....	225
5.6.7.1	FCC information.....	227
5.6.7.2	IC-FCB information.....	228

5.7	SIMATIC RF650M.....	229
5.7.1	Description	229
5.7.2	Field of application and features.....	229
6	Antennas	231
6.1	Overview	231
6.2	SIMATIC RF615A	233
6.2.1	Characteristics	233
6.2.2	Ordering data	234
6.2.3	Mounting	234
6.2.4	Connecting the antenna.....	235
6.2.5	Antenna parameter assignment.....	236
6.2.6	Antenna patterns.....	238
6.2.6.1	Alignment of transponders to the antenna.....	238
6.2.6.2	Antenna pattern ETSI	241
6.2.6.3	Antenna pattern FCC	244
6.2.6.4	Interpretation of directional radiation patterns	247
6.2.7	Technical data.....	248
6.2.8	Dimension drawing	250
6.2.9	Certificates & approvals	251
6.3	SIMATIC RF620A	252
6.3.1	Characteristics	252
6.3.2	Ordering data	253
6.3.3	Installation.....	253
6.3.4	Connecting the antenna.....	254
6.3.4.1	Bending radii and bending cycles of the cable	254
6.3.5	Antenna parameter assignment.....	255
6.3.6	Antenna patterns.....	257
6.3.6.1	Alignment of transponders to the antenna.....	257
6.3.6.2	Antenna pattern ETSI	260
6.3.6.3	Antenna pattern FCC	263
6.3.6.4	Interpretation of directional radiation patterns	266
6.3.7	Technical data.....	267
6.3.8	Dimension drawing	269
6.3.9	Approvals & certificates	270
6.4	SIMATIC RF640A	271
6.4.1	Characteristics	271
6.4.2	Ordering data	272
6.4.3	Installation.....	272
6.4.4	Connecting the antenna.....	273
6.4.4.1	Bending radii and bending cycles of the cable	274
6.4.5	Antenna parameter assignment.....	274
6.4.5.1	Setting RF640A parameters for RF650R.....	274
6.4.5.2	Setting RF640A parameters for RF680R/RF685R	276
6.4.6	Antenna patterns.....	278
6.4.6.1	Antenna radiation patterns in the ETSI frequency band.....	278
6.4.6.2	Antenna radiation patterns in the FCC frequency band	283
6.4.6.3	Interpretation of directional radiation patterns	288
6.4.7	Technical data.....	289
6.4.8	Dimension drawing	291
6.4.9	Approvals & certificates	292

6.5	SIMATIC RF642A	293
6.5.1	Characteristics	293
6.5.2	Ordering data	294
6.5.3	Installation	294
6.5.4	Connecting the antenna	295
6.5.4.1	Bending radii and bending cycles of the cable	296
6.5.5	Antenna parameter assignment	297
6.5.5.1	Alignment of transponders to the antenna	297
6.5.5.2	RF642A parameter assignment	300
6.5.6	Antenna patterns	302
6.5.6.1	Antenna radiation patterns in the ETSI frequency band	302
6.5.6.2	Antenna radiation patterns in the FCC frequency band	304
6.5.6.3	Interpretation of directional radiation patterns	306
6.5.7	Technical data	307
6.5.8	Dimension drawing	309
6.5.9	Approvals & certificates	310
6.6	SIMATIC RF650A	311
6.6.1	Characteristics	311
6.6.2	Ordering data	312
6.6.3	Installation	312
6.6.4	Connecting the antenna	313
6.6.4.1	Bending radii and bending cycles of the cable	314
6.6.5	Antenna parameter assignment	314
6.6.6	Antenna patterns	316
6.6.6.1	Antenna patterns in the ETSI frequency band	317
6.6.6.2	Antenna patterns in the FCC frequency band	319
6.6.6.3	Interpretation of directional radiation patterns	321
6.6.7	Technical data	322
6.6.8	Dimension drawing	324
6.6.9	Approvals & certificates	325
6.7	SIMATIC RF660A	326
6.7.1	Characteristics	326
6.7.2	Ordering data	327
6.7.3	Installation	327
6.7.4	Connecting the antenna	328
6.7.4.1	Bending radii and bending cycles of the cable	328
6.7.5	Antenna parameter assignment	329
6.7.6	Antenna patterns	331
6.7.7	Technical data	334
6.7.8	Dimension drawing	336
6.7.9	Approvals & certificates	337
6.8	SIMATIC RF680A	338
6.8.1	Characteristics	338
6.8.2	Ordering data	340
6.8.3	Installation	340
6.8.4	Connecting the antenna	341
6.8.4.1	Bending radii and bending cycles of the cable	342
6.8.5	Antenna parameter assignment	343
6.8.6	Antenna patterns	345
6.8.6.1	Antenna patterns in the ETSI frequency band	346
6.8.6.2	Antenna patterns in the FCC frequency band	350

6.8.6.3	Interpretation of directional radiation patterns	354
6.8.7	Technical data.....	355
6.8.8	Dimension drawing	357
6.8.9	Approvals & certificates	358
7	Transponder	359
7.1	Overview	359
7.1.1	Mode of operation of transponders	359
7.1.2	Transponder classes and generations.....	360
7.1.3	Electronic Product Code (EPC)	360
7.1.4	SIMATIC memory configuration of the RF600 transponders and labels	362
7.1.5	Storage and transportation roll goods.....	363
7.2	SIMATIC RF630L Smartlabel	364
7.2.1	Features	364
7.2.2	Ordering data	365
7.2.3	Technical data.....	366
7.2.4	Dimension drawings.....	374
7.2.5	Certificates and approvals	377
7.3	SIMATIC RF642L Smartlabel	378
7.3.1	Features	378
7.3.2	Ordering data	378
7.3.3	Technical specifications	379
7.3.4	Dimension drawing	381
7.4	SIMATIC RF690L Smartlabel	382
7.4.1	Characteristics	382
7.4.2	Ordering data	382
7.4.3	Memory organization	383
7.4.4	Technical specifications	383
7.4.5	Dimension drawing	385
7.4.6	Certificates and approvals	386
7.5	SIMATIC RF610T	387
7.5.1	Features	387
7.5.2	Ordering data	387
7.5.3	Technical specifications	388
7.5.4	Dimension drawing	390
7.5.5	Certificates and approvals	390
7.6	SIMATIC RF610T ATEX.....	391
7.6.1	Features	391
7.6.2	Ordering data	392
7.6.3	Use of the transponder in hazardous areas.....	392
7.6.3.1	Use of the transponder in hazardous areas for gases.....	394
7.6.3.2	Use of the transponder in hazardous areas for dusts.....	395
7.6.4	Technical specifications	396
7.6.5	Dimension drawing	398
7.6.6	Certificates and approvals	398
7.7	SIMATIC RF620T	399
7.7.1	Characteristics	399
7.7.2	Ordering data	400
7.7.3	Planning the use	400

7.7.3.1	Range when mounted on flat metallic carrier plates	400
7.7.3.2	Range when mounted on non-metallic carrier materials	401
7.7.4	Technical specifications	402
7.7.5	Dimension drawing	404
7.7.6	Certificates and approvals	405
7.8	SIMATIC RF625T	406
7.8.1	Characteristics	406
7.8.2	Ordering data	407
7.8.3	Planning the use	407
7.8.3.1	Optimum antenna/transponder positioning with planar mounting of the transponder on metal	407
7.8.3.2	Range when mounted on flat metallic carrier plates	408
7.8.3.3	Range when mounted on non-metallic carrier materials	409
7.8.3.4	Mounting in metal	409
7.8.4	Technical specifications	410
7.8.5	Dimension drawing	412
7.8.6	Certificates and approvals	412
7.9	SIMATIC RF630T	413
7.9.1	Characteristics	413
7.9.2	Ordering data	414
7.9.3	Planning application	414
7.9.3.1	Optimum antenna/transponder positioning	414
7.9.3.2	Range when mounted on flat metallic carrier plates	416
7.9.4	Technical specifications	417
7.9.5	Dimension drawing	419
7.9.6	Certificates and approvals	420
7.10	SIMATIC RF640T	421
7.10.1	Characteristics	421
7.10.2	Ordering data	422
7.10.3	Planning the use	422
7.10.3.1	Optimum antenna/transponder positioning with plane mounting of the transponder on metal	422
7.10.3.2	Range when mounted on flat metallic carrier plates	423
7.10.3.3	Range when mounted on non-metallic carrier materials	424
7.10.3.4	Use of the transponder in hazardous areas	424
7.10.3.5	Use of the transponder in hazardous areas for gases	425
7.10.3.6	Use of the transponder in hazardous areas for dusts	427
7.10.4	Technical specifications	430
7.10.5	Dimension drawing	433
7.10.6	Certificates and approvals	434
7.11	SIMATIC RF645T	435
7.11.1	Characteristics	435
7.11.2	Ordering data	435
7.11.3	Technical specifications	436
7.11.4	Dimension drawing	438
7.11.5	Certificates and approvals	440
7.12	SIMATIC RF680T	441
7.12.1	Characteristics	441
7.12.2	Ordering data	442

7.12.3	Planning the use	442
7.12.3.1	Optimum antenna/transponder positioning with plane mounting of the transponder on metal	442
7.12.3.2	Range when mounted on flat metallic carrier plates.....	443
7.12.3.3	Range when mounted on non-metallic carrier materials	443
7.12.3.4	Use of the transponder in the hazardous area	444
7.12.3.5	Use of the transponder in the hazardous area for gases	444
7.12.3.6	Use of the transponder in the hazardous area for dusts	448
7.12.4	Technical specifications	451
7.12.5	Dimension drawing	453
7.12.6	Certificates and approvals	454
7.13	SIMATIC RF682T	455
7.13.1	Characteristics	455
7.13.2	Ordering data	456
7.13.3	Planning operation	456
7.13.3.1	Optimum antenna/transponder positioning with plane mounting of the transponder on metal	456
7.13.3.2	Note on installation	457
7.13.3.3	Range when mounted on flat metallic carrier plates.....	457
7.13.4	Technical specifications	458
7.13.5	Dimension drawing	460
7.13.6	Certificates and approvals	461
8	Integration into networks	463
8.1	Overview of parameterization of RF600 reader.....	463
8.2	Integration in IT networks via the user application	464
8.3	Integration in control networks.....	464
9	System diagnostics	467
9.1	Diagnostics via the LED displays of the reader	467
9.1.1	How the LED status display works	471
9.1.2	Diagnostics via LED operating display	472
9.2	XML/PLC error messages	473
10	Accessories	481
10.1	Wide-range power supply unit for SIMATIC RF systems	481
10.1.1	Features	481
10.1.2	Scope of supply	481
10.1.3	Ordering data	482
10.1.4	Safety Information.....	483
10.1.5	Mounting & connecting	485
10.1.6	Pin assignment of DC outputs and mains connection	488
10.1.7	Technical specifications	488
10.1.8	Dimension drawing	491
10.1.9	Certificates and approvals	492
10.2	Power splitter for RF600 systems.....	494
10.2.1	Characteristics	494
10.2.2	Ordering data	494
10.2.3	Example of a configuration	495
10.2.4	Technical specifications.....	495

10.2.5	Dimension drawing	496
10.3	Reader and antenna holders	497
10.3.1	Overview	497
10.3.2	Ordering data	497
10.3.3	Mounting with the SIMATIC antenna holder	497
10.3.4	Dimension drawing	499
A	Appendix	503
A.1	Certificates & approvals	503
A.2	Service & support.....	506

Introduction

1.1 Preface

Purpose of this document

This system manual contains the information needed to plan and configure the RF600 system.

It is intended both for programming and testing/debugging personnel who commission the system themselves and connect it with other units (automation systems, further programming devices), as well as for service and maintenance personnel who install expansions or carry out fault/error analyses.

Scope of this documentation

This documentation is valid for all supplied versions of the SIMATIC RF600 system and describes the state of delivery as of 06/2019. If you are using older firmware versions, please refer to the 08/2011 edition of the documentation.

Registered trademarks

SIMATIC®, SIMATIC RF®, MOBY®, RF MANAGER® and SIMATIC Sensors® are registered trademarks of Siemens AG.

Recycling and disposal



The products are low in harmful substances, can be recycled and meet the requirements of the Directive 2012/19/EU for disposal of waste electrical and electronic equipment (WEEE).

Do not dispose of the products at public disposal sites.

For environmentally compliant recycling and disposal of your electronic waste, please contact a company certified for the disposal of electronic waste or your Siemens representative.

Note the different country-specific regulations.

History

Currently released versions of the SIMATIC RF600 system manual:

Edition	Comment
11/2005	First edition
...	...
10/2015	Approval for the readers RF650R, RF680R, and RF685R
12/2015	New antennas RF650A and RF680A
10/2016	Revision of the transponder sections
02/2018	Expansion of the documentation by the following: <ul style="list-style-type: none">• RF615A antenna• RF645T, RF682T transponders
11/2018	Expansion of the documentation by the following: <ul style="list-style-type: none">• Reader SIMATIC RF615R
06/2019	Expansion of the documentation by the following: <ul style="list-style-type: none">• Reader SIMATIC RF610R• Transponder RF630L

Declaration of conformity

The EC declaration of conformity and the corresponding documentation are made available to authorities in accordance with EC directives. Your sales representative can provide these on request.

Observance of installation guidelines

The installation guidelines and safety instructions given in this documentation must be followed during commissioning and operation.

1.2 Abbreviations and naming conventions

Abbreviations and naming conventions

The following terms/abbreviations are used synonymously in this document:

Reader	Write/read device (SLG)
Transponder, tag	Data carrier, mobile data storage, (MDS)
Communications module (CM)	Interface module (ASM)

Safety Information

2.1 General safety instructions

Note

Heed the safety notices

Please observe the safety instructions on the back cover of this documentation.

SIMATIC RFID products comply with the salient safety specifications to VDE/DIN, IEC, EN, UL and CSA. If you have questions about the admissibility of the installation in the designated environment, please contact your service representative.

WARNING

Safety extra low voltage

The equipment is designed for operation with Safety Extra-Low Voltage (SELV) by a Limited Power Source (LPS). (This does not apply to 100 V ... 240 V devices.)

This means that only safety-extra low voltage (SELV) with a limited power source (LPS) complying with IEC 60950-1 / EN 60950-1 / VDE 0805-1 may be connected to the power supply terminals or the power supply unit for the equipment power supply must comply with NEC Class 2, according to the National Electrical Code (r) (ANSI / NFPA 70).

There is an additional requirement if devices are operated with a redundant power supply:

If the equipment is connected to a redundant power supply (two separate power supplies), both must meet these requirements.

WARNING

Opening the device

Do not open the device when energized.

NOTICE

Alterations not permitted

Alterations to the devices are not permitted.

Failure to observe this requirement shall constitute a revocation of the radio equipment approval, CE approval and manufacturer's warranty.

Operating temperature

 **CAUTION**

Increased temperatures on the lower casing

Note that the lower casing of the readers is made of metal. This means that temperatures can occur on the lower casing that are higher than the maximum permitted operating temperature.

 **CAUTION**

Do not expose the readers to direct sunlight

Note that the readers must not be exposed to direct sunlight. Direct sunlight can lead to the maximum permitted operating temperature being exceeded.

Overvoltage protection

NOTICE

Protection of the external 24 VDC voltage supply

If the module is supplied via extensive 24 V supply lines or networks, interference by strong electromagnetic pulses on the supply lines is possible, e.g. from lightning or the switching of large loads.

The connector for the 24 VDC external power supply is not protected against strong electromagnetic pulses. Make sure that any cables liable to lightning strikes are fitted with suitable overvoltage protection.

Repairs

 **WARNING**

Repairs only by authorized qualified personnel

Repairs may only be carried out by authorized qualified personnel. Unauthorized opening of and improper repairs to the device may result in substantial damage to equipment or risk of personal injury to the user.

Lightning protection

 **CAUTION**

Installation only in protected areas

Antennas and readers can be installed in the protected part of a building. When implementing your lightning protection concept, make sure you adhere to the VDE 0182 or IEC 62305 standards.

When installing outdoors, we recommend that you protect the readers/antennas from the weather with a box.

The antenna RF650A must not be installed in the (protected) outdoor area.

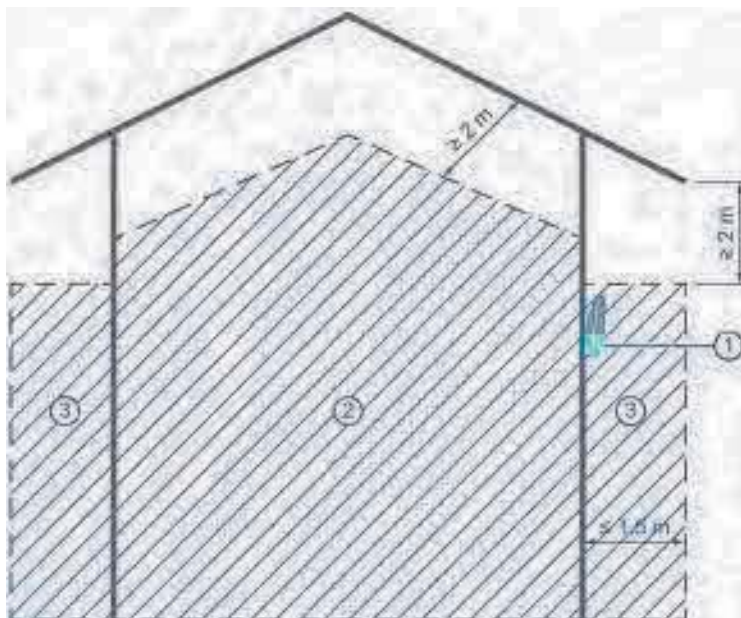

- ① Antenna or reader
- ② Protected area (indoors); grounding is not necessary here.
- ③ Protected area (outdoors); grounding is not necessary here.

Figure 2-1 Mounting the reader in protected areas

System expansion

Only install system expansion devices designed for this device. If you install other upgrades, you may damage the system or violate the safety requirements and regulations for radio frequency interference suppression. Contact your technical customer service or where you purchased your device to find out which system expansions are suitable for installation.

Note

Warranty conditions

If you cause system defects by improperly installing or exchanging system expansion devices, the warranty becomes void.

Security information

Siemens provides products and solutions with industrial security functions that support the secure operation of plants, systems, machines and networks.

In order to protect plants, systems, machines and networks against cyber threats, it is necessary to implement – and continuously maintain – a holistic, state-of-the-art industrial security concept. Siemens' products and solutions constitute one element of such a concept.

Customers are responsible for preventing unauthorized access to their plants, systems, machines and networks. Such systems, machines and components should only be connected to an enterprise network or the internet if and to the extent such a connection is necessary and only when appropriate security measures (e.g. firewalls and/or network segmentation) are in place.

For additional information on industrial security measures that may be implemented, please visit

Link: (<http://www.siemens.com/industrialsecurity>)

Siemens' products and solutions undergo continuous development to make them more secure. Siemens strongly recommends that product updates are applied as soon as they are available and that the latest product versions are used. Use of product versions that are no longer supported, and failure to apply the latest updates may increase customers' exposure to cyber threats.

To stay informed about product updates, subscribe to the Siemens Industrial Security RSS Feed under

Link: (<http://www.siemens.com/industrialsecurity>)

2.2 Safety instructions for third-party antennas as well as for modifications to the RF600 system

Always observe the following general safety instructions before selecting a component from a different vendor:

The manufacturer accepts no responsibility for functional suitability or legal implications for the installation of third-party components.

Note

Alterations not permitted

Alterations to the devices are not permitted. If this is not adhered to, the radio approvals, the relevant country approvals (e.g. CE or FCC) and the manufacturer's guarantee are invalidated.

Modifications to the SIMATIC RF600 system

NOTICE

Damage to the system

<p>If you install unsuitable or unapproved extensions, you may damage the system or violate the safety requirements and regulations for radio frequency interference suppression. Contact your technical customer service or where you purchased your device to find out which system expansions are suitable for installation.</p>

NOTICE

Loss of warranty

<p>If you cause defects on the SIMATIC RF600 system by improperly installing or exchanging system expansions, the warranty becomes void.</p>
--

Note

Loss of validity for type tests and certificates

SIMATIC RFID products comply with the salient safety specifications to VDE/DIN, IEC, EN, UL and CSA. When using RFID components that do not belong to the RF600 range of products, all type tests as well as all certificates relevant to the RF600, such as CE, FCC, UL, CSA are invalidated.

Note

User responsibility for modified product

As a user of the modified product, you accept responsibility for use of the complete RFID product comprising both SIMATIC RF600 components and third-party RFID components. This particularly applies to modification or replacement of:

- Antennas
 - Antenna cables
 - readers
 - Power supply units with connection cables
-

2.3 Safety distance to transmitter antenna

2.3.1 Safety distance between transmitter antenna and personnel

For antenna configurations where it is possible to be briefly or constantly within the transmission range of the antennas, as in loading ramps, for example, minimum distances must be maintained.

Limits

The ICRP (International Commission of Radiological Protection) has worked out limit values for human exposure to HF fields that are also recommended by the ICNIRP (International Commission of Non Ionizing Radiological Protection). In German legislation on emissions (since 1997), the following limit values apply. These can vary according to frequency:

Frequency f [MHz]	Electrical field strength E [V/m]	Magnetic field strength H [A/m]
10 - 400	27,5	0,073
400 - 2.000	$1.375 \times f^{1/2}$	$0.0037 \times f^{1/2}$
2.000 - 300.000	61	0,16

The limit values for the 900 MHz reader antenna alternating field are thus:

Electrical field strength: $E = 41.25 \text{ V/m}$

Magnetic field strength: $H = 0.111 \text{ A/m}$

HF power density: $E \times H = 4.57 \text{ W/m}^2$

2.3.2 Minimum distance to antenna in accordance with ETSI

At a transmission frequency of 900 MHz, the wavelength of the electromagnetic wave λ is approximately 0.34 m. For distances less than 1λ in the near field, the electrical field strength ($1/r$) diminishes exponentially to the power three over distance, and for distances greater than 1λ , it diminishes exponentially to the power two over distance.

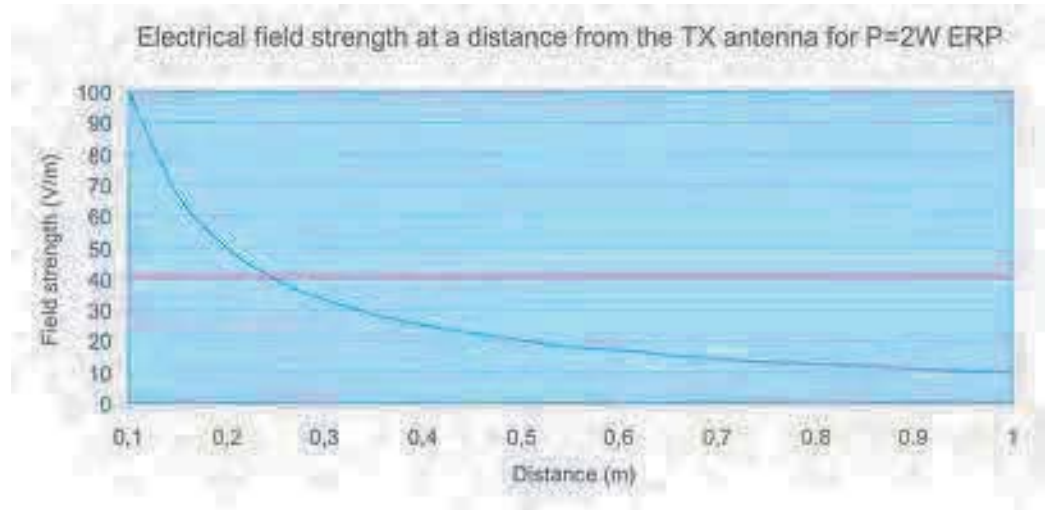

The horizontal line at 41.25 V/m marks the "safety limit value".

For the maximum permitted transmit power ($1/r^2$) in accordance with ETSI (2 W ERP), the "safety distance" is $d = 0.24$ m. This means that personnel should not remain closer than 24 cm to the transmitter antenna for extended periods (for several hours without interruption). Remaining within the vicinity of the antenna for a brief period, even for repeated periods (at a distance < 0.24 m), is harmless according to current knowledge.

Distance to transmitter antenna [m]	Field strength [V/m]	% of limit value
1	10	24
5	2	5

If the transmitter power is set lower than the highest permissible value (2 watts ERP), the "safety distance" reduces correspondingly.

The values for this are as follows:

Radiated power ERP [W]	Safety distance to transmitter antenna [m]
2.0	0.24
1.0	0.17
0.5	0.12

Note

Reduced maximum radiated power with RF600 readers

SIMATIC RF610R and RF615R (ETSI) readers have a maximum transmit power of 400 mW. The radiated power depends on the antenna cable and the antenna used, but must not exceed 2 W ERP.

The SIMATIC RF650R (ETSI) reader has a maximum transmit power of 1 W. The radiated power therefore depends on the antenna cable and the antenna used, but must not exceed 2 W ERP.

The SIMATIC RF680R (ETSI) reader has a maximum transmit power of 2 W. The radiated power therefore depends on the antenna cable and the antenna used, but must not exceed 2 W ERP.

The SIMATIC RF685R (ETSI) reader has a maximum radiated power of 2 W ERP. The safety clearance is therefore at least 0.24 m.

When using Siemens products and with suitable configuration via the WBM, the high limits cannot be exceeded.

2.3.3 Minimum distance to antenna in accordance with FCC

For the maximum permitted radiated power in accordance with FCC (4 W EIRP), the "safety distance" is $d = 0.26$ m. This means that personnel should not remain closer than 26 cm to the transmitter antenna for extended periods (several hours without interruption). Remaining within the vicinity of the antenna for brief period, even repeated periods (at a distance < 0.26 m) is harmless to health according to current knowledge.

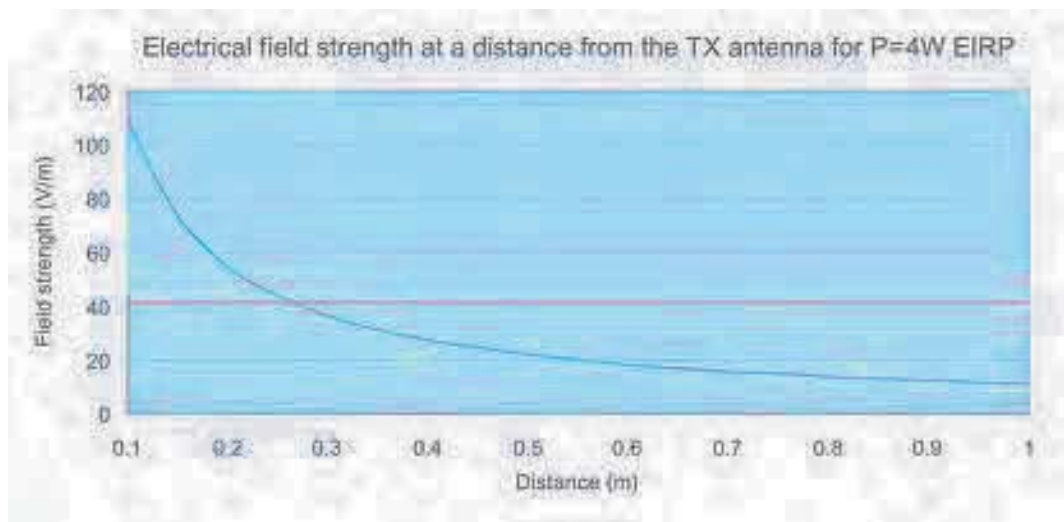

The horizontal line at 41.25 V/m marks the "safety limit value".

Distance to transmitter antenna [m]	Feld strength [V/m]	% of limit value
1	10.9	26
5	2.2	5.3

If the transmit power is set lower than the highest permitted value (4 W EIRP), the "safety distance" reduces correspondingly.

The values for this are as follows:

Radiated power EIRP [W]	Safety distance to transmitter antenna [m]
4.0	0.26
<2.5	>0.20

Generally a safety distance of at least 0.2 m should be maintained.

Note

Reduced maximum radiated power with RF600 readers

SIMATIC RF610R and RF615R (FCC) readers have a maximum transmit power of 400 mW. The radiated power depends on the antenna cable and the antenna used, but must not exceed 2 W ERP.

The SIMATIC RF650R (FCC) reader has a maximum transmit power of 1 W. The radiated power therefore depends on the antenna cable and the antenna used, but must not exceed 4 W EIRP.

The SIMATIC RF680R (FCC) reader has a maximum transmit power of 2 W. The radiated power therefore depends on the antenna cable and the antenna used, but must not exceed 4 W EIRP.

The SIMATIC RF685R (CC) reader has a maximum transmit power of 2 W. This means that the safety distance is at least 0.12 m.

When using Siemens products and with suitable configuration via the WBM, the high limits cannot be exceeded.

System overview of SIMATIC RF600

SIMATIC RF600 is an identification system that operates in the UHF range. UHF technology supports large write/read distances with passive transponders.

The general automation and IT structure of a company is shown in the following figure. This comprises several different levels that are described in detail below.

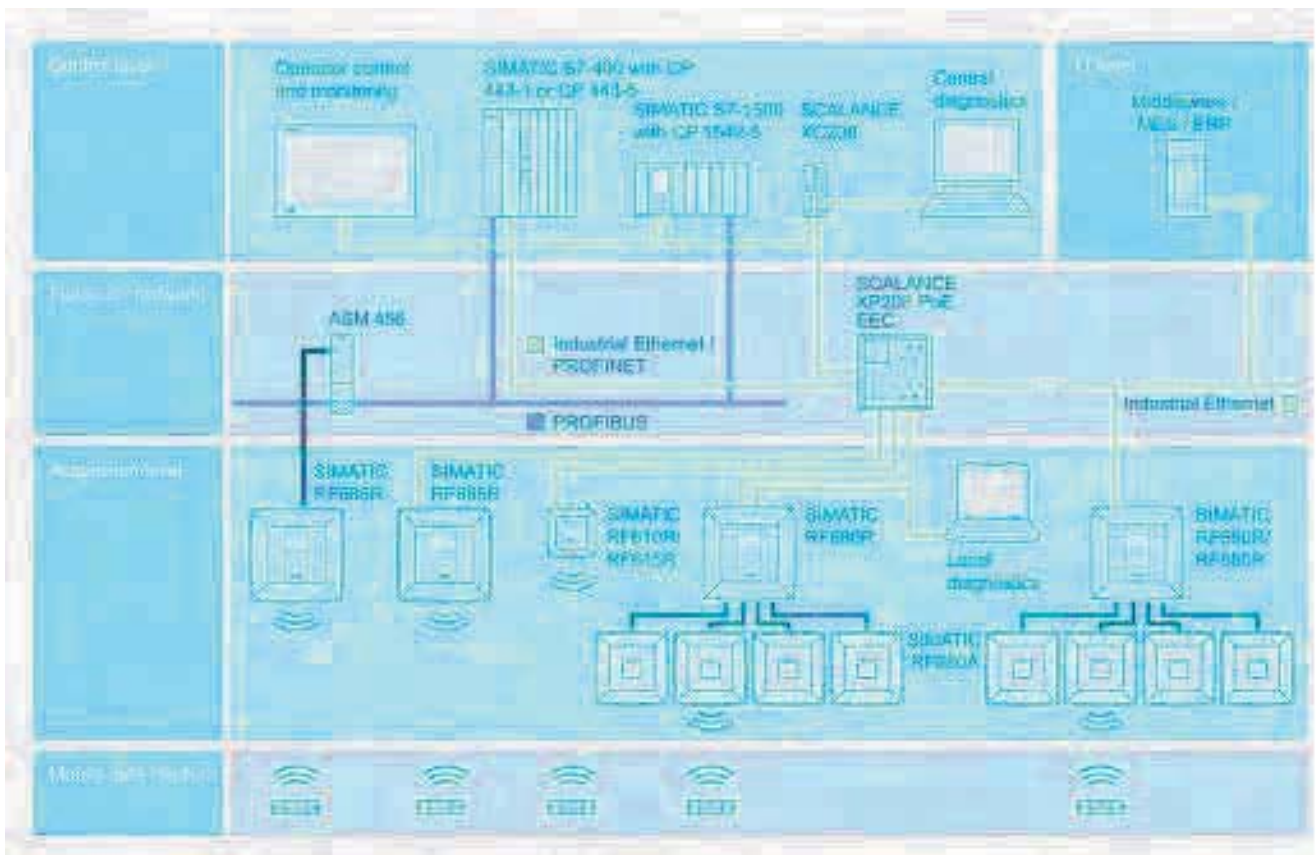

Figure 3-1 System overview SIMATIC RF600 with RF610R, RF615R, RF650R, RF680R, RF685R

- **Acquisition level**

This level contains the RFID readers that read the appropriate transponder data and transfer it to the next higher level.

- **Control level**

At the control level, the RFID data is collected, preprocessed and made available to the production control and business administration control levels for further processing.

- **IT level**

The Manufacturing Execution System (MES) closes the gap between the data that arises in the automation environment (control level) and the logistic and commercial processes

of the company (business administration control). MES solutions are used, for example, for defining and performing production processes.

3.1 Application areas of RF600

RFID (radio frequency identification) permits continuous identification, tracking and documentation of all delivered, stocked and shipped goods in the incoming goods, warehouse, production, production logistics and distribution departments. A small data medium - referred to as SmartLabel, transponder or tag - is attached to every item, package or pallet, and contains all important information. The data medium receives the power it requires via an antenna which is also used for data transmission.

3.2 System components

Table 3- 1 System components of the RF600 product series

Product photo	Description
	<p>SIMATIC RF610R</p> <p>RF610R reader is suitable for applications in production logistics and distribution. It is characterized by a very compact size - with reduced transmit power – as well as an internal antenna.</p> <p>It is integrated for distribution via Ethernet with the XML protocol or OPC UA. EtherNet/IP, PROFINET and PROFIBUS are available for integration in production logistics.</p>
	<p>SIMATIC RF615R</p> <p>RF615R reader is suitable for applications in production logistics and distribution. It is characterized by a very compact size - with reduced transmit power – as well as an internal antenna.</p> <p>It is integrated for distribution via Ethernet with the XML protocol or OPC UA. EtherNet/IP, PROFINET and PROFIBUS are available for integration in production logistics. It is equipped with an integrated antenna and has a connector for an external antenna.</p>
	<p>SIMATIC RF650R</p> <p>The RF650R reader is suitable for applications in logistics. It is integrated via Ethernet with the XML protocol or OPC UA. It has 4 connectors for external antennas.</p>
	<p>SIMATIC RF680R</p> <p>The RF680R reader is suitable for applications in production logistics and distribution. It is integrated for distribution via Ethernet with the XML protocol or OPC UA. For integration in production logistics PROFINET, EtherNet/IP or PROFIBUS are available. As an alternative, integration can also be via PROFIBUS via the serial interface. It has 4 connectors for external antennas.</p>
	<p>SIMATIC RF685R</p> <p>The RF685R reader is suitable for applications in production logistics and distribution. It is integrated for distribution via Ethernet with the XML protocol or OPC UA. For integration in production logistics PROFINET, EtherNet/IP or PROFIBUS are available. As an alternative, integration can also be via PROFIBUS via the serial interface. It is equipped with an integrated antenna with switchable polarization and has a connector for an external antenna.</p>

3.2 System components

Product photo	Description
	<p>SIMATIC RF650M</p> <p>The RF650M mobile reader expands the identification system RF600 with a powerful handheld terminal for applications in the areas of logistics, production and service. In addition, it is an indispensable aid for commissioning and testing.</p>
	<p>SIMATIC RF615A and RF620A</p> <p>SIMATIC RF615A and RF620A are linear antennas with a very compact design suitable for industry. They are suitable for UHF transponders with normal (far field) antenna characteristics.</p>
	<p>SIMATIC RF640A</p> <p>The SIMATIC RF640A is a circular antenna of medium size for universal applications, for example material flow and logistics systems.</p>
	<p>SIMATIC RF642A</p> <p>SIMATIC RF642A is a linear antenna of medium size for environments where a lot of metal occurs.</p>
	<p>SIMATIC RF650A</p> <p>SIMATIC RF650A is a circular antenna of medium size for universal use in industrial applications in production and logistics.</p>

Product photo	Description
	<p>SIMATIC RF660A SIMATIC RF660A is a powerful circular antenna for production and logistics applications.</p>
	<p>SIMATIC RF680A SIMATIC RF680A is an antenna whose polarization can be changed (circular, linear horizontal or linear vertical) of medium size for universal use in industrial applications in production and logistics.</p>
	<p>RF600 transponders The RF600 transponder family provides the right solution for every application: RF610T ISO Card is a flexible card suitable for numerous applications. The transponders RF620T, RF625T, RF630T, RF640T and RF645T are designed specially for industrial requirements. They are very rugged and highly resistant to detergents. The RF640T can also be mounted directly on metal. The transponders RF680T and RF682T were developed specifically for use in high temperatures up to 220° C. In the area of Smartlabels, a comprehensive spectrum of competitively priced labels is available for the widest range of requirements. The heat-resistant smart label RF690L can resist temperatures up to 230 °C or 160 °C and is therefore ideally suited to identification tasks in the paint shop/drying area.</p>

3.3 Features

The RF600 identification system has the following performance features:

Table 3- 2 Features of the RF600 RFID system

Type	Contactless RFID (Radio Frequency IDentification) system in the UHF band
Transmission frequency	<ul style="list-style-type: none"> • ETSI: 865 to 868 MHz • FCC: 902 to 928 MHz • CMIIT: 920.625 to 924.375 MHz • ARIB (STD-T106): 916.8 MHz to 920.4 MHz • ARIB (STD-T107): 920.4 to 923.4 MHz
Standards	ISO 18000-62, ISO 18000-63

Table 3- 3 Features of the RF600 readers

Reader	Antennas	Read/write distance ¹⁾	Interface
RF610R	1 x internal antenna	< 1 m	Ethernet, EtherNet/IP, OPC UA, PROFINET and PROFIBUS
RF615R	1 x internal antenna 1 x antenna connector for external antennas	Internal antenna: < 1 m External antenna: < 3 m	Ethernet, EtherNet/IP, OPC UA, PROFINET and PROFIBUS
RF650R	4 x antenna connectors for external antennas	< 8 m	Ethernet, OPC UA
RF680R	4 x antenna connectors for external antennas	< 8 m	Ethernet, EtherNet/IP, OPC UA, PROFINET and PROFIBUS
RF685R	1 x internal antenna 1 x antenna connector for external antennas	Internal antenna: < 7 m External antenna < 8 m	Ethernet, EtherNet/IP, OPC UA, PROFINET and PROFIBUS

¹⁾ Depends on the connected antenna and the transponder being used

Certificates

RF600 readers support the following certificates and approvals:

- RF610R certificate (<https://support.industry.siemens.com/cs/ww/en/ps/25390/cert>)
- RF615R certificates (<https://support.industry.siemens.com/cs/ww/en/ps/25391/cert>)
- RF650R certificates (<https://support.industry.siemens.com/cs/ww/en/ps/15085/cert>)
- RF680R/RF685R certificates (<https://support.industry.siemens.com/cs/ww/en/ps/15088/cert>)

Table 3- 4 Characteristics of the RF650M mobile reader

Transmission frequency	<ul style="list-style-type: none"> • ETSI: 865 to 868 MHz • FCC: 902 to 928 MHz • CMIIT: 920 to 925 MHz
Read/write distance	3 m
Standards	ISO 18000-63

Table 3- 5 Characteristics of the transponders

Version	Transponders/Smartlabels	Designation	Standards supported
	Smartlabel	RF630L RF640L RF690L	ISO 18000-62 ISO 18000-63
	ISO card Container tag Disc tag Powertrain tag Tool tag On Metal Tag Heat-resistant tag Heat-resistant tag	RF610T RF620T RF625T RF630T RF640T (Gen 2) RF645T RF680T RF682T	ISO 18000-62 ISO 18000-63

RF600 system planning

4.1 Overview

You should observe the following criteria for implementation planning:

- Possible system configurations
- Antenna configurations
- Environmental conditions for transponders
- The response of electromagnetic waves in the UHF band
- Regulations applicable to frequency bands
- EMC Directives

4.2 Possible system configurations

The SIMATIC RF600 system is characterized by a high level of standardization of its components. This means that the system follows the TIA principle throughout: Totally Integrated Automation. It provides maximum transparency at all levels with its reduced number of interfaces. This ensures optimum interaction between all system components.

The RF600 system with its flexible components offers many possibilities for system configuration. This section shows you how you can use the RF600 components on the basis of various example scenarios.

4.2.1 Intralogistics scenario

This scenario describes the transport of material via conveyor systems that are made up of large numbers of standard elements. They are characterized by long distances, frequent branches (separators, infeed and outfeed), standardized transport containers and high movement speeds. The installation space available for identification technology is limited, and the high number of read points demands a low-cost solution.

Due to the high movement speeds of transport containers in some cases, the limited space available and the fact that the read points are sometimes located very close together, the use of the RF600 system with space-saving antennas and a low transmit power can be recommended.

Features of the scenario

Intralogistics (material flow)

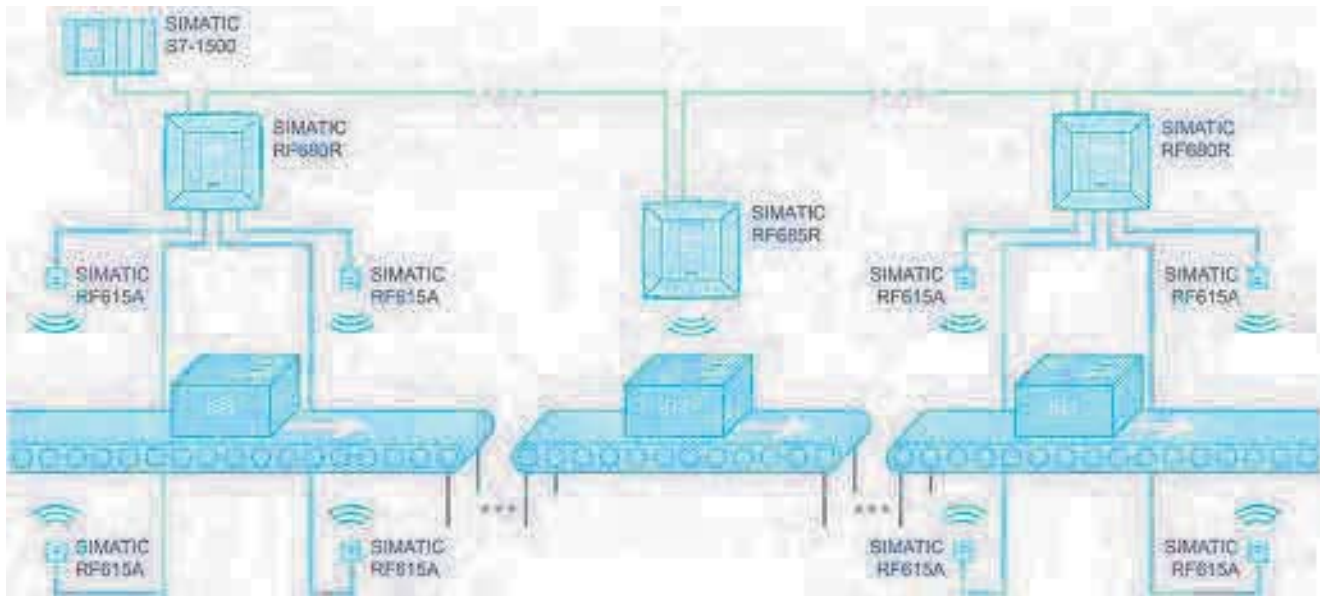

Figure 4-1 Scenario: Intralogistics (material flow)

The conveyor transports the transport containers past the antennas. The transponders attached to the transport containers are always evenly aligned. The transponders in this scenario are transponders of the type SIMATIC RF630L. The conveyor belt has a maximum width of approximately 80 cm in this example. The maximum transport speed is 2 m/s. With this arrangement, only a single transponder needs to be detected each time (single-tag).

In this scenario, SIMATIC RF680R and RF685R are used as readers. Due to the limited space available and the low reading distances, the SIMATIC RF615A antennas are used in this example. As an alternative - with greater available space and to guarantee optimum read reliability - the SIMATIC RF650A antennas can also be used. Because the readers are connected in a bus topology, wiring requirements are reduced.

The reader reads the information from the transponders on the transport containers and forwards it to the SIMATIC S7 controller.

Intralogistics (separator)

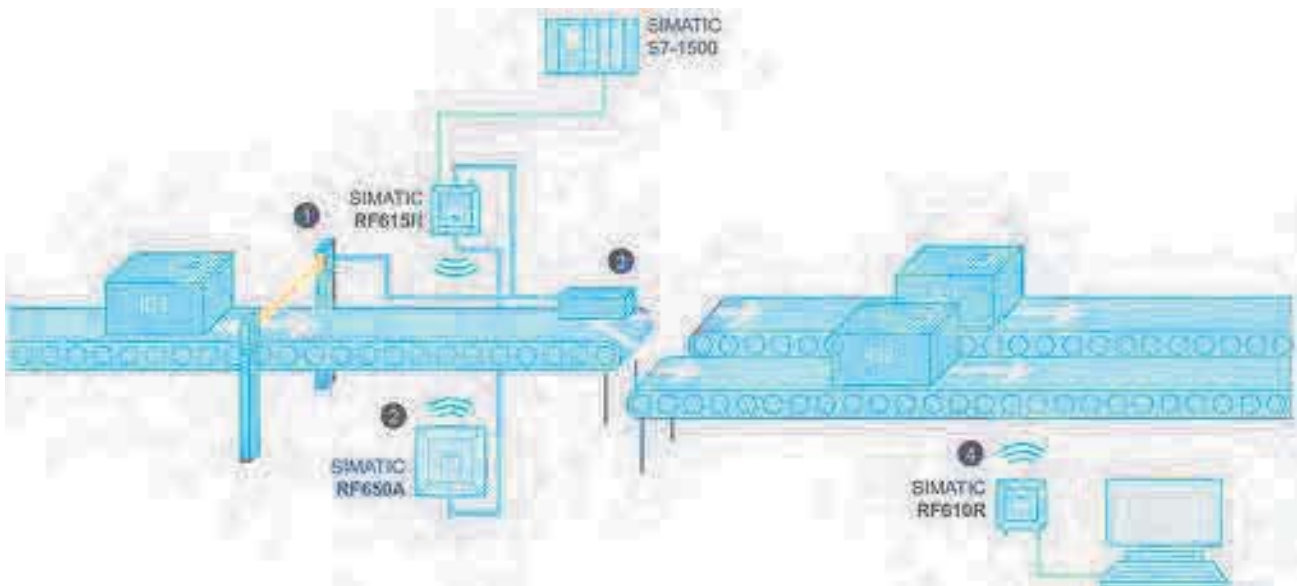

- ① Trigger by light barrier on DI
- ② Distributed small gate
- ③ Separator setting by means of DQ
- ④ Individual read point

Figure 4-2 Scenario: Intralogistics (separator)

In this example scenario, items must be distributed to the correct storage location in a transport container via a separator. The transponders attached to the transport containers are always evenly aligned. The transponders in this scenario are transponders of the type SIMATIC RF630L. The conveyor belt has a maximum width of approximately 80 cm in this example. The maximum transport speed of the conveyor belt is 2 m/s.

In this scenario, a SIMATIC RF615R with a SIMATIC RF650A and a SIMATIC RF610R external antenna are used as the readers. These readers are inexpensive and feature a very compact design.

When a transport container passes the light barrier ①, the reader reads the information from the transponder on the transport containers and forwards it to the SIMATIC S7 controller. The SIMATIC S7 controls the separator ③ of the conveyor system depending on the transponder information.

4.2.2 Scenario for workpiece identification

A typical characteristic of modern manufacturing scenarios is their multitude of variations. The individual data and production steps are stored in the transponder of a tool holder or product. These data are read by the machining stations during a production process and, if necessary, tagged with status information. This can be used to dynamically identify which production step is the next in the series. This has the advantage that the production line can work automatically without the need to access higher system components. The use of RFID therefore increases the availability of the plant.

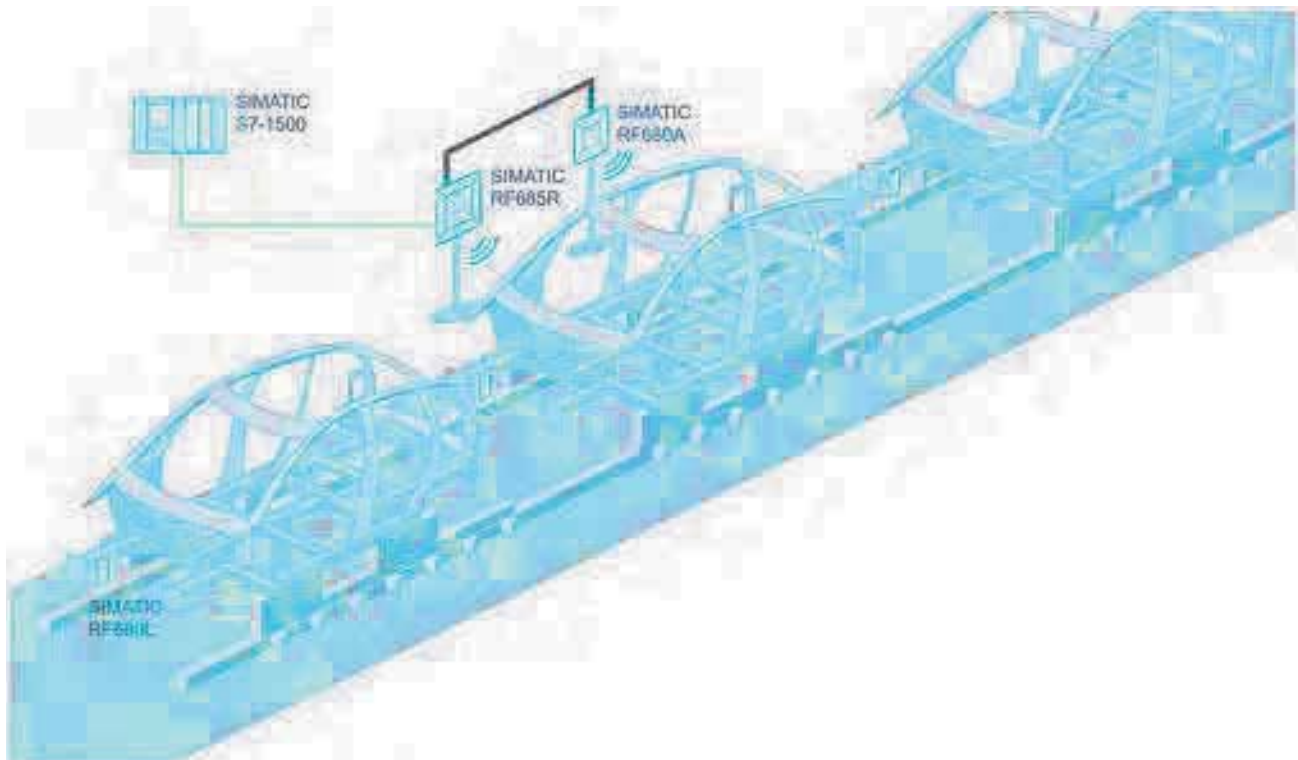

Figure 4-3 Scenario: Workpiece identification

Features of the scenario

Transponders are attached to workpiece holders. Their spatial orientation is always identical. With this arrangement, only a single transponder needs to be detected each time (single-tag).

The SIMATIC RF685R reader reads the information from the transponders with its integrated antenna or the external antenna RF680A and transfers it to the SIMATIC S7 controller. Depending on the stored transponder information, the SIMATIC S7 controller different control tasks, for example, automatically providing a suitable tool for an industrial robot at the correct time.

In a metallic wireless environment or when lots of readers/antennas are mounted close together we recommend that you do not have the readers reading permanently. Instead execute specific read/write commands when an object/transponder is located in front of an antenna or passes it. This "triggering" can be implemented with light barriers or beros. This procedure reduces mutual influence/disruption of the read points and increases the

identification quality of the wanted transponders while reducing the identification of unwanted transponders.

4.2.3 Goods tracking scenario

In this scenario, a gate consisting of a SIMATIC RF650R reader and four antennas checks the goods passing through the gate. All stored goods are equipped with transponders. A traffic light indicates whether the goods may leave the warehouse.

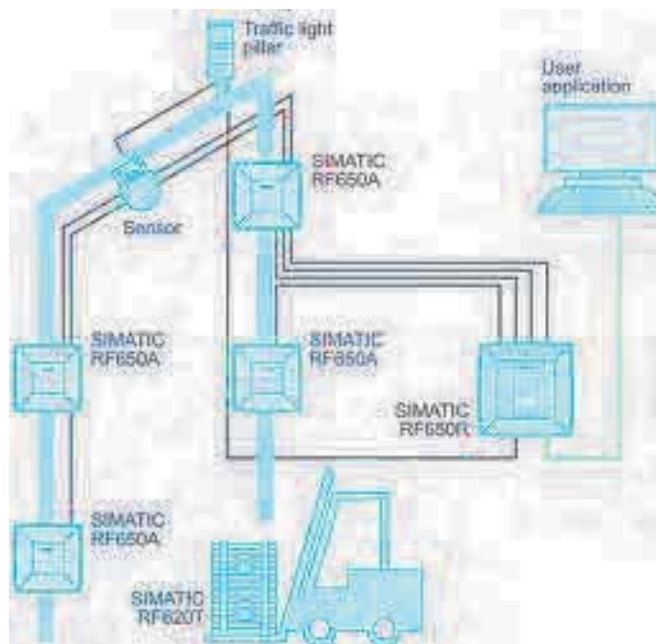

Figure 4-4 Scenario: Goods tracking

Features of the scenario

In this example scenario, the export of goods from a warehouse is checked using the SIMATIC RF650R reader and four SIMATIC RF650A antennas connected to it. A sensor registers when a vehicle passes the gate and reports this to the higher-level system, which then triggers a read operation via the reader.

The reader reads the information from the transponders on the goods and forwards it to the user application, which checks the status of the goods. The traffic light is set to green or red depending on whether the goods are released.

4.2.4 Scenario incoming goods, distribution of goods and outgoing goods

The scenario consists of an RFID system with three readers. The SIMATIC RF650R reader with its four antennas identifies the incoming/outgoing products at the incoming/outgoing goods gates of a factory building hall through which pallets are delivered. Each pallet is fitted with a transponder. The transponders contain user data that provides information about the sender and receiver of the goods. This data is read out and passed on. The goods supplied on the pallets are processed in the factory and then exit the factory through the outgoing goods gate.

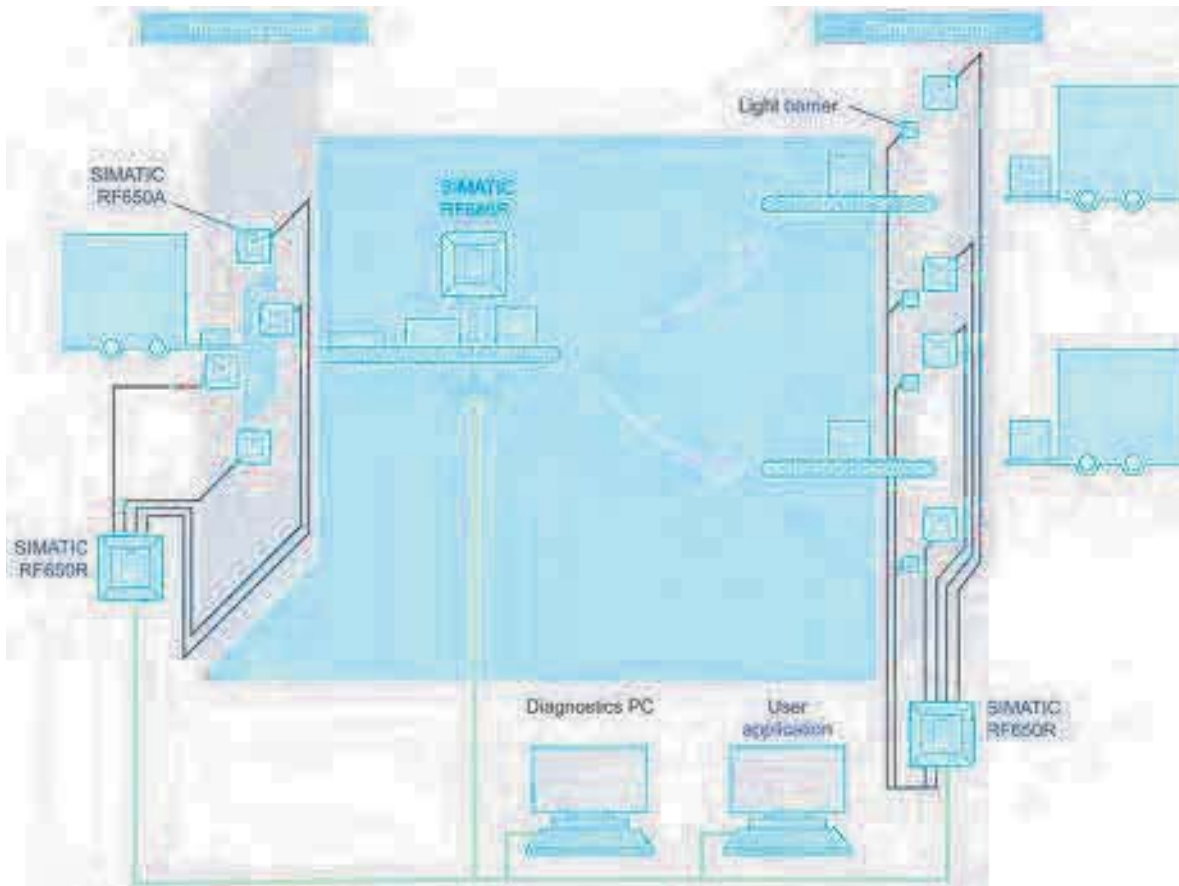

Figure 4-5 Scenario: Incoming goods, distribution of goods and outgoing goods

Features of the scenario

In this example scenario, the SIMATIC RF685R reader is controlled by a light barrier and monitors a conveyor belt; the conveyor belt transports the goods towards two output gates that are assigned to different recipients. Each item has a transponder that is always fitted at the same position and with the same alignment on the item. These transponders also contain user data that provides information about the sender and receiver of the goods. There is a separator at the end of the conveyor belt that determines the output gate to which the goods should be directed. The separator is set according to the results from the reader and the goods are distributed.

After the sorter, the goods are loaded onto pallets - each pallet is fitted with a transponder. These transponders also contain user data that provides information about the sender and receiver of the goods. Based on the data read by the SIMATIC RF650R reader, there is a check to make sure that the correct pallets for the specific receiver are available at the outgoing goods gate. Light barriers are installed to control the reader. Depending on the read results of the reader, the outgoing portal opens, or it remains closed.

4.3 Antenna configurations

Note

Validity of antenna configuration

The following information about the antenna configuration only applies to the antennas of the RF600 family. Refer to the Guidelines for selecting RFID UHF antennas (Page 51) for information on the configuration of third-party antennas.

4.3.1 Antenna configuration example

The following figure shows an example of an application with an antenna configuration of the RF650R. The antennas are positioned at the height at which the transponders to be identified are expected. The maximum width of the portal recommended for reliable operation is 4 m.

The diagram shows a configuration with three antennas. Up to four antennas can be used depending on the local conditions.

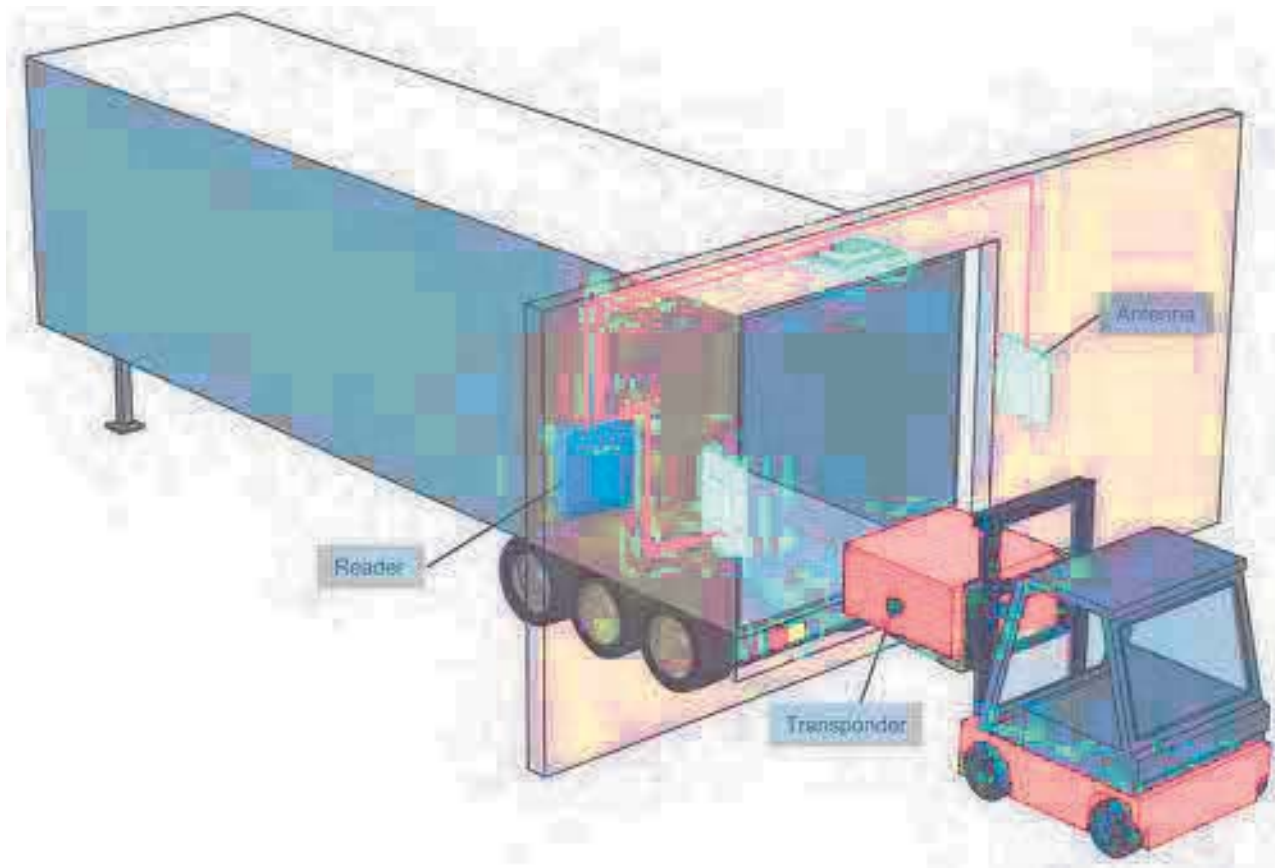
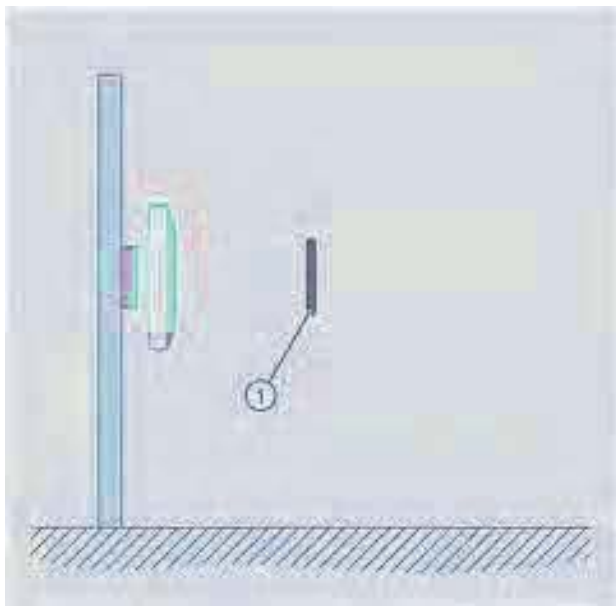

Figure 4-6 Example of an antenna configuration with three antennas

4.3.2 Possibilities and application areas for antenna configurations

Some basic antenna configurations and possible fields of application are shown below.

With the various configurations, please note that up to four external antennas can be connected to the RF650R and RF680R readers, while one external antenna can be connected to the RF615 and RF685R readers. The RF615R and RF685R readers also have an internal antenna. The RF610R reader only has an internal antenna.

Antenna configuration 1	Description/ application areas
	<p>This arrangement of antennas is appropriate when the transponders to be read are only located on one side of the goods to be acquired, for example, if a conveyor belt with passing goods has to be monitored during production and it is precisely defined on which side the transponders to be read are attached.</p> <p>① Transponder</p>

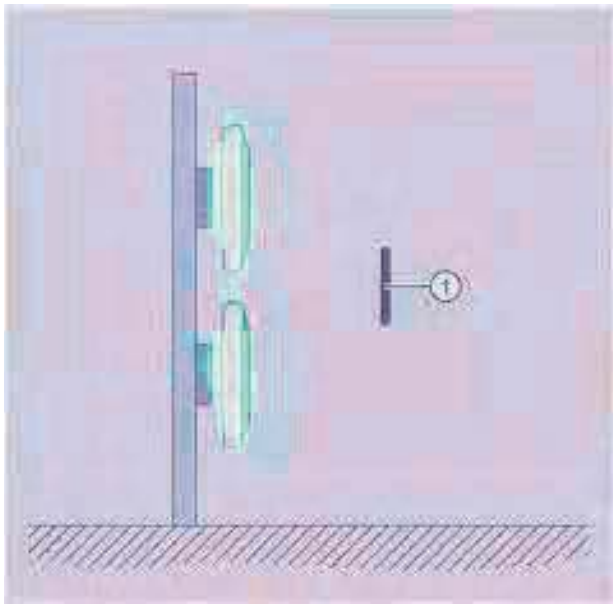
Antenna configuration 2	Description/ application areas
 <p>The diagram shows a vertical pole with two antennas mounted on it. To the right, a horizontal arm extends from the pole, holding a transponder. The ground is indicated by a hatched area at the bottom.</p>	<p>This arrangement of antennas is appropriate when the transponders to be read are only located on one side of the items to be identified, e.g. when pallets are to be identified and it is known on which side the transponders to be read are located.</p> <p>① Transponder</p>

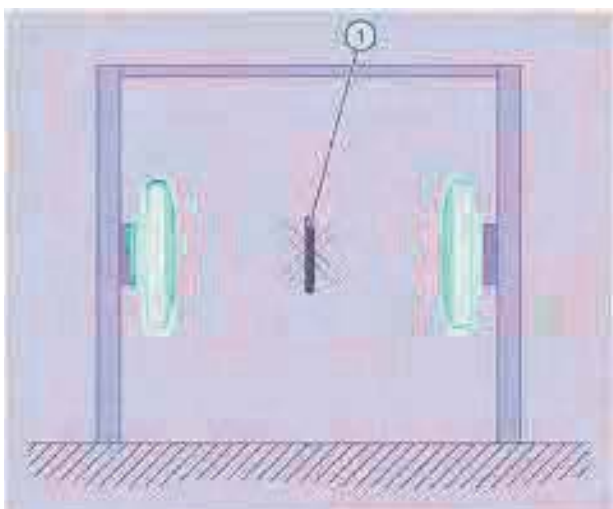
Antenna configuration 3	Description/ application areas
 <p>The diagram shows a vertical pole with two antennas mounted on it. A horizontal arm extends from the pole, holding a transponder. The ground is indicated by a hatched area at the bottom.</p>	<p>Preferred for the identification of goods at loading gates: The transponder is located in the radiation field of two antennas; for reliable transponder reading, the height of the transponders above floor level must therefore be known with reasonable accuracy.</p> <p>① Transponder</p>

Antenna configuration 4	Description/ application areas
	<p>Preferred for the identification of goods at loading gates: Similar to configuration 2, but with additional reading reliability when the transponder is at an angle to the vertical.</p> <p>① Transponder</p>

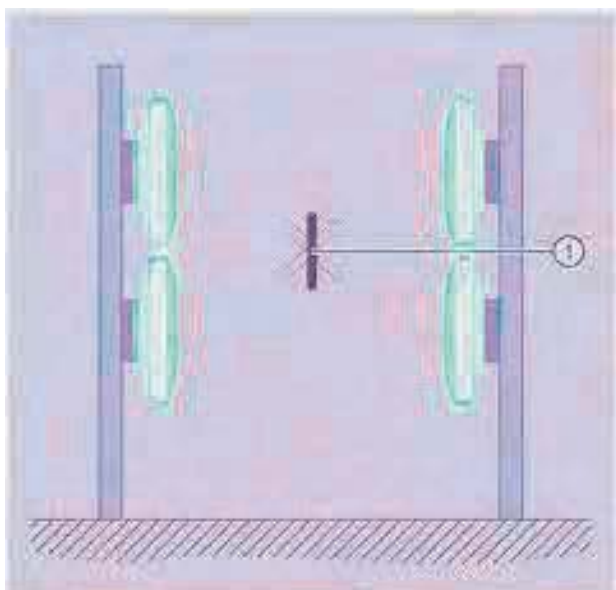
Antenna configuration 5	Description/ application areas
	<p>Preferred for the identification of goods at loading gates: The transponder is located in the radiation field of all four antennas, so the transponder position for reliable tag identification is more flexible than in configuration 2.</p> <p>① Transponder</p>

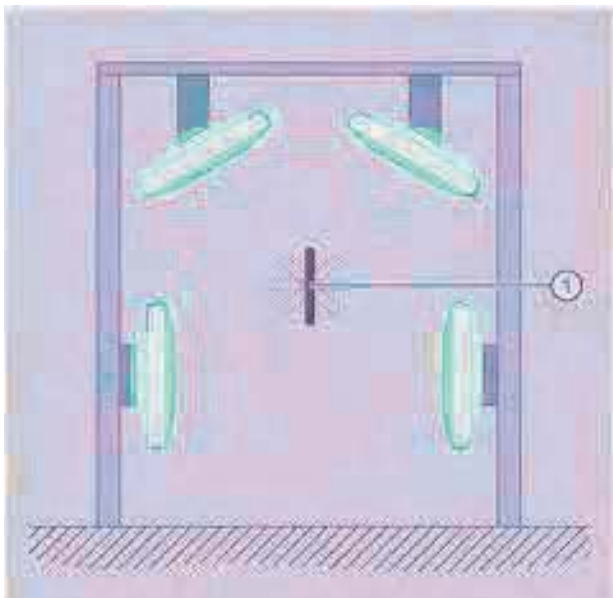
Antenna configuration 6	Description/ application areas
	<p>Preferred for the identification of goods at loading gates: Similar to configuration 4, but the reliability of transponder identification is improved as a result of the four antennas at separate locations, so the transponder position is not critical.</p> <p>① Transponder</p>

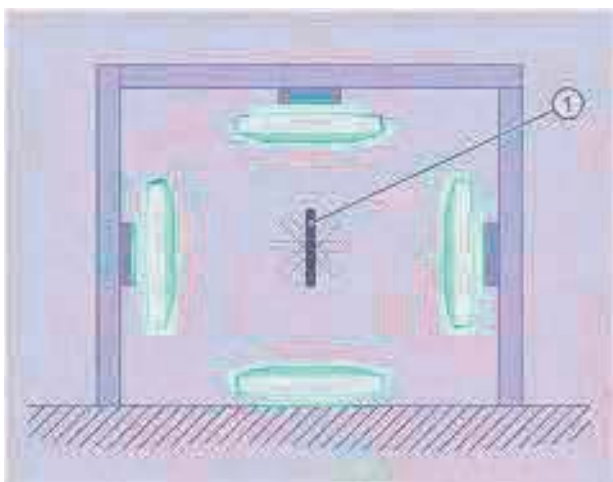
Antenna configuration 7	Description/ application areas
	<p>This tunnel configuration is suitable for conveyor belt applications. The goods with the transponders to be read are moving forwards on a conveyor belt but the alignment of the transponders relative to the antennas is not clearly defined. One of the antenna is located on the floor and radiates vertically upwards in the direction of the conveyor belt. A relatively high reading reliability is achieved due to the use of four antennas.</p> <p>① Transponder</p>

4.3.3 Transponder orientation in space

The alignment of the transponder antenna to the antenna of the reader influences the reading range. For maximum performance and to achieve the maximum read range, the transponder antenna should therefore be aligned parallel to the reader antenna:

Parallel transponder alignment	Large reading range
	The probability of identification of the transponders is at a maximum.

Vertical transponder alignment	Minimal reading range
	The probability of identification of the transponders is at a minimum.

4.3.4 Specified minimum and maximum spacing of antennas

Specified minimum spacing of antennas

The following diagram shows the specified minimum and maximum spacings for mounting antennas:

Between the antenna and liquids or metals, a minimum distance of 50 cm should be kept to. The distance between the antenna and the floor should also be at least 50 cm.

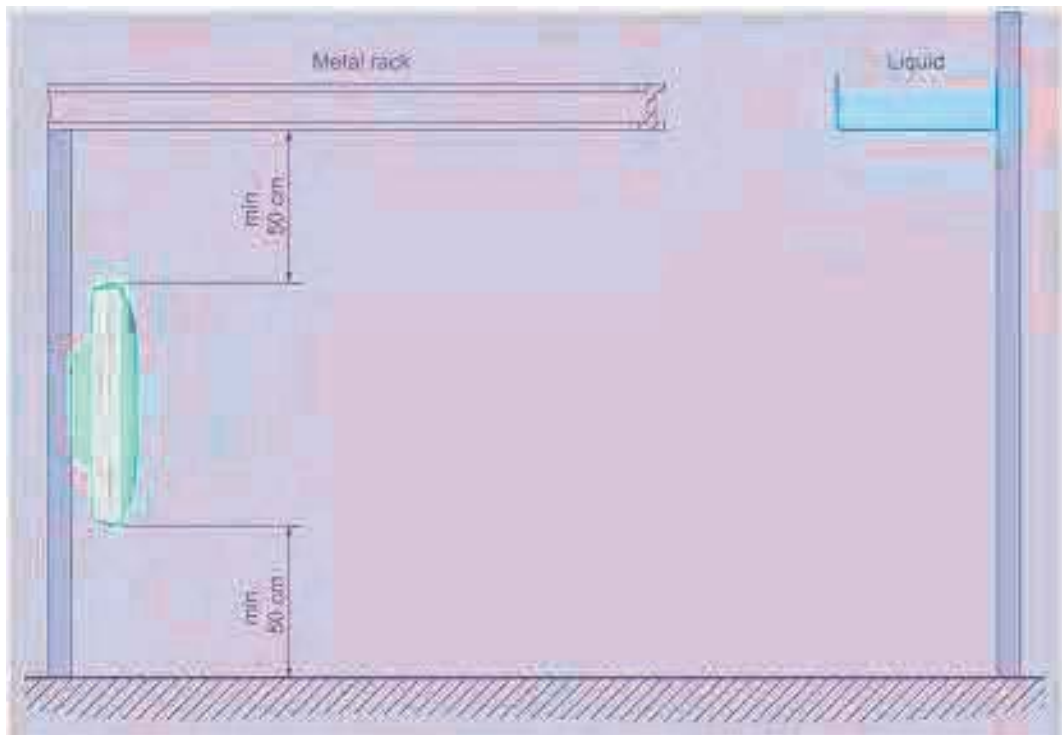
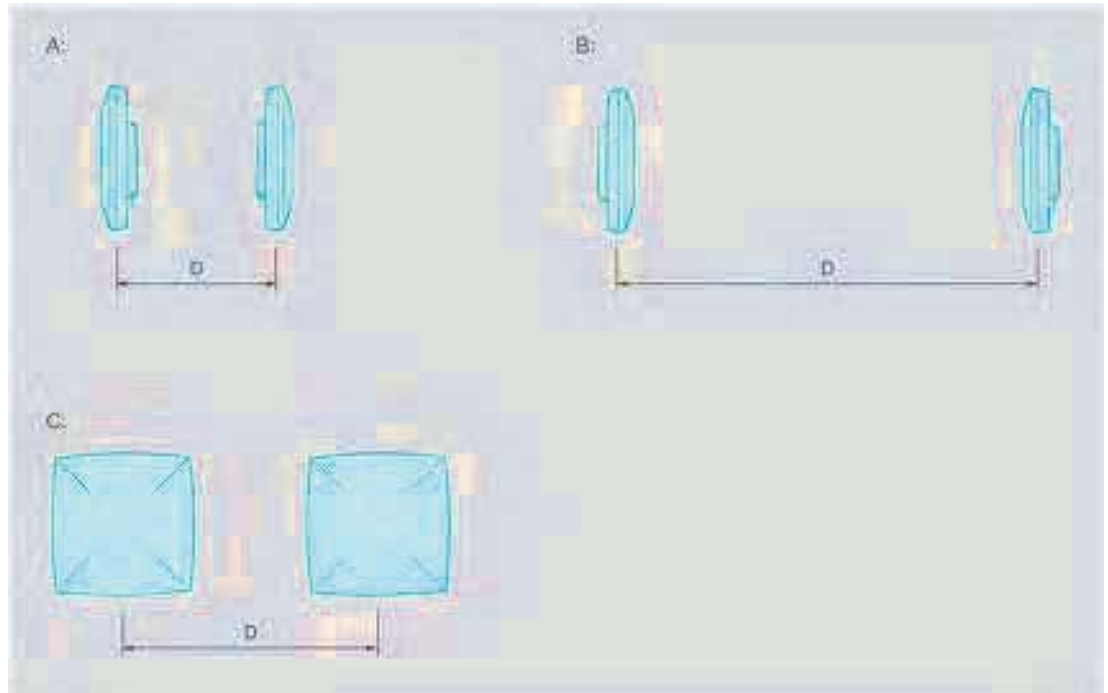

Figure 4-7 Minimum distance to the environment

4.3.5 Reciprocal influence of read points

Antenna alignment and resulting antenna spacing

The minimum distance required between antennas that use the same frequency and that are connected to different readers depends on the maximum transmit power set and the antenna alignment. The following minimum distances apply with maximum transmit power.



- A Back to back
- B Pointing at each other
- C Next to each other

Figure 4-8 Antenna spacing for different readers/antennas and identical frequencies

Table 4- 1 Antenna alignment and minimum antenna spacing

Antenna configuration	Antenna alignment	Minimum distance (D)		
		RF610R/RF615R with internal antenna	RF685R with internal antenna	RF600 reader with RF615A/RF620A
A	Back to back	1.0 m	0.3 m	1.0 m
B	Pointing at each other	2.0 m	2.0 m	2.0 m
C	Next to each other	1.0 m	0.5 m	1.0 m
		RF600 reader with RF640A/RF642A	RF600 reader with RF650A/RF680A	RF600 reader with RF660A
A	Back to back	1.0 m	0.3 m	0.5 m
B	Pointing at each other	2.0 m	2.0 m	2.0 m
C	Next to each other	2.0 m	0.5 m	0.8 m

Antenna spacing with portal configuration

In the portal configuration, multiple antennas are connected to one reader. In this case, the antennas must not exceed the maximum distance to one another.

Table 4- 2 Maximum antenna spacing of the external antennas with a portal configuration

Antenna configuration	Antenna alignment	Maximum distance (D)		
		RF600 reader with RF615A/RF620A	RF600 reader with RF640A/RF642A	RF600 reader with RF650A/RF660A/RF680A
B	Pointing at each other	2.0 m	8.0 m	8.0 m

¹⁾ Portal spacing of up to 10 m is possible. The probability of a read must be checked.

4.3.6 Read and write range

The read/write range between the reader/antenna and the transponder is influenced by the following factors:

Table 4- 3 Factors on the read/write range

Factors	Description
Transmit power of the reader	The higher the transmit power of the reader, the larger the reading range.
Transponder size and design	The larger the transponder antenna, the larger the power input area and therefore the larger the reading range.
Absorption factor of the materials	The higher the absorption of the surrounding material, the smaller the reading range.
Manufacturing quality of the transponders	The better the transponder has been matched to the operating frequencies during manufacturing, the greater the reading range.

Factors	Description
Reflection characteristics of the environment	In a multiple-reflection environment (e.g., in rooms with reflecting surfaces, machinery, or concrete walls), the reading range can be significantly higher than in a low-reflection environment.
Number of transponders in the antenna field	<p>The typical ranges always relate to a transponder installed at the maximum possible distance from the antenna.</p> <p>If there are several transponders located in the antenna field, the distances to all other transponders must not exceed the maximum possible distance to be able to be detected from the antenna field.</p> <p>The width and height of the antenna field within which its transponders can be arranged at a certain distance from the antenna depend on the following:</p> <ul style="list-style-type: none"> • The radiated power, • Only reading or reading and writing of the transponders (writing requires more power, typically double the power) • The aperture angle (horizontal) • The aperture angle (vertical)

You will find detailed information about the reading range of the individual readers in the "Technical specifications" in the sections for the various readers.

4.3.7 Static/dynamic mode

Reading or writing can be either static or dynamic.

- Reading/writing is counted as being **static** if the tag does not move in front of the antenna and is read or written.
- Reading/writing is counted as being **dynamic** if the tag moves past the antenna during reading/writing.

The following overview shows which environments are suitable for which read or write mode:

Operating mode	Read	Write
Static	Recommended in normal UHF environments	Recommended in normal UHF environments
Dynamic	Recommended under difficult UHF conditions	Not recommended in difficult UHF environments

4.3.8 Operation of several readers within restricted space

4.3.8.1 Using more than one reader

When mounting the readers make sure that there is a minimum clearance of 0.5 m between the readers to avoid them influencing each other.

Avoiding problems

When several RFID readers are used, there is a danger that RFID transponders can also be read out by other readers. Care must therefore be taken to ensure that the transponder can only be identified by the intended reader.

Technical disruptions between readers then occur particularly when they transmit on the same channel (on the same frequency). You will find more detailed information in the section "The response of electromagnetic waves in the UHF band (Page 66)".

4.3.8.2 Optimization of robustness of tag data accesses for readers that are operated simultaneously

Parameter data access reliability

If several readers are to be operated simultaneously in an environment, then the following settings affect the reliability of the reader's access to transponder data:

- Electromagnetic environment (see section "The response of electromagnetic waves in the UHF band (Page 66)")
- Type of transponder (see section "Transponder (Page 359)")
- Number of transponders to be detected by an antenna at a time
- Type of antenna (see section "Antennas (Page 231)" and section "Guidelines for selecting RFID UHF antennas (Page 51)")
- Transponders' distance from and orientation to antennas (see section "Transponder (Page 359)")
- Distances and orientation of antennas of different readers to each other
- Radiated power of antennas

The robustness of transponder data access is improved for readers whenever distances to adjacent readers are increased, radiated power is reduced, and a channel plan (for ETSI readers) is implemented. Adjacent readers are parameterized in the channel plan in such a way that they do not use the same channels.

A channel plan can be created for ETSI and CMIT readers; for FCC readers, it is assumed that the probability of two readers accidentally using the same channel is very low.

4.3.8.3 Frequency hopping

This technique is intended to prevent mutual interference between readers. The reader changes its transmission channel in a random or programmed sequence (FHSS).

Procedure for FCC

Frequency hopping is always active in the FCC country profile. With 50 available channels the probability is low that two readers will be operating on the same frequency. In China, one reader operates on at least 2 channels, e.g. sixteen 2 watt channels.

You will find more information on frequency ranges in the section "Regulations applicable to frequency bands (Page 97)".

Procedure for ETSI

Frequency hopping is optional in the ETSI wireless profile. According to ETSI EN 203 208 V1.4.1, frequency hopping is required in multi-channel operation; without it, only single-channel operation is possible. In this mode, the reader pauses for 100 ms after each 4 s transmission period to comply with the standard.

4.3.9 Guidelines for selecting RFID UHF antennas

4.3.9.1 Note safety information

 WARNING
Before planning how to use third-party components, as the operator of a system that comprises both RF600 components and third-party components, you must comply with the safety information in Section Safety instructions for third-party antennas as well as for modifications to the RF600 system (Page 19).

4.3.9.2 Preconditions for selecting RFID UHF antennas

Target group

This section is aimed at configuration engineers who thoroughly understand and wish to carry out the selection and installation of an antenna or a cable for the SIMATIC RF600 system. The various antenna and cable parameters are explained, and information is provided on the criteria you must particularly observe. Otherwise this chapter is equally suitable for theoretical and practice-oriented users.

Purpose of this chapter

This section will help you to select the suitable antenna or the suitable cable taking into account all important criteria and to make the relevant settings in the configuration software/WBM of the SIMATIC RF600 system. Correct and safe integration into the SIMATIC RF600 system is only possible following adaptation of all required parameters.

4.3.9.3 General application planning

Overview of the total SIMATIC RF600 system and its influencing factors

In the following graphic you can see the design of a SIMATIC RF600 reader with connected antenna and the influencing factors. The influencing factors affect the radiated power output.

$$\text{Radiated power} = \text{transmit power} \pm \text{influencing factors}$$

You must be aware of these influencing factors and also consider them if you wish to integrate components such as antennas or cables into the system. These influencing factors are described in more detail in sections "Antennas (Page 231)" and "Antenna cables (Page 53)".

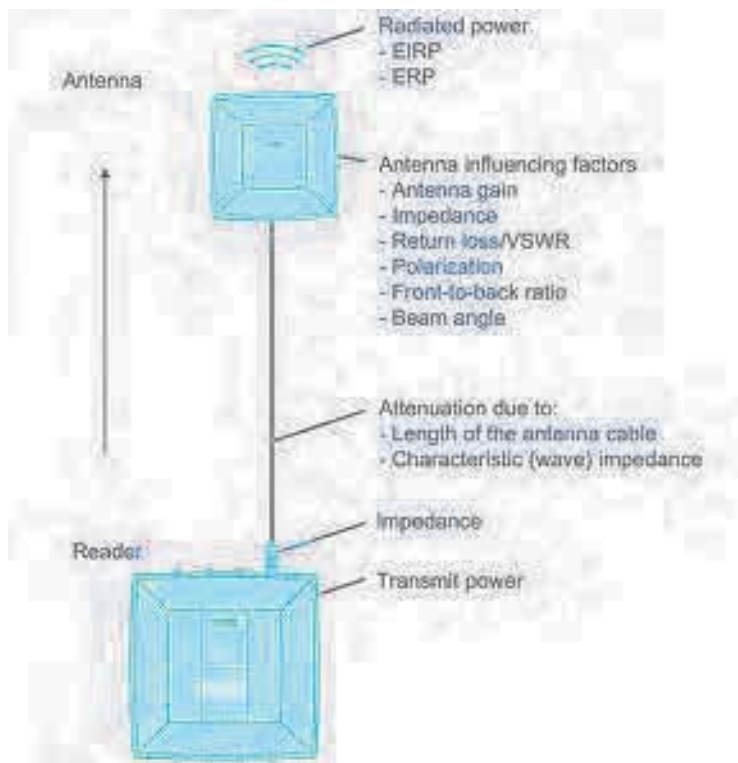

Figure 4-9 Overview diagram: Influencing factors

When operating the SIMATIC RF600 system, you need to observe additional influencing factors such as minimum spacing between antennas in the room.

Environmental conditions

NOTICE

Damage to the device

In line with the application, you must take into consideration the mechanical loads (shock and vibration) as well as environmental demands such as temperature, moisture, UV radiation.

The device could be damaged if these factors are not considered.

Specifying the transmit / radiated power

Depending on whether you want to use a third-party antenna and/or antenna cable with a reader, you need to select the suitable components. When selecting third-party components orient yourself on the values of comparable Siemens products.

With the readers, the parameters for the transmit/radiated power, antenna gain and cable loss (user-defined) are set using the WBM. In the WBM, you can select the Siemens products being used from a drop-down list quickly and easily, and the values and their effect on the transmit/radiated power are calculated directly. With third-party products, you can enter the relevant values manually.

Based on the entered products/values, the WBM calculates the permitted radiated power and makes sure that this is not exceeded.

4.3.9.4 Types of antenna

In principle, all types of directional antennas can be considered as antennas for integration into the SIMATIC RF600 system. Directional antennas have a preferred direction in which more energy is radiated than in other directions.

RF600 antennas on the other hand, are optimized for operation with RF600 readers and have all the required approvals.

4.3.9.5 Antenna cables

Selection criteria

You must observe the criteria listed below when selecting the appropriate antenna cable.

Characteristic impedance

Note the following points when selecting the antenna cable:

- You can only use coaxial antenna cables when connecting an antenna.
- These antenna cables must have a nominal characteristic impedance of $Z = 50 \text{ Ohm}$.

Antenna cable loss

In order to be able to transmit the available UHF power from the RF600 reader to the antenna or antennas, the antenna cable loss should not exceed a value of approx. 5 dB.

Dependency of the cable loss

The cable loss depends on two important factors:

- External characteristics of cable. These includes the cable length, diameter and design.
- As a result of the physical principle, the cable loss is also frequency-dependent. In other words, the cable loss increases the higher the transmitter frequency is. Therefore the cable loss must be specified in the frequency band from 860 to 960 MHz.

Cable vendors usually provide tables or calculation aids for their types of cable which usually include the transmitter and receiver frequencies as well as the cable length. Therefore contact your cable vendor in order to determine the appropriate type of cable using the approximate value referred to above.

Notes on use

Shielding of the antenna cable

Coaxial antenna cables generally have a shielded design and therefore radiate little of the transmitted power to the environment.

Bending radius of the antenna cable

The properties of the cable shield are influenced by mechanical loading or bending. You must therefore observe the static and dynamic bending radii specified by the cable vendor.

Connectors and adapters

You must use connectors and adapters of the type "Reverse Polarity R-TNC" (male connector) for your antenna cables to ensure correct connection to the RF600 reader interface.

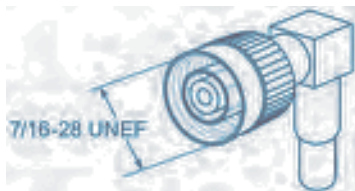

Figure 4-10 Thread standardization

You can find more information in the catalog data of your cable vendor.

4.4 Minimum distances and maximum ranges

The following section describes the configuration of the antenna and transponder relative to each other. The aim of the section is to help you achieve the maximum ranges listed here in a typical electromagnetic environment. One of the main focuses of the section is the effect of the mounting surface of the transponder on the read/write distance.

As the requirements for achieving the maximum distances specified here, note the following points:

- Operate the readers with the maximum possible and permitted transmit power.
- With external antennas, the antenna cable with 1 m cable length and 0.5 dB cable loss is used (6GT2815-0BH10).
- Optimum alignment of the transponder and antenna is ensured (see section "Configurations of antenna and transponder (Page 55)").
- The optimum mounting surface for the transponder has been selected (see section "Effects of the materials of the mounting surfaces on the range (Page 58)").
- The maximum range specified in the section "Maximum read/write ranges of transponders (Page 59)" applies only to read processes.

With write operations, the range is reduced as described in the section.

- Effects that reduce read/write ranges are avoided (see section "Antenna configurations (Page 39)").

4.4.1 Configurations of antenna and transponder

Below, you will find several possible antenna-transponder configurations that are necessary to achieve the maximum range. The polarization of the antenna plays a decisive role. The antennas are distinguished according the following types:

- Linear antennas:
RF615A, RF620A, RF642A
- Circular antennas:
RF640A, RF660A, RF650A
- Antennas that can be switched over (linear/circular):
RF680A

With the antenna types with linear polarization (RF620A and RF642A), the polarization axes of the antenna and of the transponder must be aligned parallel to each other to achieve a maximum range.

NOTICE

Reduction of the maximum read/write range when using linear antennas

If the alignment of the polarization axes of linear antennas (RF620A or RF642A) and transponders is not parallel, this reduces the read/write range. The reduction in the range depends on the angular deviation between the polarization axes of the antenna and the polarization axis of the transponder. You will find further details in the section "Alignment of transponders to the antenna (Page 257)" or "Alignment of transponders to the antenna (Page 297)".

Note

Adjustable RF680A antenna

Note that the antenna RF680A can be switched over. This means that you can set the polarization axis of this antenna manually. Depending on the setting (circular or linear horizontal or linear vertical) the antenna has the properties of a circular or linear antenna.

Possible transponder alignments depending on the antenna type

Circular antennas

To achieve the maximum read/write range with circular antennas, make sure that the planes of the polarization axes have the same alignment. Changing the transponder angle within the x-y plane has no effect on the range.

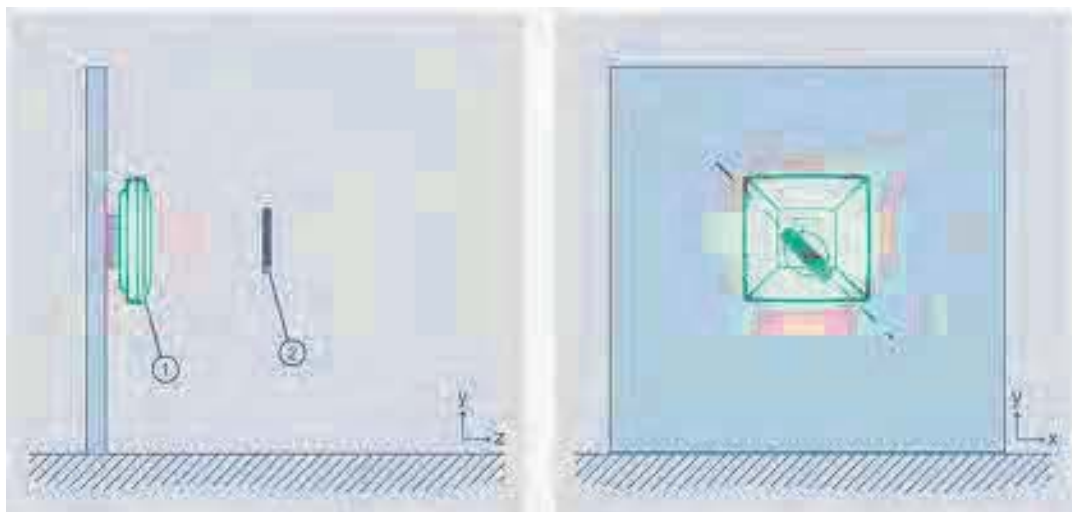

- ① Circular antenna RF640A, RF650A, RF660A or RF680A
- ② Transponder

Figure 4-11 Possible transponder alignment with circular antennas

Linear antennas

To achieve the maximum range with linear antennas, make sure that the polarization axes of the antenna and transponder are parallel to each other. Changing the transponder angle within the x-y plane leads to a reduction of the range.

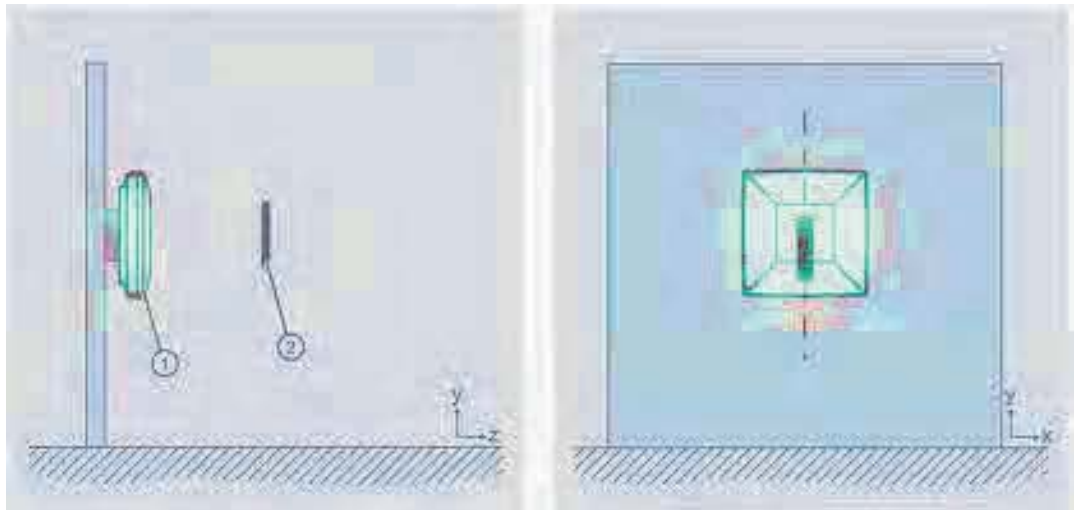

- ① Linear antenna RF615A, RF620A, RF642A or RF680A
- ② Transponder

Figure 4-12 Possible transponder alignment with linear antennas

Note

Optimum transponder position/alignment

Depending on the electromagnetic properties of the environment, the optimum transponder position and alignment may differ from those shown above.

Suboptimal transponder alignment for all antenna types

If the angle is changed within the y-z plane, this causes a reduction in range for all antenna types.

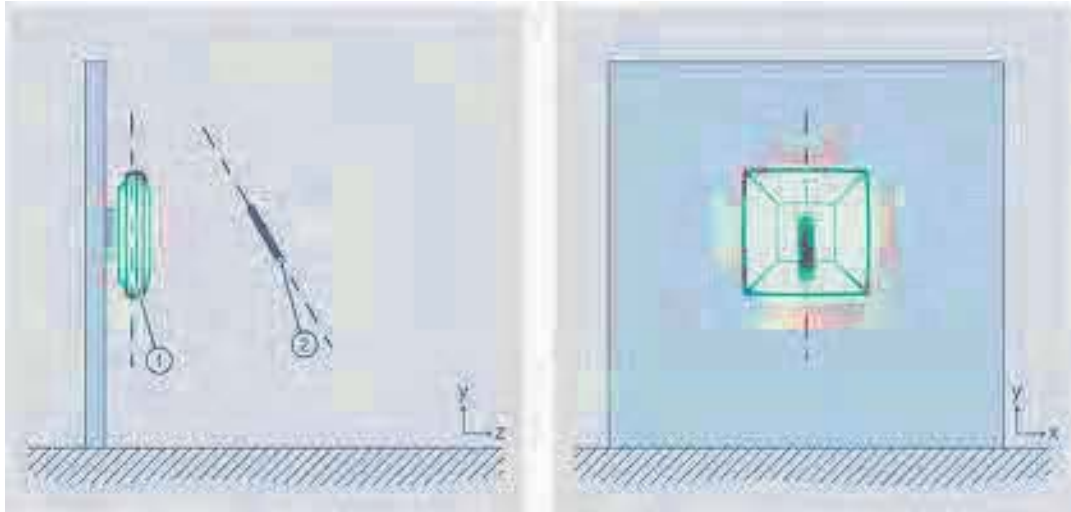

- ① Antenna RF615A, RF620A, RF640A, RF642A, RF650A or RF680A
- ② Transponder

Figure 4-13 Suboptimal transponder alignment

Note

Exceptions

The suboptimal transponder alignment does not apply to the transponders RF625T and RF630T. You will find additional information on this in the sections dealing with the transponders.

4.4.2 Effects of the materials of the mounting surfaces on the range

Effects due to antenna mounting

For the RF640A, RF642A, RF650A, RF660A and RF680A antennas, the antenna gain and therefore the maximum read/write range does not depend on the selected material of the mounting surface. In contrast to this, the antenna gain of the RF615A and RF620A antennas and therefore the maximum read/write range of transponders depends on the mounting surface of the antenna. To achieve the maximum range with an RF615A/RF620A antenna, the antenna needs to be mounted on a metallic surface of at least 150 x 150 mm.

You will find more detailed information on antenna gain in the subsections of the section "Antenna patterns (Page 257)".

Effects due to transponder mounting

The maximum read/write range of the transponders depends on the material of the mounting surface. The specified ranges apply when mounted on non-metallic surfaces, such as paper or card, with the RF640L, RF642L, RF625T, RF630T, RF640T and RF645T when mounted on metal.

Mounting on plastic can reduce the maximum read/write range considerably depending on the type of plastic (up to 70%). When mounted on wood, the range is further reduced the more moisture the wood contains. Due to the attenuating properties of glass, direct mounting without a spacer can halve the range.

If the RF625T, RF630T, RF640T, RF645T, RF680T or RF682T transponders are mounted on metal, this metallic surface acts as a reflection surface. This surface should therefore be adequately large. To achieve the listed maximum ranges, transponders must be mounted on a metallic mounting surface with a minimum diameter of 150 mm, for the RF630T and RF680T 300 mm. If the metallic mounting surface only has a diameter of 65 mm instead of the required 150 mm, the range is reduced by 65%.

4.4.3 Maximum read/write ranges of transponders

Maximum read ranges

The measurements were made under the following conditions:

- ETSI radio profile
- Maximum possible radiated power of the reader or antenna.
- Optimum transponder alignment and mounting surface
- With antenna connected:
 - With a 3 meter long antenna cable with 1 dB cable loss (article number: 6GT2815-0BH30)
 - RF615A and RF620A: Mounted on metal.
 - RF680A: Circular polarization
- Room temperature of approx. 20 - 25 °C
- Low-reflection environment; Ranges may be smaller or larger depending on the ambient conditions.

4.4 Minimum distances and maximum ranges

The following tables summarize the ranges with the RF610R and RF615R readers, as well as the RF680R and RF685R readers, since the ranges achieved are identical with these readers. Note that the RF610R reader does not have an external antenna connector and the RF680R reader does not have an internal antenna.

Table 4- 4 Read range of the transponders I (all ranges in meters [m])

	SIMATIC RF630L 6GT2810-2AB01- 0AX1	SIMATIC RF630L 6GT2810-2AB02- 0AX0	SIMATIC RF630L 6GT2810-2AB03	SIMATIC RF630L 6GT2810-2AB04
SIMATIC RF610R SIMATIC RF615R with internal antenna	1.0	1.0	0.6	0.6
SIMATIC RF615R with RF615A	0.4	0.5	0.2	0.2
with RF620A	0.4	0.6	0.2	0.2
with RF640A	1.6	1.8	0.6	1.0
with RF642A	3.5	4.0	1.6	1.8
with RF650A	1.6	2.0	0.9	0.8
with RF660A	3.0	4.0	1.4	1.6
with RF680A	1.6	2.0	1.0	1.0
SIMATIC RF650R with RF615A	1.0	1.2	0.5	0.6
with RF620A	1.0	1.2	0.5	0.7
with RF640A	3.0	3.0	1.6	1.8
with RF642A	5.0	5.0	3.0	3.5
with RF650A	3.0	3.0	1.4	1.8
with RF660A	5.0	5.0	2.5	3.0
with RF680A	3.0	3.0	1.4	1.8
SIMATIC RF685R with internal antenna	5.0	6.0	3.0	3.5
SIMATIC RF680R SIMATIC RF685R with RF615A	1.4	1.8	0.7	0.8
with RF620A	1.6	1.8	0.8	0.9
with RF640A	4.0	4.0	2.0	2.5
with RF642A	5.0	5.0	3.0	3.5
with RF650A	3.5	4.0	1.8	2.5
with RF660A	5.0	5.0	2.5	3.0
with RF680A	4.0	4.5	1.8	2.5

Table 4- 5 Read range of the transponders II (all ranges in meters [m])

	SIMATIC RF630L 6GT2810-2AC82	SIMATIC RF630L 6GT2810-2AE80-0AX2	SIMATIC RF630L 6GT2810-2AE81-0AX1
SIMATIC RF610R SIMATIC RF615R with internal antenna	0.4	1.0	0.6
SIMATIC RF615R with RF615A	0.1	0.5	0.2
with RF620A	0.2	0.5	0.2
with RF640A	1.4	2.5	1.0
with RF642A	3.0	4.0	2.5
with RF650A	1.4	2.5	1.0
with RF660A	2.5	4.0	3.5
with RF680A	1.4	2.5	1.2
SIMATIC RF650R with RF615A	0.7	1.4	0.6
with RF620A	0.8	1.4	0.6
with RF640A	2.5	4.0	1.8
with RF642A	4.5	6.0	3.5
with RF650A	2.0	3.5	1.8
with RF660A	4.0	6.0	3.0
with RF680A	2.0	3.5	1.8
SIMATIC RF685R with internal antenna	5.0	6.0	3.5
SIMATIC RF680R SIMATIC RF685R with RF615A	1.0	1.8	0.9
with RF620A	1.2	2.0	1.0
with RF640A	3.0	5.0	2.5
with RF642A	5.0	6.0	4.0
with RF650A	3.0	5.0	2.5
with RF660A	4.0	6.0	3.5
with RF680A	3.0	5.0	2.5

4.4 Minimum distances and maximum ranges

Table 4- 6 Read range of the transponders III (all ranges in meters [m])

	SIMATIC RF640L ¹⁾	SIMATIC RF642L ¹⁾	SIMATIC RF690L	SIMATIC RF610T
SIMATIC RF610R SIMATIC RF615R with internal antenna	0.5	0.8	0.2	0.8
SIMATIC RF615R with RF615A	0.2	0.2	0.1	0.3
with RF620A	0.2	0.4	0.1	0.4
with RF640A	0.5	1.2	0.1	1.2
with RF642A	2.5	2.0	0.3	3.0
with RF650A	1.0	0.8	0.1	1.2
with RF660A	2.0	1.8	0.3	3.0
with RF680A	0.5	1.0	0.1	1.4
SIMATIC RF650R with RF615A	0.1	0.4	0.2	0.9
with RF620A	0.1	0.4	0.2	0.9
with RF640A	0.8	1.2	2.5	2.5
with RF642A	3.5	2.0	2.0	4.5
with RF650A	1.6	1.2	3.0	2.0
with RF660A	2.5	1.6	1.4	3.5
with RF680A	1.6	1.2	0.9	2.0
SIMATIC RF685R with internal antenna	2.5	2.0	3.0	5.0
SIMATIC RF680R SIMATIC RF685R with RF615A	0.2	0.5	0.2	1.2
with RF620A	0.2	0.5	0.3	1.4
with RF640A	1.0	1.4	3.5	3.0
with RF642A	3.5	2.0	2.0	4.5
with RF650A	2.0	1.6	3.5	3.0
with RF660A	2.5	1.6	1.4	3.5
with RF680A	2.5	1.6	1.4	3.0

¹⁾ Mounting on metal. Mounting surface with a minimum diameter of 150 mm.

Table 4- 7 Read range of the transponders IV (all ranges in meters [m])

	SIMATIC RF620T ¹⁾	SIMATIC RF625T ²⁾	SIMATIC RF630T ²⁾	SIMATIC RF640T ²⁾
SIMATIC RF610R SIMATIC RF615R with internal antenna	1.0	0.3	0.3	0.4
SIMATIC RF615R with RF615A	1.0	0.1	0.1	0.2
with RF620A	1.2	0.1	0.2	0.2
with RF640A	4.0	0.3	0.4	0.7
with RF642A	4.0	1.0	0.5	1.4
with RF650A	3.5	0.2	0.4	0.7
with RF660A	4.0	0.8	1.0	1.2
with RF680A	4.0	0.2	0.5	1.2
SIMATIC RF650R with RF615A	1.8	0.3	0.4	0.6
with RF620A	1.8	0.4	0.4	0.7
with RF640A	5.0	1.0	1.0	1.8
with RF642A	7.0	1.8	2.0	2.5
with RF650A	4.0	1.0	0.9	2.0
with RF660A	6.0	1.4	1.8	2.0
with RF680A	4.0	0.8	0.9	2.0
SIMATIC RF685R with internal antenna	7.0	2.0	2.0	3.5
SIMATIC RF680R SIMATIC RF685R with RF615A	2.5	0.5	0.5	0.8
with RF620A	2.5	0.5	0.5	1.0
with RF640A	6.0	1.4	1.4	2.5
with RF642A	7.0	1.8	2.0	4.0
with RF650A	5.0	1.4	1.2	2.5
with RF660A	6.0	1.4	1.8	3.0
with RF680A	6.0	1.2	1.2	3.0

1) Mounting on a non-metallic surface. Mounting on metal is only permitted in combination with a spacer.

2) Mounting on metal Mounting surface with a minimum diameter of 150 mm, for the RF630T 300 mm.

4.4 Minimum distances and maximum ranges

Table 4- 8 Read range of the transponders V (all ranges in meters [m])

	SIMATIC RF645T ¹⁾	SIMATIC RF680T ¹⁾	SIMATIC RF682T ¹⁾
SIMATIC RF610R SIMATIC RF615R with internal antenna	1.0	1.0	1.0
SIMATIC RF615R with RF615A	0.7	0.6	0.4
with RF620A	0.9	0.7	0.4
with RF640A	1.4	2.0	1.2
with RF642A	3.0	4.0	2.5
with RF650A	1.6	1.8	1.2
with RF660A	3.5	4.0	2.0
with RF680A	1.8	2.0	1.2
SIMATIC RF650R with RF615A	1.2	1.0	0.7
with RF620A	1.4	1.2	0.8
with RF640A	4.0	3.0	2.5
with RF642A	6.0	5.0	4.5
with RF650A	3.5	3.0	2.0
with RF660A	5.0	4.5	4.0
with RF680A	3.0	3.0	2.0
with RF680A	4.5	4.5	3.0
SIMATIC RF685R with internal antenna	6.0	5.0	4.0
SIMATIC RF680R SIMATIC RF685R with RF615A	1.8	1.4	1.0
with RF620A	2.0	1.6	1.2
with RF640A	5.0	4.0	3.0
with RF642A	6.0	5.0	4.5
with RF650A	5.0	4.0	2.5
with RF660A	5.0	4.5	4.0
with RF680A	4.5	4.5	3.0

¹⁾ Mounting on metal. Mounting surface with a minimum diameter of 150 mm, for the RF680T 300 mm.

Maximum write ranges

Depending on the transponder type, the reader antenna requires more power for writing than for reading data. When writing, the maximum range reduces by approximately 30 % compared with the read range.

4.4.4 Minimum distances between antennas and transponders

The antennas listed here are all far field antennas. For this reason, a minimum distance between antennas and transponders must be maintained to ensure reliable transponder data access:

Table 4- 9 Minimum distances to be maintained between antennas and transponders

RF600 antenna	Minimum distances to be maintained
RF615A	50 mm
RF620A	50 mm
RF640A	200 mm
RF642A	200 mm
RF650A	200 mm
RF660A	200 mm
RF680A	200 mm
RF685R, internal antenna	200 mm

4.4.5 Influence of electrically conductive walls on the range

NOTICE

Influence of conducting walls on the range

If there are metallic (reflecting) surfaces in the immediate vicinity of the transponder, this can have a negative effect on the write/read range. Test the environmental conditions before using the transponder.

4.5 Environmental conditions for transponders

Basic rules

The transponder must not be placed directly on metal surfaces or on containers of liquid. The on-metal transponders designed specifically for use in metallic environments are an exception to this. For physical reasons, a minimum distance must be maintained between the transponder antenna and conductive material. A minimum distance of 5 cm is recommended. The transponder operates better when the distance is greater (between 5 and 20 cm).

- Transponder assembly on non-conductive material (plastic, wood) has a tendency to be less critical than assembly on poorly conductive material.
- The best results are achieved on the materials specified by the transponder manufacturer.
- For more information, refer to the section "Transponder (Page 359)" or ask the relevant transponder manufacturer.

4.6 The response of electromagnetic waves in the UHF band

4.6.1 The effect of reflections and interference

Reflections and interference

Electromagnetic waves in the UHF band behave and propagate in a similar manner to light waves, that is they are reflected from large objects such as ceilings, floors, walls and windows and interfere with each other. Due to the nature of electromagnetic waves, interference can lead to wave amplification which can produce an increased reading range. In the worst case scenario, interference can also result in waves being extinguished which causes gaps in reader coverage.

In some circumstances, reflections can also be beneficial when they cause electromagnetic waves to be routed around objects, in a sense (deflection). This can increase the reading probability.

Due to these electromagnetic characteristics, it is extremely difficult in the multiple-reflection environment that is usually found in real environments on site to determine propagation paths and field strengths for a particular location.

Reducing the effect of reflections/interference on transponder identification

- Reducing the transmit power:
To minimize interference, we recommend that the transmit power of the reader is reduced until it is sufficient for an identification rate of 100%.
- Increasing the number of antennas:
More antennas (3 or 4) in a suitable antenna configuration can prevent gaps in reader coverage.

4.6.2 Influence of metals

Metal can have an effect on the electromagnetic field depending on the arrangement or environment. The effect ranges from a hardly determinable influence through to total blocking of communication. The term metal in this context also includes metallized materials that are either coated with metal or shot through with metal to such an extent that UHF radiation cannot penetrate or only to a minimal extent.

The effect of metal on the electromagnetic field can be prevented as follows:

- Do not mount transponders on metal.
The on-metal transponders designed specifically for use in metallic environments are an exception to this.
- Do not place metallic or conducting objects in the propagation field of the antenna and transponder.

Influence of metal on transponders

Normally transponders must not be mounted directly on metallic surfaces. The transponders designed specifically for use in metallic environments are an exception to this (e.g.: RF690L, RF620T, RF625T, RF630T, RF640T, RF680T).

Due to the nature of the electromagnetic field, a minimum distance must be maintained between the transponder antenna and conductive materials. For more detailed information on the special case of attaching transponders to electrically conducting materials, refer to the relevant transponder sections.

In the case of transponders that are not designed for mounting on metallic materials, the minimum permissible distance from metal is 5 cm. The larger the distance between the transponder and the metallic surface, the better the function of the transponder.

Influence of metal on antennas

Note that metal surfaces located directly in the antenna field reflect the transmitted power directly to the antenna. Due to the nature of the electromagnetic field, a minimum distance must be maintained between the antenna and conductive materials. You can find more detailed information on this in section "Specified minimum and maximum spacing of antennas (Page 46)".

If the reflected energy becomes too strong in the receive path of the reader, this activates a protective circuit that shows itself as an antenna error without there actually being an error in the configuration or a defect on the antenna.

4.6 The response of electromagnetic waves in the UHF band

This effect depends very much on the transmitted power, the components being used (cable, antenna) and the distance from the metallic surface to the antenna. In this case, repositioning/realigning the antenna or reducing the radiated power can remedy the situation.

4.6.3 Influence of liquids and non-metallic substances

Non-metallic substances can also affect the propagation of electromagnetic waves and thus the transponder range.

When non-metallic substances or objects that can absorb UHF radiation are located in the propagation field, these can alter the antenna field depending on their size and distance and can even extinguish the field entirely.

The RF damping effect of water, materials containing water, ice and carbon is high. Electromagnetic energy is partly reflected and absorbed.

Oil- or petroleum-based liquids have low RF damping. Electromagnetic waves penetrate these liquids and are only slightly weakened.

4.6.4 Influence of external components

The RED guideline and the relevant standards govern the electromagnetic compatibility requirements. This also concerns the third-party components of the RF600 system. Even though requirements for electromagnetic compatibility are defined, various components will still interfere with each other.

The performance of the RF600 system is highly dependent on the electromagnetic environment of the antennas.

Reflections and interference

On the one hand, antenna fields will be weakened by absorbing materials and reflected by conducting materials. When electromagnetic fields are reflected, the antenna field and reflecting fields overlap (interference).

Third-party components in the same frequency band

On the other hand, third-party components may transmit on the same frequency band as the reader, or the third-party components may transmit in different frequency bands with side bands that overlap with the frequency band of the reader. This results in a reduction of the "signal-to-noise" ratio which reduces the performance of an RF600 system.

If a DECT station that is transmitting in the 2 GHz band, for example, is located in the receiving range of an antenna of the RF600 system, the performance of the write and read access to the transponder may be reduced.

4.7 Planning and installation of UHF read points

Due to their comparatively large effective range, RFID UHF systems (frequency band 865 - 928 MHz) have different requirements in terms of planning, commissioning and operation compared with the HF systems commonly used up to now in automation (frequency band 13.56 MHz). This section describes important rules for preparation and implementation of the RFID UHF systems.

4.7.1 Technical basics

General

In contrast to inductively coupled HF systems, in UHF technology, there is full propagation of the radio waves just as in other wireless systems (radio, TV etc). There are both magnetic and electrical field components present. The following graphic shows the structure of a UHF system. One characteristic is the design of the transponder that differs greatly from the structure used in HF systems, e.g. the use of a dipole or helix antenna.

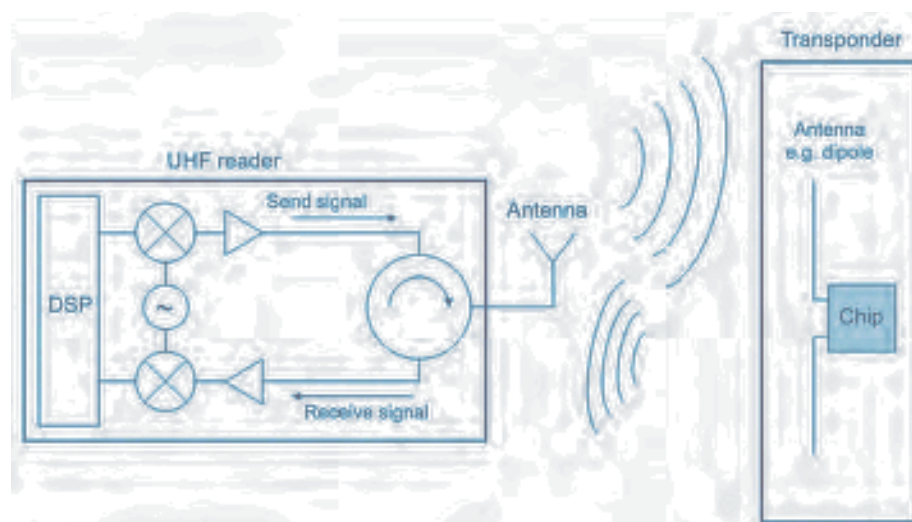

Figure 4-14 Structure of a UHF RFID system

RSSI value

The signal strength of the transponder response is known as the RSSI value (Received Signal Strength Indicator). The RSSI value is a one byte value (0 to 255), the higher the value the better the signal strength (according to the IEEE 802.11 standard).

The actual RSSI value depends on numerous parameters:

- transponder type used,
- chip used in the transponder,
- connected antenna,
- transmit power,

- distance between antenna and transponder,
- reflections,
- noise level in the channel used and in neighboring channels

The RSSI value is important for the automatic evaluation of the read point and for filtering. A simple comparison of the RSSI values of two transponders is nevertheless not possible because the values are influenced by the transponder tolerances and the non-homogeneous antenna field. This means that it is possible that a transponder positioned closer to the RFID antenna has a lower RSSI value than a transponder much further away.

Propagation of the antenna field

The waves do not propagate as a homogeneous field, there is superposition of the waves that can cause the following effects:

- Overshoots and field gaps due to obliteration of two waves
These are caused by reflection and the resulting propagation on different paths (comparable with fading effects on the car radio, e.g. noise when the vehicle is standing)
- Generation of overshoots due to reflecting objects and surfaces

This can be illustrated by comparing it with a "hall of mirrors". The signal transmitted by the reader is reflected (several times) by metallic objects such as housings, steel supports or grilles and this can lead to unwanted effects and read errors. It is also possible that a transponder is not identified although it is located in the assumed direct identification range of the reader. It can also happen that a transponder moving outside the antenna field is read out due to overshoots.

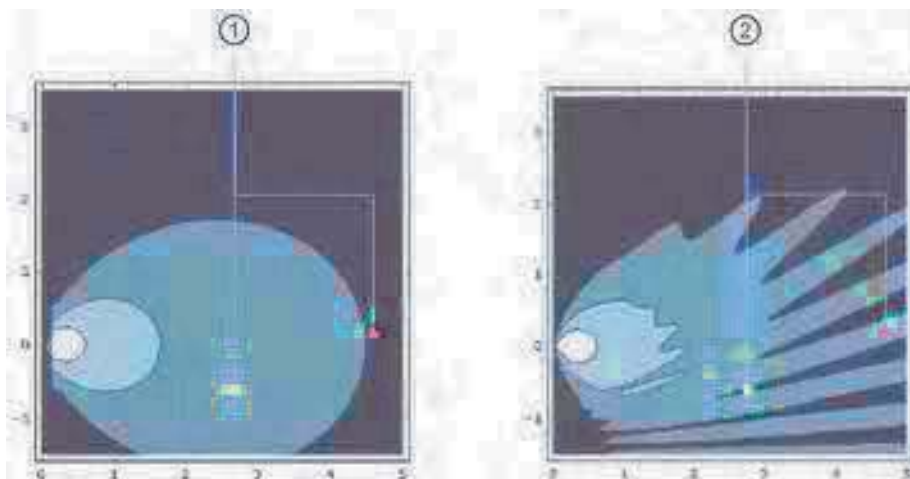

- ① Identification situation with two transponders in an ideal radio/antenna field
- ② Identification situation with two transponders in a real radio/antenna field with reflections that can lead to obliteration and overshoots

Figure 4-15 Propagation of UHF RFID antenna fields

Properties of the transmitting antenna

Depending on their design, UHF RFID antennas provide different properties. They differ in the polarization and antenna gain.

The direction of the electrical field component of an electromagnetic wave and the alignment of the antenna decide the polarization of the radiation. A distinction is made between linear and circular polarization of an antenna. With linear polarization you achieve the maximum write/read distances when the polarization axes of the antenna and transponder are parallel to each other. As the deviation increases, the received power deteriorates.

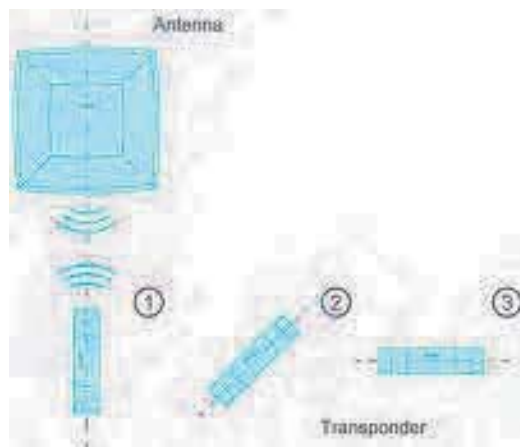

- ① Polarization axes parallel: approx. 100 % range
- ② Polarization axis turned through 45°: approx. 50% range
- ③ Polarization axis turned through 90°: approx. 10% range

Figure 4-16 Effect of the polarization axes on the write/read distance with linear antennas

Linear antennas can only be used if the alignment of the transponder is defined. On the other hand, one advantage of linear antennas is that they react less sensitively to reflections. This restriction does not apply with circular polarization. Circular antennas can also be used with differing alignments of the transponder and achieve constant results (e.g. RF680A or RF685R). It has been shown that with a defined transponder alignment, the linear antenna normally produces the best results.

4.7.2 Implementation of UHF RFID installations

The use of UHF RFID systems requires careful planning and preparation to avoid problems during commissioning and operation.

4.7.2.1 Preparation phase

Device selection

When selecting the suitable RFID hardware, remember the following minimum criteria:

- Integration in a control/IT environment
- Degree of protection
- Size of the identification range
- Type, number and position of the transponders in the antenna field
- Reflecting and absorbent materials in the vicinity of the antenna
- Distance between the antenna or the reader and the transponder

The following application examples illustrate the requirements for specific use cases and provide suitable solutions:

- Read point in a conveyor system in confined installation conditions:

A container should be transported in a conveyor system. Information on the next transport section is contained in a transponder which is attached to the side of the container.

Possible configuration: RF610R or possibly RF615R with integrated internal antenna and a compact, external antenna (e.g. RF615A, RF620A)

- RFID gate at the incoming goods / outgoing goods department:

Several transponders are located on different packaging of products on a pallet. These need to be identified when passing through the RFID gate.

Possible configuration: RF650R with four circular antennas (e.g. RF650A, RF660A depending on the required radiated power)

- Four read points along the production line:

A product needs to be processed by different machines along the production line. The information for this is contained on a transponder attached to the product that must be read out at each machine.

Possible configuration: RF680R with four antennas (e.g. RF615A, RF620A, RF680A)

- Read point on a production line with a predominantly metallic environment:

A product needs to be processed by different machines along the production line. The information for this is contained on a transponder attached to the product that must be read out at each machine.

Possible configuration: RF685R with integrated adaptive antenna

Dynamic identification

Dead spots cannot be excluded. To be able to compensate for dead spots, we recommend that you give preference to dynamic identification rather than static identification. Dynamic identification means that the transponders are read while they are moving (e.g. on the conveyor belt). If static identification is necessary, the antenna field can be virtually dynamized with the RF685R antenna or RF680A.

Triggering

To read out all right transponder data, you can have the readers perform permanent write/read actions or have specific write/read actions triggered. For the following reasons, we recommend that you trigger specific write/read actions:

- The RFID system only performs write/read actions when an object to be identified enters the antenna field. This reduces the number of process errors and they can be identified more quickly.
- Due to the fact that the various RFID systems only perform write/read actions when necessary, this reduces the possibility of antenna fields disrupting each other. This increases process reliability in plants, particularly when there is a high reader density.

Decoupling third-party RFID systems

If you are using different RFID systems, make sure that no two systems are active at the same time or operate separately from each other. Ideally there should be no mixed usage.

Training

Make sure that the engineers commissioning the UHF RFID systems are adequately trained.

4.7.2.2 Test phase

Metals and absorbent materials have a major influence on the functioning of UHF RFID systems. Since every environment has different conditions, we recommend that you run a test with all the objects to be identified for each read point. Include neighboring readers in these tests as well as scenarios for overshoots. Run through the tests an adequate number of times to make sure that any sporadically occurring influences on the antenna fields are also tested.

The final position of the transponder should only be decided after an adequately intensive test phase so that suitable variations can be tried out if errors occur.

4.7.2.3 Setting up read points

The read point setup described in this section is performed using the Web Based Management (WBM) and applies to the RF600 readers. You can find a detailed description of the WBM in the configuration manual "SIMATIC RF600 (<https://support.industry.siemens.com/cs/ww/en/ps/15081/man>)".

Adjust antennas

Follow the steps below to optimize the antenna alignment:

1. Position the object fitted with a transponder and to be identified at the required read point.
2. Align the reader or the antenna so that its front points in the direction of the object (transponder) to be identified.

Keep to the minimum distances between antennas and transponders to avoid antenna errors.

When using linear antennas, make sure the polarization direction is correct.

3. In the "Settings - Adjust antenna" menu item, select the connected antenna and click the "Start adjustment" button.

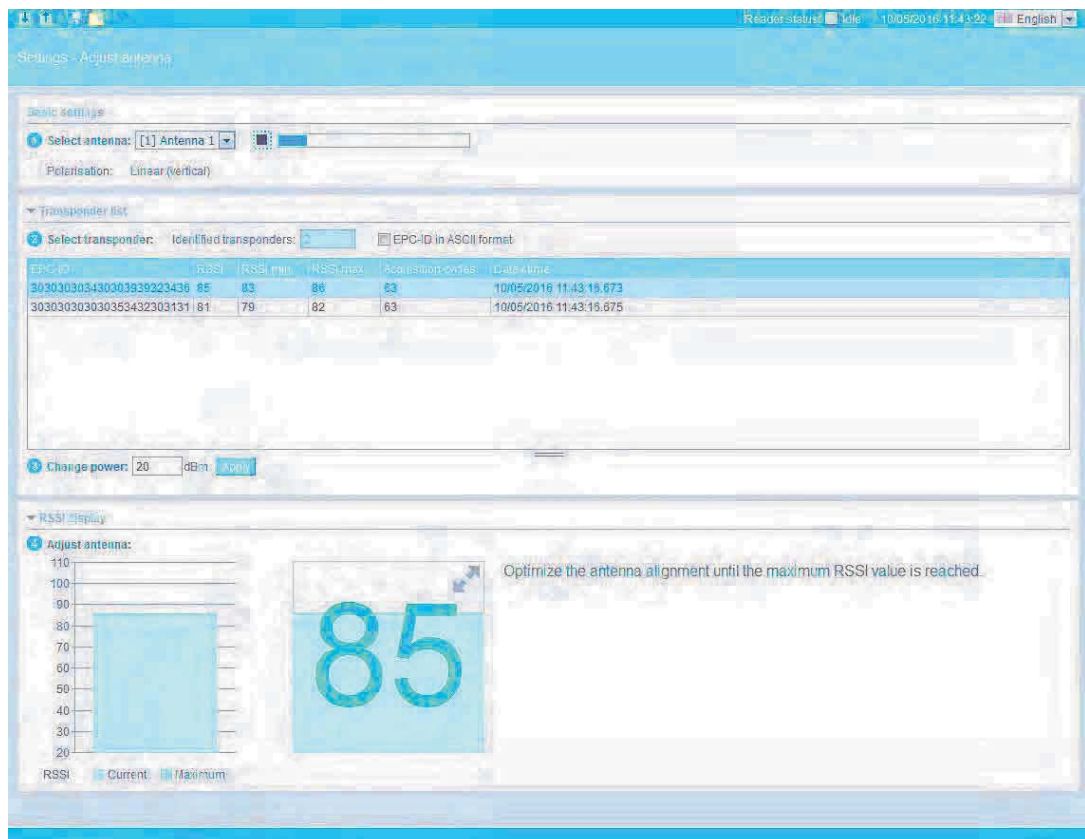

Figure 4-17 Optimizing the antenna alignment with the "Settings - Adjust antenna" menu item of the WBM

4. In the "RSSI display" area, you can see the current (light blue) and maximum reached (dark blue) RSSI values.

Note**Transponder is not identified**

If no transponder is identified, first increase the radiated power as described in the following section. Then repeat the antenna adjustment.

Also check the polarization of your antenna. If the transponder always has the same alignment, the antenna polarization should be adapted accordingly. If the transponder moves or the alignment of the transponder varies, it is advisable to combine several antenna polarization types or to select a circular polarization.

5. Optimize the antenna adjustment until the maximum possible RSSI value is reached.
6. Secure the antenna.

Note that the RSSI value depends on the following components:

- transponder used,
- antenna used,
- Polarization,
- reflecting and absorbent materials in the vicinity of the antenna.

Radiated power

Using the "Settings - Read points" menu item of the WBM, you can set the radiated power. Select the radiated power so that the required transponders can be identified reliably but without overreach. In this case, the following applies: "as much as necessary, as little as possible".

In the "Settings - Activation power" menu item, you can find the optimum radiated power for reliable transponder access.

Detect activation power

Follow the steps below to detect the activation power:

1. In the "Settings - Activation power" menu item, select the connected antenna and click the "Start measurement" button.
2. In the "Min. power" column of the transponder list, you can see the required activation power. The value "Min. power" of the transponder last selected in the transponder list is automatically transferred to the "Accept power" box with 2 dB added.

Note

Optimizing the radiated power

The value entered automatically in the "Accept power" box corresponds to the minimum value with which the transponder was identified by the antenna (Min. power) plus a power reserve of 2 dB. This value serves as a guideline and you can adapt it. To be sure that the antenna reliably detects the transponders regularly, we recommend that you accept the automatically adapted default value.

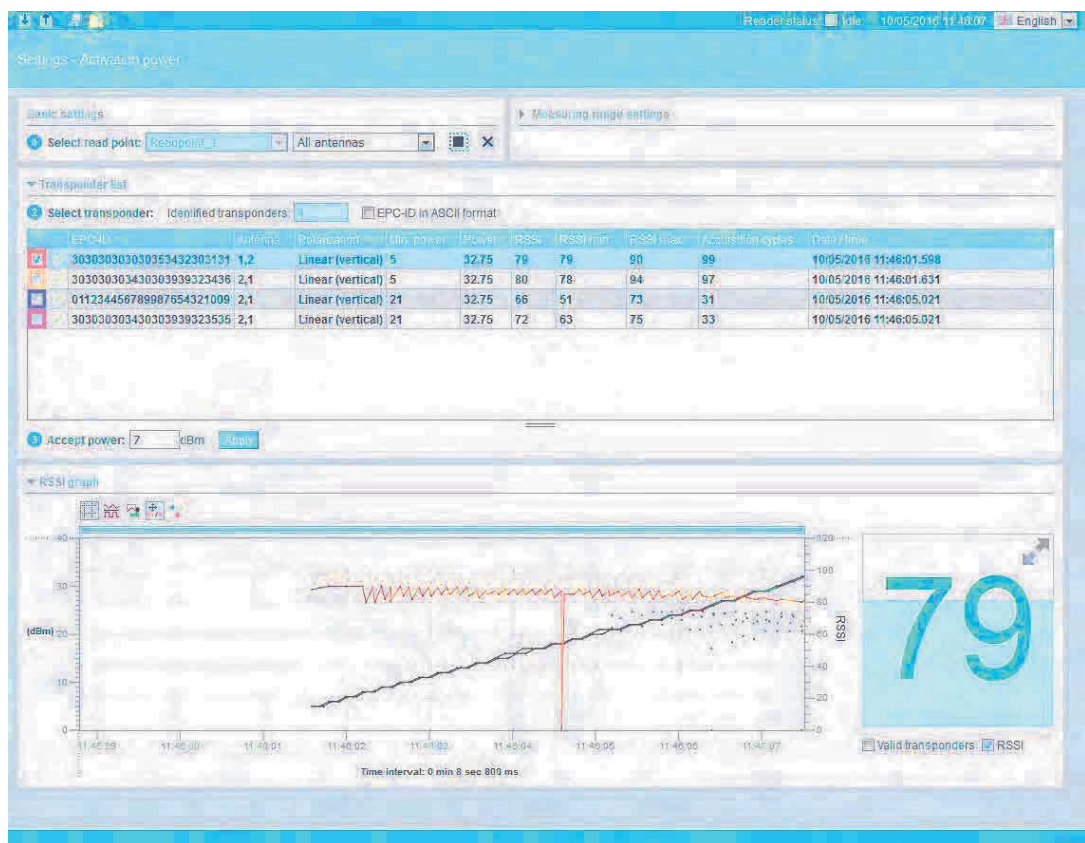



Figure 4-18 Determining the activation power using the "Settings - Activation power" menu item

3. Click the "Apply" button to transfer the value entered in the "Radiated power" input box of the "Settings - Read points" menu item.
4. Click the  symbol to transfer the configuration to the reader.

4.7.3 Dealing with field disturbances

4.7.3.1 Types and approaches to solutions

The superposition of radio waves and reflection by conductive materials (in particular metal) can lead to weakening or strengthening of the antenna field at certain points in space. These effects can lead to disruptions when identifying RFID transponders that can be distinguished as follows:

- Overshoots due to increasing field strength: Transponders are detected that are actually beyond the read distance.

Approaches to solutions:

- Reduction of the radiated power
- Determining the input attenuation
- Use of UHF algorithms
- Changing the antenna position
- Shielding measures
- Varying the antenna polarization
- Use antennas with a lower gain
- Use antennas with adjustable polarization

- Lack of separation of transponders: Transponders positioned close together are detected together although the application logic requires individual detection (for example to determine the positioning order). All transponders are within the read distance.

Approaches to solutions:

- Reduction of the radiated power
- Use of UHF algorithms
- Changing the antenna position
- Shielding measures
- Use antennas with a lower gain

- Field obliteration: Due to the superposition of waves, obliteration effects occur within the read distance.

Approaches to solutions:

- Varying the antenna polarization
- Using additional antennas
- Use of UHF algorithms
- Changing the antenna position
- Shielding measures
- Use antennas with a lower gain

4.7 Planning and installation of UHF read points

- Reader ↔ reader influence: Several readers influence or disturb each other during transponder identification.

Approaches to solutions:

- "Interconnect" neighboring readers so that they do not send at the same time
- Enable intermissions ("Settings - General" menu item)
- Channel management

- Reader ↔ transponder influence: A reader communicates with a transponder that is also in the identification area of another reader.

Solution approaches:

- "Interconnect" neighboring readers so that they do not send at the same time

- Other sources of disturbances that can lead to restriction of transponder identification.

Other sources of disturbances can occur if there are devices with similar frequency bands (for example 900 MHz) in the vicinity of the reader. The diagnostics corresponds to the influence of one reader on another. Mobile phones can also disturb identification. This is the case if a reader of the type FCC or CMIIT is operated in Europe.

Solution approaches:

- The disturbances can be eliminated by temporarily turning off the suspected source of interference or its shielding. Interference can also occur with devices in other frequency bands if these are located in the immediate vicinity of the RFID antenna (e.g. DECT telephone directly in front of the RFID antenna). Common industrial interference mechanisms, such as the harmonics of frequency converters or static discharge (ESD) can also cause disturbances.

Note

Occurrence of disturbances

Remember that these disturbances can also occur sporadically or in certain combinations.

4.7.3.2 Measures for eliminating field disturbances

Using shields

To avoid reflections, you can fit UHF absorbent material. To do this, the absorbent material is mounted at various suspected reflection points until the field disturbance no longer occurs. Where possible, avoid the use of metal structures (for example housings) and use plastic instead.

Even with reader-to-reader influence, you can use absorbent plates or shielding sheets.

Channel management

To operate the readers, depending on the country profile, you have between four and fifty send channels available. Ideally, you should make the channel assignments manually in STEP 7 Basic / Professional (TIA Portal) or in the WBM. This allows you to reduce reader-to-reader influence and if applicable field obliteration.

Table 4- 10 Example of a channel plan according to ETSI

Reader	Reader 1	Reader 2	Reader 3	Reader 4	Reader 5	...
Transmission channel	4	10	7	13	4	...
Frequency (MHz)	865.7	866.9	866.3	867.5	865.7	...

Use of multiple antennas

If you do not find the ideal antenna position to be able to identify the transponders in the various positions and alignments, you have the option of using more antennas. Multiple antennas mounted at different positions enlarge the identification range.

Enabling send pauses

If too many neighboring readers send at the same time, this causes overload of the radio channels. In this case, enable the "Intermissions" function in the "Settings - General" menu item to improve read reliability.

Varying the antenna polarization

By using linear or circular antennas, you can reduce field obliteration. This improves the reader reliability in difficult radio conditions.

The RF685R and RF680 readers also provide the option of operating the internal or external antenna both as a linear, vertical, linear horizontal and circular antenna. If more than one polarization is enabled, the polarization is changed automatically with each inventory. This increases the probability of identification in difficult radio conditions.

Changing the antenna position

In difficult radio conditions (e.g. where there is a lot of metal) it is possible that the communication between transponders and readers is impaired. You can counter this by changing the position of the antenna relative to the transponder. This also changes the multipath propagation of the radio waves and obliteration is reduced or shifted.

Use of UHF algorithms

In the "Settings - Read points" menu item of the WBM, you will find various "Tools" in the "Algorithms" area that you can use to improve the read/write reliability.

4.8 Chemical resistance of the readers and transponders

4.8.1 Readers

4.8.1.1 Overview of the readers and their housing materials

Resistance to chemicals depends on the housing materials used to manufacture the reader. The following table provides you with an overview of the housing materials that are used with the RF600 readers:

Individual part of the reader	Housing material of the reader
Top cover	Pocan CF2200; The chemical resistance of this plastic is listed in section "CF2200".
Bottom cover	<ul style="list-style-type: none"> • RF610R/RF615R: Pocan CF2200 • RF650R/RF680R/RF685R: Aluminum
Fiber-optic cable	Makrolon®2405
Decorative membrane ¹⁾	Autotex V200
Socket ¹⁾	Brass (copper alloy) CuZn40Pb2

¹⁾ Non-relevant component for resistance of complete housing

In case of questions please contact Siemens Support (section "Service & support (Page 506)").

4.8.1.2 Pocan CF2200

The following table provides an overview of the chemical resistance of the Pocan CF2200.

Table 4- 11 Resistance to chemicals - Pocan CF2200

Substance	Test conditions		Evaluation
	Concentration [%]	Temperature [°C]	
Alcohols			
Ethyl alcohol	-	-	++++
Isopropyl alcohol	-	-	++++
Phenol	-	-	○
Glycol	-	-	++++
Glycerine	-	-	++++
Alkalis			
Sodium hydroxide	10%	-	○
Ammonia solution	Diluted	-	++++
Halogens			
Bromine	-	-	○
Chlorine	-	-	○
Ketones			
Acetone	-	-	++
Methyl ethyl ketone (MEK)	-	-	++++
General silicone oils	-	-	++++
Hydrocarbons			
n-hexane	-	-	++++
Gasoline, super (aromatic contents)	-	-	++++
Heating oil	-	-	++++
Benzine (aromatic contents)	-	-	++++
Benzene	-	-	++++
Naphthalene	-	-	++++
Nitrobenzene	-	-	++++
Toluene	-	-	++++
Oils, greases			
Soya oil	-	-	++++
Olive oil	-	-	++++
Butter	-	-	++++
Motor oils HD, hydraulic oils	-	-	++++
Gearbox oils (mild-blend)	-	-	++++
Lubricating greases (roller bearing greases DIN 51825)	-	-	++++
Lubricating greases (basis: ester oils, diester oils, phosphate ester, synthetic oil)	-	-	++++

Substance	Test conditions		Evaluation
	Concentration [%]	Temperature [°C]	
Cleaning products			
Curd soap	-	-	++++
Detergent	-	-	++++
Cleaning products	-	-	++++
Salt solutions			
Sodium hypochloride	-	-	○
Sea water	-	-	++++
Acids			
Hydrochloric acid	20 %	-	++
Nitric acid	2%	-	++++
Phosphoric acid	30%	-	○
Sulfuric acid	2%	-	++++
	80%	-	○
Lactic acid	10%	-	++++
Acetic acid	10%	-	++++
Oleic acid	-	-	++++
Silicone oils			
General silicone oils	-	-	++++
Other substances			
Diethyl ether	-	-	++++
Urea	-	-	++++
Trichlorethylene	-	-	○
Nitrobenzene	-	-	++++
Hydrogen peroxide	30%	-	++++

Explanation of the rating	
++++	Resistant
+++	Practically resistant
++	Conditionally resistant
+	Less resistant
○	Not resistant
conc.	Concentrated solution
w.	Water solution
c. s.	Cold saturated

4.8.2 Transponder

4.8.2.1 Overview of the transponders and their housing materials

The following sections describe the resistance to chemicals of the various transponders. Resistance to chemicals depends on the housing materials used to manufacture the transponders.

The following table provides an overview of the housing materials of the transponders:

Table 4- 12 Overview of the housing materials of the transponders

Housing material	Transponder
Acrylonitrile/butadiene/styrene (ABS)	RF645T
Polyamide 12 (PA12)	RF640T
Polyamide 6.6 (PA 6.6)	RF625T
Polyamide 6.6 GF (PA 6.6 GF)	RF630T
Polyethylene terephthalate (PET)	RF640L RF690L
Polypropylene (PP)	RF620T
Polyphenylene sulfide (PPS)	RF680T RF682T
Polyvinyl chloride (PVC)	RF610T RF610T ATEX

Note

Chemical substances not listed

The following sections describe the chemical resistance of the various transponders to specific substances. If you require information about chemical substances that are not listed, contact Customer Support.

4.8.2.2 Acrylonitrile/butadiene/styrene (ABS)

The following table provides an overview of the chemical resistance of the transponder made of acrylonitrile/butadiene/styrene (ABS).

Table 4- 13 Resistance to chemicals - ABS

Substance	Test conditions		Evaluation
	Concentration [%]	Temperature [°C]	
Acetone	-	-	++
Alcohols	-	-	++
Gasoline	-	-	++++
Aliphatic hydrocarbons	-	-	++++

Substance	Test conditions		Evaluation
	Concentration [%]	Temperature [°C]	
Aromatic hydrocarbons	-	-	○
Weak alkaline solutions	-	-	++++
Strong alkaline solutions	-	-	++++
Weak mineral acids	-	-	++++
Strong mineral acids	-	-	○
Perchloroethylene	-	-	++
Mineral lubricants	-	-	++++
Oxidizing acids	-	-	○
Weak organic acids	-	-	++++
Strong organic acids	-	-	++
Trichloroethylene	-	-	○
UV light and weathering	-	-	++
Hot water (hydrolysis resistance)	-	-	++++

Explanation of the rating	
++++	Resistant
+++	Practically resistant
++	Conditionally resistant
+	Less resistant
○	Not resistant

4.8.2.3 Polyamide 12 (PA12)

The following table provides an overview of the chemical resistance of the transponder made of polyamide 12. The resistance of the plastic housing to chemicals used in the automobile sector (e.g.: oils, greases, diesel fuel, gasoline, etc.) is not listed extra.

Table 4- 14 Chemical resistance - Polyamide 12

Substance	Test conditions		Evaluation
	Concentration [%]	Temperature [°C]	
Battery acid	30 %	20 °C	++
Ammonia, gaseous	-	60 °C	++++
Ammonia, w.	conc.	60 °C	++++
	10 %	60 °C	++++
Benzene	-	20 °C	++++
	-	60 °C	+++
Bleach solution (12.5% effective chlorine)	-	20 °C	++
Butane, gas, liquid	-	60 °C	++++
Butyl acetate (acetic acid butyl ester)	-	60 °C	++++

4.8 Chemical resistance of the readers and transponders

Substance	Test conditions		Evaluation
	Concentration [%]	Temperature [°C]	
n(n)	-	20 °C	++++
	-	60 °C	+++
Calcium chloride, w.	-	20 °C	++++
	-	60 °C	+++
Calcium nitrate, w.	c. s.	20 °C	++++
	c. s.	60 °C	+++
Chlorine	-	20 °C	○
Chrome baths, tech.	-	20 °C	○
Iron salts, w.	c. s.	60 °C	++++
Acetic acid, w.	50 %	20 °C	○
Ethyl alcohol, w., undenaturated	95 %	20 °C	++++
	95 %	60 °C	+++
	50 %	60 °C	++++
Formaldehyde, w.	30 %	20 °C	+++
	10 %	20 °C	++++
	10 %	60 °C	+++
FORMALIN	-	20 °C	+++
Glycerine	-	60 °C	++++
Isopropanol	-	20 °C	++++
	-	60 °C	+++
Potassium hydroxide, w.	50 %	60 °C	++++
LYSOL	-	20 °C	++
Magnesium salts, w.	c. s.	60 °C	++++
Methyl alcohol, w.	50 %	60 °C	++++
Lactic acid, w.	50 %	20 °C	++
	10 %	20 °C	+++
	10 %	60 °C	++
Sodium carbonate, w. (soda)	c. s.	60 °C	++++
Sodium chloride, w.	c. s.	60 °C	++++
Sodium hydroxide	-	60 °C	++++
Nickel salts, w.	c. s.	60 °C	++++
Nitrobenzene	-	20 °C	+++
	-	60 °C	++
Phosphoric acid	10 %	20 °C	+
Propane	-	60 °C	++++
Mercury	-	60 °C	++++
Nitric acid	10 %	20 °C	+
Hydrochloric acid	10 %	20 °C	+
Sulfur dioxide	low	60 °C	++++
Sulfuric acid	25 %	20 °C	++
	10 %	20 °C	+++

Substance	Test conditions		Evaluation
	Concentration [%]	Temperature [°C]	
Hydrogen sulfide	low	60 °C	++++
Carbon tetrachloride	-	60 °C	++++
Toluene	-	20 °C	++++
	-	60 °C	+++
Detergent	high	60 °C	++++
Plasticizer	-	60 °C	++++

Explanation of the rating	
++++	Resistant
+++	Practically resistant
++	Conditionally resistant
+	Less resistant
o	Not resistant
w.	Water solution
c. s.	Cold saturated

4.8.2.4 Polyamide 6.6 (PA 6.6)

The following table provides an overview of the chemical resistance of the transponder made of polyamide 6.6 (PA 6.6). It must be emphasized that the plastic housing is extremely resistant to chemicals in automobiles (e.g.: oil, grease, diesel fuel, gasoline, ...) which are not listed separately.

Table 4- 15 Resistance to chemicals - PA 6.6

Substance	Test conditions		Evaluation
	Concentration [%]	Temperature [°C]	
Acetone	-	-	++++
Alcohols	-	-	++++
Gasoline	-	-	++++
Aliphatic hydrocarbons	-	-	++++
Aromatic hydrocarbons	-	-	++++
Weak alkaline solutions	-	-	++
Strong alkaline solutions	-	-	o
Weak mineral acids	-	-	+++
Strong mineral acids	-	-	o
Perchloroethylene	-	-	++++
Mineral lubricants	-	-	++++
Oxidizing acids	-	-	o
Weak organic acids	-	-	++
Strong organic acids	-	-	o

Substance	Test conditions		Evaluation
	Concentration [%]	Temperature [°C]	
Trichloroethylene	-	-	++++
Hot water (hydrolysis resistance)	-	-	++

Explanation of the rating	
++++	Resistant
+++	Practically resistant
++	Conditionally resistant
+	Less resistant
o	Not resistant

4.8.2.5 Polyamide 6.6 GF (PA 6.6 GF)

The following table provides an overview of the chemical resistance of the transponder made of polyamide 6.6 GF. Different values may apply to the stainless steel bolt head. It must be emphasized that the plastic housing is extremely resistant to chemicals in automobiles (e.g.: oil, grease, diesel fuel, gasoline, ...) which are not listed separately.

Table 4- 16 Resistance to chemicals - PA 6.6 GF

Substance	Test conditions		Evaluation
	Concentration [%]	Temperature [°C]	
Ammonia, w.	conc.	60 °C	++++
	20 %	60 °C	++++
Benzene	-	60 °C	++++
Bleach solution (12.5 % effective chlorine)	-	60 °C	o
Butane, gas, liquid	-	20 °C	++++ ¹⁾
Butyl acetate (acetic acid butyl ester)	-	20 °C	++++ ¹⁾
Calcium chloride, saturated 10 % solution	-	20 °C	++++
	-	60 °C	++
Chlorine	-	20 °C	o
Chrome baths, tech.	-	20 °C	o
Iron salts, w.	c. s.	20 °C	o
Acetic acid, w.	10 %	20 °C	++
	10 %	60 °C	o
Ethyl alcohol, w., undenaturated	40 %	20 °C	++++
Formaldehyde	30 %	20 °C	++++
FORMALIN	-	20 °C	++++
Glycerine	-	20 °C	++++
Isopropanol	-	60 °C	++++
Potassium hydroxide, w.	10 ... 15 %	20 °C	++

4.8 Chemical resistance of the readers and transponders

Substance	Test conditions		Evaluation
	Concentration [%]	Temperature [°C]	
Magnesium salts, w.	-	20 °C	++++ ¹⁾
Methyl alcohol, w.	50 %	20 °C	++++
Lactic acid, w.	-	20 °C	++++
	-	60 °C	○
Sodium carbonate, w. (soda)	-	20 °C	++++
Sodium chloride, w.	-	20 °C	++
Sodium hydroxide	10	20 °C	++++
Nitrobenzene	-	20 °C	++ ¹⁾
Phosphoric acid	10 %	20 °C	○
Propane	-	20 °C	++++
Nitric acid	10 %	20 °C	○
Hydrochloric acid	10 %	20 °C	○
Sulfur dioxide	low	20 °C	++
Sulfuric acid	25 %	20 °C	○
	10 %	20 °C	○
Hydrogen sulfide	dry	20 °C	++++
	dry	60 °C	○
Carbon tetrachloride	1 ... 4	20 °C	++++

¹⁾ Nothing specified for stainless steel

Explanation of the rating	
++++	Resistant
+++	Practically resistant
++	Conditionally resistant
+	Less resistant
○	Not resistant
conc.	Concentrated solution
w.	Water solution
c. s.	Cold saturated

4.8.2.6 Polyethylene terephthalate (PET)

The following table provides an overview of the chemical resistance of the transponder made of polyethylene terephthalate.

Table 4- 17 Chemical resistance - polyethylene terephthalate

Substance	Test conditions		Evaluation
	Concentration [%]	Temperature [°C]	
Acetone	100 %	20 °C	++++
	60 %	60 °C	○
Formic acid	10 %	20 °C	++++
	10 %	60 °C	○
	95 %	20 °C	+
Ammonium hydroxide	10 %	20 °C	○
Gasoline (normal)	-	80 °C	++++
Gasoline (super)	-	60 °C	++++
Benzene	100 %	20 °C	++++
Chlorobenzene	100 %	20 °C	++++
Chloroform	10 %	20 °C	○
Citric acid	100 %	20 °C	++++
Cyclohexane	100 %	20 °C	++++
Diethyl ether	100 %	20 °C	++++
Dimethyl formamide	100 %	20 °C	++++
Dioxane	100 %	20 °C	++++
	100 %	60 °C	○
Acetic acid	conc.	20 °C	++++
	conc.	60 °C	++
	conc.	80 °C	○
	10 %	20 °C	++++
Ethanol	96 %	20 °C	++++
Hydrofluoric acid	50 %	20 °C	○
	5 %	20 °C	++++
Formaldehyde	30 %	20 °C	++++
Freon 11	-	20 °C	++++
Fruit juices	-	20 °C	++++
Glycerine	-	60 °C	++++
Heptane	100 %	20 °C	++++
Potassium dichromate	10 %	20 °C	++++
Potassium permanganate	10 %	20 °C	++++
Copper sulfate	10 %	20 °C	++++
Methanol	100 %	20 °C	++++
Methyl ethyl ketone	100 %	20 °C	++++
Milk	-	20 °C	++++

4.8 Chemical resistance of the readers and transponders

Substance	Test conditions		Evaluation
	Concentration [%]	Temperature [°C]	
Lactic acid	10 %	20 °C	++++
Sodium chloride	10 %	80 °C	++++
Antichlor	10 %	20 °C	++++
Paraffin oil	-	60 °C	++++
Perchloroethylene	100 %	20 °C	++++
Petroleum	-	80 °C	++++
Phenol	30 %	20 °C	++
Propanol	diluted	20 °C	++++
Nitric acid	40 %	20 °C	o
	36 %	20 °C	o
Hydrochloric acid	100 %	20 °C	++++
Carbon disulfide	98 %	20 °C	++++
Sulfuric acid	30 %	20 °C	o
	5 %	60 °C	++++
	diluted	80 °C	++++
Hydrogen sulfide	10 %	20 °C	++++
Silicon oil	-	80 °C	++++
Edible fat	-	80 °C	++++
Cooking oil	100 %	80 °C	++++
Carbon tetrachloride	100 %	23	++++
Toluene	-	20 °C	++++
Water	-	20 °C	++++
Hydrogen peroxide	5 %	20 °C	++++
	5 %	20 °C	++++
Xylene	10 %	20 °C	++++
Zinc chloride	-	20 °C	++++

Explanation of the rating	
++++	Resistant
+++	Practically resistant
++	Conditionally resistant
+	Less resistant
o	Not resistant
conc.	Concentrated solution

4.8.2.7 Polypropylene (PP)

The following table provides an overview of the chemical resistance of the transponder made of polyethylene terephthalate.

Table 4- 18 Chemical resistance - polypropylene

Substance	Test conditions		Evaluation
	Concentration [%]	Temperature [°C]	
Emissions alkaline/containing hydrogen fluoride /carbon dioxide	low	50 °C	++++
Emissions containing hydrochloric acid	-	50 °C	++++
Emissions containing sulfuric acid	-	20 °C	++++
	-	50 °C	○
Battery acid	38 %	50 °C	++++
Aluminum acetate, w.	-	50 °C	++++
Aluminum chloride	10 %	50 °C	++++
Aluminum nitrate, w.	-	50 °C	++++
Aluminum salts	-	50 °C	++++
Formic acid	50 %	20 °C	++++
	50 %	50 °C	○
Aminoacetic acid (glycocoll, glycine)	10 %	50 °C	++++
Ammonia, gaseous	-	50 °C	++++
Ammonia	25 %	50 °C	++++
Ammonia, w.	conc.	50 °C	++++
	10 %	50 °C	++++
Arsenic acid, w.	-	50 °C	++++
Ascorbic acid, w.	-	50 °C	++++
Gasoline	-	20 °C	○
Benzene	-	20 °C	○
Prussic acid, w.	-	50 °C	++++
Sodium hypochlorite solution	diluted / 20 %	20 °C	++++
	diluted / 20 %	50 °C	++
	50 %	50 °C	++
Borax	-	50 °C	++++
Boric acid, w.	10 %	50 °C	++++
Brake fluid	-	50 °C	++++
Bromine	-	20 °C	○
Butane, gas, liquid	technically clean	50 °C	++++
Butyl acetate (acetic acid butyl ester)	-	20 °C	++
	-	50 °C	○

Substance	Test conditions		Evaluation
	Concentration [%]	Temperature [°C]	
Calcium chloride, w./ alcoholic	-	20 °C	++++
	-	50 °C	+++
Calcium chloride,	-	50 °C	++++
Calcium nitrate, w.	-	50 °C	++++
	50 %	50 °C	++++
Chlorine	-	20 °C	○
Chloroacetic acid	-	50 °C	++++
Chloric acid	20 %	20 °C	++++
	20 %	50 °C	○
Chrome baths, tech.	-	20 °C	○
Chromium salts	-	50 °C	++++
Chromic acid	10 %	50 °C	++++
	20 / 50	50 °C	++
Chromosulfuric acid	conc.	20 °C	○
Citric acid	10 %	50 °C	++++
Diesel fuel	-	20 °C	++++
Diesel oil	100 %	20 °C	++++
Diglycole acid	30 %	50 °C	++++
Iron salts, w.	c. s.	50 °C	++++
Vinegar	-	50 °C	++++
Acetic acid	5 / 50	50 °C	++++
Ethanol	50 / 96	50 °C	++++
Ethyl alcohol	96 / 40	50 °C	++++
Fluoride	-	50 °C	++++
Formaldehyde	10 %	50 °C	++++
	40 %	50 °C	+++
Formaldehyde solution	30 %	50 °C	++++
Glycerine	any	50 °C	++++
Glycol	-	50 °C	++++
Uric acid	-	20 °C	++++
HD oil, motor oil, without aromatic compounds	-	20 °C	++++
Heating oil	-	20 °C	++++
Isopropanol	technically clean	50 °C	++++
Potassium hydroxide, w.	-	50 °C	++++
Potassium hydroxide	10 / 50	50 °C	++++
Silicic acid	any	50 °C	++++
Common salt	-	50 °C	++++
Carbonic acid	saturated	50 °C	++++
LYSOL	-	50 °C	++
Magnesium salts, w.	c. s.	50 °C	++++

4.8 Chemical resistance of the readers and transponders

Substance	Test conditions		Evaluation
	Concentration [%]	Temperature [°C]	
Magnesium salts	any	50 °C	++++
Machine oil	100 %	20 °C	++++
Sea water	-	50 °C	++++
Methanol	-	50 °C	++++
Methyl alcohol, w.	50 %	50 °C	++++
Lactic acid, w.	-	50 °C	++++
Lactic acid	3 / 85	20 °C	++++
	3 / 85	50 °C	+++
	80 %	50 °C	++++
Engine oil	-	20 °C	++++
Sodium carbonate, w. (soda)	c. s.	50 °C	++++
Sodium carbonate	-	50 °C	++++
Sodium chloride, w.	c. s.	50 °C	++++
Sodium hydroxide, w.	-	50 °C	++++
Sodium hydroxide solution, w.	-	50 °C	++++
Sodium hydroxide solution	30 / 45 / 60	50 °C	++++
Nickel salts, w.	c. s.	50 °C	++++
Nickel salts	saturated	50 °C	++++
Nitrobenzene	-	20 °C	+++
	-	50 °C	++
Oxalic acid	-	50 °C	++++
Petroleum	technically clean	20 °C	++++
Phosphoric acid	1 ... 5 / 30	50 °C	++++
	85 %	50 °C	+++
Phosphoric acid, w	20 %	50 °C	++++
Propane	liquid	20 °C	++++
Propane	gaseous	20 °C	++
Mercury	pure	50 °C	++++
Crude oil	100 %	-	++
Ammonium chloride	100 %	50 °C	++++
Ammonium chloride, w.	-	50 °C	++++
Nitric acid	-	20 °C	○
	50 %	20 °C	++
	1 ... 10 %	50 °C	++++
Hydrochloric acid	1 ... 5 / 20	50 °C	++++
	35 %	20 °C	++++
	35 %	50 °C	+++
	conc.	50 °C	++++

4.8 Chemical resistance of the readers and transponders

Substance	Test conditions		Evaluation
	Concentration [%]	Temperature [°C]	
Sulfur dioxide	low	50 °C	++++
	moist	20 °C	++++
	moist	50 °C	++
	liquid	50 °C	o
Sulfuric acid	1 ... 6 / 40 / 80	50 °C	++++
	20 %	20 °C	++++
	20 %	50 °C	+++
	60 %	20 °C	++++
	60 %	50 °C	++
	95 %	20 °C	++
	95 %	50 °C	o
	fuming	20 °C	o
Hydrogen sulfide	low / saturated	50 °C	++++
Detergent	high	50 °C	++++
Water	-	50 °C	++++
Hydrogen	technically clean	50 °C	++++
Plasticizer	-	20 °C	++++
	-	50 °C	++

Explanation of the rating	
++++	Resistant
+++	Practically resistant
++	Conditionally resistant
+	Less resistant
o	Not resistant
conc.	Concentrated solution
w.	Water solution
c. s.	Cold saturated

4.8.2.8 Polyphenylene sulfide (PPS)

The following table provides an overview of the chemical resistance of the transponder made of polyphenylene sulfide (PPS). The transponder has special chemical resistance to solutions up to a temperature of 200 °C. A reduction in the mechanical properties has been observed in aqueous solutions of hydrochloric acid (HCl) and nitric acid (HNO₃) at 80 °C. The plastic housings are resistant to all types of fuel including methanol.

Table 4- 19 Chemical resistance - polyphenylene sulfide (PPS)

Substance	Test conditions		Evaluation
	Concentration [%]	Temperature [°C]	
Acetone	-	55 °C	++++
n-butanol (butyl alcohol)	-	80 °C	++++
Butanone-2 (methyl ethyl ketone)	-	60 °C	++++
n-butyl acetate	-	80 °C	++++
Brake fluid	-	80 °C	++++
Calcium chloride (saturated)	-	80 °C	++++
Diesel fuel	-	80 °C	++++
Diethyl ether	-	23 °C	++++
Frigene 113	-	23 °C	++++
Anti-freeze	-	120 °C	++++
Kerosene	-	60 °C	++++
Methanol	-	60 °C	++++
Engine oil	-	80 °C	++++
Sodium chloride (saturated)	-	80 °C	++++
Sodium hydroxide	30 %	80 °C	++++
Sodium hypochlorite (30 or 180 days)	5 %	80 °C	++
	5 %	80 °C	-
Sodium hydroxide solution	30 %	90 °C	++++
Nitric acid	10 %	23 °C	++++
Hydrochloric acid	10 %	80 °C	-
Sulfuric acid	10 %	23 °C	++++
	10 %	80 °C	++
	30 %	23 °C	++++
Tested fuels	-	80 °C	++++
FAM testing fluid acc. to DIN 51 604-A Toluene	-	80 °C	++
1, 1, 1-Trichloroethane Xylene	-	80 °C	++++
Zinc chloride (saturated)	-	80 °C	++
	-	75 °C	++++

Explanation of the rating	
++++	Resistant
+++	Practically resistant
++	Conditionally resistant
+	Less resistant
○	Not resistant

4.8.2.9 Polyvinyl chloride (PVC)

The following table provides an overview of the chemical resistance of the transponder made of polyvinyl chloride (PVC).

Table 4- 20 Chemical resistance - polyvinyl chloride (PVC)

Substance	Test conditions		Evaluation
	Concentration [%]	Temperature [°C]	
Salt water	5 %	-	++++
Sugared water	10 %	-	++++
Acetic acid, w.	5 %	-	++++
Sodium carbonate, w.	5 %	-	++++
Ethyl alcohol, w.	60 %	-	++++
Ethylene glycol	50 %	-	++++
Fuel B (acc. to ISO 1817)	-	-	++++
Human sweat	-	-	++++

Explanation of the rating	
++++	Resistant
+++	Practically resistant
++	Conditionally resistant
+	Less resistant
○	Not resistant
w.	Water solution

4.9 Regulations applicable to frequency bands

Overview of the frequency bands

The frequency ranges are standardized by EPCglobal Inc. Since these are changed regularly, we recommend that you check the current country-specific frequency bands and approvals directly on the Internet page of EPCglobal®.

You will find the current country-specific frequency bands and approvals on the following Internet page:

EPCglobal (http://www.gs1.org/docs/epcglobal/UHF_Regulations.pdf)

You will find a list of all the country-specific approvals for SIMATIC RFID systems on the following Internet page:

Wireless approvals of SIMATIC RFID systems (<http://www.siemens.com/rfid-approvals>)

4.10 Guidelines for electromagnetic compatibility (EMC)

4.10.1 Overview

These EMC directives answer the following questions:

- Why are EMC directives necessary?
- What types of external interference have an impact on the system?
- How can interference be prevented?
- How can interference be eliminated?
- Examples of interference-free plant design

The description is aimed at "qualified personnel":

- Configuration engineers and planners who plan system configurations with RFID modules and have to observe the necessary guidelines.
- Installation and service engineers who install the connecting cables in accordance with this description or who rectify defects in this area in the event of interference.

Note

Observe the EMC directives

Failure to observe the specifically emphasized notes can result in dangerous conditions in the plant or the destruction of individual components or the entire plant.

4.10.2 What does EMC mean?

The increasing use of electrical and electronic devices is accompanied by:

- Higher component density
- More switched power electronics
- Increasing switching rates
- Lower power consumption of components due to steeper switching edges

The higher the degree of automation, the greater the risk of interaction between devices.

Electromagnetic compatibility (EMC) is the ability of an electrical or electronic device to operate satisfactorily in an electromagnetic environment without affecting or interfering with the environment over and above certain limits.

EMC can be broken down into three different areas:

- Internal immunity to interference:
Immunity to internal (own) electrical disturbance
- External immunity to interference:
Immunity to external electromagnetic disturbances
- Degree of interference emission:
Emission of interference and its effect on the electrical environment

All three areas are considered when testing an electrical device.

The RFID modules are tested for conformity with the limit values required by the CE and RED directives. Since the RFID modules are merely components of an overall system, and sources of interference can arise as a result of combining different components, certain directives have to be followed when setting up a plant.

EMC measures usually consist of a complete package of measures, all of which need to be implemented in order to ensure that the plant is immune to interference.

Note

Adherence to EMC directives

The plant manufacturer is responsible for the observance of the EMC directives; the plant operator is responsible for radio interference suppression in the overall plant.

All measures taken when setting up the plant prevent expensive retrospective modifications and interference suppression measures.

The plant operator must comply with the locally applicable laws and regulations. They are not covered in this document.

4.10.3 Basic rules

It is often sufficient to follow a few elementary rules in order to ensure electromagnetic compatibility (EMC).

The following rules must be observed:

Shielding by enclosure

- Protect the device against external interference by installing it in a cabinet or housing. The housing or enclosure must be connected to the chassis ground.
- Use metal plates to shield against electromagnetic fields generated by inductances.
- Use metal connector housings to shield data conductors.

Wide-area ground connection

- Plan a meshed grounding concept.
- Bond all passive metal parts to chassis ground, ensuring large-area and low-HF-impedance contact.
- Establish a large-area connection between the passive metal parts and the central grounding point.
- Don't forget to include the shielding bus in the chassis ground system. That means the actual shielding busbars must be connected to ground by large-area contact.
- Aluminium parts are not suitable for ground connections.

Plan the cable installation

- Break the cabling down into cable groups and install these separately.
- Always route power cables, signal cables and HF cables through separated ducts or in separate bundles.
- Feed the cabling into the cabinet from one side only and, if possible, on one level only.
- Route the signal cables as close as possible to chassis surfaces.
- Twist the feed and return conductors of separately installed cables.
- Routing HF cables:
avoid parallel routing of HF cables.
- Do not route cables through the antenna field.

Shielding for the cables

- Shield the data cables and connect the shield at both ends.
- Shield the analog cables and connect the shield at one end, e.g. on the drive unit.
- Always apply large-area connections between the cable shields and the shielding bus at the cabinet inlet and make the contact with clamps.

- Feed the connected shield through to the module without interruption.
- Use braided shields, not foil shields.

Line and signal filter

- Use only line filters with metal housings
- Connect the filter housing to the cabinet chassis using a large-area low-HF-impedance connection.
- Never fix the filter housing to a painted surface.
- Fix the filter at the control cabinet inlet or in the direction of the source.

4.10.4 Propagation of electromagnetic interference

Three components have to be present for interference to occur in a system:

- Interference source
- Coupling path
- Interference sink



Figure 4-19 Propagation of interference

If one of the components is missing, e.g. the coupling path between the interference source and the interference sink, the interference sink is unaffected, even if the interference source is transmitting a high level of noise.

The EMC measures are applied to all three components, in order to prevent malfunctions due to interference. When setting up a plant, the manufacturer must take all possible measures in order to prevent the occurrence of interference sources:

- Only devices fulfilling limit class A of VDE 0871 may be used in a plant.
- Interference suppression measures must be introduced on all interference-emitting devices. This includes all coils and windings.
- The design of the system must be such that mutual interference between individual components is precluded or kept as small as possible.

Information and tips for plant design are given in the following sections.

Interference sources

In order to achieve a high level of electromagnetic compatibility and thus a very low level of disturbance in a plant, it is necessary to recognize the most frequent interference sources. These must then be eliminated by appropriate measures.

Table 4- 21 Interference sources: origin and effect

Interference source	Interference results from	Effect on the interference sink
Contactor, electronic valves	Contacts	System disturbances
	Coils	Magnetic field
Electrical motor	Collector	Electrical field
	Winding	Magnetic field
Electric welding device	Contacts	Electrical field
	Transformer	Magnetic field, system disturbance, transient currents
Power supply unit, switched- mode	Circuit	Electrical and magnetic field, system disturbance
High-frequency appliances	Circuit	Electromagnetic field
Transmitter (e.g. professional mobile radio)	Antenna	Electromagnetic field
Ground or reference potential difference	Voltage difference	Transient currents
Operator	Static charge	Electrical discharge currents, electrical field
Power cable	Current flow	Electrical and magnetic field, system disturbance
High-voltage cable	Voltage difference	Electrical field

What interference can affect RFID?

Table 4- 22 Interference sources: Causes and remedies

Interference source	Cause	Remedy
Switched-mode power supply	Interference emitted from the current infeed	Replace the power supply
Interference injected through the cables connected in series	Cable is inadequately shield- ed	Better cable shielding
	The reader is not connected to ground.	Ground the reader

Interference source	Cause	Remedy
HF interference over the antennas	caused by another reader	<ul style="list-style-type: none"> Position the antennas further apart. Erect suitable damping materials between the antennas. Reduce the power of the readers. Please follow the instructions in the section <i>Installation guidelines/reducing the effects of metal</i>

4.10.5 Equipotential bonding

Potential differences between different parts of a plant can arise due to the different design of the plant components and different voltage levels. If the plant components are connected across signal cables, transient currents flow across the signal cables. These transient currents can corrupt the signals.

Proper equipotential bonding is thus essential.

- The equipotential bonding conductor must have a sufficiently large cross section (at least 10 mm²).
- The distance between the signal cable and the associated equipotential bonding conductor must be as small as possible (antenna effect).
- A fine-strand conductor must be used (better high-frequency conductivity).
- When connecting the equipotential bonding conductors to the centralized equipotential bonding strip (EBS), the power components and non-power components must be combined.
- The equipotential bonding conductors of the separate modules must lead directly to the equipotential bonding strip.

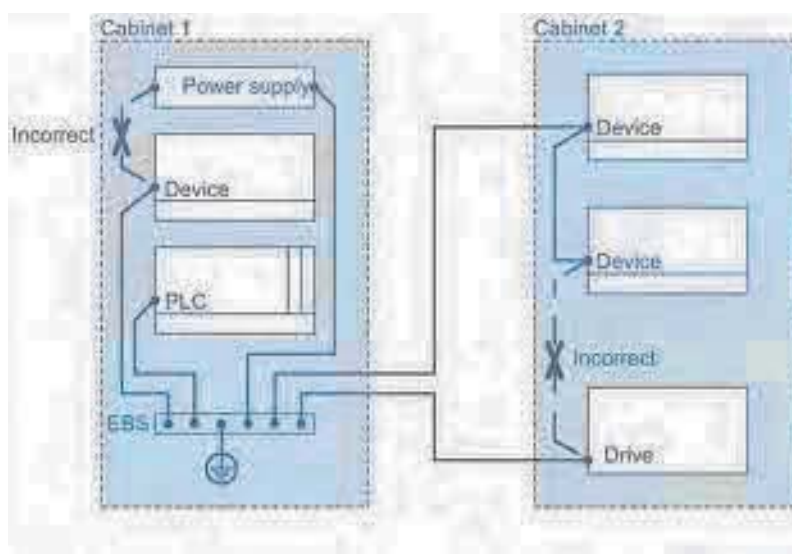

Figure 4-20 Equipotential bonding (EBS = Equipotential bonding strip)

The better the equipotential bonding in a plant, the smaller the chance of interference due to fluctuations in potential.

Equipotential bonding should not be confused with protective earthing of a plant. Protective earthing prevents the occurrence of excessive contact voltages in the event of equipment faults whereas equipotential bonding prevents the occurrence of differences in potential.

4.10.6 Cable shielding

Signal cables must be shielded in order to prevent coupling of interference.

The best shielding is achieved by installing the cables in steel tubes. However, this is only necessary if the signal cable is routed through an environment prone to particular interference. It is usually adequate to use cables with braided shields. In either case, however, correct connection is vital for effective shielding.

The following generally applies:

- For analog signal cables, the shield has to be connected at one end on the receiver side
- For digital signals, the shield has to be connected to the enclosure at both ends
- Since interference signals are frequently within the HF range (> 10 kHz), a large-area HF-proof shield contact is necessary

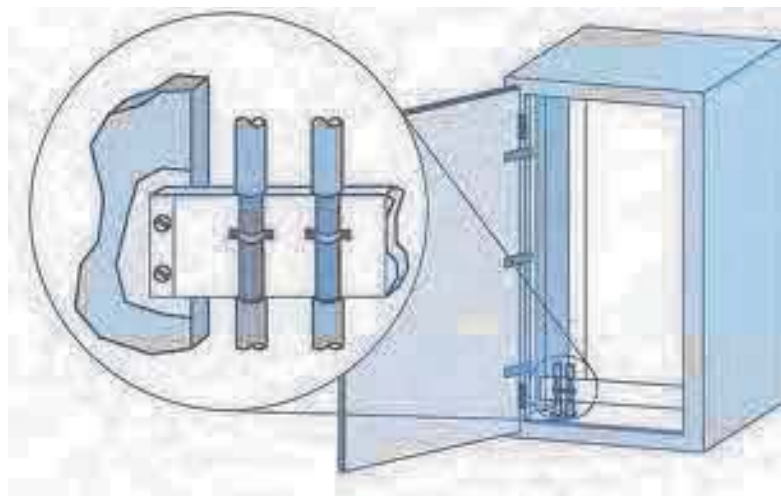

Figure 4-21 Cable shielding

The shielding bus should be connected to the control cabinet enclosure in a manner allowing good conductance (large-area contact) and must be situated as close as possible to the cable inlet. The cable insulation must be removed and the cable clamped to the shielding bus (high-frequency clamp) or secured using cable ties. Care should be taken to ensure that the connection allows good conductance.

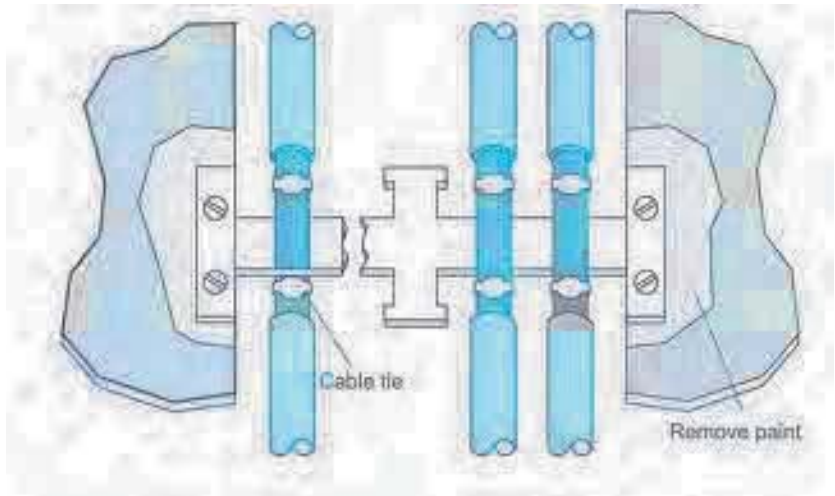

Figure 4-22 Connection of shielding bus

The shielding bus must be connected to the PE busbar.

If shielded cables have to be interrupted, the shield must be continued via the corresponding connector housing. Only suitable connectors may be used for this purpose.

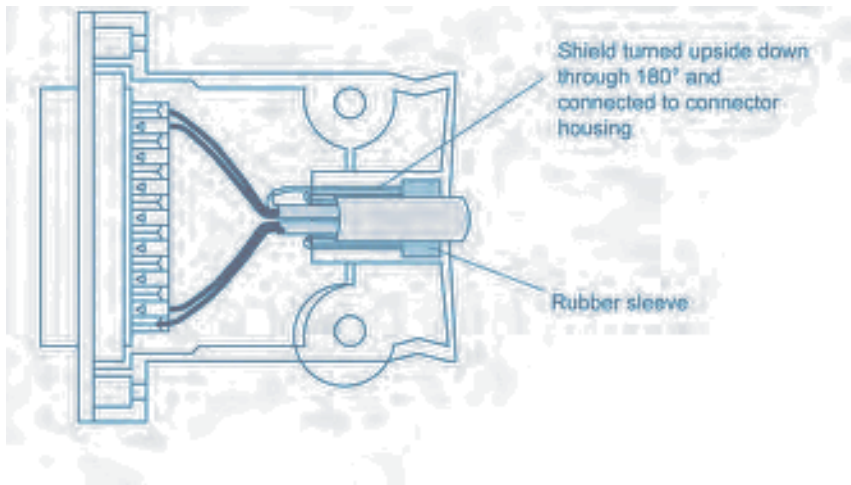

Figure 4-23 Interruption of shielded cables

If intermediate connectors, which do not have a suitable shield connection are used, the shield must be continued by fixing cable clamps at the point of interruption. This ensures a large-area, HF-conducting contact.

Readers

5.1 Overview

The following table shows the most important features of the stationary RF600 readers at a glance:

Table 5- 1 Characteristics of the readers

Characteristics	SIMATIC RF610R	SIMATIC RF615R	SIMATIC RF650R	SIMATIC RF680R	SIMATIC RF685R
Air interface / standards supported	ISO 18000-62 ISO 18000-63				
Radio profile variants	ETSI, FCC, CMIIT		ETSI, FCC, CMIIT, ARIB (STD-T107)	ETSI, FCC, CMIIT, ARIB (STD-T106)	
LEDs	7		6	17	
Interfaces					
Number of external antennas via RP-TNC	--	1	4		1
Available internal antennas	1		--		1
Ethernet	1 x M12 connector (4-pin)		1 x RJ45 connector (8-pin) according to IEC PAS 61076-3-117	2 x M12 connector (4-pin)	
PROFINET	✓		--	✓	
RS-422	1 x plug (M12, 8-pin) ¹⁾		--	1 x plug (M12, 8-pin) ¹⁾	
Digital inputs	--	1 x (M12, 5-pin) log "0": 0...7 V log "1": 15...24 V	4 x (M12, 12-pin) log "0": 0...7 V log "1": 15...24 V		
Digital outputs (short-circuit-proof)	--	1 x (M12, 5-pin)	4 x (M12, 12-pin)		
Power supply	24 V DC (M12, 8-pin) 20...30 V (0.3 A) external		24 V DC (M12, 8-pin) 20...30 V (2 A) external		

5.1 Overview

Characteristics	SIMATIC RF610R	SIMATIC RF615R	SIMATIC RF650R	SIMATIC RF680R	SIMATIC RF685R
Max. radiated power ETSI in ERP	200 mW ERP	200 mW ERP ²⁾ 1 W ERP	2 W ERP		2 W ERP ²⁾ 2 W ERP
Max. radiated power CMIIT in ERP	250 mW ERP	250 mW ERP ²⁾ 1 W ERP	2 W ERP		2 W ERP ²⁾ 2 W ERP
Max. radiated power FCC in EIRP	400 mW EIRP	400 mW EIRP ²⁾ 1.8 W EIRP	4 W EIRP		4 W EIRP ²⁾ 4 W EIRP
Max. radiated power ARIB in EIRP	--		0.5 W EIRP	4 W EIRP	
Max. transmit power ETSI and CMIIT ³⁾	26 dBm 0.4 W		30 dBm 1 W	33 dBm 2 W	
Max. transmit power FCC ³⁾	26 dBm 0.4 W		30 dBm 1 W	33 dBm 2 W	
Max. transmit power ARIB ³⁾	--		24 dBm 0.25 W	30 dBm 1 W	
Max. transmission speed of the communications interface ⁴⁾	100 Mbps or 115.2 kbps		100 Mbps	100 Mbps or 115.2 kbps	
Max. transmission speed reader → transponder	80 kbps				
Max transmission speed transponder → reader	400 kbps				

- 1) Connection of the readers to the ASM 456 communications module
- 2) Internal antenna
- 3) With a profile with a Tx transmission seed of 80 kbps (Tari = 12.5 us) the transmit power is 1 W.
- 4) A transmission speed of 10 Mbps is not supported.

Note

License requirement for ARIB STD-106 wireless profile

Note that the ARIB STD-106 wireless profile requires a license. When using the SIMATIC RF680R and RF685R readers in the ARIB STD-106 wireless profile, you need a valid license from the relevant authority.

5.2 SIMATIC RF610R

5.2.1 Description

5.2.1.1 Overview

The SIMATIC RF610R is a stationary reader in the UHF frequency band with an integrated antenna.

The maximum transmit power is 400 mW, the radiant power of the internal antenna is 200 or 250 mW ERP / 400 mW EIRP. The interfaces (Ethernet, power supply) are located on the lower front edge. These interfaces can be used to connect the reader to the power supply and a PC for parameter assignment.

The degree of protection is IP67.

	Pos.	Description
	①	"PRESENCE" LED (PRE)
	②	LED operating display
	③	Interface to power supply (RS422), 24 V DC ¹⁾ : X80 DC24V (M12, 8-pin)
	④	Ethernet interface, TCP/IP: X1 P1 (M12, 4-pin)

¹) Connection of the readers to the ASM 456 communications module via the RS-422 interface.

5.2.1.2 Ordering data

Table 5- 2 RF610R ordering data

Product	Article number
RF610R (ETSI)	6GT2811-6BC10-0AA0
RF610R (FCC)	6GT2811-6BC10-1AA0
RF610R (CMIIT)	6GT2811-6BC10-2AA0

Table 5- 3 Ordering data accessories

Product	Article number
SIMATIC antenna holder for RF600 devices	6GT2890-2AB10
Connecting cable and connectors	
<ul style="list-style-type: none"> Ethernet plug on the reader FastConnect M12 (IP65) 	6GK1901-0DB20-6AA0
<ul style="list-style-type: none"> Ethernet plug Standard IE FastConnect RJ45 180 (IP20) 	6GK1901-1BB10-2AA0
<ul style="list-style-type: none"> Industrial Ethernet cable M12 / M12 	5 m 6XV1870-8AH50
<ul style="list-style-type: none"> Industrial Ethernet connecting cable M12-180 / RJ45 	2 m 6XV1871-5TH20
	3 m 6XV1871-5TH30
	5 m 6XV1871-5TH50
<ul style="list-style-type: none"> Industrial Ethernet cable by the meter, green (minimum 20 m) 	6XV1840-2AH10
<ul style="list-style-type: none"> Connecting cable reader ↔ CM M12-180 / M12-180 	2 m 6GT2891-4FH20
	5 m 6GT2891-4FH50
	10 m 6GT2891-4FN10
	20 m 6GT2891-4FN20
	50 m 6GT2891-4FN50
Wide-range power supply unit for SIMATIC RF systems	
<ul style="list-style-type: none"> With EU plug 	6GT2898-0AC00
<ul style="list-style-type: none"> With UK plug 	6GT2898-0AC10
<ul style="list-style-type: none"> With US plug 	6GT2898-0AC20
24 V connecting cable reader ↔ wide-range power supply unit	
with plug, 5 m	6GT2891-0PH50
with open ends, 2 m	6GT2891-4EH20
with open ends, 5 m	6GT2891-4EH50
DVD "Ident Systems Software & Documentation"	6GT2080-2AA20

5.2.1.3 Pin assignment of the power supply interface (X80 24VDC)

Table 5- 4 Pin assignment of the RS422 interface (reader end)

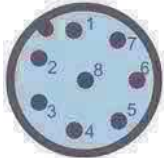
View of interface (M12 socket, 8-pin)	Pin	Wire colors	Assignment
	1	White	+ 24 V
	2 ¹⁾	Brown	- Tx
	3	Green	0 V
	4 ¹⁾	Yellow	+ Tx
	5 ¹⁾	Gray	+ Rx
	6 ¹⁾	Pink	- Rx
	7	--	Unassigned
	8	--	Earth (shield)

¹⁾ These pins are not required if the reader is operated via Ethernet.

Note

Requirement for external power sources

The reader must only be supplied with power by power supply units that meet the requirements of LPS (Limited Power Source) and NEC Class 2.

Requirement for external power sources

The reader must only be supplied with power by power supply units that meet the requirements of limited power source (LPS) and NEC Class 2.

Spécification des sources de tension externes

L'alimentation du plot de lecture/écriture doit être exclusivement assurée par des blocs d'alimentation conformes aux spécifications des sources à puissance limitée (Limited Power Sources LPS) et de NEC class 2.

Notes on connectors and cables

The cables with open cable ends (6GT2891-4EH20, 6GT2891-4EH50) have an 8-pin M12 plug at one end, while the other end of the cable is "open". There are 8 color-coded single wires there for connecting to external devices.

The product range includes additional cables of the type 6GT2891-4Fxxx (2 to 50 m) with an M12 connector at both ends. These cables can be used as extension cables. Long cables can be shortened if necessary.

NOTICE

Insulate unused single wires

Unused single wires must be insulated individually to prevent unwanted connections of signal lines.

NOTICE

For long cables: Adapt the power supply and transmission speed

Note that even with long cables, the supply voltage of 24 VDC must always be guaranteed. Note also that the transmission speed on the serial interface must, if necessary, be reduced.

SIMATIC standard cables (e.g. 6GT2891-4FN10) have a loop resistance of 160 mOhm / meter. This results in a voltage drop of 0.8 volts on the 24 V cable for every 10 meters of connecting cable and with a power requirement of 500 mA. If the power requirement increases through the use of the digital inputs/outputs, the voltage drop increases accordingly.

5.2.1.4 Pin assignment of the Industrial Ethernet interface (X1 P1)

Table 5- 5 Pin assignment of the Industrial Ethernet interface (reader end)

View of interface (M12 socket, 4-pin)	Pin	Pin assignment
	1	Data line +Tx
	2	Data line +Rx
	3	Data line -Tx
	4	Data line -Rx

5.2.1.5 Ground connection

Due to the potential-free design of the reader, no earthing measures are required.

5.2.2 Planning operation

5.2.2.1 Internal antenna

Minimum mounting clearances of two readers

RF610R has an internal circular antenna. To prevent the antenna fields from overlapping, always observe the recommended minimum distances between two readers as described in the section "Reciprocal influence of read points (Page 47)".

Dense Reader Mode (DRM)

The readers can also interfere with each other (secondary fields), if the channels (Reader TX, Transponder TX) overlap. In order to prevent a transponder channel overlapping with a reader channel, we recommend that the Dense Reader Mode (DRM) is used.

Note

Protective cap

If you only use the internal antenna of the reader, we recommend that you close the external, unused antenna connector on the reader using the protective cap.

Antenna diagram RF610R (ETSI)

The following radiation diagrams show the directional characteristics of the internal antenna of the RF610R (ETSI) reader. For the spatial presentation of the directional characteristics, the horizontal plane (azimuth section) as well as the vertical plane (elevation section) must be considered. This results in a spatial image of the directional radiation pattern of the antenna.

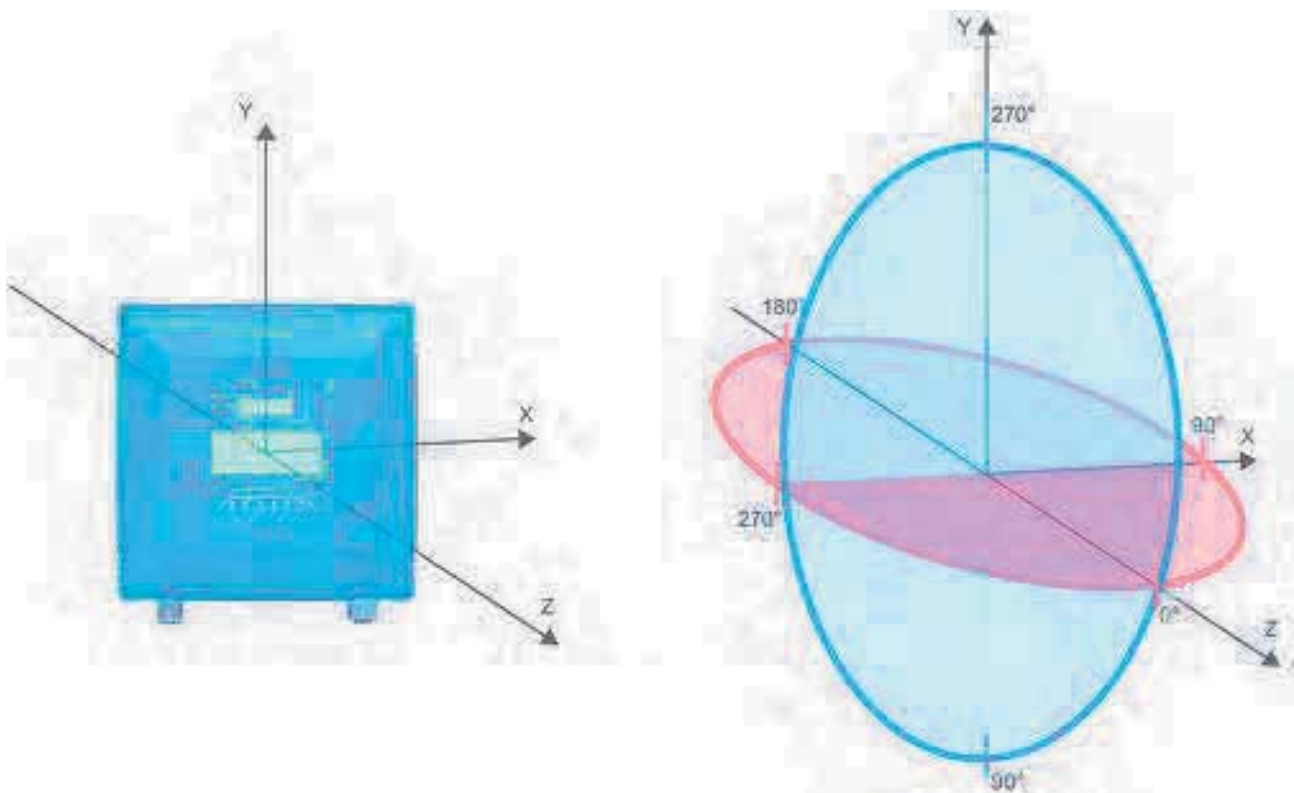

Figure 5-1 Reference system

Radiation diagram (ETSI)

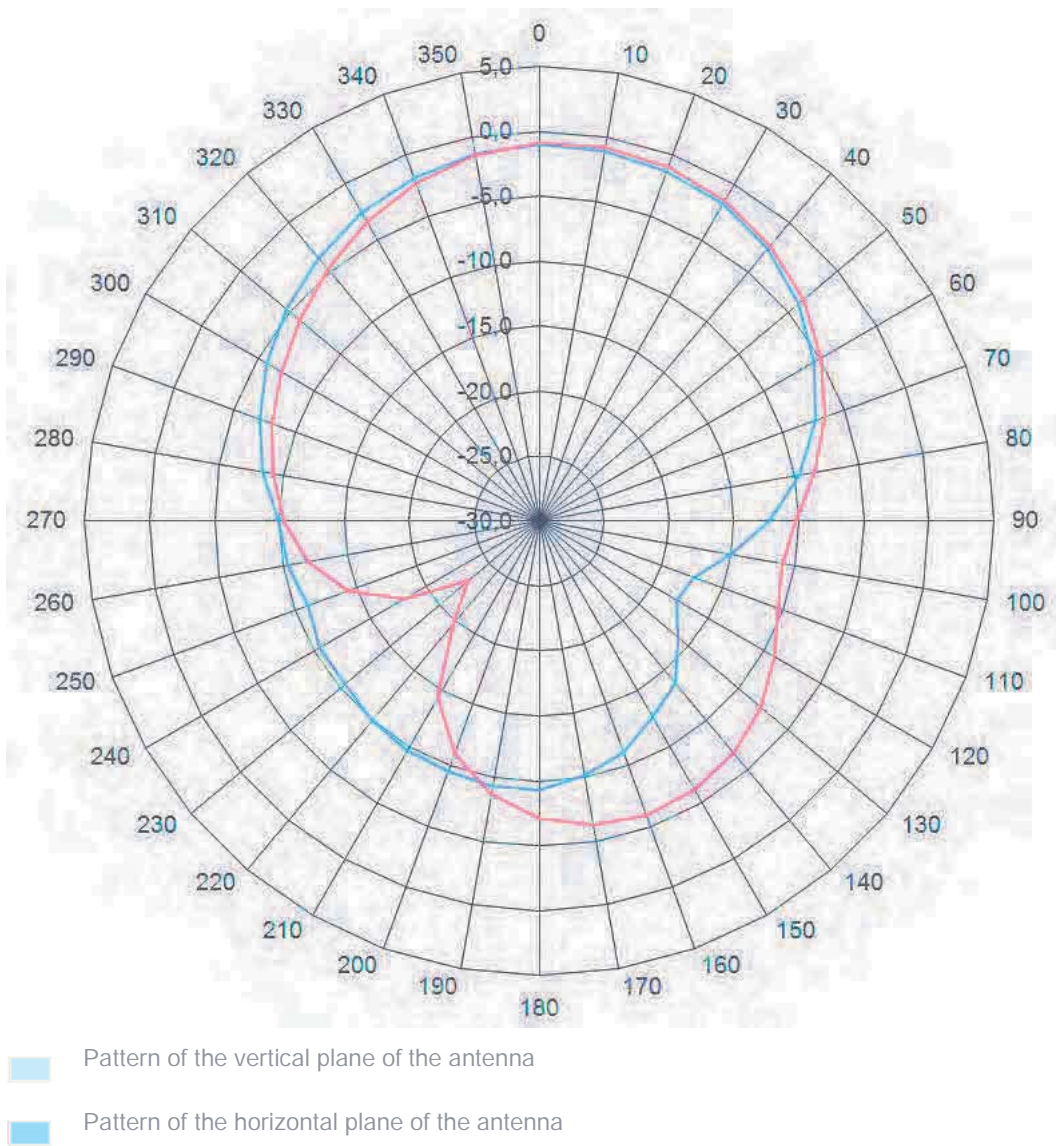

Figure 5-2 Directional radiation pattern of RF610R in the ETSI frequency band

Overview of the antenna parameters

Table 5- 6 Maximum linear electrical aperture angle at 865 MHz:

	Polarization (circular)
Azimuth section	100°
Elevation section	100°
Typical antenna gain in the frequency band 865 to 868 MHz	-1 dBi
Antenna axis ratio	2 dB

You will find more information on the antennas in the section "Guidelines for selecting RFID UHF antennas (Page 51)".

Antenna diagram for RF610R (FCC)

The following radiation diagrams show the directional characteristics of the internal antenna of the RF610R (FCC) reader. For the spatial presentation of the directional characteristics, the horizontal plane (azimuth section) as well as the vertical plane (elevation section) must be considered. This results in a spatial image of the directional radiation pattern of the antenna.

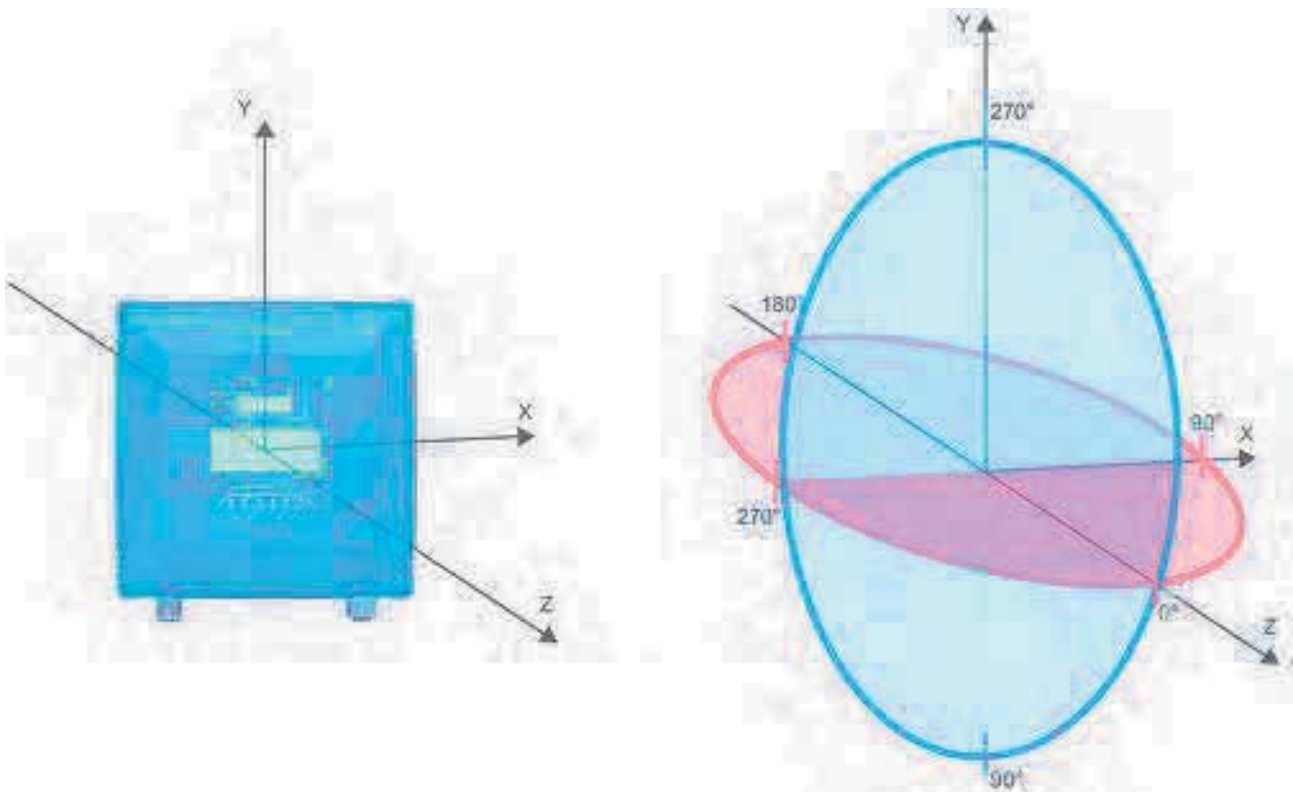
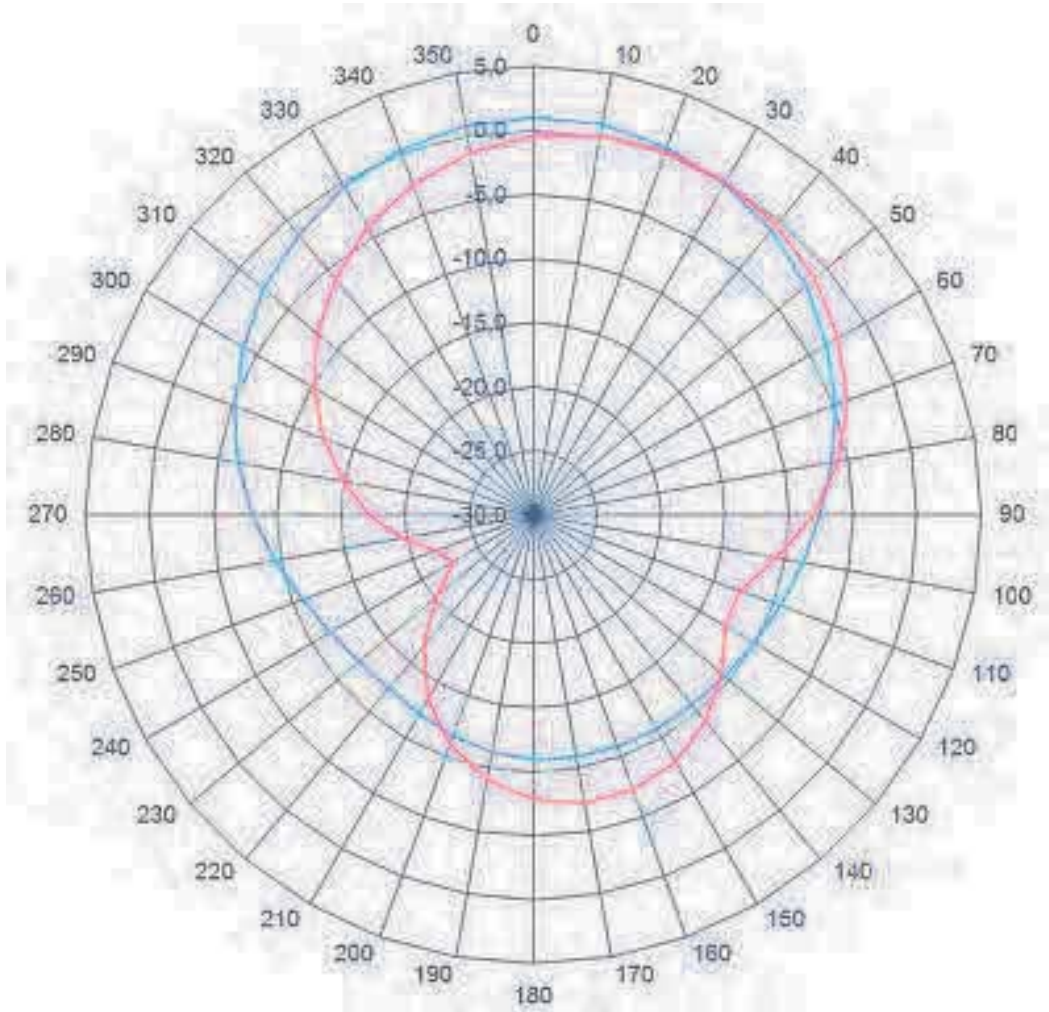

Figure 5-3 Reference system

Radiation diagram (FCC)



- Pattern of the vertical plane of the antenna
- Pattern of the horizontal plane of the antenna

Figure 5-4 Directional radiation pattern of RF610R in the FCC frequency band

Overview of the antenna parameters

Table 5- 7 Maximum linear electrical aperture angle at 915 MHz:

	Polarization (circular)
Azimuth section	100°
Elevation section	100°
Typical antenna gain in the frequency band 902 to 928 MHz	0 dBi
Antenna axis ratio	2 dB

You will find more information on the antennas in the section "Guidelines for selecting RFID UHF antennas (Page 51)".

5.2.2.2 Interpretation of radiation patterns

You can find detailed information on the interpretation in the section "Interpretation of radiation patterns (Page 215)".

5.2.3 Installation / mounting

Requirement

NOTICE

Close unused connectors

Note that the readers only have the specified degree of protection when all connectors are in use or when unused connectors are closed with the protective caps.

CAUTION

Emitted radiation

The transmitter complies with the requirements of Health Canada and the FCC limit values for subjecting persons to HF radiation, provided that a minimum spacing of 26 cm exists between antenna and person. When the antennas are installed, you must therefore ensure that a minimum spacing of 26 cm is maintained between personnel and antennas.

Mounting/installing the device

You can mount the reader in the following ways:

- directly on a flat surface using the VESA 100 mounting system (torque \approx 1.5 Nm).

The positions of the mounting holes for the device are shown in the section Dimension drawing (Page 120).

5.2.4 Configuration/integration

An Ethernet interface is available for integrating the device into system environments/networks. RF610R can be configured via the Ethernet interface and with direct connection to the PC. You can configure and program the reader using the following tools:

- STEP 7 Basic/Professional (TIA Portal)
- or via EtherNet/IP
- Web Based Management (WBM)
- OPC UA or XML based user applications

Note that configuration in parallel is not possible using different tools. Simple process controls (e.g. a traffic signal) can be implemented directly using the reader via the digital input/output.

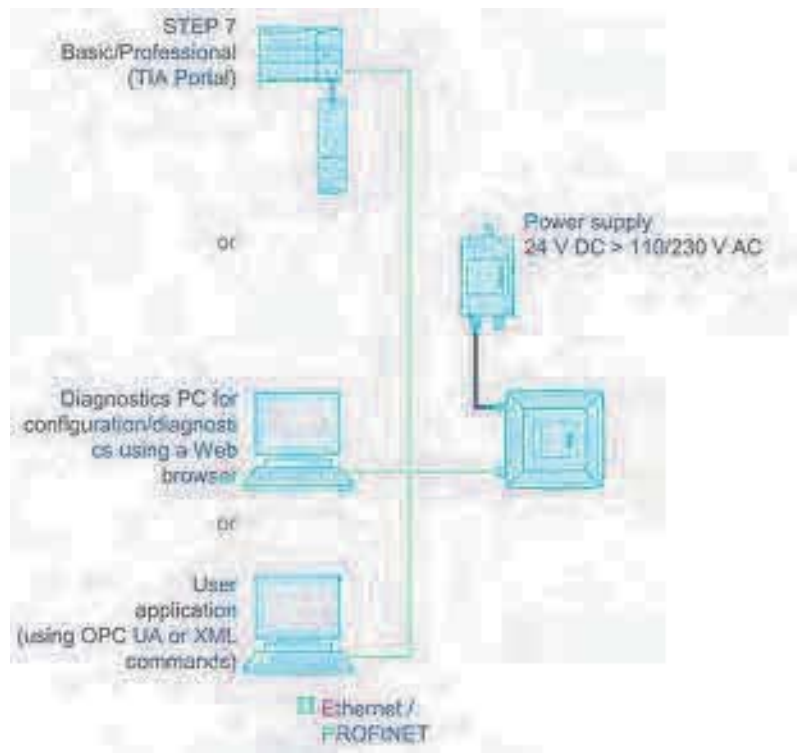

Figure 5-5 Overview: Configuration of RF610R readers

5.2.5 Technical specifications

Table 5- 8 Technical specifications of the RF610R reader

6GT2811-6BC10-xAA0	
Product type designation	SIMATIC RF610R
Radio frequencies	
Operating frequency	
• ETSI	• 865 to 868 MHz
• FCC	• 902 to 928 MHz
• CMIIT	• 920 to 925 MHz
Transmit power	
• ETSI	• 3 ... 400 mW
• FCC	• 3 ... 400 mW
• CMIIT	• 3 ... 400 mW
Maximum radiated power	
• ETSI	• 200 mW ERP
• FCC	• 400 mW EIRP
• CMIIT	• 250 mW ERP
Electrical data	
Range (internal antenna)	
• ETSI	• ≤ 1 m
• FCC	• ≤ 1 m
• CMIIT	• ≤ 1 m
Protocol	ISO 18000-62/-63
Transmission speed	≤ 300 kbps
Frequency accuracy	≤ ±10 ppm
Channel spacing	
• ETSI	• 600 kHz
• FCC	• 500 kHz
• CMIIT	• 250 kHz
Modulation methods	ASK: DSB modulation & PR-ASK modulation encoding, Manchester or Pulse Interval (PIE)
Multitag capability	Yes

6GT2811-6BC10-xAA0	
Typical transmission time per byte	
• Write access	• 2 ms
• Read access	• 0.15 ms
Supply voltage	24 VDC (20 ... 30 VDC) ¹⁾
Maximum permitted current consumption	0.3 A
Current consumption (on standby), typical	
• 20 V input voltage on the reader	• 200 mA / 4 W
• 24 V input voltage on the reader	• 170 mA / 4.1 W
• 30 V input voltage on the reader	• 150 mA / 4.2 W
Current consumption (at 400 mW transmit power), typical	
• 20 V input voltage on the reader	• 260 mA / 5.2 W
• 24 V input voltage on the reader	• 220 mA / 5.3 W
• 30 V input voltage on the reader	• 170 mA / 5.1 W
Interfaces	
Power supply	1x M12 (8-pin)
Ethernet interface	1x M12 (4-pin), 100 Mbps
Mechanical specifications	
Material	Pocan (silicone-free)
Color	TI-Grey
Permitted ambient conditions	
Ambient temperature	
• During operation	• -25 ... +55 °C
• During transportation and storage	• -40 ... +85 °C
Conditions relating to UL approval	<ul style="list-style-type: none"> • for indoor use only (dry location) • Mounting height shall be equal or less than 2 m (MS1 classification according UL/IEC 62368-1). La hauteur de montage doit être égale ou inférieure à 2 m (classification MS1 selon CEI 62368-1).
Degree of protection	IP67
Shock resistant to EN 60068-2-27	25.5 g ²⁾
Vibration to EN 60068-2-6	3.1 g ²⁾

6GT2811-6BC10-xAA0**Design, dimensions and weight**

Dimensions (W × H × D)	140.5 × 133 × 45 mm
Weight	370 g
Type of mounting	VESA 100 4x screws M4 (≈ 1.5 Nm)
Operation indicator	6 LEDs
Status display	1 LED (enclosure, all-round)

Standards, specifications, approvals

Proof of suitability	EN 301 489-1 V2.2.0 / EN 301 489-3 V2.1.1 / EN 302 208 V3.1.1 FCC CFR 47, Part 15 section 15.247
MTBF	29 years

- ¹⁾ All supply and signal voltages must be safety extra low voltage (SELV/PELV according to EN 60950). All voltage sources must meet the requirements of limited power sources (LPS) and NEC Class 2.
Note that, depending on the power consumption, using extension cables > 20 m (6GT2891-4FN50) may lead to a voltage drop on the reader. This voltage drop can mean that the necessary minimum voltage on the reader is below the required 20 V.
- ²⁾ The values for shock and vibration are maximum values and must not be applied continuously. These values only apply to mounting using screws.

5.2.6 Dimension drawing

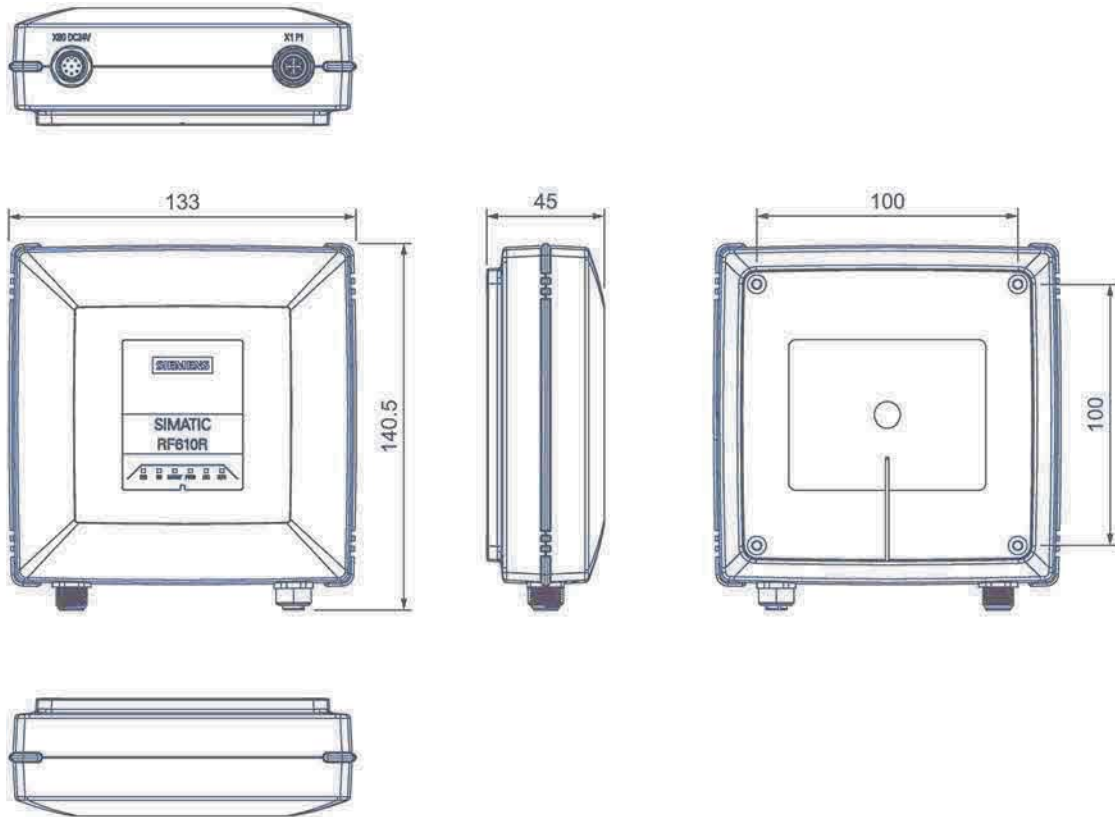

Figure 5-6 Dimension drawing RF610R

All dimensions in mm (± 0.5 mm tolerance)

5.2.7 Certificates and approvals

5.2.7.1 CE mark

Note

Marking on the readers according to specific approval

The certificates and approvals listed here apply only if the corresponding mark is found on the readers.

Table 5- 9 6GT2811-6BC10-0AA0

Labeling	Description
	Conformity with the RED directive 2014/53/EU Conformity with the RoHS directive 2011/65/EU

5.2.7.2 Country-specific certifications

Table 5- 10 6GT2811-6BC10-1AA0



Labeling	Description
 Federal Communications Commission	FCC CFR 47, Part 15 section 15.247 Radio Frequency Interference Statement This equipment has been tested and found to comply with the limits for a Class B digital device, pursuant to Part 15 of the FCC Rules. FCC ID: NXW-RF610R
Industry Canada Radio Standards Specifications	RSS-247 Issue 2 IC: 267X-RF610R
	This product is UL-certified for the USA and Canada. It meets the following safety standard(s): UL/IEC 62368-1, 2nd Ed CAN/CSA C22.2 No. 62368-1-14, 2nd Ed Audio/video, information and communication technology equipment - Part 1: Safety requirements

Table 5- 11 6GT2811-6BC10-2AA0

Standard	
CMIIT Certification	China radio approval Marking on the reader: CMIIT ID: 2018DJxxxx

5.2.7.3 FCC information

Siemens SIMATIC RF610R (FCC): 6GT2811-6BC10-1AA0

FCC ID: NXW-RF610R

This device complies with part 15 of the FCC rules. Operation is subject to the following two conditions:

- (1) This device may not cause harmful interference, and
- (2) this device must accept any interference received, including interference that may cause undesired operation.

Caution

Any changes or modifications not expressly approved by the party responsible for compliance could void the user's authority to operate the equipment.

Note

This equipment has been tested and found to comply with the limits for a Class B digital device, pursuant to part 15 of the FCC Rules.

These limits are designed to provide reasonable protection against harmful interference when the equipment is operated in a commercial environment. This equipment generates, uses, and can radiate radio frequency energy and, if not installed and used in accordance with the instruction manual, may cause harmful interference to radio communications. Operation of this equipment in a residential area is likely to cause harmful interference in which case the user will be required to correct the interference at his own expense.

FCC Notice

To comply with FCC part 15 rules in the United States, the system must be professionally installed to ensure compliance with the Part 15 certification.

It is the responsibility of the operator and professional installer to ensure that only certified systems are deployed in the United States. The use of the system in any other combination (such as co-located antennas transmitting the same information) is expressly forbidden.

FCC Exposure Information

To comply with FCC RF exposure compliance requirements, the antennas used for this transmitter must be installed to provide a separation distance of at least 20 cm from all persons and must not be co-located or operating in conjunction with any other antenna or transmitter.

5.2.7.4 IC-FCB information

Siemens SIMATIC RF610R (FCC): 6GT2811-6BC10-1AA0

IC: 267X-RF610R

This device complies with Industry Canada licence-exempt RSS standard(s). Operation is subject to the following two conditions:

- (1) This device may not cause interference, and
- (2) this device must accept any interference, including interference that may cause undesired operation of the device.

Le présent appareil est conforme aux CNR d'Industrie Canada applicables aux appareils radio exempts de licence. L'exploitation est autorisée aux deux conditions suivantes :

- (1) L'appareil ne doit pas produire de brouillage, et
- (2) l'utilisateur de l'appareil doit accepter tout brouillage radioélectrique subi, même si le brouillage est susceptible d'en compromettre le fonctionnement.

5.2.7.5 Other certificates and approvals

ISA-S71.04-1985

RF610R reader meets the requirements according to ISA-S71.04-1985 Airborne Contaminants Class G3.

5.3 SIMATIC RF615R

5.3.1 Description

5.3.1.1 Overview

The SIMATIC RF615R is a stationary reader in the UHF frequency band with an integrated antenna. An external UHF RFID antenna can be connected via an RP-TNC connector.

The maximum transmit power is 400 mW, the radiant power of the internal antenna is 200 or 250 mW ERP / 400 mW EIRP. A radiated power of up to 1000 mW ERP / 1800 mW EIRP is achieved when the appropriate antennas and antenna cables are used. The interfaces (Ethernet, power supply, DI/DQ interface) are located on the lower front edge. These interfaces can be used to connect the reader to the power supply, to a digital input/output, and to a PC for parameter assignment.

The degree of protection is IP67.

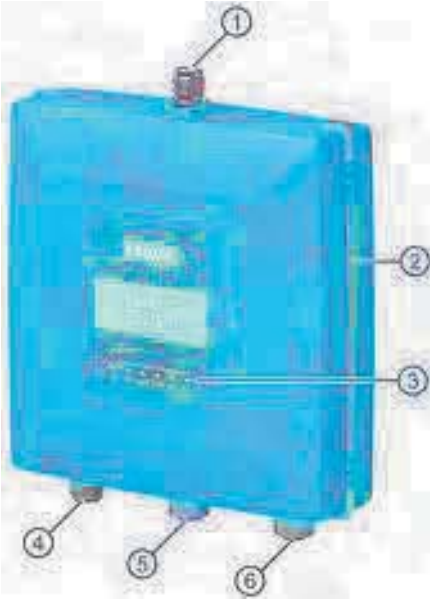
	Pos.	Description
	①	RP-TNC interface for connection of an external antenna
	②	"PRESENCE" LED (PRE)
	③	LED operating display
	④	Interface to power supply (RS422), 24 V DC ¹⁾ : X80 DC24V (M12, 8-pin)
	⑤	DI/DQ interface: X10 DI/DQ (M12, 5-pin)
	⑥	Ethernet interface, TCP/IP: X1 P1 (M12, 4-pin)

¹) Connection of the readers to the ASM 456 communications module via the RS-422 interface.

5.3.1.2 Ordering data

Table 5- 12 RF615R ordering data

Product	Article number
RF615R (ETSI)	6GT2811-6CC10-0AA0
RF615R (FCC)	6GT2811-6CC10-1AA0
RF615R (CMIIT)	6GT2811-6CC10-2AA0

Table 5- 13 Ordering data accessories

Product	Article number
SIMATIC antenna holder for RF600 devices	6GT2890-2AB10
Connecting cable and connectors	
<ul style="list-style-type: none"> DI/DO plug M12 for fabrication 	3RK1902-4BA00-5AA0
<ul style="list-style-type: none"> Ethernet plug on the reader FastConnect M12 (IP65) 	6GK1901-0DB20-6AA0
<ul style="list-style-type: none"> Ethernet plug Standard IE FastConnect RJ45 180 (IP20) 	6GK1901-1BB10-2AA0
<ul style="list-style-type: none"> Industrial Ethernet cable M12 / M12 	5 m 6XV1870-8AH50
<ul style="list-style-type: none"> Industrial Ethernet connecting cable M12-180 / RJ45 	2 m 6XV1871-5TH20
	3 m 6XV1871-5TH30
	5 m 6XV1871-5TH50
<ul style="list-style-type: none"> Industrial Ethernet cable by the meter, green (minimum 20 m) 	6XV1840-2AH10
<ul style="list-style-type: none"> Connecting cable reader ↔ CM M12-180 / M12-180 	2 m 6GT2891-4FH20
	5 m 6GT2891-4FH50
	10 m 6GT2891-4FN10
	20 m 6GT2891-4FN20
	50 m 6GT2891-4FN50
Wide-range power supply unit for SIMATIC RF systems	
<ul style="list-style-type: none"> With EU plug 	6GT2898-0AC00
<ul style="list-style-type: none"> With UK plug 	6GT2898-0AC10
<ul style="list-style-type: none"> With US plug 	6GT2898-0AC20
24 V connecting cable reader ↔ wide-range power supply unit	
<ul style="list-style-type: none"> with plug, 5 m 	6GT2891-0PH50
<ul style="list-style-type: none"> with open ends, 2 m 	6GT2891-4EH20
<ul style="list-style-type: none"> with open ends, 5 m 	6GT2891-4EH50
DVD "Ident Systems Software & Documentation"	6GT2080-2AA20

5.3.1.3 Pin assignment of the DI/DQ interface (X10 DI/DQ)

Table 5- 14 Pin assignment of the DI/DQ interface (reader end)

View of interface (M12 socket, 5-pin)	Pin	Pin assignment
	1	DI Common / Input Common
	2	DO / Output
	3	DO Common / Output Common
	4	DI / Input
	5	Not connected

Note

Requirement for external power sources

If the DI/DQ interface is supplied by means of an external power source, the power source must comply with requirements on limited power sources (LPS) and NEC Class 2.

Requirement for external power sources

If the DI/DQ interface is supplied by an external power source, the power source must comply with requirements on limited power sources (LPS) and NEC Class 2.

Spécification des sources de tension externes

En cas d'alimentation de l'interface DI/DO par une source de tension externe, la source de tension doit être conforme aux spécifications des sources à puissance limitée (Limited Power Sources LPS) et de NEC class 2.

5.3.1.4 Switching scheme for the DI/DQ interface

Connection possibilities

You can connect the reader in different ways. In general, the outputs and inputs should be connected as follows:

Output (DQ)

- The output at < 20 °C is rated for 0.5 A current (0.33 A at 55 °C) and electronically protected.
- The output is electrically isolated via optocoupler.

Input (DI)

- The input is set up with electrical isolation via optocoupler.
- Level
 - Low: 0 ... 7 V
 - High: 15 ... 24 V

The following diagrams illustrate various connection possibilities.

Note

Minimum time between changes

Note that changes on the DI/DQ interface that are not applied for at least 1.5 seconds are not detected by the reader.

Voltage infeed from external source

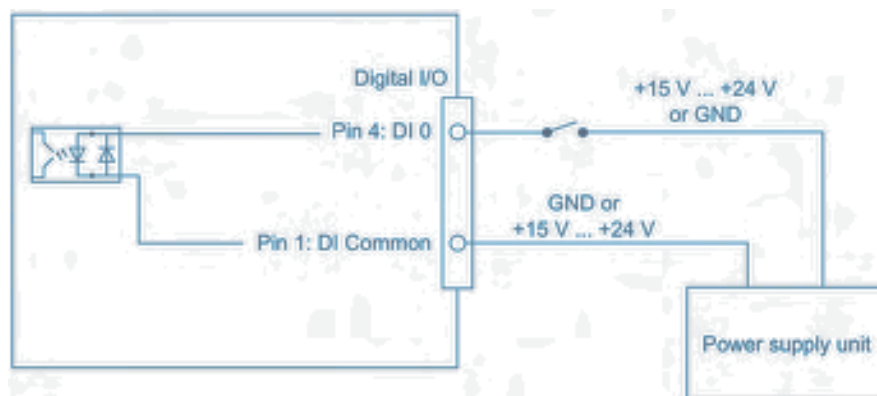

Figure 5-7 Circuit example 1: Digital input

Voltage infeed from external source

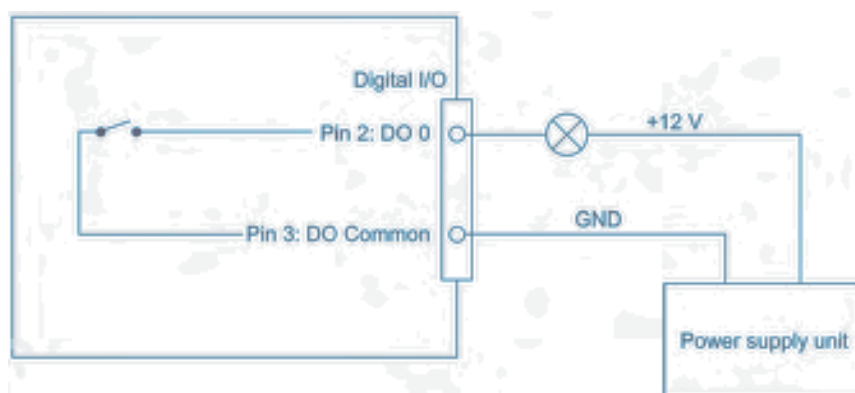
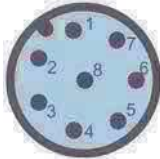

Figure 5-8 Circuit example 2: Digital output

Voltage infeed from an external source is shown here for 12 V as an example. Other voltages are also permissible.

5.3.1.5 Pin assignment of the power supply interface (X80 24VDC)

Table 5- 15 Pin assignment of the RS422 interface (reader end)

View of interface (M12 socket, 8-pin)	Pin	Wire colors	Assignment
	1	White	+ 24 V
	2 ¹⁾	Brown	- Tx
	3	Green	0 V
	4 ¹⁾	Yellow	+ Tx
	5 ¹⁾	Gray	+ Rx
	6 ¹⁾	Pink	- Rx
	7	--	Unassigned
	8	--	Earth (shield)

¹⁾ These pins are not required if the reader is operated via Ethernet.

Note

Requirement for external power sources

The reader must only be supplied with power by power supply units that meet the requirements of LPS (Limited Power Source) and NEC Class 2.

Requirement for external power sources

The reader must only be supplied with power by power supply units that meet the requirements of limited power source (LPS) and NEC Class 2.

Spécification des sources de tension externes

L'alimentation du plot de lecture/écriture doit être exclusivement assurée par des blocs d'alimentation conformes aux spécifications des sources à puissance limitée (Limited Power Sources LPS) et de NEC class 2.

Notes on connectors and cables

The cables with open cable ends (6GT2891-4EH20, 6GT2891-4EH50) have an 8-pin M12 plug at one end, while the other end of the cable is "open". There are 8 color-coded single wires there for connecting to external devices.

The product range includes additional cables of the type 6GT2891-4Fxxx (2 to 50 m) with an M12 connector at both ends. These cables can be used as extension cables. Long cables can be shortened if necessary.

NOTICE

Insulate unused single wires

Unused single wires must be insulated individually to prevent unwanted connections of signal lines.

NOTICE

For long cables: Adapt the power supply and transmission speed

Note that even with long cables, the supply voltage of 24 VDC must always be guaranteed. Note also that the transmission speed on the serial interface must, if necessary, be reduced.

SIMATIC standard cables (e.g. 6GT2891-4FN10) have a loop resistance of 160 mOhm / meter. This results in a voltage drop of 0.8 volts on the 24 V cable for every 10 meters of connecting cable and with a power requirement of 500 mA. If the power requirement increases through the use of the digital inputs/outputs, the voltage drop increases accordingly.

5.3.1.6 Pin assignment of the Industrial Ethernet interface (X1 P1)

Table 5- 16 Pin assignment of the Industrial Ethernet interface (reader end)

View of interface (M12 socket, 4-pin)	Pin	Pin assignment
	1	Data line +Tx
	2	Data line +Rx
	3	Data line -Tx
	4	Data line -Rx

5.3.1.7 Ground connection

Due to the potential-free design of the reader, no earthing measures are required.

5.3.2 Planning operation

5.3.2.1 Internal antenna

Minimum mounting clearances of two readers

RF615R has an internal circular antenna. To prevent the antenna fields from overlapping, always observe the recommended minimum distances between two readers as described in the section "Reciprocal influence of read points (Page 47)".

Dense Reader Mode (DRM)

The readers can also interfere with each other (secondary fields), if the channels (Reader TX, Transponder TX) overlap. In order to prevent a transponder channel overlapping with a reader channel, we recommend that the Dense Reader Mode (DRM) is used.

Note

Protective cap

If you only use the internal antenna of the reader, we recommend that you close the external, unused antenna connector on the reader using a protective cap.

Antenna diagram RF615R (ETSI)

The following radiation diagrams show the directional characteristics of the internal antenna of the RF615R (ETSI) reader. For the spatial presentation of the directional characteristics, the horizontal plane (azimuth section) as well as the vertical plane (elevation section) must be considered. This results in a spatial image of the directional radiation pattern of the antenna.

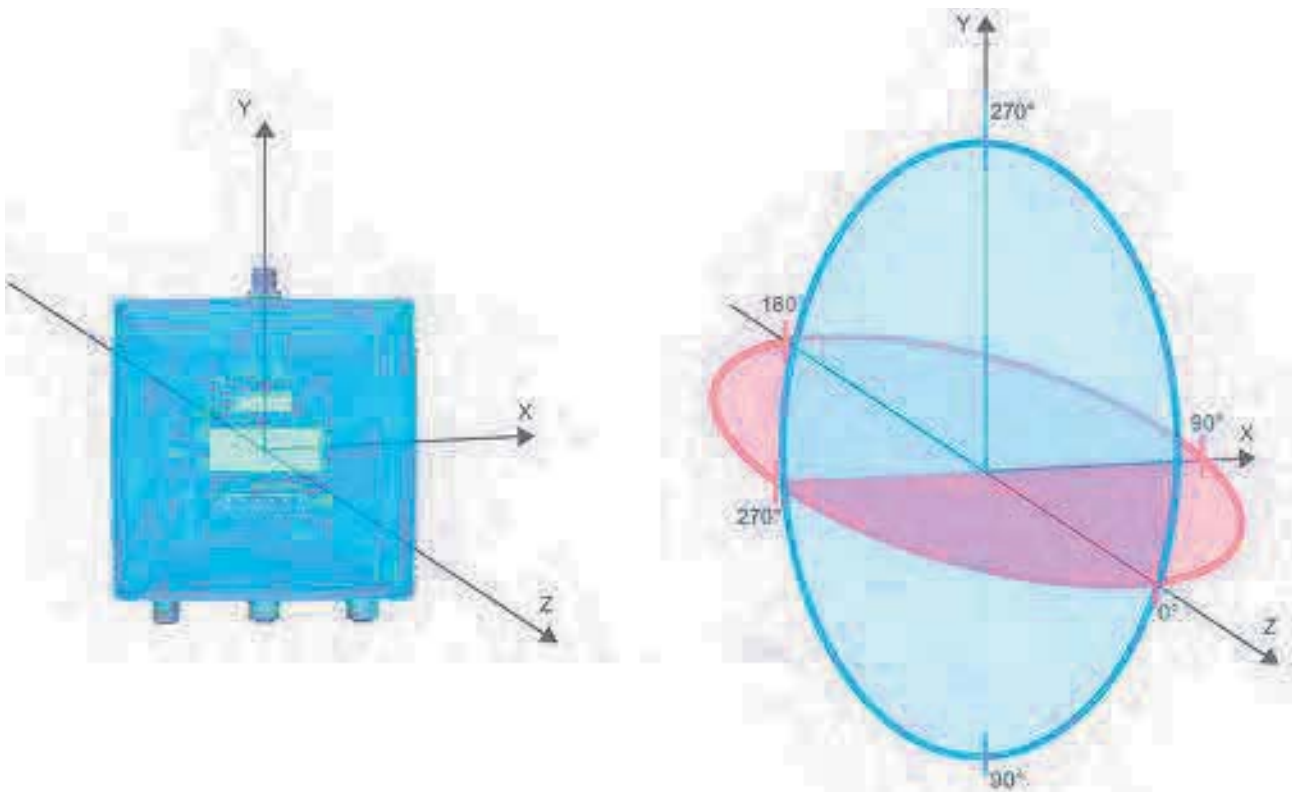

Figure 5-9 Reference system

Radiation diagram (ETSI)

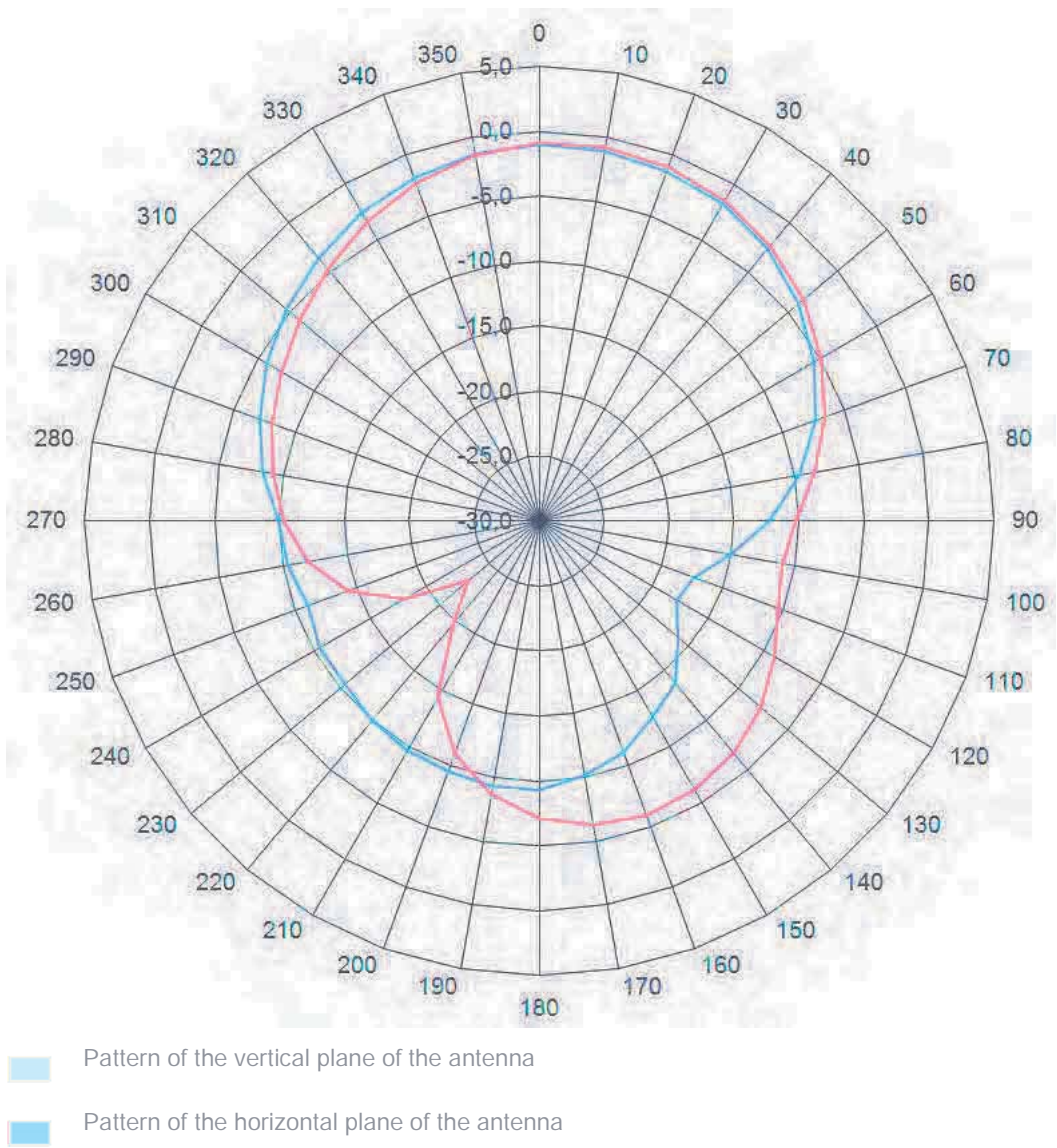

Figure 5-10 Directional radiation pattern of RF615R in the ETSI frequency band

Overview of the antenna parameters

Table 5- 17 Maximum linear electrical aperture angle at 865 MHz:

	Polarization (circular)
Azimuth section	100°
Elevation section	100°
Typical antenna gain in the frequency band 865 to 868 MHz	-1 dBi
Antenna axis ratio	2 dB

You will find more information on the antennas in the section "Guidelines for selecting RFID UHF antennas (Page 51)".

Antenna diagram for RF615R (FCC)

The following radiation diagrams show the directional characteristics of the internal antenna of the RF615R (FCC) reader. For the spatial presentation of the directional characteristics, the horizontal plane (azimuth section) as well as the vertical plane (elevation section) must be considered. This results in a spatial image of the directional radiation pattern of the antenna.

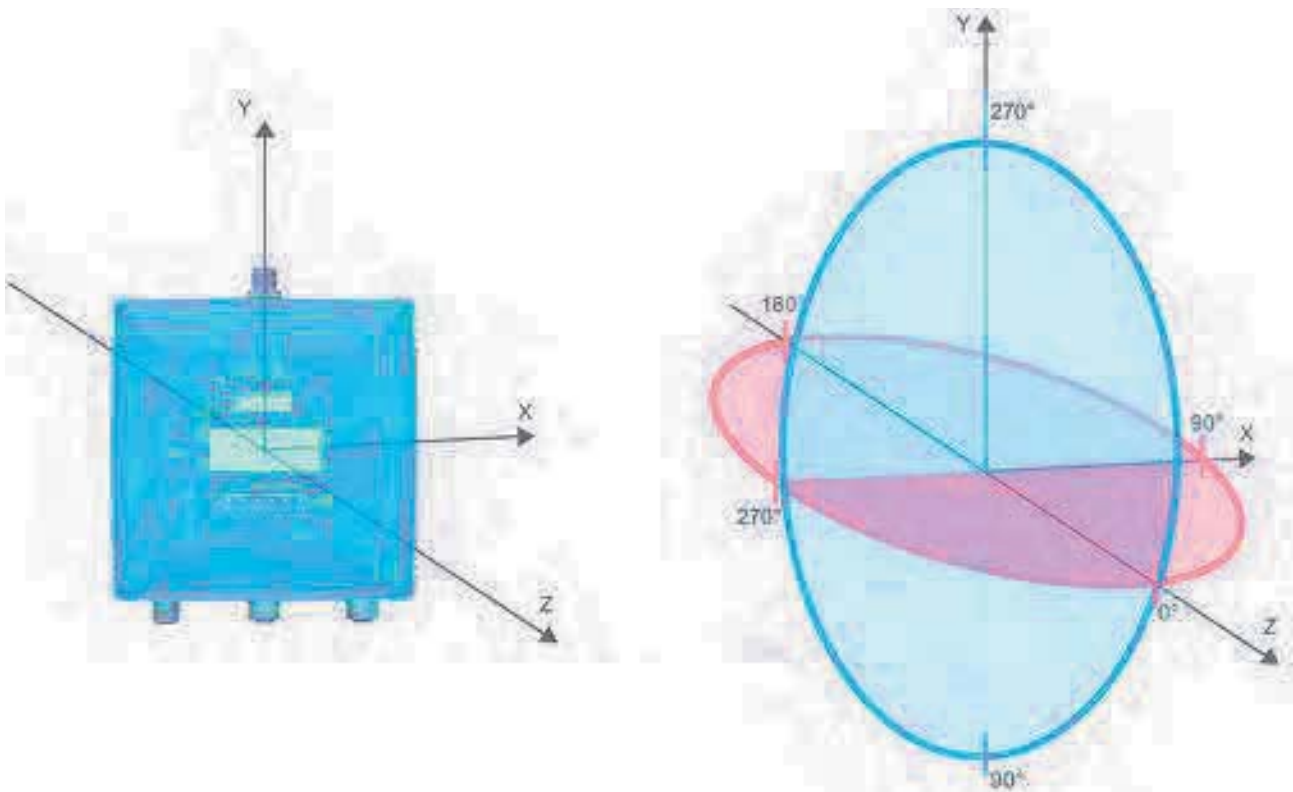

Figure 5-11 Reference system

Radiation diagram (FCC)

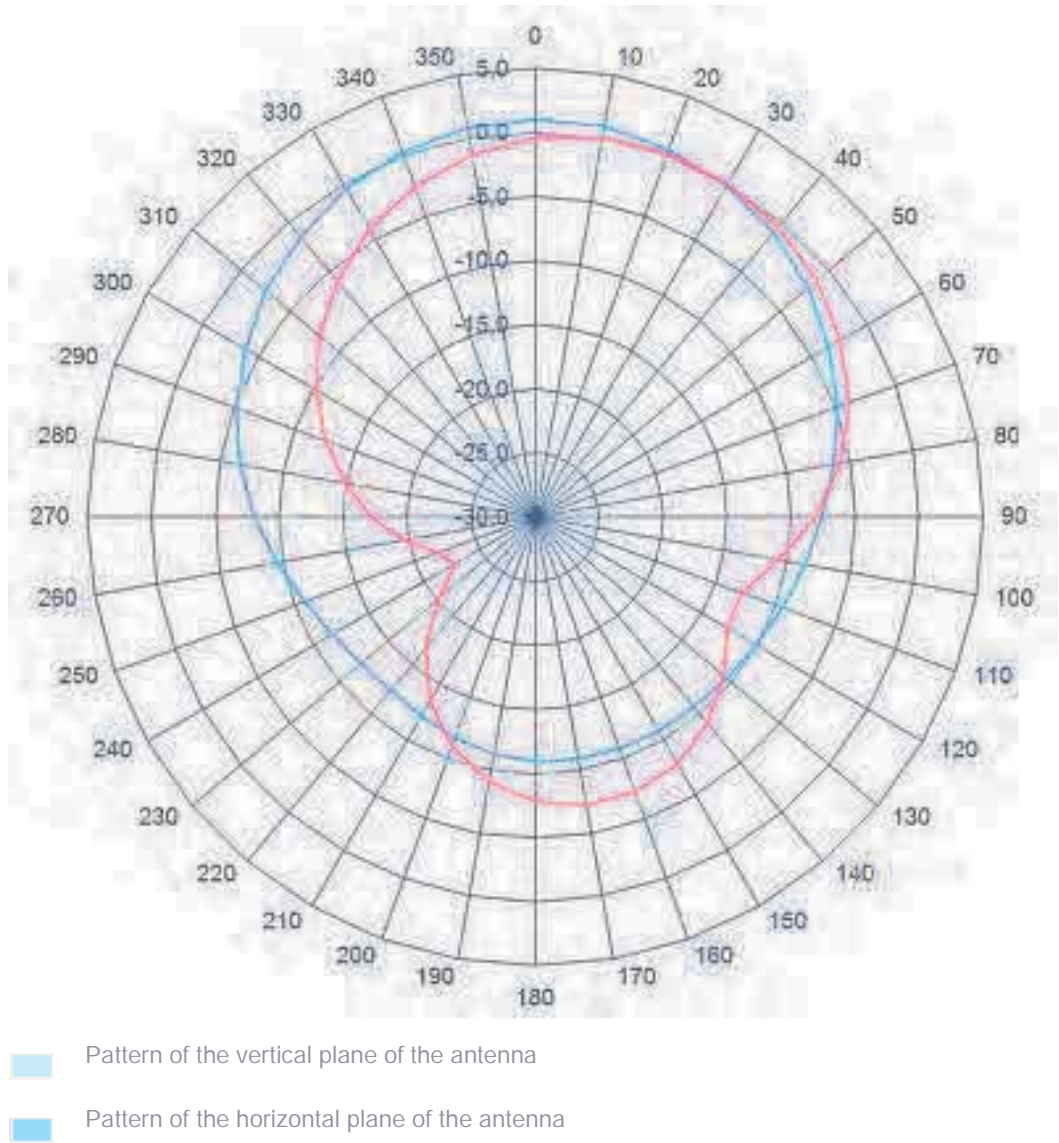

Figure 5-12 Directional radiation pattern of RF615R in the FCC frequency band

Overview of the antenna parameters

Table 5- 18 Maximum linear electrical aperture angle at 915 MHz:

	Polarization (circular)
Azimuth section	100°
Elevation section	100°
Typical antenna gain in the frequency band 902 to 928 MHz	0 dBi
Antenna axis ratio	2 dB

You will find more information on the antennas in the section "Guidelines for selecting RFID UHF antennas (Page 51)".

Interpretation of radiation patterns

You can find detailed information on the interpretation in the section "Interpretation of radiation patterns (Page 215)".

5.3.2.2 External antenna

Preassembled standard cables in lengths of 1 m, 3 m, 5 m, 10 m, 15 m, 20 m and 40 m are available to connect the antenna.

The read range is limited by the cable loss. The maximum range can be achieved with the cable 6GT2815-0BH10 (length 1 m) since this has the lowest cable loss.

Examples of possible antenna reading point configurations

- A data source with an external antenna for a reading point.
- As an alternative, a data source with an internal antenna for a reading point.

5.3.3 Installing/mounting

Requirement

NOTICE
Close unused connectors
Note that the readers only have the specified degree of protection when all connectors are in use or when unused connectors are closed with the protective caps.



CAUTION
Emitted radiation
The transmitter complies with the requirements of Health Canada and the FCC limit values for subjecting persons to HF radiation, provided that a minimum spacing of 26 cm exists between antenna and person. When the antennas are installed, you must therefore ensure that a minimum spacing of 26 cm is maintained between personnel and antennas.

Mounting/installing the device

You can mount the reader in the following ways:

- directly on a flat surface using the VESA 100 mounting system (torque \approx 1.5 Nm).

The positions of the mounting holes for the device are shown in the section Dimension drawing (Page 141).

5.3.4 Configuration/integration

An Ethernet interface is available for integrating the device into system environments/networks. RF615R can be configured via the Ethernet interface and with direct connection to the PC. You can configure and program the reader using the following tools:

- STEP 7 Basic/Professional (TIA Portal)
- or via EtherNet/IP
- Web Based Management (WBM)
- OPC UA or XML based user applications

Note that configuration in parallel is not possible using different tools. Simple process controls (e.g. a traffic signal) can be implemented directly using the reader via the digital input/output.

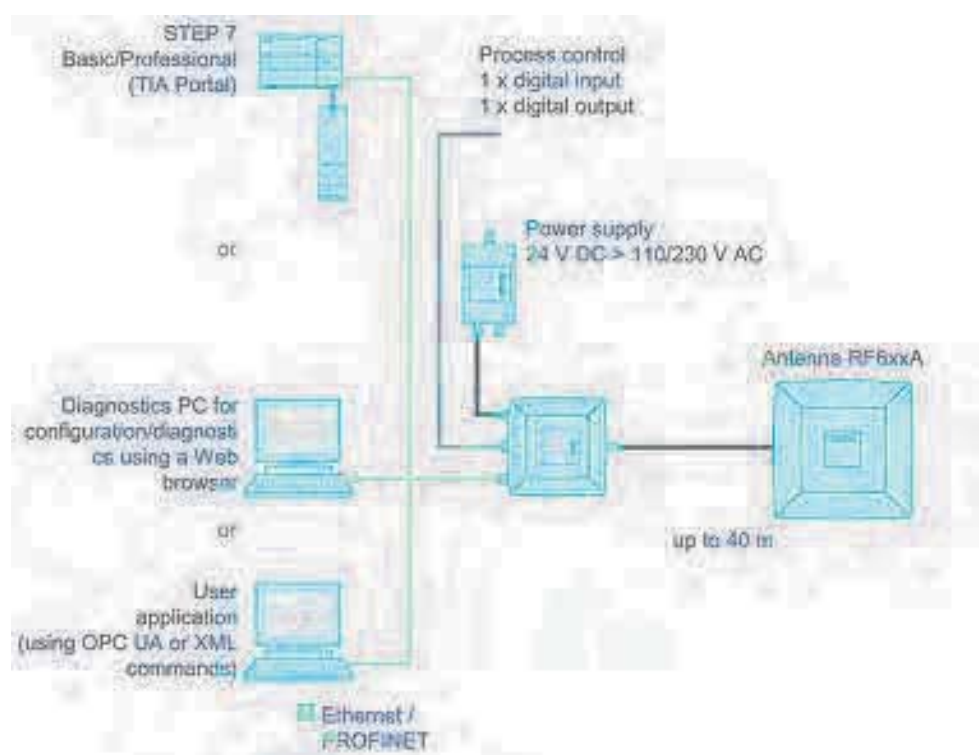

Figure 5-13 Overview: Configuration of RF615R readers

5.3.5 Technical specifications

Table 5- 19 Technical specifications of the RF615R reader

6GT2811-6CC10-xAA0	
Product type designation	SIMATIC RF615R
Radio frequencies	
Operating frequency	
• ETSI	• 865 to 868 MHz
• FCC	• 902 to 928 MHz
• CMIIT	• 920 to 925 MHz
Transmit power ¹⁾	
• ETSI	• 3 ... 400 mW
• FCC	• 3 ... 400 mW
• CMIIT	• 3 ... 400 mW
Maximum radiated power per antenna	
• ETSI	• 1000 mW ERP
• FCC	• 1800 mW EIRP
• CMIIT	• 1000 mW ERP
Electrical data	
Range (internal antenna)	
• ETSI	• ≤ 1 m
• FCC	• ≤ 1 m
• CMIIT	• ≤ 1 m
Protocol	ISO 18000-62/-63
Transmission speed	≤ 300 kbps
Frequency accuracy	≤ ±10 ppm
Channel spacing	
• ETSI	• 600 kHz
• FCC	• 500 kHz
• CMIIT	• 250 kHz
Modulation methods	ASK: DSB modulation & PR-ASK modulation encoding, Manchester or Pulse Interval (PIE)
Multitag capability	Yes

6GT2811-6CC10-xAA0	
Typical transmission time per byte	
• Write access	• 2 ms
• Read access	• 0.15 ms
Supply voltage	24 V DC (20 ... 30 V DC) ²⁾
Maximum permitted current consumption	0.3 A
Maximum permitted current consumption via DI/DQ interface	
• < 20 °C	• 0.5 A
• ≈ 55 °C	• 0.33 A
Current consumption (on standby), typical	
• 20 V input voltage on the reader	• 200 mA / 4 W
• 24 V input voltage on the reader	• 170 mA / 4.1 W
• 30 V input voltage on the reader	• 150 mA / 4.2 W
Current consumption (at 400 mW transmit power), typical	
• 20 V input voltage on the reader	• 260 mA / 5.2 W
• 24 V input voltage on the reader	• 220 mA / 5.3 W
• 30 V input voltage on the reader	• 170 mA / 5.1 W
Interfaces	
Antenna connectors	1x RP-TNC
Power supply	1x M12 (8-pin)
DI/DQ interface	1x M12 (5-pin)
Digital inputs	1
Digital outputs	1
Ethernet interface	1x M12 (4-pin), 100 Mbps
Mechanical specifications	
Material	Pocan (silicone-free)
Color	TI-Grey

6GT2811-6CC10-xAA0

Permitted ambient conditions

Ambient temperature

- | | |
|---|--|
| <ul style="list-style-type: none"> • During operation | <ul style="list-style-type: none"> • -25 ... +55 °C |
| <ul style="list-style-type: none"> • During transportation and storage | <ul style="list-style-type: none"> • -40 ... +85 °C |

Conditions relating to UL approval

- for indoor use only (dry location)
- Mounting height shall be equal or less than 2 m (MS1 classification according UL/IEC 62368-1).
La hauteur de montage doit être égale ou inférieure à 2 m (classification MS1 selon CEI 62368-1).

Degree of protection

IP67

Shock resistant to EN 60068-2-27

25.5 g ³⁾

Vibrations according to EN 60068-2-6

3.1 g ³⁾**Design, dimensions and weight**

Dimensions (W × H × D)

155 × 133 × 45 mm

Weight

370 g

Type of mounting

VESA 100
4x screws M4 (≈ 1.5 Nm)

Operation indicator

6 LEDs

Status display

1 LED (enclosure, all-round)

Standards, specifications, approvals

Proof of suitability

EN 301 489-1 V2.2.0 / EN 301 489-3 V2.1.1 /
EN 302 208 V3.1.1

FCC CFR 47, Part 15 section 15.247

MTBF

29 years

- 1) Measured at the output of the antenna socket.
- 2) All supply and signal voltages must be safety extra low voltage (SELV/PELV according to EN 60950). All voltage sources must meet the requirements of limited power sources (LPS) and NEC Class 2.
Note that, depending on the power consumption, using extension cables > 20 m (6GT2891-4FN50) may lead to a voltage drop on the reader. This voltage drop can mean that the necessary minimum voltage on the reader is below the required 20 V.
- 3) The values for shock and vibration are maximum values and must not be applied continuously. These values only apply to mounting using screws.

5.3.6 Dimension drawing

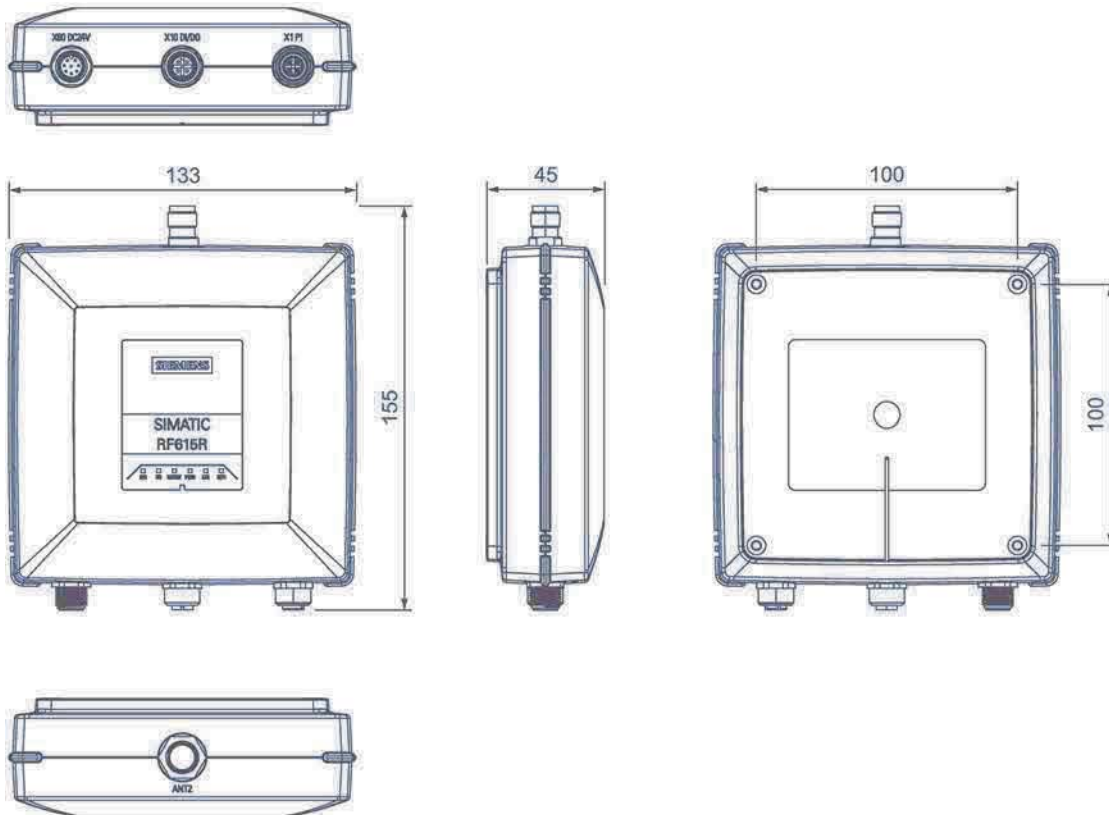

Figure 5-14 Dimension drawing RF615R

All dimensions in mm (± 0.5 mm tolerance)

5.3.7 Certificates and approvals

5.3.7.1 CE mark

Note

Marking on the readers according to specific approval

The certificates and approvals listed here apply only if the corresponding mark is found on the readers.

Table 5- 20 6GT2811-6CC10-0AA0

Labeling	Description
	Conformity with the RED directive 2014/53/EU Conformity with the RoHS directive 2011/65/EU

5.3.7.2 Country-specific certifications

Table 5- 21 6GT2811-6CC10-1AA0



Labeling	Description
 Federal Communications Commission	FCC CFR 47, Part 15 section 15.247 Radio Frequency Interference Statement This equipment has been tested and found to comply with the limits for a Class B digital device, pursuant to Part 15 of the FCC Rules. FCC ID: NXW-RF615R
Industry Canada Radio Standards Specifications	RSS-247 Issue 2 IC: 267X-RF615R
	This product is UL-certified for the USA and Canada. It meets the following safety standard(s): UL/IEC 62368-1, 2nd Ed CAN/CSA C22.2 No. 62368-1-14, 2nd Ed Audio/video, information and communication technology equipment - Part 1: Safety requirements

Table 5- 22 6GT2811-6CC10-2AA0

Standard	
CMIIT Certification	China radio approval Marking on the reader: CMIIT ID: 2019DJ2356

5.3.7.3 FCC information

Siemens SIMATIC RF615R (FCC): 6GT2811-6CC10-1AA0

FCC ID: NXW-RF615R

This device complies with part 15 of the FCC rules. Operation is subject to the following two conditions:

- (1) This device may not cause harmful interference, and
- (2) this device must accept any interference received, including interference that may cause undesired operation.

Caution

Any changes or modifications not expressly approved by the party responsible for compliance could void the user's authority to operate the equipment.

Note

This equipment has been tested and found to comply with the limits for a Class B digital device, pursuant to part 15 of the FCC Rules.

These limits are designed to provide reasonable protection against harmful interference when the equipment is operated in a commercial environment. This equipment generates, uses, and can radiate radio frequency energy and, if not installed and used in accordance with the instruction manual, may cause harmful interference to radio communications. Operation of this equipment in a residential area is likely to cause harmful interference in which case the user will be required to correct the interference at his own expense.

FCC Notice

To comply with FCC part 15 rules in the United States, the system must be professionally installed to ensure compliance with the Part 15 certification.

It is the responsibility of the operator and professional installer to ensure that only certified systems are deployed in the United States. The use of the system in any other combination (such as co-located antennas transmitting the same information) is expressly forbidden.

FCC Exposure Information

To comply with FCC RF exposure compliance requirements, the antennas used for this transmitter must be installed to provide a separation distance of at least 20 cm from all persons and must not be co-located or operating in conjunction with any other antenna or transmitter.

5.3.7.4 IC-FCB information

Siemens SIMATIC RF615R (FCC): 6GT2811-6CC10-1AA0

IC: 267X-RF615R

This device complies with Industry Canada licence-exempt RSS standard(s). Operation is subject to the following two conditions:

- (1) This device may not cause interference, and
- (2) this device must accept any interference, including interference that may cause undesired operation of the device.

In order to comply with ISED RF Exposure requirements, this device must be installed to provide at least 20 cm separation from the human body at all times.

Le présent appareil est conforme aux CNR d'Industrie Canada applicables aux appareils radio exempts de licence. L'exploitation est autorisée aux deux conditions suivantes :

- (1) L'appareil ne doit pas produire de brouillage, et
- (2) l'utilisateur de l'appareil doit accepter tout brouillage radioélectrique subi, même si le brouillage est susceptible d'en compromettre le fonctionnement.

Afin de se conformer aux exigences d'exposition RF ISED, cet appareil doit être installé pour fournir au moins 20 cm de séparation du corps humain en tout temps.

Industry Canada Notice

To reduce potential radio interference to other users, the antenna type and its gain should be so chosen that the equivalent isotropically radiated power (e.i.r.p.) is not more than that permitted for successful communication.

To comply with Industry Canada licence-exempt RSS standard(s), the system must be professionally installed to ensure compliance with IC certification.

Pour se conformer aux normes RSS exemptes de licence d'Industrie Canada, le système doit être installé par un professionnel afin d'assurer la conformité avec la certification IC.

5.3.7.5 Other certificates and approvals

ISA-S71.04-1985

RF615R reader meets the requirements according to ISA-S71.04-1985 Airborne Contaminants Class G3.

5.4 SIMATIC RF650R

5.4.1 Description

5.4.1.1 Overview

The SIMATIC RF650R is a stationary reader in the UHF frequency band without an integrated antenna. Up to four external UHF RFID antennas can be connected via RP-TNC connectors.

The maximum transmit power is 1000 mW at the reader output. A radiated power of up to 2000 mW ERP / 4000 mW EIRP is achieved when the appropriate antennas and antenna cables are used. The interfaces (Ethernet, power supply, DI/DQ interface) are located on the lower front edge. These interfaces can be used to connect the reader to the power supply and a PC for parameter assignment.

The degree of protection is IP30.

	Pos.	Description
	①	RP-TNC interfaces for connecting up to 4 external antennas
	②	LED operating display
	③	DI/DQ interface: X10 DI/DQ (M12, 12-pin)
	④	Interface to power supply (RS422), 24 V DC ¹⁾ : X80 DC24V (M12, 8-pin)
	⑤	Ethernet interface, TCP/IP: X1 P1 (RJ45, 8-pin)

5.4.1.2 Ordering data

Table 5- 23 Ordering data RF650R

Product	Article number
RF650R (ETSI)	6GT2811-6AB20-0AA0
RF650R (FCC)	6GT2811-6AB20-1AA0
RF650R (CMIIT)	6GT2811-6AB20-2AA0
RF650R (ARIB)	6GT2811-6AB20-4AA0

Table 5- 24 Ordering data accessories

Product	Article number
Holders for securing the reader <ul style="list-style-type: none"> • DIN rail T35 (S7-1200) • S7-300 standard rail • S7-1500 standard rail 	6GT2890-0AB00
SIMATIC antenna holder for RF600 devices	6GT2890-2AB10
Connecting cable and connectors	
<ul style="list-style-type: none"> • DI/DQ cable connector open cable ends 	5 m 6GT2891-0CH50
<ul style="list-style-type: none"> • Ethernet plug Standard IE FastConnect RJ45 180 (IP20) 	6GK1901-1BB10-2AA0
<ul style="list-style-type: none"> • Industrial Ethernet cable RJ45 / RJ45 	10 m 6XV1870-3QN10
<ul style="list-style-type: none"> • Industrial Ethernet connecting cable M12-180 / RJ45 	2 m 6XV1871-5TH20
	3 m 6XV1871-5TH30
	5 m 6XV1871-5TH50
<ul style="list-style-type: none"> • Industrial Ethernet cable by the meter, green (minimum 20 m) 	6XV1840-2AH10
<ul style="list-style-type: none"> • Connecting cable reader ↔ CM M12-180 / M12-180 	2 m 6GT2891-4FH20
	5 m 6GT2891-4FH50
	10 m 6GT2891-4FN10
	20 m 6GT2891-4FN20
	50 m 6GT2891-4FN50
Wide-range power supply unit for SIMATIC RF systems	
<ul style="list-style-type: none"> • With EU plug 	6GT2898-0AC00
<ul style="list-style-type: none"> • With UK plug 	6GT2898-0AC10
<ul style="list-style-type: none"> • With US plug 	6GT2898-0AC20

Product	Article number
24 V connecting cable reader ↔ wide-range power supply unit	
• with plug, 5 m	6GT2891-0PH50
• with open ends, 2 m	6GT2891-4EH20
• with open ends, 5 m	6GT2891-4EH50
DVD "Ident Systems Software & Documentation"	6GT2080-2AA20

5.4.1.3 Pin assignment of the DI/DQ interface (X10 DI/DQ)

Table 5- 25 Pin assignment of the DI/DQ interface (reader end)

View of interface (M12 socket, 12-pin)	Pin	Pin assignment
	1	GND (output to supply of the digital inputs/outputs [not galvanically isolated])
	2	VCC (output to the supply of the digital inputs/outputs [not galvanically isolated])
	3	DO Common / Output Common
	4	DO 0 / Output 00
	5	DO 1 / Output 01
	6	DO 2 / Output 02
	7	DO 3 / Output 03
	8	DI 0 / Input 00
	9	DI Common / Input Common
	10	DI 1 / Input 01
	11	DI 2 / Input 02
	12	DI 3 / Input 03

Note

Requirement for external power sources

When the DI/DQ interface is supplied with power by an external power source, this source must meet the requirements for LPS (Limited Power Sources) and NEC Class 2.

Color scheme of the DI/DQ standard cable with M12 connector

The following figure shows the color scheme of the DI/DQ standard cable from Siemens (6GT2891-0CH50). You can use the color scheme to assign the wire colors to the pins.

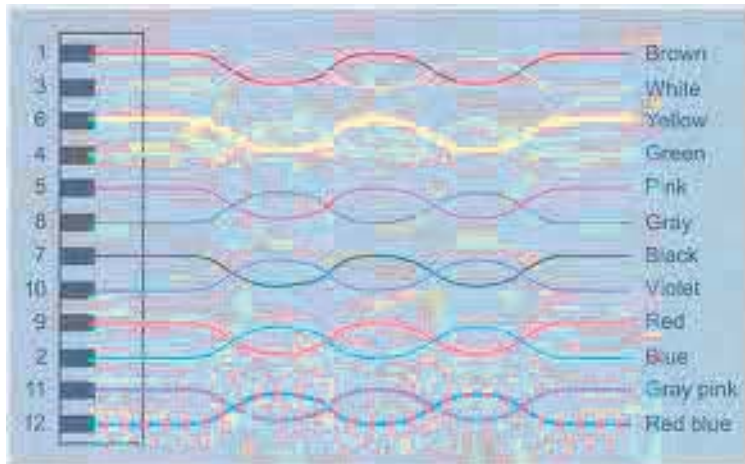

Figure 5-15 Wiring diagram: M12 connector

5.4.1.4 Switching scheme for the DI/DQ interface

Connection possibilities

You can connect the reader in different ways. In general, the outputs and inputs should be connected as follows:

Output (DO 0 ... 3)

- Each output is rated for 0.5 A current and is electronically protected.
- 4 digital outputs can be operated simultaneously each with up to 0.5 A (up to 1 A in total). With a total current > 1 A, you need to use an external power supply.
- The outputs are optically isolated through optocouplers.

input (DI 0 ... 3)

- The inputs are optically isolated through optocouplers.
- Level
 - Low: 0 ... 7 V
 - High: 15 ... 24 V

The following diagrams illustrate various connection possibilities.

Note

Minimum time between changes

Note that changes on the DI/DQ interface that are not applied for at least 1.5 seconds are not detected by the reader.

Voltage infeed from internal source (no electrical isolation)

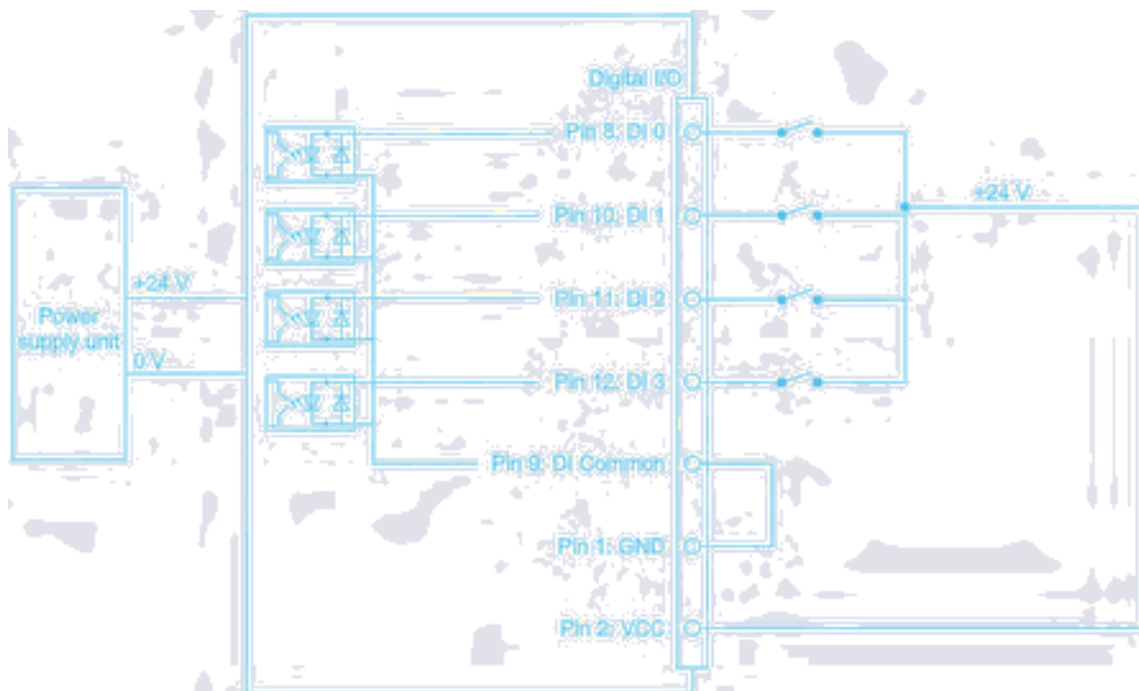

Figure 5-16 Circuit example 1: Digital inputs

Alternative connection possibilities:

- Pin 2 (VCC) to Pin 9 DI Common
- Pin 1 GND to busbar inputs

Voltage infeed from external source

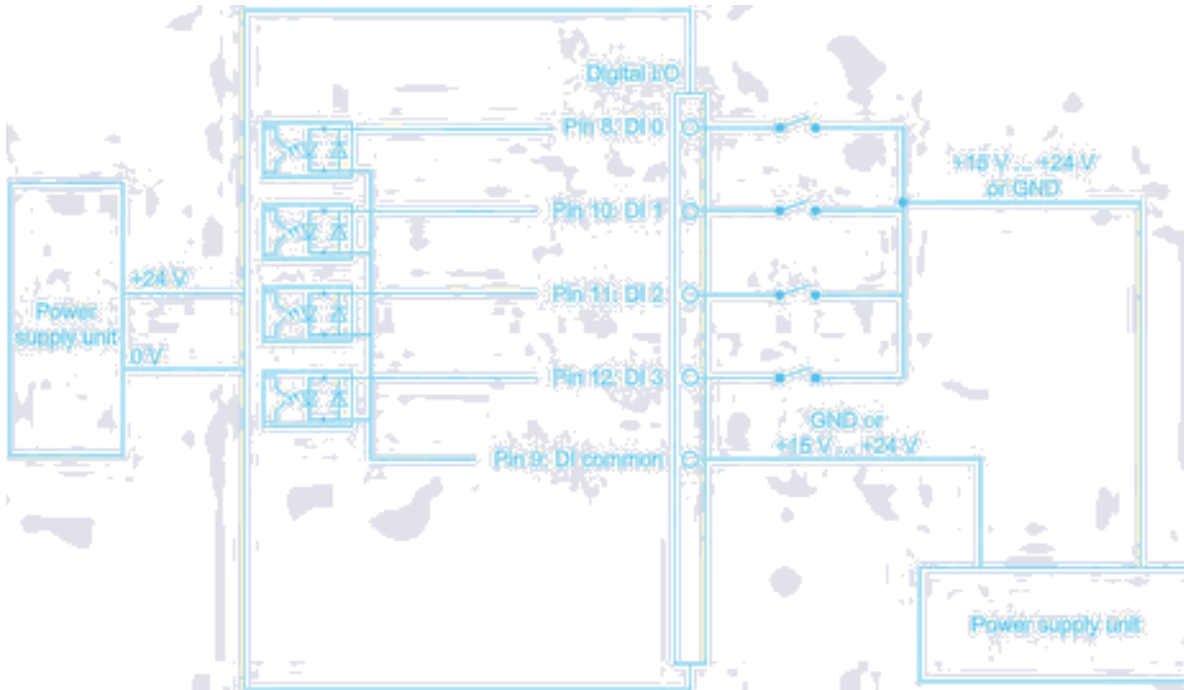

Figure 5-17 Circuit example 2: Digital inputs

Voltage infeed from external source with various voltages

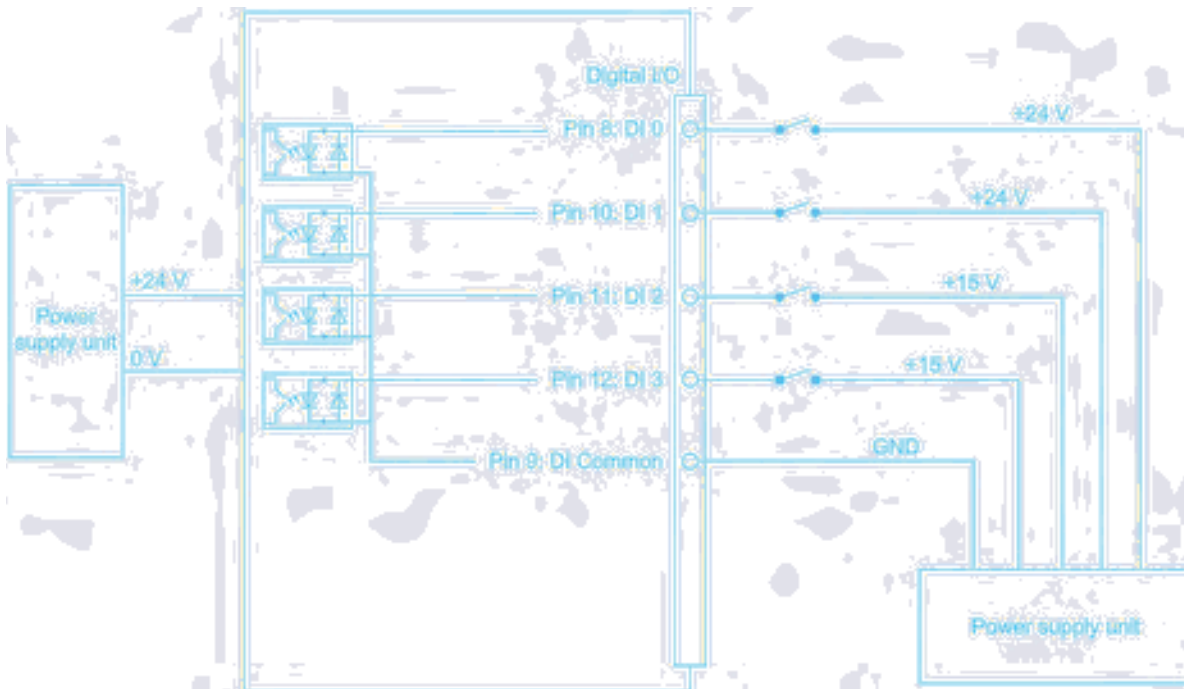

Figure 5-18 Circuit example 3: Digital inputs

Voltage infeed from internal source

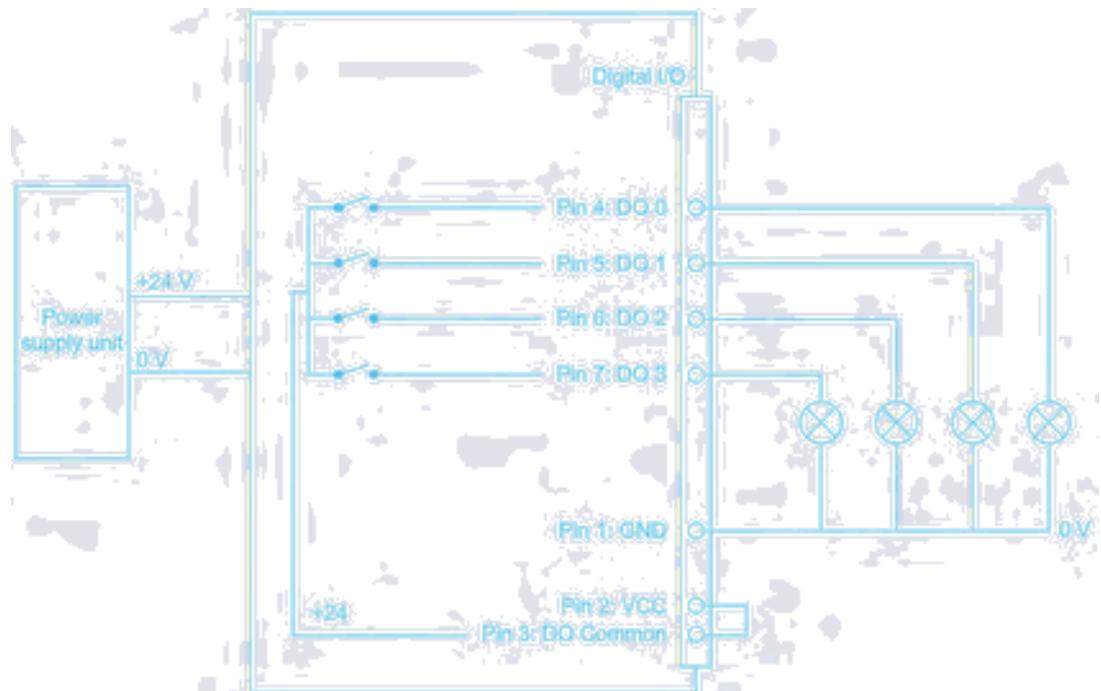

Figure 5-19 Circuit example 4: Digital outputs

Alternative connection possibilities:

- Pin 1 GND to Pin 3 DO Common
- Pin 2 (VCC) to busbar outputs

Voltage infeed from external source

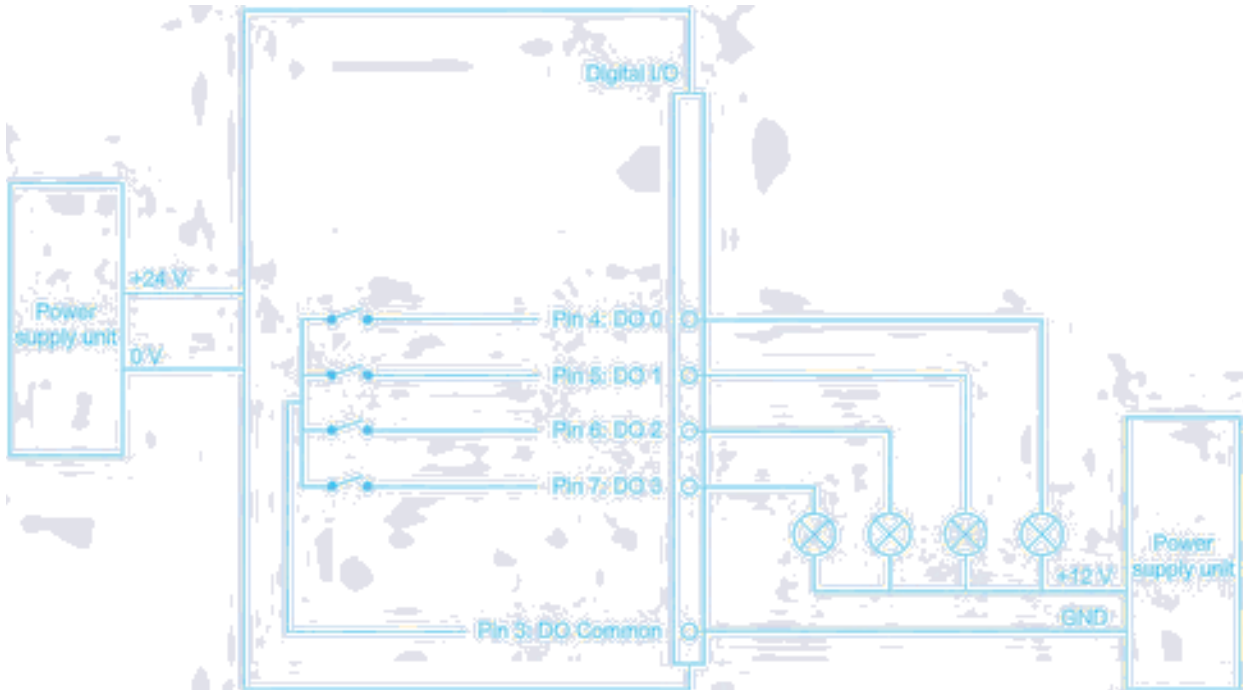

Figure 5-20 Circuit example 5: Digital outputs

Voltage infeed from an external source is shown here for 12 V as an example. Other voltages are also permissible.

Voltage infeed from external source with various voltages

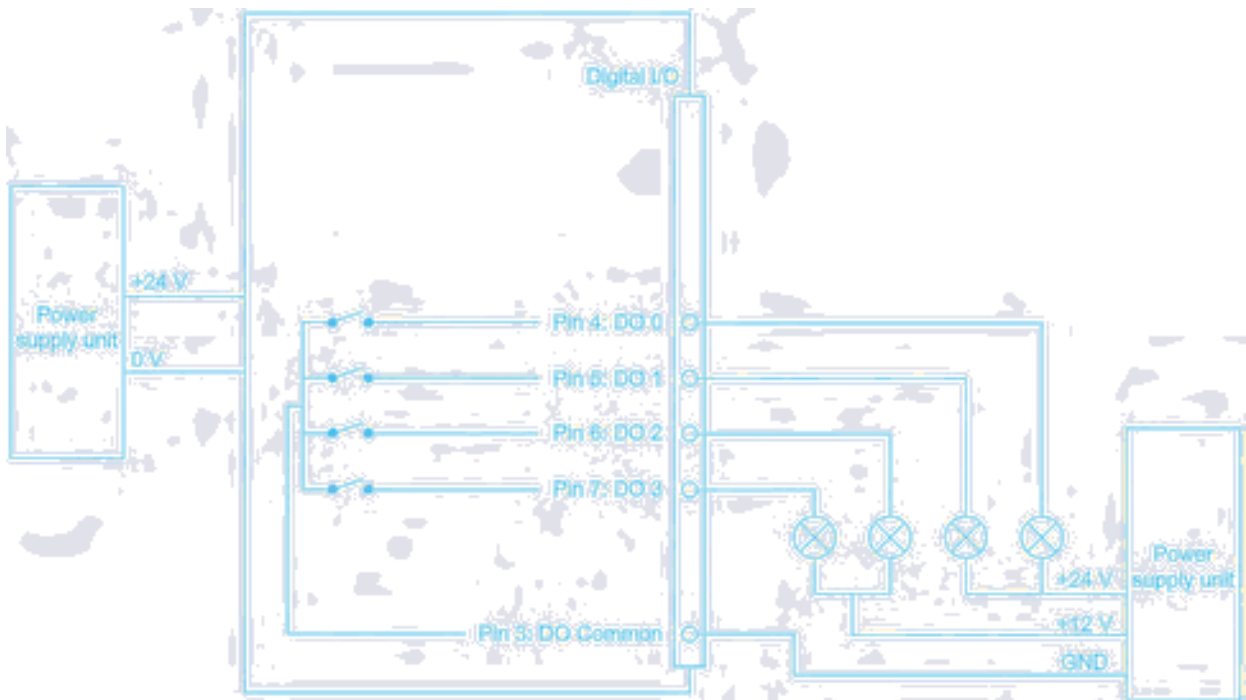

Figure 5-21 Circuit example 6: Digital outputs

5.4.1.5 Pin assignment of the power supply interface (X80 24VDC)

Table 5- 26 Pin assignment of the RS422 interface (reader end)

View of interface (M12 socket, 8-pin)	Pin	Wire colors	Assignment
	1	White	+ 24 V
	2 ¹⁾	Brown	- Tx
	3	Green	0 V
	4 ¹⁾	Yellow	+ Tx
	5 ¹⁾	Gray	+ Rx
	6 ¹⁾	Pink	- Rx
	7	--	Unassigned
	8	--	Earth (shield)

¹⁾ These pins are not required if the reader is operated via Ethernet.

Note

Requirement for external power sources

The reader must only be supplied with power by power supply units that meet the requirements of LPS (Limited Power Source) and NEC Class 2.

Requirement for external power sources

The reader must only be supplied with power by power supply units that meet the requirements of limited power source (LPS) and NEC Class 2.

Spécification des sources de tension externes

L'alimentation du plot de lecture/écriture doit être exclusivement assurée par des blocs d'alimentation conformes aux spécifications des sources à puissance limitée (Limited Power Sources LPS) et de NEC class 2.

Notes on connectors and cables

The cables with open cable ends (6GT2891-4EH20, 6GT2891-4EH50) have an 8-pin M12 plug at one end, while the other end of the cable is "open". There are 8 color-coded single wires there for connecting to external devices.

The product range includes additional cables of the type 6GT2891-4Fxxx (2 to 50 m) with an M12 connector at both ends. These cables can be used as extension cables. Long cables can be shortened if necessary.

NOTICE

Insulate unused single wires

Unused single wires must be insulated individually to prevent unwanted connections of signal lines.

NOTICE

For long cables: Adapt the power supply and transmission speed

Note that even with long cables, the supply voltage of 24 VDC must always be guaranteed. Note also that the transmission speed on the serial interface must, if necessary, be reduced.
--

SIMATIC standard cables (e.g. 6GT2891-4FN10) have a loop resistance of 160 mOhm / meter. This results in a voltage drop of 0.8 volts on the 24 V cable for every 10 meters of connecting cable and with a power requirement of 500 mA. If the power requirement increases through the use of the digital inputs/outputs, the voltage drop increases accordingly.
--

5.4.1.6 Pin assignment of the Industrial Ethernet interface (X1 P1)

Table 5- 27 Pin assignment of the Industrial Ethernet interface (reader end)

View of interface (RJ45 socket, 8-pin)	Pin	Pin assignment
	1	Transmit Data (+)
	2	Transmit Data (-)
	3	Receive Data (+)
	4	Terminated
	5	Terminated
	6	Receive Data (-)
	7	Terminated
	8	Terminated

Note

Use of Siemens cables

We recommend that you only use original Siemens cables and connectors (refer to the section "Ordering data (Page 146)") to connect to the Ethernet socket of the reader. If plug-in connectors from other manufacturers are used, it may be difficult or even impossible to remove the plug from the reader.

5.4.1.7 Grounding connection

On the top of the reader there is a blind drill hole (M4 x 8) for grounding. Tighten the screw with a torque of ≈ 1.5 Nm.

 WARNING
Hazardous voltage due to lightning strikes Death or serious injury may occur as a result of lightning strikes to antennas mounted outside buildings. If the reader is operated with antennas mounted outside buildings, it is imperative that the reader is electrically connected to the ground potential.

NOTICE
Installation only in protected areas The antenna can be installed in the protected part of a building. When implementing your lightning protection concept, make sure you adhere to the VDE 0182 or IEC 62305 standards.

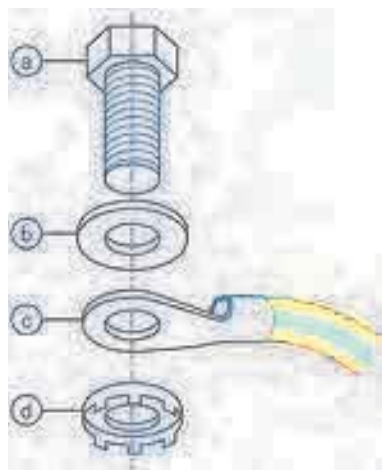
Ground connection	
	(a) Screw (M4 x 8)
	(b) Flat washer
	(c) Cable lug
	(d) Contact washer

5.4.2 Planning operation

5.4.2.1 Antenna/read point configurations

You can connect up to four external antennas to the RF650R reader. The standard setting is that an antenna is connected when the reader is started. When connecting multiple antennas, note the information in the section "Specified minimum and maximum spacing of antennas (Page 46)".

With the WBM, you can set up various different configurations of antennas and/or reading points as required. Based on the number of data sources and subsequent assignment of the antennas, many tasks can be accomplished.

Examples of possible antenna reading point configurations

- Four data sources each with one antenna for four different reading points.
- Two data sources each with two antennas for small portals.
- One data source with 4 antennas for large portals.

You will find further information in the online help of the products.

5.4.3 Installation/mounting

Requirement

NOTICE
Close unused connectors
Note that the readers only have the specified degree of protection when all connectors are in use or when unused connectors are closed with the protective caps.

 CAUTION
Emitted radiation
The transmitter complies with the requirements of Health Canada and the FCC limit values for subjecting persons to HF radiation, provided that a minimum spacing of 26 cm exists between antenna and person. When the antennas are installed, you must therefore ensure that a minimum spacing of 26 cm is maintained between personnel and antennas.

Mounting/installing the device

You can mount the reader in the following ways:

- DIN rail T35 (S7-1200)
- S7-300 standard rail
- S7-1500 standard rail
- directly on a flat surface using the VESA 100 mounting system (torque \approx 1.5 Nm).

The positions of the mounting holes for the device are shown in the section Dimension drawing (Page 165).

Mounting the reader on a DIN/standard rail

Table 5- 28 DIN rail mounting

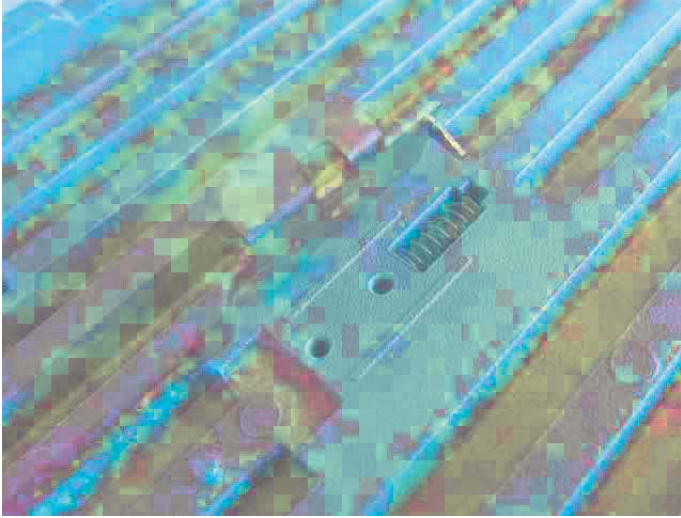
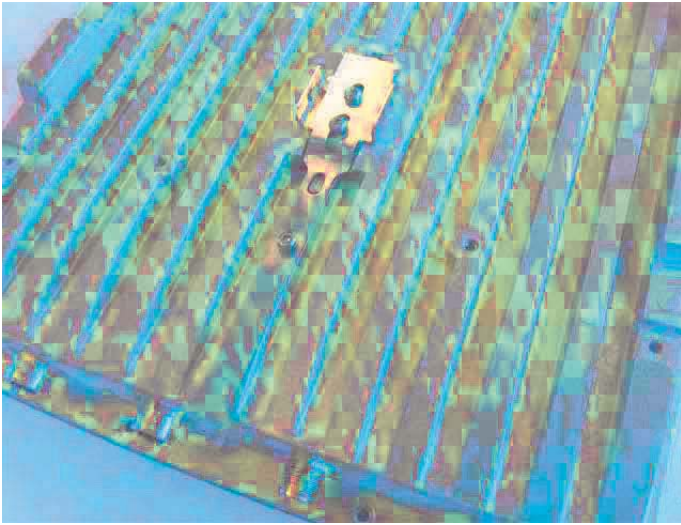
	Description
	1. Place the spring in the groove.
	2. Mount the holder using the supplied Torx screws. When mounting the holder, make sure that the angled tip is positioned above the spring in the groove.

	Description
	<p>3. Fit the lower part of the locking mechanism of the reader into the DIN rail.</p> <p>To be able to mount the reader on or remove it from the DIN rail, pull down the holder mounted in step 2.</p>

Table 5- 29 Installation on a standard rail

	Description
	<ol style="list-style-type: none"> 1. Mount the two adapter pieces using the supplied Torx screws.
	<ol style="list-style-type: none"> 2. Fit the upper part of the locking mechanism of the reader into the standard rail. 3. Secure the reader using the supplied slotted-head screws.

5.4.4 Configuration/integration

An Ethernet interface is available for integrating the device into system environments/networks. The RF650R can be configured via the Ethernet interface and with direct connection to the PC. You can configure and program the reader using the following tools:

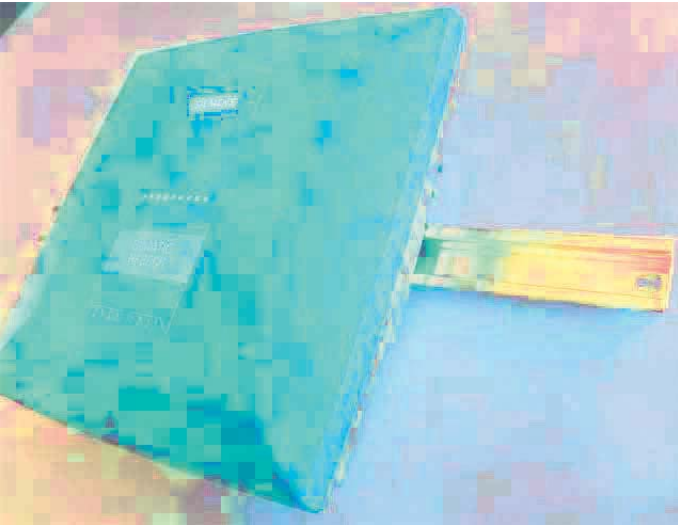
- using Web Based Management (WBM)
- OPC UA or XML based user applications

Note that configuration in parallel is not possible using different tools. Simple process controls (e.g. a traffic signal) can be implemented directly using the reader via four digital inputs/outputs.

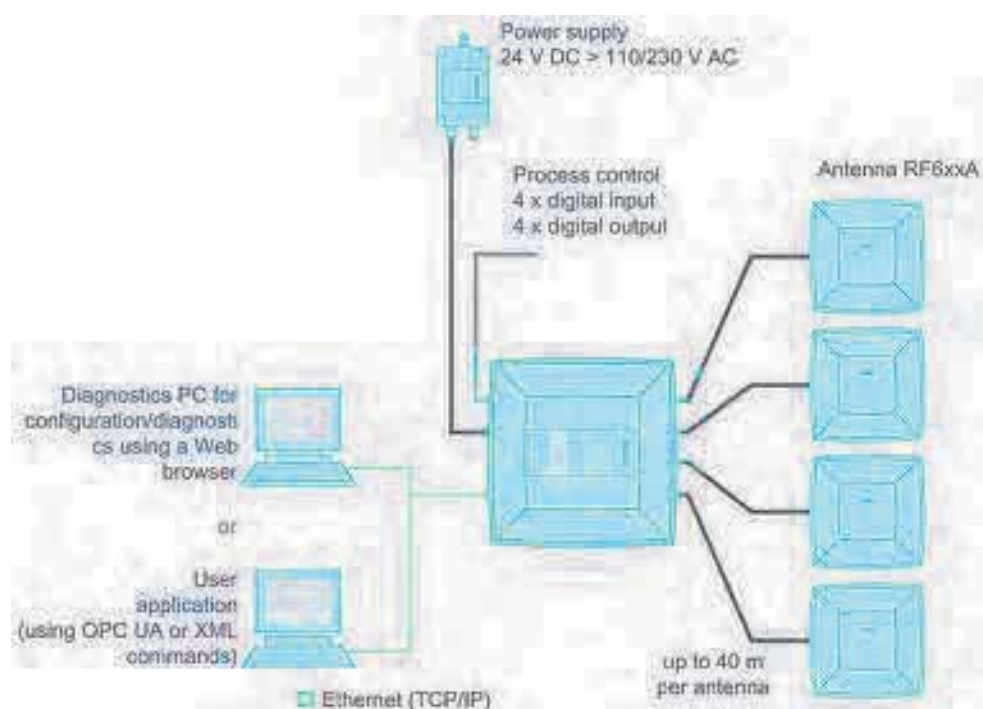

Figure 5-22 Overview: Configuration of RF650R readers

5.4.5 Technical specifications

Table 5- 30 Technical specifications of the RF650R reader

6GT2811-6AB20-xAA0	
Product type designation	SIMATIC RF650R
Radio frequencies	
Operating frequency	
• ETSI	• 865 to 868 MHz
• FCC	• 902 to 928 MHz
• CMIIT	• 920 to 925 MHz
• ARIB (STD-T107)	• 920.4 to 923.4 MHz
Transmit power ¹⁾	
• ETSI	• 3 to 1000 mW
• FCC	• 3 to 1000 mW
• CMIIT	• 3 to 1000 mW
• ARIB (STD-T107)	• 3 to 250 mW
Maximum radiated power per antenna	
• ETSI	• 2000 mW ERP
• FCC	• 4000 mW EIRP
• CMIIT	• 2000 mW ERP
• ARIB (STD-T107)	• 500 mW EIRP
Electrical data	
Range	
• ETSI	• ≤ 8 m
• FCC	• ≤ 8 m
• CMIIT	• ≤ 8 m
• ARIB (STD-T107)	• ≤ 4 m
Protocol	ISO 18000-62/-63
Transmission speed	≤ 300 kbps
Frequency accuracy	≤ ±10 ppm

6GT2811-6AB20-xAA0	
Channel spacing	
• ETSI	• 600 kHz
• FCC	• 500 kHz
• CMIIT	• 250 kHz
• ARIB (STD-T107)	• 200 kHz
Modulation methods	ASK: DSB modulation & PR-ASK modulation encoding, Manchester or Pulse Interval (PIE)
Multitag capability	Yes
Typical transmission time per byte	
• Write access	• 2 ms
• Read access	• 0.15 ms
Supply voltage	24 V DC (20 ... 30 V DC) ²⁾
Maximum permitted current consumption	2 A
Maximum permitted current consumption via DI/DQ interface	1 A
Current consumption (on standby), typical	
• 20 V input voltage on the reader	• 220 mA / 4.4 W
• 24 V input voltage on the reader	• 190 mA / 4.5 W
• 30 V input voltage on the reader	• 150 mA / 4.5 W
Current consumption (at 1000 mW transmit power), typical	
• 20 V input voltage on the reader	• 450 mA / 9.0 W
• 24 V input voltage on the reader	• 370 mA / 8.9 W
• 30 V input voltage on the reader	• 300 mA / 9.0 W
Current consumption (at 2000 mW transmit power), typical	
• 20 V input voltage on the reader	• 610 mA / 12.2 W
• 24 V input voltage on the reader	• 500 mA / 12.0 W
• 30 V input voltage on the reader	• 410 mA / 12.3 W
Interfaces	
Antenna connectors	4x RP-TNC
Power supply	1x M12 (8-pin)
DI/DQ interface	1x M12 (12-pin)
Digital inputs	4
Digital outputs	4
Ethernet interface	1x RJ45 (8-pin), 100 Mbps

6GT2811-6AB20-xAA0	
Mechanical specifications	
Material	
• Upper part of housing	• Pocan (silicone-free)
• Lower part of housing	• Aluminum
Color	
• Upper part of housing	• TI-Grey
• Lower part of housing	• Silver
Permitted ambient conditions	
Ambient temperature	
• During operation	• -25 ... +55 °C
• During transportation and storage	• -40 ... +85 °C
Degree of protection	IP30
Shock resistant to EN 60068-2-27	25.5 g ³⁾
Vibrations according to EN 60068-2-6	3.1 g ³⁾
Design, dimensions and weight	
Dimensions (W × H × D)	258 × 258 × 80 mm
Weight	2.4 kg
Type of mounting	
• Mounting rail	• Hanging
• VESA 100	• 4x M4 screws (≈ 1.5 Nm)
Operation indicator	6 LEDs
Status display	-
Standards, specifications, approvals	
Proof of suitability	EN 301 489-1 V1.9.2 / EN 301 489-3 V1.6.1 / EN 302 208-1/-3 V1.4.1 FCC CFR 47, Part 15 section 15.247
MTBF	31 years

¹⁾ Measured at the output of the antenna socket.

²⁾ All supply and signal voltages must be safety extra low voltage (SELV/PELV according to EN 60950). The voltage sources must meet the requirements of limited power sources (LPS) and NEC Class 2.

Note that, depending on the power consumption, using extension cables > 20 m (6GT2891-4FN50) may lead to a voltage drop on the reader. This voltage drop can mean that the necessary minimum voltage on the reader is below the required 20 V.

³⁾ The values for shock and vibration are maximum values and must not be applied continuously. These values only apply to mounting using screws.

5.4.6 Dimension drawing

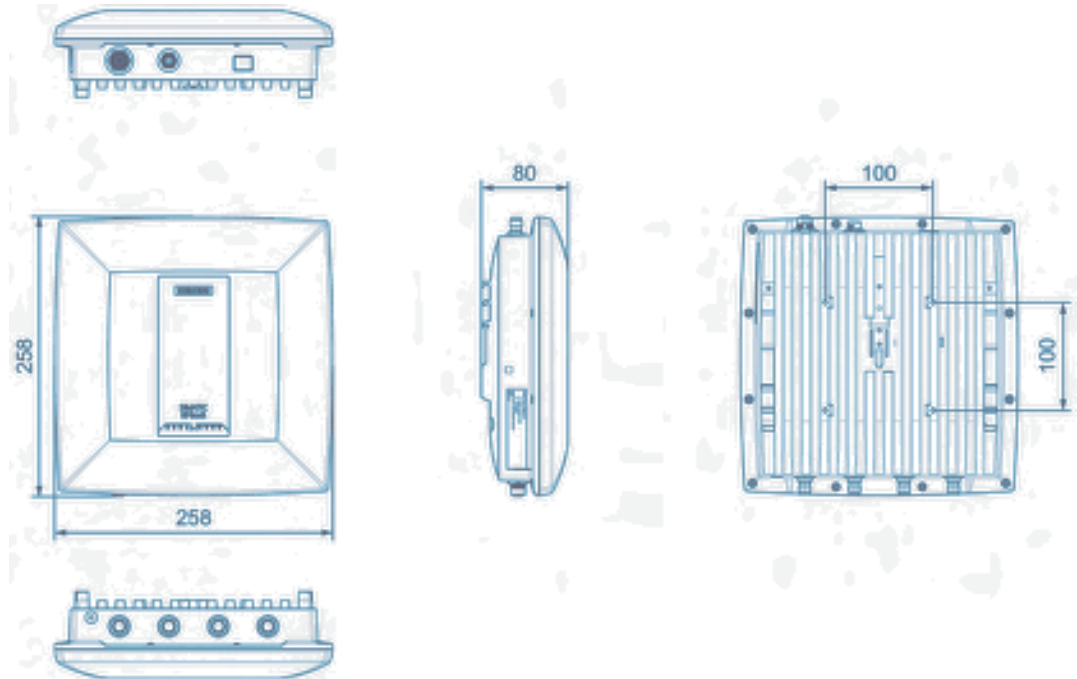

Figure 5-23 Dimension drawing RF650R

All dimensions in mm (± 0.5 mm tolerance)

5.4.7 Certificates and approvals

Note



Marking on the readers according to specific approval

The certificates and approvals listed here apply only if the corresponding mark is found on the readers.

Table 5- 31 6GT2811-6AB20-0AA0

Labeling	Description
	Conformity with the RED directive 2014/53/EU Conformity with the RoHS directive 2011/65/EU
	South Africa radio approval: Radio Equipment Type Approval
India	India wireless approval Marking on the reader: No. NR-ETA/1587
	Radio approval for Russia, Belarus, Kazakhstan

Table 5- 32 6GT2811-6AB20-1AA0

Labeling	Description
 Federal Communications Commission	FCC CFR 47, Part 15 section 15.247 Radio Frequency Interference Statement This equipment has been tested and found to comply with the limits for a Class B digital device, pursuant to Part 15 of the FCC Rules. FCC ID: NXW-RF600R2
Industry Canada Radio Standards Specifications	RSS-247 Issue 2 IC: 267X-RF600R2
	This product is UL-certified for the USA and Canada. It meets the following safety standard(s): UL 60950-1 - Information Technology Equipment Safety - Part 1: General Requirements CSA C22.2 No. 60950 -1 - Safety of Information Technology Equipment UL Report E 115352

Labeling	Description
	<p>Brazil radio approval Marking on the reader (6GT2811-6AB20-1AA0):</p>  <p>Statement about approval: Este equipamento opera em caráter secundário, isto é, não tem direito à proteção contra interferência prejudicial, mesmo de estações do mesmo tipo e não pode causar interferência a sistemas operando em caráter primário. Reader certificate: ANATEL 2892-15-4794</p>
	<p>KCC Certification Type of equipment: A급 기기 (업무용 방송통신기자재) Class A Equipment (Industrial Broadcasting & Communication Equipment) 이 기기는 업무용(A급) 전자파적합기기로서 판 매자 또는 사용자는 이 점을 주의하시기 바라 며, 가정외의 지역에서 사용하는 것을 목적으로 합니다. This equipment is Industrial (Class A) electromagnetic wave suitability equipment and seller or user should take notice of it, and this equipment is to be used in the places except for home. Certificate of the reader: MSIP-CMM-RF5-RF650R</p>
C-14627	<p>Argentina radio approval: Registro de la COMISION NACIONAL DE COMUNICACIONES</p>
RCPSISI14-1926	<p>Mexico radio approval: CERTIFICADO DE HOMOLOGACION, IFETEL</p>
	<p>Australia radio approval: This product meets the requirements of the AS/NZS 3548 Norm.</p>

Table 5- 33 6GT2811-6AB20-2AA0

Standard	
----------	--

Standard	
CMIIT Certification	China radio approval Marking on the reader: CMIIT ID: 2014DJ3987

5.4.7.1 FCC information

Siemens SIMATIC RF650R (FCC): 6GT2811-6AB20-1AA0

FCC ID: NXW-RF600R2

This device complies with part 15 of the FCC rules. Operation is subject to the following two conditions:

- (1) This device may not cause harmful interference, and
- (2) this device must accept any interference received, including interference that may cause undesired operation.

Caution

Any changes or modifications not expressly approved by the party responsible for compliance could void the user's authority to operate the equipment.

Note

This equipment has been tested and found to comply with the limits for a Class B digital device, pursuant to part 15 of the FCC Rules.

These limits are designed to provide reasonable protection against harmful interference when the equipment is operated in a commercial environment. This equipment generates, uses, and can radiate radio frequency energy and, if not installed and used in accordance with the instruction manual, may cause harmful interference to radio communications. Operation of this equipment in a residential area is likely to cause harmful interference in which case the user will be required to correct the interference at his own expense.

FCC Notice

To comply with FCC part 15 rules in the United States, the system must be professionally installed to ensure compliance with the Part 15 certification.

It is the responsibility of the operator and professional installer to ensure that only certified systems are deployed in the United States. The use of the system in any other combination (such as co-located antennas transmitting the same information) is expressly forbidden.

FCC Exposure Information

To comply with FCC RF exposure compliance requirements, the antennas used for this transmitter must be installed to provide a separation distance of at least 20 cm from all persons and must not be co-located or operating in conjunction with any other antenna or transmitter.

5.4.7.2 IC-FCB information

Siemens SIMATIC RF650R (FCC): 6GT2811-6AB20-1AA0

IC: 267X-RF600R2

This device complies with Industry Canada licence-exempt RSS standard(s). Operation is subject to the following two conditions:

- (1) This device may not cause interference, and
- (2) this device must accept any interference, including interference that may cause undesired operation of the device.

Le présent appareil est conforme aux CNR d'Industrie Canada applicables aux appareils radio exempts de licence. L'exploitation est autorisée aux deux conditions suivantes :

- (1) L'appareil ne doit pas produire de brouillage, et
- (2) l'utilisateur de l'appareil doit accepter tout brouillage radioélectrique subi, même si le brouillage est susceptible d'en compromettre le fonctionnement.

Industry Canada Notice

To reduce potential radio interference to other users, the antenna type and its gain should be so chosen that the equivalent isotropically radiated power (e.i.r.p.) is not more than that permitted for successful communication.

Transmitter power and antenna information for antennas with a gain less than 6 dBi:

This device has been designed to operate with the SIMATIC RF620A antenna 902-928, the SIMATIC RF640A antenna 902-928 as well as the SIMATIC RF660A antenna 902-928 listed below, and having a maximum gain of 5,5 dBi.

Arbitrary transmission power settings in combination with other antennas or antennas having a gain greater than 5,5 dBi are strictly prohibited for use with this device.

The required antenna impedance is 50 Ohms.

Transmitter power and antenna information for antennas with a gain greater 6 dBi:

This device requires professional installation. Antennas with a gain greater 6 dBi may be used provided the system does not exceed the radiation power of 4000 mW E.I.R.P. This device has been designed to operate with the SIMATIC RF642A antenna 902-928 exceeding the maximum gain of 5,5 dBi under the restriction that the RF power at the input of the antenna must be set to meet the following relation: RF power (dBm) \leq 30 dBm – (antenna gain (dBi) – 6 dBi) Other antennas or system configurations for antennas having a gain greater than 6 dBi are strictly prohibited for use with this device. The required antenna impedance is 50 Ohms.

5.5 SIMATIC RF680R

5.5.1 Description

5.5.1.1 Overview

The SIMATIC RF680R is a stationary reader in the UHF frequency band without an integrated antenna. Up to four external UHF RFID antennas can be connected via RP-TNC connectors.

The maximum transmit power is 2000 mW at the reader output. A radiated power of up to 2000 mW ERP / 4000 mW EIRP is achieved when the appropriate antennas and antenna cables are used. The interfaces (Ethernet, power supply, DI/DQ interface) are located on the lower front edge. These interfaces can be used to connect the reader to the power supply and to a PC or a controller for parameter assignment.

The degree of protection is IP65.

	Pos.	Description
	①	RP-TNC interfaces for connecting up to 4 external antennas
	②	LED status display
	③	LED operating display
	④	DI/DQ interface: X10 DI/DQ (M12, 12-pin)
	⑤	Interface to power supply (RS422), 24 V DC ¹⁾ : X80 DC24V (M12, 8-pin)
	⑥	Ethernet interface, TCP/IP: X1 P1 (M12, 4-pin)
	⑦	Ethernet interface, TCP/IP: X1 P2 (M12, 4-pin)

¹⁾) Connection of the readers to the ASM 456 communications module via the RS-422 interface.

5.5.1.2 Ordering data

Table 5- 34 Ordering data RF680R

Product	Article number
RF680R (ETSI)	6GT2811-6AA10-0AA0
RF680R (FCC)	6GT2811-6AA10-1AA0
RF680R (CMIIT)	6GT2811-6AA10-2AA0
RF680R (ARIB)	6GT2811-6AA10-4AA0

Table 5- 35 Ordering data accessories

Product	Article number
Holder set for securing the reader <ul style="list-style-type: none"> DIN rail T35 (S7-1200) S7-300 standard rail S7-1500 standard rail 	6GT2890-0AB00
SIMATIC antenna holder for RF600 devices	6GT2890-2AB10
Connecting cable and connectors	
<ul style="list-style-type: none"> DI/DQ cable connector open cable ends 	5 m 6GT2891-0CH50
<ul style="list-style-type: none"> Ethernet plug on the reader FastConnect M12 (IP65) 	6GK1901-0DB20-6AA0
<ul style="list-style-type: none"> Ethernet plug Standard IE FastConnect RJ45 180 (IP20) 	6GK1901-1BB10-2AA0
<ul style="list-style-type: none"> Industrial Ethernet cable M12 / RJ45 	5 m 6XV1871-5TH50
<ul style="list-style-type: none"> Industrial Ethernet cable M12 / M12 	5 m 6XV1870-8AH50
<ul style="list-style-type: none"> Industrial Ethernet connecting cable M12-180 / RJ45 	2 m 6XV1871-5TH20
	3 m 6XV1871-5TH30
	5 m 6XV1871-5TH50
<ul style="list-style-type: none"> Industrial Ethernet cable by the meter, green (minimum 20 m) 	6XV1840-2AH10
<ul style="list-style-type: none"> Connecting cable reader ↔ CM M12-180 / M12-180 	2 m 6GT2891-4FH20
	5 m 6GT2891-4FH50
	10 m 6GT2891-4FN10
	20 m 6GT2891-4FN20
	50 m 6GT2891-4FN50

Product	Article number
Connecting cable CM ↔ reader / extension cable for 24 V connecting cable RS422, M12 connector, 8-pin socket	
• 2 m	6GT2891-4FH20
• 5 m	6GT2891-4FH50
• 10 m	6GT2891-4FN10
• 20 m	6GT2891-4FN20
• 50 m	6GT2891-4FN50
Wide-range power supply unit for SIMATIC RF systems	
• With EU plug	6GT2898-0AC00
• With UK plug	6GT2898-0AC10
• With US plug	6GT2898-0AC20
24 V connecting cable reader ↔ wide-range power supply unit	
• with plug, 5 m	6GT2891-0PH50
• with open ends, 2 m	6GT2891-4EH20
• with open ends, 5 m	6GT2891-4EH50
Set of protective caps Contains 3 protective caps for antenna output, one protective cap for digital I/O interface and 2 protective caps for Ethernet/PROFINET (required for IP65 degree of protection when some connectors are unused)	6GT2898-4AA10
DVD "Ident Systems Software & Documentation"	6GT2080-2AA20

5.5.1.3 Pin assignment of the DI/DQ interface (X10 DI/DQ)

Table 5- 36 Pin assignment of the DI/DQ interface (reader end)

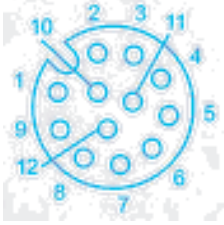
View of interface (M12 socket, 12-pin)	Pin	Pin assignment
	1	GND (output to supply of the digital inputs/outputs [not galvanically isolated])
	2	VCC (output to the supply of the digital inputs/outputs [not galvanically isolated])
	3	DO Common / Output Common
	4	DO 0 / Output 00
	5	DO 1 / Output 01
	6	DO 2 / Output 02
	7	DO 3 / Output 03
	8	DI 0 / Input 00
	9	DI Common / Input Common
	10	DI 1 / Input 01
	11	DI 2 / Input 02
	12	DI 3 / Input 03

Note

Requirement for external power sources

When the DI/DQ interface is supplied with power by an external power source, this source must meet the requirements for LPS (Limited Power Sources) and NEC Class 2.

Color scheme of the DI/DQ standard cable with M12 connector

The following figure shows the color scheme of the DI/DQ standard cable from Siemens (6GT2891-0CH50). You can use the color scheme to assign the wire colors to the pins.

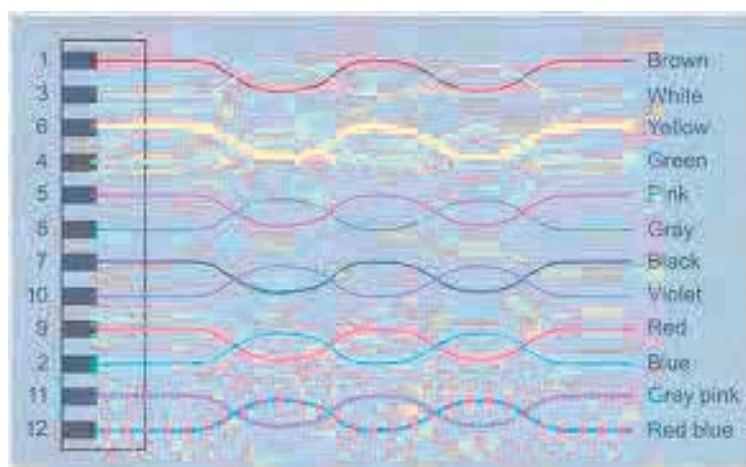

Figure 5-24 Wiring diagram: M12 connector

5.5.1.4 Switching scheme for the DI/DQ interface

Connection possibilities

You can connect the reader in different ways. In general, the outputs and inputs should be connected as follows:

Output (DO 0 ... 3)

- Each output is rated for 0.5 A current and is electronically protected.
- 4 digital outputs can be operated simultaneously each with up to 0.5 A (up to 1 A in total). With a total current > 1 A, you need to use an external power supply.
- The outputs are optically isolated through optocouplers.

input (DI 0 ... 3)

- The inputs are optically isolated through optocouplers.
- Level
 - Low: 0 ... 7 V
 - High: 15 ... 24 V

The following diagrams illustrate various connection possibilities.

Note

Minimum time between changes

Note that changes on the DI/DQ interface that are not applied for at least 1.5 seconds are not detected by the reader.

Voltage infeed from internal source (no electrical isolation)

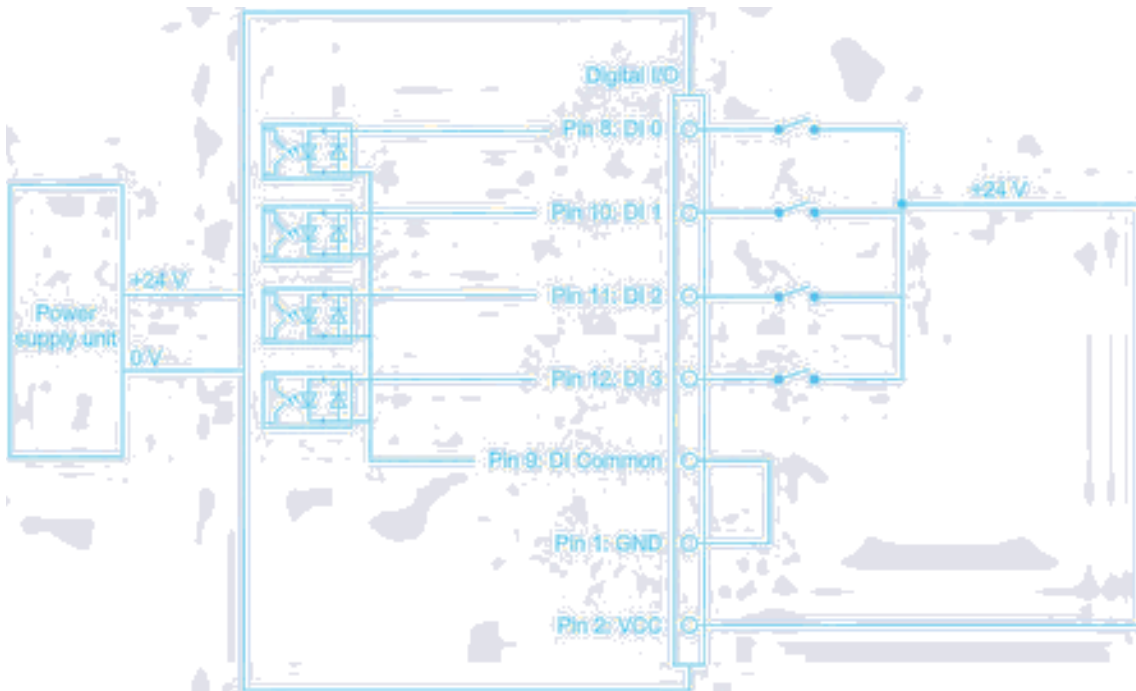

Figure 5-25 Circuit example 1: Digital inputs

Alternative connection possibilities:

- Pin 2 (VCC) to Pin 9 DI Common
- Pin 1 GND to busbar inputs

Voltage infeed from external source

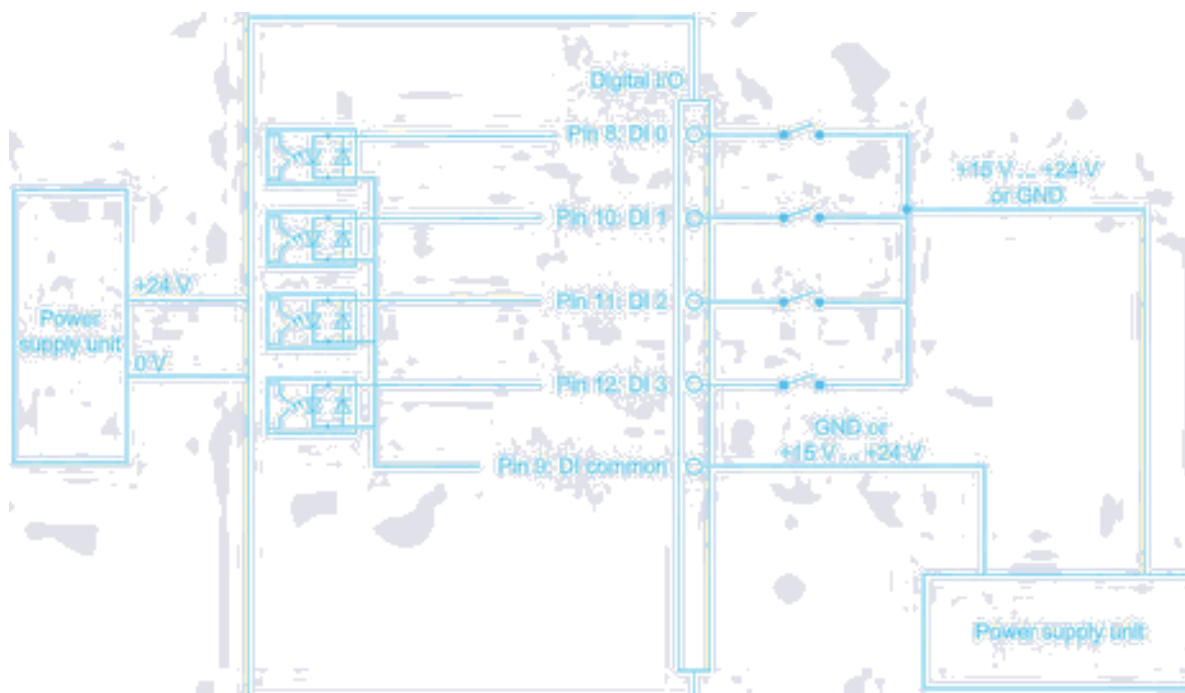

Figure 5-26 Circuit example 2: Digital inputs

Voltage infeed from external source with various voltages

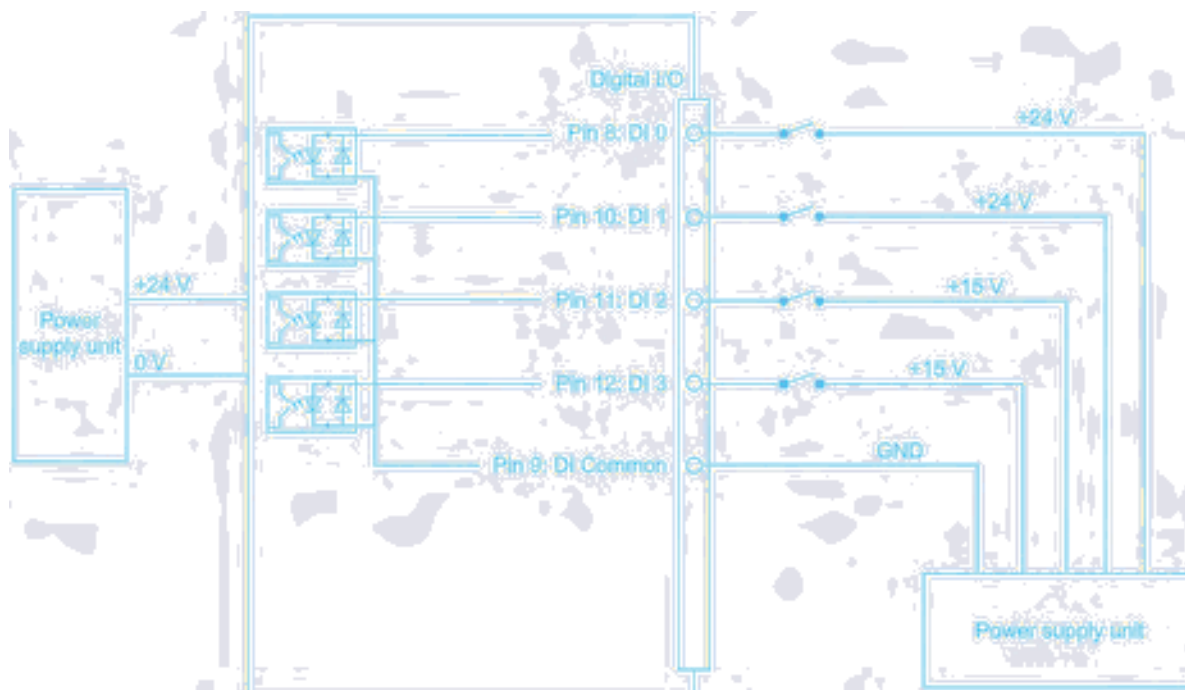

Figure 5-27 Circuit example 3: Digital inputs

Voltage infeed from internal source

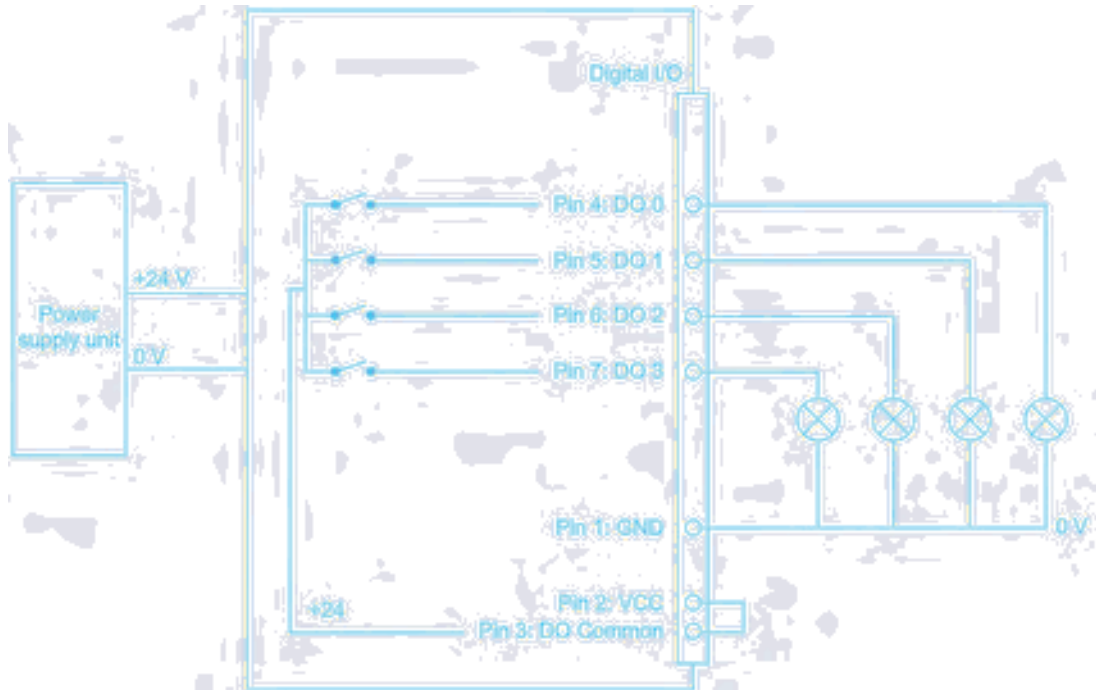

Figure 5-28 Circuit example 4: Digital outputs

Alternative connection possibilities:

- Pin 1 GND to Pin 3 DO Common
- Pin 2 (VCC) to busbar outputs

Voltage infeed from external source

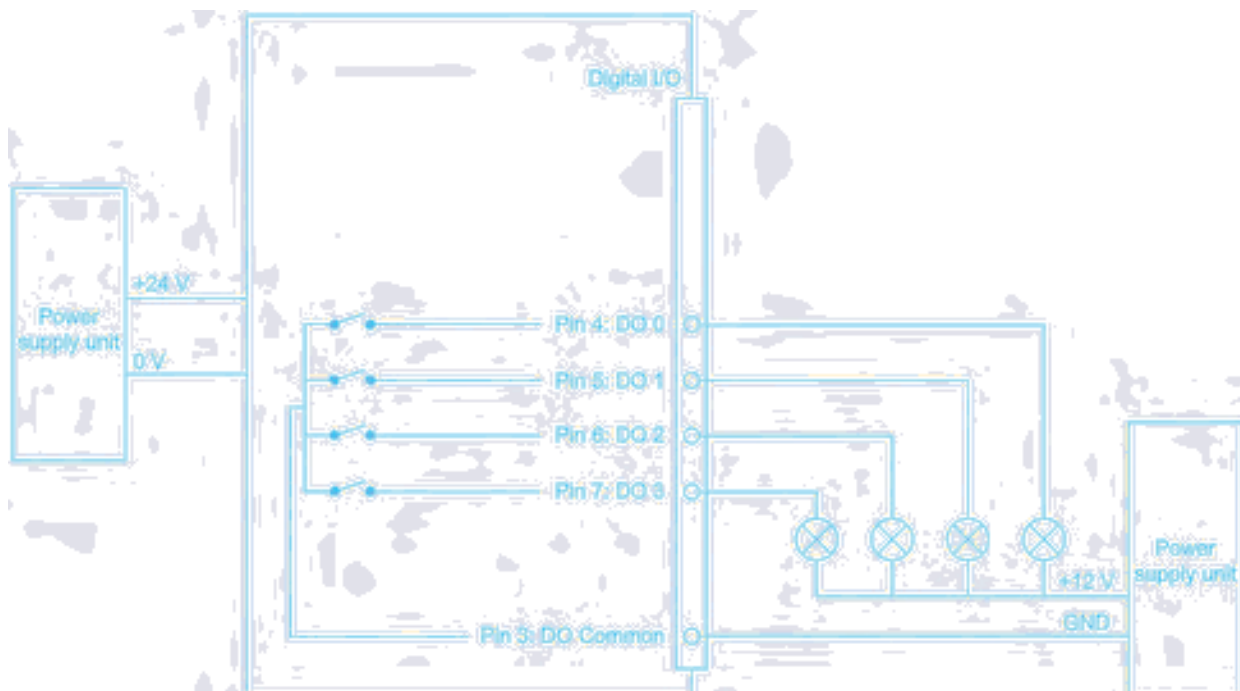

Figure 5-29 Circuit example 5: Digital outputs

Voltage infeed from an external source is shown here for 12 V as an example. Other voltages are also permissible.

Voltage infeed from external source with various voltages

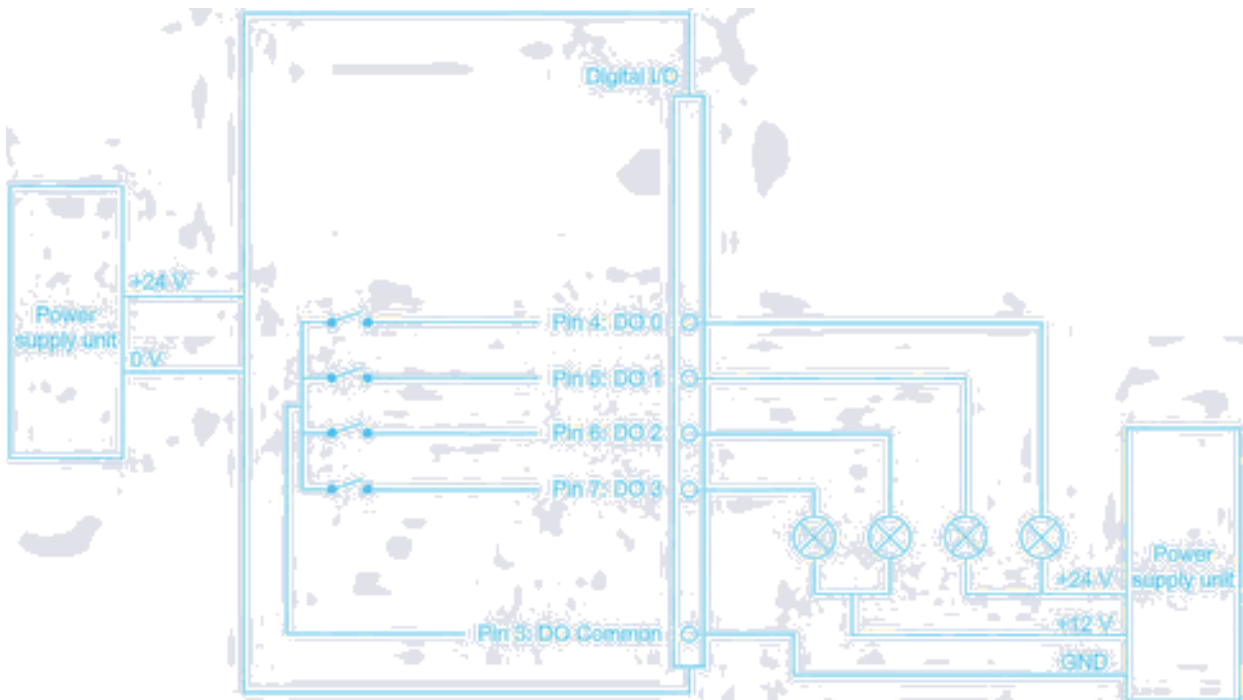

Figure 5-30 Circuit example 6: Digital outputs

5.5.1.5 Pin assignment of the power supply interface (X80 24VDC)

Table 5- 37 Pin assignment of the RS422 interface (reader end)

View of interface (M12 socket, 8-pin)	Pin	Wire colors	Assignment
	1	White	+ 24 V
	2 ¹⁾	Brown	- Tx
	3	Green	0 V
	4 ¹⁾	Yellow	+ Tx
	5 ¹⁾	Gray	+ Rx
	6 ¹⁾	Pink	- Rx
	7	--	Unassigned
	8	--	Earth (shield)

¹⁾ These pins are not required if the reader is operated via Ethernet.

Note**Requirement for external power sources**

The reader must only be supplied with power by power supply units that meet the requirements of LPS (Limited Power Source) and NEC Class 2.

Requirement for external power sources

The reader must only be supplied with power by power supply units that meet the requirements of limited power source (LPS) and NEC Class 2.

Spécification des sources de tension externes

L'alimentation du plot de lecture/écriture doit être exclusivement assurée par des blocs d'alimentation conformes aux spécifications des sources à puissance limitée (Limited Power Sources LPS) et de NEC class 2.

Notes on connectors and cables

The cables with open cable ends (6GT2891-4EH20, 6GT2891-4EH50) have an 8-pin M12 plug at one end, while the other end of the cable is "open". There are 8 color-coded single wires there for connecting to external devices.

The product range includes additional cables of the type 6GT2891-4Fxxx (2 to 50 m) with an M12 connector at both ends. These cables can be used as extension cables. Long cables can be shortened if necessary.

NOTICE**Insulate unused single wires**

Unused single wires must be insulated individually to prevent unwanted connections of signal lines.

NOTICE**For long cables: Adapt the power supply and transmission speed**

Note that even with long cables, the supply voltage of 24 VDC must always be guaranteed. Note also that the transmission speed on the serial interface must, if necessary, be reduced.

SIMATIC standard cables (e.g. 6GT2891-4FN10) have a loop resistance of 160 mOhm / meter. This results in a voltage drop of 0.8 volts on the 24 V cable for every 10 meters of connecting cable and with a power requirement of 500 mA. If the power requirement increases through the use of the digital inputs/outputs, the voltage drop increases accordingly.

5.5.1.6 Pin assignment of the Industrial Ethernet interface (X1 P1; X1 P2)

Table 5- 38 Pin assignment of the Industrial Ethernet interface (reader end)

View of interface (M12 socket, 4-pin)	Pin	Pin assignment
	1	Data line +Tx
	2	Data line +Rx
	3	Data line -Tx
	4	Data line -Rx

5.5.1.7 Grounding connection

On the top of the reader there is a blind drill hole (M4 x 8) for grounding. Tighten the screw with a torque of ≈ 1.5 Nm.

<p>! WARNING</p> <p>Hazardous voltage due to lightning strikes</p> <p>Death or serious injury may occur as a result of lightning strikes to antennas mounted outside buildings.</p> <p>If the reader is operated with antennas mounted outside buildings, it is imperative that the reader is electrically connected to the ground potential.</p>

<p>NOTICE</p> <p>Installation only in protected areas</p> <p>The antenna can be installed in the protected part of a building. When implementing your lightning protection concept, make sure you adhere to the VDE 0182 or IEC 62305 standards.</p>
--

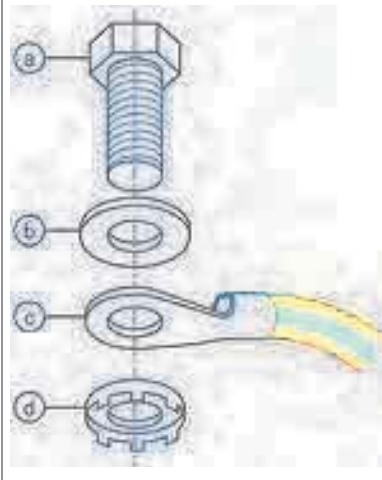
Ground connection	
	(a) Screw (M4 x 8)
	(b) Flat washer
	(c) Cable lug
	(d) Contact washer

5.5.2 Planning operation

5.5.2.1 Antenna/read point configurations

You can connect up to four external antennas to the RF680R reader. The standard setting is that an antenna is connected when the reader is started. When connecting multiple antennas, note the information in the section "Specified minimum and maximum spacing of antennas (Page 46)".

With the WBM, you can set up various different configurations of antennas and/or reading points as required. Based on the number of data sources and subsequent assignment of the antennas, many tasks can be accomplished.

Examples of possible antenna reading point configurations

- Four data sources each with one antenna for four different reading points.
- Two data sources each with two antennas for small portals.
- One data source with 4 antennas for large portals.

You will find further information in the online help of the products.

5.5.3 Installation/mounting

Requirement

NOTICE
Close unused connectors Note that the readers only have the specified degree of protection when all connectors are in use or when unused connectors are closed with the protective caps. Close any connectors on the reader that you are not using with protective caps. You can order the protective cap set using the article number specified in the section "Ordering data".

 CAUTION
Emitted radiation The transmitter complies with the requirements of Health Canada and the FCC limit values for subjecting persons to HF radiation, provided that a minimum spacing of 26 cm exists between antenna and person. When the antennas are installed, you must therefore ensure that a minimum spacing of 26 cm is maintained between personnel and antennas.

5.5.3.1 Mounting/Installation

Mounting/installing the device

You can mount the reader in the following ways:

- DIN rail T35 (S7-1200)
- S7-300 standard rail
- S7-1500 standard rail
- directly on a flat surface using the VESA 100 mounting system (torque \approx 1.5 Nm).

The positions of the mounting holes for the device are shown in the section Dimension drawing (Page 190).

Mounting the reader on a DIN/standard rail

Table 5- 39 DIN rail mounting

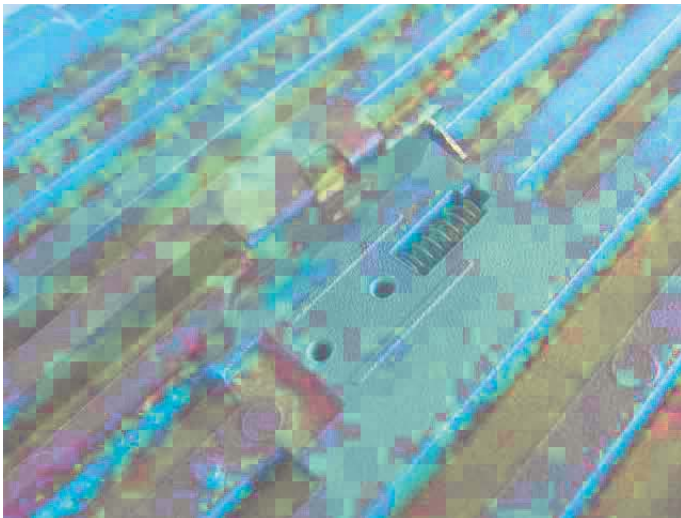
	Description
	<p>1. Place the spring in the groove.</p>

	Description
	<p>2. Mount the holder using the supplied Torx screws. When mounting the holder, make sure that the angled tip is positioned above the spring in the groove.</p>
	<p>3. Fit the lower part of the locking mechanism of the reader into the DIN rail. To be able to mount the reader on or remove it from the DIN rail, pull down the holder mounted in step 2.</p>

Table 5- 40 Installation on a standard rail

	Description
	<ol style="list-style-type: none"> <li data-bbox="887 398 1469 454">1. Mount the two adapter pieces using the supplied Torx screws.
	<ol style="list-style-type: none"> <li data-bbox="887 965 1469 1021">2. Fit the upper part of the locking mechanism of the reader into the standard rail. <li data-bbox="887 1032 1469 1088">3. Secure the reader using the supplied slotted-head screws.

5.5.4 Configuration/integration

An Ethernet interface is available for integrating the device into system environments/networks. The RF680R can be configured via the Ethernet interface and with direct connection to the PC. You can configure and program the reader using the following tools:

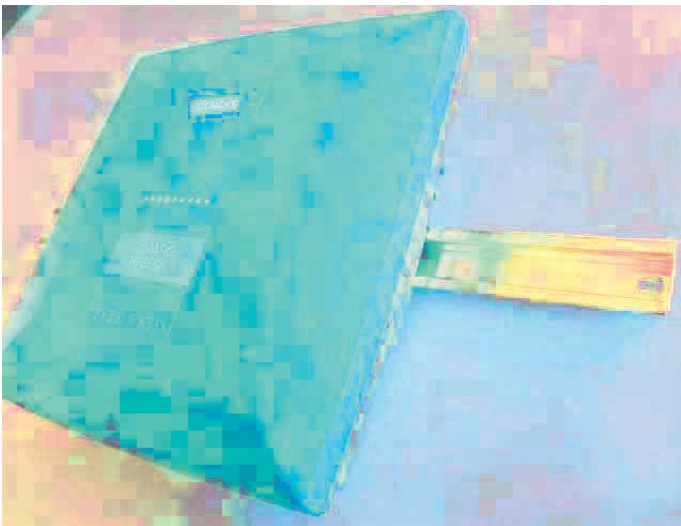
- STEP 7 Basic/Professional (TIA Portal)
- or via EtherNet/IP
- Web Based Management (WBM)
- OPC UA or XML based user applications

Note that configuration in parallel is not possible using different tools. Simple process controls (e.g. a traffic signal) can be implemented directly using the reader via four digital inputs/outputs.

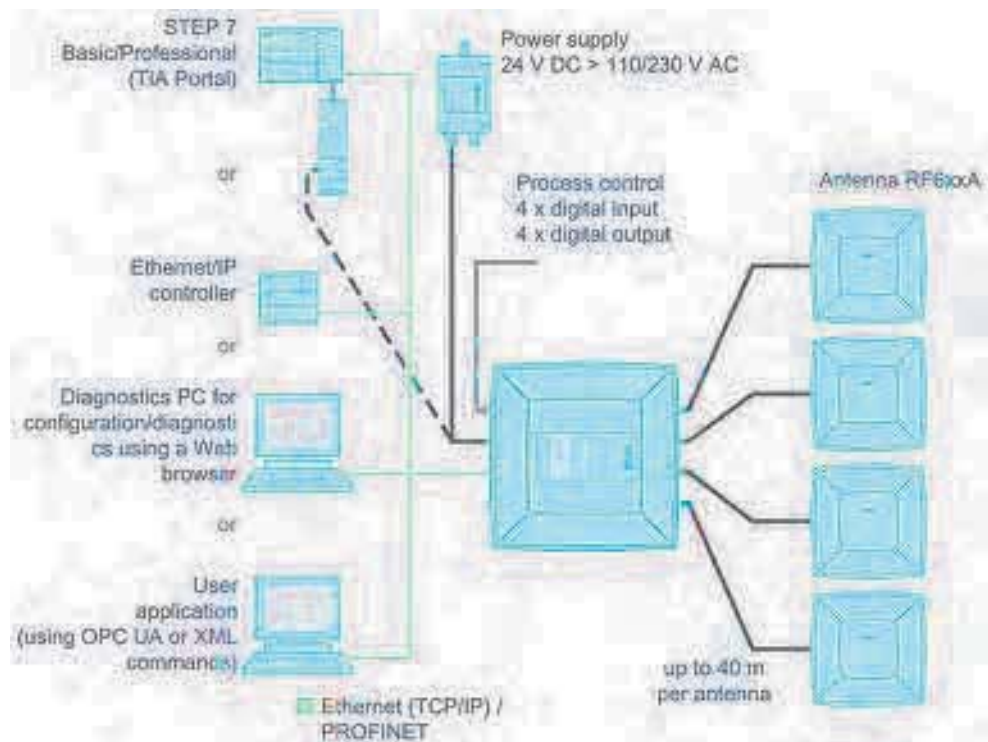

Figure 5-31 Overview: Configuration of RF680R readers

5.5.5 Technical specifications

Table 5- 41 Technical specifications of the RF680R reader

6GT2811-6AA10-xAA0	
Product type designation	SIMATIC RF680R
Radio frequencies	
Operating frequency	
• ETSI	• 865 to 868 MHz
• FCC	• 902 to 928 MHz
• CMIIT	• 920 to 925 MHz
• ARIB (STD-T106)	• 916.8 MHz to 920.4 MHz
Transmit power ¹⁾	
• ETSI	• 3 to 2000 mW
• FCC	• 3 to 2000 mW
• CMIIT	• 3 to 2000 mW
• ARIB (STD-T106)	• 3 to 1000 mW
Maximum radiated power per antenna	
• ETSI	• 2000 mW ERP
• FCC	• 4000 mW EIRP
• CMIIT	• 2000 mW ERP
• ARIB (STD-T106)	• 4000 mW EIRP
Electrical data	
Range	
• ETSI	• ≤ 8 m
• FCC	• ≤ 8 m
• CMIIT	• ≤ 8 m
• ARIB (STD-T106)	• ≤ 8 m
Protocol	ISO 18000-62/-63
Transmission speed	≤ 300 kbps
Frequency accuracy	≤ ±10 ppm

6GT2811-6AA10-xAA0	
Channel spacing	
• ETSI	• 600 kHz
• FCC	• 500 kHz
• CMIIT	• 250 kHz
• ARIB (STD-T106)	• 1200 kHz
Modulation methods	ASK: DSB modulation & PR-ASK modulation encoding, Manchester or Pulse Interval (PIE)
Multitag capability	Yes
Typical transmission time per byte	
• Write access	• 2 ms
• Read access	• 0.15 ms
Supply voltage	24 V DC (20 ... 30 V DC) ²⁾
Maximum permitted current consumption	2 A
Maximum permitted current consumption via DI/DQ interface	1 A ³⁾
Current consumption (on standby), typical	
• 20 V input voltage on the reader	• 220 mA / 4.4 W
• 24 V input voltage on the reader	• 190 mA / 4.5 W
• 30 V input voltage on the reader	• 150 mA / 4.5 W
Current consumption (at 1000 mW transmit power), typical	
• 20 V input voltage on the reader	• 450 mA / 9.0 W
• 24 V input voltage on the reader	• 380 mA / 9.1 W
• 30 V input voltage on the reader	• 300 mA / 9.6 W
Current consumption (at 2000 mW transmit power), typical	
• 20 V input voltage on the reader	• 610 mA / 12.2 W
• 24 V input voltage on the reader	• 500 mA / 12.0 W
• 30 V input voltage on the reader	• 410 mA / 12.3 W
Interfaces	
Antenna connectors	4x RP-TNC
Power supply	1x M12 (8-pin)
DI/DQ interface	1x M12 (12-pin)
Digital inputs	4
Digital outputs	4
Ethernet interface	2x M12 (4-pin), 100 Mbps

6GT2811-6AA10-xAA0

Mechanical specifications

Material

- | | |
|-------------------------|-------------------------|
| • Upper part of housing | • Pocan (silicone-free) |
| • Lower part of housing | • Aluminum |
-

Color

- | | |
|-------------------------|-----------|
| • Upper part of housing | • TI-Grey |
| • Lower part of housing | • Silver |
-

Permitted ambient conditions

Ambient temperature

- | | |
|-------------------------------------|------------------|
| • During operation | • -25 ... +55 °C |
| • During transportation and storage | • -40 ... +85 °C |
-

Degree of protection	IP65
----------------------	------

Shock resistant to EN 60068-2-27	25.5 g ⁴⁾
----------------------------------	----------------------

Vibrations according to EN 60068-2-6	3.1 g ⁴⁾
--------------------------------------	---------------------

Design, dimensions and weight

Dimensions (W × H × D)	258 × 258 × 80 mm
------------------------	-------------------

Weight	2.4 kg
--------	--------

Type of mounting

- | | |
|-----------------|---------------------------|
| • Mounting rail | • Hanging |
| • VESA 100 | • 4x M4 screws (≈ 1.5 Nm) |
-

Operation indicator	8 LEDs
---------------------	--------

Status display	9 LEDs
----------------	--------

6GT2811-6AA10-xAA0

Standards, specifications, approvals

Proof of suitability	EN 301 489-1 V1.9.2 / EN 301 489-3 V1.6.1 / EN 302 208-1/-3 V1.4.1 FCC CFR 47, Part 15 section 15.247
MTBF	28 years

- 1) Measured at the output of the antenna socket.
- 2) All supply and signal voltages must be safety extra low voltage (SELV/PELV according to EN 60950). The voltage sources must meet the requirements of limited power sources (LPS) and NEC Class 2.

Note that, depending on the power consumption, using extension cables > 20 m (6GT2891-4FN50) may lead to a voltage drop on the reader. This voltage drop can mean that the necessary minimum voltage on the reader is below the required 20 V.

- 3) Keep to the switching schemes of the DI/DQ interface.
- 4) The values for shock and vibration are maximum values and must not be applied continuously. These values only apply to mounting using screws.

5.5.6 Dimension drawing

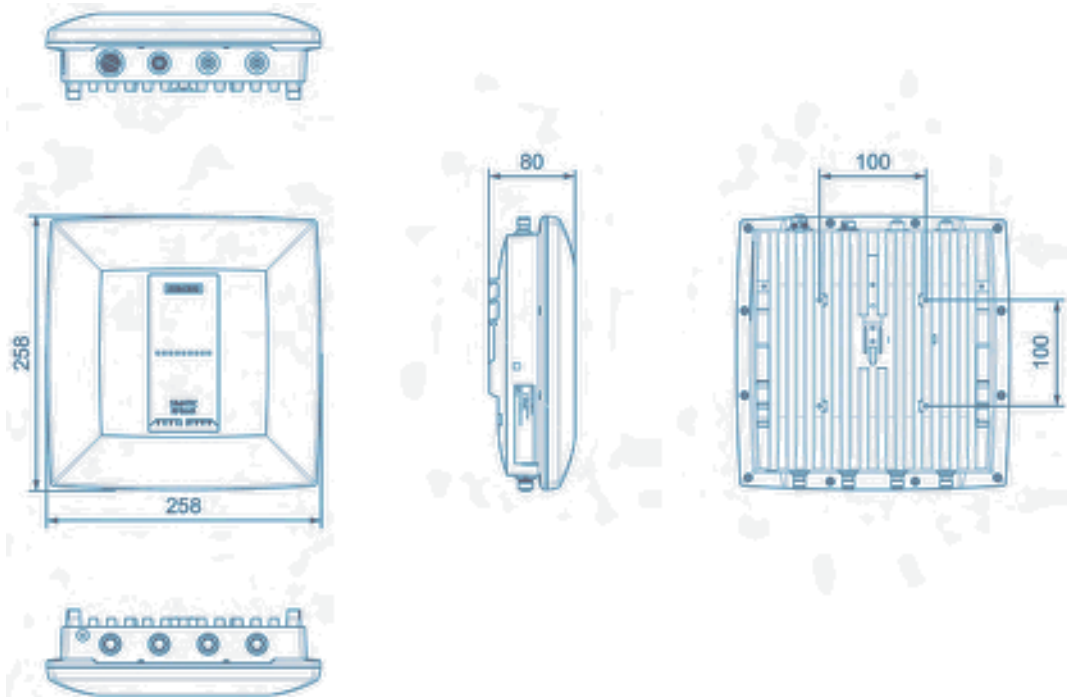

Figure 5-32 Dimension drawing RF680R

All dimensions in mm (± 0.5 mm tolerance)

5.5.7 Certificates and approvals

Note



Marking on the readers according to specific approval

The certificates and approvals listed here apply only if the corresponding mark is found on the readers.

Table 5- 42 6GT2811-6AA10-0AA0

Labeling	Description
	Conformity with the RED directive 2014/53/EU Conformity with the RoHS directive 2011/65/EU
	South Africa radio approval: Radio Equipment Type Approval
India	India wireless approval Marking on the reader: No. NR-ETA/1588
	Radio approval for Russia, Belarus, Kazakhstan

Table 5- 43 6GT2811-6AA10-1AA0

Labeling	Description
 Federal Communications Commission	FCC CFR 47, Part 15 section 15.247 Radio Frequency Interference Statement This equipment has been tested and found to comply with the limits for a Class B digital device, pursuant to Part 15 of the FCC Rules. FCC ID: NXW-RF600R2
Industry Canada Radio Standards Specifications	RSS-210 Issue 7, June 2007, Section 2.2, A8 IC: 267X-RF600R2, Model: RF680R
	This product is UL-certified for the USA and Canada. It meets the following safety standard(s): UL 60950-1 - Information Technology Equipment Safety - Part 1: General Requirements CSA C22.2 No. 60950 -1 - Safety of Information Technology Equipment UL Report E 115352



Labeling	Description
	<p>Brazil radio approval Marking on the reader (6GT2811-6AA10-1AA0):</p>  <p>Statement about approval: Este equipamento opera em caráter secundário, isto é, não tem direito à proteção contra interferência prejudicial, mesmo de estações do mesmo tipo e não pode causar interferência a sistemas operando em caráter primário. Reader certificate: ANATEL 2892-15-4794</p>
	<p>KCC Certification Type of equipment: A급 기기 (업무용 방송통신기자재) Class A Equipment (Industrial Broadcasting & Communication Equipment) 이 기기는 업무용(A급) 전자파적합기기로서 판 매자 또는 사용자는 이 점을 주의하시기 바라 며, 가정외의 지역에서 사용하는 것을 목적으로 합니다. This equipment is Industrial (Class A) electromagnetic wave suitability equipment and seller or user should take notice of it, and this equipment is to be used in the places except for home. Certificate of the reader: MSIP-CMM-RF5-RF680R</p>
<p>C-141618</p>	<p>Argentina radio approval: Registro de la COMISION NACIONAL DE COMUNICACIONES</p>
<p>RCPSIS14-1926-A1</p>	<p>Mexico radio approval: CERTIFICADO DE HOMOLOGACION, IFETEL</p>
	<p>Australia radio approval: This product meets the requirements of the AS/NZS 3548 Norm.</p>

Table 5- 44 6GT2811-6AA10-2AA0

Standard	
<p>CMIIT Certification</p>	<p>China radio approval Marking on the reader: CMIIT ID: 2014DJ3988</p>

5.5.7.1 FCC information

Siemens SIMATIC RF680R (FCC): 6GT2811-6AA10-1AA0

FCC ID: NXW-RF600R2

This device complies with part 15 of the FCC rules. Operation is subject to the following two conditions:

- (1) This device may not cause harmful interference, and
- (2) this device must accept any interference received, including interference that may cause undesired operation.

Caution

Any changes or modifications not expressly approved by the party responsible for compliance could void the user's authority to operate the equipment.

Note

This equipment has been tested and found to comply with the limits for a Class B digital device, pursuant to part 15 of the FCC Rules.

These limits are designed to provide reasonable protection against harmful interference when the equipment is operated in a commercial environment. This equipment generates, uses, and can radiate radio frequency energy and, if not installed and used in accordance with the instruction manual, may cause harmful interference to radio communications. Operation of this equipment in a residential area is likely to cause harmful interference in which case the user will be required to correct the interference at his own expense.

FCC Notice

To comply with FCC part 15 rules in the United States, the system must be professionally installed to ensure compliance with the Part 15 certification.

It is the responsibility of the operator and professional installer to ensure that only certified systems are deployed in the United States. The use of the system in any other combination (such as co-located antennas transmitting the same information) is expressly forbidden.

FCC Exposure Information

To comply with FCC RF exposure compliance requirements, the antennas used for this transmitter must be installed to provide a separation distance of at least 20 cm from all persons and must not be co-located or operating in conjunction with any other antenna or transmitter.

5.5.7.2 IC-FCB information

Siemens SIMATIC RF680R (FCC): 6GT2811-6AA10-1AA0

IC: 267X-RF600R2

This device complies with Industry Canada licence-exempt RSS standard(s). Operation is subject to the following two conditions:

- (1) This device may not cause interference, and
- (2) this device must accept any interference, including interference that may cause undesired operation of the device.

Le présent appareil est conforme aux CNR d'Industrie Canada applicables aux appareils radio exempts de licence. L'exploitation est autorisée aux deux conditions suivantes :

- (1) L'appareil ne doit pas produire de brouillage, et
- (2) l'utilisateur de l'appareil doit accepter tout brouillage radioélectrique subi, même si le brouillage est susceptible d'en compromettre le fonctionnement.

Industry Canada Notice

To reduce potential radio interference to other users, the antenna type and its gain should be so chosen that the equivalent isotropically radiated power (e.i.r.p.) is not more than that permitted for successful communication.

Transmitter power and antenna information for antennas with a gain less than 6 dBi:

This device has been designed to operate with the SIMATIC RF620A antenna 902-928, the SIMATIC RF640A antenna 902-928 as well as the SIMATIC RF660A antenna 902-928 listed below, and having a maximum gain of 5,5 dBi.

Arbitrary transmission power settings in combination with other antennas or antennas having a gain greater than 5,5 dBi are strictly prohibited for use with this device.

The required antenna impedance is 50 Ohms.

Transmitter power and antenna information for antennas with a gain greater 6 dBi:

This device requires professional installation. Antennas with a gain greater 6 dBi may be used provided the system does not exceed the radiation power of 4000 mW E.I.R.P. This device has been designed to operate with the SIMATIC RF642A antenna 902-928 exceeding the maximum gain of 5,5 dBi under the restriction that the RF power at the input of the antenna must be set to meet the following relation: $RF \text{ power (dBm)} \leq 30 \text{ dBm} - (\text{antenna gain (dBi)} - 6 \text{ dBi})$ Other antennas or system configurations for antennas having a gain greater than 6 dBi are strictly prohibited for use with this device. The required antenna impedance is 50 Ohms.

5.6 SIMATIC RF685R

5.6.1 Description

5.6.1.1 Overview

The SIMATIC RF685R is a stationary reader in the UHF frequency band with an integrated antenna. An additional external UHF RFID antenna can be connected via an RP-TNC connector.

The maximum transmit power is 2000 mW at the external reader output, the radiated power of the internal antenna is also 2000 mW ERP/EIRP. A radiated power of up to 2000 mW ERP / 4000 mW EIRP is achieved when the appropriate antennas and antenna cables are used. The interfaces (Ethernet, power supply, DI/DQ interface) are located on the lower front edge. These interfaces can be used to connect the reader to the power supply and to a PC or a controller for parameter assignment.

The degree of protection is IP65.

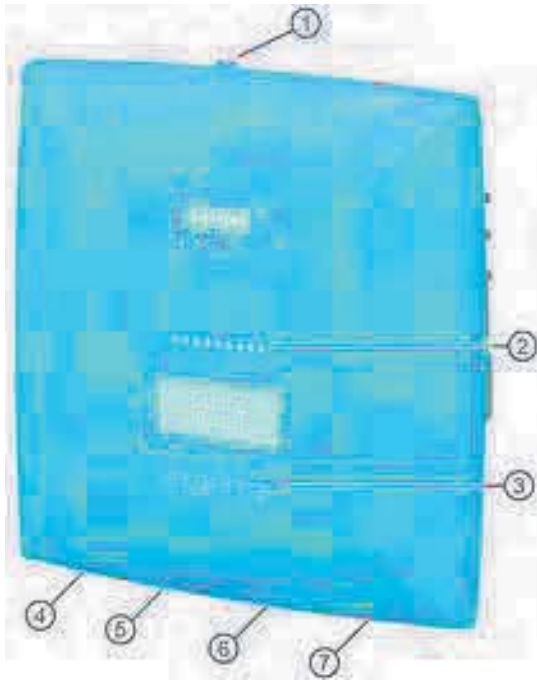
	Pos.	Description
	①	RP-TNC interface for connection of an external antenna
	②	LED status display
	③	LED operating display
	④	DI/DQ interface: X10 DI/DQ (M12, 12-pin)
	⑤	Interface to power supply (RS422), 24 V DC ¹⁾ : X80 DC24V (M12, 8-pin)
	⑥	Ethernet interface, TCP/IP: X1 P1 (M12, 4-pin)
	⑦	Ethernet interface, TCP/IP: X1 P2 (M12, 4-pin)

¹⁾) Connection of the readers to the ASM 456 communications module via the RS-422 interface.

5.6.1.2 Ordering data

Table 5- 45 Ordering data RF685R

Product	Article number
RF685R (ETSI)	6GT2811-6CA10-0AA0
RF685R (FCC)	6GT2811-6CA10-1AA0
RF685R (CMIIT)	6GT2811-6CA10-2AA0
RF685R (ARIB)	6GT2811-6CA10-4AA0

Table 5- 46 Ordering data accessories

Product	Article number
Holder set for securing the reader <ul style="list-style-type: none"> DIN rail T35 (S7-1200) S7-300 standard rail S7-1500 standard rail 	6GT2890-0AB00
SIMATIC antenna holder for RF600 devices	6GT2890-2AB10
Connecting cable and connectors	
<ul style="list-style-type: none"> DI/DQ cable connector open cable ends 	5 m 6GT2891-0CH50
<ul style="list-style-type: none"> Ethernet plug on the reader FastConnect M12 (IP65) 	6GK1901-0DB20-6AA0
<ul style="list-style-type: none"> Ethernet plug Standard IE FastConnect RJ45 180 (IP20) 	6GK1901-1BB10-2AA0
<ul style="list-style-type: none"> Industrial Ethernet cable M12 / RJ45 	5 m 6XV1871-5TH50
<ul style="list-style-type: none"> Industrial Ethernet cable M12 / M12 	5 m 6XV1870-8AH50
<ul style="list-style-type: none"> Industrial Ethernet connecting cable M12-180 / RJ45 	2 m 6XV1871-5TH20
	3 m 6XV1871-5TH30
	5 m 6XV1871-5TH50
<ul style="list-style-type: none"> Industrial Ethernet cable by the meter, green (minimum 20 m) 	6XV1840-2AH10
<ul style="list-style-type: none"> Connecting cable reader ↔ CM M12-180 / M12-180 	2 m 6GT2891-4FH20
	5 m 6GT2891-4FH50
	10 m 6GT2891-4FN10
	20 m 6GT2891-4FN20
	50 m 6GT2891-4FN50

Product	Article number
Connecting cable CM ↔ reader / extension cable for 24 V connecting cable RS422, M12 connector, 8-pin socket	
• 2 m	6GT2891-4FH20
• 5 m	6GT2891-4FH50
• 10 m	6GT2891-4FN10
• 20 m	6GT2891-4FN20
• 50 m	6GT2891-4FN50
Wide-range power supply unit for SIMATIC RF systems	
• With EU plug	6GT2898-0AC00
• With UK plug	6GT2898-0AC10
• With US plug	6GT2898-0AC20
24 V connecting cable reader ↔ wide-range power supply unit	
• with plug, 5 m	6GT2891-0PH50
• with open ends, 2 m	6GT2891-4EH20
• with open ends, 5 m	6GT2891-4EH50
Set of protective caps Contains 3 protective caps for antenna output, one protective cap for digital I/O interface and 2 protective caps for Ethernet/PROFINET (required for IP65 degree of protection when some connectors are unused)	6GT2898-4AA10
DVD "Ident Systems Software & Documentation"	6GT2080-2AA20

5.6.1.3 Pin assignment of the DI/DQ interface (X10 DI/DQ)

Table 5- 47 Pin assignment of the DI/DQ interface (reader end)

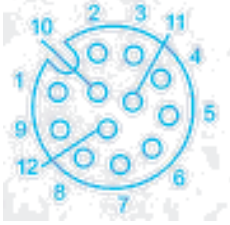
View of interface (M12 socket, 12-pin)	Pin	Pin assignment
	1	GND (output to supply of the digital inputs/outputs [not galvanically isolated])
	2	VCC (output to the supply of the digital inputs/outputs [not galvanically isolated])
	3	DO Common / Output Common
	4	DO 0 / Output 00
	5	DO 1 / Output 01
	6	DO 2 / Output 02
	7	DO 3 / Output 03
	8	DI 0 / Input 00
	9	DI Common / Input Common
	10	DI 1 / Input 01
	11	DI 2 / Input 02
	12	DI 3 / Input 03

Note**Requirement for external power sources**

When the DI/DQ interface is supplied with power by an external power source, this source must meet the requirements for LPS (Limited Power Sources) and NEC Class 2.

Color scheme of the DI/DQ standard cable with M12 connector

The following figure shows the color scheme of the DI/DQ standard cable from Siemens (6GT2891-0CH50). You can use the color scheme to assign the wire colors to the pins.

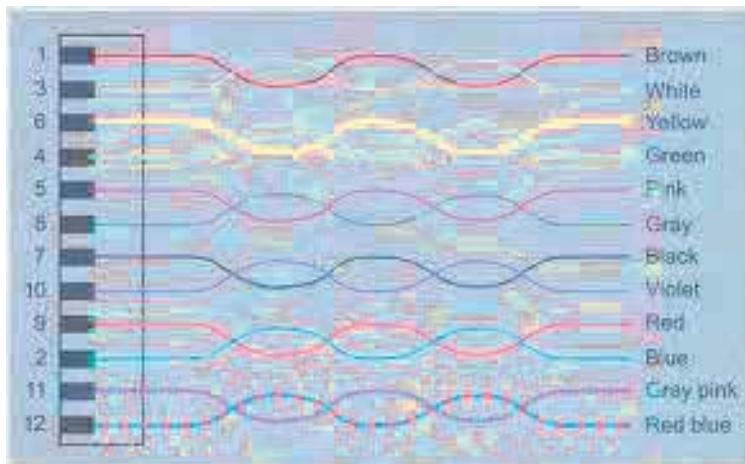

Figure 5-33 Wiring diagram: M12 connector

5.6.1.4 Switching scheme for the DI/DQ interface**Connection possibilities**

You can connect the reader in different ways. In general, the outputs and inputs should be connected as follows:

Output (DO 0 ... 3)

- Each output is rated for 0.5 A current and is electronically protected.
- 4 digital outputs can be operated simultaneously each with up to 0.5 A (up to 1 A in total). With a total current > 1 A, you need to use an external power supply.
- The outputs are optically isolated through optocouplers.

input (DI 0 ... 3)

- The inputs are optically isolated through optocouplers.
- Level
 - Low: 0 ... 7 V
 - High: 15 ... 24 V

The following diagrams illustrate various connection possibilities.

Note

Minimum time between changes

Note that changes on the DI/DQ interface that are not applied for at least 1.5 seconds are not detected by the reader.

Voltage infeed from internal source (no electrical isolation)

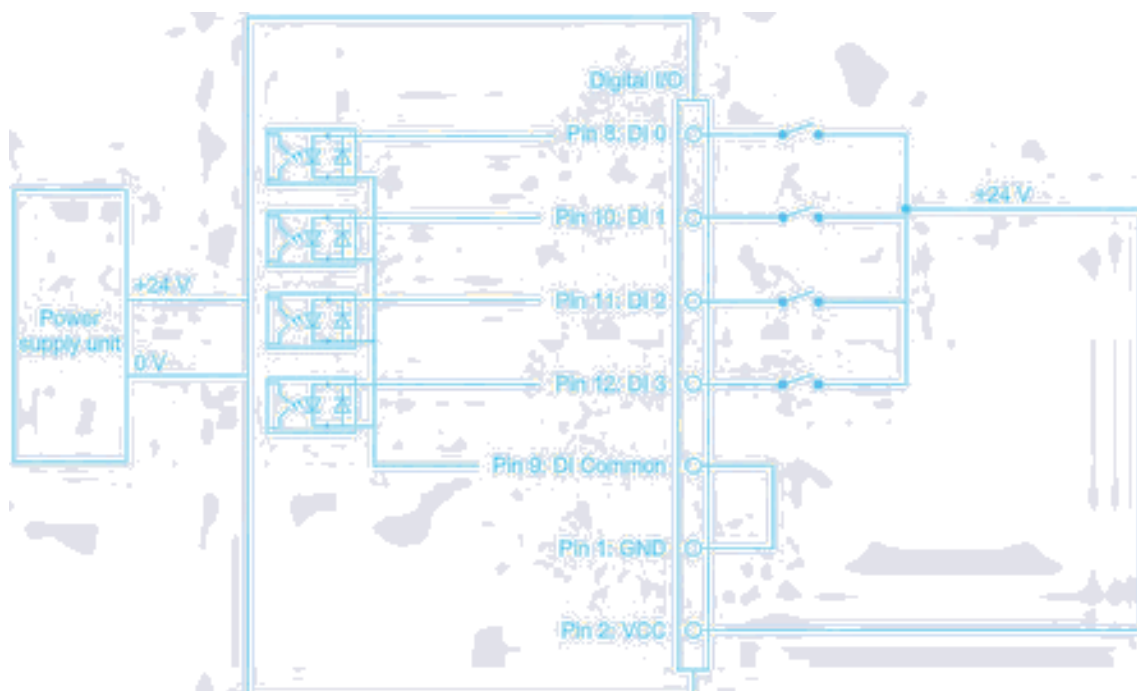

Figure 5-34 Circuit example 1: Digital inputs

Alternative connection possibilities:

- Pin 2 (VCC) to Pin 9 DI Common
- Pin 1 GND to busbar inputs

Voltage infeed from external source

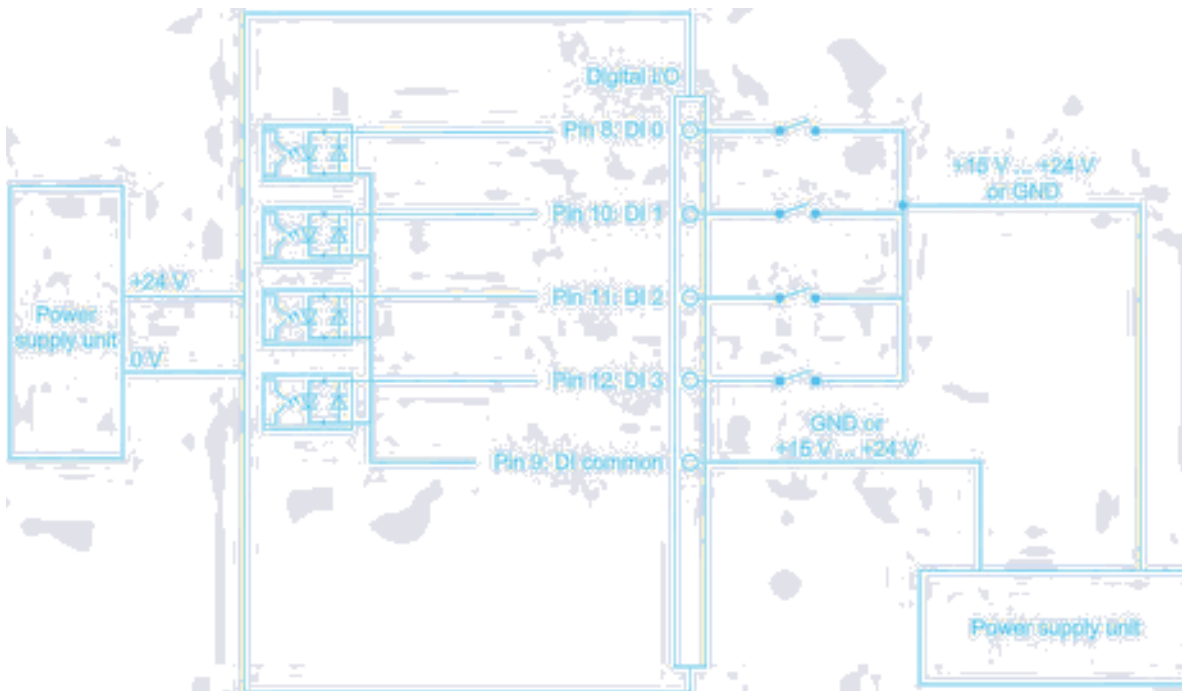

Figure 5-35 Circuit example 2: Digital inputs

Voltage infeed from external source with various voltages

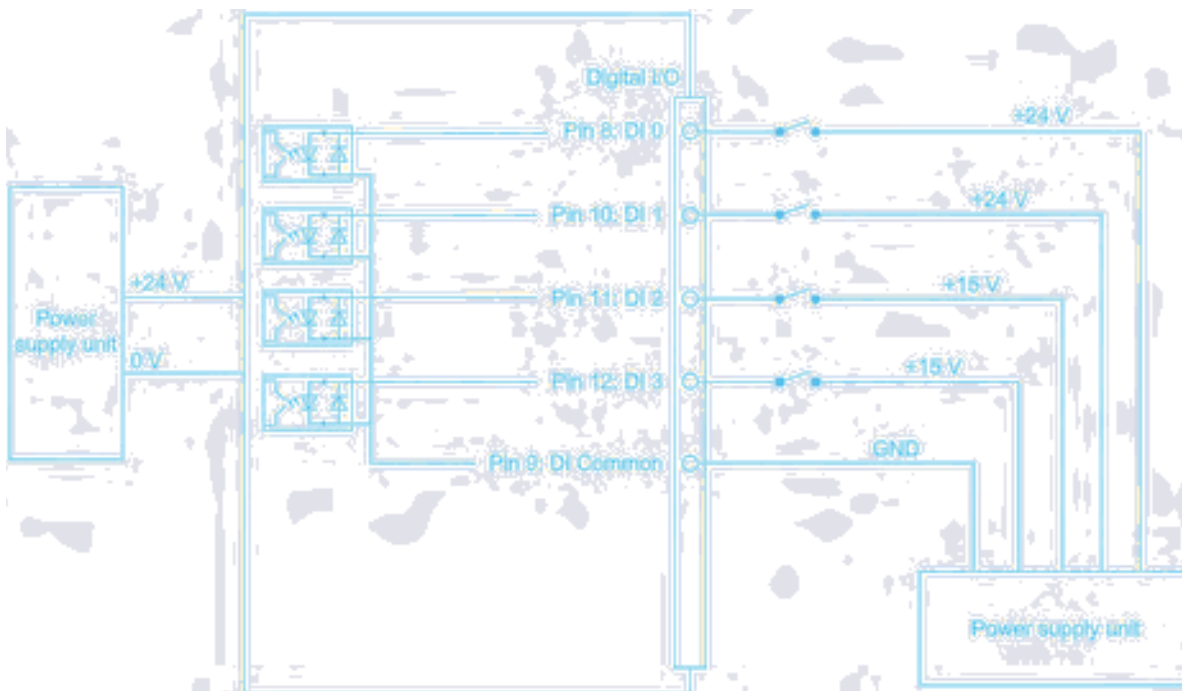

Figure 5-36 Circuit example 3: Digital inputs

Voltage infeed from internal source

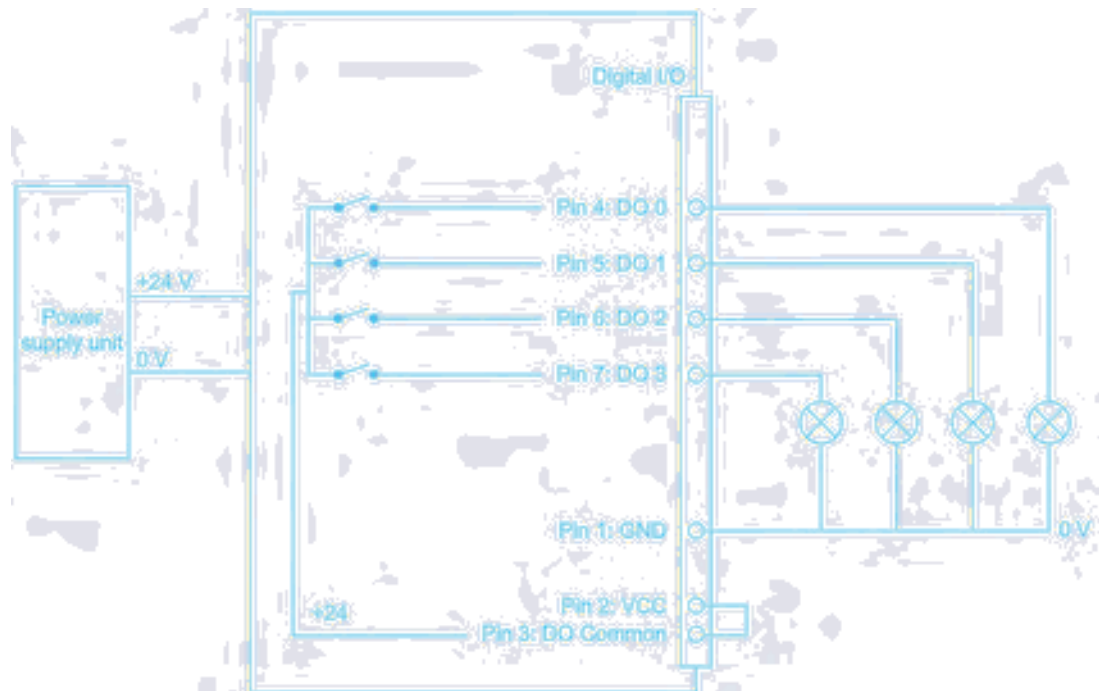

Figure 5-37 Circuit example 4: Digital outputs

Alternative connection possibilities:

- Pin 1 GND to Pin 3 DO Common
- Pin 2 (VCC) to busbar outputs

Voltage infeed from external source

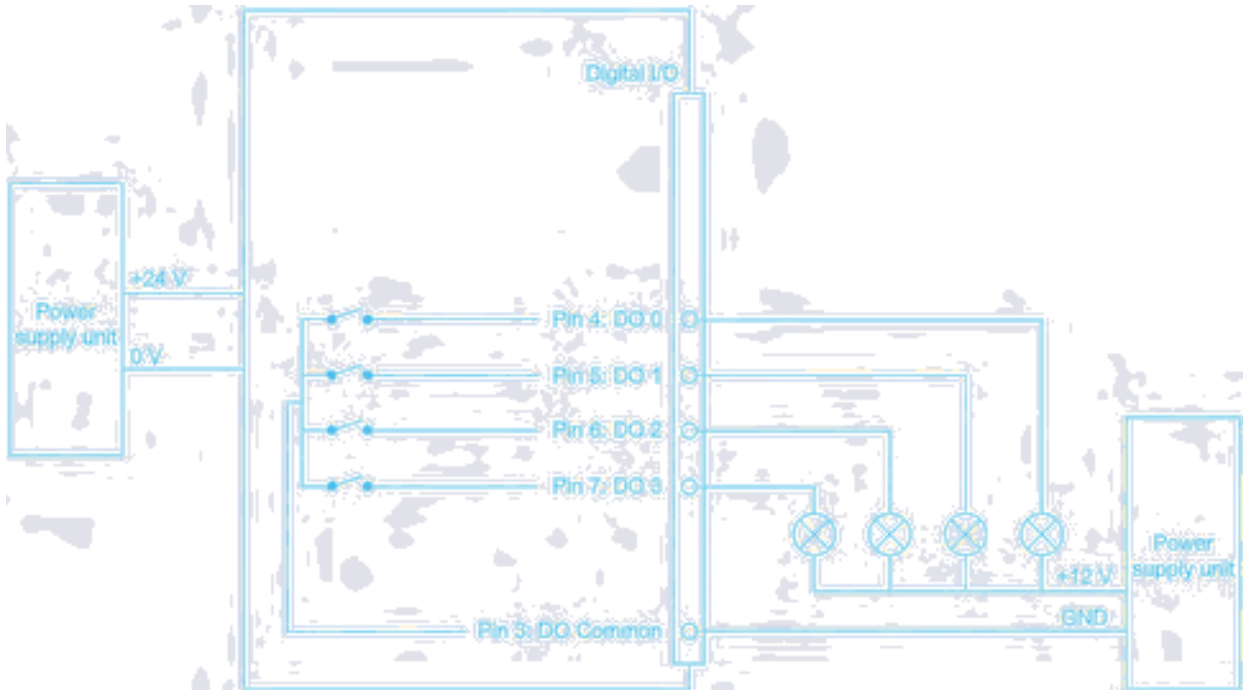

Figure 5-38 Circuit example 5: Digital outputs

Voltage infeed from an external source is shown here for 12 V as an example. Other voltages are also permissible.

Voltage infeed from external source with various voltages

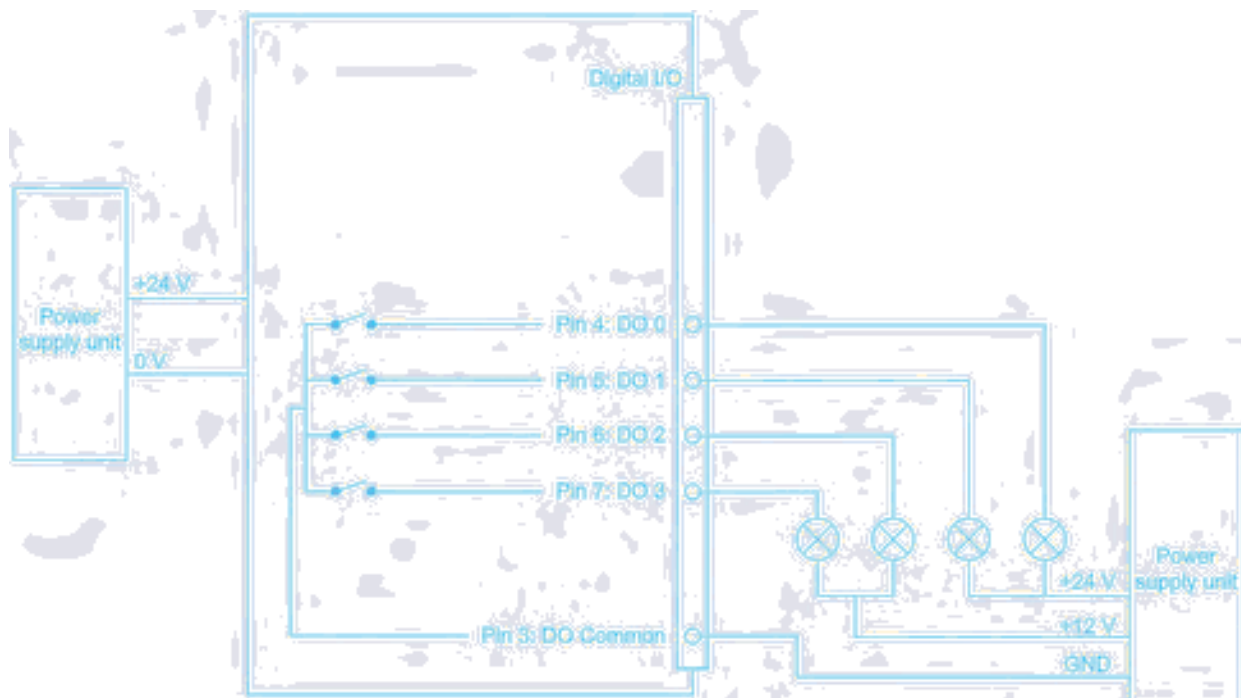

Figure 5-39 Circuit example 6: Digital outputs

5.6.1.5 Pin assignment of the power supply interface (X80 24VDC)

Table 5- 48 Pin assignment of the RS422 interface (reader end)

View of interface (M12 socket, 8-pin)	Pin	Wire colors	Assignment
	1	White	+ 24 V
	2 ¹⁾	Brown	- Tx
	3	Green	0 V
	4 ¹⁾	Yellow	+ Tx
	5 ¹⁾	Gray	+ Rx
	6 ¹⁾	Pink	- Rx
	7	--	Unassigned
	8	--	Earth (shield)

¹⁾ These pins are not required if the reader is operated via Ethernet.

Note

Requirement for external power sources

The reader must only be supplied with power by power supply units that meet the requirements of LPS (Limited Power Source) and NEC Class 2.

Requirement for external power sources

The reader must only be supplied with power by power supply units that meet the requirements of limited power source (LPS) and NEC Class 2.

Spécification des sources de tension externes

L'alimentation du plot de lecture/écriture doit être exclusivement assurée par des blocs d'alimentation conformes aux spécifications des sources à puissance limitée (Limited Power Sources LPS) et de NEC class 2.

Notes on connectors and cables

The cables with open cable ends (6GT2891-4EH20, 6GT2891-4EH50) have an 8-pin M12 plug at one end, while the other end of the cable is "open". There are 8 color-coded single wires there for connecting to external devices.

The product range includes additional cables of the type 6GT2891-4Fxxx (2 to 50 m) with an M12 connector at both ends. These cables can be used as extension cables. Long cables can be shortened if necessary.

NOTICE
Insulate unused single wires
Unused single wires must be insulated individually to prevent unwanted connections of signal lines.

NOTICE
For long cables: Adapt the power supply and transmission speed
Note that even with long cables, the supply voltage of 24 VDC must always be guaranteed. Note also that the transmission speed on the serial interface must, if necessary, be reduced.
SIMATIC standard cables (e.g. 6GT2891-4FN10) have a loop resistance of 160 mOhm / meter. This results in a voltage drop of 0.8 volts on the 24 V cable for every 10 meters of connecting cable and with a power requirement of 500 mA. If the power requirement increases through the use of the digital inputs/outputs, the voltage drop increases accordingly.

5.6.1.6 Pin assignment of the Industrial Ethernet interface (X1 P1; X1 P2)

Table 5- 49 Pin assignment of the Industrial Ethernet interface (reader end)

View of interface (M12 socket, 4-pin)	Pin	Pin assignment
	1	Data line +Tx
	2	Data line +Rx
	3	Data line -Tx
	4	Data line -Rx

5.6.1.7 Grounding connection

On the top of the reader there is a blind drill hole (M4 x 8) for grounding. Tighten the screw with a torque of ≈ 1.5 Nm.

<p> WARNING</p> <p>Hazardous voltage due to lightning strikes</p> <p>Death or serious injury may occur as a result of lightning strikes to antennas mounted outside buildings.</p> <p>If the reader is operated with antennas mounted outside buildings, it is imperative that the reader is electrically connected to the ground potential.</p>
<p>NOTICE</p> <p>Installation only in protected areas</p> <p>The antenna can be installed in the protected part of a building. When implementing your lightning protection concept, make sure you adhere to the VDE 0182 or IEC 62305 standards.</p>

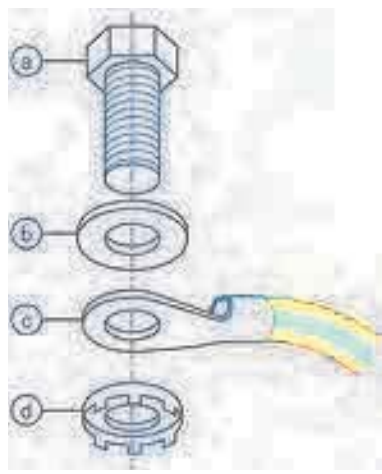
Ground connection	
	(a) Screw (M4 x 8)
	(b) Flat washer
	(c) Cable lug
	(d) Contact washer

5.6.2 Planning operation

5.6.2.1 Internal antenna

Minimum mounting clearances of two readers

RF685R has an adjustable internal antenna (linear horizontal or linear vertical). This means that you can set the antenna polarization to be either horizontal, vertical or circular. With the internal antenna active and at 2000 mW ERP radiated power, due to the aperture angle of the antennas, their fields can overlap considerably. This means it is no longer possible to be sure in which of the antenna fields the data of a transponder will be accessed.

To avoid these cases, always observe the recommended minimum distances between two readers as described in the section "Reciprocal influence of read points (Page 47)".

Dense Reader Mode (DRM)

The readers can also interfere with each other (secondary fields), if the channels (Reader TX, Transponder TX) overlap. In order to prevent a transponder channel overlapping with a reader channel, we recommend that the Dense Reader Mode (DRM) is used.

Note

Protective cap

If you only use the internal antenna of the reader, we recommend that you close the external, unused antenna connector on the reader using a protective cap.

Antenna diagram for RF685R (ETSI)

The following radiation diagrams show the directional characteristics of the internal antenna of the RF685R (ETSI) reader. For the spatial presentation of the directional characteristics, the horizontal plane (azimuth section) as well as the vertical plane (elevation section) must be considered. This results in a spatial image of the directional radiation pattern of the antenna.

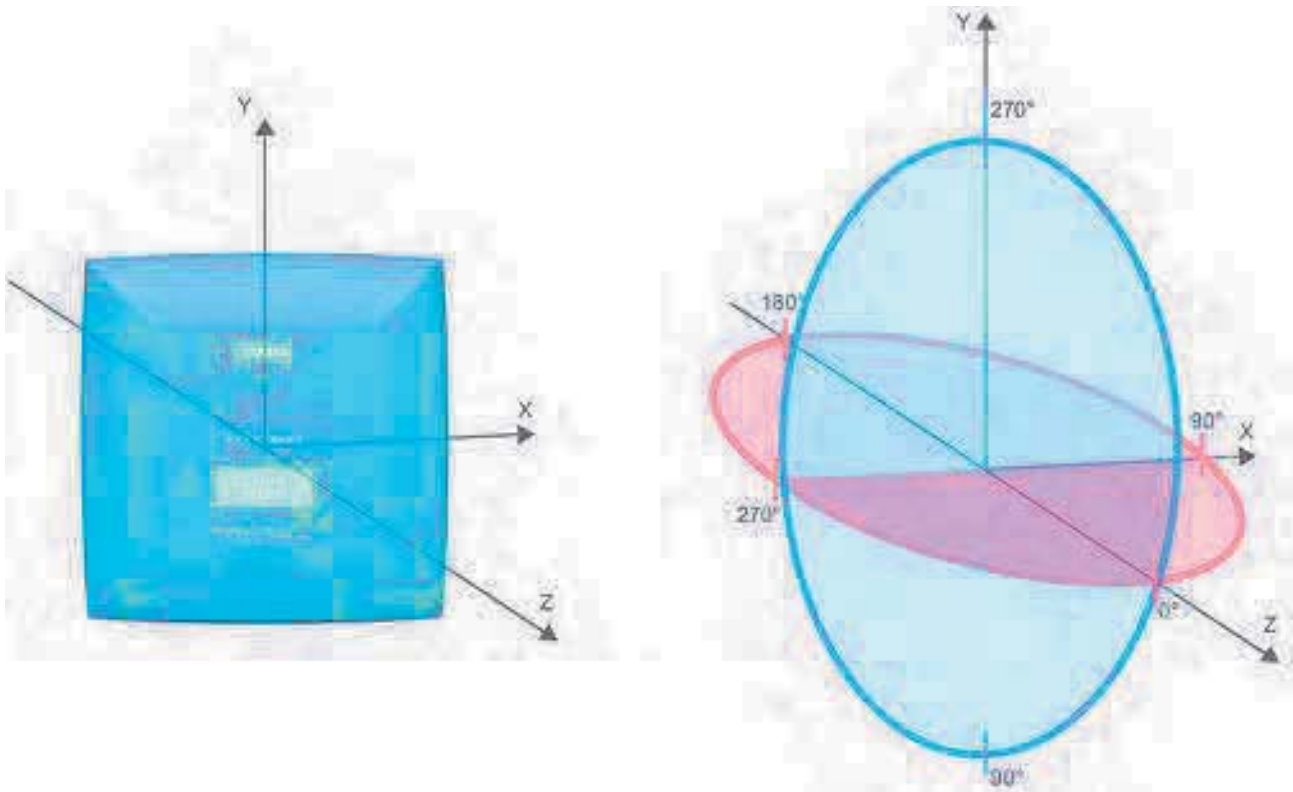

Figure 5-40 Reference system

Radiation diagram (Azimuth section)

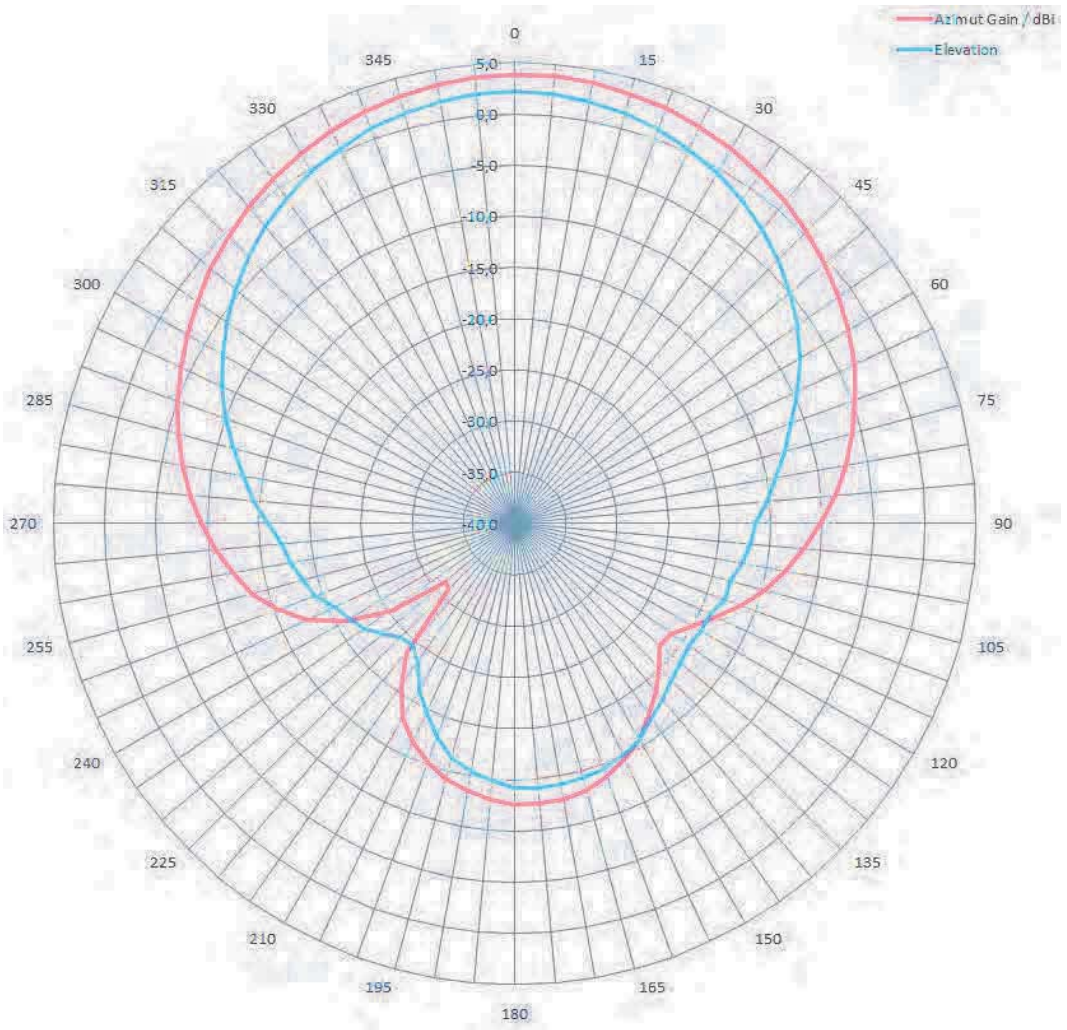

Figure 5-41 Azimuth section

Radiation diagram (elevation section)

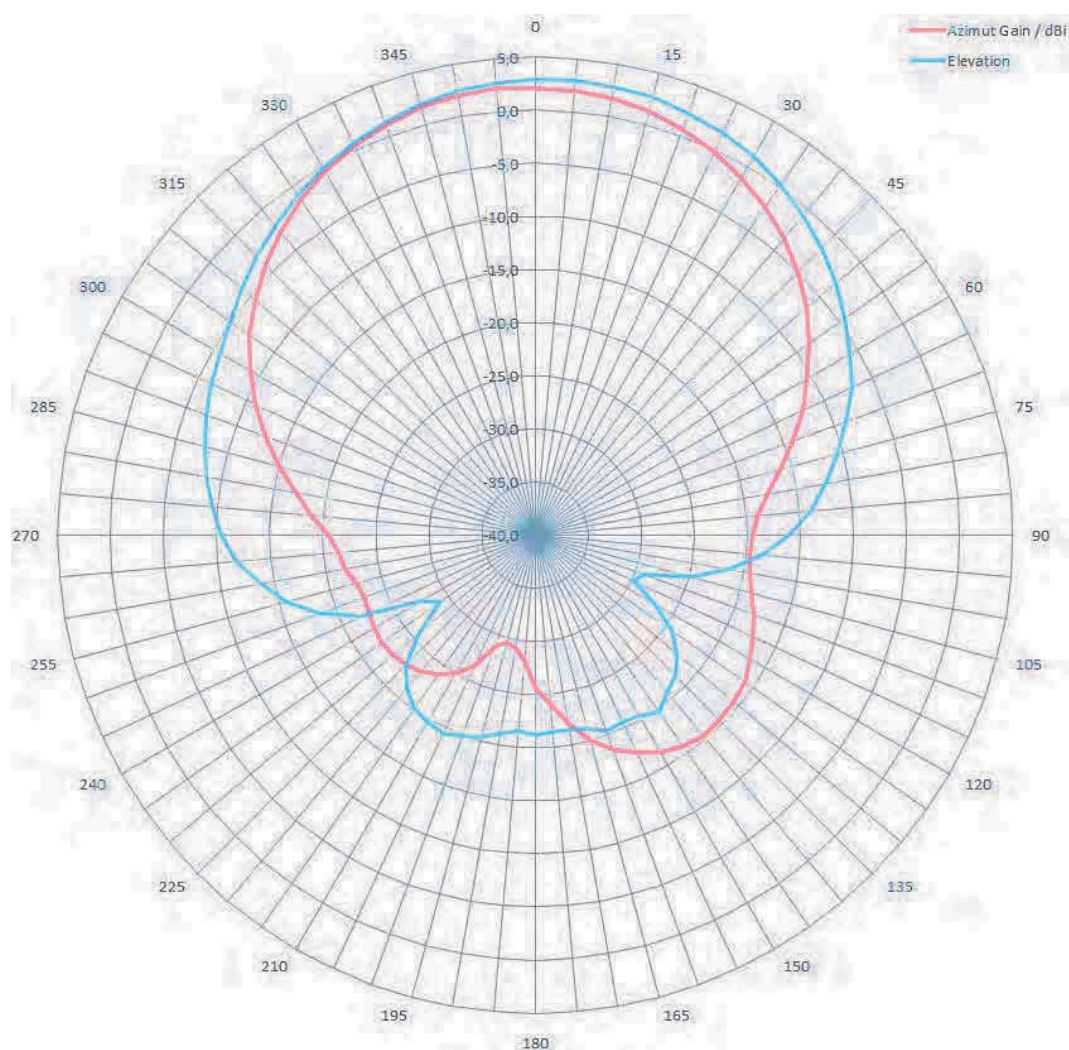

Figure 5-42 Elevation section

Radiation diagram circular

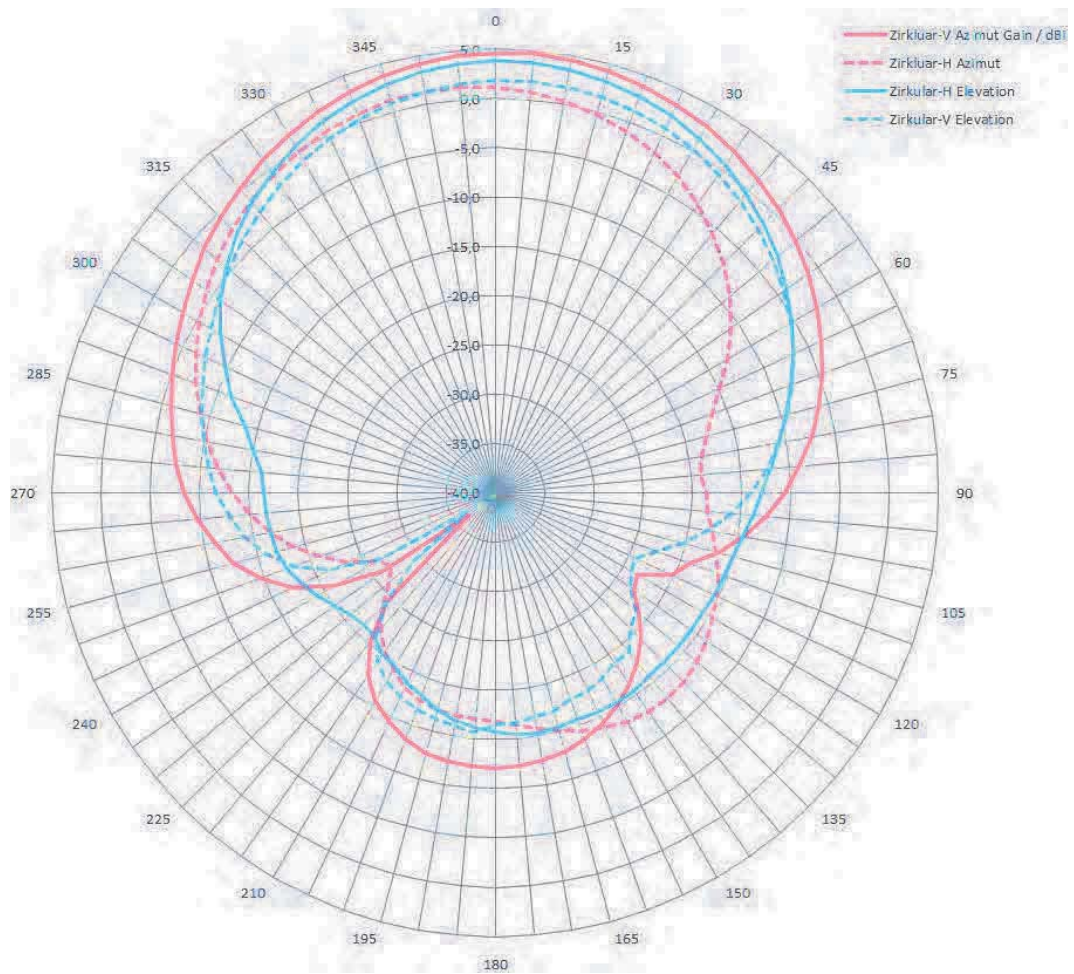

Figure 5-43 Circular section

Overview of the antenna parameters

Table 5- 50 Maximum linear electrical aperture angle at 865 MHz:

	Polarization		Circular polariza- tion
	Linear vertical	Linear horizontal	
Azimuth section	64°	61°	65°
Elevation section	64°	66°	63°
Typical antenna gain in the frequency band 865 to 868 MHz	5 dBi	3 dBi	5 dBi
Antenna axis ratio	--	--	2 dB

You will find more information on the antennas in the section "Guidelines for selecting RFID UHF antennas (Page 51)".

Antenna diagram for RF685R (FCC)

The following radiation diagrams show the directional characteristics of the internal antenna of the RF685R (FCC) reader. For the spatial presentation of the directional characteristics, the horizontal plane (azimuth section) as well as the vertical plane (elevation section) must be considered. This results in a spatial image of the directional radiation pattern of the antenna.

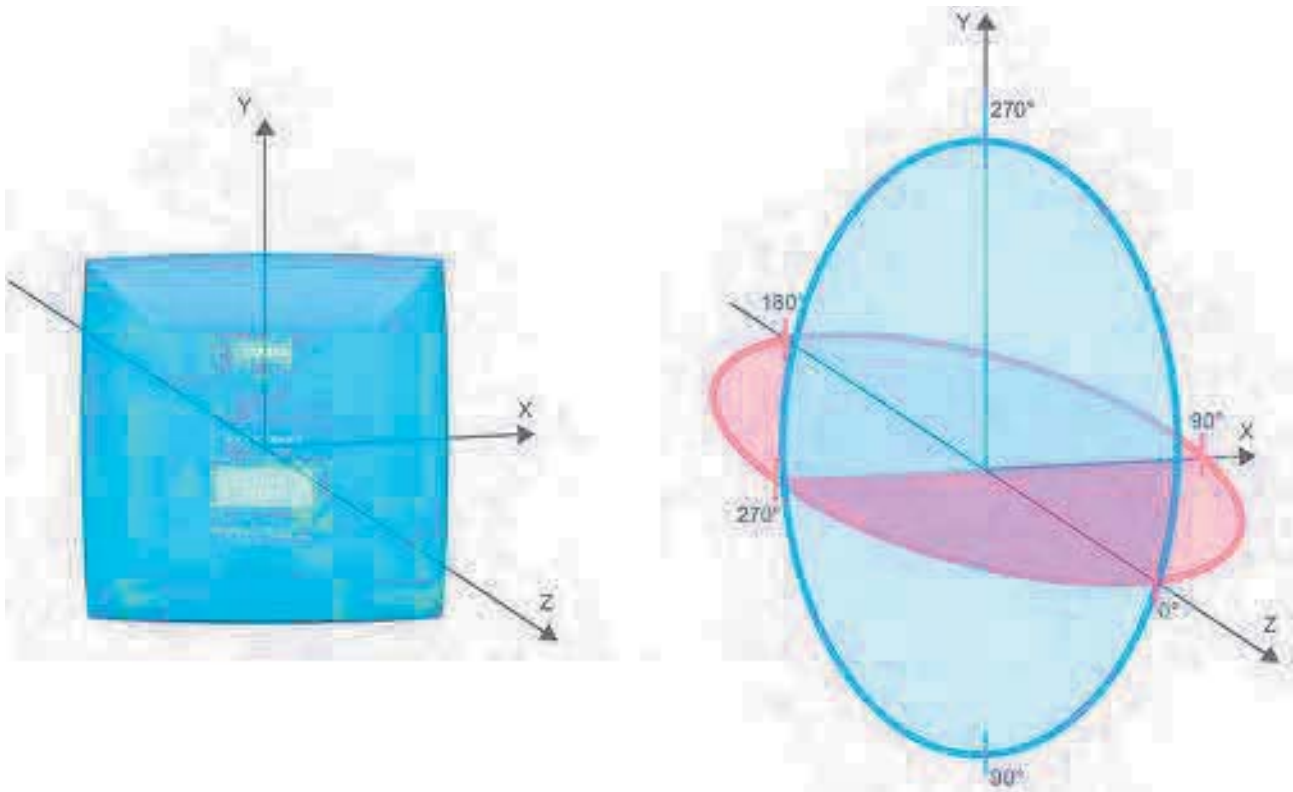

Figure 5-44 Reference system

Radiation diagram (Azimuth section)

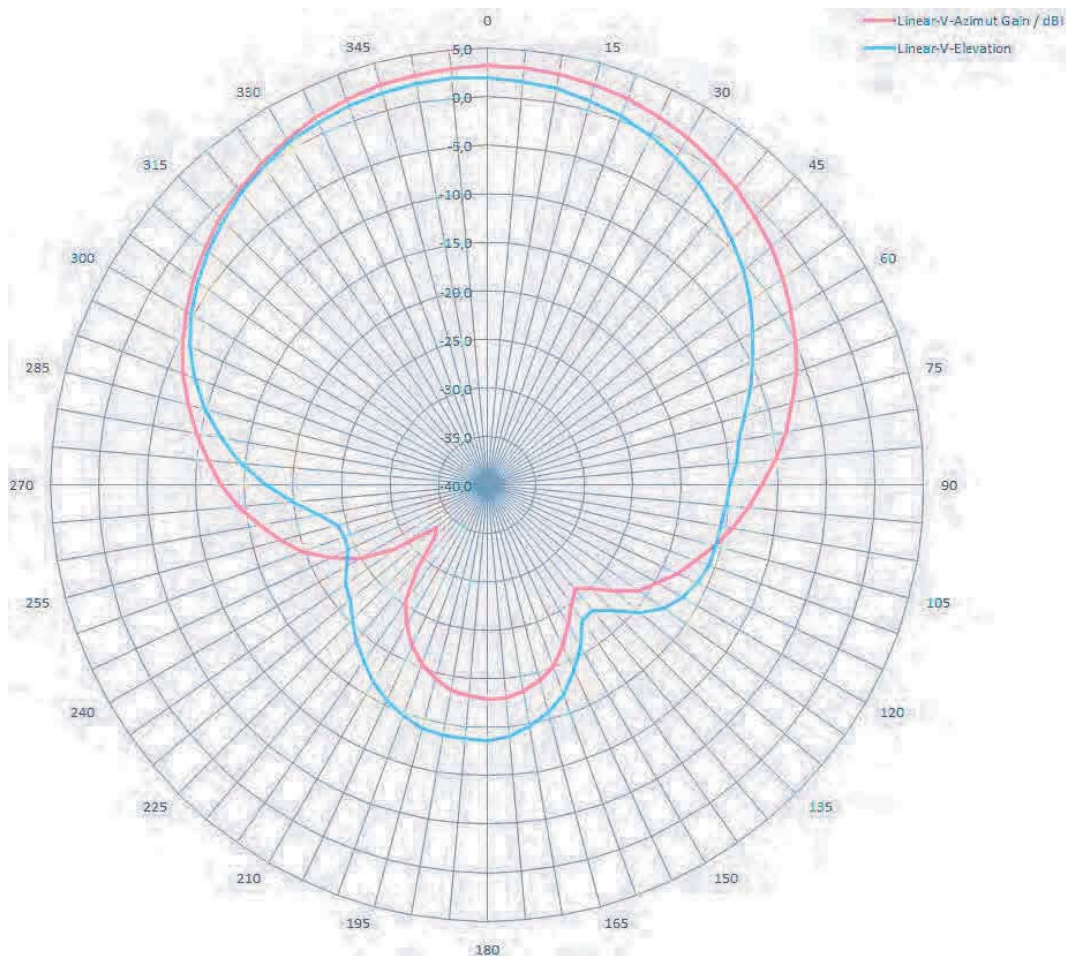

Figure 5-45 Azimuth section

Radiation diagram (elevation section)

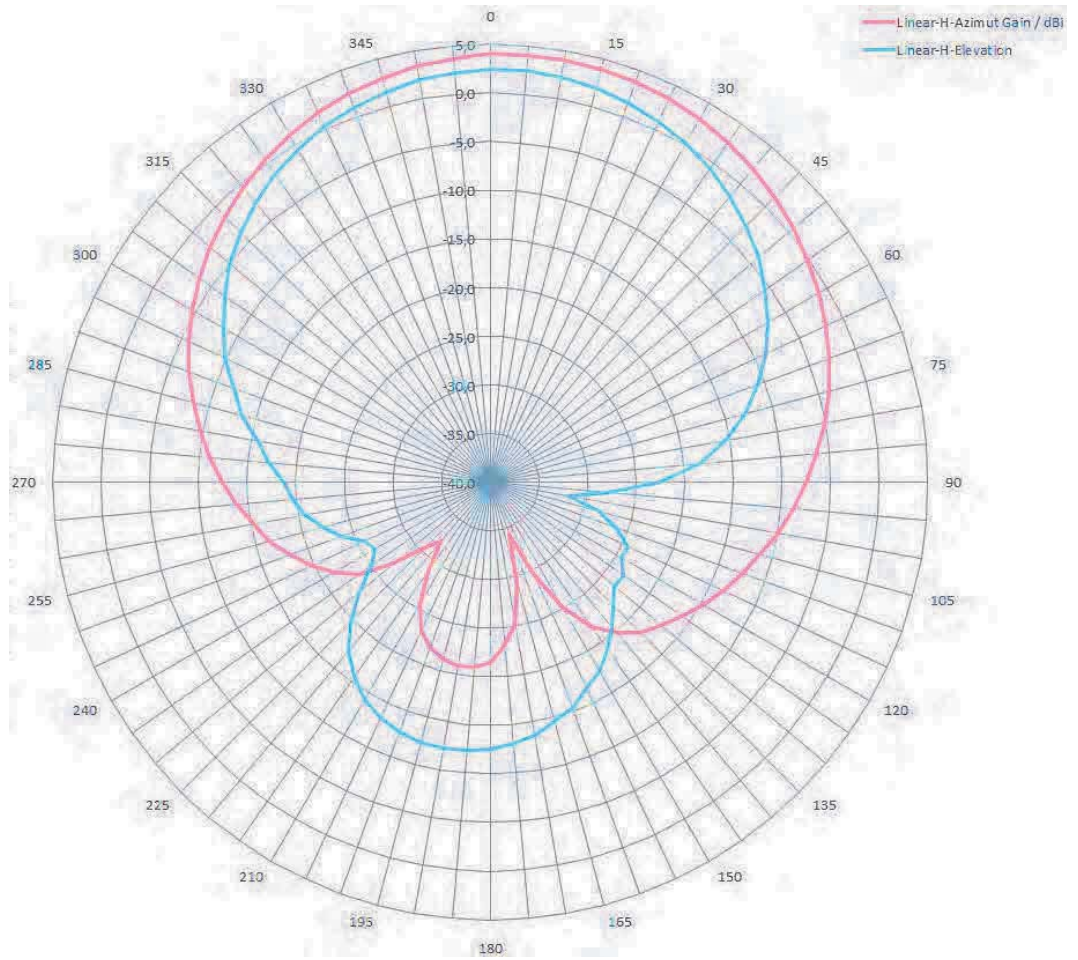

Figure 5-46 Elevation section

Radiation diagram (circular)

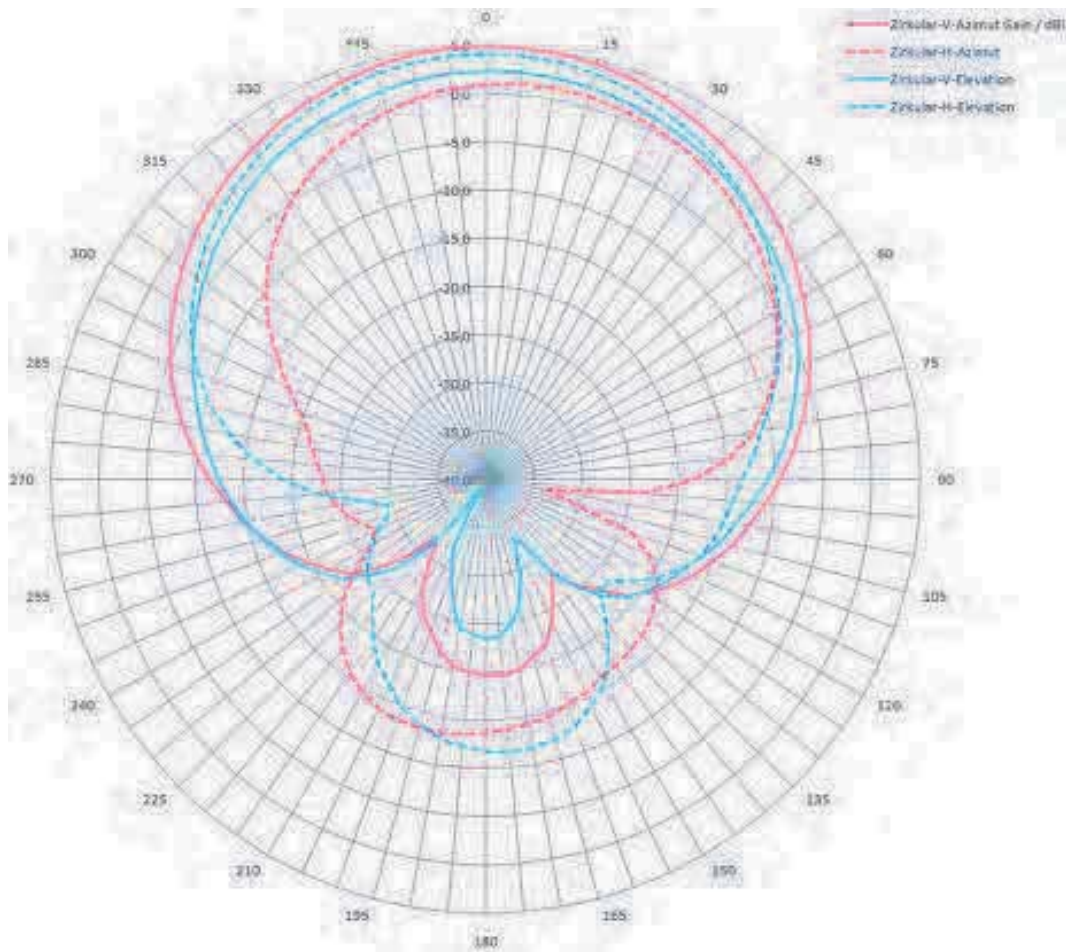

Figure 5-47 Circular section

Overview of the antenna parameters

Table 5- 51 Maximum linear electrical aperture angle at 915 MHz:

	Polarization		Circular polarization
	Linear vertical	Linear horizontal	
Azimuth section	74°	64°	73°
Elevation section	70°	78°	68°
Typical antenna gain in the frequency band 902 to 928 MHz	5 dBi	3 dBi	5 dBi
Antenna axis ratio	--	--	2 dB

You will find more information on the antennas in the section "Guidelines for selecting RFID UHF antennas (Page 51)".

Interpretation of radiation patterns

The following overview table will help you with the interpretation of radiation patterns.

The table shows which dBi values correspond to which read/write ranges (in %): You can read the radiated power depending on the reference angle from the radiation patterns, and thus obtain information on the read/write range with this reference angle with regard to a transponder.

The dBr values correspond to the difference between the maximum dBi value and a second dBi value.

Table 5- 52 Range of antenna depending on antenna gain

Deviation from maximum antenna gain [dBr]	Read/write range [%]
0	100
-3	70
-6	50
-9	35
-12	25
-15	18
-18	13

Example

As can be seen in the section Antenna diagram for RF685R (ETSI) (Page 207), the maximum antenna gain 0 dB is standardized. In the Azimuth diagram, the antenna gain falls by 3°dB at approximately $\pm 39^\circ$. This means that the dBr value is -3. The antenna range is only 70 % of the maximum range at $\pm 39^\circ$ from the Z axis within the horizontal plane.

5.6.2.2 External antenna

Preassembled standard cables in lengths of 1 m, 3 m, 5 m, 10 m, 15 m, 20 m and 40 m are available to connect the antenna.

The read range is limited by the cable loss. The maximum range can be achieved with the cable 6GT2815-0BH10 (length 1 m) since this has the lowest cable loss.

Examples of possible antenna reading point configurations

- A data source with an external antenna for a reading point.
- As an alternative, a data source with an internal antenna for a reading point.

5.6.3 Installation/mounting

Requirement

NOTICE**Close unused connectors**

Note that the readers only have the specified degree of protection when all connectors are in use or when unused connectors are closed with the protective caps.

Close any connectors on the reader that you are not using with protective caps. You can order the protective cap set using the article number specified in the section "Ordering data".

**CAUTION****Emitted radiation**

The transmitter complies with the requirements of Health Canada and the FCC limit values for subjecting persons to HF radiation, provided that a minimum spacing of 26 cm exists between antenna and person. When the antennas are installed, you must therefore ensure that a minimum spacing of 26 cm is maintained between personnel and antennas.

Mounting/installing the device

You can mount the reader in the following ways:

- Using a standardized VESA 100 mounting system and the Antenna Mounting Kit (refer to the section AUTOHOTSPOT).



Tighten the M4 screws on the rear of the reader using a torque of ≤ 1.5 Nm.

- DIN rail T35 (S7-1200)
- S7-300 standard rail
- S7-1500 standard rail
- directly on a flat surface using the VESA 100 mounting system (torque ≈ 1.5 Nm).

The positions of the mounting holes for the device are shown in the section Dimension drawing (Page 224).

Mounting the reader on a DIN/standard rail

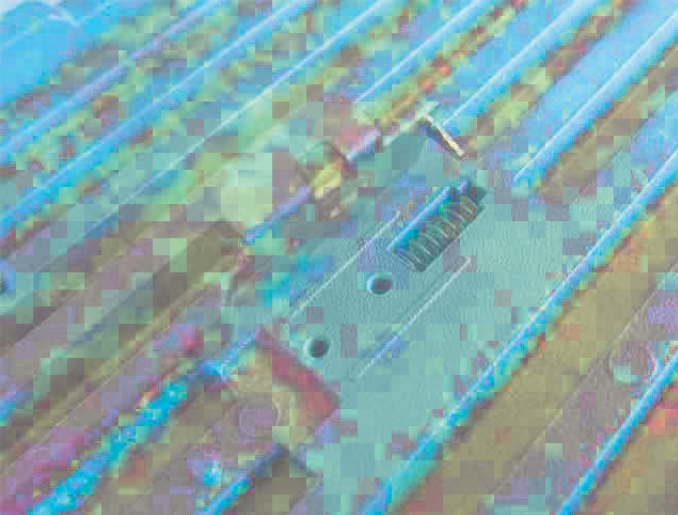
Table 5- 53 DIN rail mounting

	Description
	1. Place the spring in the groove.
	2. Mount the holder using the supplied Torx screws. When mounting the holder, make sure that the angled tip is positioned above the spring in the groove.

	Description
	<p>3. Fit the lower part of the locking mechanism of the reader into the DIN rail.</p> <p>To be able to mount the reader on or remove it from the DIN rail, pull down the holder mounted in step 2.</p>

Table 5- 54 Installation on a standard rail

	Description
	<ol style="list-style-type: none"> <li data-bbox="887 398 1469 454">1. Mount the two adapter pieces using the supplied Torx screws.
	<ol style="list-style-type: none"> <li data-bbox="887 963 1469 1019">2. Fit the upper part of the locking mechanism of the reader into the standard rail. <li data-bbox="887 1025 1469 1081">3. Secure the reader using the supplied slotted-head screws.

5.6.4 Configuration/integration

An Ethernet interface is available for integrating the device into system environments/networks. The RF685R can be configured via the Ethernet interface and with direct connection to the PC. You can configure and program the reader using the following tools:

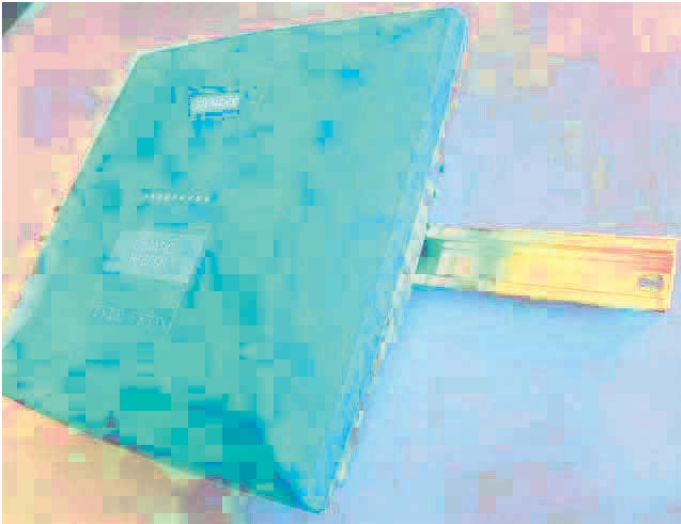
- STEP 7 Basic/Professional (TIA Portal)
- or via EtherNet/IP
- Web Based Management (WBM)
- OPC UA or XML based user applications

Note that configuration in parallel is not possible using different tools. Simple process controls (e.g. a traffic signal) can be implemented directly using the reader via four digital inputs/outputs.

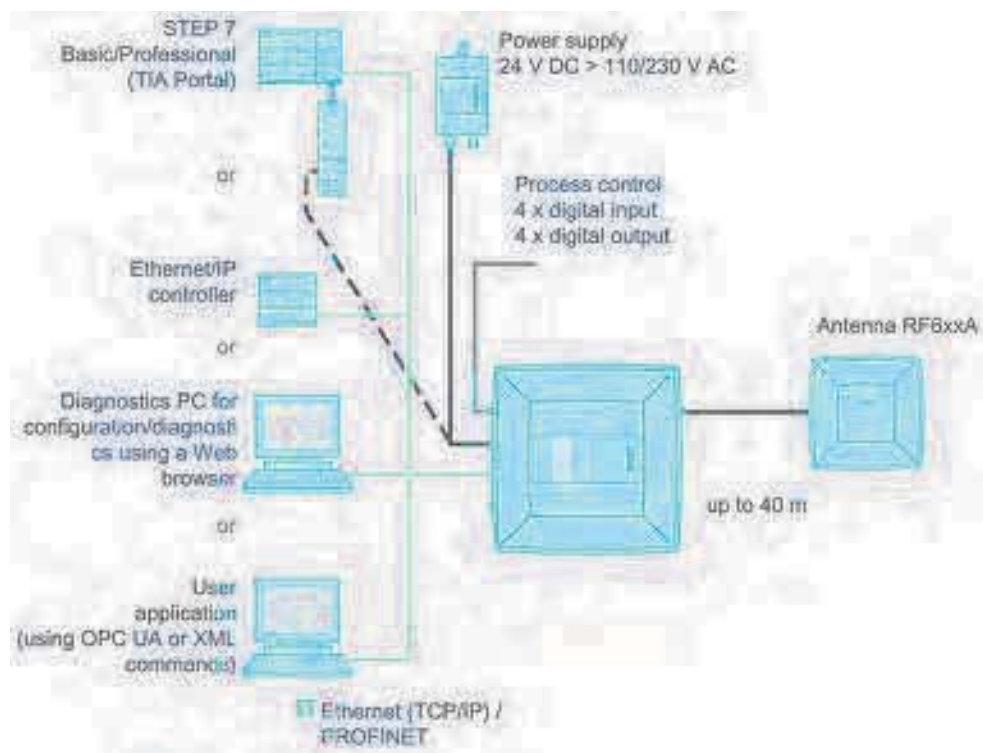

Figure 5-48 Overview: Configuration of RF685R readers

5.6.5 Technical specifications

Table 5- 55 Technical specifications of the RF685R reader

6GT2811-6CA10-xAA0	
Product type designation	SIMATIC RF685R
Radio frequencies	
Operating frequency	
• ETSI	• 865 to 868 MHz
• FCC	• 902 to 928 MHz
• CMIIT	• 920 to 925 MHz
• ARIB (STD-T106)	• 916.8 MHz to 920.4 MHz
Transmit power ¹⁾	
• ETSI	• 3 to 2000 mW
• FCC	• 3 to 2000 mW
• CMIIT	• 3 to 2000 mW
• ARIB (STD-T106)	• 3 to 1000 mW
Maximum radiated power per antenna	
• ETSI	• 2000 mW ERP
• FCC	• 4000 mW EIRP
• CMIIT	• 2000 mW ERP
• ARIB (STD-T106)	• 4000 mW EIRP
Electrical data	
Range (internal antenna)	
• ETSI	• ≤ 8 m
• FCC	• ≤ 8 m
• CMIIT	• ≤ 8 m
• ARIB (STD-T106)	• ≤ 8 m
Protocol	ISO 18000-62/-63
Transmission speed	≤ 300 kbps
Frequency accuracy	≤ ±10 ppm

6GT2811-6CA10-xAA0	
Channel spacing	
• ETSI	• 600 kHz
• FCC	• 500 kHz
• CMIIT	• 250 kHz
• ARIB (STD-T106)	• 1200 kHz
Modulation methods	ASK: DSB modulation & PR-ASK modulation encoding, Manchester or Pulse Interval (PIE)
Multitag capability	Yes
Typical transmission time per byte	
• Write access	• 2 ms
• Read access	• 0.15 ms
Supply voltage	24 V DC (20 ... 30 V DC) ²⁾
Maximum permitted current consumption	2 A
Maximum permitted current consumption via DI/DQ interface	1 A ³⁾
Current consumption (on standby), typical	
• 20 V input voltage on the reader	• 220 mA / 4.4 W
• 24 V input voltage on the reader	• 190 mA / 4.5 W
• 30 V input voltage on the reader	• 150 mA / 4.5 W
Current consumption (at 1000 mW transmit power), typical	
• 20 V input voltage on the reader	• 450 mA / 9.0 W
• 24 V input voltage on the reader	• 380 mA / 9.1 W
• 30 V input voltage on the reader	• 300 mA / 9.6 W
Current consumption (at 2000 mW transmit power), typical	
• 20 V input voltage on the reader	• 610 mA / 12.2 W
• 24 V input voltage on the reader	• 500 mA / 12.0 W
• 30 V input voltage on the reader	• 410 mA / 12.3 W
Interfaces	
Antenna connectors	1x RP-TNC
Power supply	1x M12 (8-pin)
DI/DQ interface	1x M12 (12-pin)
Digital inputs	4
Digital outputs	4
Ethernet interface	2x M12 (4-pin), 100 Mbps

6GT2811-6CA10-xAA0

Mechanical specifications

Material

- | | |
|-------------------------|-------------------------|
| • Upper part of housing | • Pocan (silicone-free) |
| • Lower part of housing | • Aluminum |

Color

- | | |
|-------------------------|-----------|
| • Upper part of housing | • TI-Grey |
| • Lower part of housing | • Silver |

Permitted ambient conditions

Ambient temperature

- | | |
|-------------------------------------|------------------|
| • During operation | • -25 ... +55 °C |
| • During transportation and storage | • -40 ... +85 °C |

Degree of protection

IP65

Shock resistant to EN 60068-2-27

25.5 g ⁴⁾

Vibrations according to EN 60068-2-6

3.1 g ⁴⁾**Design, dimensions and weight**

Dimensions (W × H × D)

258 × 258 × 80 mm

Weight

2.47 kg

Type of mounting

- | | |
|-----------------|---------------------------|
| • Mounting rail | • Hanging |
| • VESA 100 | • 4x M4 screws (≈ 1.5 Nm) |

Operation indicator

8 LEDs

Status display

9 LEDs

6GT2811-6CA10-xAA0

Standards, specifications, approvals

Proof of suitability	EN 301 489-1 V1.9.2 / EN 301 489-3 V1.6.1 / EN 302 208-1/-3 V1.4.1 FCC CFR 47, Part 15 section 15.247
MTBF	29 years

- 1) Measured at the output of the antenna socket.
- 2) All supply and signal voltages must be safety extra low voltage (SELV/PELV according to EN 60950). The voltage sources must meet the requirements of limited power sources (LPS) and NEC Class 2.

Note that, depending on the power consumption, using extension cables > 20 m (6GT2891-4FN50) may lead to a voltage drop on the reader. This voltage drop can mean that the necessary minimum voltage on the reader is below the required 20 V.

- 3) Keep to the switching schemes of the DI/DQ interface.
- 4) The values for shock and vibration are maximum values and must not be applied continuously. These values only apply to mounting using screws.

5.6.6 Dimension drawing

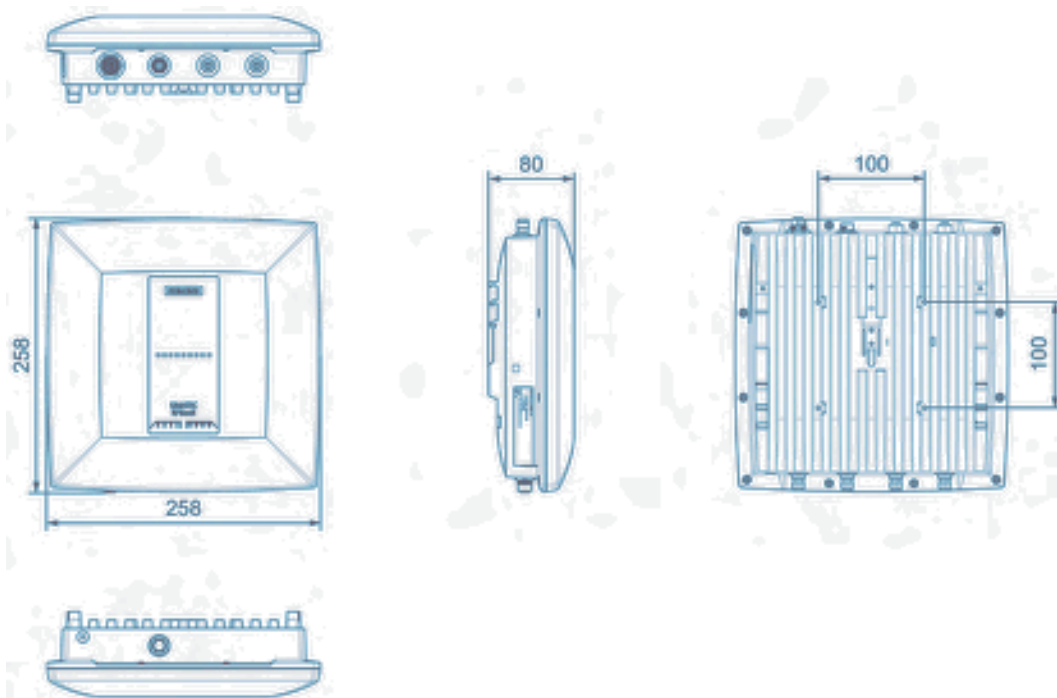

Figure 5-49 Dimension drawing RF685R

All dimensions in mm (± 0.5 mm tolerance)

5.6.7 Certificates and approvals

Note



Marking on the readers according to specific approval

The certificates and approvals listed here apply only if the corresponding mark is found on the readers.

Table 5- 56 6GT2811-6CA10-0AA0

Labeling	Description
	Conformity with the RED directive 2014/53/EU Conformity with the RoHS directive 2011/65/EU
	South Africa radio approval: Radio Equipment Type Approval
India	India wireless approval Marking on the reader: No. NR-ETA/1589
	Radio approval for Russia, Belarus, Kazakhstan

Table 5- 57 6GT2811-6CA10-1AA0

Labeling	Description
 Federal Communications Commission	FCC CFR 47, Part 15 section 15.247 Radio Frequency Interference Statement This equipment has been tested and found to comply with the limits for a Class A digital device, pursuant to Part 15 of the FCC Rules. FCC ID: NXW-RF600R2
Industry Canada Radio Standards Specifications	RSS-210 Issue 6, Section 2.2, A8 IC: 267X-RF600R2, Model: RF685R
	This product is UL-certified for the USA and Canada. It meets the following safety standard(s): UL 60950-1 - Information Technology Equipment Safety - Part 1: General Requirements CSA C22.2 No. 60950 -1 - Safety of Information Technology Equipment UL Report E 115352

Labeling	Description
	<p>Brazil radio approval Marking on the reader (6GT2811-6CA10-1AA0):</p>  <p>Statement about approval: Este equipamento opera em caráter secundário, isto é, não tem direito à proteção contra interferência prejudicial, mesmo de estações do mesmo tipo e não pode causar interferência a sistemas operando em caráter primário. Reader certificate: ANATEL 2892-15-4794</p>
	<p>KCC Certification Type of equipment: A급 기기 (업무용 방송통신기자재) Class A Equipment (Industrial Broadcasting & Communication Equipment) 이 기기는 업무용(A급) 전자파적합기기로서 판 매자 또는 사용자는 이 점을 주의하시기 바라 며, 가정외의 지역에서 사용하는 것을 목적으로 합니다. This equipment is Industrial (Class A) electromagnetic wave suitability equipment and seller or user should take notice of it, and this equipment is to be used in the places except for home. Certificate of the reader: MSIP-CMM-RF5-RF685R</p>
<p>HC-141617</p>	<p>Argentina radio approval: Registro de la COMISION NACIONAL DE COMUNICACIONES</p>
<p>RCPSISI14-1926-A2</p>	<p>Mexico radio approval: CERTIFICADO DE HOMOLOGACION, IFETEL</p>
	<p>Australia radio approval: This product meets the requirements of the AS/NZS 3548 Norm.</p>

Table 5- 58 6GT2811-6CA10-2AA0

Standard	
<p>CMIIT Certification</p>	<p>China radio approval Marking on the reader: CMIIT ID: 2014DJ3989</p>

5.6.7.1 FCC information

Siemens SIMATIC RF685R (FCC): 6GT2811-6CA10-1AA0

FCC ID: NXW-RF600R2

This device complies with part 15 of the FCC rules. Operation is subject to the following two conditions:

- (1) This device may not cause harmful interference, and
- (2) this device must accept any interference received, including interference that may cause undesired operation.

Caution

Any changes or modifications not expressly approved by the party responsible for compliance could void the user's authority to operate the equipment.

Note

This equipment has been tested and found to comply with the limits for a Class B digital device, pursuant to part 15 of the FCC Rules.

These limits are designed to provide reasonable protection against harmful interference when the equipment is operated in a commercial environment. This equipment generates, uses, and can radiate radio frequency energy and, if not installed and used in accordance with the instruction manual, may cause harmful interference to radio communications. Operation of this equipment in a residential area is likely to cause harmful interference in which case the user will be required to correct the interference at his own expense.

FCC Notice

To comply with FCC part 15 rules in the United States, the system must be professionally installed to ensure compliance with the Part 15 certification.

It is the responsibility of the operator and professional installer to ensure that only certified systems are deployed in the United States. The use of the system in any other combination (such as co-located antennas transmitting the same information) is expressly forbidden.

FCC Exposure Information

To comply with FCC RF exposure compliance requirements, the antennas used for this transmitter must be installed to provide a separation distance of at least 20 cm from all persons and must not be co-located or operating in conjunction with any other antenna or transmitter.

5.6.7.2 IC-FCB information

Siemens SIMATIC RF685R (FCC): 6GT2811-6CA10-1AA0

IC: 267X-RF600R2

This device complies with Industry Canada licence-exempt RSS standard(s). Operation is subject to the following two conditions:

- (1) This device may not cause interference, and
- (2) this device must accept any interference, including interference that may cause undesired operation of the device.

Le présent appareil est conforme aux CNR d'Industrie Canada applicables aux appareils radio exempts de licence. L'exploitation est autorisée aux deux conditions suivantes :

- (1) L'appareil ne doit pas produire de brouillage, et
- (2) l'utilisateur de l'appareil doit accepter tout brouillage radioélectrique subi, même si le brouillage est susceptible d'en compromettre le fonctionnement.

Industry Canada Notice

To reduce potential radio interference to other users, the antenna type and its gain should be so chosen that the equivalent isotropically radiated power (e.i.r.p.) is not more than that permitted for successful communication.

Transmitter power and antenna information for antennas with a gain less than 6 dBi:

This device has been designed to operate with the SIMATIC RF620A antenna 902-928, the SIMATIC RF640A antenna 902-928 as well as the SIMATIC RF660A antenna 902-928 listed below, and having a maximum gain of 5,5 dBi. Arbitrary transmission power settings in combination with other antennas or antennas having a gain greater than 5,5 dBi are strictly prohibited for use with this device. The required antenna impedance is 50 Ohms.

Transmitter power and antenna information for antennas with a gain greater 6 dBi:

This device requires professional installation. Antennas with a gain greater 6 dBi may be used provided the system does not exceed the radiation power of 4000 mW E.I.R.P. This device has been designed to operate with the SIMATIC RF642A antenna 902-928 exceeding the maximum gain of 5,5 dBi under the restriction that the RF power at the input of the antenna must be set to meet the following relation: RF power (dBm) \leq 30 dBm – (antenna gain (dBi) – 6 dBi) Other antennas or system configurations for antennas having a gain greater than 6 dBi are strictly prohibited for use with this device. The required antenna impedance is 50 Ohms.

5.7 SIMATIC RF650M

5.7.1 Description

SIMATIC RF650M expands the RF600 identification system with a powerful mobile reader for applications in the areas of logistics, production and service. In addition, it is an indispensable aid for startup and testing.

5.7.2 Field of application and features

Device variants for different frequency ranges

The SIMATIC RF650M device is available in two variants:

- for the frequency range ETSI (6GT2813-0CA00)
- for the frequency range FCC (6GT2813-0CA10)

Implementation environment, field of application and features

- **Field of application**

Due to its protection class IP65 the handheld terminal SIMATIC RF650M is also suitable for use in a harsh environment. The device is extremely rugged and protected against spray water. The backlit display is easy to read even under unfavorable lighting conditions.

- **RFID system**

The device can be used to process all RF600 transponders and transponders compatible with them.

- **Radio transmission protocols**

The following radio transmission protocols are supported:

- ISO 18000-63

- **API software interface**

The SIMATIC RF650M Mobile handheld terminal is supplied with an API software interface that can be used by customized user programs.

You can perform the following functions with the SIMATIC RF650M handheld terminal:

Functions

- Reading the EPC-ID
- Writing the EPC-ID to a transponder
- Reading data from the transponder
- Writing the data to the transponder
- Reading and displaying the ID number of the transponder (identify transponder)
- Localizing transponders
- Representing and editing the data in hexadecimal and ASCII format
- Password protection for all write functions that can be enabled or disabled (Write, Lock, Kill)
- Menu guidance in English and German (switchable)
- Easy creation of your own RFID applications with the software "Application Interface" (API)

You will find further information on the RF650M handheld terminal in the operating instructions "SIMATIC RF650M mobile handheld terminal (<https://support.industry.siemens.com/cs/ww/en/view/109475735>)".

Antennas

6.1 Overview

The following table shows the most important features of the RF600 antennas at a glance:

Table 6- 1 Characteristics of the RF615A, RF620A and RF660A antennas

Characteristics	RF615A		RF620A		RF660A	
Material	PA 6, silicone-free		PA 12, silicone-free			
Frequency range	865-868 MHz	902-928 MHz	865-868 MHz	902-928 MHz	865-868 MHz	902-928 MHz
Impedance	50 ohms nominal					
Antenna gain	-13 ... -5 dBi ¹⁾		-10 ... -5 dBi ¹⁾		7 dBi	6 dBi
VSWR (standing wave ratio)	2:1 max.					
Polarization	Linear				RH circular	
Radiating/receiving angle	Depending on the mounting surface				55° - 60°	60° - 75°
Connector	RP-TNC coupling					
Mounting type	2 x M4 screws		2 x M5 screws		4x screws M4 (VESA 100 fastening system)	
Degree of protection	IP67 (IP rating is not investigated by UL)		IP67			
Permissible ambient temperature	-20 °C ... +70 °C				-25 °C ... +75 °C	

¹⁾ Lowest values apply when mounted on non-metallic surfaces; the higher values apply when mounted on metallic surfaces.

Table 6- 2 Characteristics of the RF640A and RF642A antennas

Characteristics	RF640A		RF642A	
Material	PA 12, silicone-free			
Frequency range	865-868 MHz	902-928 MHz	865-868 MHz	902-928 MHz
Impedance	50 ohms nominal			
Antenna gain	4 dBi (7 dBic)	4.3 dBi (7.3 dBic)	6 dBi	7 dBi
VSWR (standing wave ratio)	Max. 1.25	Max. 1.6	Max. 1.4	
Polarization	RH circular		Linear	
Radiating/receiving angle	Horiz. plane: 80°	Horiz. plane: 75°	Horiz. plane: 75°	Horiz. plane: 80°
	Vertic. plane: 75°	Vertic. plane: 85°	Vertic. plane: 70°	Vertic. plane: 70°
Connector	RP-TNC coupling			
Mounting type	4x screws M4 (VESA 100 fastening system)			
Degree of protection	IP65			
Permissible ambient temperature	-25 °C ... +75 °C			

Table 6- 3 Characteristics of the RF650A and RF680A antennas

Characteristics	RF650A		RF680A	
Material	Pocan DPCF2200, silicone free			
Frequency range	865-868 MHz	902-928 MHz	865-868 MHz	902-928 MHz
Impedance	50 ohms nominal			
Antenna gain	4 dBi (7 dBic)	3.5 dBi (6.5 dBic)	3.5 dBi (6.5 dBic)	3.5 dBi (6.5 dBic)
VSWR (standing wave ratio)	Max. 1.45		Max. 1.45	
Polarization	RH circular		RH circular / linear	
Radiating/receiving angle	Horiz. plane: 83°	Horiz. plane: 90°	Horiz. plane: 85°	Horiz. plane: 90°
	Vertic. plane: 70°	Vertic. plane: 76°	Vertic. plane: 80°	Vertic. plane: 77°
Connector	RP-TNC coupling			
Mounting type	4x screws M4 (VESA 100 fastening system)			
Degree of protection	IP65			
Permissible ambient temperature	-25 °C ... +75 °C			

6.2 SIMATIC RF615A

6.2.1 Characteristics

SIMATIC RF615A	Characteristics	
	Area of application	The SIMATIC RF615A is a universal UHF antenna in a compact size for industrial applications, e.g. for installation directly on the robot arm.
	Frequency range	<ul style="list-style-type: none"> • 865 to 868 MHz (RF615A ETSI) • 902 to 928 MHz (RF615A FCC)
	Read range	Max. 2 m
	Polarization	Linear
	Degree of protection	IP67 (IP rating is not investigated by UL)
	Mounting	2 x M4
	Connection	30 cm connecting cable (connected permanently to the antenna) and RP-TNC coupling An antenna cable is required for connection to the reader (e.g. 6GT2815-0BH30).

Frequency ranges

The antenna is a narrowband antenna and is available in the following two frequency range variants.

- RF615A ETSI: 865 to 868 MHz
- RF615A FCC: 902 to 928 MHz

Function

The SIMATIC RF615A is used for transmitting and receiving data in the UHF range. The antennas are connected to the SIMATIC RF600 readers via antenna cables that are available in different lengths.

6.2.2 Ordering data

Table 6- 4 RF615A ordering data

Product	Article number
SIMATIC RF615A (ETSI)	6GT2812-0EA00
SIMATIC RF615A (FCC)	6GT2812-0EA01

Table 6- 5 Ordering data accessories

Product	Article number	
Connecting cable between reader and antenna	1 m (cable loss 0.5 dB)	6GT2815-0BH10
	3 m (cable loss 1.0 dB)	6GT2815-0BH30
	5 m, suitable for drag chains (cable loss 1.5 dB)	6GT2815-2BH50
	10 m (cable loss 2.0 dB)	6GT2815-1BN10
	10 m (cable loss 4.0 dB)	6GT2815-0BN10
	15 m, suitable for drag chains (cable loss 4.0 dB)	6GT2815-2BN15
	20 m (cable loss 4.0 dB)	6GT2815-0BN20
	40 m (cable loss 5.0 dB)	6GT2815-0BN40

6.2.3 Mounting

Two holes for M4 screws are provided for mounting the antenna. The antenna is suitable for mounting on metallic and non-metallic surfaces.

Note

Maximum read/write range

The maximum read/write ranges are only reached when the antenna is mounted on a metallic surface with a minimum size of 150 x 150 mm.

Note

Antenna gain depends on the mounting surface

Note that the antenna gain depends on the material of the mounting surface. If the antenna is mounted on a metallic surface, the antenna gain is -5 dBi. If the antenna is mounted on a non-metallic surface, the antenna gain is -13 dBi.

6.2.4 Connecting the antenna

The SIMATIC RF615A antenna must be connected to the reader using an antenna cable.

Preassembled standard cables in lengths of 1 m, 3 m, 5 m, 10 m, 15 m, 20 m and 40 m are available to connect the antenna.

The range of the antenna is limited by the cable loss. The maximum range can be achieved with the cable 6GT2815-0BH10 (length 1 m), since this cable has the lowest cable loss.

Requirement

Note

Use of Siemens antenna cable

To ensure optimum functioning of the antenna, it is recommended that a Siemens antenna cable is used in accordance with the list of accessories.

Strain relief

To protect the antenna connecting cable from strain, you can attach strain relief, e.g. in the form of a strain relief clamp. The following graphic shows the optimum mounting point for attaching strain relief.

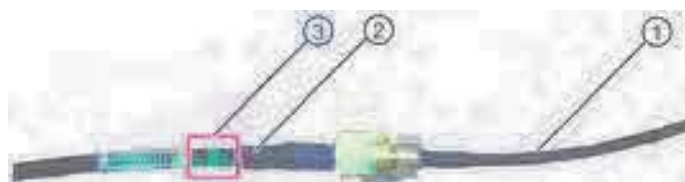

- ① RF615A antenna connecting cable
- ② RF600 antenna cable
- ③ Mounting point for strain relief

Figure 6-1 Strain relief

The following listed bending radii are minimum values, which may not be fallen below and are based on repeated bending.

Table 6- 6 Bending radii of the antenna cable

Cable designation	Article number	Length [m]	Cable loss [dB]	Bending radius [mm]
Antenna cable	6GT2815-0BH10	1	0.5	51
Antenna cable	6GT2815-0BH30	3	1	51
Antenna cable (suitable for drag chains)	6GT2815-2BH50	5	1.5	45 ^{1) 2)}
Antenna cable	6GT2815-1BN10	10	2	77
Antenna cable	6GT2815-0BN10	10	4	51

Cable designation	Article number	Length [m]	Cable loss [dB]	Bending radius [mm]
Antenna cable (suitable for drag chains)	6GT2815-2BN15	15	4	45 ^{1) 2)}
Antenna cable	6GT2815-0BN20	20	4	77
Antenna cable	6GT2815-0BN40	40	5	77

1) Permissible minimum bending radius with one-time bending. 28 mm

2) With cables capable of being used in drag chains, 100,000 bending cycles at a bending radius of 100 mm and a bend of $\pm 180^\circ$ or 3 million torsion cycles with a bend of $\pm 180^\circ$ on a cable length of 1 m are permitted.

6.2.5 Antenna parameter assignment

Depending on the country or region in which the antenna is being operated, it is subject to regional limitations with respect to the radiated power.

Limitations in the EU, EFTA, or Turkey

Note

Limitation of the radiated power according to EN 302 208 V1.4.1 (ETSI)

RF600 systems that are put into operation in the EU, EFTA or Turkey must not exceed the following radiated power with an RF615A antenna:

- 500 mW ERP (or 27 dBm ERP)
Converted into EIRP: 820 mW EIRP (or 29 dBm EIRP)

Make the following settings to ensure that the maximum permitted radiated power of the antenna is not exceeded:

- Antenna gain: -5 dBi
- Radiated power: ≤ 340 mW ERP (or 25.35 dBm ERP)
Converted into EIRP: ≤ 560 mW EIRP (or 27.5 dBm EIRP)
- Use of cable loss associated with the antenna cable.

Limitations in the USA and Canada

Note

Limitation of the radiated power (FCC)

RF600 systems that are put into operation in the USA and Canada must not exceed the following radiated power with an RF615A antenna:

- 4000 mW EIRP (or 36 dBm EIRP)
-

Make the following settings to ensure that the maximum permitted radiated power of the antenna is not exceeded:

- Conducted power P (dBm) of the RF600 reader: < 30 dBm
- Antenna gain G_i (dBi) in the FCC frequency band: ≤ -5 dBi
- Cable loss a_k (dB): ≥ 1 dB

$$P \text{ (dBm)} \leq 30 \text{ dBm} - (G_i - 6 \text{ dBi}) + a_k$$

Limitations in China

Note

Limitation of the radiated power (CMIIT)

RF600 systems that are put into operation in China must not exceed the following radiated power with an RF615A antenna:

- 2000 mW ERP (or 33 dBm ERP)
Converted into EIRP: 3250 mW EIRP (or 35 dBm EIRP)
-

Make the following settings to ensure that the maximum permitted radiated power of the antenna is not exceeded:

- Radiated power: ≤ 2000 mW ERP (or 33 dBm ERP)
Converted into EIRP: ≤ 3250 mW EIRP (or 35 dBm EIRP)
- Use of cable loss associated with the antenna cable.

Limitations in Japan

Note

Limitation of the radiated power (ARIB)

RF600 systems that are put into operation in Japan must not exceed the following radiated power with an RF615A antenna:

- 500 mW EIRP (or 27 dBm EIRP) for operation with RF650R (ARIB STD-T107)
- 4000 mW EIRP (or 36 dBm EIRP) for operation with RF680R/RF685R (ARIB STD-T106)

The maximum permissible radiated power of the antenna cannot be reached or exceeded due to the negative antenna gain.

6.2.6 Antenna patterns

6.2.6.1 Alignment of transponders to the antenna

Polarization axis

Since the RF615A antenna has linear polarization, it is necessary to consider the alignment of the transponders with regard to the polarization axis of the antenna.

The polarization axes of antenna and transponder must always be parallel. The symbol on the antenna indicates the polarization axis.



Figure 6-2 Polarization axis

Alignment

The following diagram shows the optimum alignment of the RF600 transponders to the RF615A antenna.

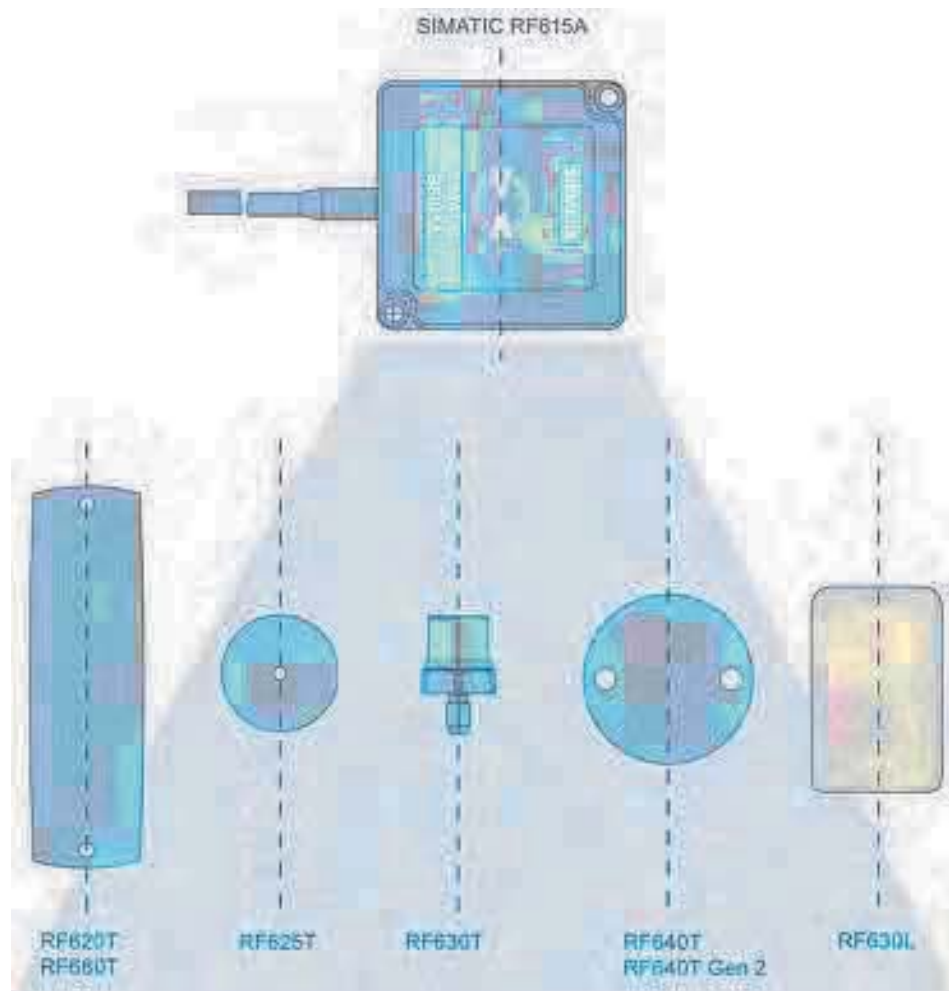

Figure 6-3 Optimum alignment of transponders to the antenna

Angle deviation diagram for alignment

The following diagram shows the dependence of the following factors:

- Alignment angle of transponder to antenna
- Maximum range of antenna

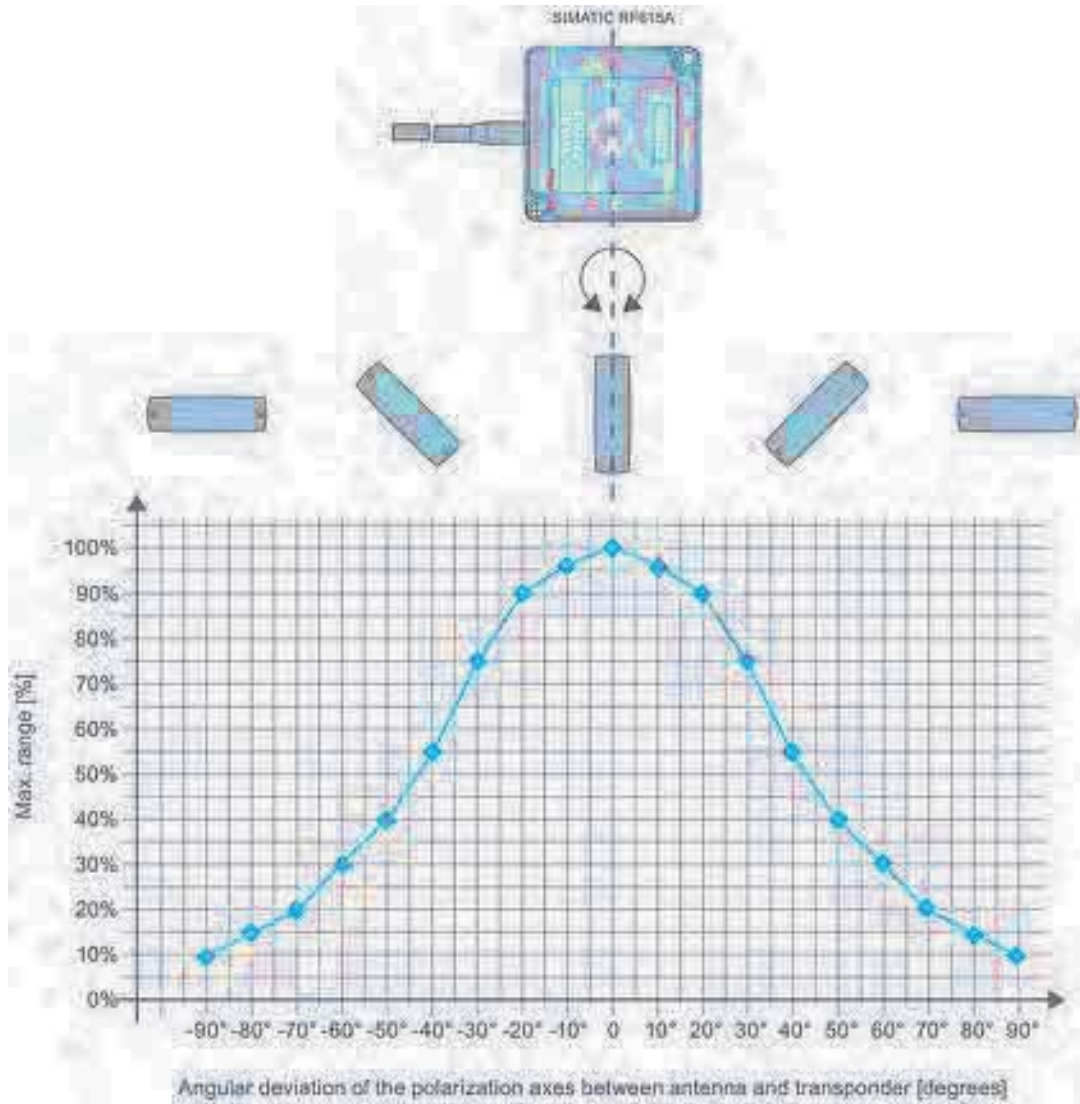

Figure 6-4 Effect on the read/write range depending on the antenna alignment

6.2.6.2 Antenna pattern ETSI

Directional radiation pattern ETSI

The directional radiation pattern is shown for nominal alignment and a center frequency of 866.3 MHz. The nominal antenna alignment is given when the antenna elevation is provided as shown in the following figure.

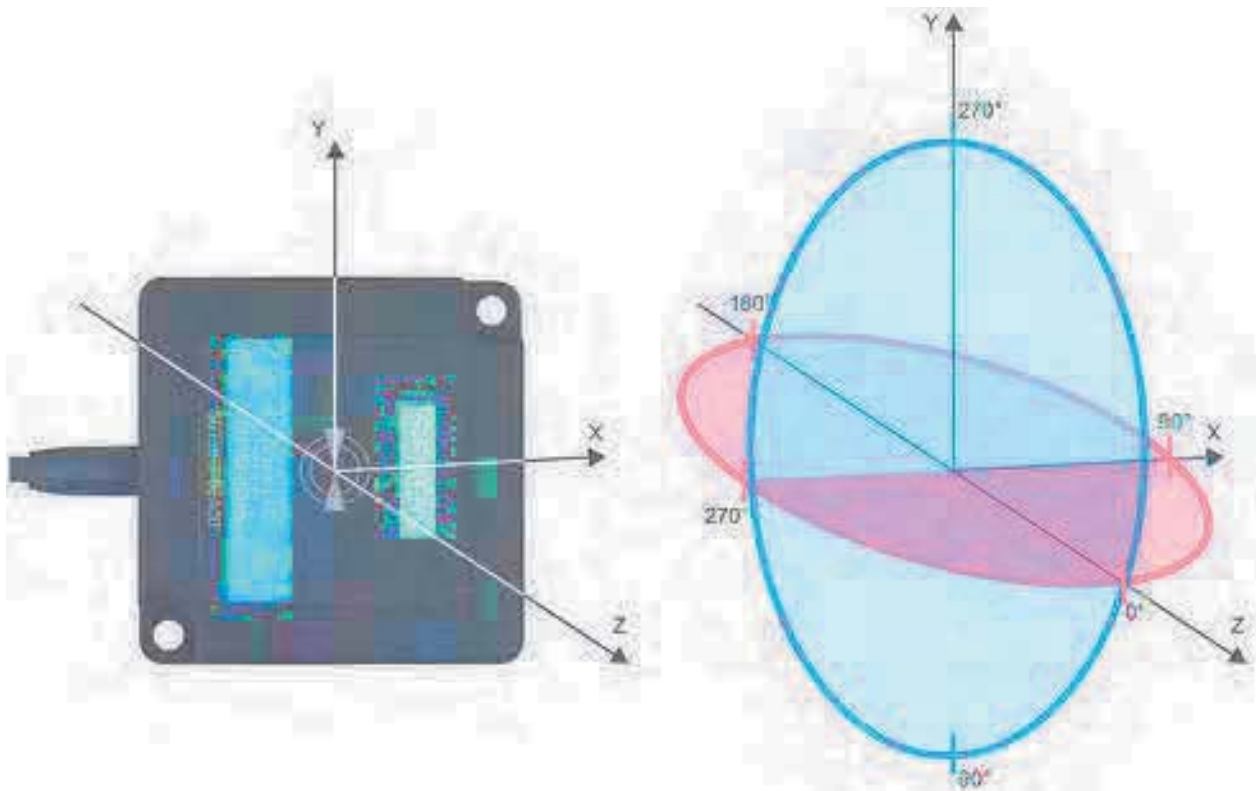
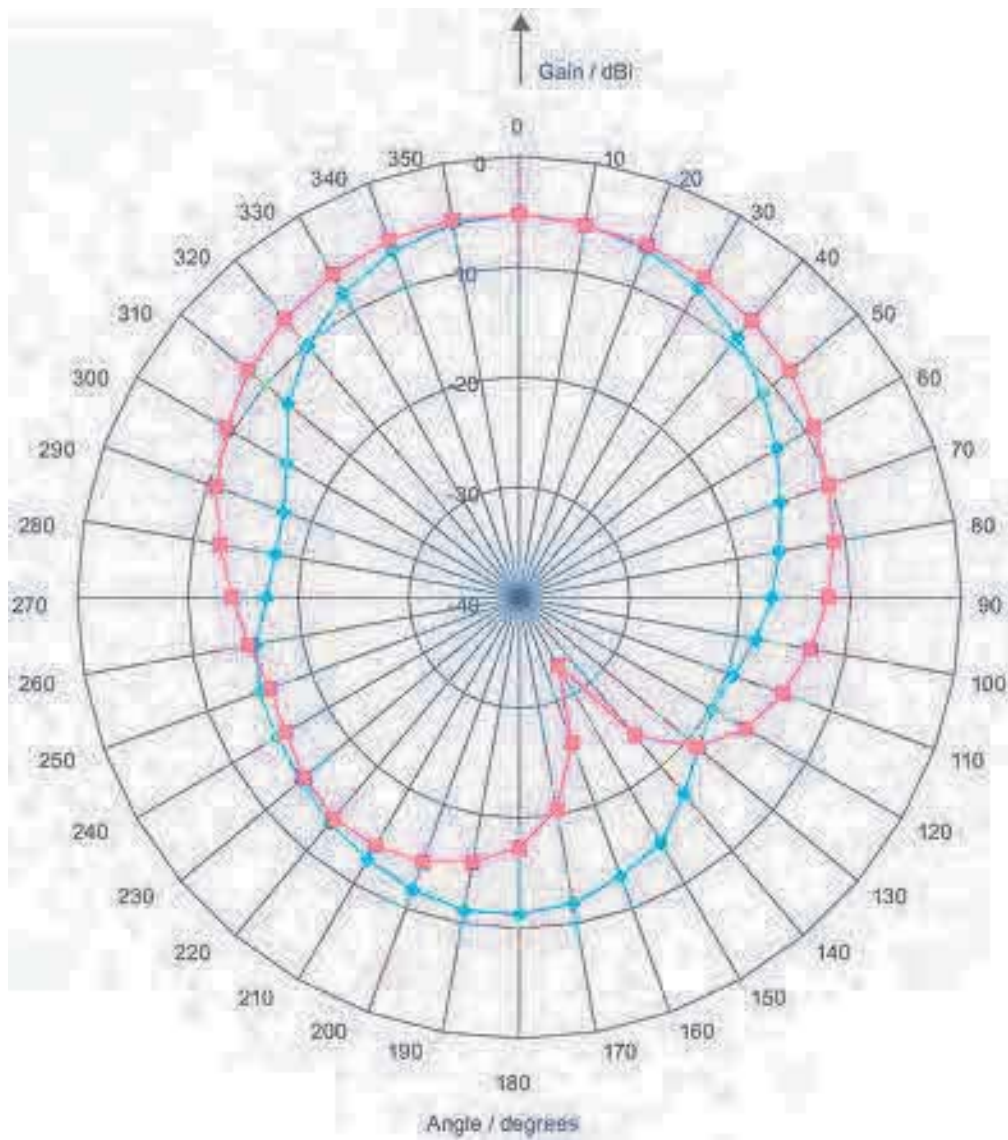

Figure 6-5 Reference system

The half-power beam width of the antenna is defined by the angle between the two -3 dB points. The range (in %) corresponding to the dB values in the patterns can be obtained from this table .

Note that the measurements presented graphically below were carried out in a low-reflection environment. Deviations can therefore occur in a normally reflecting environment.

Directional radiation pattern ETSI on metallic mounting surface (15 cm x 15 cm)



- Pattern of the vertical plane of the antenna
- Pattern of the horizontal plane of the antenna

Figure 6-6 Directional radiation pattern RF615A ETSI on metallic mounting surface

Directional radiation pattern ETSI on non-metallic mounting surface

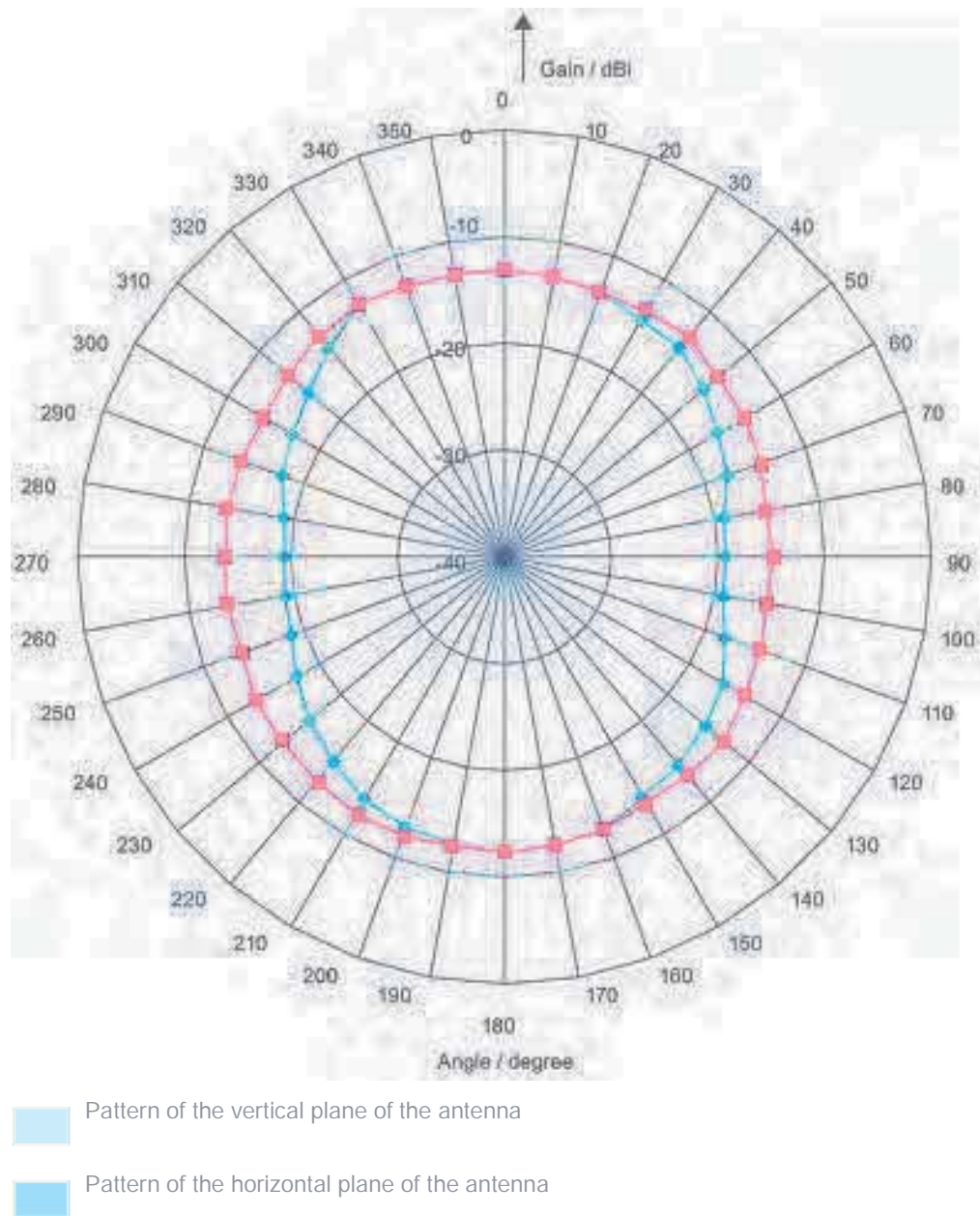

Figure 6-7 Directional radiation pattern RF615A ETSI on non-metallic mounting surface

6.2.6.3 Antenna pattern FCC

Directional radiation pattern FCC

The directional radiation pattern is shown for nominal alignment and a center frequency of 915 MHz.

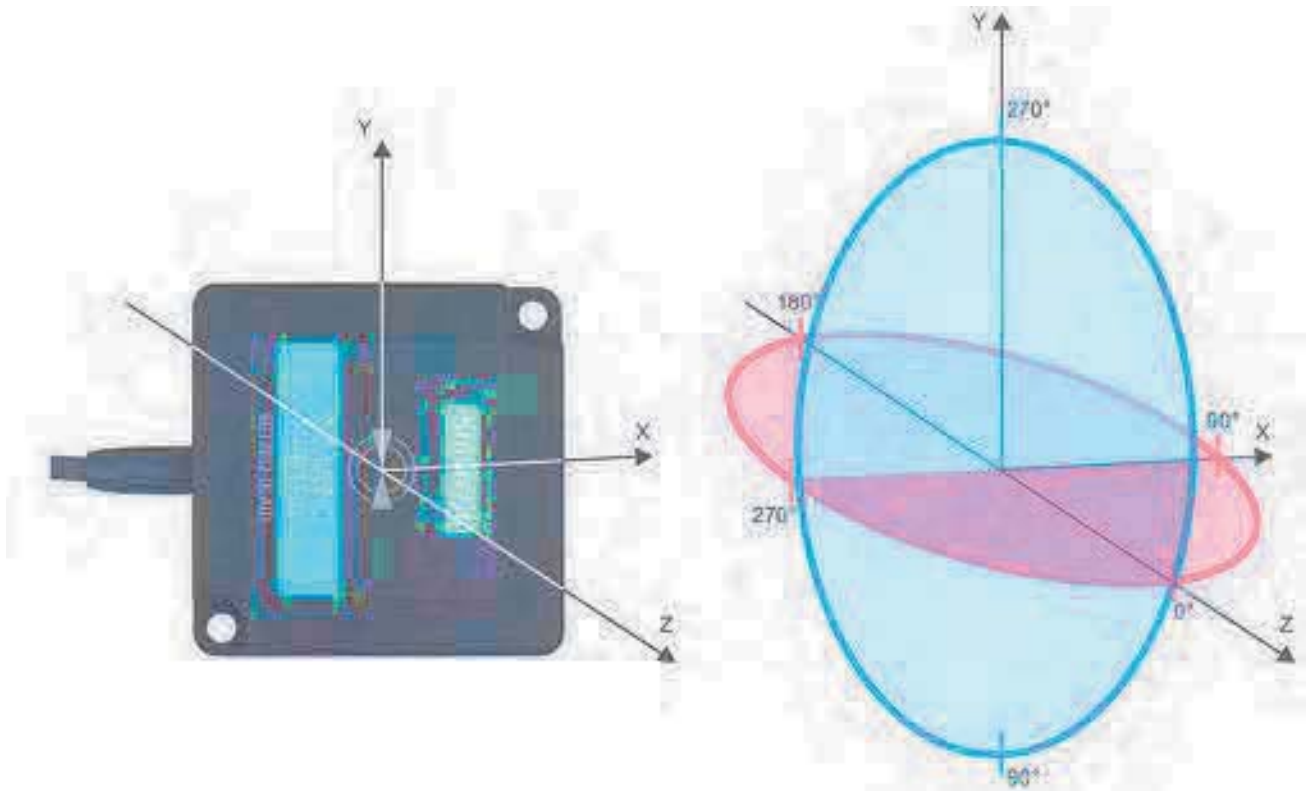

Figure 6-8 Reference system

The half-power beam width of the antenna is defined by the angle between the two -3 dB points (corresponding to half the power in relation to the maximum power). Which range (in %) corresponds to the dB values in the patterns can be obtained from this table .

Note that the measurements presented graphically below were carried out in a low-reflection environment. Low deviations can therefore occur in a normally reflecting environment.

Directional radiation pattern of the RF615A (FCC) on metallic mounting surface (15 cm x 15 cm)

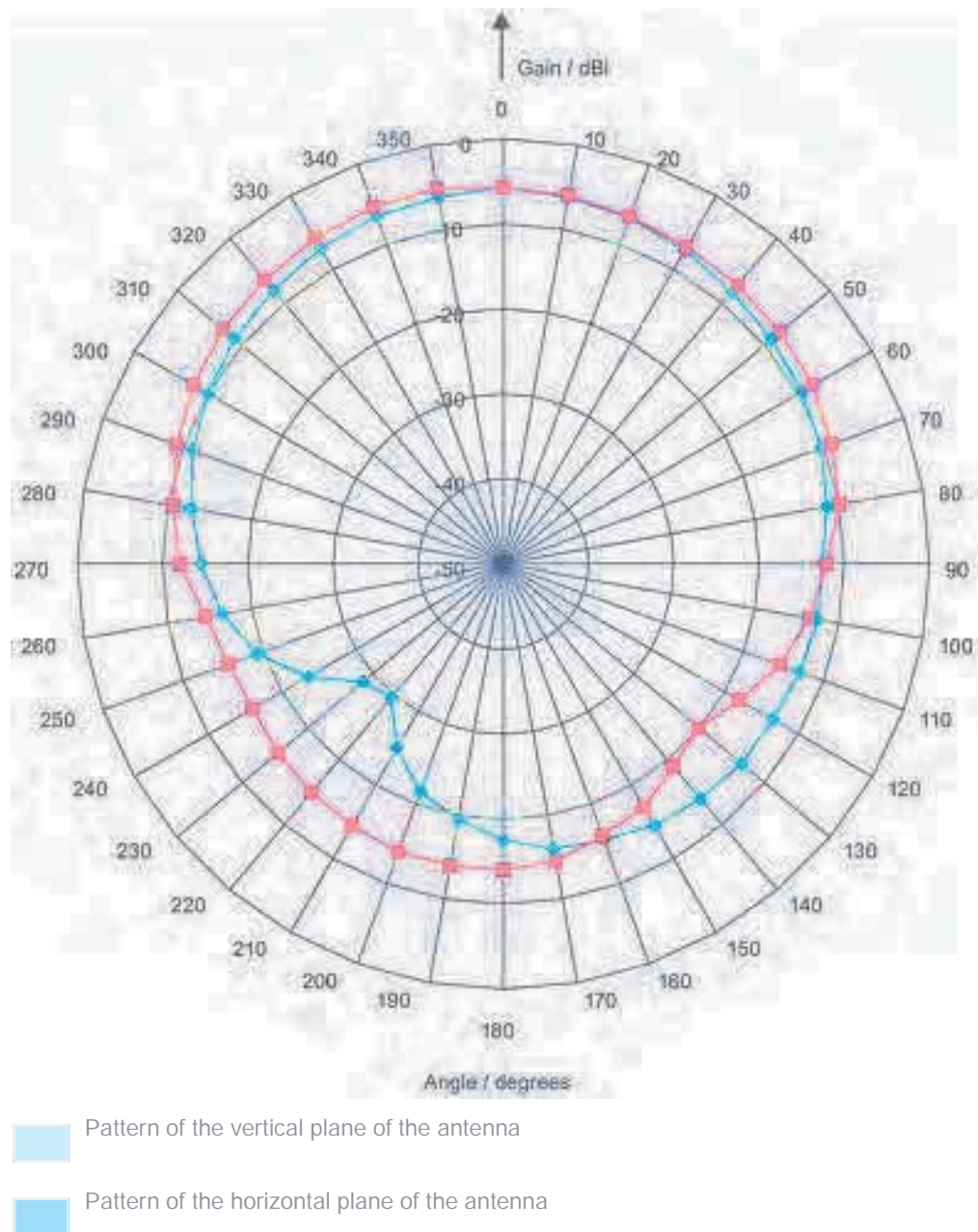
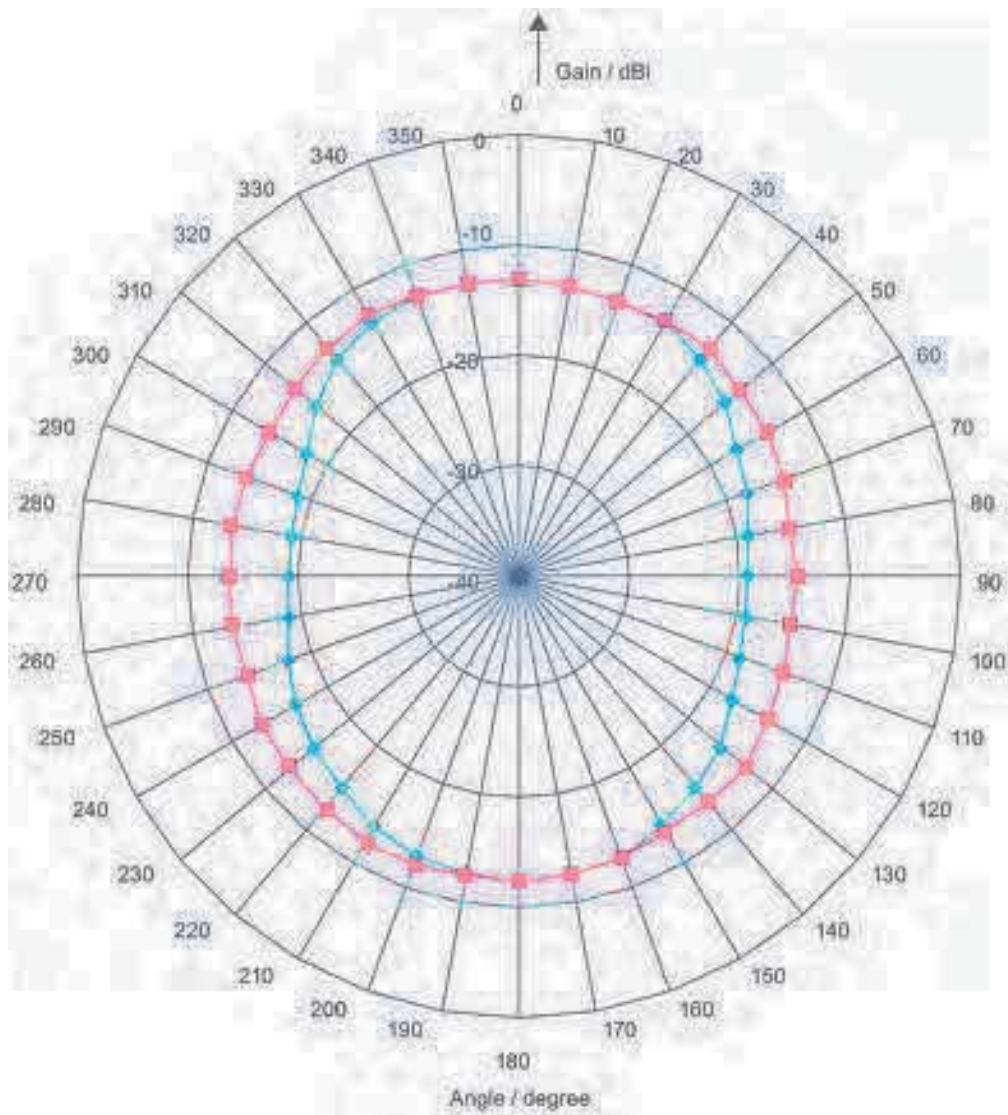

Figure 6-9 Directional radiation pattern of the RF615A (FCC) on metallic mounting surface

Directional radiation pattern of the RF615A (FCC) on non-metallic mounting surface



- Pattern of the vertical plane of the antenna
- Pattern of the horizontal plane of the antenna

Figure 6-10 Directional radiation pattern of the RF615A (FCC) on non-metallic mounting surface

6.2.6.4 Interpretation of directional radiation patterns

The following overview table will help you with the interpretation of directional radiation patterns.

The table shows which dBi values correspond to which read/write ranges (in %): You can read the radiated power depending on the reference angle from the directional radiation patterns, and thus obtain information on the read/write range with this reference angle with regard to a transponder.

The dBr values correspond to the difference between the maximum dBi value and a second dBi value.

Deviation from maximum antenna gain [dBr]	Read/write range [%]
0	100
-3	70
-6	50
-9	35
-12	25
-15	18
-18	13

Example

As can be seen from the Antenna pattern ETSI (Page 241), the maximum antenna gain is -5 dBi. In the vertical plane, the antenna gain has dropped to approx. -11 dBi at +50°. This means that the dBr value is -6. The antenna range is only 50% of the maximum range at +50° from the Z axis within the vertical plane (see line shown in blue in the directional radiation pattern: Characteristic of the vertical plane of the antenna and the associated representation of the reference system).

6.2.7 Technical data

Table 6- 7 Technical specifications for the RF615A antenna

6GT2812-0EA0x	
Product type designation	SIMATIC RF615A
Radio frequencies	
Operating frequency	
• ETSI	• 865 to 868 MHz
• FCC	• 902 to 928 MHz
Maximum radiated power	
• ETSI	• ≤ 340 mW ERP
• FCC	• ≤ 560 mW EIRP
• CMIIT	• ≤ 340 mW ERP
• ARIB	• STD-T107: RF650R: ≤ 500 mW EIRP • STD-T106: RF680R/RF685R: < 560 mW EIRP
Antenna gain	
• ETSI	• -13 dBi ... -5 dBi • Depends on background, refer to the section "Antenna pattern ETSI (Page 241)"
• FCC	• Depends on background, refer to the section "Antenna pattern FCC (Page 244)"
Opening angle for sending/receiving when mounted on a metal surface of 15 cm x 15 cm ¹⁾	
• ETSI	• Horizontal plane: 100° Vertical plane: 75° see section "Antenna pattern ETSI (Page 241)"
• FCC	• Horizontal plane: 130° Vertical plane: 105° see section "Antenna pattern FCC (Page 244)"

6GT2812-0EA0x

Electrical data

Range	See section "Maximum read/write ranges of transponders (Page 59)"
Impedance	50 Ω
Polarization	Linear
VSWR (standing wave ratio)	≤ 2:1
Power	
<ul style="list-style-type: none"> • ETSI 	<ul style="list-style-type: none"> • ≤ 2 W
<ul style="list-style-type: none"> • FCC 	<ul style="list-style-type: none"> • ≤ 1 W

Interfaces

Plug connection	30 cm coaxial cable with RP-TNC coupling (for connection of the antenna cable)
-----------------	--

Mechanical specifications

Material	PA6 V0, silicone-free
Color	Black
Tightening torque (at room temperature)	≤ 1.5 Nm (when mounted on a flat surface)

Permitted ambient conditions

Ambient temperature	
<ul style="list-style-type: none"> • During operation 	<ul style="list-style-type: none"> • -20 ... +70 °C
<ul style="list-style-type: none"> • During transportation and storage 	<ul style="list-style-type: none"> • -40 ... +85 °C
Conditions relating to UL approval	<ul style="list-style-type: none"> • for indoor use only (dry location) • mounted on height below 2 m • Coaxial connectors and cables shall comply with NFPA70 art. 820 part V
Degree of protection	IP67 (IP rating is not investigated by UL)
Shock resistant to EN 60068-2-27	50 g ²⁾
Vibration to EN 60068-2-6	20 g ²⁾

Design, dimensions and weight

Dimensions (H x W x D)	52 x 52 x 16 mm
Weight	60 g

6GT2812-0EA0x	
Standards, specifications, approvals	
Proof of suitability	FCC: cULus
MTBF	1190 years

- 1) The values differ for different dimensions/materials of the mounting surface.
- 2) The values for shock and vibration are maximum values and must not be applied continuously.

6.2.8 Dimension drawing

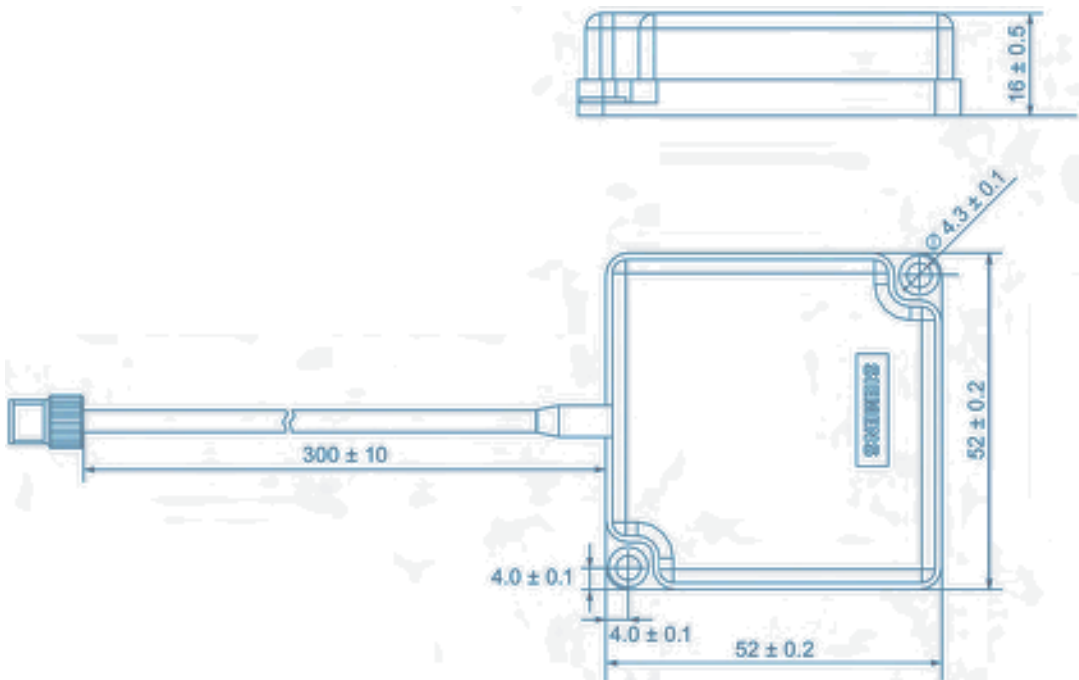

Figure 6-11 Dimension drawing RF615A

All dimensions in mm

6.2.9 Certificates & approvals

Table 6- 8 6GT2812-0EA00





Labeling	Description
	Conformity with the RED directive 2014/53/EU Conformity with the RoHS directive 2011/65/EU

Table 6- 9 6GT2812-0EA01

Labeling	Description
 Federal Communications Commission	FCC CFR 47, Part 15 sections 15.247 Radio Frequency Interference Statement This equipment has been tested and found to comply with the limits for a Class B digital device, pursuant to Part 15 of the FCC Rules. The FCC approval is granted in association with the FCC approval of the following RF600 readers: <ul style="list-style-type: none"> FCC ID: NXW-RF600R2 (for RF650R: 6GT2811-6AB20-1AA0, RF680R: 6GT2811-6AA10-1AA0, RF685R: 6GT2811-6CA10-1AA0)
Industry Canada Radio Standards Specifications	RSS-210 Issue 7, June 2007, Sections 2.2, A8 The approval for Industry Canada is granted in association with the Industry Canada approval of the following RF600 readers: <ul style="list-style-type: none"> IC: 267X-RF600R2, Model RF650R (for 6GT2811-6AB20-1AA0) IC: 267X-RF600R2, Model RF680R (for 6GT2811-6AA10-1AA0) IC: 267X-RF600R2, Model RF685R (for 6GT2811-6CA10-1AA0)
	This product is UL-certified for the USA and Canada. It meets the following safety standard(s): <ul style="list-style-type: none"> UL Report E115352 UL 62368-1 - AVICT Equipment - Part 1: Safety Requirements CSA C22.2 No. 62368-1-14 AVICT Equipment - Part 1: Safety Requirements

6.3 SIMATIC RF620A

6.3.1 Characteristics

SIMATIC RF620A	Characteristics	
	Area of application	The SIMATIC RF620A is a universal UHF antenna in a compact size for industrial applications in limited installation spaces.
	Frequency range	<ul style="list-style-type: none"> • 865 to 868 MHz (RF620A ETSI) • 902 to 928 MHz (RF620A FCC)
	Read range	Max. 2 m
	Polarization	Linear
	Degree of protection	IP67
	Mounting	2x M5
	Connector	30 cm connecting cable (connected permanently to the antenna) and RP-TNC coupling An antenna cable is required for connection to the reader (e.g. 6GT2815-0BH30).

Frequency ranges

The antenna is a narrowband antenna and is available in the following two frequency range variants.

- RF620A ETSI: 865 to 868 MHz
- RF620A FCC: 902 to 928 MHz

Function

The SIMATIC RF620A is used for transmitting and receiving data in the UHF range. The antennas are connected to the SIMATIC RF600 readers via antenna cables that are available in different lengths.