

6.8.2 Ordering data

Table 6- 42 Ordering data RF680A

Product	Article number
SIMATIC RF680A	6GT2812-2GB08

Table 6- 43 Ordering data accessories

Product	Article number	
Connecting cable between reader and antenna	1 m (cable loss 0.5 dB)	6GT2815-0BH10
	3 m (cable loss 1.0 dB)	6GT2815-0BH30
	5 m, suitable for drag chains (cable loss 1.5 dB)	6GT2815-2BH50
	10 m (cable loss 2.0 dB)	6GT2815-1BN10
	10 m (cable loss 4.0 dB)	6GT2815-0BN10
	15 m, suitable for drag chains (cable loss 4.0 dB)	6GT2815-2BN15
	20 m (cable loss 4.0 dB)	6GT2815-0BN20
	40 m (cable loss 5.0 dB)	6GT2815-0BN40
SIMATIC antenna holder for RF 600 devices	6GT2890-2AB10	
Antenna mounting kit	6GT2890-0AA00	

6.8.3 Installation

Mounting system

A standardized VESA 100 mounting system is provided to mount the antenna. The mounting system consists of four fixing holes for M4 screws at intervals of 100 mm. The antenna is suitable for mounting on metallic and non-metallic surfaces.

Note

Achieving optimum wave propagation

To achieve optimum wave propagation, the antenna should not be surrounded by conducting objects. The area between antenna and transponder should also allow wave propagation without interference.

Antenna holders

The Siemens antenna holders allow for fine adjustment of the antenna field by setting the solid angle.

6.8.4 Connecting the antenna

The SIMATIC RF680A antenna must be connected to the reader using an antenna cable. Preassembled standard cables in lengths of 1 m, 3 m, 5 m, 10 m, 15 m, 20 m and 40 m are available to connect the antenna.

NOTICE

Connecting the antenna

Do not connect the adaptive antenna RF680A during operation. Only connect the antenna to a reader that has been switched off and then restart the reader.

The range of the antenna is limited by the cable loss. The maximum range can be achieved with the cable 6GT2815-0BH10 (length 1 m), since this cable has the lowest cable loss.

Requirement

Note

Use of Siemens antenna cables

To ensure optimum functioning of the antenna, it is recommended that a Siemens antenna cable be used in accordance with the list of accessories.

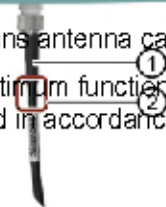

Strain relief

To protect the antenna from strain, you can attach strain relief, e.g. in the form of a strain relief clamp. The following graphic shows the optimum mounting point for attaching strain relief.

- ① RF600 antenna cable
 ② Mounting point for strain relief

Figure 6-52 Strain relief

6.8.4.1 Bending radii and bending cycles of the cable

The following listed bending radii are minimum values, which may not be fallen below and are based on repeated bending.

Table 6-44 Bending radii of the antenna cable

Cable designation	Article number	Length [m]	Cable loss [dB]	Bending radius [mm]
Antenna cable	6GT2815-0BH10	1	0.5	51
Antenna cable	6GT2815-0BH30	3	1	51
Antenna cable (suitable for drag chains)	6GT2815-2BH50	5	1.5	45 ¹⁾²⁾
Antenna cable	6GT2815-1BN10	10	2	77
Antenna cable	6GT2815-0BN10	10	4	51
Antenna cable (suitable for drag chains)	6GT2815-2BN15	15	4	45 ¹⁾²⁾

Cable designation	Article number	Length [m]	Cable loss [dB]	Bending radius [mm]
Antenna cable	6GT2815-0BN20	20	4	77
Antenna cable	6GT2815-0BN40	40	5	77

¹⁾ Permissible minimum bending radius with one-time bending, 28 mm

²⁾ With cables capable of being used in drag chains, 100,000 bending cycles at a bending radius of 100 mm and a bend of $\pm 180^\circ$ or 3 million torsion cycles with a bend of $\pm 180^\circ$ on a cable length of 1 m are permitted.

6.8.5 Antenna parameter assignment

Depending on the country or region in which the antenna is being operated, it is subject to regional limitations with respect to the radiated power.

Limitations in the EU, EFTA, or Turkey

Note

Limitation of the radiated power according to EN 302 208 V1.4.1 (ETSI)

RF600 systems that are put into operation in the EU, EFTA or Turkey must not exceed the following radiated power with an RF680A antenna:

- 2000 mW ERP (or 33 dBm ERP)
Converted into EIRP: 3250 mW EIRP (or 35 dBm EIRP)

Make the following settings to ensure that the maximum permitted radiated power of the antenna is not exceeded:

- Antenna gain: 3.5 dBi (6.5 dBic)
- Radiated power: ≤ 2000 mW ERP (or 33 dBm ERP)
Converted into EIRP: ≤ 3250 mW EIRP (or 35 dBm EIRP)
- Use of cable loss associated with the antenna cable.

Limitations in the USA and Canada

Note

Limitation of the radiated power (FCC)

RF600 systems that are put into operation in the USA and Canada must not exceed the following radiated power with an RF680A antenna:

- 4000 mW EIRP (or 36 dBm EIRP)

Make the following settings to ensure that the maximum permitted radiated power of the antenna is not exceeded:

- Conducted power P (dBm) of the RF600 reader: < 30 dBm
- Antenna gain G_i (dBi) in the FCC frequency band: ≤ 3.5 dBi
- Cable loss a_k (dB): ≥ 1 dB

$$P \text{ (dBm)} \leq 30 \text{ dBm} - (G_i - 6 \text{ dBi}) + a_k$$

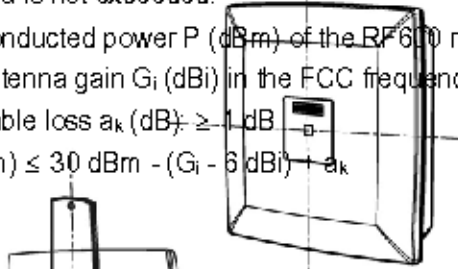

Limitations in China

Note

Limitation of the radiated power (CMIIT)

RF600 systems that are put into operation in China must not exceed the following radiated power with an RF680A antenna:

- 2000 mW ERP (or 33 dBm ERP)
- Converted into EIRP: 3250 mW EIRP (or 35 dBm EIRP)

Make the following settings to ensure that the maximum permitted radiated power of the antenna is not exceeded:

- Antenna gain: 3 dBi (6 dBic)
- Radiated power: ≤ 2000 mW ERP (or 33 dBm ERP)
- Converted into EIRP: ≤ 3250 mW EIRP (or 35 dBm EIRP)
- Use of cable loss associated with the antenna cable.

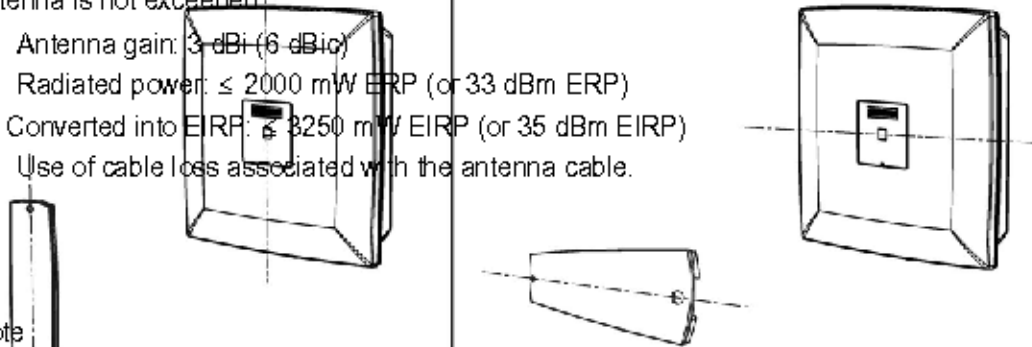

Limitations in Japan

Note

Limitation of the radiated power (ARIB)

RF600 systems that are put into operation in Japan must not exceed the following radiated power with an RF680A antenna:

- 500 mW EIRP (or 27 dBm EIRP) for operation with RF650R (ARIB STD-T107)
- 4000 mW EIRP (or 36 dBm EIRP) for operation with RF680R/RF685R (ARIB STD-T106)

6.8.6 Antenna patterns

Transponder alignment

The antenna RF680A has an adjustable antenna (circular or linear horizontal or linear vertical). With a circular antenna the alignment of the antenna axis of symmetry changes between horizontal and vertical each time it transmits. For this reason, with a circular antenna the alignment of the transponder polarization axis (horizontal/vertical) is unimportant. Make sure, however, that the transponder is aligned with the antenna.

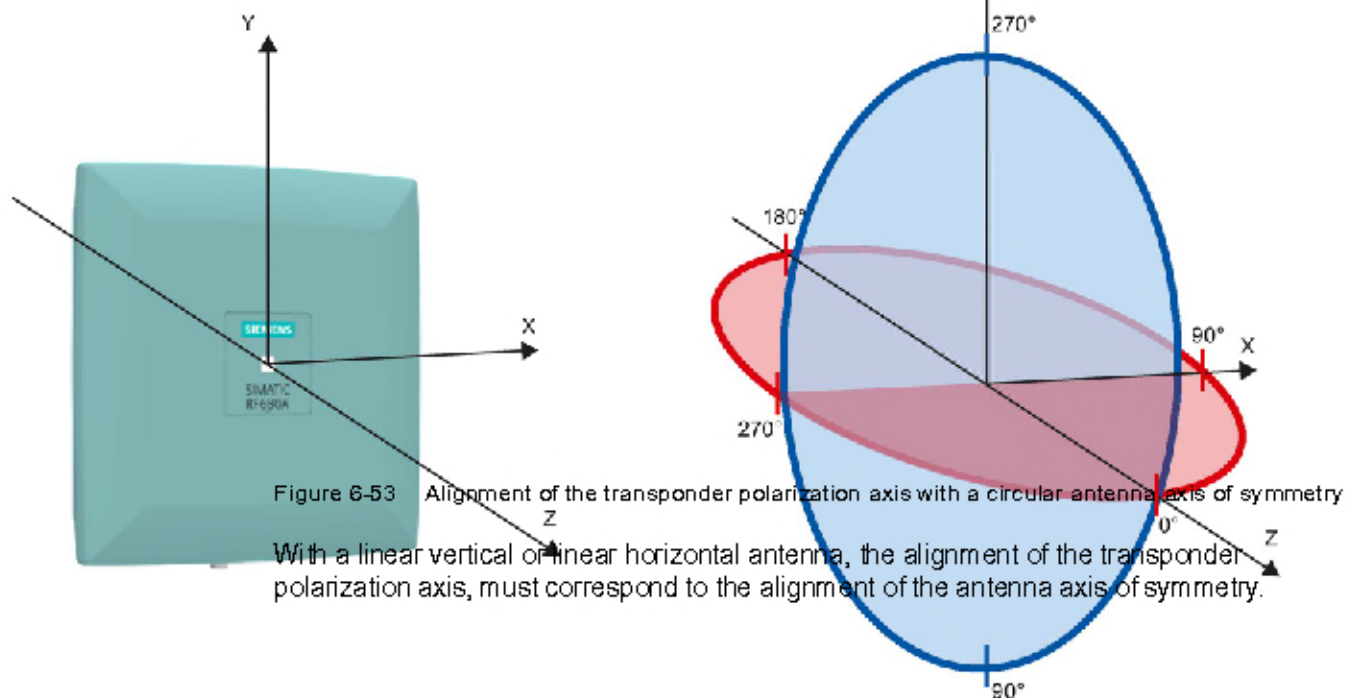

Figure 6-54 Alignment of the transponder polarization axis with a linear vertical or linear horizontal antenna axis of symmetry

6.8.6.1 Antenna patterns in the ETSI frequency band

Directional radiation pattern ETSI

The directional radiation pattern is shown for nominal alignment and a center frequency of 866.3 MHz. The nominal antenna alignment is given when the antenna elevation is provided as shown in the following figure.

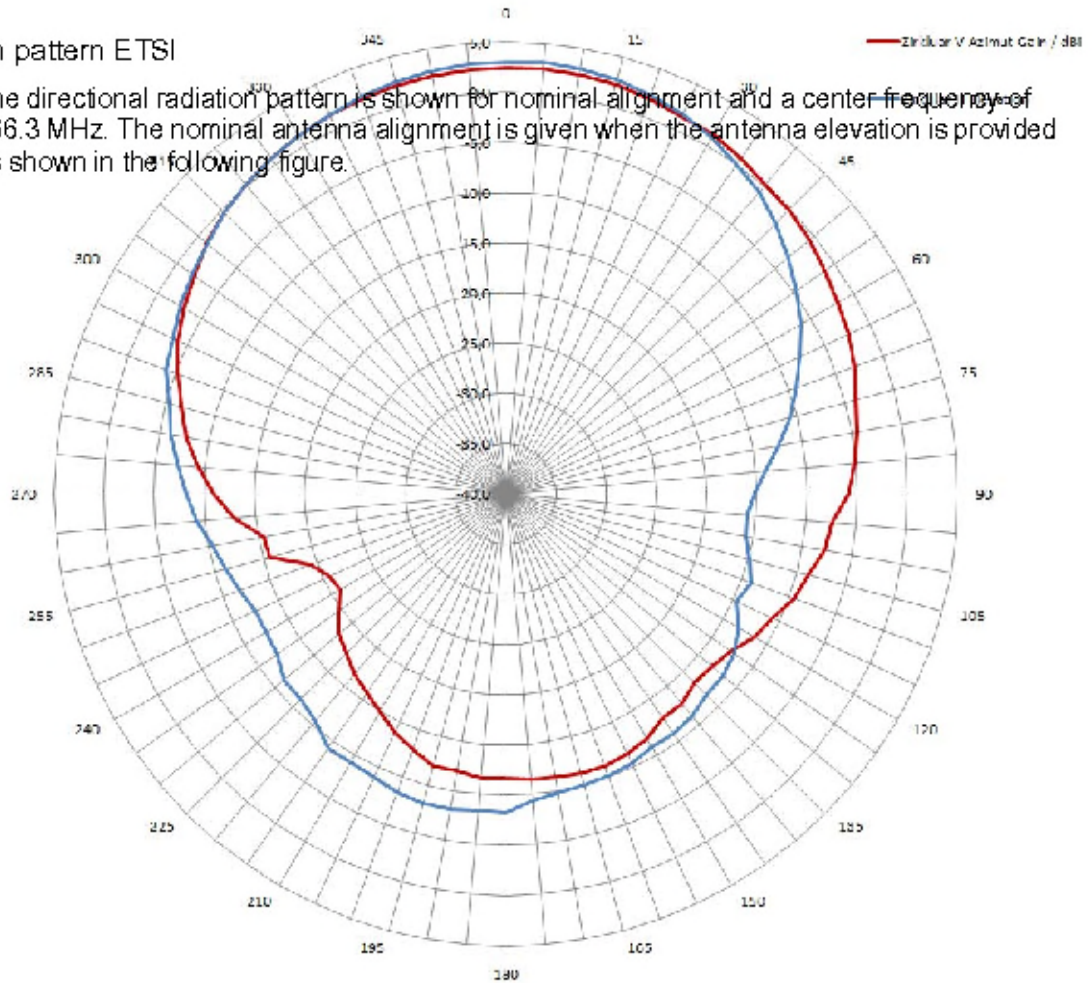

Figure 6-55 Reference system

The half-power beam width of the antenna is defined by the angle between the two -3 dB points. The range (in %) corresponding to the dB values in the patterns can be obtained from this table (Page 354).

Note that the measurements presented graphically below were carried out in a low-reflection environment. Deviations can therefore occur in a normally reflecting environment.

Radiation diagram circular in the ETSI frequency band

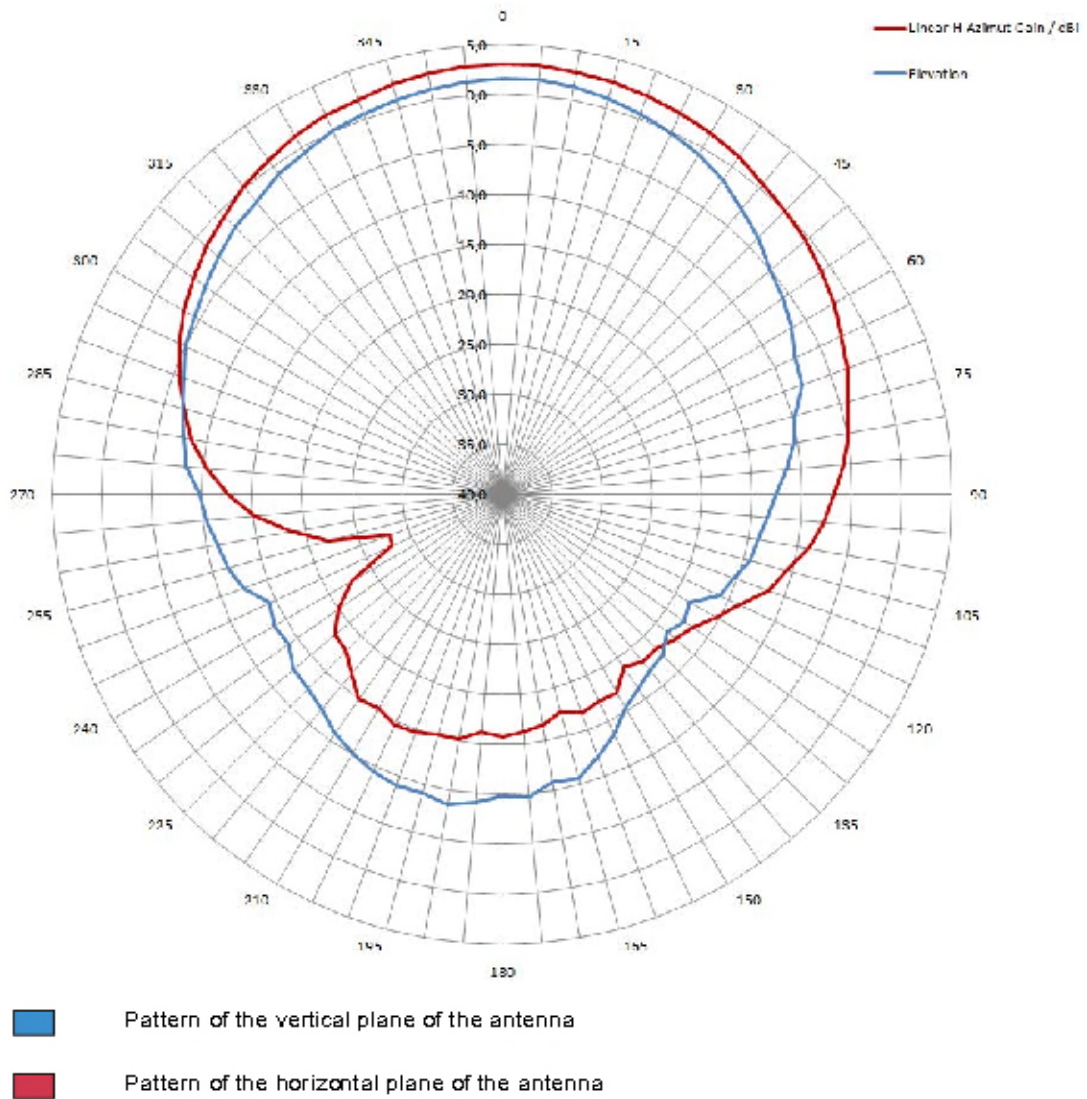

Figure 6-56 Directional radiation pattern of RF680A in the ETSI frequency band

Radiation diagram (linear horizontal) in the ETSI frequency band

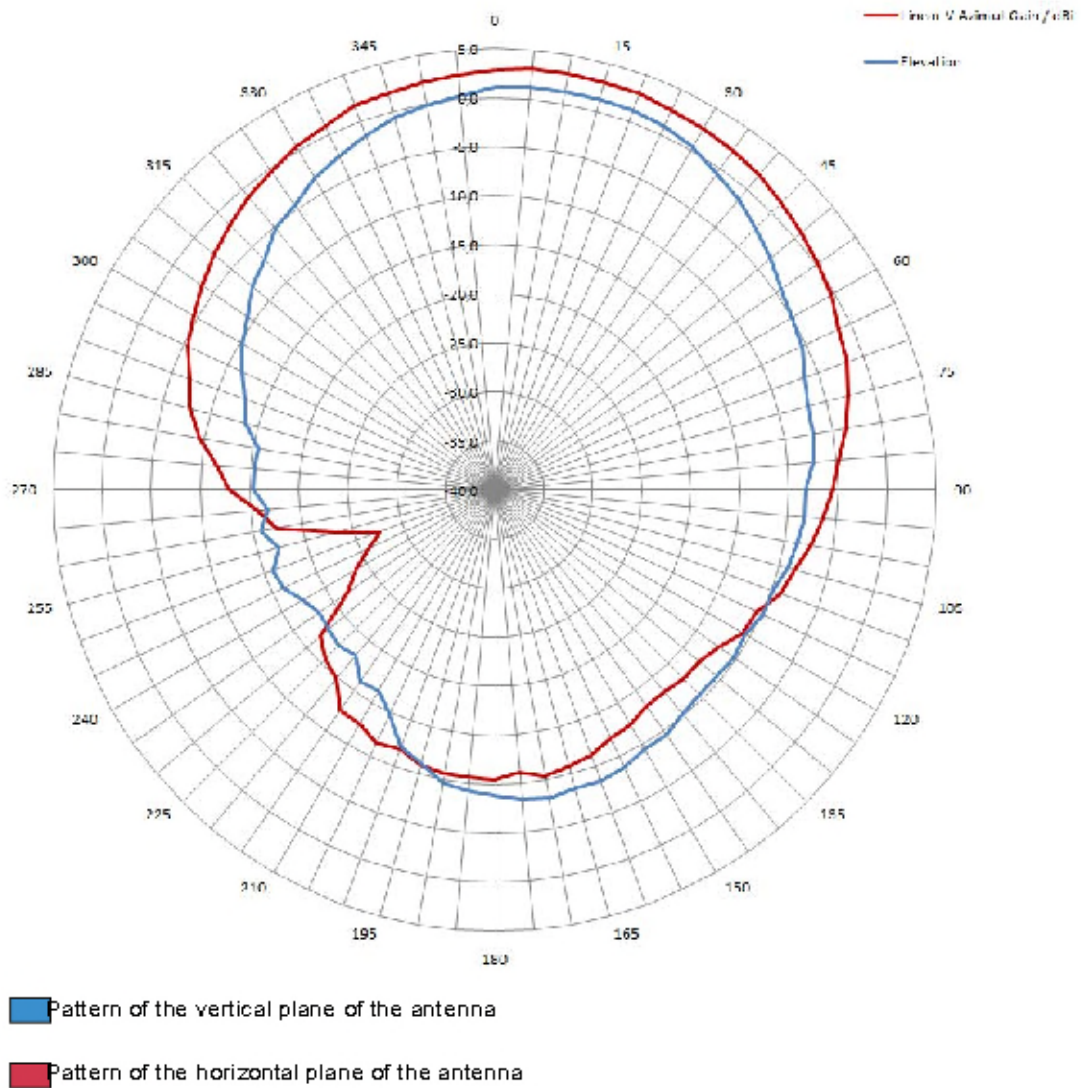
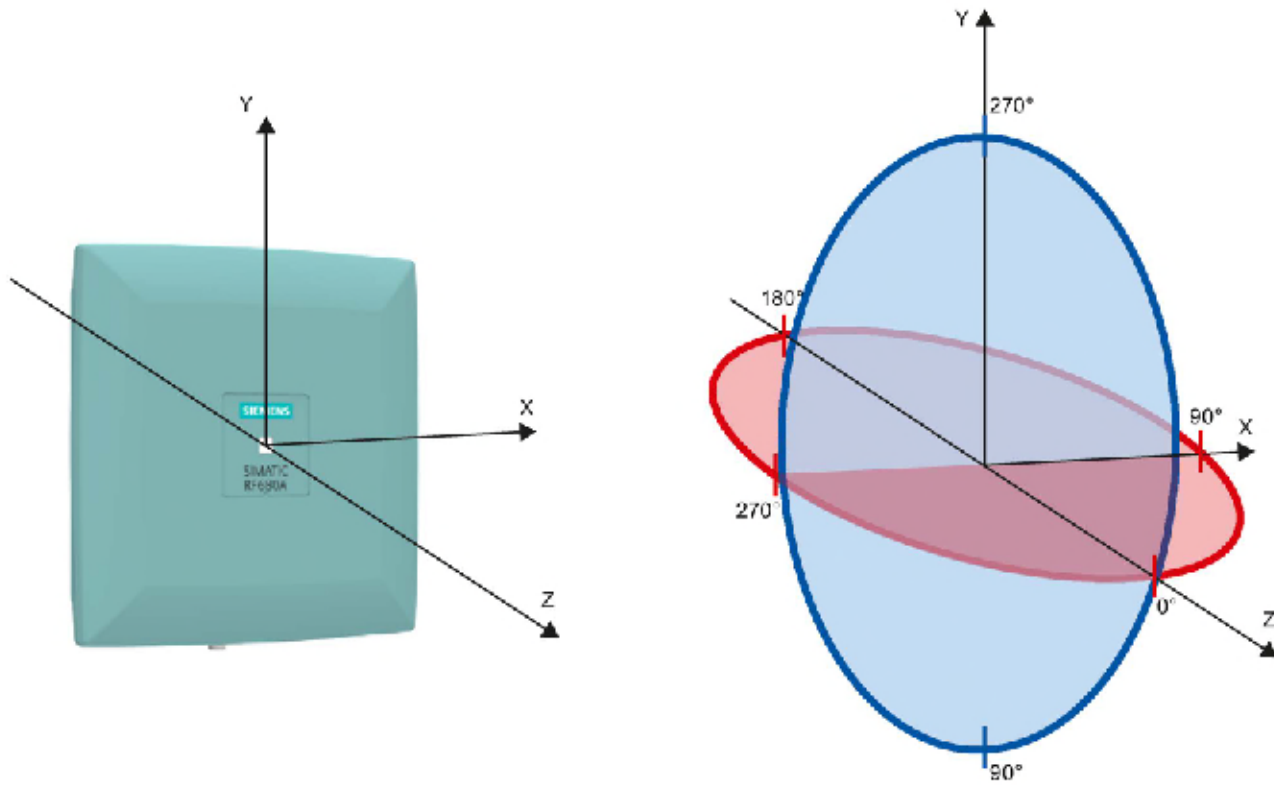

Figure 6-57 The RF680A directional radiation pattern in the ETSI frequency band, axis of symmetry of the antenna, and polarization axis of the transponder are aligned horizontally

Radiation diagram (linear vertical) in the ETSI frequency band



Pattern of the vertical plane of the antenna

Pattern of the horizontal plane of the antenna

Figure 6-58 The RF680A directional radiation pattern in the ETSI frequency band, axis of symmetry of the antenna, and polarization axis of the transponder are aligned vertically

6.8.6.2 Antenna patterns in the FCC frequency band

Directional radiation pattern FCC

The directional radiation pattern is shown for nominal alignment and a center frequency of 915 MHz.

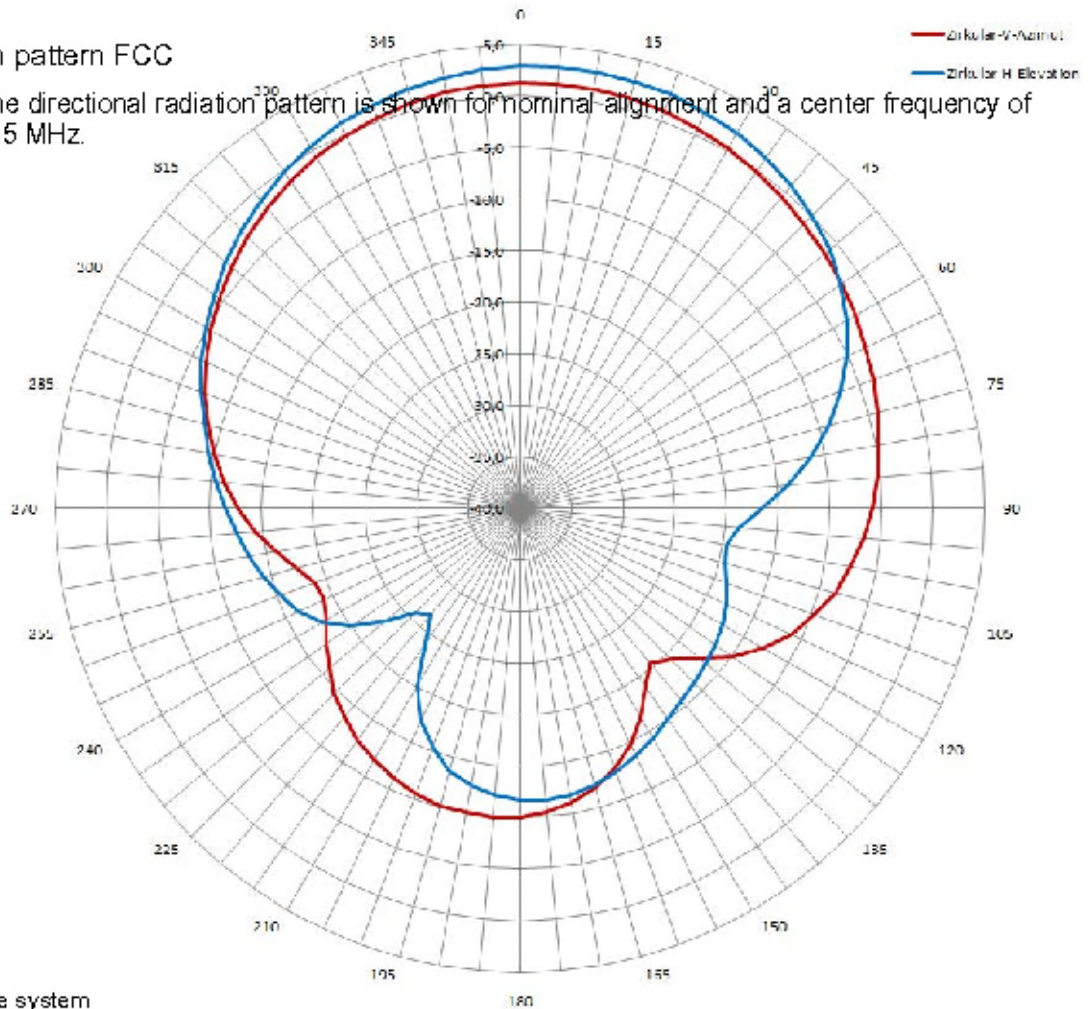
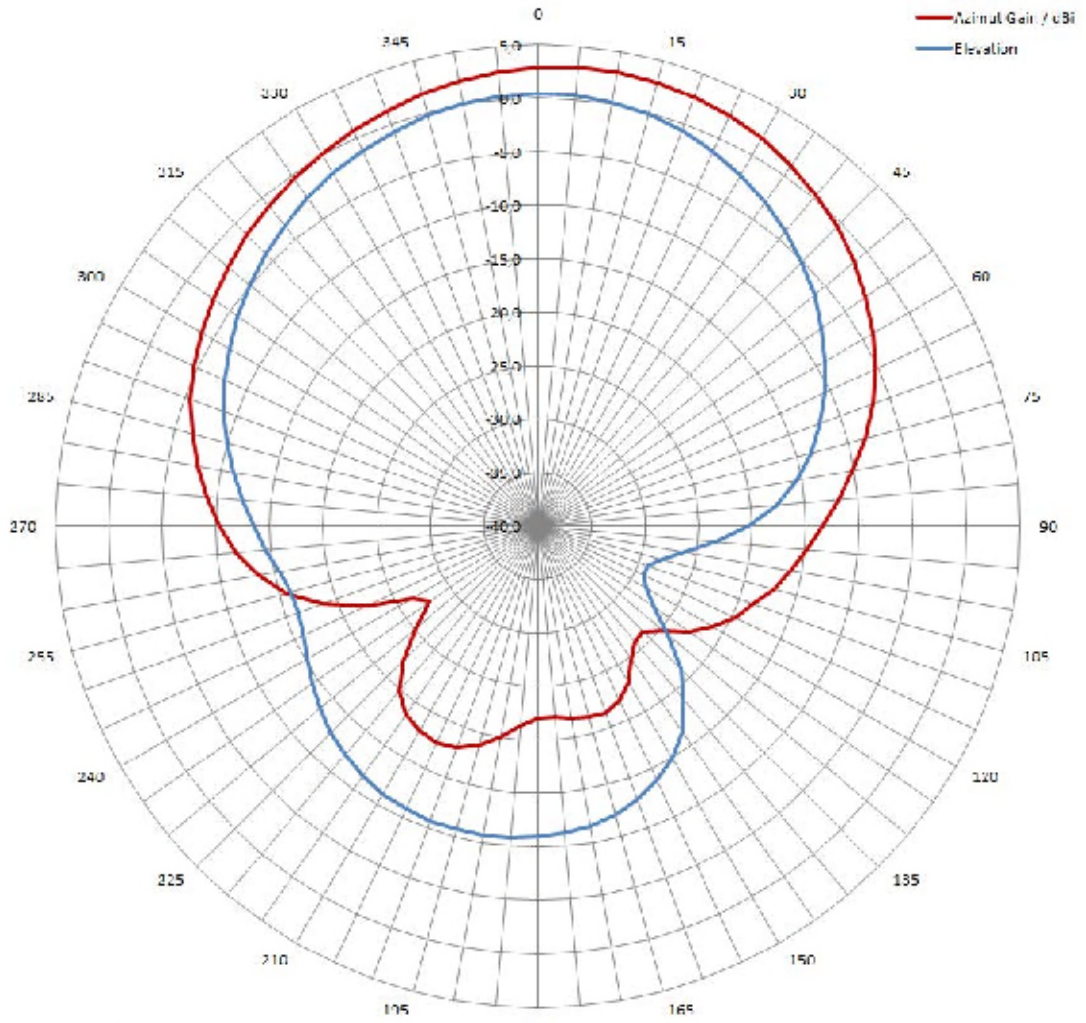

Figure 6-59 Reference system

The half-power beam width of the antenna is defined by the angle between the two -3 dB points (corresponding to half the power in relation to the maximum power). Which range (in %) corresponds to the dB values in the patterns can be obtained from this table (Page 354).

Note that the measurements presented graphically below were carried out in a low-reflection environment. Deviations can therefore occur in a normally reflecting environment.

Radiation diagram circular in the FCC frequency band



Pattern of the vertical plane of the antenna

 Pattern of the horizontal plane of the antenna

 Figure 6-60 Directional radiation pattern of the RF680A in the FCC frequency band

Radiation diagram (linear horizontal) in the FCC frequency band

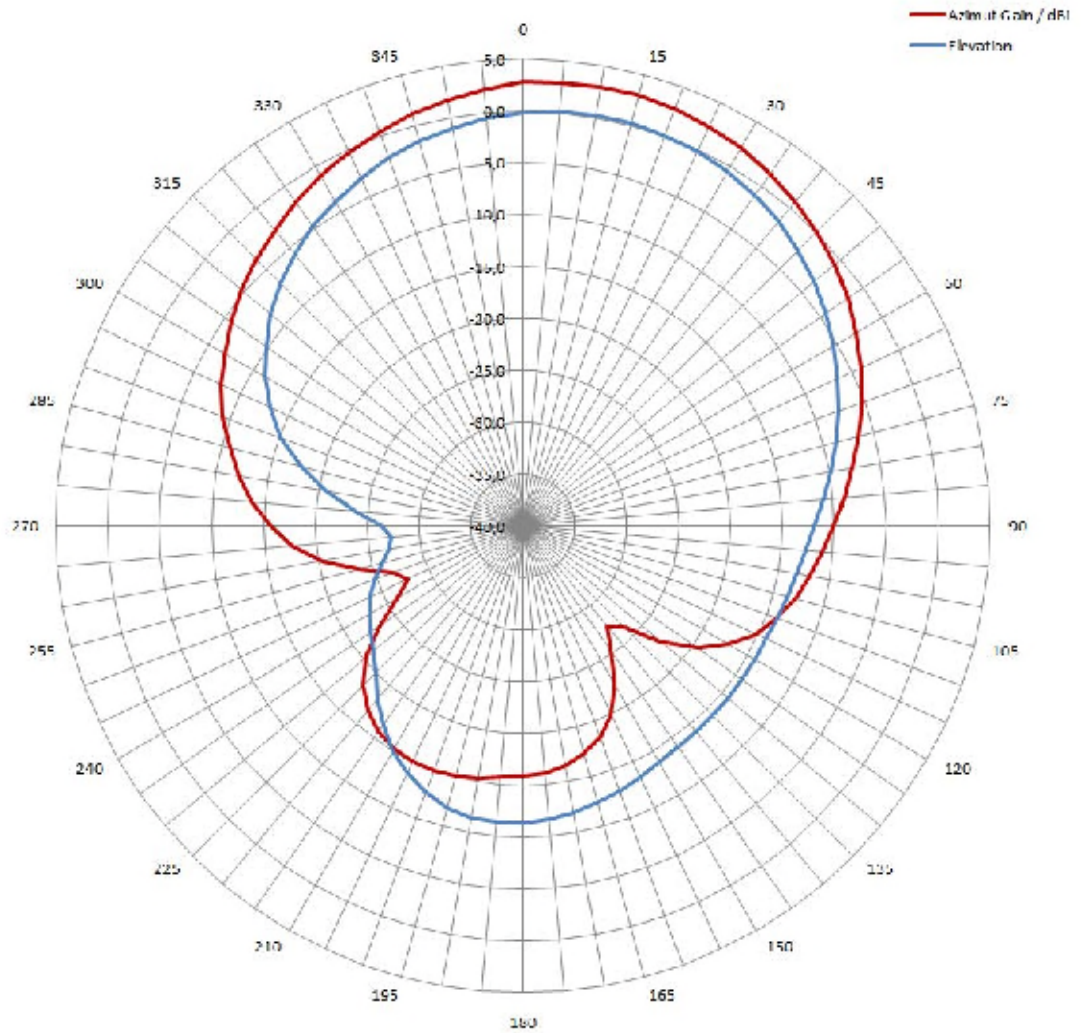

- Pattern of the vertical plane of the antenna
- Pattern of the horizontal plane of the antenna

Figure 6-61 The RF680A directional radiation pattern in the FCC frequency band, axis of symmetry of the antenna, and polarization axis of the transponder are aligned horizontally

Radiation diagram (linear vertical) in the FCC frequency band

Pattern of the vertical plane of the antenna

Pattern of the horizontal plane of the antenna

Figure 6-62 The RF680A directional radiation pattern in the FCC frequency band, axis of symmetry of the antenna, and polarization axis of the transponder are aligned vertically

6.8.6.3 Interpretation of directional radiation patterns

The following overview table will help you with the interpretation of directional radiation patterns.

The table shows which dBi values correspond to which read/write ranges (in %). You can read the radiated power depending on the reference angle from the directional radiation patterns, and thus obtain information on the read/write range with this reference angle with regard to a transponder.

The dBr values correspond to the difference between the maximum dBi/dBic value and a second dBi/dBic value.

Table 6- 45 Interpretation of directional radiation patterns

Deviation from maximum antenna gain [dBr]	Read/write range [%]
0	100
-3	70
-6	50
-9	35
-12	25
-15	18
-18	13

Example

As can be seen in "Antenna patterns in the ETSI frequency band (Page 346)" the maximum antenna gain in the vertical plane is 3.45 dBi (6.45 dBic). In this plane, and with the polarization axis of the transponder parallel to the axis of symmetry of the antenna, the antenna gain drops to about 0.5 dBic at +50° or 310°. This means that the dBr value is -6. The antenna range is only +50% of the maximum range at + 50° or 310° from the Z axis within the vertical plane (see values shown in blue in the directional radiation pattern: Characteristic of the vertical plane of the antenna (Page 346) and the associated representation of the reference system (Page 346)).

6.8.7

Technical data

Table 6- 46 Technical specifications for the RF680A antenna

6GT2812-2GB08	
Product type designation	SIMATIC RF680A
Radio frequencies	
Operating frequency	865 to 928 MHz
Maximum radiated power	
<ul style="list-style-type: none"> ▪ ETSI 	<ul style="list-style-type: none"> ▪ RF650R: ≤ 1220 mW ERP ▪ RF680R/RF685R: ≤ 2000 mW ERP
<ul style="list-style-type: none"> ▪ FCC 	<ul style="list-style-type: none"> ▪ RF650R: ≤ 2000 mW EIRP ▪ RF680R/RF685R: ≤ 4000 mW EIRP
<ul style="list-style-type: none"> ▪ CMIIT 	<ul style="list-style-type: none"> ▪ RF650R: ≤ 1220 mW ERP ▪ RF680R/RF685R: ≤ 2000 mW ERP
<ul style="list-style-type: none"> ▪ ARIB 	<ul style="list-style-type: none"> ▪ STD-T107: RF650R: ≤ 500 mW EIRP ▪ STD-T108: RF680R/RF685R: < 4000 mW EIRP
Antenna gain	
<ul style="list-style-type: none"> ▪ ETSI 	<ul style="list-style-type: none"> ▪ 3.5 dBi (6.5 dBic)
<ul style="list-style-type: none"> ▪ FCC 	<ul style="list-style-type: none"> ▪ 3.5 dBi (6.5 dBic)
Opening angle for sending/receiving when mounted on a metal surface of 15 cm x 15 cm ¹⁾	
<ul style="list-style-type: none"> ▪ ETSI 	<ul style="list-style-type: none"> ▪ Horizontal plane: 87° ▪ Vertical plane: 80° ▪ see section "Antenna patterns in the ETSI frequency band (Page 346)"
<ul style="list-style-type: none"> ▪ FCC 	<ul style="list-style-type: none"> ▪ Horizontal plane: 90° ▪ Vertical plane: 77° ▪ see section "Antenna patterns in the FCC frequency band (Page 350)"
Front-to-back ratio	
<ul style="list-style-type: none"> ▪ ETSI 	<ul style="list-style-type: none"> ▪ 14 dB \pm 4 dB ▪ (depends on orientation of the transponder)
<ul style="list-style-type: none"> ▪ FCC 	<ul style="list-style-type: none"> ▪ 14 dB \pm 4 dB ▪ (depends on orientation of the transponder)

6GT2812-2GB08

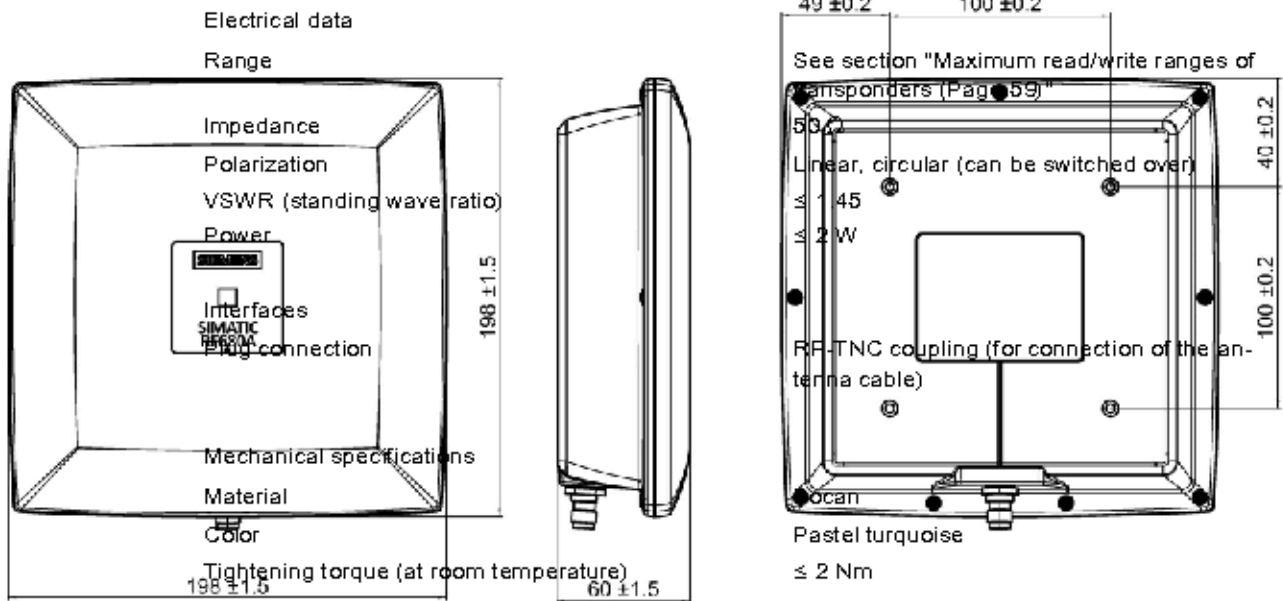

Permitted ambient conditions	
Ambient temperature	
▪ During operation	▪ -25 ... +75 °C
▪ During transportation and storage	▪ -40 ... +85 °C
Degree of protection	IP65
Shock resistant to EN 60068-2-27	30 g ²⁾
Vibrations according to EN 60068-2-6	10 g ²⁾
Design, dimensions and weight	
Dimensions (H x W x D)	198 x 198 x 60 mm
Weight	690 g
Status display	1 LED
Standards, specifications, approvals	
Proof of suitability	CE (according to RED), FCC (Title 47, Part 15.247), cULus
MTBF	218 years

¹⁾ The values differ for different dimensions/materials of the mounting surface.

²⁾ The values for shock and vibration are maximum values and must not be applied continuously.

6.8.8 Dimension drawing



Figure 6-63 Dimension drawing RF680A

All dimensions in mm



6.8.9 Approvals & certificates

Table 6- 47 6GT2812-2GB08

Labeling	Description
	Conformity with the RED directive 2014/53/EU Conformity with the RoHS directive 2011/65/EU

Table 6- 48 6GT2812-2GB08

Labeling	Description
Federal Communications Commission	FCC CFR 47, Part 15 sections 15.247 Radio Frequency Interference Statement This equipment has been tested and found to comply with the limits for a Class B digital device, pursuant to Part 15 of the FCC Rules. The FCC approval is granted in association with the FCC approval of the following RF600 readers: <ul style="list-style-type: none"> FCC ID: NXW-RF600R2 (for RF650R: 6GT2811-6AB20-1AA0, RF680R: 6GT2811-6AA10-1AA0, RF685R: 6GT2811-6CA10-1AA0)
Industry Canada Radio Standards Specifications	Electromagnetic waves from reader antenna RSS-210 Issue 7, June 2007, Sections 2.2, A8 The approval for Industry Canada is granted in association with the Industry Canada approval of the following RF600 readers: <ul style="list-style-type: none"> IC: 267X-RF600R2, Model RF650R (for 6GT2811-6AB20-1AA0) IC: 267X-RF600R2, Model RF680R (for 6GT2811-6AA10-1AA0) IC: 267X-RF600R2, Model RF685R (for 6GT2811-6CA10-1AA0)
	This product is UL-certified for the USA and Canada. It meets the following safety standard(s): <ul style="list-style-type: none"> UL 60950-1 - Information Technology Equipment Safety - Part 1: General Requirements CSA C22.2 No. 60950 -1 - Safety of Information Technology Equipment UL Report E115352
	KCC Certification Type of equipment: A급 기기 (업무용 방송통신기자재) Class A Equipment (Industrial Broadcasting & Communication Equipment) 이 기기는 업무용(A급) 전자파적합기기로서 판 매자 또는 사용자는 이 점을 주의하시기 바라 며, 가정외의 지역에서 사용하는 것을 목적으로 합니다. This equipment is Industrial (Class A) electromagnetic wave suitability equipment and seller or user should take notice of it, and this equipment is to be used in the places except for home. Certificate of the antenna: MSIP-REI-S49-RF680A

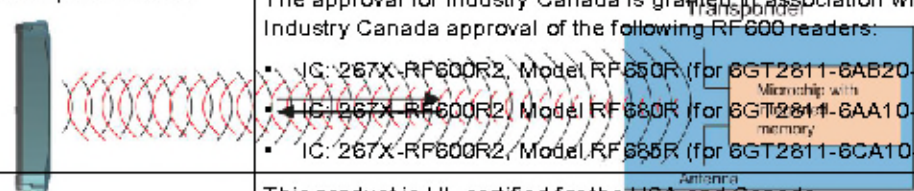

Transponder

7.1 Overview

7.1.1 Mode of operation of transponders

The transponder mainly comprises a microchip with an integrated memory and a dipole antenna.

The principle of operation of a passive RFID transponder is as follows:

- Diversion of some of the high-frequency energy emitted by the reader to supply power to the integrated chip
- Receiving commands from the reader
- Responses are transmitted to the reader antenna by modulating the reflected radio waves (backscatter technique)

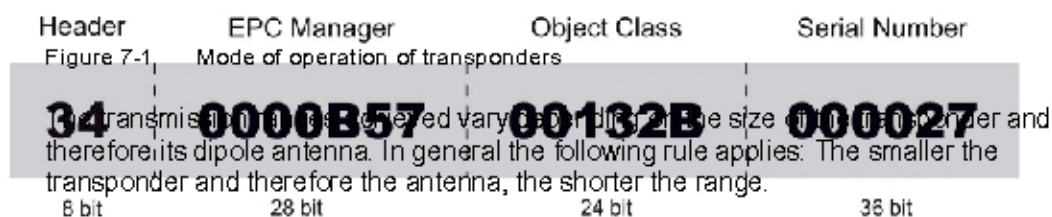

7.1.2 Transponder classes and generations

The transponder classes are distinguished by the different communication protocols used between the reader and transponder. Transponder classes are usually not mutually compatible.

The following transponder classes/protocol types are supported by the RF600 system:

- ISO 18000-62
- ISO 18000-63

Transponders supported

RF600 system supports passive transponders with the following minimum characteristics:

- EPC ID (Electronic Product Code Identifier)
- IID
- A function which permanently ensures that transponders no longer respond.
- After the lock programming can no longer be reprogrammed.

7.1.3 Electronic Product Code (EPC)

The Electronic Product Code (EPC) supports the unique identification of objects (e.g. retail items, logistical items or transport containers). This makes extremely accurate identification possible. In practical use, the EPC is stored on a transponder and scanned by the reader.

There are different EPC number schemes with different data lengths. Below is the structure of a GID-96-bit code (EPC Global Tag Data Standards V1.1 Rev. 1.27):

- Header: identifies the EPC identification number that follows with regard to length, type, structure and version of the EPC
- EPC Manager: identifies the company/corporation
- Object class: Corresponds to the article number
- Serial Number: consecutive number of the article

The Siemens UHF transponders are all suitable for working with EPC and other number schemes. Before a transponder can work with a number scheme, the relevant numbers must first be written to the transponder.

Presetting of the EPC memory of industrial Siemens transponders RF6xxT

The first 12 bytes of the EPC memory ("0x00 - 0x0B") are preset. As of byte 13 ("0x0C") the EPC memory is not preset.

Table 7-1 Presetting of the EPC memory

Address UID	Address with FB (UID)	Value
0x00	0xFF00	0x00
...
0x04	0xFF04	0x00
0x05	0xFF05	Transponder type ¹⁾
0x06	0xFF06	Year produced ¹⁾
0x07	0xFF07	Month produced ¹⁾
0x08	0xFF08	Day produced ¹⁾
0x09	0xFF09	Consecutive number ¹⁾
Bank 0x0A USER	0xFF0A	...
Bank 0x0B UID	0xFF0B	...

¹⁾ In the following table, these values are described in greater detail.
 Note that the RF6xxT transponders cannot be disabled using a kill password.

Table 7-2 Explanation of the values

Transponder type	Year produced	Month produced	Day produced	Consecutive number ¹⁾		
				0x00	0x01	0x02
RF620T = 0x3E	2018 = 0x12	Jan. = 0x01	01 = 0x01	0x00	0x00	0x01
RF625T = 0x8E	2019 = 0x13	Feb. = 0x02	02 = 0x02	0x00	0x00	0x02
RF630T = 0x3F
RF640T = 0x40
RF645T = 0x84
RF680T = 0x44
RF682T = 0x64
...	...	Dec. = 0x0C	31 = 0x1F	0xFF	0xFF	0xFF

¹⁾ The consecutive number is counted absolutely as of the respective production date and is therefore unique.

7.1.4 SIMATIC memory configuration of the RF600 transponders and labels

Special memory configuration of the RF600 transponders and smartlabels

Address spaces of the transponder versions

With the RF600 readers, the user data, TID, EPC and passwords are read out via the relevant memory banks. To read out the required data, the relevant memory bank must be selected.

The table above shows the area and length of the user data ("USER" column). You can read out the EPC-ID using an inventory command. As an alternative, you can also read out the EPC-ID using a Read command to memory bank 1, start address 0x04.

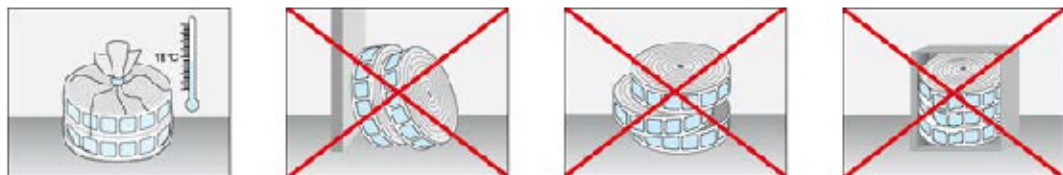

Figure 7-2 Memory configuration

Note

Information on the detailed memory configuration

The memory configuration of the various transponders and smartlabels varies and depends on the chip type used. You will find detailed information of the memory configuration in the data sheets of the chip manufacturer.

Note

Preset EPC ID

The EPC ID of the transponders RF620T to RF680T are preset with a 12 byte long identifier. This identifier is based on a numbering scheme. You will find more information on this in the section "Electronic Product Code (EPC) (Page 360)".

7.1.5 Storage and transportation roll goods

NOTICE
Notes on storage and transportation of rolls
Note the following information on the storage and transportation of rolls:
<ul style="list-style-type: none">• Protect the transponders from direct sunlight and heat (e.g. heating appliances).• Prior to use, store the label rolls in the polyethylene bag or the shrink film of the original packaging.• Store the label rolls in a cool and dry location. Ideal conditions: 18 °C ±5 °C, 40-60 % humidity• Stack several label rolls lying flat and centered one above the other.• Avoid external pressure (e.g. a narrow box).



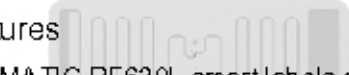
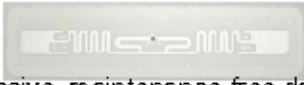

Figure 7-3 Storage of transponders

7.2 SIMATIC RF630L Smartlabel

7.2.1 Features

SIMATIC RF630L smart labels are passive, maintenance-free data carriers based on UHF Class 1 Gen2 technology that are used to store the "Electronic Product Code" (EPC).

Smart labels offer numerous possible uses for a wide range of applications and support efficient logistics throughout the process chain.

Smartlabel SIMATIC RF630L (6GT2810-2AB0x)				
	6GT2810-2AB01-0AX1	6GT2810-2AB02-0AX0	6GT2810-2AB03	6GT2810-2AB04
Product photo				
Area of application	Simple identification such as barcode replacement or supplementation, through warehouse and distribution logistics, right up to product identification.			
EPC memory	32 bytes / 256 bits	12 ... 16 bytes / 96 ... 128 bits	12 ... 30 bytes / 96 ... 240 bits	32 bytes / 256 bits
User memory	64 bytes / 512 bits	64 bytes / 512 bits	64 bytes / 512 bits	64 bytes / 512 bits
Read range	max. 4 m ¹⁾	Max. 5 m ¹⁾		max. 4 m ¹⁾
Mounting	Self-adhesive, for attaching to plastic surfaces.	Self-adhesive, for example for attaching to packaging units, paper or cartons		
	Not suitable for fixing straight onto metal or onto liquid containers			

¹⁾ Depending on the environment, the reader/the antennas and the set power

Smartlabel SIMATIC RF630L (6GT2810-2AC82; 6GT2810-2AE8x)			
	6GT2810-2AC82	6GT2810-2AE80-0AX2	6GT2810-2AE81-0AX1
Product photo			
Area of application	Simple identification such as barcode replacement or supplementation, through warehouse and distribution logistics, right up to product identification.		
EPC memory	16 bytes / 128 bits	12 ... 60 bytes / 96 ... 480 bits ¹⁾	16 bytes / 128 bits
User memory	16 bytes / 128 bits	16 ... 64 bytes / 128 ... 512 bits ¹⁾	--
Read range	max. 3.5 m ²⁾	max. 4 m ²⁾	
Mounting	Self-adhesive, for attaching to plastic surfaces.		
	Not suitable for fixing straight onto metal or onto liquid containers		

¹⁾ The EPC memory has a default size of 96 bits. If necessary, the EPC memory size can be expanded to 480 bits in increments of 16 bits at the cost of the user memory.

²⁾ Depending on the environment, the reader/the antennas and the configured power

7.2.2 Ordering data

Table 7-3 Ordering data RF630L

Product	Article number
SIMATIC RF630L ¹⁾ Smartlabel 101.6 × 50.8 mm	6GT2810-2AB01-0AX1
SIMATIC RF630L ²⁾ Smartlabel 97 × 27 mm	6GT2810-2AB02-0AX0
SIMATIC RF630L ³⁾ Smartlabel 54 × 34 mm	6GT2810-2AB03
SIMATIC RF630L ³⁾ Smartlabel 74 × 27 mm	6GT2810-2AB04
SIMATIC RF630L ⁴⁾ Smartlabel 45 × 20 mm	6GT2810-2AC82
SIMATIC RF630L ⁵⁾ Smartlabel 105 × 25 mm	6GT2810-2AE80-0AX2
SIMATIC RF630L ⁶⁾ Smartlabel 90 × 30 mm	6GT2810-2AE81-0AX1

Delivery format

SIMATIC RF630L smart label is supplied in the following form:

- ~~1) 4 000 Smartlabels per packaging unit: 1 000 labels on a roll~~
Minimum order quantity: 1 packaging unit (4 000 units)
- ~~2) 5 000 smart labels per packaging unit: 5 000 labels on one roll~~
Minimum order quantity: 1 packaging unit (5 000 units)
- ~~3) 2 000 Smartlabels per packaging unit: 2 000 labels on one roll~~
Minimum order quantity: 1 packaging unit (2 000 units)
- ~~4) 10 000 Smartlabels per packaging unit: 2 500 labels on a roll~~
Minimum order quantity: 1 packaging unit (10 000 units)
- ~~5) 5 000 Smartlabels per packaging unit: 1 000 labels on a roll~~
Minimum order quantity: 5 packaging unit (5 000 units)
- ~~6) 7 000 Smartlabels per packaging unit: 3 500 labels on a roll~~
Minimum order quantity: 1 packaging unit (7 000 units)

7.2.3 Technical data

Table 7- 4 Technical specifications of the transponder SIMATIC RF630L

	6GT2810-2AB01-0AX1	6GT2810-2AB02-0AX0
Product type designation	SIMATIC RF630L	
Radio frequencies		
Operating frequency	860 to 960 MHz	
Memory		
Chip (manufacturer/type)	NXP / G2IM	IMPINJ / MONZA 4QT
Memory type	EEPROM	
Memory configuration		
▪ EPC	▪ 32 bytes / 256 bits	▪ 12 ... 16 bytes / 96 ... 128 bits
▪ User memory	▪ 64 bytes / 512 bits	▪ 64 bytes / 512 bits
▪ TID	▪ 12 bytes / 96 bits	▪ 4 bytes / 32 bits
Number of write cycles (< 40 °C)	> 10 ⁵	
Number of read cycles (< 40 °C)	> 10 ¹⁴	
Data retention time (< 40 °C)	30 years	

	6GT2810-2AB01-0AX1	6GT2810-2AB02-0AX0
Electrical data		
Range	≤ 4 m ¹⁾	≤ 5 m ¹⁾
Protocol	ISO 18000-63	
Transmission speed	≤ 320 kbps	
Polarization	Linear	
Multitag capability	Yes	
Mechanical specifications		
Material	Paper	
Silicone-free	Yes	
Color	White	
Antenna material	Aluminum	
Type of antenna	Shortened dipole	
Printing	Can be printed using heat transfer technique	
Roll core diameter	76 mm	
Roll outer diameter	≤ 120 mm	
Permitted ambient conditions		
Ambient temperature		
▪ In operation, during write/read access	▪ -25 ... +65 °C	▪ -40 ... +65 °C
▪ In operation, outside write/read access	▪ -25 ... +80 °C	▪ -40 ... +80 °C
▪ During transportation and storage	▪ +15 ... +25 °C ²⁾	
Distance from metal	Not suitable for mounting directly on metal	
Degree of protection	IP67 (when adhered)	
Resistance to mechanical stress	Torsion and bending stress conditionally permissible	
Design, dimensions and weight		
Dimensions (L x W x D)	101.6 x 50.8 x 0.3 mm	27 x 97 x 0.3 mm
Weight	1 g	
¹⁾ The information relates to the maximum read range. You will find more information on ranges in the section "Minimum distances and maximum ranges (Page 55)".		
²⁾ For more information, refer to the section "Storage and transportation roll goods (Page 363)".		

Table 7- 5 Technical specifications of the transponder SIMATIC RF630L

	6GT2810-2AB03	6GT2810-2AB04
Product type designation	SIMATIC RF630L	
Radio frequencies		
Operating frequency	860 to 960 MHz	
Memory		
Chip (manufacturer/type)	NXP / G2XM	NXP / G2IM
Memory type	EEPROM	
Memory configuration		
▪ EPC	▪ 12 ... 30 bytes / 96 ... 240 bits	▪ 32 bytes / 256 bits
▪ User memory	▪ 64 bytes / 512 bits	▪ 64 bytes / 512 bits
▪ TID	▪ 8 bytes / 64 bits	▪ 12 bytes / 96 bits
Number of write cycles (< 40 °C)	> 10 ⁶	
Number of read cycles (< 40 °C)	> 10 ¹⁴	
Data retention time (< 40 °C)	10 years	30 years
Electrical data		
Range	≤ 5 m ¹⁾	≤ 4 m ¹⁾
Protocol	ISO 18000-63	
Transmission speed	≤ 320 kbps	
Polarization	Linear	
Multitag capability	Yes	
Mechanical specifications		
Material	Paper	PET
Silicone-free	Yes	
Color	White	
Antenna material	Aluminum	
Type of antenna	Shortened dipole	
Printing	Can be printed using heat transfer technique	
Roll core diameter	76 mm	
Roll outer diameter	≤ 120 mm	

	6GT2810-2AB03	6GT2810-2AB04
Permitted ambient conditions		
Ambient temperature		
▪ In operation, during write/read access	▪ -40 ... +65 °C	▪ -20 ... +65 °C
▪ In operation, outside write/read access	▪ -40 ... +80 °C	▪ -20 ... +85 °C
▪ During transportation and storage	▪ +15 ... +25 °C ²⁾	
Distance from metal	Not suitable for mounting directly on metal	
Degree of protection	IP67 (when adhered)	
Resistance to mechanical stress	Torsion and bending stress conditionally permissible	
Design, dimensions and weight		
Dimensions (L x W x D)	34 x 54 x 0.3 mm	74 x 27 x 0.3 mm
Weight	1 g	

¹⁾ The information relates to the maximum read range. You can find more information on ranges in the section "Minimum distances and maximum ranges (Page 55)".

²⁾ For more information, refer to the section "Storage and transportation roll goods (Page 363)".

Table 7- 6 Technical specifications of the transponder SIMATIC RF630L

		6GT2810-2AC&2
Product type designation		SIMATIC RF630L
Radio frequencies		
Operating frequency		860 to 960 MHz
Memory		
Chip (manufacturer/type)		Alien / Higgs4
Memory type		EEPROM
Memory configuration		
▪ EPC		▪ 16 bytes / 128 bits ¹⁾
▪ User memory		▪ 16 bytes / 128 bits
▪ TID		▪ 24 bytes / 192 bits
Number of write cycles (22 °C)		> 10 000; at least 1 000
Number of read cycles (22 °C)		> 10 ¹⁴
Data retention time (< 55 °C)		50 years
Electrical data		
Range		max. 3.5 m ²⁾
Protocol		ISO 18000-63
Transmission speed		≤ 320 Kbps
Polarization		Linear
Mechanical specifications		
Material		PET
Silicone-free		Yes
Color		White
Antenna material		Aluminum
Type of antenna		Compressed dipole
Printing		Can be printed using heat transfer technique
Roll core diameter		76.2 mm
Roll outer diameter		170 (±3) mm

6GT2810-2AC82

Permitted ambient conditions	
Ambient temperature	
<ul style="list-style-type: none"> ▪ In operation, during write/read access 	<ul style="list-style-type: none"> ▪ -25 ... +85 °C
<ul style="list-style-type: none"> ▪ In operation, outside write/read access 	<ul style="list-style-type: none"> ▪ -25 ... +85 °C <p style="margin-left: 20px;">Special feature: 1 hour at +95 °C</p>
<ul style="list-style-type: none"> ▪ During transportation and storage 	<ul style="list-style-type: none"> ▪ +5 ... +25 °C ³⁾
Distance from metal	Not suitable for mounting directly on metal
Degree of protection	IP 67 ⁴⁾
Resistance to mechanical stress	Torsion and bending stress conditionally permissible
Design, dimensions and weight	
Dimensions (L x W x D)	45 (±0.5) × 20 (±0.5) x 0.3 mm
Weight	Approx. 0.5 g
<p>¹⁾ The EPC-ID has different IDs preset.</p> <p>²⁾ The information relates to the maximum read range. You can find more information on ranges in the section "Minimum distances and maximum ranges (Page 55)".</p> <p>³⁾ For more information, refer to the section "Storage and transportation roll goods (Page 363)".</p> <p>⁴⁾ When affixed and if the ambient conditions are adhered to (operating temperature -25 ... +85 °C).</p>	

Table 7- 7 Technical specifications of the transponder SIMATIC RF630L

	6GT2810-2AE80-0AX2	6GT2810-2AE81-0AX1
Product type designation	SIMATIC RF630L	
Radio frequencies		
Operating frequency	860 to 960 MHz	
Memory		
Chip (manufacturer/type)	Alien / Higgs3	NXP / G2iL
Memory type		
Memory configuration		
▪ EPC	▪ 12 ... 60 bytes / 96 ... 480 bits ¹⁾	▪ 16 bytes / 128 bits
▪ User memory	▪ 16 ... 64 bytes / 128 ... 512 bits ¹⁾	▪ --
▪ TID	▪ 4 bits / 32 Byte	▪ 8 bytes / 64 bits
Number of write cycles (22 °C)	> 100 000	
Number of read cycles (22 °C)	unlimited	
Data retention time (< 55 °C)	30 years	
Electrical data		
Range	≤ 4 m ²⁾	
Protocol	ISO 18000-63	
Transmission speed	≤ 320 Kbps	
Polarization	Linear	
Mechanical specifications		
Material	PET	
Silicone-free	Yes	
Color	White	
Antenna material	Aluminum	
Type of antenna	ALN-9640 "Squiggle®"	Belt inlay
Printing	Can be printed using heat transfer technique	
Roll core diameter	76.2 mm	76.4 mm
Roll outer diameter	110 mm	200 (±3) mm
Winding direction	Wound to the outside	

6GT2810-2AE80-0AX2 6GT2810-2AE81-0AX1

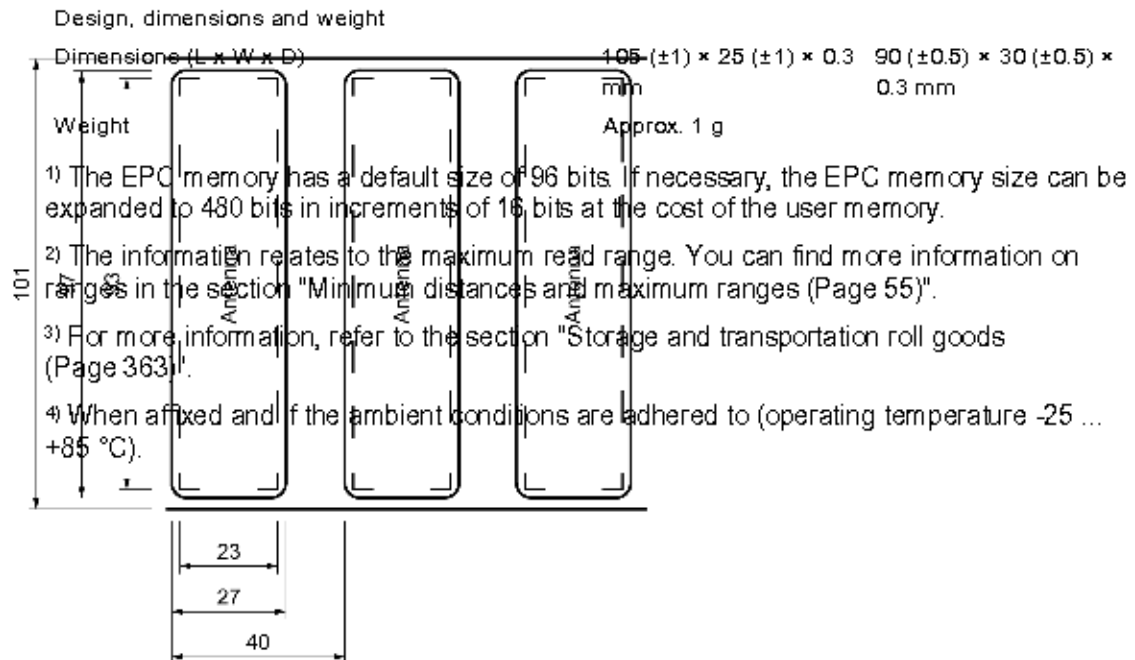
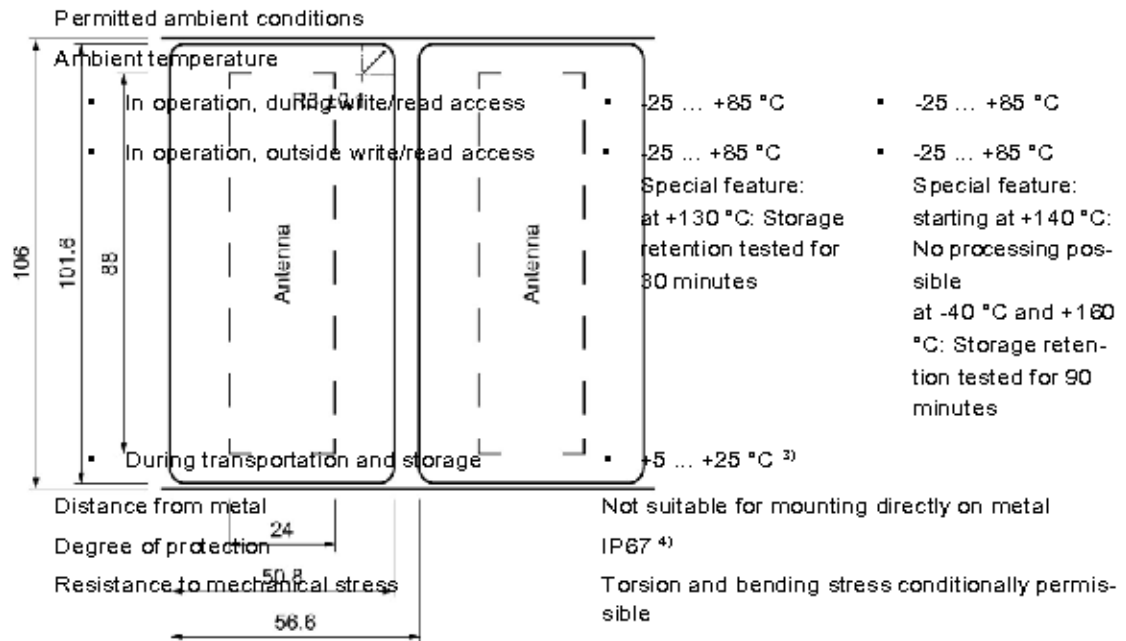

7.2.4

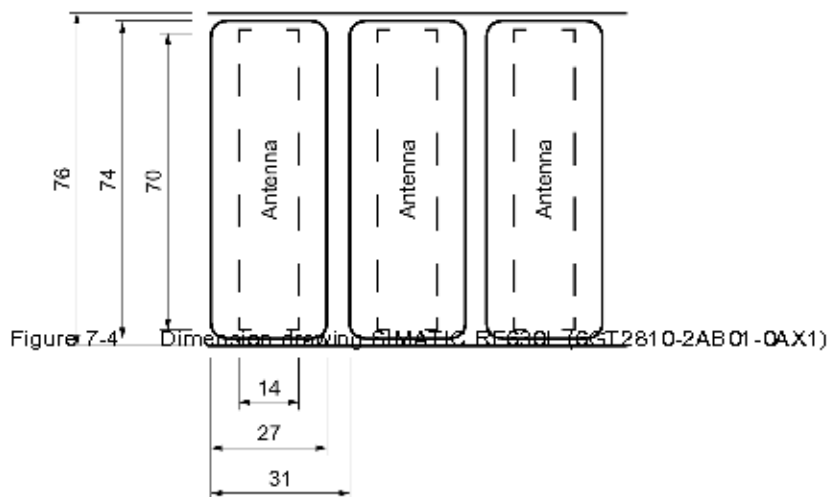
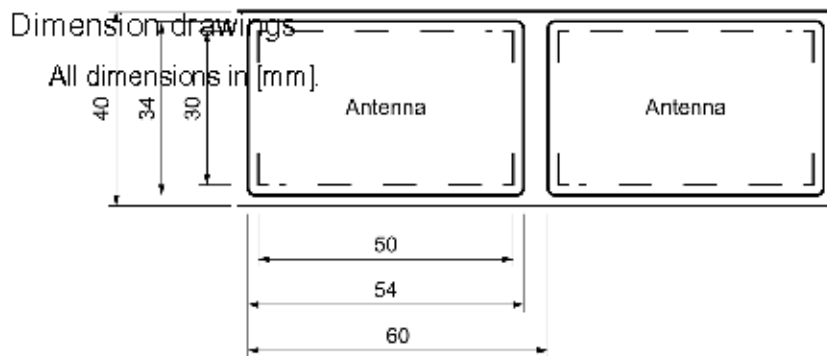

Figure 7-5 Dimension drawing SIMATIC RF630L (6GT2810-2AB02-0AX0)

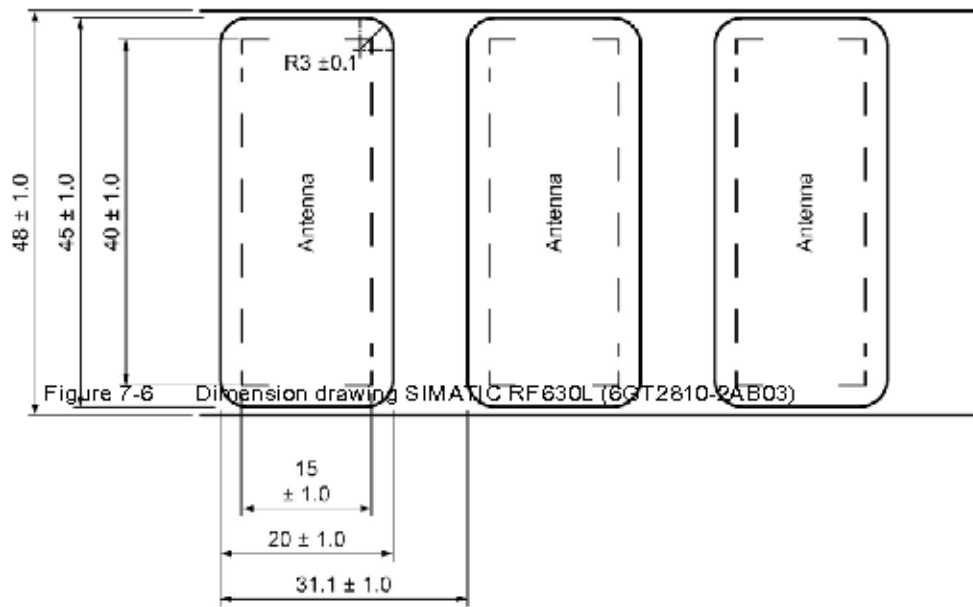

Figure 7-6 Dimension drawing SIMATIC RF630L (6GT2810-2AB03)

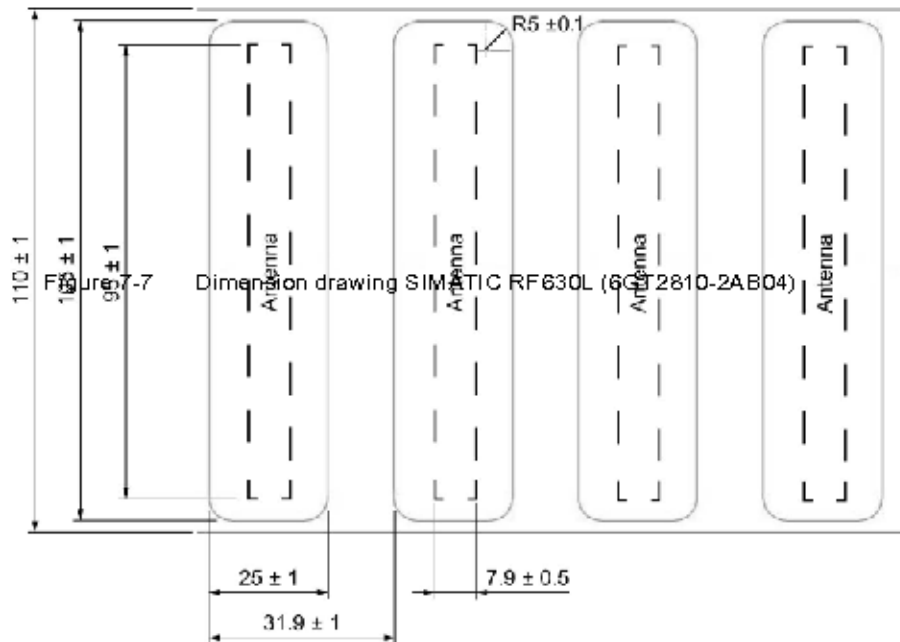

Figure 7-7 Dimension drawing SIMATIC RF630L (6GT2810-2AB04)

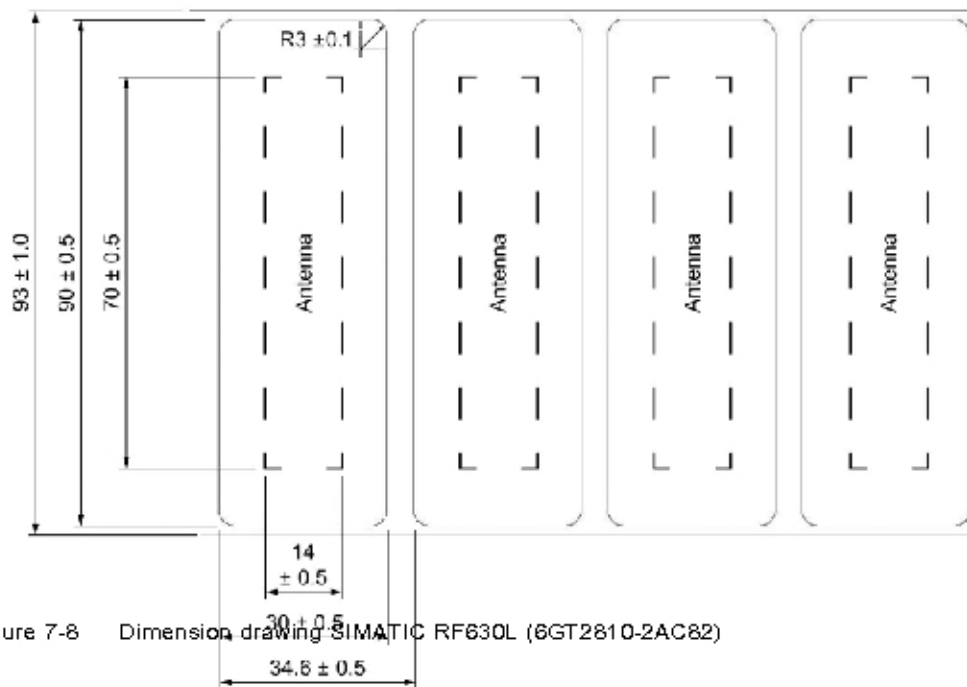

Figure 7-8 Dimension drawing SIMATIC RF630L (6GT2810-2AC82)



Figure 7-9 Dimension drawing SIMATIC RF630L (6GT2810-2AE 80-0A.X2)



Figure 7-10 Dimension drawing SIMATIC RF630L (8GT2810-2AE81-0AX1)

7.2.5 Certificates and approvals

Certificate	Description
	Conformity with the RED directive 2014/53/EU Conformity with the RoHS directive 2011/65/EU
Federal Communications Commission	Passive labels and transponders comply with the valid regulations; certification is not required.

7.3 SIMATIC RF642L Smartlabel

7.3.1 Features

The SIMATIC RF642L Smartlabel is a passive and maintenance-free data carrier. The Smartlabel operates based on UHF Class 1 Gen 2 technology and is used to save the "Electronic Product Code" (EPC) up to 448 bits. The transponder also has 2048 bits of user memory.

The SIMATIC RF642L is designed for direct mounting on metal surfaces. When used on non-metallic surfaces, the reading range can be reduced by up to 70 %.

SIMATIC RF642L Smartlabel	Characteristics	
	Area of application	Industrial plant management, identification of tools, containers and metallic equipment.
	Frequency range	<ul style="list-style-type: none"> ▪ ETSI: 865 to 868 MHz ▪ FCC: 902 to 928 MHz
	Air interface	According to ISO 18000-63
	Memory	<ul style="list-style-type: none"> ▪ EPC: 56 bytes / 448 bits ▪ User memory: 256 bytes / 2048 bits
	Read range	Max. 2.8 m on metal ¹⁾
	Mounting	Self-adhesive Designed for mounting directly on metal

¹⁾ Depending on the environment, the employed reader/the antennas and the set power

7.3.2 Ordering data

Table 7-8 RF642L ordering data

Product	Article number
SIMATIC RF642L (ETSI)	6GT2810-3AC00
SIMATIC RF642L (FCC)	6GT2810-3AC10

Delivery form

SIMATIC RF642L Smartlabel is delivered in the following form:

- 500 Smartlabels per packaging unit: 500 labels on one roll
Minimum order quantity: 1 packaging unit (500 units)
- The Smartlabels have a unique 12-byte EPC ID.

7.3.3 Technical specifications

Table 7- 9 Technical specifications of the SIMATIC RF642L transponder

6GT2810-3ACx0	
Product type designation	SIMATIC RF642L
Radio frequencies	
Operating frequency	
▪ ETSI	▪ 865 to 868 MHz
▪ FCC	▪ 902 to 928 MHz
Memory	
Chip (manufacturer/type)	NXP / UCODE 7xm-2k
Memory type	EEPROM
Memory configuration	
▪ EPC	▪ 56 bytes / 448 bits
▪ User memory	▪ 256 bytes / 2048 bits
▪ TID	▪ 12 bytes / 96 bits
Number of write cycles (< 40 °C)	> 10 ⁵
Number of read cycles (< 40 °C)	> 10 ¹⁴
Data retention time (< 40 °C)	50 years
Electrical data	
Range	
▪ Writing	▪ ≤ 0.9 m
▪ Reading	▪ ≤ 2.8 m
Protocol	ISO 18000-63
Transmission speed	≤ 320 kbps
Polarization	Linear
Mechanical specifications	
Material	PET, PE
Silicone-free	Yes
Color	White
Antenna material	Aluminum
Type of antenna	Shortened dipole
Printing	Can be printed using heat transfer technique
Roll core diameter	76 mm
Roll outer diameter	≤ 200 mm

6GT2810-3ACx0

Permitted ambient conditions

Ambient temperature

- In operation, during write/read access
- In operation, outside write/read access
- During transportation and storage

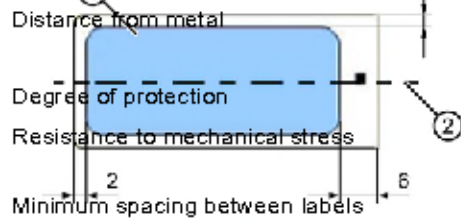

Degree of protection

Resistance to mechanical stress

Minimum spacing between labels

- Vertically
- Horizontally

Design, dimensions and weight

Dimensions (L x W x D)

Weight

- 1) Ideal storage conditions
 2) Water depth 1 m for max. 5 hours

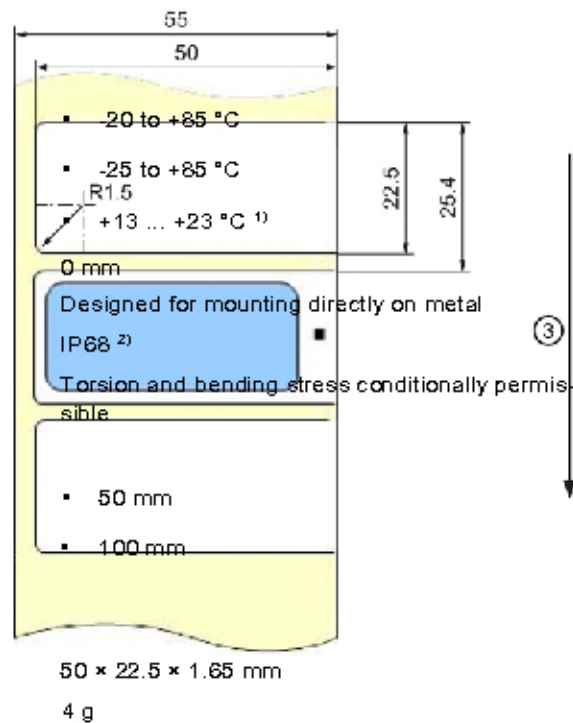

50 × 22.5 × 1.65 mm

4 g

7.3.4 Dimension drawing



- ① Printable area
- ② Polarization axis
- ③ Conveyor direction

Figure 7-11 Dimension drawing RF642L

All dimensions in mm

7.4 SIMATIC RF690L Smartlabel

7.4.1 Characteristics

The SIMATIC RF690L High Temp Smartlabel is a passive and maintenance-free data carrier. It operates based on the UHF Class 1 Gen 2 technology and is used to store the "Electronic Product Code" (EPC). The transponder also has a user memory.

The SIMATIC RF690L can also be mounted on metal.

Smartlabel SIMATIC RF690L	Characteristics	
	Area of application	Heat-proof UHF label for a wide range of possible applications, for example, on metal or with high temperatures up to +160 °C
	Frequency range	<ul style="list-style-type: none"> ▪ ETSI: 865 to 868 MHz ▪ FCC: 902 to 928 MHz
	Air interface	According to ISO 18000-63
	Memory	<ul style="list-style-type: none"> ▪ EPC: 8 ... 60 bytes / 64 ... 480 bits ¹⁾ ▪ User memory: 16 ... 64 bytes / 128 ... 512 bits ¹⁾
	Read range	<ul style="list-style-type: none"> ▪ Max. 5.0 m on non-metallic surface ²⁾ ▪ Max. 2.4 m on metal ²⁾
	Mounting	Self-adhesive Suitable for mounting directly on metal.

¹⁾ The EPC memory has a default size of 96 bits. When necessary, the EPC memory size can be expanded to 480 bits in steps of 16 bits at the cost of the user memory.

²⁾ Depending on the environment, the employed reader/the antennas and the set power

7.4.2 Ordering data

Table 7- 10 Ordering data RF690L

Product	Article number
SIMATIC RF690L (ETSI)	6GT2810-2AG00
SIMATIC RF690L (FCC)	6GT2810-2AG10

Delivery format

SIMATIC RF690L smartlabel is supplied in the following form:

- 400 smart labels per packaging unit 400 labels on one roll

Minimum order quantity: 1 packaging unit (400 units)

7.4.3 Memory organization

Transponders with an "Alien Higgs 3" chip have an EPC memory with a standard size of 96 Bits (12 bytes). When necessary, the EPC memory size can be expanded to 480 bits (60 bytes) in steps of 16 bits at the cost of the user memory.

The following table shows how many bytes can be added to the EPC memory and how this affects the size of the user memory.

Table 7- 11 Size of the EPC memory and effect on the user memory

EPC memory		User memory
[bytes]	[bits]	[bytes]
54 ... 60	432 ... 480	16
46 ... 52	368 ... 416	24
38 ... 44	304 ... 352	32
30 ... 36	240 ... 288	40
22 ... 28	176 ... 224	48
14 ... 20	112 ... 160	56
0 ... 12	0 ... 96	64

7.4.4 Technical specifications

Table 7- 12 Technical specifications of the transponder SIMATIC RF690L

6GT 2810-2AGx0	
Product type designation	SIMATIC RF690L
Radio frequencies	
Operating frequency	
<ul style="list-style-type: none"> ▪ ETSI ▪ FCC 	<ul style="list-style-type: none"> ▪ 865 to 868 MHz ▪ 902 to 928 MHz
Memory	
Chip (manufacturer/type)	Alien / Higgs 3
Memory type	EEPROM
Memory configuration	
<ul style="list-style-type: none"> ▪ EPC ▪ User memory ▪ TID ▪ Unique TID ▪ TID device configuration 	<ul style="list-style-type: none"> ▪ 8 ... 60 bytes / 64 ... 480 bits¹⁾ ▪ 16 ... 64 bytes / 128 ... 512 bits¹⁾ ▪ 4 bytes / 32 bits ▪ 8 bytes / 64 bits ▪ 12 bytes / 96 bits

		6GT2810-2AGx0
Number of write cycles (< 40 °C)		> 500
Number of read cycles (< 40 °C)		> 10 ¹⁴
Data retention time (< 40 °C)		50 years
Electrical data		
Range		
▪ Writing		▪ ??? m
▪ Reading		▪ ≤ 5.0 m ²⁾
Protocol		EPCglobal Class 1 Gen 2 / ISO 18000-63
Polarization		Linear
Mechanical specifications		
Material		PET
Silicone-free		Yes
Color		Beige/silver
Antenna material		Aluminum
Type of antenna		Shortened dipole
	100	
Printing	88	Can be printed using heat transfer technique
Roll core diameter		76 mm
Roll outer diameter		200 mm
Permitted ambient conditions		
Ambient temperature		
▪ In operation, during write/read access	R3	▪ 25 ... +85 °C
▪ In operation, outside write/read access		▪ -25 to +95 °C permanently
		Special features: As of 100 °C 20% reduction of the write/read distance +140 ... +160 °C: No processing possible
▪ During transportation and storage		▪ +13 ... +23 °C ³⁾
Distance from metal		0 mm
		Suitable for mounting directly on metal
Degree of protection		IP67
Resistance to mechanical stress		Torsion and bending stress conditionally permissible

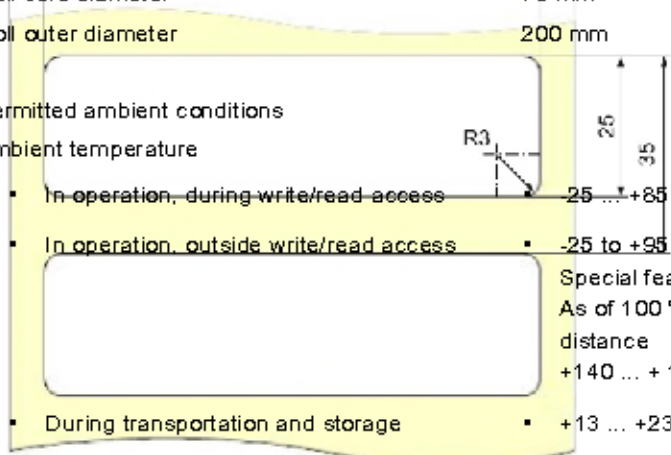

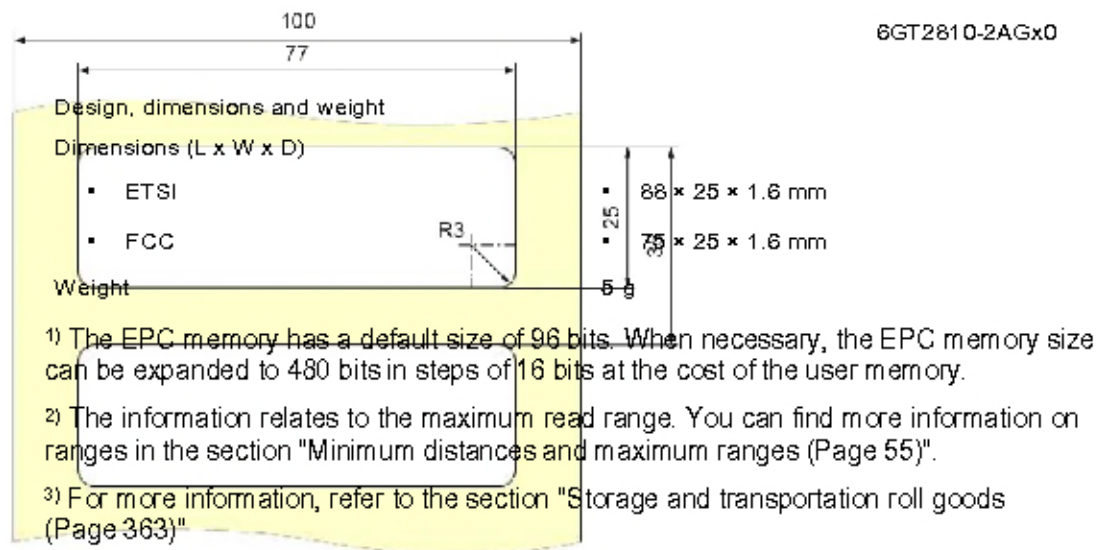

7.4.5 Dimension drawing



Figure 7-12 Dimension drawing RF690L (ETSI, article number: 6GT2810-2AG00)

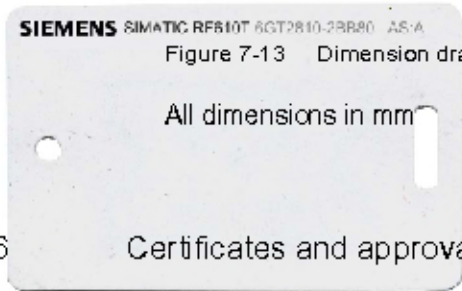

Figure 7-13 Dimension drawing RF690L (FCC, article number: 6GT2810-2AG10)

All dimensions in mm

7.4.6 Certificates and approvals

Certificate	Description
	Conformity with the RED directive 2014/53/EU Conformity with the RoHS directive 2011/65/EU
Federal Communications Commission	Passive labels and transponders comply with the valid regulations; certification is not required.

7.5 SIMATIC RF610T

7.5.1 Features

The SIMATIC RF610T is passive and maintenance-free. It operates based on the UHF Class 1 Gen 2 technology and is used for saving the electronic product code (EPC) of 96 bits / 240 bits. The label also has a 512 bit user memory.

The SIMATIC RF610T offers a host of possible uses for a wide range of applications and supports efficient logistics throughout the entire process chain.

~~Thanks to its antenna geometry, the transponder can be read from any direction. However, the range is reduced if it is not aligned in parallel with the antenna.~~

SIMATIC RF610T	Characteristics	
	Area of application	<ul style="list-style-type: none"> ▪ Simple identification, such as barcode replacement or barcode supplement ▪ Warehouse and distribution logistics ▪ Product identification <p><i>For the Food & Beverage sector, a special version can be supplied on request that is certified for use in contact with food.</i></p>
	Air interface	According to ISO 18000-63
	Memory	<ul style="list-style-type: none"> ▪ EPC: 96 ... 240 bits ▪ User memory: 64 bytes
	Read range	Max. 5 m ¹⁾
	Mounting	<ul style="list-style-type: none"> ▪ Suspended by means of cable ties, or similar ▪ Can also be fixed with screws or glued by customer. ▪ Not suitable for mounting straight onto metal.

¹⁾ Depending on the environment, the reader/the antennas and the set power

7.5.2 Ordering data

Table 7-13 Ordering data RF610T

Product	Article number
SIMATIC RF610T	6GT2810-2BB80

Delivery format

SIMATIC RF610T is supplied in the following form:

- 500 transponders per packaging unit

Minimum order quantity: 1 packaging unit (500 units)

7.5.3 Technical specifications

Table 7- 14 Technical specifications of the transponder SIMATIC RF610T

6GT2810-2BB80	
Product type designation	SIMATIC RF610T
Radio frequencies	
Operating frequency	
▪ ETSI	▪ 865 to 868 MHz
▪ FCC	▪ 902 to 928 MHz
Memory	
Chip (manufacturer/type)	NXP / G2XM
Memory type	EEPROM
Memory configuration	
▪ EPC	▪ 12 ... 30 bytes / 96 ... 240 bits
▪ User memory	▪ 64 bytes / 512 bits
▪ TID	▪ 8 bytes / 64 bits
▪ Reserved (passwords)	▪ 8 bytes / 64 bits
Number of write cycles (< 40 °C)	> 10 ⁵
Number of read cycles (< 40 °C)	> 10 ¹⁴
Data retention time (< 40 °C)	10 years
Electrical data	
Range	≤ 5 m ¹⁾
Protocol	ISO 18000-63
Transmission speed	≤ 320 kbps
Polarization	Linear

6GT2810-2BB80

Mechanical specifications	
Material	PVC
Silicone-free	Yes
Color	White
Antenna material	Aluminum
Type of antenna	Shortened dipole
Printing	Can be printed using heat transfer technique
Permitted ambient conditions	
Ambient temperature	
▪ In operation, during write/read access	▪ -25 ... +85 °C
▪ In operation, outside write/read access	▪ -40 ... +85 °C
▪ During transportation and storage	▪ -40 ... +85 °C
Distance from metal	Not suitable for mounting directly on metal
Degree of protection	IP 67
Resistance to mechanical stress	Torsion and bending stress conditionally permissible
Shock-resistant according to DIN EN 60721-3-7, Class 7 M3	100 g ²⁾
Vibration to EN 60068-2-6	50 g ²⁾
Design, dimensions and weight	
Dimensions (L x W x D)	86 × 54 × 0.6 mm
Weight	3 g



¹⁾ The information relates to the maximum read range. You will find more information on ranges in the section "Minimum distances and maximum ranges (Page 55)".

²⁾ The values for shock and vibration are maximum values and must not be applied continuously.



C Effects of temperatures > 70 °C

Note that in temperature ranges > 70 °C, the transponder can become slightly deformed. However, this has no effect on the transponder function.

7.5.4 Dimension drawing

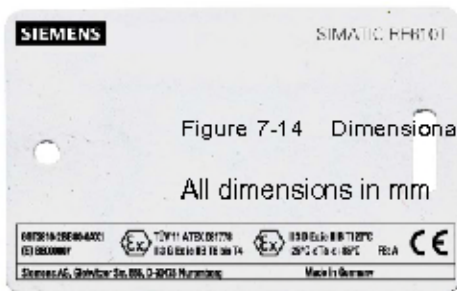

7.5.5 Certificates and approvals

Certificate	Description
	Conformity with the RED directive 2014/53/EU Conformity with the RoHS directive 2011/65/EU
Federal Communications Commission	Passive labels and transponders comply with the valid regulations; certification is not required.
	This product is UL-certified for the USA and Canada. It meets the following safety standard(s): <ul style="list-style-type: none"> ▪ UL508 - Industrial Control Equipment ▪ CSA C22.2 No. 142 - Process Control Equipment ▪ UL Report E 120869

7.6 SIMATIC RF610T ATEX

7.6.1 Features

The SIMATIC RF610T special variant ATEX is passive and maintenance-free. It operates based on the UHF Class 1 Gen 2 technology and is used for saving the electronic product code (EPC) of 96 bits / 240 bits. The label also has a 512 bit user memory.

The SIMATIC RF610T special variant ATEX provides numerous possible uses for a wide range of applications and allows efficient logistics throughout the entire process chain.

Thanks to its antenna geometry, the transponder can be read from any direction. However, the range is reduced if it is not aligned in parallel with the antenna.

SIMATIC RF610T	Characteristics	
	Area of application	<ul style="list-style-type: none"> ▪ Simple identification, such as barcode replacement or barcode supplement ▪ Warehouse and distribution logistics ▪ Product identification
		For the Food & Beverage sector, a special version can be supplied on request that is certified for use in contact with food.
	Air interface	According to ISO 18000-63
	Memory	<ul style="list-style-type: none"> ▪ EPC: 96 ... 240 bits ▪ User memory: 64 bytes
	Read range	Max. 5 m ¹⁾
	Mounting	<ul style="list-style-type: none"> ▪ Suspended by means of cable ties, or similar ▪ Can also be fixed with screws or glued by customer. ▪ Not suitable for mounting straight onto metal.

¹⁾ Depending on the environment, the reader/the antennas and the set power



7.6.2 Ordering data

Table SIEMENS Ordering data RF610T ATEX SIMATIC RF610T	
Product	Article number
SIMATIC RF610T ATEX	6GT2810-2B B80-OAX1

Delivery format

SIMATIC RF610T ATEX is supplied in the following form:

- 500 transponders per packaging unit
- Minimum order quantity: 1 packaging unit (= 500 units)

NOTICE

Approved use

This device/system may only be used for the applications described in the catalog and the technical documentation "System manual SIMATIC RF600 (<https://support.industry.siemens.com/cs/ww/en/ps/15069/man>)" and only in combination with third-party devices and components recommended and/or approved by Siemens.

7.6.3 Use of the transponder in hazardous areas

In a conformity declaration, TÜV NORD CERT GmbH has confirmed compliance with the essential health and safety requirements relating to the design and construction of equipment and protective systems intended for use in hazardous areas as per Annex II of the directive 2014/34/EU.

The essential health and safety requirements are satisfied in accordance with standards EN 6079-0: 2012 + A11: 2013, EN 60079-11: 2012.

This allows the RF610T special variant ATEX transponder to be used in hazardous areas for gases, for the device category 3 G and gas group IIB, or alternatively in hazardous areas for dusts, for the device category 3 D and group IIIB.

 WARNING
Ignitions of gas-air mixtures or dust-air mixtures
The SIMATIC RF610T transponder must be set up and maintained in such a way that electrostatic discharges are excluded.
The SIMATIC RF610T transponder may not be installed in areas influenced by processes that generate high electrostatic charges.

Identification and warning on the transponder

Figure 7-15 Schematic representation of the SIMATIC RF610T ATEX transponder

The labeling of the front of the transponder shown above is an example and can vary between batches produced at different times.

 This does not affect the hazardous area marking.

Order number and serial number

6GT2810-2BB80-0AX1 / (S) B0000007

Identification



TÜV 11 ATEX 081778 X
II 3 G Ex ic IIB T6/T5/T4 Gc

II 3 D Ex ic IIIB T₅ 120°C Dc,
-25 °C < Ta < +85 °C

Warning

WARNING
WARNING POTENTIAL ELECTROSTATIC CHARGING HAZARD-SEE INSTRUCTIONS

Manufacturer's address - distributor

Siemens AG

DE-76181 Karlsruhe

7.6.3.1 Use of the transponder in hazardous areas for gases

Temperature class grading for gases with up to 2000 mW ERP

The temperature class of the transponder for hazardous areas depends on the ambient temperature range.

If the radiated power of an antenna radiating into the hazardous area or located in the hazardous area and operating in the 865 - 868 MHz frequency band cannot exceed the value 2000 mW, the temperature class grading is as follows:

Table 7- 16 Temperature class grading for gases

Ambient temperature range	Temperature class
-25 °C to +85 °C	T4
-25 °C to +65 °C	T5
-25 °C to +50 °C	T6

WARNING

Ignitions of gas-air mixtures

When using the RF610T transponder, check to make sure that the temperature class is adhered to in keeping with the requirements of the area of application.

Non-compliance with the permitted temperature ranges while using the transponder can lead to ignitions of gas-air mixtures.

WARNING

Ignitions of gas-air mixtures

The maximum radiated power of the transmitter used to operate the transponder must not exceed 2000 mW ERP.

Non-compliance with the permitted radiated power can lead to ignitions of gas-air mixtures.

7.6.3.2 Use of the transponder in hazardous areas for dusts

The equipment is suitable for dusts whose ignition temperatures for a dust layer of 5 mm are higher than 210 °C (smoldering temperature). The ignition temperature specified here according to EN 60079-0: 2012 + A11: 2013 for ignition protection type ic in this case references the smoldering temperature of a layer of combustible flyings (ic IIIA) or alternatively non-conductive dusts (ic IIIB).

Temperature class grading for dusts with up to 2000 mW ERP

If the radiated power of an antenna radiating into the hazardous area or located in the hazardous area and operating in the 865 - 868 MHz frequency band cannot exceed the value 2000 mW, the temperature class grading is as follows:

Table 7- 17 Temperature class grading for dusts

Ambient temperature range	Temperature value
-25 °C < T _a < +85 °C	T _s 120 °C

WARNING
Ignitions of dust-air mixtures
When using the RF610T transponder, make sure that the temperature values are adhered to in keeping with the requirements of the area of application.
Non-compliance with the permitted temperature ranges while using the transponder can lead to ignitions of dust-air mixtures.

7.6.4 Technical specifications

Table 7- 18 Technical specifications of the transponder SIMATIC RF610T special variant ATEX

6GT2810-2BB80-0AX1	
Product type designation	SIMATIC RF610T special variant ATEX
Radio frequencies	
Operating frequency	
▪ ETSI	▪ 865 to 868 MHz
▪ FCC	▪ 902 to 928 MHz
Memory	
Chip (manufacturer/type)	NXP / G2XM
Memory type	EEPROM
Memory configuration	
▪ EPC	▪ 12 ... 30 bytes / 96 ... 240 bits
▪ User memory	▪ 64 bytes / 512 bits
▪ TID	▪ 8 bytes / 64 bits
▪ Reserved (passwords)	▪ 8 bytes / 64 bits
Number of write cycles (< 40 °C)	> 10 ⁶
Number of read cycles (< 40 °C)	> 10 ¹⁴
Data retention time (< 40 °C)	10 years
Electrical data	
Range	≤ 5 m ¹⁾
Protocol	ISO 18000-63
Transmission speed	≤ 320 kbps
Polarization	Linear
Mechanical specifications	
Material	PVC
Silicone-free	Yes
Color	White
Antenna material	Aluminum
Type of antenna	Shortened dipole
Printing	Can be printed using heat transfer technique

6GT2810-2BB80-0AX1

86	
Permitted ambient conditions	
Ambient temperature	
<ul style="list-style-type: none"> ▪ In operation, write/read access ▪ In operation, outside write/read access ▪ During transportation and storage 	<ul style="list-style-type: none"> ▪ $-25 \dots +85 \text{ }^\circ\text{C}$ ▪ $-40 \dots +85 \text{ }^\circ\text{C}$ ▪ $-40 \dots +85 \text{ }^\circ\text{C}$
Distance from metal	Not suitable for mounting directly on metal
Degree of protection	IP67
Resistance to mechanical stress	Torsion and bending stress conditionally permissible
Shock-resistant according to DIN EN 60721-3-7, Class 7 M3	100 g ²⁾
Vibration to EN 60068-2-6	50 g ²⁾
Design, dimensions and weight	
Dimensions (L x W x D)	86 x 54 x 0.4 mm
Weight	3 g
Standards, specifications, approvals	
Proof of suitability	TÜV 11 ATEX 081778 X (EN 60079-0, EN 60079-11): II 3 G Ex ic IIB T6/T5/T4 Gc, II 3 D Ex ic IIB T _s 120°C Dc, $-25 \text{ }^\circ\text{C} < T_a < +85 \text{ }^\circ\text{C}$ 1712 years



¹⁾ The information relates to the maximum read range. You will find more information on ranges in the section "Minimum distances and maximum ranges (Page 55)".



²⁾ The values for shock and vibration are maximum values and must not be applied continuously.

Note

Effects of temperatures > 70 °C

Note that in temperature ranges > 70 °C, the transponder can become slightly deformed. However, this has no effect on the transponder function.

7.6.5 Dimension drawing

Figure 7-16 Dimension drawing SIMATIC RF610T (special variant ATEX)

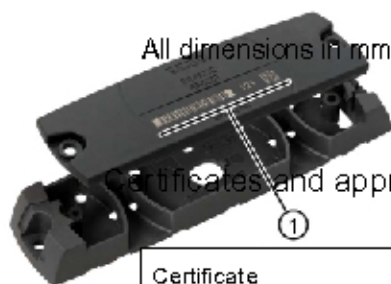

7.6.6 Certificates and approvals

Certificate	Description
	Conformity with the ATEX directive 2014/34/EU based on: Conformity statement no. TÜV 11 ATEX 081778 X Conformity with the RED directive 2014/53/EU Conformity with the RoHS directive 2011/65/EU
Federal Communications Commission	Passive labels and transponders comply with the valid regulations; certification is not required.

7.7 SIMATIC RF620T

7.7.1 Characteristics

The SIMATIC RF620T Transponder is passive and maintenance-free, based on the UHF Class 1 Gen2 technology for storing the 96-bit/128-bit "electronic product code" (EPC).

The transponder also has a 64-byte user memory.

The container tag for industrial applications is rugged and highly resistant to detergents. It is designed for easy attachment onto plastic, wood, glass, e.g. containers, palettes, and trolleys.

The optimum functionality/range of the RF620T on metal is achieved by means of the spacer. Since the plastic is food safe, it is also suitable for use in the food-processing industry.

This container tag is designed for the frequency range of 860 MHz to 960 MHz and can be operated in combination with our UHF system RF600.

SIMATIC RF620T Transponder	Characteristics	
	Area of application	Transponder for rugged, industrial requirements such as RF identification in warehouses and the logistics and transport area.
	Frequency range	860 to 960 MHz
	Polarization	Linear
	Memory	<ul style="list-style-type: none"> EPC: 96 / 128 bits User memory: 64 bytes
	Read range	Max. 8 m ¹⁾
	Mounting	<ul style="list-style-type: none"> Square metal support <ul style="list-style-type: none"> Screw, bond On metal by means of spacers Circular metal carrier
	① Labeling area	<p>can inscribe the transponder itself using laser, or adhere a label to position ①. Possible types of labeling:</p> <ul style="list-style-type: none"> Barcode Inscription in plain text Data matrix code
	Housing color	Anthracite

¹⁾ Depending on the environment, the reader/the antennas and the set power

7.7.2 Ordering data

Table 7- 19 Ordering data RF620T

Product	Article number
SIMATIC RF620T	6GT2810-2HC81
Spacer for SIMATIC RF620T	6GT2898-2AA00

Delivery format

SIMATIC RF620T is supplied in the following form:

- 20 transponders per packaging unit
- Minimum order quantity: 1 packaging unit (20 units)

7.7.3 Planning the use

7.7.3.1 Range when mounted on flat metallic carrier plates

The transponder generally has linear polarization. The polarization axis runs as shown in the diagram below. When using a circular antenna and when the transponder is centrally mounted on a plane metal plate, which may either be almost square or circular, it can be aligned in any direction. When using a linear antenna, the polarization axes of antenna and transponder must always be aligned in parallel.

Figure 7-17 Optimum positioning of the transponder on a (square or circular) metal surface

Table 7- 20 Range with metallic, flat carriers without spacers

Carrier material	Range
Metal plate at least 300 x 300 mm	typically 40%

Table 7- 21 Range with flat metallic carriers with spacers

Carrier material	Range
Metal plate at least 300 x 300 mm	typically 100%

The use of spacers on metallic surfaces is recommended.

On rectangular carrier plates, the range depends on the mounting orientation of the transponder.

You will find more information on the range in the section "Minimum distances and maximum ranges (Page 55)".

7.7.3.2 Range when mounted on non-metallic carrier materials

Table 7- 22 Range with non-metallic carriers

Carrier material	Range
Transponder on wooden carrier (dry, degree of moisture < 15%)	typically 75 %
Transponder on plastic carrier	typically 75 %
Transponder on glass	typically 75 %
Transponder on mineral water container	typically 15 %

You will find more information on the range in the section "Minimum distances and maximum ranges (Page 55)".

7.7.4 Technical specifications

Table 7- 23 Technical specifications of the transponder SIMATIC RF620T

6GT2810-2HC81	
Product type designation	SIMATIC RF620T
Radio frequencies	
Operating frequency	
▪ ETSI	▪ 865 to 868 MHz
▪ FCC	▪ 902 to 928 MHz
Memory	
Chip (manufacturer/type)	IMPINJ / MONZA 4QT
Memory type	EEPROM
Memory configuration	
▪ EPC	▪ 12 ... 16 bytes / 96 ... 128 bits
▪ User memory	▪ 64 bytes / 512 bits
▪ TID	▪ 4 bytes / 32 bits
Number of write cycles (< 40 °C)	> 10 ⁵
Number of read cycles (< 40 °C)	> 10 ¹⁴
Data retention time (< 40 °C)	10 years
Electrical data	
Range	≤ 8 m ¹⁾
Protocol	ISO 18000-63
Transmission speed	≤ 320 kbps
Polarization	Linear
Mechanical specifications	
Material	PP
Silicone-free	Yes
Color	Anthracite
Antenna material	Aluminum
Type of antenna	Shortened dipole
Printing	Can be printed using heat transfer technique

6GT2810-2HC81

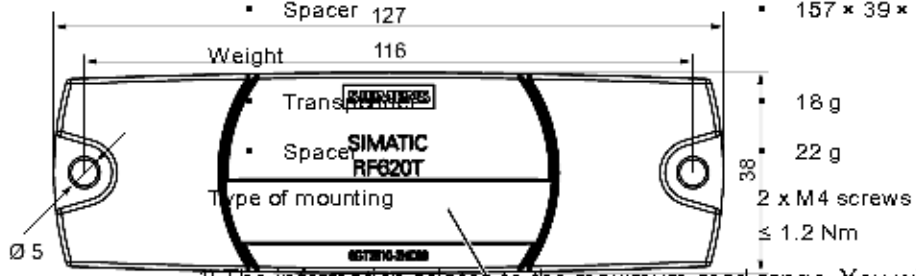
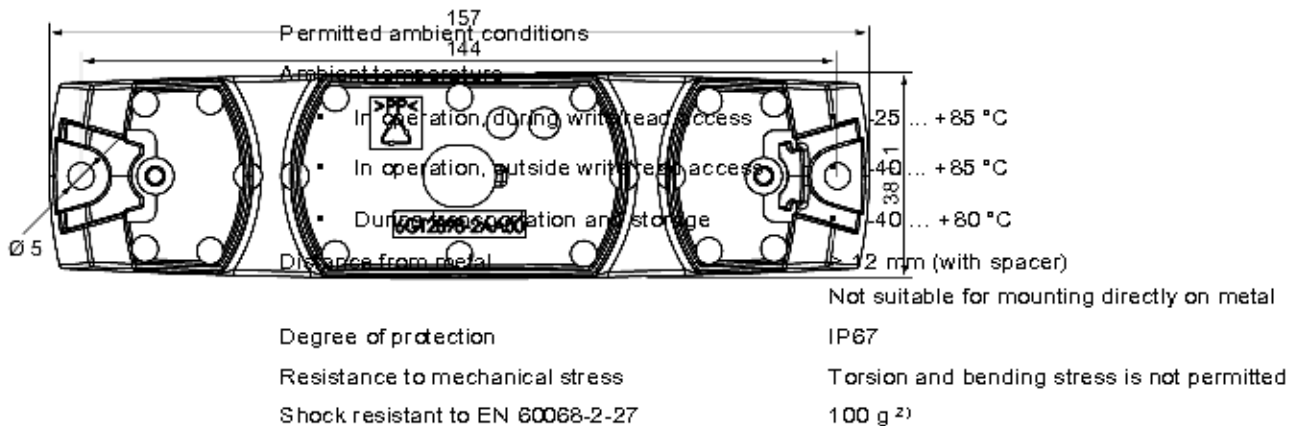

¹⁾ The information relates to the maximum read range. You will find more information on ranges in the section "Minimum distances and maximum ranges (Page 55)".

²⁾ The values for shock and vibration are maximum values and must not be applied continuously.



7.7.5 Dimension drawing



Figure 7-18 SIMATIC RF620T UHF container tag

Units of measurement: All dimensions in mm

Tolerances, unless indicated otherwise, are ± 0.5 mm.

① Labeling area, see Section Characteristics (Page 399)

7.7.6 Certificates and approvals

Table 7- 24 6GT2810-2HC00 - RF620T

Certificate	Description
	Conformity with the RED directive 2014/53/EU Conformity with the RoHS directive 2011/65/EU

Table 7- 25 6GT2810-2HC80 - RF620T

Certificate	Description
Federal Communications Commission	Passive labels or transponders comply with the valid regulations; certification is not required.
	This product is UL-certified for the USA and Canada. It meets the following safety standard(s): <ul style="list-style-type: none"> ▪ UL508 - Industrial Control Equipment ▪ CSA C22.2 No. 142 - Process Control Equipment ▪ UL Report E 120869



7.8 SIMATIC RF625T

7.8.1 Characteristics

The SIMATIC RF625T transponder is a passive, maintenance-free data carrier with a round design. It operates based on UHF Class 1 Gen 2 technology and is used to save the "Electronic Product Code" (EPC) of 96 bits/128 bits. The transponder also has a 512-bit user memory.

The areas of application are industrial asset management, RF identification of tools, containers and metallic equipment.

The Disk Tag is small and rugged and suitable for industrial applications with degree of protection IP68. It is highly resistant to oil, grease and cleaning agents.

Ideally, the SIMATIC RF625T is mounted directly on a flat metal surface of at least 150 mm diameter where it achieves a typical sensing distance of 1.5 m.

SIMATIC RF625T	Characteristics	
	Area of application	Identification tasks in rugged industrial environments
	Frequency range	<ul style="list-style-type: none"> ▪ ETSI: 865 to 868 MHz ▪ FCC: 902 to 928 MHz
	Air interface	According to ISO 18000-63
	Polarization	Linear
	Memory	<ul style="list-style-type: none"> ▪ EPC: 96 / 128 bits ▪ User memory: 64 bytes
	Read range	Max. 1.5 m ¹⁾
	Mounting	1 x M3 screw
	Mounting	Designed for direct mounting on conductive materials (preferably metal).

¹⁾ Depending on the environment, the reader/the antennas and the set power

7.8.2 Ordering data

Table 7-26 Ordering data RF625T

Product	Article number
SIMATIC RF625T (ETSI)	6GT2810-2EE00
SIMATIC RF625T (FCC)	6GT2810-2EE01

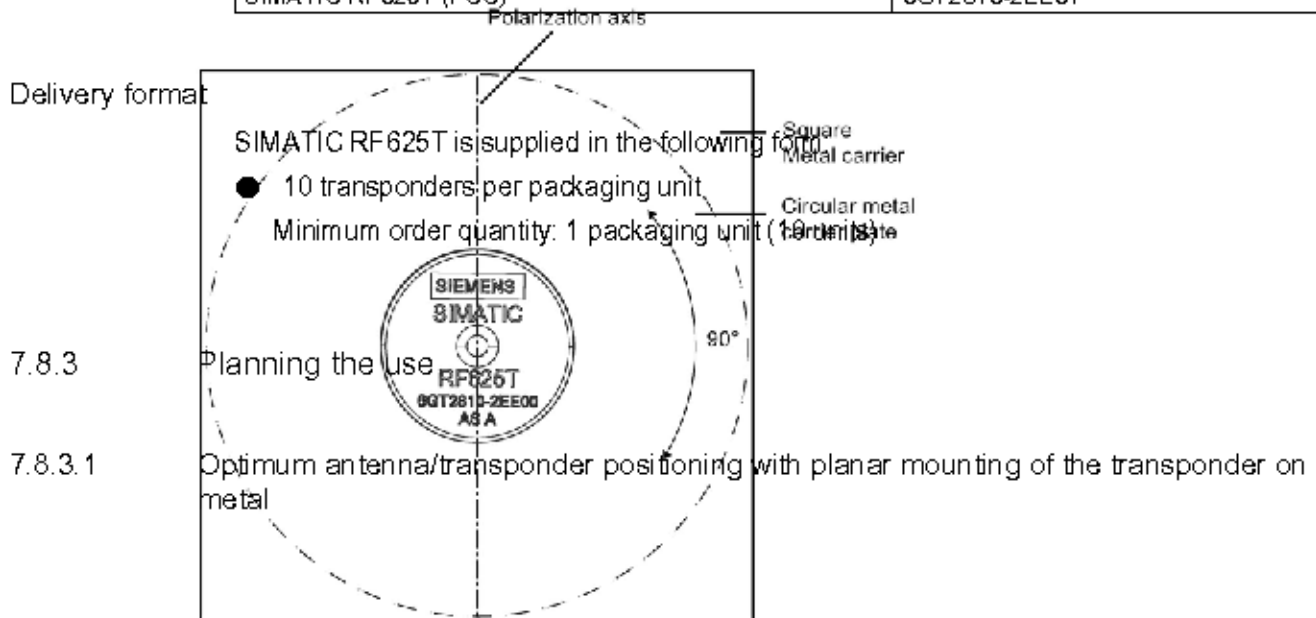

Figure 7-19 Example of optimum reader/antenna transponder positioning

The graphic shows an example of optimum positioning of the transponder relative to the reader or the antenna. This positioning is regardless of whether you are working with the internal reader antenna or with one of the external RF600 antennas.

7.8.3.2 Range when mounted on flat metallic carrier plates

The transponder generally has linear polarization. The polarization axis runs as shown in the diagram below. When using a circular antenna and when the transponder is centrally mounted on a plane metal plate, which may either be almost square or circular, it can be aligned in any direction. When using a linear antenna, the polarization axes of antenna and transponder must always be aligned in parallel.

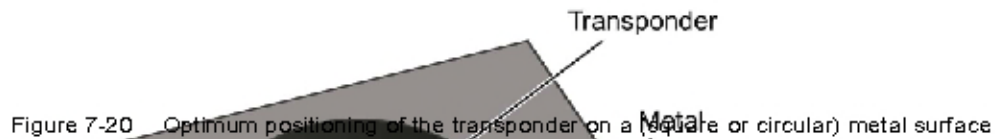

Table 7-27 Range on flat metallic carriers

Carrier material	Range
Metal plate of at least \varnothing 150 mm	100%
Metal plate \varnothing 120 mm	approx. 70%
Metal plate \varnothing 85 mm	approx. 60%
Metal plate \varnothing 65 mm	approx. 60%

On rectangular carrier plates, the range depends on the mounting orientation of the transponder.

You will find more information on the range in the section "Minimum distances and maximum ranges (Page 55)".

7.8.3.3 Range when mounted on non-metallic carrier materials

The transponder is generally designed for mounting on metallic objects which provide the conditions for the maximum reading ranges

Table 7-28 Range with non-metallic carriers

Carrier material	Range
Transponder on wooden carrier	approx. 60%
Transponder on plastic carrier	approx. 65 %
Transponder on plastic mineral water bottle	approx. 70%
Transponder without base	approx. 50 %

The maximum range of 100% is achieved by mounting the transponder in a free space with low reflections on a flat metal carrier with a diameter of at least 150 mm.

You will find more detailed information on the range in the section "Minimum distances and maximum ranges (Page 55)".

7.8.3.4 Mounting in metal

It is possible to mount the transponder in metal. If there is not enough clearance to the surrounding metal, this reduces the reading range.

Clearance (all-round)	Reading range ¹⁾
a = 5 mm	Approx. 50 %
a = 10 mm	Approx. 70%

¹⁾ The read range information applies when the transponder is mounted on a metallic carrier with a diameter of at least 150 mm.

Figure 7-21 Flush-mounting of RF625T in metal

7.8.4 Technical specifications

Table 7- 29 Technical specifications of the transponder SIMATIC RF625T

6GT2810-2EE0x	
Product type designation	SIMATIC RF625T
Radio frequencies	
Operating frequency	
▪ ETSI	▪ 865 to 868 MHz
▪ FCC	▪ 902 ... 928 MHz ¹⁾
Memory	
Chip (manufacturer/type)	IMPINJ / MONZA 4QT
Memory type	EEPROM
Memory configuration	
▪ EPC	▪ 12 ... 16 bytes / 96 ... 128 bits
▪ User memory	▪ 64 bytes / 512 bits
▪ TID	▪ 4 bytes / 32 bits
▪ Reserved (passwords)	▪ 64 bytes / 512 bits
Number of write cycles (< 40 °C)	> 10 ¹⁴
Number of read cycles (< 40 °C)	> 10 ⁸
Data retention time (< 40 °C)	22 years
Electrical data	
Range	≤ 1.5 m ²⁾
Protocol	ISO 18000-63
Transmission speed	≤ 320 kbps
Polarization	Linear
Mechanical specifications	
Material	PA6.6
Silicone-free	Yes
Color	Black
Antenna material	Aluminum
Type of antenna	Shortened dipole
Printing	No

6GT2810-2EE0x

	Permitted ambient conditions	
	Ambient temperature	<ul style="list-style-type: none"> ▪ In operation, during write/read access ▪ In operation, outside write/read access ▪ During transportation and storage
		<ul style="list-style-type: none"> ▪ -25 ... +85 °C ▪ -40 ... +125 °C ▪ -40 ... +125 °C
	Distance from metal	0 mm Designed for mounting directly on metal
	Degree of protection	IP68 / IPx9K
	Resistance to mechanical stress	Torsion and bending stress is not permitted
	Shock-resistant according to DIN EN 60721-3-7	100 g ³⁾
	Class 7 M3	
	Vibration to EN 60068-2-6	50 g ³⁾
Design, dimensions and weight		
	Dimensions (\varnothing × D)	30 × 8 mm
	Weight	6 g
	Type of mounting	1 × M3 countersunk screw ≤ 0.5 Nm

Standards, specifications, approvals

MTBF 1141 years



¹⁾ The range is reduced to 70% at the band limits 902 MHz or 928 MHz. Due to frequency fluctuations, this effect has no impact.

²⁾ Mounting on a flat metal surface with a diameter of at least 150 mm and at room temperature. The information relates to the maximum read range. You will find more information on ranges in the section "Minimum distances and maximum ranges (Page 55)". When these minimum distances are not achieved, there is a reduction in the maximum possible read and write distances of the transponder.



³⁾ The values for shock and vibration are maximum values and must not be applied continuously.



7.8.5 Dimension drawing

Figure 7-22 SIMATIC RF625T UHF Disk Tag

Units of measurement: All dimensions in mm

7.8.6 Certificates and approvals



Table 7- 30 6GT2810-2EE00 - RF625T

Certificate	Description
	Conformity with the RED directive 2014/53/EU
	Conformity with the RoHS directive 2011/65/EU

Table 7- 31 6GT2810-2EE01 - RF625T

Certificate	Description
Federal Communications Commission	Passive labels or transponders comply with the valid regulations; certification is not required
	This product is UL-certified for the USA and Canada. It meets the following safety standard(s): <ul style="list-style-type: none"> ▪ UL508 - Industrial Control Equipment ▪ CSA C22.2 No. 142 - Process Control Equipment ▪ UL Report E 120869

7.9 SIMATIC RF630T

7.9.1 Characteristics

The SIMATIC RF630T transponder is a passive (i.e. battery-free) and maintenance-free, cylindrical data carrier. It operates based on UHF Class 1 Gen 2 technology and is used to save the "Electronic Product Code" (EPC) of 96 bits/240 bits. The transponder also has a 512-bit user memory.

Areas of application include the mounting of metallic components (e.g. engine assembly in the automobile industry) as well as RF identification of tools, containers and metal frames.

The RF630T is small and rugged and suitable for industrial applications with IP68/IPX9K degree of protection. It is highly resistant to oil, grease and cleaning agents.

The SIMATIC RF630T is mounted directly onto metal surfaces to ensure optimum functioning.

SIMATIC RF630T	Characteristics	
	Area of application	Identification tasks in rugged industrial environments
	Frequency range	<ul style="list-style-type: none"> ▪ ETSI: 865 to 868 MHz ▪ FCC: 902 to 928 MHz
	Air interface	According to ISO 18000-63
	Polarization	Linear
	Memory	<ul style="list-style-type: none"> ▪ EPC: 96 ... 240 bits ▪ User memory: 64 bytes
	Read range	Max. 1.2 m ¹⁾
	Mounting	Screw-in
	Mounting	Designed for direct mounting on conductive materials (preferably metal).

¹⁾ Depending on the environment, the reader/the antennas and the set power

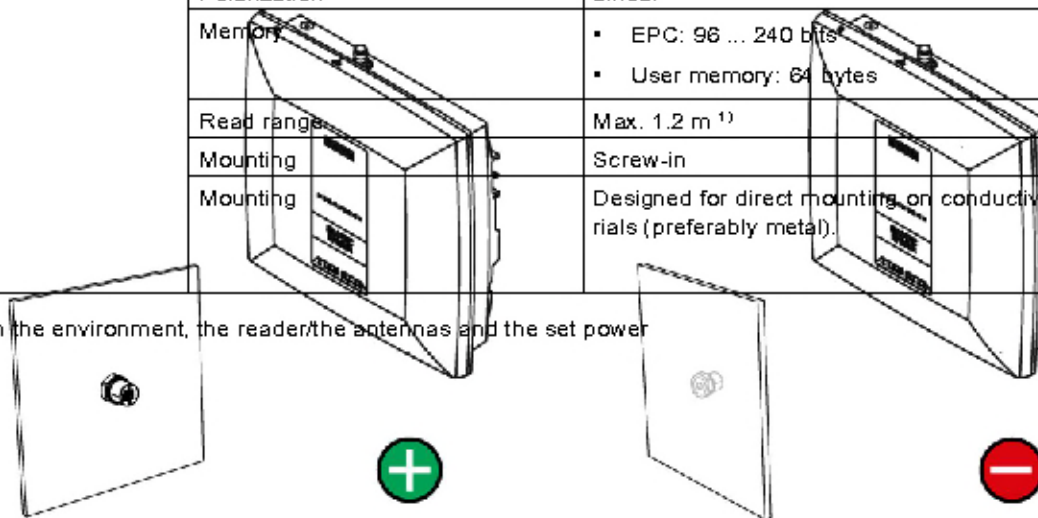

7.9.2 Ordering data

Table 7- 32 Ordering data RF630T

Product	Article number
SIMATIC RF630T (ETSI)	6GT2810-2EC00
SIMATIC RF630T (FCC)	6GT2810-2EC10

Delivery format

SIMATIC RF630T is supplied in the following form:

- 10 transponders per packaging unit
- Minimum order quantity: 1 packaging unit (10 units)

7.9.3

Planning application

7.9.3.1

Optimum antenna/transponder positioning

The maximum reading range is achieved when the reader antenna is positioned at right angles to the mounting surface. In the case of parallel mounting directly above the transponder, detection is not possible.

Optimum alignment of the transponder to the transmitting antenna

Incorrect alignment of the transponder to the transmitting antenna

Application example

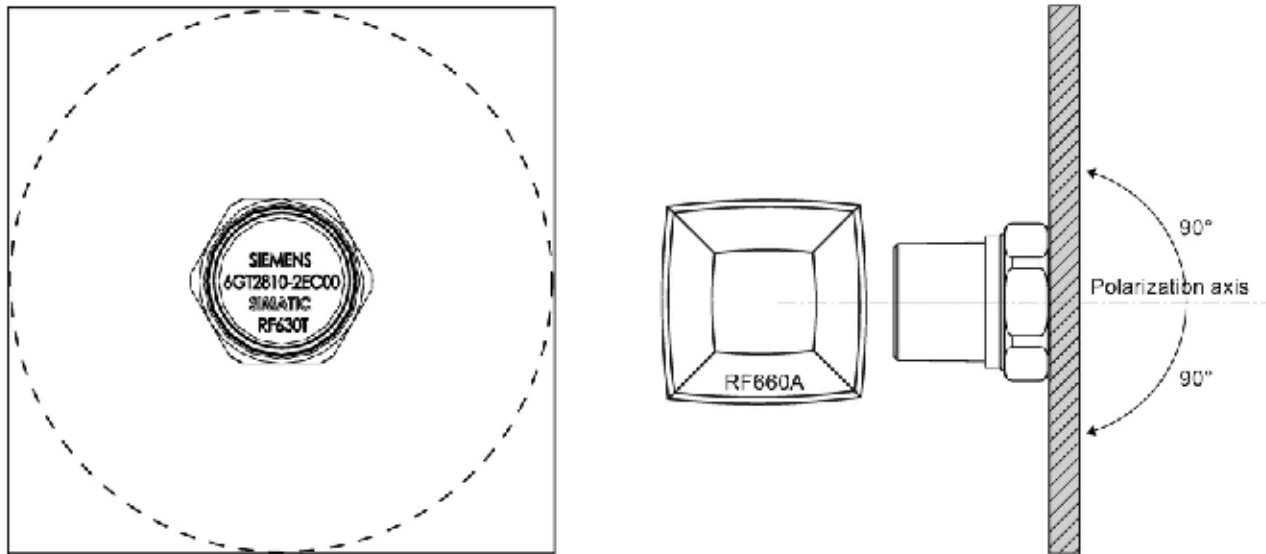

- ① Antenna
- ② Object made of metal (e.g. motor block)
- ③ Transponder
- ④ Conveyor belt

Figure 7-23 RF630T application example

7.9.3.2 Range when mounted on flat metallic carrier plates

The transponder generally has linear polarization. The polarization axis runs as shown in the diagram below. If the tag is mounted in the center of a flat metal plate, which is either approximately square or circular, it can be aligned in any direction since the transmitting and receiving RF660A antennas operate with circular polarization.

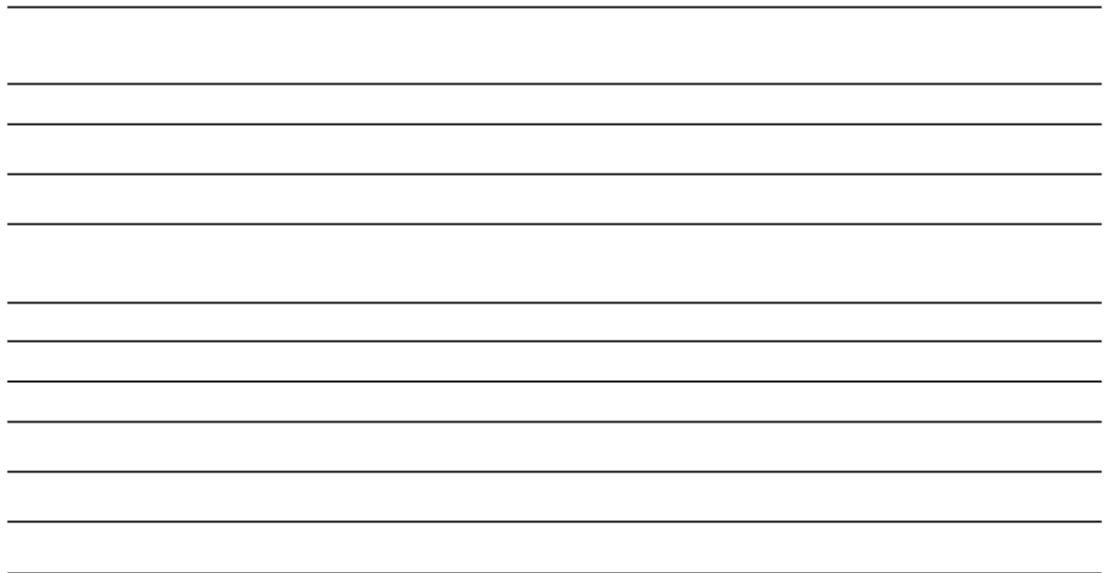

Figure 7-24 Optimum positioning of the transponder on a (square or circular) metal surface

Table 7- 33 Range on flat metallic carriers

Carrier material	Range
Metal plate of at least Ø 300 mm	100 %
Metal plate Ø 150 mm	approx. 75 %
Metal plate Ø 120 mm	approx. 50 %
Metal plate Ø 85 mm	approx. 40%

On rectangular carrier plates, the range depends on the mounting orientation of the transponder

You will find more detailed information on the range in the section "Minimum distances and maximum ranges (Page 55)".

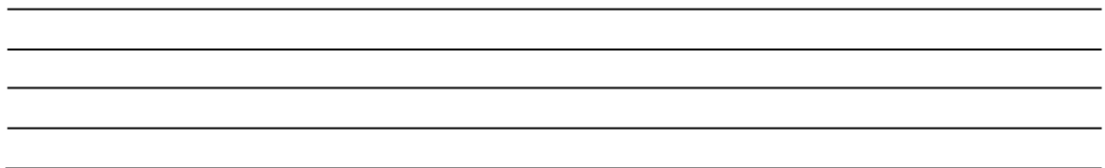

7.9.4 Technical specifications

Table 7- 34 Technical specifications of the transponder SIMATIC RF630T

6GT2810-2EC0x	
Product type designation	SIMATIC RF630T
Radio frequencies	
Operating frequency	
▪ ETSI	▪ 865 to 868 MHz
▪ FCC	▪ 902 ... 928 MHz ¹⁾
Memory	
Chip (manufacturer/type)	NXP / G2XM
Memory type	EEPROM
Memory configuration	
▪ EPC	▪ 12 ... 30 bytes / 96 ... 240 bits
▪ User memory	▪ 64 bytes / 512 bits
▪ TID	▪ 8 bytes / 64 bits
Number of write cycles (< 40 °C)	> 10 ¹⁴
Number of read cycles (< 40 °C)	> 10 ⁶
Data retention time (< 40 °C)	10 years
Electrical data	
Range	≤ 2 m ²⁾
Protocol	ISO 18000-63
Transmission speed	≤ 320 kbps
Polarization	Linear
Mechanical specifications	
Material	PA6.6 GF
Silicone-free	Yes
Color	Black/silver
Antenna material	Aluminum
Type of antenna	Shortened dipole
Printing	No

6GT2810-2EC0x

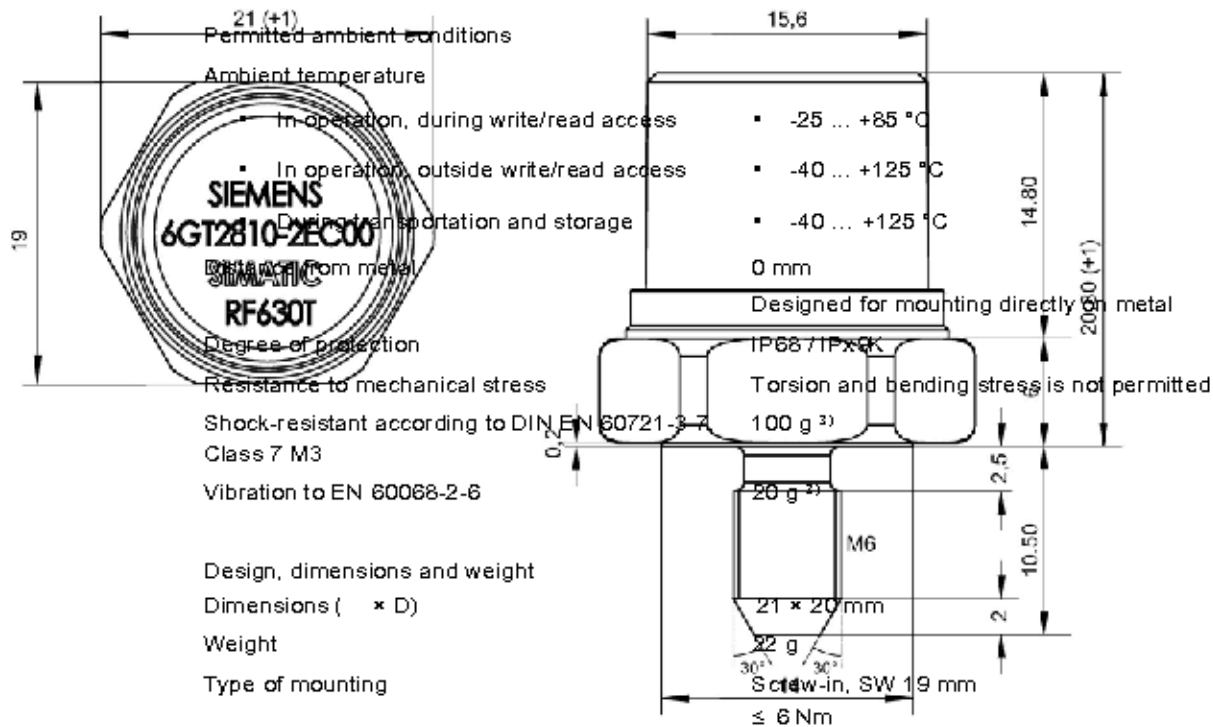

1) The range is reduced to 70% at the band limits 902 MHz or 928 MHz. Due to frequency fluctuations, this effect has no impact.

2) Mounting on a flat metal surface with a diameter of at least 150 mm and at room temperature. The information relates to the maximum read range. You will find more information on ranges in the section "Minimum distances and maximum ranges (Page 55)".

3) The values for shock and vibration are maximum values and must not be applied continuously.

7.9.5 Dimension drawing



Figure 7-25 SIMATIC RF630T

Units of measurement: All dimensions in mm

General tolerances in accordance with DIN ISO 2768f.