

5.2.6 Dimension drawing

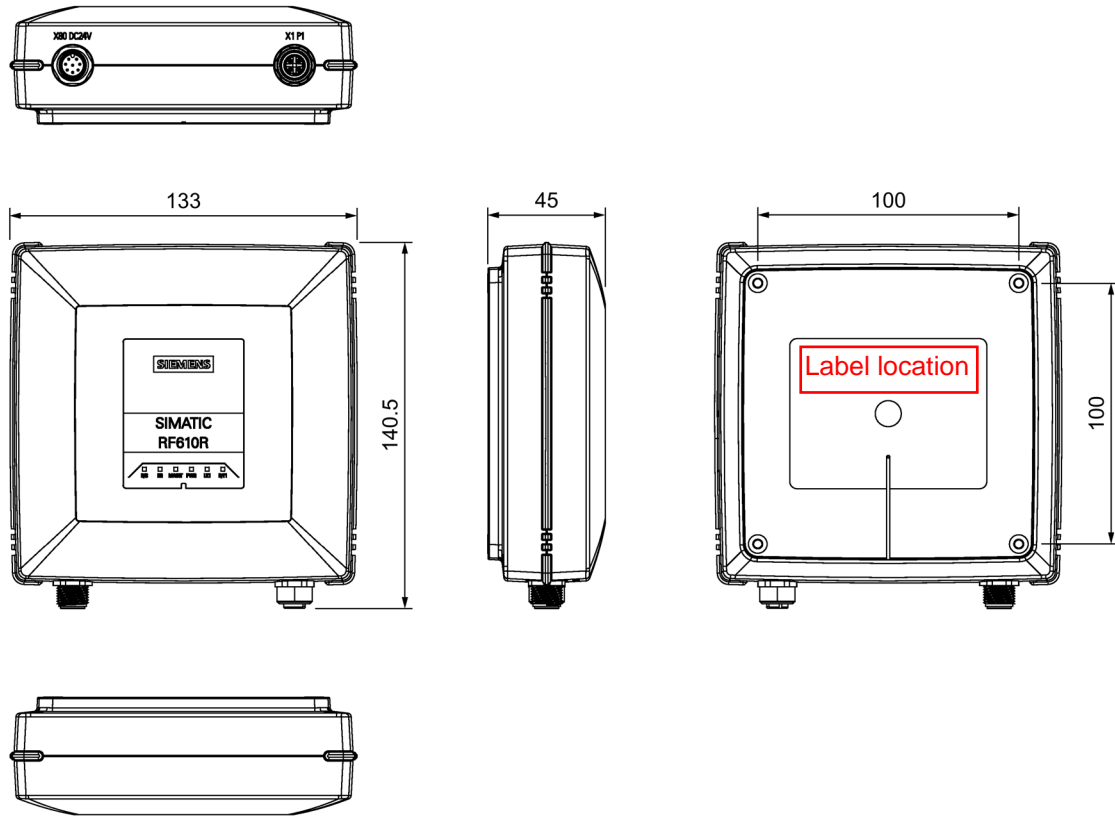

Figure 5-6 Dimension drawing RF610R

All dimensions in mm (± 0.5 mm tolerance)