

***EMC* EMISSION - TEST REPORT**

JQA APPLICATION No. : KL80000030

Name of Product : Cellular Phone

Model/Type No. : EB-TX220

FCC ID : NWJ10A002A

Applicant : Matsushita Communication Industrial Co., Ltd.

Address : 4-3-1, Tsunashima-higashi, Kohoku-ku, Yokohama Kanagawa
223-8639, Japan

Manufacturer : Matsushita Communication Industrial Co., Ltd.

Address : 4-3-1, Tsunashima-higashi, Kohoku-ku, Yokohama Kanagawa
223-8639, Japan

Receive date of TUT : April 13, 2000

Final Judgement : **Passed**

TEST RESULTS IN THIS REPORT are obtained in use of equipment that is traceable to Electro-technical Lab. of MITI Japan and Communications Research Lab. of PTT Japan.

THE TEST RESULTS only responds to the test sample. This test report shall not be reproduced except in full.

DIRECTORY

	Page
A) Documentation	
Directory	<u>2</u>
Test Regulation / General Information	<u>3 - 6</u>
Test Conditions	<u>7 - 21</u>
Configuration of TUT / Operation mode of the TUT	<u>22 - 25</u>
TUT Modification / Responsible Party	<u>26</u>
Test results / Measurement Uncertainty	<u>27 - 28</u>
Summary	<u>29</u>
Test System-Arrangement (Drawings)	<u>30</u>
Test-setup (Photographs) at worst case	<u>31</u>
B) Test data	
- 800 MHz Systems -	
Transmitter Power(TP)	<u>32</u>
Maximum Transmitter Power(ERP)	<u>33 - 34</u>
Unwanted Radiation	<u>35 - 47</u>
- 1900 MHz Systems -	
Transmitter Power(TP)	<u>48</u>
Maximum Transmitter Power(EIRP)	<u>49</u>
Unwanted Radiation	<u>50 - 56</u>

TEST REGULATION

FCC Rules and Regulations Parts 22 and 24 (October 1, 1998)

a) 800 MHz systems(Part 22) : Cellular Radiotelephone

b) 1900 MHz systems(Part 24)

○ - Narrowband PCS

● - Broadband PCS

※Three measurement items shown as follows were performed at the request of the applicant.

1) Transmitter Power(TP)

2) Maximum Transmitter Power(EIRP/ERP)

3) Unwanted Radiation

Test procedure:

The tests were performed according to FCC Rules and Regulations Part 2 (October 1, 1999), and ANSI C63.4 (1992).

GENERAL INFORMATION

Test facility:

1) Test Facility located at Kita-Kansai : 1st and 2nd Open Sites (3 m Site)
Test Facility located at Kameoka Open Site (3, 10 and 30 m, on common plane)
FCC filing No. : 31040/SIT 1300F2

2) KITA-KANSAI TESTING CENTER is recognized under the National Voluntary Laboratory Accreditation Program for satisfactory compliance established in Title 15, Part 285 Code of Federal Regulations.
NVLAP Lab Code: 200191-0

Definitions for symbols used in this test report:

- - Black box indicates that the listed condition, standard or equipment is applicable for this Report.
- - Blank box indicates that the listed condition, standard or equipment is not applicable for this Report.

Description of the Transmitter Under Test (TUT):

1) Name : Cellular Phone
2) Model/Type No. : EB-TX220
3) Product Type : Prototype(Serial No. : --)
4) Category : Broadband PCS / Cellular Radiotelephone
5) TUT Authorization : - Verification - Certification - D.o.C.
6) Transmitting Frequency : 824.040 MHz (991 ch) - 848.970 MHz (799 ch)
: 1850.040 MHz (2 ch) - 1909.920 MHz (1998 ch)
7) Receiving Frequency : 869.040 MHz (991 ch) - 893.970 MHz (799 ch))
: 1930.080 MHz (2 ch) - 1989.960 MHz (1998 ch)
8) Integrated Antenna : Helical Antenna
9) Emission Designations : F3E (800 MHz) / M1E(800 MHz,1900 MHz)
10) Nominal ERP : 0.6 W
11) Power Rating : 3.6Vdc

Transmitter Technical Characteristics(§2.1033) :

- A. TX RF Power Output : 0.6W
- B. Tunable Channels(not user tunable) : 1997(Refer to page 6)
- C. Transmitting Frequency Range : 824.040 MHz to 848.970 MHz
: 1850.04 to 1909.920 MHz
- D. Emission Designations : F3E (800 MHz) / M1E(800 MHz,1900 MHz)
- E. Power Supply : 3.6Vdc
- G. TX Antenna Gain : -1.0dBd

Channel Numbers and Frequencies for 800MHz Systems

Band	Bandwidth (MHz)	Number of Channels	Boundary Channel Numbers	Transmitter Center Frequency (MHz)
Not Used		1	990	824.010
A''	1	33	991 ~ 1023	824.040 ~ 825.000
A	10	333	1 ~ 333	825.030 ~ 834.990
B	10	333	334 ~ 666	835.020 ~ 844.980
A'	1.5	50	667 ~ 716	845.010 ~ 846.480
B'	2.5	83	717 ~ 799	846.510 ~ 848.970

Channel Numbers and Frequencies for 1900MHz Systems

Band	Bandwidth (MHz)	Number of Channels	Boundary Channel Numbers	Transmitter Center Frequency (MHz)
Not Used		1	1	1850.010
A	15	497	2 ~ 498	1850.040 ~ 1864.920
A,D(Note)		3	499 ~ 501	1864.950 ~ 1865.010
D	5	164	502 ~ 665	1865.040 ~ 1869.930
D,B(Note)		2	666 ~ 667	1869.960 ~ 1869.990
B	15	498	668 ~ 1165	1870.020 ~ 1884.930
B,E(Note)		2	1166 ~ 1167	1884.960 ~ 1884.990
E	5	165	1168 ~ 1332	1885.020 ~ 1889.940
E,F(Note)		2	1333 ~ 1334	1889.970 ~ 1890.000
F	5	164	1335 ~ 1498	1890.030 ~ 1894.920
F,C(Note)		3	1499 ~ 1501	1894.950 ~ 1895.010
C	15	497	1502 ~ 1998	1895.040 ~ 1909.920
Not Used		1	1999	1909.950

Note : This channel does not entirely fall into a single band (A,B,C,D,E or F). A mobile station capable of operating in any of these bands or combination thereof shall also be able to operate on the associated border channel (s).

TEST CONDITIONS

Transmitter Power(TP) Measurement (§2.1046(a))

Test Procedure :

The Transmitter Power was measured with a power meter, two 10 dB attenuators and a short, low loss cable.

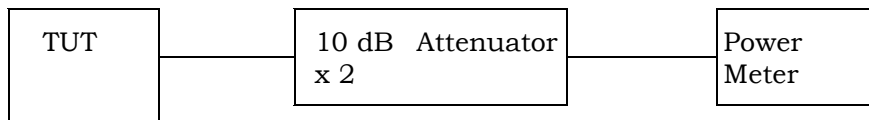

Test location :

KITA-KANSAI Testing Center

7-7, Ishimaru, 1-Chome, Mino-Shi, Osaka, 562-0027, Japan

● - Shielded room

KAMEOKA EMC Branch

9-1, Ozaki, Inukanno, Nishibetsuin-Cho, Kameoka-Shi, Kyoto, 621-0126, Japan

○ - Shielded room

Used test instruments and sites :

Model No.	Device ID	Last Cal. Date	Cal. Interval
● - 432B/8478B	B - 24/B-43	March, 2000	1 Year
○ - 6-20	D - 27		
● - 4T-10	D - 73	May, 1999	1 Year
● - 4T-10	D - 74	May, 1999	1 Year
○ - 8566B	A - 13		
○ - 8593A	A - 15		

Environmental conditions :

Temperature: 18 °C Humidity: 30 %

Transmitter Power(ERP) Measurement (§22.913)

- 800 MHz Systems -

The measurement were performed shown as follows.

Step 1) The test was set-up shown as Fig.1(a). In order to obtain the maximum emission, the TUT is placed at the height 0.8m on the wooden table, at the distance 3m from the receiving antenna(Resonant Tune Dipole Antenna) and rotated around 360 degrees. The receiving antenna height was varied from 1m to 4 m . The TUT on the table was placed to be maximum emission against the receiving antenna polarized (Vertical and Horizontal). Then the meter reading of the test receiver at the maximum emission was A dB(μ V).

Step 2) The test was set-up shown as Fig.1(b). The TUT was replaced to half-wave dipole antenna at the same polarized under the same condition as step 1. The RF power was fed to the transmitting Antenna(half-wave Dipole Antenna) from the signal generator. In order to obtain the maximum emission level, the height of the receiving antenna is varied from 1m to 4 m. The level of the signal generator was adjusted so that the meter reading of the test receiver at the maximum emission was A dB(μ V) ,same as the recorded level in Step1. Then the RF power into the substitution half-wave dipole antenna was P(dBm).

The ERP is calculated in the following equation.

$$\text{ERP[dBm]} = P \text{ (dBm)} - (\text{Balun Loss of the half-wave Dipole Ant. (dB)}) + \text{Cable Loss(dB)}$$

Test location:

KITA-KANSAI Testing Center

7-7, Ishimaru, 1-Chome, Mino-Shi, Osaka, 562-0027, Japan

● - 1st site (3 meters)

○ - 2nd site (3 meters)

KAMEOKA EMC Branch

9-1, Ozaki, Inukanno, Nishibetsuin-Cho, Kameoka-Shi, Kyoto, 621-0126, Japan

○ - 3 meters

○ - 10 meters

Validation of Site Attenuation:

1) Last Confirmed Date : October 28, 19998

2) Interval : 1 Year

Used test instruments:

Model No.	Device ID	Last Cal. Date	Cal. Interval
● - ESV	A - 7	December, 1999	1 Year
○ - ESV/ESV-Z3	A - 6 / A - 18		
○ - ESV/ESV-Z3	A - 4 / A - 20		
○ - ESV/ESV-Z3	A - 8 / A - 19		
● - 4396B	B - 47	July, 1999	1 Year
○ - 8566B	A - 13		
○ - 8593A	A - 15		
○ - KBA-511A	C - 12		
● - KBA-611	C - 22	November, 1999	1 Year
○ - KBA-511A	C - 13		
● - KBA-611	C - 19	November, 1999	1 Year
○ - KBA-511A	C - 11		
○ - KBA-611	C - 21		
○ - Cable	H - 1		
○ - Cable	H - 2		
● - Cable	H - 5	November, 1999	1 Year
○ - Cable	H - 6		
○ - DC6180	E - 51		
● - 8673D	B - 2	April, 1999	1 Year

Temperature: 19 °C Humidity: 59 %

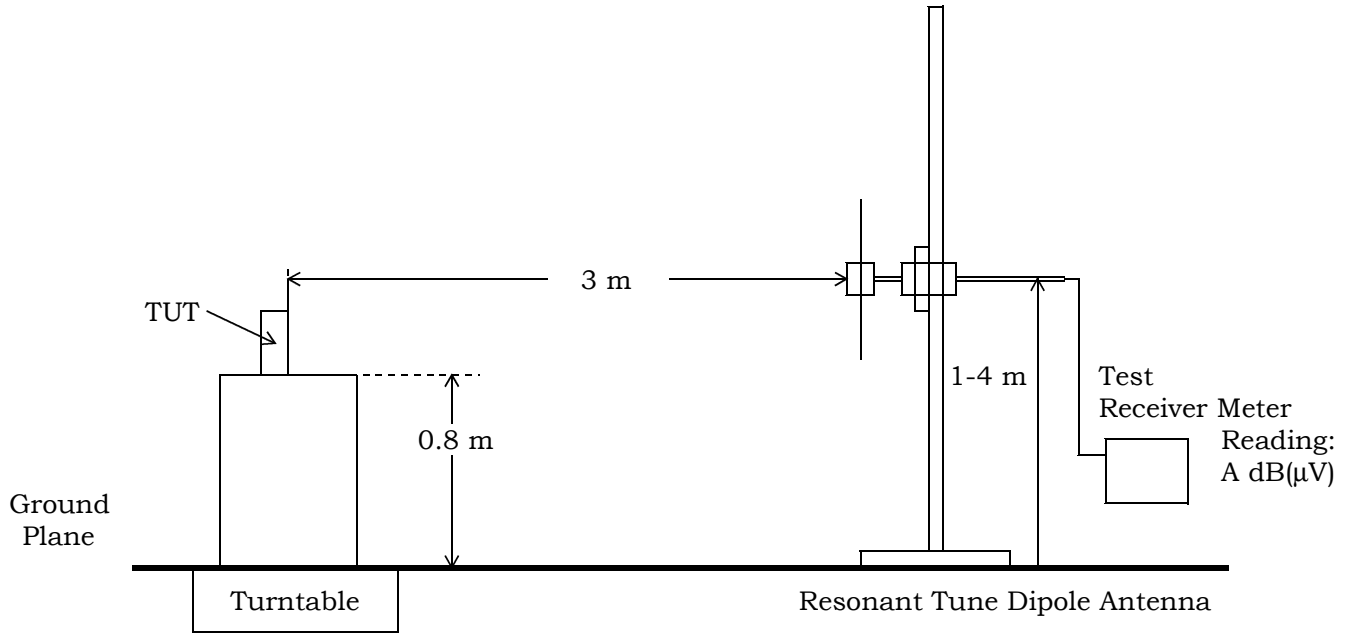

(a) TUT

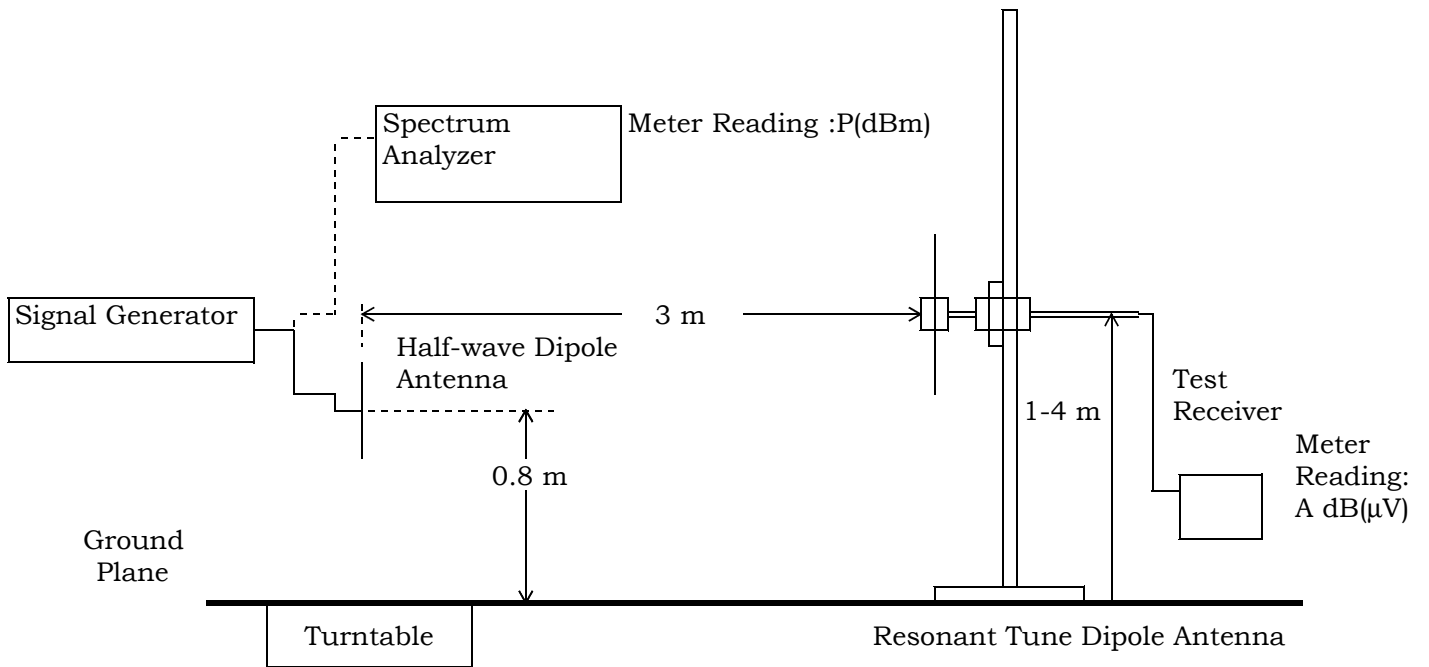

(b) Half-wave Dipole Antenna

Fig.1 Maximum Transmitter Power(ERP) Measurement(800 MHz system)

Transmitter Power(EIRP) Measurement (§24.232)
- 1900 MHz Systems -

The measurement were performed shown as follows.

Step 1) The test was set-up shown as Fig.2(a). In order to obtain the maximum emission, the TUT is placed at the height 0.8m on the wooden table, at the distance 3m from the receiving antenna(Horn Antenna) and rotated around 360 degrees. The receiving antenna height was varied from 1m to 4 m . The TUT on the table was placed to be maximum emission against the receiving antenna polarized (Vertical and Horizontal). Then the meter reading of the test receiver at the maximum emission was A dB(μ V).

Step 2) The test was set-up shown as Fig.2(b). The TUT was replaced to Horn antenna at the same polarized under the same condition as step 1. The RF power was fed to the transmitting Antenna(horn Antenna) through the RF amplifier from the signal generator. In order to obtain the maximum emission level, the height of the receiving antenna is varied from 1m to 4 m. The level of the signal generator was adjusted so that the meter reading of the test receiver at the maximum emission was A dB(μ V) ,same as the recorded level in Step1. Then the RF power into the substitution horn antenna was P(dBm).

The EIRE is calculated in the following equation.

$$\text{EIRP(dBm)} = \text{P (dBm)} + \text{Gh(dBi)}$$

Where, Gh(dBi) : Gain of the substitution horn antenna

Test location :

KITA-KANSAI Testing Center

7-7, Ishimaru, 1-Chome, Mino-Shi, Osaka, 562-0027, Japan

● - 1st site (3 meters)

○ - 2nd site (3 meters)

KAMEOKA EMC Branch

9-1, Ozaki, Inukanno, Nishibetsuin-Cho, Kameoka-Shi, Kyoto, 621-0126, Japan

○ - 1st open site ○ - 3 m ○ - 10 m ○ - 30 m

○ - 2nd open site ○ - 3 m ○ - 10 m

Validation of Site Attenuation :

1) Last Confirmed Date : October 28, 1999

2) Interval : 1 Year

Used test instruments :

Model No.	Device ID	Last Cal. Date	Cal. Interval		
● - 8566B	A - 13	November, 1999	1 year		
○ - 8593A	A - 15				
○ - ESV	A - 4				
● - 4T-10	D - 73	May, 1999	1 year		
○ - 4T-10	D - 74				
○ - WJ-6611-513	A - 23	May, 1999	1 year		
○ - WJ-6882-824	A - 21				
○ - DBL-0618N515	A - 33				
● - 91888-2	C - 41 - 1				
● - 91888-2	C - 42 - 1				
○ - 91889-2	C - 41 - 2				
○ - 94613-1	C - 41 - 3				
○ - 91891-2	C - 41 - 4				
○ - 94614-1	C - 41 - 5				
○ - 3160-09	C - 48				
○ - 355C	D - 22	April, 1999	1 Year		
○ - 355D	D - 23				
○ - 8494H/8595H	D - 76				
○ - MZ5010C	D - 81				
● - 8673D	B - 2				
● - Cable	C - 40 - 11			May, 1999	1 year
● - Cable	C - 40 - 12				

Environmental conditions :

Temperature: 18 °C Humidity: 30 %

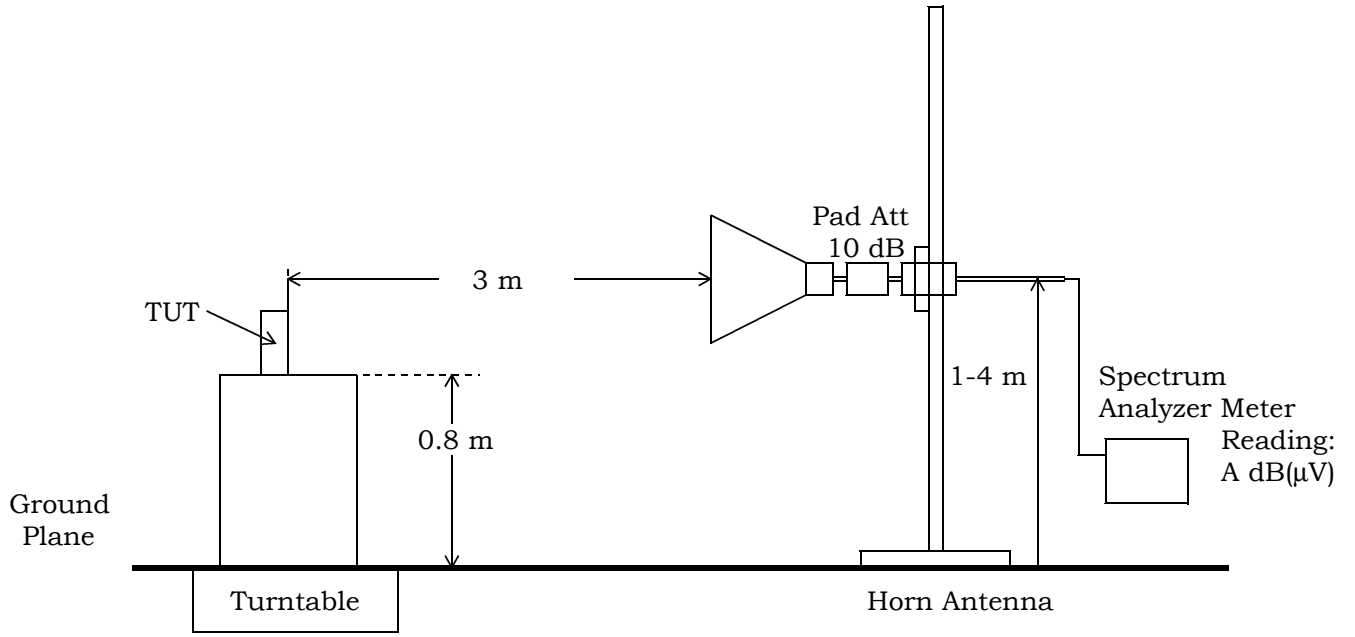

(a) TUT

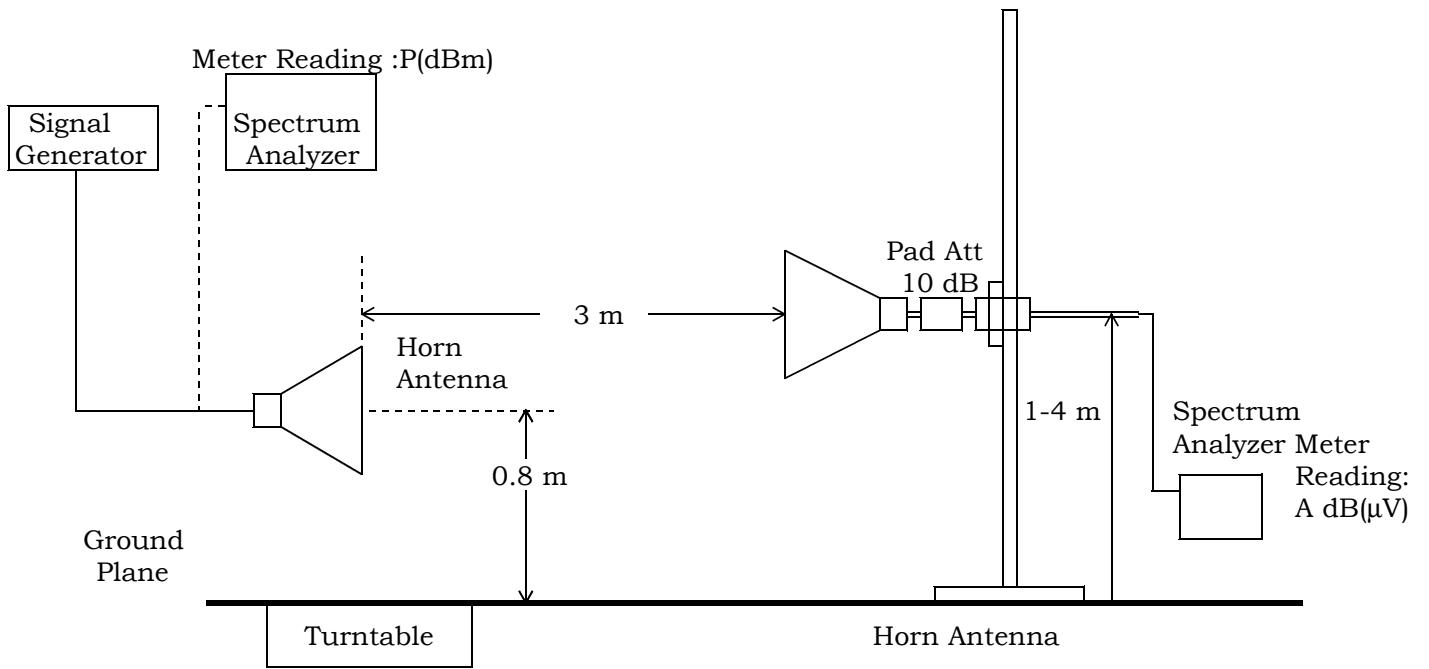

(b) Substitution Horn Antenna

Fig.2 Maximum Transmitter Power (EIRP) Measurement(1900 MHz systems)

**Unwanted Radiation Measurement (§2.1053,§22.917§24.238)
- Radiated Field Strength at 3m -**

The spurious radiation for transmitter were measured at the distance 3m away from the TUT which was placed on a wooden table 0.8m in height and was varying at three orthogonal axes. The receiving antenna was oriented for vertical polarization and varied from 1 m to 4 m until the maximum emission level was detected on the measuring instrument. The TUT was rotated 360 degrees until the maximum emission was received. The measurement was also repeated with the receiving antenna in the horizontal polarization.

This test was carried out using the loop antenna for up to 30MHz, using the half-wave dipole antenna for up to 1GHz and using the horn antenna for above 1GHz.

The respective measuring emission level of the spurious and harmonics were compared with the radiated emission level of fundamental frequency by specified attenuation limits, $43+10\log_{10}(TP \text{ in watt})$ [dB]. TP = Transmitter power at the ANT OUT under test configuration as the handsfree unit used.

The tests were carried out under two test configuration as the single unit and the private handsfree adapter used.

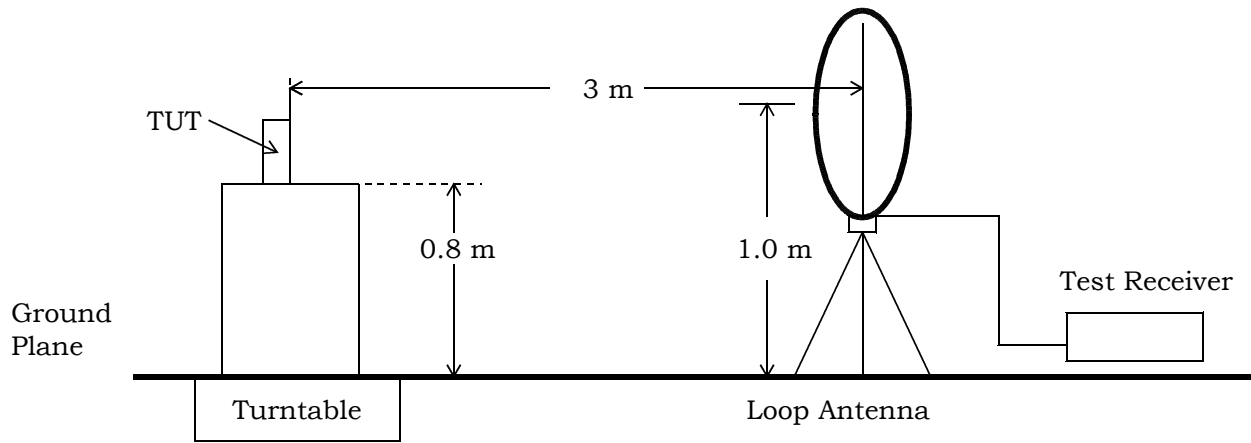

(a) Measurement set up for up to 30 MHz

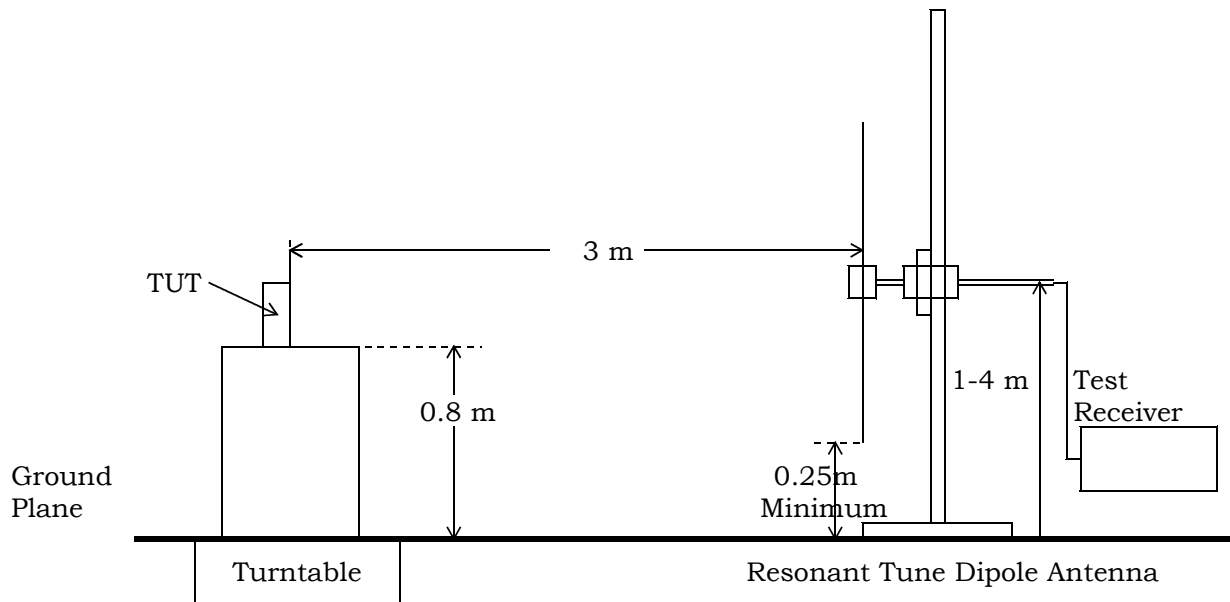

(b) Measurement set up for up to 1 GHz

Fig.3 Unwanted Radiation Measurement(Field Strength at 3 m)

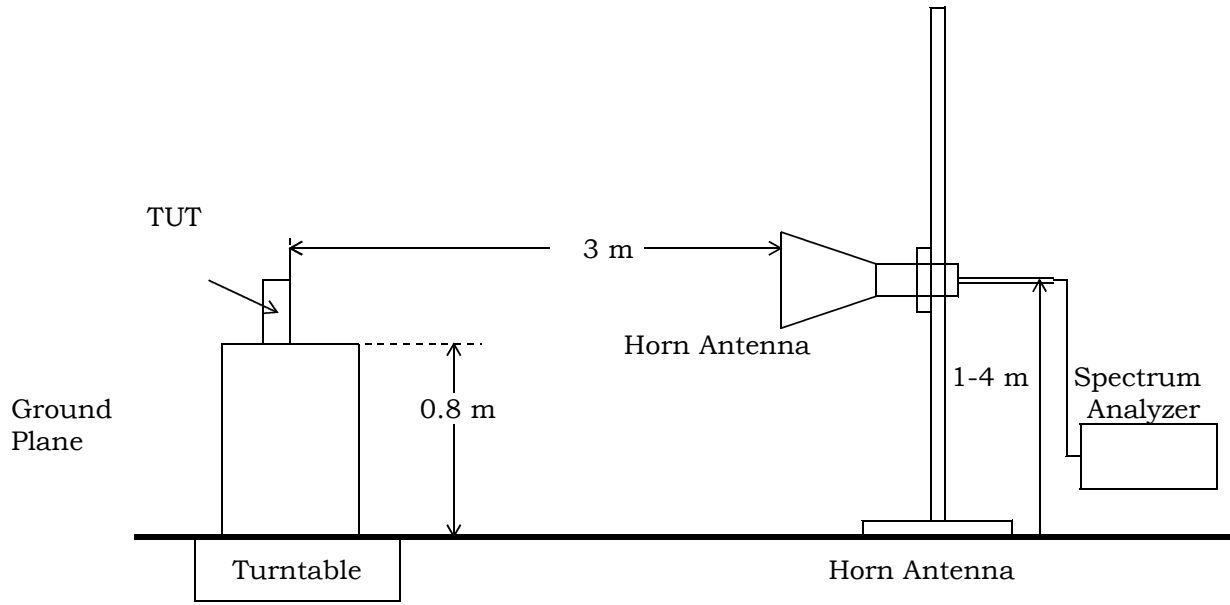

(c) Measurement set up for above 1GHz

Fig.3 Unwanted Radiation Measurement(Field Strength at 3 m)

Test location :

KITA-KANSAI Testing Center

7-7, Ishimaru, 1-Chome, Mino-Shi, Osaka, 562-0027, Japan

● - 1st site (3 meters)

○ - 2nd site (3 meters)

KAMEOKA EMC Branch

9-1, Ozaki, Inukanno, Nishibetsuin-Cho, Kameoka-Shi, Kyoto, 621-0126, Japan

○ - 1st open site ○ - 3 m ○ - 10 m ○ - 30 m

○ - 2nd open site ○ - 3 m ○ - 10 m

Validation of Site Attenuation :

1) Last Confirmed Date : October 28, 1999

2) Interval : 1 Year

Used test instruments :

Model No.	Device ID	Last Cal. Date	Cal. Interval
○ - ESH 3	A - 1		
● - ESH 2	A - 2	May, 1999	1 Year
○ - ESH 2	A - 3		
● - HFH2-Z2	C - 2	February, 2000	1 Year
○ - HFH2-Z2	C - 3		
● - ESV/ESV-Z3	A - 7 / A - 17	December, 1999	1 Year
○ - ESV/ESV-Z3	A - 6 / A - 18		
● - KBA-511A	C - 12	November, 1999	1 Year
● - KBA-611	C - 22	November, 1999	1 Year
○ - KBA-511A	C - 13		
○ - KBA-611	C - 19		
○ - KBA-511A	C - 11		
○ - KBA-611	C - 21		
○ - Cable	H - 1		
○ - Cable	H - 2		
● - Cable	H - 5	November, 1999	1 Year
○ - Cable	H - 6		
○ - 4396B	B - 47		
● - 8566B	A - 13	November, 1999	1 Year
○ - 8593A	A - 15		
● - 8673D	B - 2	April, 1999	1 Year
● - KBA-511A	C - 12	November, 1999	1 Year
● - KBA-611	C - 22	November, 1999	1 Year
○ - Cable	H - 1		
○ - Cable	H - 2		
○ - Cable	H - 5		
○ - Cable	H - 6		
○ - DC6180	E - 51		

- continue -

Used test instruments :

Model No.	Device ID	Last Cal. Date	Cal. Interval
● - 4T-10	D - 73	May, 1999	1 Year
○ - 4T-10	D - 74		
○ - WJ-6611-513	A - 23		
● - WJ-6882-824	A - 21	May, 1999	1 Year
● - DBL-0618N515	A - 33	October, 1999	1 Year
● - UHF-128	D - 43	April, 2000	1 Year
○ - 91888-2	C - 41 - 1		
○ - 91889-2	C - 41 - 2		
○ - 94613-1	C - 41 - 3		
○ - 91891-2	C - 41 - 4		
○ - 94614-1	C - 41 - 5		
● - 3160-04	C - 55	June, 1999	1 Year
● - 3160-05	C - 56	June, 1999	1 Year
● - 3160-06	C - 57	June, 1999	1 Year
● - 3160-07	C - 58	June, 1999	1 Year
● - 3160-08	C - 59	June, 1999	1 Year
● - 3160-09	C - 48	October, 1999	1 Year
○ - 3160-10	C - 49		
○ - TRA-603D	D - 24		
○ - 8494H/8595H	D - 76		
● - MZ5010C	D - 81	October, 1999	1 Year
● - Cable	C - 40 - 11	May, 1999	1 Year
● - Cable	C - 40 - 12	May, 1999	1 Year

Environmental conditions :

Temperature: 18 °C Humidity: 30 %

Unwanted Radiation Measurement (§2.1053,§22.917§24.238)

- ERP method -

Step 1) The spurious radiation for transmitter were measured at the distance 3m away from the TUT which was placed on a wooden table 0.8m in height and was varying at three orthogonal axes. The receiving antenna was oriented for vertical polarization and varied from 1 m to 4 m until the maximum emission level was detected on the measuring instrument. The TUT was rotated 360 degrees until the maximum emission was received. The measurement was also repeated with the receiving antenna in the horizontal polarization.

This test was carried out using the loop antenna for up to 30MHz, using the half-wave dipole antenna for up to 1GHz and using the horn antenna for above 1GHz.

Step 2) The EIRP and ERP measurement were carried out with according to Step 2 in page 8 for under 1GHz and in page 11 for above 1GHz. Then the RF power in the substitution antenna half-wave dipole antenna for up to 1GHz and the substitution horn antenna for above 1GHz.

The EIRP is calculated in the following equation.

A) Up to 1GHz

$$\text{EIRP(dBm)} = P \text{ (dBm)} + G_d(\text{dBi}) - (\text{Balun Loss of the half-wave dipole Ant. (dB)}) + \text{Cable Loss(dB)}$$

Where, $G_d(\text{dBi})$: Gain of the substitution half-dipole antenna

B) Above 1GHz

$$\text{EIRP(dBm)} = P \text{ (dBm)} + G_h(\text{dBi})$$

Where, $G_h(\text{dBi})$: Gain of the substitution horn antenna

The ERP is calculated in the following equation.

$$\text{ERP[dBm]} = \text{EIRP (dBm)} - G_d(\text{dBi})$$

The respective calculated EIRP and ERP of the spurious and harmonics were compared with the EIRP and ERP of fundamental frequency by specified attenuation limits, $43 + 10 \log_{10}(\text{TP in watt})[\text{dB}]$. Where, TP = Transmitter power at the ANT OUT under test configuration as the handsfree unit used.

The tests were carried out under one test configuration as the handsfree unit used.

Test location :

KITA-KANSAI Testing Center

7-7, Ishimaru, 1-Chome, Mino-Shi, Osaka, 562-0027, Japan

● - 1st site (3 meters)

○ - 2nd site (3 meters)

KAMEOKA EMC Branch

9-1, Ozaki, Inukanno, Nishibetsuin-Cho, Kameoka-Shi, Kyoto, 621-0126, Japan

○ - 1st open site ○ - 3 m ○ - 10 m ○ - 30 m

○ - 2nd open site ○ - 3 m ○ - 10 m

Validation of Site Attenuation :

1) Last Confirmed Date : October 28, 1999

2) Interval : 1 Year

Used test instruments :

Model No.	Device ID	Last Cal. Date	Cal. Interval
○ - ESH 3	A - 1		
● - ESH 2	A - 2	May, 1999	1 Year
○ - ESH 2	A - 3		
● - HFH2-Z2	C - 2	February, 2000	1 Year
○ - HFH2-Z2	C - 3		
● - ESV/ESV-Z3	A - 7 / A - 17	December, 1999	1 Year
○ - ESV/ESV-Z3	A - 6 / A - 18		
● - KBA-511A	C - 12	November, 1999	1 Year
● - KBA-611	C - 22	November, 1999	1 Year
● - KBA-511A	C - 13	November, 1999	1 Year
● - KBA-611	C - 19	November, 1999	1 Year
○ - KBA-511A	C - 11		
○ - KBA-611	C - 21		
○ - Cable	H - 1		
○ - Cable	H - 2		
● - Cable	H - 5	November, 1999	1 Year
○ - Cable	H - 6		
○ - 4396B	B - 47		
● - 8566B	A - 13	November, 1999	1 Year
○ - 8593A	A - 15		
● - 8673D	B - 2	April, 1999	1 Year
○ - Cable	H - 1		
○ - Cable	H - 2		
○ - Cable	H - 5		
○ - Cable	H - 6		
○ - DC6180	E - 51		

- continue -

Used test instruments :

Model No.	Device ID	Last Cal. Date	Cal. Interval
● - 4T-10	D - 73	May, 1999	1 Year
○ - 4T-10	D - 74		
○ - WJ-6611-513	A - 23		
● - WJ-6882-824	A - 21	May, 1999	1 Year
● - DBL-0618N515	A - 33	October, 1999	1 Year
● - UHF-128	D - 43	April, 2000	1 Year
● - 91888-2	C - 40 - 1	May, 1999	1 Year
● - 91888-2	C - 41 - 1	May, 1999	1 Year
● - 91889-2	C - 41 - 2	May, 1999	1 Year
● - 94613-1	C - 41 - 3	May, 1999	1 Year
● - 91891-2	C - 41 - 4	May, 1999	1 Year
● - 94614-1	C - 41 - 5	May, 1999	1 Year
● - 3160-04	C - 55	June, 1999	1 Year
● - 3160-05	C - 56	June, 1999	1 Year
● - 3160-06	C - 57	June, 1999	1 Year
● - 3160-07	C - 58	June, 1999	1 Year
● - 3160-08	C - 59	June, 1999	1 Year
● - 3160-09	C - 48	October, 1999	1 Year
○ - 3160-10	C - 49		
○ - TRA-603D	D - 24		
○ - 8494H/8595H	D - 76		
● - MZ5010C	D - 81	October, 1999	1 Year
● - Cable	C - 40 - 11	May, 1999	1 Year
● - Cable	C - 40 - 12	May, 1999	1 Year

Environmental conditions :

Temperature: 18 °C Humidity: 30 %

CONFIGURATION OF TUT

The Transmitter Under Test (TUT) consists of :

Description	Applicant (Manufacturer)	Model No. (Serial No.)	FCC ID
Cellular Phone	Matsushita Communication Ind. Co., Ltd. (Matsushita Communication Ind. Co., Ltd.)	EB-TX220 (--)	NWJ10A002A

The measurement was carried out with the following equipment connected :

Description	Grantee/Distributor	Model No. (Serial No.)	FCC ID
Battery	Matsushita Communication Ind. Co., Ltd.	EB-BL220 (--)	N/A
Handset Holder	Matsushita Communication Ind. Co., Ltd.	EB-KA220 (--)	N/A
Handsfree Unit	Matsushita Communication Ind. Co., Ltd.	EB-HF210 (--)	N/A
Private Handsfree Adapter	Matsushita Communication Ind. Co., Ltd.	EB-EM210 (--)	N/A
Interface Cable	Matsushita Communication Ind. Co., Ltd.	-- (--)	N/A
Microphone	Matsushita Communication Ind. Co., Ltd.	-- (--)	N/A
Speaker	Matsushita Communication Ind. Co., Ltd.	-- (--)	N/A
DC Power Cord	Matsushita Communication Ind. Co., Ltd.	-- (--)	N/A
DC Power Supply	KIKUSUI ELECTRONICS CORP.	PAB 18-1.8 (1420354)	N/A

Type of Interference Cable(s) and the AC Power Cord used with the TUT :

	Description	Port	Shielded Cable	Shell Material	Ferrite Core	Cable Length
1	TUT	Serial	NO	Nonmetal	NO	1.2 m
	Private Handsfree Adapter	---		Nonmetal		
2	TUT	ANT OUT	YES	Metal	NO	0.1 m
	20 dB Attenuator + 50Ω terminator	---		Metal		
3	TUT (used Interface Cable)	Serial	NO	Nonmetal	NO	1.8 m
	Handsfree Unit	MAIN UNIT		Nonmetal		
4	Handsfree Unit	Speaker	NO	Nonmetal	NO	1.8 m
	Speaker	--		--		
5	TUT	MIC	NO	Nonmetal	NO	3.5 m
	Microphone	--		--		
6	TUT	12V	NO	Nonmetal	NO	3.0 m
	DC Power Supply	DC OUT		Nonmetal		
7	AC Power Cord(DC Power Supply)	--	NO	--	NO	2.3 m
	1φ-2Pin Plug					

Test Configuration:

Operation - mode of the TUT:

The tests were carried out under 3 modulation types(2 types on 800MHz systems and 1 type on 1900 MHz systems) shown as follows :

1) 800 MHz systems

a) F3E : Continuous Wave

b) TDMA : The carrier wave is modulated by PN9 random pattern data, which causes the maximum spread on the spectrum specified in TIA/EIA IS-138-A.

2) 1900 MHz systems

TDMA : The carrier wave is modulated by PN9 random pattern data, which causes the maximum spread on the spectrum specified in TIA/EIA IS-138-A.

The tests were carried under 3 test configuration in page 30 shown as follows:

	Test Configuration	The condition of the transmitting antenna
1	Single Unit	Integrated antenna
2	Private Handsfree Adapter used	Integrated antenna
3	Handsfree Unit used	ANT OUT terminal with the Equivalent terminator

The evaluation of the unwanted radiation is respective values for the condition of the transmitting antenna shown as follows :

	The condition of the transmitting antenna	Evaluation Method
A	Integrated antenna	Radiated Field Strength at 3m
B	ANT OUT terminal with the Equivalent terminator	ERP

The tests were carried out under 9 combination patterns of 3 modulation types and 3 test configurations.

Test system:

The TUT is 2 communicating systems as one 800 MHz systems(Cellular Radiotelephone) and one 1900MHz systems(Broadband PCS).

The TUT has two ports as one serial port and one battery port.

The TUT also has a Handset Holder, a Handsfree Unit, a Private Handsfree Unit, an interface cable, a microphone, a speaker and a DC Power Cord, which are option.

Special accessories:

None

A) 800 MHz Systems:

Detailed Transmitter portion:

Transmitting frequency : 824.040 MHz(991ch) - 848.970 MHz(799ch)
1st Local frequency : 1004.040 MHz(991ch) - 1028.970 MHz(799ch)
2nd Local frequency : 180.00 MHz

Detailed Receiver portion:

Receiving frequency : 869.040 MHz(991ch) - 893.970 MHz(799ch)
1st Local frequency : 1004.040 MHz(991ch) - 1028.970 MHz(799ch)
2nd Local frequency : 135.06 MHz
1st Intermediate frequency : 135.00 MHz
2nd Intermediate frequency : 60 kHz

B) 1900 MHz Systems:

Detailed Transmitter portion:

Transmitting frequency : 1850.040 MHz(2ch) - 1909.920 MHz(1998ch)
1st Local frequency : 2065.080 MHz(2ch) - 2124.960 MHz(1998ch)
2nd Local frequency : 180.00 MHz

Detailed Receiver portion:

Receiving frequency : 1930.080 MHz(2ch) - 1989.960 MHz(1998ch)
1st Local frequency : 2065.080 MHz(2ch) - 2124.960 MHz(1998ch)
2nd Local frequency : 215.04 MHz
1st Intermediate frequency : 135.00 MHz
2nd Intermediate frequency : 60 kHz

Other Clock Frequency:

32 kHz, 60kHz, 19.44 MHz, 67.53 MHz, 90 MHz, 360 MHz, 107.52 MHz, 270.12 MHz, 430.08 MHz

TUT Modification

- - No modifications were conducted by JQA to achieve compliance to applied levels.
- - To achieve compliance to applied levels, the following change(s) were made by JQA during the compliance test.

The modification(s) will be implemented in all production models of this equipment.

Applicant : N/A Date : N/A
Typed Name : N/A Position : N/A

Responsible Party

Responsible Party of Test Item(Product)

Responsible party :

Contact Person :

Signatory

Deviation from standard

- - No deviations from the standard described in page 3.
- - The following deviations were employed from the standard described in page 3.

TEST RESULTS
- 800 MHz Systems -

Transmitter Power(TP)

The transmitter power is 0.513 W at 824.04 MHz
Uncertainty of measurement results +0.6 dB(2σ) -0.6 dB(2σ)

Remarks: _____

Transmitter Power(ERP)

The requirements are **● - Passed** **○ - Not Passed**
The Maximum ERP is 1.413 W at 836.40 MHz
Min. limit margin 7.0 dB at 836.40 MHz
Max. limit exceeding _____ dB at _____ MHz
Uncertainty of measurement results +1.3 dB(2σ) -1.3 dB(2σ)

Remarks: _____

Unwanted Radiation (9 kHz - 20 GHz)

The requirements are **● - Passed** **○ - Not Passed**
Min. limit margin 22.0 dB at 1648.08 MHz
Max. limit exceeding _____ dB at _____ MHz
Uncertainty of measurement results
9 kHz - 30 MHz +2.5 dB(2σ) -2.5 dB(2σ)
30 MHz - 1 GHz +4.1 dB(2σ) -4.2 dB(2σ)
1 GHz - 20 GHz +3.1 dB(2σ) -3.2 dB(2σ)

Remarks: _____

SUMMARY

GENERAL REMARKS :

The TUT was tested according to the three requirements (shown as follows) at the request of the applicant of FCC Rules and Regulations Parts 22 and 24 (October 1, 1998) under the test configuration, as shown in page 30.

※Three measurement items shown as follows were performed at the request of the applicant.

- 1) Transmitter Power (TP)
- 2) Maximum Transmitter Power (EIRP/ERP)
- 3) Unwanted Radiation

The conclusion for the test items of which are required by the applied regulation is indicated under the final judgement.

FINAL JUDGEMENT :

The "as received" sample;

- - fulfill the test requirements of the regulation mentioned on page 3.
- - fulfill the test requirements of the regulation mentioned on page 3, but with certain qualifications.
- - doesn't fulfill the test regulation mentioned on page 3.

Begin of testing : April 13, 2000

End of testing : April 21, 2000

- JAPAN QUALITY ASSURANCE ORGANIZATION -

Approved by :



Takashi Yamanaka
Manager
EMC Div.
JQA KITA-KANSAI Testing Center

Issued by :

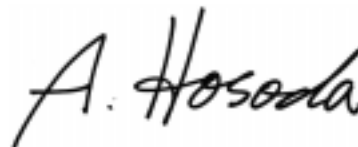

Akio Hosoda
Project Manager
EMC Div.
JQA KITA-KANSAI Testing Center

Test System-Arrangement (Drawings)

1) Single Unit

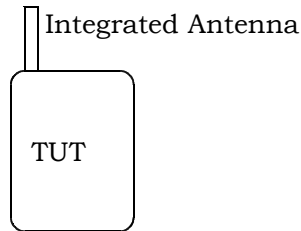

2) Private Handsfree Adapter used

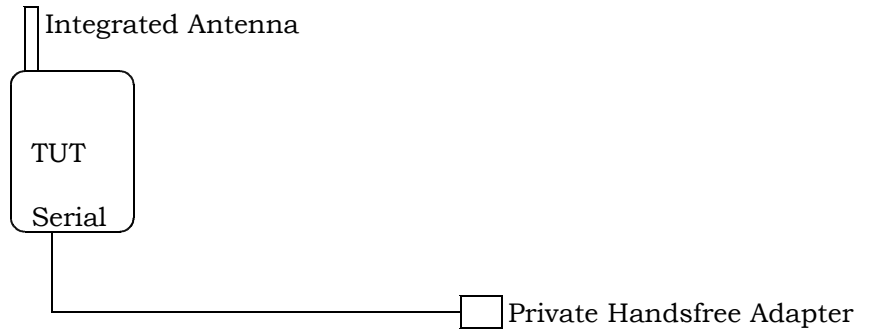

3) Handsfree Unit Used

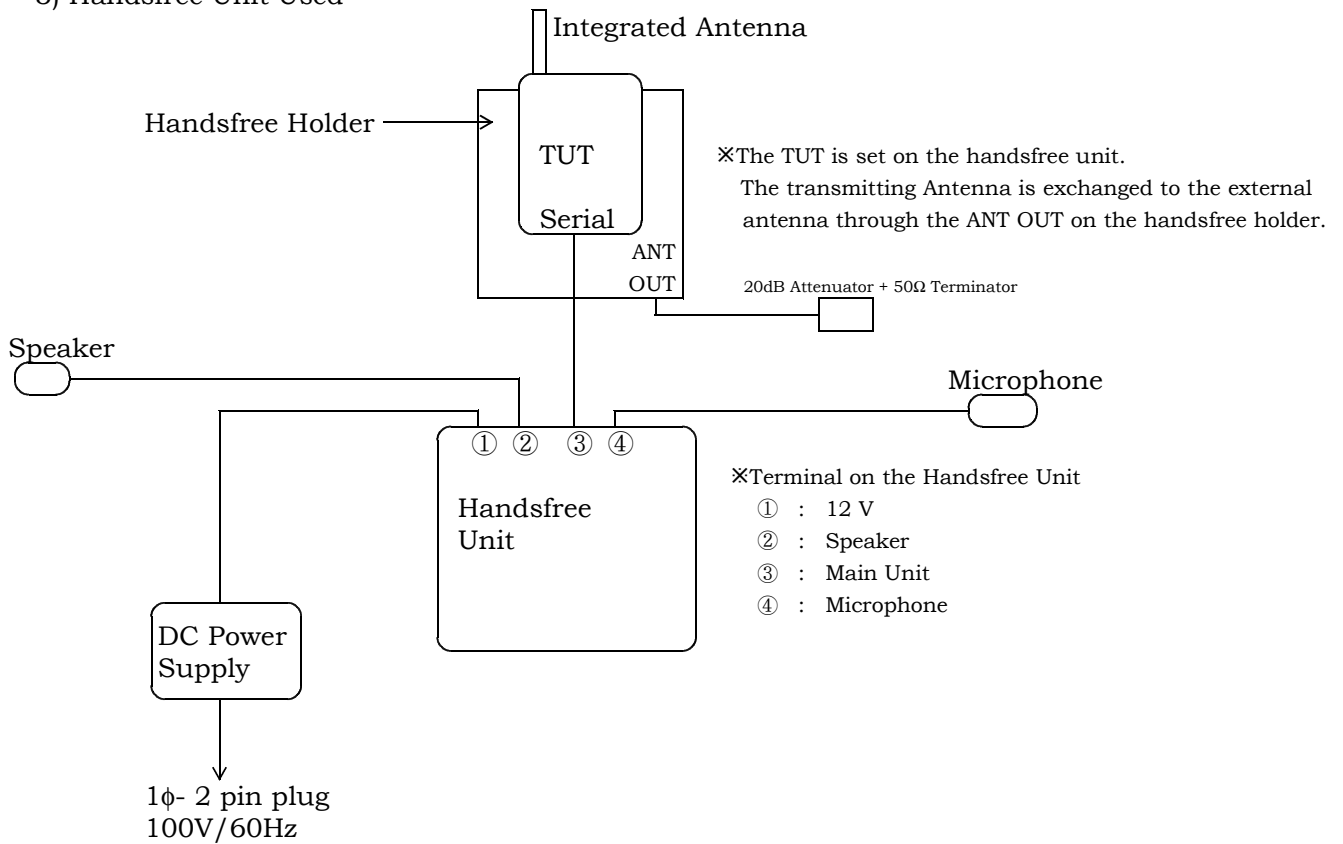

- ※Terminal on the Handsfree Unit
- ① : 12 V
 - ② : Speaker
 - ③ : Main Unit
 - ④ : Microphone

Test-Setup (Photographs) at worst case

800 MHz Systems



1900 MHz Systems



Horizontal Polarization



Horizontal Polarization



Vertical Polarization

Vertical Polarization

Transmitter Power(TP) Measurement
- 800 MHz Systems -

Test Date: April 19, 2000
Temp.: 18 °C; Humi.: 30 %

Measurement Results:

1) Modulation Type : F3E

Frequency (MHz)	Transmitter Power (W)
824.04	0.339
836.40	0.316
848.97	0.339

2) Modulation Type : TDMA

Frequency (MHz)	Transmitter Power (W)
824.04	0.513
836.40	0.479
848.97	0.490

The point shown on "___" is the Maximum level Point.

Tester Signature : _____



Type Name : Akio Hosoda

Transmitter Power(ERP) Measurement
- 800 MHz Systems -

Test Date: April 21 , 2000
Temp.: 19 °C; Humi.: 59 %

Measurement Results:

1-a) Test Configuration : Single Unit
Modulation Type : F3E

Frequency (MHz)	Maximum Transmitter Power ERP(W)		Limits (W)	Margin (dB)
	Hori.	Vert.		
824.04	0.513	0.447	7.0	+11.4
836.40	0.537	0.575	7.0	+10.9
848.97	0.437	0.776	7.0	+12.1

1-b) Test Configuration : Private Handsfree Adapter used
Modulation Type : F3E

Frequency (MHz)	Maximum Transmitter Power ERP(W)		Limits (W)	Margin (dB)
	Hori.	Vert.		
824.04	0.447	0.282	7.0	+12.0
836.40	0.437	0.407	7.0	+12.1
848.97	0.427	0.550	7.0	+11.1

2-a) Test Configuration : Single Unit
Modulation Type : TDMA

Frequency (MHz)	Maximum Transmitter Power ERP(W)		Limits (W)	Margin (dB)
	Hori.	Vert.		
824.04	1.148	1.175	7.0	+ 7.8
836.40	1.413	1.122	7.0	+ 7.0
848.97	1.047	1.230	7.0	+ 7.6

2-b) Test Configuration : Private Handsfree Adapter used
Modulation Type : TDMA

Frequency (MHz)	Maximum Transmitter Power ERP(W)		Limits (W)	Margin (dB)
	Hori.	Vert.		
824.04	0.550	0.490	7.0	+11.1
836.40	0.832	0.562	7.0	+ 9.3
848.97	0.692	0.871	7.0	+ 9.1

Minimum Margin at 836.04 MHz : $10\log_{10}(7.0/1.413) = 7.0(\text{dB})$
The point shown on " ___ " is the Minimum Margin Point.

Tester Signature : 

Type Name : Akio Hosoda

Unwanted Radiation Measurement
 - 800 MHz Systems -

Test Date: April 14, 2000
 Temp.: 18 °C; Humi.: 30 %

Measurement Results:

1-a-1) Test Configuration : Single Unit
 Modulation Type : F3E
 Transmitting Frequency : 824.04 MHz

Frequency (MHz)	Corr. Factor (dB)	Meter Reading [dB(μV)]		Results [dB(μV/m)]		Limits* [dB(μV/m)]	Margin (dB)	Remarks (Note 3)
		Horiz.	Vert.	Horiz.	Vert.			
824.04	34.4	94.0	92.3	128.4	126.7	----	----	F
1648.08	-6.3	63.0	62.0	56.7	55.7	90.1	+33.4	E
2472.12	-0.4	61.0	55.0	60.6	54.6	90.1	+29.5	B
3296.16	0.8	32.0	51.0	32.8	51.8	90.1	+38.3	B
4120.20	6.4	<30.0	<30.0	<36.4	<36.4	90.1	>+53.7	B
4944.24	5.9	<30.0	<30.0	<35.9	<35.9	90.1	>+54.2	B
5768.28	6.8	<30.0	<30.0	<36.8	<36.8	90.1	>+53.3	B
6592.32	9.9	<30.0	<30.0	<39.9	<39.9	90.1	>+50.2	B
7416.36	10.6	<30.0	<30.0	<40.6	<40.6	90.1	>+49.5	B
8240.40	5.7	<30.0	<30.0	<35.7	<35.7	90.1	>+54.4	C

※ : Limit = 128.4(Maximum at 824.04 MHz) - [43 + 10log(0.339)] = 90.1 [dB(μV/m)]

1-a-2) Test Configuration : Single Unit
 Modulation Type : F3E
 Transmitting Frequency : 836.40 MHz

Frequency (MHz)	Corr. Factor (dB)	Meter Reading [dB(μV)]		Results [dB(μV/m)]		Limits* [dB(μV/m)]	Margin (dB)	Remarks (Note 3)
		Horiz.	Vert.	Horiz.	Vert.			
836.40	34.5	93.9	92.6	128.4	127.1	----	----	F
1672.80	-6.3	55.0	48.0	48.7	41.7	90.4	+41.7	E
2509.20	-0.6	58.0	54.0	57.4	53.4	90.4	+33.0	B
3345.60	0.9	44.0	35.0	44.9	35.9	90.4	+45.5	B
4182.00	6.4	<30.0	<30.0	<36.4	<36.4	90.4	>+54.0	B
5018.40	5.9	<30.0	<30.0	<35.9	<35.9	90.4	>+54.5	B
5854.80	9.3	<30.0	<30.0	<39.3	<39.3	90.4	>+51.1	B
6691.20	9.9	<30.0	<30.0	<39.9	<39.9	90.4	>+50.5	B
7527.60	10.7	<30.0	<30.0	<40.7	<40.7	90.4	>+49.7	B
8364.00	5.7	<30.0	<30.0	<35.7	<35.7	90.4	>+54.7	C

※ : Limit = 128.4(Maximum at 836.40 MHz) - [43 + 10log(0.316)] = 90.4 [dB(μV/m)]

1-a-3) Test Configuration : Single Unit
 Modulation Type : F3E
 Transmitting Frequency : 848.97 MHz

Frequency (MHz)	Corr. Factor (dB)	Meter Reading [dB(μV)]		Results [dB(μV/m)]		Limits* [dB(μV/m)]	Margin (dB)	Remarks (Note 3)
		Horiz.	Vert.	Horiz.	Vert.			
848.97	34.7	93.4	92.0	128.1	126.7	----	----	F
1697.94	-6.7	62.0	59.0	55.3	52.3	89.8	+34.5	E
2546.91	-0.6	59.0	55.0	58.4	54.4	89.8	+31.4	B
3395.88	2.8	54.0	46.0	56.8	48.8	89.8	+33.0	B
4244.85	6.4	<30.0	<30.0	<36.4	<36.4	89.8	>+53.4	B
5093.82	6.0	<30.0	<30.0	<36.0	<36.0	89.8	>+53.8	B
5942.79	9.6	<30.0	<30.0	<39.6	<39.6	89.8	>+50.2	B
6791.76	9.9	<30.0	<30.0	<39.9	<39.9	89.8	>+49.9	B
7640.73	1.9	<30.0	<30.0	<31.9	<31.9	89.8	>+57.9	B
8489.70	5.6	<30.0	<30.0	<35.6	<35.6	89.8	>+54.2	C

※ : Limit = 128.1(Maximum at 848.97 MHz) - [43 + 10log(0.339)] = 89.8 [dB(μV/m)]

1-b-1) Test Configuration : Private Handsfree Adapter used
 Modulation Type : F3E
 Transmitting Frequency : 824.04 MHz

Frequency (MHz)	Corr. Factor (dB)	Meter Reading [dB(μV)]		Results [dB(μV/m)]		Limits* [dB(μV/m)]	Margin (dB)	Remarks (Note 3)
		Horiz.	Vert.	Horiz.	Vert.			
824.04	34.4	93.4	90.3	127.8	124.7	89.5	----	F
1648.08	-6.3	63.0	63.0	56.7	56.7	89.5	+32.8	E
2472.12	-0.4	61.0	54.0	60.6	53.6	89.5	+28.9	B
3296.16	0.8	31.0	50.0	31.8	50.8	89.5	+38.7	B
4120.20	6.4	<30.0	<30.0	<36.4	<36.4	89.5	>+53.1	B
4944.24	5.9	<30.0	<30.0	<35.9	<35.9	89.5	>+53.6	B
5768.28	6.8	<30.0	<30.0	<36.8	<36.8	89.5	>+52.7	B
6592.32	9.9	<30.0	<30.0	<39.9	<39.9	89.5	>+49.6	B
7416.36	10.6	<30.0	<30.0	<40.6	<40.6	89.5	>+48.9	B
8240.40	5.7	<30.0	<30.0	<35.7	<35.7	89.5	>+53.8	C

* : Limit = 127.8(Maximum at 824.04 MHz) - [43 + 10log(0.339)] = 89.5 [dB(μV/m)]

1-b-2) Test Configuration : Private Handsfree Adapter used
 Modulation Type : F3E
 Transmitting Frequency : 836.40 MHz

Frequency (MHz)	Corr. Factor (dB)	Meter Reading [dB(μV)]		Results [dB(μV/m)]		Limits* [dB(μV/m)]	Margin (dB)	Remarks (Note 3)
		Horiz.	Vert.	Horiz.	Vert.			
836.40	34.5	93.0	91.1	127.5	125.6	-----	-----	F
1672.80	-6.3	55.0	48.0	48.7	41.7	89.5	+40.8	E
2509.20	-0.6	58.0	53.0	57.4	52.4	89.5	+32.1	B
3345.60	0.9	44.0	37.0	44.9	37.9	89.5	+44.6	B
4182.00	6.4	<30.0	<30.0	<36.4	<36.4	89.5	>+53.1	B
5018.40	5.9	<30.0	<30.0	<35.9	<35.9	89.5	>+53.6	B
5854.80	9.3	<30.0	<30.0	<39.3	<39.3	89.5	>+50.2	B
6691.20	9.9	<30.0	<30.0	<39.9	<39.9	89.5	>+49.6	B
7527.60	10.7	<30.0	<30.0	<40.7	<40.7	89.5	>+48.8	B
8364.00	5.7	<30.0	<30.0	<35.7	<35.7	89.5	>+53.8	C

* : Limit = 127.5(Maximum at 836.40 MHz) - [43 + 10log(0.316)] = 89.5 [dB(μV/m)]

1-b-3) Test Configuration : Private Handsfree Adapter used
 Modulation Type : F3E
 Transmitting Frequency : 848.97 MHz

Frequency (MHz)	Corr. Factor (dB)	Meter Reading [dB(μV)]		Results [dB(μV/m)]		Limits* [dB(μV/m)]	Margin (dB)	Remarks (Note 3)
		Horiz.	Vert.	Horiz.	Vert.			
848.97	34.7	93.3	90.5	128.0	125.2	---	---	F
1697.94	-6.7	67.0	61.0	60.3	54.3	89.7	+29.4	E
2546.91	-0.6	60.0	55.0	59.4	54.4	89.7	+30.3	B
3395.88	2.8	55.0	46.0	57.8	48.8	89.7	+31.9	B
4244.85	6.4	<30.0	<30.0	<36.4	<36.4	89.7	>+53.3	B
5093.82	6.0	<30.0	<30.0	<36.0	<36.0	89.7	>+53.7	B
5942.79	9.6	<30.0	<30.0	<39.6	<39.6	89.7	>+50.1	B
6791.76	9.9	<30.0	<30.0	<39.9	<39.9	89.7	>+49.8	B
7640.73	1.9	<30.0	<30.0	<31.9	<31.9	89.7	>+57.8	C
8489.70	5.6	<30.0	<30.0	<35.6	<35.6	89.7	>+54.1	C

* : Limit = 128.0(Maximum at 848.97 MHz) - [43 + 10log(0.339)] = 89.7 [dB(μV/m)]

1-c-1) Test Configuration : Handsfree Unit used
 Modulation Type : F3E
 Transmitting Frequency : 824.04 MHz

Frequency (MHz)	ERP [dBm]		Limits [dBm]	Margin (dB)	Remarks (Note 3)
	Hori.	Vert.			
1648.08	-35.0	-38.0	-13.0	+22.0	E
2472.12	-42.8	-42.8	-13.0	+29.8	B
3296.16	-48.6	-51.6	-13.0	+35.6	B
4120.20	<-61.0	<-61.0	-13.0	>+48.0	B
4944.24	<-61.5	<-61.5	-13.0	>+48.5	B
5768.28	<-60.6	<-60.6	-13.0	>+47.6	B
6592.32	<-57.5	<-57.5	-13.0	>+44.5	B
7416.36	<-56.8	<-56.8	-13.0	>+43.8	B
8240.40	<-61.7	<-61.7	-13.0	>+48.7	C

1-c-2) Test Configuration : Handsfree Unit used
 Modulation Type : F3E
 Transmitting Frequency : 836.40MHz

Frequency (MHz)	ERP [dBm]		Limits [dBm]	Margin (dB)	Remarks (Note 3)
	Hori.	Vert.			
1672.80	-40.0	-42.0	-13.0	+27.0	E
2509.20	-39.0	-41.0	-13.0	+26.0	B
3345.60	-46.5	-50.5	-13.0	+33.5	B
4182.00	<-61.0	<-61.0	-13.0	>+48.0	B
5018.40	<-61.5	<-61.5	-13.0	>+48.5	B
5854.80	<-58.1	<-58.1	-13.0	>+45.1	B
6691.20	<-57.5	<-57.5	-13.0	>+44.5	B
7527.60	<-56.7	<-56.7	-13.0	>+43.7	B
8364.00	<-61.7	<-61.7	-13.0	>+48.7	C

JQA Application No.: KL80000030
Model No. : EB-TX220
FCC ID : NWJ10A002A

Regulation : CFR 47 FCC Rules Parts 22 and 24
Issue Date : April 28, 2000

1-c-3) Test Configuration : Handsfree Unit used
Modulation Type : F3E
Transmitting Frequency : 848.97 MHz

Frequency (MHz)	ERP [dBm]		Limits [dBm]	Margin (dB)	Remarks (Note 3)
	Hori.	Vert.			
1697.94	-39.4	-41.4	-13.0	+26.4	E
2546.91	-40.0	-40.0	-13.0	+27.0	B
3395.88	-43.6	-46.6	-13.0	+30.6	B
4244.85	<-61.0	<-61.0	-13.0	>+48.0	B
5093.82	<-61.4	<-61.4	-13.0	>+48.4	B
5942.79	<-57.8	<-57.8	-13.0	>+44.8	B
6791.76	<-57.5	<-57.5	-13.0	>+44.5	B
7640.73	<-65.5	<-65.5	-13.0	>+52.5	C
8489.70	<-61.8	<-61.8	-13.0	>+48.8	C

2-a-1) Test Configuration : Single Unit
 Modulation Type : TDMA
 Transmitting Frequency : 824.04 MHz

Frequency (MHz)	Corr. Factor (dB)	Meter Reading [dB(μV)]		Results [dB(μV/m)]		Limits* [dB(μV/m)]	Margin (dB)	Remarks (Note 3)
		Horiz.	Vert.	Horiz.	Vert.			
824.04	34.4	97.5	96.5	131.9	130.9	-----	-----	F
1648.08	-6.3	59.0	57.0	52.7	50.7	91.8	+39.1	E
2472.12	-0.4	55.0	55.0	54.6	54.6	91.8	+37.2	B
3296.16	0.8	44.0	44.0	44.8	44.8	91.8	+47.0	B
4120.20	6.4	<30.0	<30.0	<36.4	<36.4	91.8	>+55.4	B
4944.24	5.9	<30.0	<30.0	<35.9	<35.9	91.8	>+55.9	B
5768.28	6.8	<30.0	<30.0	<36.8	<36.8	91.8	>+55.0	B
6592.32	9.9	<30.0	<30.0	<39.9	<39.9	91.8	>+51.9	B
7416.36	10.6	<30.0	<30.0	<40.6	<40.6	91.8	>+51.2	B
8240.40	5.7	<30.0	<30.0	<35.7	<35.7	91.8	>+56.1	C

* : Limit = 131.9(Maximum at 824.04 MHz) - [43 + 10log(0.513)] = 91.8[dB(μV/m)]

2-a-2) Test Configuration : Single Unit
 Modulation Type : TDMA
 Transmitting Frequency : 836.40 MHz

Frequency (MHz)	Corr. Factor (dB)	Meter Reading [dB(μV)]		Results [dB(μV/m)]		Limits* [dB(μV/m)]	Margin (dB)	Remarks (Note 3)
		Horiz.	Vert.	Horiz.	Vert.			
836.40	34.5	98.1	95.5	132.6	130.0	-----	-----	F
1672.80	-6.3	56.0	59.0	49.7	52.7	92.8	+40.1	E
2509.20	-0.6	60.0	54.0	59.4	53.4	92.8	+33.4	B
3345.60	0.9	37.0	32.0	37.9	32.9	92.8	+54.9	B
4182.00	6.4	<30.0	<30.0	<36.4	<36.4	92.8	>+56.4	B
5018.40	5.9	<30.0	<30.0	<35.9	<35.9	92.8	>+56.9	B
5854.80	9.3	<30.0	<30.0	<39.3	<39.3	92.8	>+53.5	B
6691.20	9.9	<30.0	<30.0	<39.9	<39.9	92.8	>+52.9	B
7527.60	10.7	<30.0	<30.0	<40.7	<40.7	92.8	>+52.1	B
8364.00	5.7	<30.0	<30.0	<35.7	<35.7	92.8	>+57.1	C

* : Limit = 132.6(Maximum at 836.40 MHz) - [43 + 10log(0.479)] = 92.8 [dB(μV/m)]

2-a-3) Test Configuration : Single Unit
 Modulation Type : TDMA
 Transmitting Frequency : 848.97 MHz

Frequency (MHz)	Corr. Factor (dB)	Meter Reading [dB(μV)]		Results [dB(μV/m)]		Limits* [dB(μV/m)]	Margin (dB)	Remarks (Note 3)
		Horiz.	Vert.	Horiz.	Vert.			
848.97	34.7	97.2	94.0	131.9	128.7	-----	-----	F
1697.94	-6.7	59.0	58.0	52.3	51.3	92.0	+39.7	E
2546.91	-0.6	56.0	53.0	55.4	52.4	92.0	+36.6	B
3395.88	2.8	47.0	41.0	49.8	43.8	92.0	+42.2	B
4244.85	6.4	<30.0	<30.0	<36.4	<36.4	92.0	>+55.6	B
5093.82	6.0	<30.0	<30.0	<36.0	<36.0	92.0	>+56.0	B
5942.79	9.6	<30.0	<30.0	<39.6	<39.6	92.0	>+52.4	B
6791.76	9.9	<30.0	<30.0	<39.9	<39.9	92.0	>+52.1	B
7640.73	1.9	<30.0	<30.0	<31.9	<31.9	92.0	>+60.1	C
8489.70	5.6	<30.0	<30.0	<35.6	<35.6	92.0	>+56.4	C

※ : Limit = 131.9(Maximum at 848.97 MHz) - [43 + 10log(0.490)] = 92.0 [dB(μV/m)]

2-b-1) Test Configuration : Private Handsfree Adapter used
 Modulation Type : TDMA
 Transmitting Frequency : 824.04 MHz

Frequency (MHz)	Corr. Factor (dB)	Meter Reading [dB(μV)]		Results [dB(μV/m)]		Limits* [dB(μV/m)]	Margin (dB)	Remarks (Note 3)
		Horiz.	Vert.	Horiz.	Vert.			
824.04	34.4	94.3	92.7	128.7	127.1	---	---	F
1648.08	-6.3	59.0	52.0	52.7	45.7	88.6	+35.9	E
2472.12	-0.4	54.0	54.0	53.6	53.6	88.6	+35.0	B
3296.16	0.8	44.0	47.0	44.8	47.8	88.6	+40.8	B
4120.20	6.4	<30.0	<30.0	<36.4	<36.4	88.6	>+52.2	B
4944.24	5.9	<30.0	<30.0	<35.9	<35.9	88.6	>+52.7	B
5768.28	6.8	<30.0	<30.0	<36.8	<36.8	88.6	>+51.8	B
6592.32	9.9	<30.0	<30.0	<39.9	<39.9	88.6	>+48.7	B
7416.36	10.6	<30.0	<30.0	<40.6	<40.6	88.6	>+48.0	B
8240.40	5.7	<30.0	<30.0	<35.7	<35.7	88.6	>+52.9	C

* : Limit = 128.7(Maximum at 824.04 MHz) - [43 + 10log(0.513)] = 88.6 [dB(μV/m)]

2-b-2) Test Configuration : Private Handsfree Adapter used
 Modulation Type : TDMA
 Transmitting Frequency : 836.40 MHz

Frequency (MHz)	Corr. Factor (dB)	Meter Reading [dB(μV)]		Results [dB(μV/m)]		Limits* [dB(μV/m)]	Margin (dB)	Remarks (Note 3)
		Horiz.	Vert.	Horiz.	Vert.			
836.40	34.5	95.8	92.5	130.3	127.0	-----	-----	F
1672.80	-6.3	57.0	59.0	50.7	52.7	90.5	+37.8	E
2509.20	-0.6	61.0	54.0	60.4	53.4	90.5	+30.1	B
3345.60	0.9	38.0	33.0	38.9	33.9	90.5	+51.6	B
4182.00	6.4	<30.0	<30.0	<36.4	<36.4	90.5	>+54.1	B
5018.40	5.9	<30.0	<30.0	<35.9	<35.9	90.5	>+54.6	B
5854.80	9.3	<30.0	<30.0	<39.3	<39.3	90.5	>+51.2	B
6691.20	9.9	<30.0	<30.0	<39.9	<39.9	90.5	>+50.6	B
7527.60	10.7	<30.0	<30.0	<40.7	<40.7	90.5	>+49.8	B
8364.00	5.7	<30.0	<30.0	<35.7	<35.7	90.5	>+54.8	C

* : Limit = 130.3(Maximum at 836.40 MHz) - [43 + 10log(0.479)] = 90.5 [dB(μV/m)]

2-b-3) Test Configuration : Private Handsfree Adapter used
 Modulation Type : TDMA
 Transmitting Frequency : 848.97 MHz

Frequency (MHz)	Corr. Factor (dB)	Meter Reading [dB(μV)]		Results [dB(μV/m)]		Limits* [dB(μV/m)]	Margin (dB)	Remarks (Note 3)
		Horiz.	Vert.	Horiz.	Vert.			
848.97	34.7	95.4	92.5	130.1	127.2	-----	-----	F
1697.94	-6.7	58.0	62.0	51.3	55.3	90.2	34.9	E
2546.91	-0.6	59.0	55.0	58.4	54.4	90.2	31.8	B
3395.88	2.8	48.0	42.0	50.8	44.8	90.2	39.4	B
4244.85	6.4	<30.0	<30.0	<36.4	<36.4	90.2	>+53.8	B
5093.82	6.0	<30.0	<30.0	<36.0	<36.0	90.2	>+54.2	B
5942.79	9.6	<30.0	<30.0	<39.6	<39.6	90.2	>+50.6	B
6791.76	9.9	<30.0	<30.0	<39.9	<39.9	90.2	>+50.3	B
7640.73	1.9	<30.0	<30.0	<31.9	<31.9	90.2	>+58.3	C
8489.70	5.6	<30.0	<30.0	<35.6	<35.6	90.2	>+54.6	C

* : Limit = 130.1(Maximum at 848.97 MHz) - [43 + 10log(0.490)] = 90.2 [dB(μV/m)]

2-c-1) Test Configuration : Handsfree Unit used
 Modulation Type : TDMA
 Transmitting Frequency : 824.04 MHz

Frequency (MHz)	ERP [dBm]		Limits [dBm]	Margin (dB)	Remarks (Note 3)
	Hori.	Vert.			
1648.08	-50.0	-49.0	-13.0	+36.0	E
2472.12	-50.8	-48.8	-13.0	+35.8	B
3296.16	-54.6	-59.6	-13.0	+41.6	B
4120.20	<-61.0	<-61.0	-13.0	>+48.0	B
4944.24	<-61.5	<-61.5	-13.0	>+48.5	B
5768.28	<-60.6	<-60.6	-13.0	>+47.6	B
6592.32	<-57.5	<-57.5	-13.0	>+44.5	B
7416.36	<-56.8	<-56.8	-13.0	>+43.8	B
8240.40	<-61.7	<-61.7	-13.0	>+48.7	C

2-c-2) Test Configuration : Handsfree Unit used
 Modulation Type : TDMA
 Transmitting Frequency : 846.40 MHz

Frequency (MHz)	ERP [dBm]		Limits [dBm]	Margin (dB)	Remarks (Note 3)
	Hori.	Vert.			
1672.80	-40.0	-44.0	-13.0	+27.0	E
2509.20	-42.0	-43.0	-13.0	+29.0	B
3345.60	-56.5	-57.5	-13.0	+43.5	B
4182.00	<-61.0	<-61.0	-13.0	>+48.0	B
5018.40	<-61.5	<-61.5	-13.0	>+48.5	B
5854.80	<-58.1	<-58.1	-13.0	>+45.1	B
6691.20	<-57.5	<-57.5	-13.0	>+44.5	B
7527.60	<-56.7	<-56.7	-13.0	>+43.7	B
8364.00	<-61.7	<-61.7	-13.0	>+48.7	C

2-c-3) Test Configuration : Handsfree Unit used
Modulation Type : TDMA
Transmitting Frequency : 848.97 MHz

Frequency (MHz)	ERP [dBm]		Limits [dBm]	Margin (dB)	Remarks (Note 3)
	Hori.	Vert.			
1697.94	-45.4	-48.4	-13.0	+32.4	E
2546.91	-38.0	-40.0	-13.0	+25.0	B
3395.88	-50.6	-52.6	-13.0	+37.6	B
4244.85	<-61.0	<-61.0	-13.0	>+48.0	B
5093.82	<-61.4	<-61.4	-13.0	>+48.4	B
5942.79	<-57.8	<-57.8	-13.0	>+44.8	B
6791.76	<-57.5	<-57.5	-13.0	>+44.5	B
7640.73	<-65.5	<-65.5	-13.0	>+52.5	C
8489.70	<-61.8	<-61.8	-13.0	>+48.8	C

Sample of calculated result at 1648.08 MHz, as the Minimum Margin point:
 Minimum Margin : $-13.0 - (-35.0) = 22.0(\text{dB})$
 The point shown on " ___ " is the Minimum Margin Point.

Applied limits :

A) Radiated Field Strength at 3 m

Applied limits $[\text{dB}(\mu\text{V}/\text{m})] = \text{Field Strength} [\text{dB}(\mu\text{V}/\text{m})]$ at Maximum Fundamental Frequency - $[43 + 10\log[\text{tp}(\text{W})]]$
 Where $\text{tp}(\text{W})$: Transmitter Power at antenna terminal under test configuration as the handsfree unit used.

B) ERP

Applied limits $= 10\log[\text{TP}(\text{mW})] - [43 + 10\log[\text{tp}(\text{W})]] = 10\log[\text{TP}(\text{mW})] - [43 + (10\log[\text{TP}(\text{mW})] - 30)]$
 $= -13 [\text{dBm}]$

Where $\text{tp}(\text{W}) = \text{TP}(\text{mW}) / 1000$: Transmitter Power at antenna terminal under test configuration as the handsfree unit used.

$$10\log[\text{tp}(\text{W})] = 10\log[\text{TP}(\text{mW})] - 30$$

- Note : 1. The spectrum was checked from 9 kHz up to 20 GHz.
 2. All emissions not listed were found to be more than 20dB below the limit.

Remarks:

Note 3	Detector Function	RES. B.W	V.B.W	Sweep T	Span	Corr. Factor *
A	AVE (SP)	1 MHz	1 MHz	20 msec	0 Hz	ANT+CL+P10
B	AVE (SP)	1 MHz	1 MHz	20 msec	0 Hz	ANT+CL+P20-Amp.
C	AVE (SP)	1 MHz	1 MHz	20 msec	0 Hz	ANT+CL+P10-Amp.
D	AVE (SP)	1 MHz	1 MHz	20 msec	0 Hz	ANT+CL+P10-Amp.+Mix.
E	AVE (SP)	1 MHz	1 MHz	20 msec	0 Hz	ANT+CL+HPF+P10-Amp.
F	AVE (ESV)	120 kHz	--	--	--	ANT+CL

*)ANT:Antenna Factor/CL: Cable Loss/ P20: 20dB Att. / P10: 10dB Att. / Amp.: Amplifier Gain/
 Mix.: Mixer Conversion Loss/ HPF : High Pass Filter loss

Tester Signature : 

Type Name : Akio Hosoda

JQA Application No.: KL8000030
Model No. : EB-TX220
FCC ID : NWJ10A002A

Regulation : CFR 47 FCC Rules Parts 22 and 24
Issue Date : April 28, 2000

Transmitter Power(TP) Measurement
- 1900 MHz Systems -

Test Date: April 19, 2000
Temp.: 18 °C; Humi.: 30 %

Measurement Results:

Modulation Type : TDMA

Frequency (MHz)	Transmitter Power (W)
1850.04	0.437
1879.98	0.437
1909.92	0.490

The point shown on "___" is the Maximum level Point.

Tester Signature : _____

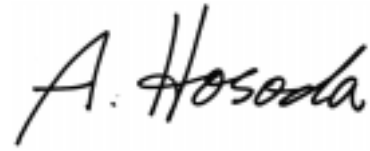

Type Name : Akio Hosoda

Transmitter Power(EIRP) Measurement
- 1900 MHz Systems -

Test Date: April 19, 2000
Temp.: 18 °C; Humi.: 30 %

Measurement Results:

- 1) Test Configuration : Single Unit
Modulation Type : TDMA

Frequency (MHz)	Maximum Transmitter Power EIRP(W)		Limits (W)	Margin (dB)
	Hori.	Vert.		
1850.04	0.011	0.003	2.0	+22.6
1879.98	0.007	0.002	2.0	+24.7
1909.92	0.008	0.003	2.0	+23.7

- 2) Test Configuration : Private Handset Adapter used
Modulation Type : TDMA

Frequency (MHz)	Maximum Transmitter Power EIRP(W)		Limits (W)	Margin (dB)
	Hori.	Vert.		
1850.04	0.011	0.003	2.0	+22.6
1879.98	0.007	0.003	2.0	+24.7
1909.92	0.008	0.003	2.0	+23.7

Minimum Margin at 1850.04 MHz : $10\log_{10}(2.0/0.011) = 22.6(\text{dB})$
The point shown on "___" is the Minimum Margin Point.

Tester Signature : _____



Type Name : Akio Hosoda

Unwanted Radiation Measurement
 - 1900 MHz Systems -

Test Date: April 13,2000
 Temp.: 18 °C; Humi.: 30 %

Measurement Results:

a-1) Test Configuration : Single Unit
 Modulation Type : TDMA
 Transmitting Frequency : 1850.04 MHz

Frequency (MHz)	Corr. Factor (dB)	Meter Reading [dB(μV)]		Results [dB(μV/m)]		Limits* [dB(μV/m)]	Margin (dB)	Remarks (Note 3)
		Horiz.	Vert.	Horiz.	Vert.			
1850.04	31.6	74.0	68.0	105.6	99.6	----	----	A
3700.08	2.9	49.0	44.0	51.9	46.9	66.2	+14.3	B
5550.12	6.4	37.0	38.0	43.4	44.4	66.2	+21.8	B
7400.16	10.6	38.0	37.0	48.6	47.6	66.2	+17.6	B
9250.20	5.7	38.0	39.0	43.7	44.7	66.2	+21.5	C
11100.24	6.6	36.0	37.0	42.6	43.6	66.2	+22.6	C
12950.28	10.5	<30.0	<30.0	<40.5	<40.5	66.2	>+25.7	C
14800.32	10.2	<30.0	<30.0	<40.2	<40.2	66.2	>+26.0	C
16650.36	10.1	<30.0	<30.0	<40.1	<40.1	66.2	>+26.1	C
18500.40	20.4	<30.0	<30.0	<50.4	<50.4	66.2	>+15.8	D

※ : Limit = 105.6(Maximum at 1850.04 MHz) - [43 + 10log(0.437)] = 66.2 [dB(μV/m)]

a-2) Test Configuration : Single Unit
 Modulation Type : TDMA
 Transmitting Frequency : 1879.98 MHz

Frequency (MHz)	Corr. Factor (dB)	Meter Reading [dB(μV)]		Results [dB(μV/m)]		Limits* [dB(μV/m)]	Margin (dB)	Remarks (Note 3)
		Horiz.	Vert.	Horiz.	Vert.			
1879.98	31.5	72.0	67.0	103.5	98.5	----	----	A
3759.96	2.9	52.0	45.0	54.9	47.9	64.1	+ 9.2	B
5639.94	6.6	39.0	38.0	45.6	44.6	64.1	+18.5	B
7519.92	10.7	40.0	43.0	50.7	53.7	64.1	+10.4	B
9399.90	5.7	36.0	38.0	41.7	43.7	64.1	+20.4	C
11279.88	6.6	<30.0	31.0	<36.6	37.6	64.1	+26.5	C
13159.86	10.5	<30.0	31.0	<40.5	41.5	64.1	+22.6	C
15039.84	10.1	32.0	34.0	42.1	44.1	64.1	+20.0	C
16919.82	10.1	<30.0	31.0	<40.1	41.1	64.1	+23.0	C
18799.80	20.6	<30.0	<30.0	<50.6	<50.6	64.1	>+13.5	D

※ : Limit = 103.5(Maximum at 1879.98 MHz) - [43 + 10log(0.437)] = 64.1 [dB(μV/m)]

a-3) Test Configuration : Single Unit
 Modulation Type : TDMA
 Transmitting Frequency : 1909.92 MHz

Frequency (MHz)	Corr. Factor (dB)	Meter Reading [dB(μV)]		Results [dB(μV/m)]		Limits* [dB(μV/m)]	Margin (dB)	Remarks (Note 3)
		Horiz.	Vert.	Horiz.	Vert.			
1909.92	31.5	73.0	68.0	104.5	99.5	-----	-----	A
3819.84	3.0	51.0	47.0	54.0	50.0	64.6	+10.6	B
5729.76	6.8	38.0	37.0	44.8	43.8	64.6	+19.8	B
7639.68	10.6	37.0	43.0	47.6	53.6	64.6	+11.0	C
9549.60	5.8	44.0	46.0	49.8	51.8	64.6	+12.8	C
11459.52	6.7	<30.0	<30.0	<36.7	<36.7	64.6	>+27.9	C
13369.44	10.5	<30.0	<30.0	<40.5	<40.5	64.6	>+24.1	C
15279.36	10.2	<30.0	<30.0	<40.2	<40.2	64.6	>+24.4	C
17189.28	10.0	<30.0	<30.0	<40.0	<40.0	64.6	>+24.6	C
19099.20	20.6	<30.0	<30.0	<50.6	<50.6	64.6	>+14.0	D

* : Limit = 104.5(Maximum at 1909.92 MHz) - [43 + 10log(0.490)] = 64.6 [dB(μV/m)]

b-1) Test Configuration : Private Handset Adapter used
 Modulation Type : TDMA
 Transmitting Frequency : 1850.04 MHz

Frequency (MHz)	Corr. Factor (dB)	Meter Reading [dB(μV)]		Results [dB(μV/m)]		Limits* [dB(μV/m)]	Margin (dB)	Remarks (Note 3)
		Horiz.	Vert.	Horiz.	Vert.			
1850.04	31.6	74.0	69.0	105.6	100.6	-----	-----	A
3700.08	2.9	51.0	44.0	53.9	46.9	66.2	+12.3	B
5550.12	6.4	37.0	38.0	43.4	44.4	66.2	+21.8	B
7400.16	10.6	38.0	37.0	48.6	47.6	66.2	+17.6	B
9250.20	5.7	39.0	40.0	44.7	45.7	66.2	+20.5	C
11100.24	6.6	35.0	36.0	41.6	42.6	66.2	+23.6	C
12950.28	10.5	<30.0	<30.0	<40.5	<40.5	66.2	>+25.7	C
14800.32	10.2	<30.0	<30.0	<40.2	<40.2	66.2	>+26.0	C
16650.36	10.1	<30.0	<30.0	<40.1	<40.1	66.2	>+26.1	C
18500.40	20.3	<30.0	<30.0	<50.3	<50.3	66.2	>+15.9	D

* : Limit = 105.6(Maximum at 1850.04 MHz) - [43 + 10log(0.437)] = 66.2 [dB(μV/m)]

b-2) Test Configuration : Private Handset Adapter used
 Modulation Type : TDMA
 Transmitting Frequency : 1879.98 MHz

Frequency (MHz)	Corr. Factor (dB)	Meter Reading [dB(μV)]		Results [dB(μV/m)]		Limits* [dB(μV/m)]	Margin (dB)	Remarks (Note 3)
		Horiz.	Vert.	Horiz.	Vert.			
1879.98	31.5	72.0	68.0	103.5	99.5	-----	-----	A
3759.96	2.9	51.0	46.0	53.9	48.9	64.1	+10.2	B
5639.94	6.6	40.0	39.0	46.6	45.6	64.1	+17.5	B
7519.92	10.7	40.0	42.0	50.7	52.7	64.1	+11.4	B
9399.90	5.7	37.0	39.0	42.7	44.7	64.1	+19.4	C
11279.88	6.6	<30.0	31.0	<36.6	37.6	64.1	+26.5	C
13159.86	10.5	<30.0	<30.0	<40.5	<40.5	64.1	>+23.6	C
15039.84	10.1	32.0	34.0	42.1	44.1	64.1	+20.0	C
16919.82	10.1	<30.0	<30.0	<40.1	<40.1	64.1	>+24.0	C
18799.80	20.6	<30.0	<30.0	<50.6	<50.6	64.1	>+13.5	D

* : Limit = 103.5(Maximum at 1879.98 MHz) - [43 + 10log(0.437)] = 64.1 [dB(μV/m)]

b-3) Test Configuration : Private Handset Adapter used
 Modulation Type : TDMA
 Transmitting Frequency : 1909.92 MHz

Frequency (MHz)	Corr. Factor (dB)	Meter Reading [dB(μV)]		Results [dB(μV/m)]		Limits* [dB(μV/m)]	Margin (dB)	Remarks (Note 3)
		Horiz.	Vert.	Horiz.	Vert.			
1909.92	31.5	73.0	69.0	104.5	100.5	-----	-----	A
3819.84	3.0	50.0	48.0	53.0	51.0	64.6	+11.6	B
5729.76	6.8	38.0	37.0	44.8	43.8	64.6	+19.8	B
7639.68	10.6	37.0	42.0	47.6	52.6	64.6	+12.0	C
9549.60	5.8	44.0	45.0	49.8	50.8	64.6	+13.8	C
11459.52	6.7	<30.0	<30.0	<36.7	<36.7	64.6	>+27.9	C
13369.44	10.5	<30.0	<30.0	<40.5	<40.5	64.6	>+24.1	C
15279.36	10.2	<30.0	<30.0	<40.2	<40.2	64.6	>+24.4	C
17189.28	10.0	<30.0	<30.0	<40.0	<40.0	64.6	>+24.6	C
19099.20	20.6	<30.0	<30.0	<50.6	<50.6	64.6	>+14.0	D

* : Limit = 104.5(Maximum at 1909.92 MHz) - [43 + 10log(0.490)] = 64.6 [dB(μV/m)]

c-1) Test Configuration : Handsfree Unit used
 Modulation Type : TDMA
 Transmitting Frequency : 1850.04 MHz

Frequency (MHz)	ERP [dBm]		Limits [dBm]	Margin (dB)	Remarks (Note 3)
	Hori.	Vert.			
3700.08	-46.5	-48.5	-13.0	+33.5	B
5550.12	-51.0	-49.0	-13.0	+36.0	B
7400.16	-46.8	-46.8	-13.0	+33.8	B
9250.20	-45.7	-50.7	-13.0	+32.7	C
11100.24	-49.8	-50.8	-13.0	+36.8	C
12950.28	<-56.9	<-56.9	-13.0	>+43.9	C
14800.32	<-57.2	<-57.2	-13.0	>+44.2	C
16650.36	<-57.3	<-57.3	-13.0	>+44.3	C
18500.40	<-47.1	<-47.1	-13.0	>+34.1	D

c-2) Test Configuration : Handsfree Unit used
 Modulation Type : TDMA
 Transmitting Frequency : 1879.98 MHz

Frequency (MHz)	ERP [dBm]		Limits [dBm]	Margin (dB)	Remarks (Note 3)
	Hori.	Vert.			
3759.96	-48.5	-46.5	-13.0	+33.5	B
5639.94	-49.8	-51.8	-13.0	+36.8	B
7519.92	-44.7	-45.7	-13.0	+31.7	B
9399.90	-51.7	-53.7	-13.0	+38.7	C
11279.88	-51.8	-50.8	-13.0	+37.8	C
13159.86	<-56.9	<-56.9	-13.0	>+43.9	C
15039.84	<-57.3	<-57.3	-13.0	>+44.3	C
16919.82	<-57.3	<-57.3	-13.0	>+44.3	C
18799.80	<-46.8	<-46.8	-13.0	>+33.8	D

c-3) Test Configuration : Handsfree Unit used
Modulation Type : TDMA
Transmitting Frequency : 1909.92 MHz

Frequency (MHz)	ERP [dBm]		Limits [dBm]	Margin (dB)	Remarks (Note 3)
	Hori.	Vert.			
3819.84	-48.4	-46.4	-13.0	+33.4	B
5729.76	-46.6	-50.6	-13.0	+33.6	B
7639.68	-42.8	-46.8	-13.0	+29.8	C
9549.60	-45.6	-46.6	-13.0	+32.6	C
11459.52	-52.7	-54.7	-13.0	+39.7	C
13369.44	<-56.9	<-56.9	-13.0	>+43.9	C
15279.36	<-57.2	<-57.2	-13.0	>+44.2	C
17189.28	<-57.4	<-57.4	-13.0	>+44.4	C
19099.20	<-46.8	<-46.8	-13.0	>+33.8	D

Sample of calculated result at 3759.96 MHz, as the Minimum Margin point:

$$\begin{array}{rcl} \text{Correction Factor} & = & 2.9 \text{ dB} \\ +) \text{ Meter Reading} & = & 52.0 \text{ dB}(\mu\text{V}) \\ \hline \text{Result} & = & 54.9 \text{ dB}(\mu\text{V}/\text{m}) \end{array}$$

Minimum Margin : $64.1 - 54.9 = 9.2(\text{dB})$

The point shown on " ___ " is the Minimum Margin Point.

Applied limits :

A) Radiated Field Strength at 3 m

Applied limits $[\text{dB}(\mu\text{V}/\text{m})] = \text{Field Strength} [\text{dB}(\mu\text{V}/\text{m})]$ at Maximum Fundamental Frequency - $[43 + 10\log[\text{tp}(\text{W})]]$
 Where $\text{tp}(\text{W})$: Transmitter Power at antenna terminal under test configuration as the handsfree unit used.

B) ERP

Applied limits $= 10\log[\text{TP}(\text{mW})] - [43 + 10\log[\text{tp}(\text{W})]] = 10\log[\text{TP}(\text{mW})] - [43 + (10\log[\text{TP}(\text{mW})] - 30)]$
 $= -13 [\text{dBm}]$

Where $\text{tp}(\text{W}) = \text{TP}(\text{mW}) / 1000$: Transmitter Power at antenna terminal under test configuration as the handsfree unit used.

$$10\log[\text{tp}(\text{W})] = 10\log[\text{TP}(\text{mW})] - 30$$

Note : 1. The spectrum was checked from 9 kHz up to 20 GHz.

2. All emissions not listed were found to be more than 20dB below the limit.

Remarks:

Note 3	Detector Function	RES. B.W	V.B.W	Sweep T	Span	Corr. Factor *
A	AVE (SP)	1 MHz	1 MHz	20 msec	0 Hz	ANT+CL+P10
B	AVE (SP)	1 MHz	1 MHz	20 msec	0 Hz	ANT+CL+P20-Amp.
C	AVE (SP)	1 MHz	1 MHz	20 msec	0 Hz	ANT+CL+P10-Amp.
D	AVE (SP)	1 MHz	1 MHz	20 msec	0 Hz	ANT+CL+P10-Amp.+Mix.
E	AVE (SP)	1 MHz	1 MHz	20 msec	0 Hz	ANT+CL+HPF+P10-Amp.
F	AVE (ESV)	120 kHz	--	--	--	ANT+CL

*)ANT:Antenna Factor/CL: Cable Loss/ P20: 20dB Att. / P10: 10dB Att. / Amp.: Amplifier Gain/

Mix.: Mixer Conversion Loss/ HPF : High Pass Filter loss

Tester Signature : _____

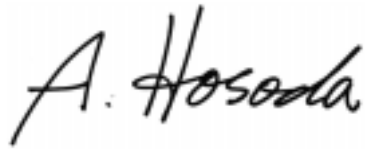

Type Name : Akio Hosoda