

---

# FCC Test Report

---

Report No.: AGC00B130101-1F2

**FCC ID** : NW71023  
**PRODUCT DESIGNATION** : HD Sports Video Camera/iON Air Pro 2 WiFi/Air Pro 2 WiFi/ Gen 2 with WiFi  
**BRAND NAME** : iON  
**MODE NAME** : #1023, 1026, 1027  
**CLIENT** : World Wide Licenses Ltd.  
**DATE OF ISSUE** : Jan.28,2013  
**STANDARD(S)** : FCC Part 15 Rules  
**REPORT VERSION** : AGCRT-US-BGN/RF-V1.0

**Attestation of Global Compliance (Shenzhen) Co., Ltd**

**CAUTION:** This report shall not be reproduced except in full without the written permission of the test laboratory and shall not be quoted out of context.

## TABLE OF CONTENTS

<b>1. VERIFICATION OF CONFORMITY .....</b>	<b>4</b>
<b>2. GENERAL INFORMATION .....</b>	<b>5</b>
2.1. PRODUCT DESCRIPTION.....	5
2.2. TABLE OF CARRIER FREQUENCIES.....	5
2.3. IEEE 802.11N MODULATION SCHEME .....	6
2.4. RELATED SUBMITTAL(S) / GRANT (S).....	6
2.5. TEST METHODOLOGY.....	6
2.6. SPECIAL ACCESSORIES .....	6
2.7. EQUIPMENT MODIFICATIONS .....	6
<b>3. MEASUREMENT UNCERTAINTY.....</b>	<b>7</b>
<b>4. DESCRIPTION OF TEST MODES.....</b>	<b>7</b>
5.1. CONFIGURATION OF EUT SYSTEM .....	8
5.2. EQUIPMENT USED IN EUT SYSTEM .....	8
5.3. SUMMARY OF TEST RESULTS .....	8
<b>6. TEST FACILITY .....</b>	<b>9</b>
<b>7. PEAK OUTPUT POWER .....</b>	<b>10</b>
7.1. MEASUREMENT PROCEDURE .....	10
7.2. TEST SET-UP (BLOCK DIAGRAM OF CONFIGURATION).....	10
7.3. LIMITS AND MEASUREMENT RESULT .....	11
<b>8. 6DB BANDWIDTH .....</b>	<b>13</b>
8.1. MEASUREMENT PROCEDURE .....	13
8.2. TEST SET-UP (BLOCK DIAGRAM OF CONFIGURATION).....	13
8.3. LIMITS AND MEASUREMENT RESULTS.....	14
<b>9. CONDUCTED SPURIOUS EMISSION .....</b>	<b>23</b>
9.1. MEASUREMENT PROCEDURE .....	23
9.2. TEST SET-UP (BLOCK DIAGRAM OF CONFIGURATION).....	23
9.3. MEASUREMENT EQUIPMENT USED.....	23
9.4. LIMITS AND MEASUREMENT RESULT .....	23
<b>10. MAXIMUM CONDUCTED OUTPUT POWER SPECTRAL DENSITY .....</b>	<b>26</b>
10.1 MEASUREMENT PROCEDURE .....	26
10.2 TEST SET-UP (BLOCK DIAGRAM OF CONFIGURATION).....	26
10.3 MEASUREMENT EQUIPMENT USED.....	26
10.4 LIMITS AND MEASUREMENT RESULT .....	26
<b>11. RADIATED EMISSION .....</b>	<b>36</b>
11.1. MEASUREMENT PROCEDURE .....	36



11.2. TEST SETUP .....	37
11.3. LIMITS AND MEASUREMENT RESULT .....	38
11.4. TEST RESULT .....	38
<b>12. BAND EDGE EMISSION .....</b>	<b>47</b>
12.1. MEASUREMENT PROCEDURE .....	47
12.2. TEST SET-UP .....	47
12.3. TEST RESULT .....	48
<b>13. FCC LINE CONDUCTED EMISSION TEST .....</b>	<b>56</b>
13.1. LIMITS OF LINE CONDUCTED EMISSION TEST .....	56
13.2. BLOCK DIAGRAM OF LINE CONDUCTED EMISSION TEST .....	56
13.3. PRELIMINARY PROCEDURE OF LINE CONDUCTED EMISSION TEST .....	57
13.4. FINAL PROCEDURE OF LINE CONDUCTED EMISSION TEST .....	57
13.5. TEST RESULT OF LINE CONDUCTED EMISSION TEST .....	57
<b>APPENDIX A: PHOTOGRAPHS OF TEST SETUP .....</b>	<b>58</b>
<b>APPENDIX B: PHOTOGRAPHS OF EUT .....</b>	<b>59</b>

**1. VERIFICATION OF CONFORMITY**

<b>Applicant</b>	World Wide Licenses Ltd.
<b>Address</b>	14F Hong Kong Pacific Centre 28 Hankow Road, Tsimshatsui, HongKong
<b>Manufacturer</b>	SKY LIGHT Electronic (ShenZhen) Limited
<b>Address</b>	NO.6 Building, JinBi Industrial Area, Huang Tian, BaoAn, ShenZhen, China.
<b>Product Designation</b>	HD Sports Video Camera, iON Air Pro 2 WiFi, Air Pro 2 WiFi, Gen 2 with WiFi
<b>Brand Name</b>	iON
<b>Test Model</b>	#1023
<b>Series Model</b>	1026,1027
<b>Difference description</b>	All the same except for the model name.
<b>Date of test</b>	Jan.23,2013 to Jan.28,2013
<b>Deviation</b>	None
<b>Condition of Test Sample</b>	Normal

We hereby certify that:

The above equipment was tested by Attestation of Global Compliance (Shenzhen) Co., Ltd. The test data, data evaluation, test procedures, and equipment configurations shown in this report were made in accordance with the procedures given in ANSI C63.4 (2003) and the energy emitted by the sample EUT tested as described in this report is in compliance with requirement of FCC Part 15 Rules requirement.

Prepared By	
	_____ Jane Wu                      Jan.28,2013
Checked By	
	_____ Forrest Lei                      Jan.28,2013
Authorized By	
	_____ Solger Zhang                      Jan.28,2013

## 2. GENERAL INFORMATION

### 2.1. PRODUCT DESCRIPTION

The EUT is designed as “HD Sports Video Camera, iON Air Pro 2 WiFi, Air Pro 2 WiFi, Gen 2 with WiFi”. It is designed by way of utilizing the DSSS and OFDM technology to achieve the system operation.

A major technical description of EUT is described as following

<b>Operation Frequency</b>	2.412 GHz to 2.462GHz
<b>Max. Output Power</b>	IEEE 802.11b:11.03dBm,IEEE 802.11g:10.81dBm, IEEE 802.11n(20):10.59dBm,IEEE 802.11n(40):9.74dBm
<b>Modulation</b>	DSSS(BPSK/QPSK/CCK);OFDM(BPSK/QPSK/16-QAM/64-QAM)
<b>Data Rate</b>	DSSS(1/2/5.5/11),OFDM(6/9/12/18/24/36/48/54) See section 1.3 for 802.11n
<b>Number of channels</b>	11
<b>Antenna Designation</b>	Integrated Antenna
<b>Antenna Gain</b>	1.0dBi
<b>Power Supply</b>	Normal Voltage: DC 3.7V & Extreme Voltage :DC 3.3V-DC 4.2V
<b>Note:</b> The DTS transmitter is not working while EUT is charged.	

### 2.2. TABLE OF CARRIER FREQUENCIES

Frequency Band	Channel Number	Frequency
2400~2483.5MHZ	1	2412 MHZ
	2	2417 MHZ
	3	2422 MHZ
	4	2427 MHZ
	5	2432 MHZ
	6	2437 MHZ
	7	2442 MHZ
	8	2447 MHZ
	9	2452 MHZ
	10	2457 MHZ
	11	2462 MHZ

Note: For 20MHZ bandwidth system use Channel 1 to Channel 11  
For 40MHZ bandwidth system use Channel 3 to Channel 9

### 2.3. IEEE 802.11N MODULATION SCHEME

MCS Index	Nss	Modulation	R	NBPS	NCBPS		NDBPS		Data rate(Mbps)	
					20MHz	40MHz	20MHz	40MHz	800nsGI	
									20MHz	40MHz
0	1	BPSK	1/2	1	52	108	26	54	6.5	13.5
1	1	QPSK	1/2	2	104	216	52	108	13.0	27.0
2	1	QPSK	3/4	2	104	216	78	162	19.5	40.5
3	1	16-QAM	1/2	4	208	432	104	216	26.0	54.0
4	1	16-QAM	3/4	4	208	432	156	324	39.0	81.0
5	1	64-QAM	2/3	6	312	648	208	432	52.0	108.0
6	1	64-QAM	3/4	6	312	648	234	489	58.5	121.5
7	1	64-QAM	5/6	6	312	648	260	540	65.0	135.0

Symbol	Explanation
NSS	Number of spatial streams
R	Code rate
NBPS	Number of coded bits per single carrier
NCBPS	Number of coded bits per symbol
NDBPS	Number of data bits per symbol
GI	Guard interval

### 2.4. RELATED SUBMITTAL(S) / GRANT (S)

This submittal(s) (test report) is intended for **FCC ID: NW71023** filing to comply with the FCC Part 15 requirements.

### 2.5. TEST METHODOLOGY

Because the EUT received power from DC3.7V lithium battery, so only radiated testing was performed according to the procedures in ANSI C63.4 (2003). Radiated testing was performed at an antenna to EUT distance 3 meters.

### 2.6. SPECIAL ACCESSORIES

Refer to section 2.2.

### 2.7. EQUIPMENT MODIFICATIONS

Not available for this EUT intended for grant.

### 3. MEASUREMENT UNCERTAINTY

Conducted measurement: +/- 2.75dB

Radiated measurement: +/- 3.2dB

### 4. DESCRIPTION OF TEST MODES

TEST MODE DESCRIPTION	
NO.	TEST MODE DESCRIPTION
1	Low channel TX
2	Middle channel TX
3	High channel TX
4	Normal Operating(wifi )
<p>Note:</p> <p>1. Transmit by 802.11b with Data rate (1/2/5.5/11)  Transmit by 802.11g with Data rate (6/9/12/18/24/36/48/54)  Transmit by 802.11n (20MHz) with Data rate (6.5/13/19.5/26/39/52/58.5/65)  Transmit by 802.11n (40MHz) with Data rate  (13.5/27/40.5/54/81/108/121.5/135)</p>	

**Note:**

1. The EUT has been set to operate continuously on the lowest, middle and highest operation frequency Individually.
2. All modes under which configure applicable have been tested and the worst mode test data recording in the test report If no other modes.
3. For Radiated Emission, 3axis were chosen for testing for each applicable mode.
4. Other conventional modes are recorded in FCC VOC report.

**5. SYSTEM TEST CONFIGURATION**

**5.1. CONFIGURATION OF EUT SYSTEM**

**Configure1:** ( Normal Operating )



**Configure2:** (continuous TX)

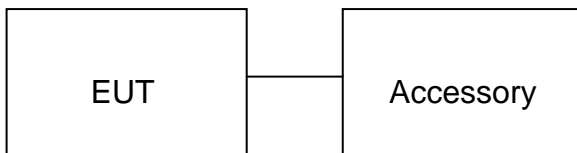

**Note:** the EUT controlled by PC to work in continuous TX mode

**5.2. EQUIPMENT USED IN EUT SYSTEM**

Item	Equipment	Mfr/Brand	Model/Type No.	Remark
1	HD Sports Video Camera	iON	#1023	EUT
2	Adapter	N/A	SP-02C0551000-G	Accessory
3	Battery	N/A	N/A	Accessory
4	USB Cable	N/A	N/A	Accessory

**Note:** the following “EUT” in setup diagram means EUT system.

**5.3. SUMMARY OF TEST RESULTS**

FCC RULES	DESCRIPTION OF TEST	RESULT
§15.247	Peak Output Power	Compliant
§15.247	6 dB Bandwidth	Compliant
§15.247	Conducted Spurious Emission	Compliant
§15.247	Maximum Conducted Output Power SPECTRAL Density	Compliant
§15.209	Radiated Emission	Compliant
§15.247	Band Edges	Compliant
§15.207	Line Conduction Emission	N/A

**Note:** The EUT received power from DC3.7V lithium battery.



## 6. TEST FACILITY

<b>Site</b>	Attestation of Global Compliance (Shenzhen) Co., Ltd
<b>Location</b>	2/F., Building 2, No.1-No.4, Chaxi Sanwei Technical Industrial Park, Gushu, Xixiang, Bao'an District, Shenzhen, Guangdong, China
<b>Description</b>	The test site is constructed and calibrated to meet the FCC requirements in documents ANSI C63.4:2003.
<b>Site Filing</b>	The FCC Registration Number is 259865
<b>Instrument Tolerance</b>	All measuring equipment is in accord with ANSI C63.4 requirements that meet industry regulatory agency and accreditation agency requirement.

## ALL TEST EQUIPMENT LIST

Description	Manufacturer	Model	S/N	Cal. Date	Cal. Due
Power meter	R&S	NRP-Z23	N/A	07/18/2012	07/17/2013
RF attenuator	N/A	RFA20db	N/A	N/A	N/A
AGILENT	Agilent	E4440A	N/A	07/18/2012	07/17/2013
Spectrum Analyzer	Agilent	E4440A	N/A	07/18/2012	06/17/2013
Amplifier	EM	EM30180	0607030	07/18/2012	07/17/2013
Horn Antenna	EM	EM-AH-10180	N/A	07/18/2012	07/17/2013
Horn Antenna	A.H. Systems Inc.	SAS-574	--	07/18/2012	07/17/2013
EMI Test Receiver	Rohde & Schwarz	ESCI	N/A	07/18/2012	07/17/2013
Biological Antenna	A.H. Systems Inc.	SAS-521-4	N/A	07/18/2012	07/17/2013
Loop Antenna	A.H.	SAS-526B	264	07/18/2012	07/17/2013
Isolation Transformer	LETEAC	LTBK	--	07/18/2012	07/17/2013

## 7. PEAK OUTPUT POWER

### 7.1. MEASUREMENT PROCEDURE

1. The EUT was placed on a table which is 0.8m above ground plane.
2. Connect EUT RF output port to power meter through an RF attenuator
3. Set the EUT Work on the top, the middle and the bottom operation frequency individually.
4. Set the RBW greater than 6DB bandwidth of emission.
5. Record the maximum power from the power meter.
6. The maximum peak power shall be less 1 Watt (30dBm).

**Note :** The EUT was tested according to KDB 558074 for compliance to FCC 47CFR 15.247 requirements.

### 7.2. TEST SET-UP (BLOCK DIAGRAM OF CONFIGURATION)

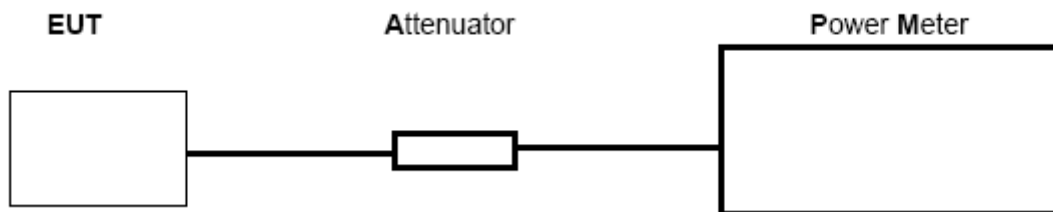

### 7.3. LIMITS AND MEASUREMENT RESULT

<b>TEST ITEM</b>	PEAK POWER
<b>TEST MODE</b>	802.11b with data rate 1

LIMITS AND MEASUREMENT RESULT				
Frequency (GHz)	Average Power (dBm)	Peak Power (dBm)	Applicable Limits (dBm)	Pass or Fail
2.412	10.21	11.03	30	Pass
2.437	10.13	10.92	30	Pass
2.462	10.06	10.84	30	Pass

<b>TEST ITEM</b>	PEAK POWER
<b>TEST MODE</b>	802.11g with data rate 6

LIMITS AND MEASUREMENT RESULT				
Frequency (GHz)	Average Power (dBm)	Peak Power (dBm)	Applicable Limits (dBm)	Pass or Fail
2.412	9.98	10.73	30	Pass
2.437	10.01	10.81	30	Pass
2.462	9.88	10.65	30	Pass

<b>TEST ITEM</b>	PEAK POWER
<b>TEST MODE</b>	802.11n 20 with data rate 6.5

LIMITS AND MEASUREMENT RESULT				
Frequency (GHz)	Average Power (dBm)	Peak Power (dBm)	Applicable Limits (dBm)	Pass or Fail
2.412	9.81	10.59	30	Pass
2.437	9.69	10.48	30	Pass
2.462	9.55	10.35	30	Pass

<b>TEST ITEM</b>	PEAK POWER
<b>TEST MODE</b>	802.11n 40 with data rate 13.5

<b>LIMITS AND MEASUREMENT RESULT</b>				
<b>Frequency (GHz)</b>	<b>Average Power (dBm)</b>	<b>Peak Power (dBm)</b>	<b>Applicable Limits (dBm)</b>	<b>Pass or Fail</b>
2.422	8.68	9.41	30	Pass
2.437	8.81	9.53	30	Pass
2.452	8.92	9.74	30	Pass

## 8. 6DB BANDWIDTH

### 8.1. MEASUREMENT PROCEDURE

1. The EUT was placed on a table which is 0.8m above ground plane.
2. Connect EUT RF output port to the Spectrum Analyzer through an RF attenuator
3. Set the EUT Work on the top, the middle and the bottom operation frequency individually.
3. Set SPA Centre Frequency = Operation Frequency, RBW= 100 KHz, VBW $\geq$ RBW.
4. Set SPA Trace 1 Max hold, then View.

**Note:** The EUT was tested according to KDB 558074 for compliance to FCC 47CFR 15.247 requirements.

### 8.2. TEST SET-UP (BLOCK DIAGRAM OF CONFIGURATION)

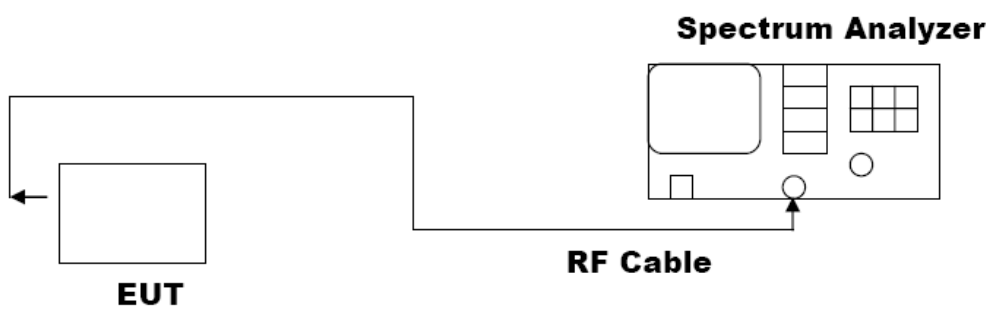

### 8.3. LIMITS AND MEASUREMENT RESULTS

<b>TEST ITEM</b>	6DB BANDWIDTH
<b>TEST MODE</b>	802.11b with data rate 11

LIMITS AND MEASUREMENT RESULT			
Applicable Limits	Applicable Limits		
	Test Data (MHz)		Criteria
>500KHZ	Low Channel	8.586	PASS
	Middle Channel	9.069	PASS
	High Channel	8.582	PASS

<b>TEST ITEM</b>	6DB BANDWIDTH
<b>TEST MODE</b>	802.11g with data rate 54

LIMITS AND MEASUREMENT RESULT			
Applicable Limits	Applicable Limits		
	Test Data (MHz)		Criteria
>500KHZ	Low Channel	16.440	PASS
	Middle Channel	16.458	PASS
	High Channel	16.426	PASS

<b>TEST ITEM</b>	6DB BANDWIDTH
<b>TEST MODE</b>	802.11n 20 with data rate 65

LIMITS AND MEASUREMENT RESULT			
Applicable Limits	Applicable Limits		
	Test Data (MHz)		Criteria
>500KHZ	Low Channel	17.703	PASS
	Middle Channel	17.677	PASS
	High Channel	17.698	PASS

<b>TEST ITEM</b>	6DB BANDWIDTH
<b>TEST MODE</b>	802.11n 40 with data rate 135

<b>LIMITS AND MEASUREMENT RESULT</b>			
<b>Applicable Limits</b>	<b>Applicable Limits</b>		
	<b>Test Data (MHz)</b>		<b>Criteria</b>
>500KHZ	Low Channel	35.498	PASS
	Middle Channel	36.025	PASS
	High Channel	35.202	PASS

**802.11b TEST RESULT**  
**TEST PLOT OF BANDWIDTH FOR LOW CHANNEL**

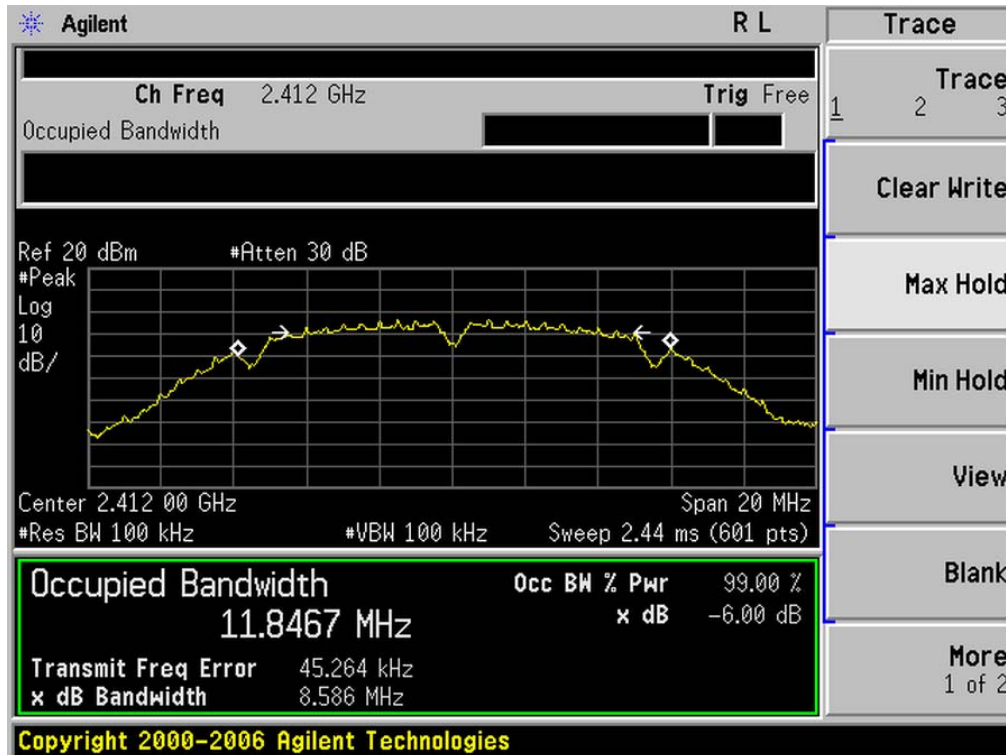

**TEST PLOT OF BANDWIDTH FOR MIDDLE CHANNEL**

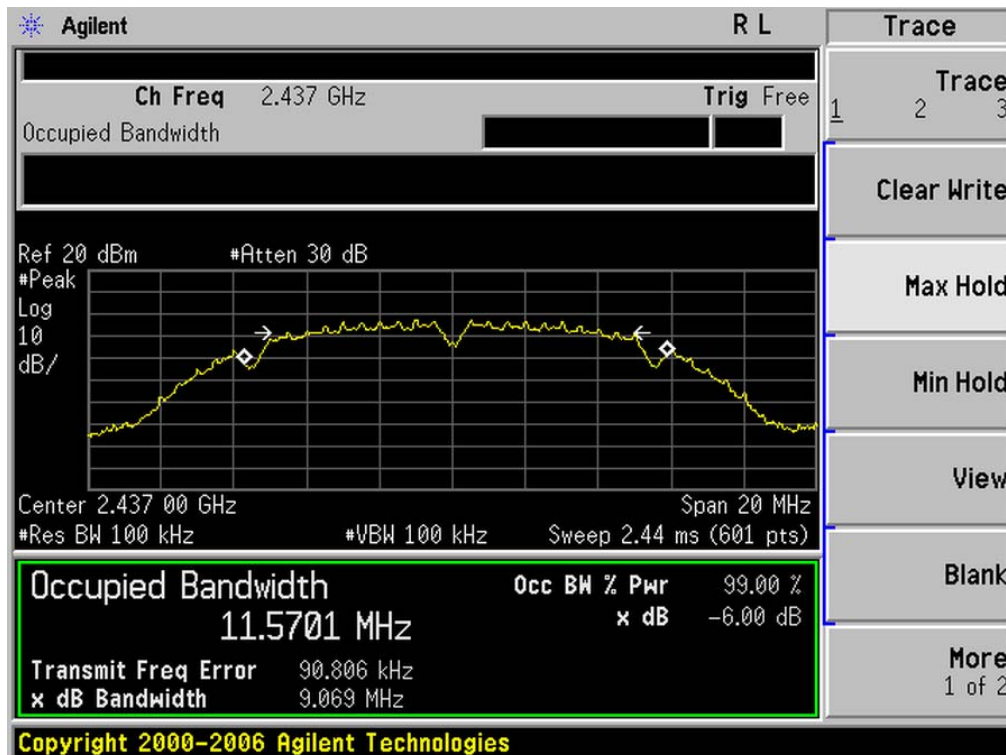



TEST PLOT OF BANDWIDTH FOR HIGH CHANNEL

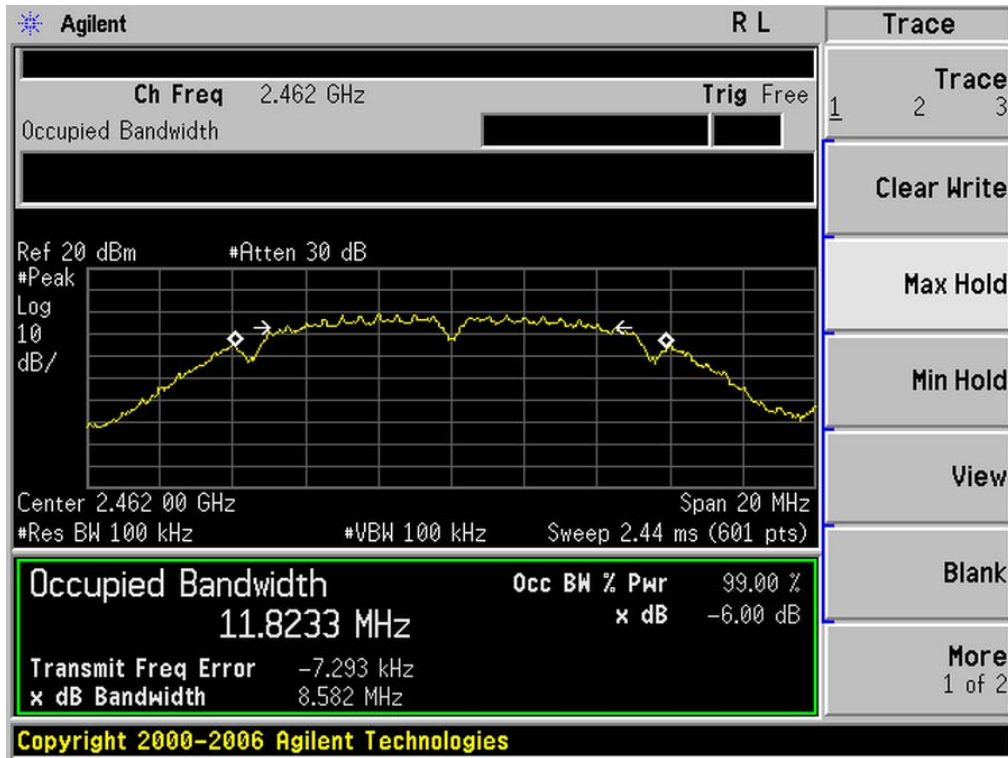

### 802.11g TEST RESULT

#### TEST PLOT OF BANDWIDTH FOR LOW CHANNEL

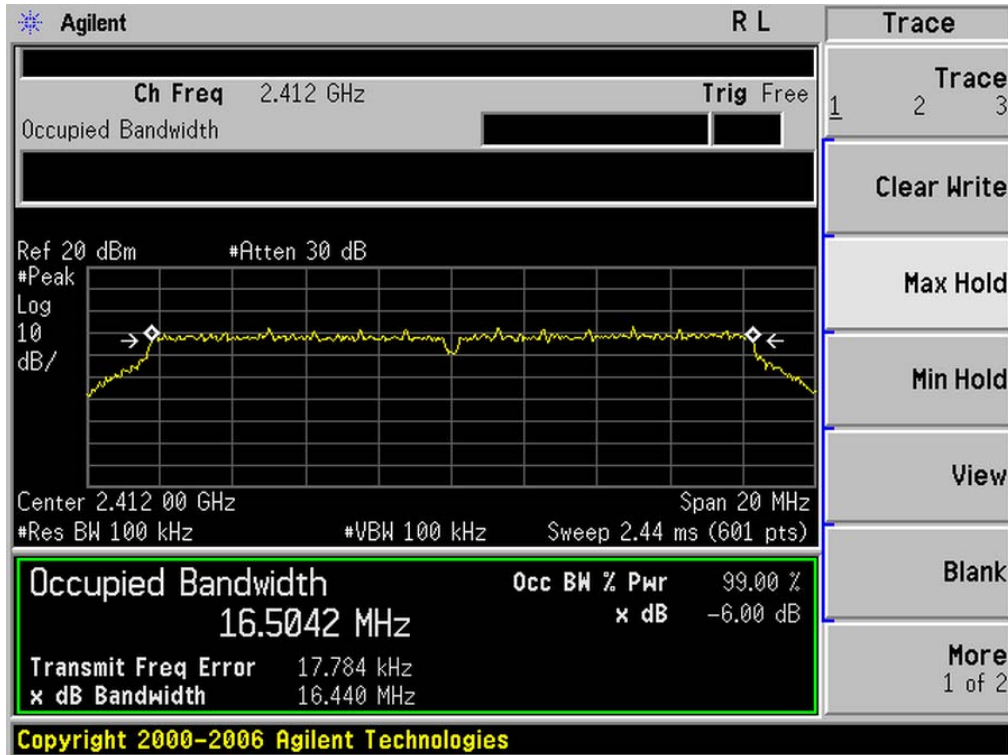

#### TEST PLOT OF BANDWIDTH FOR MIDDLE CHANNEL

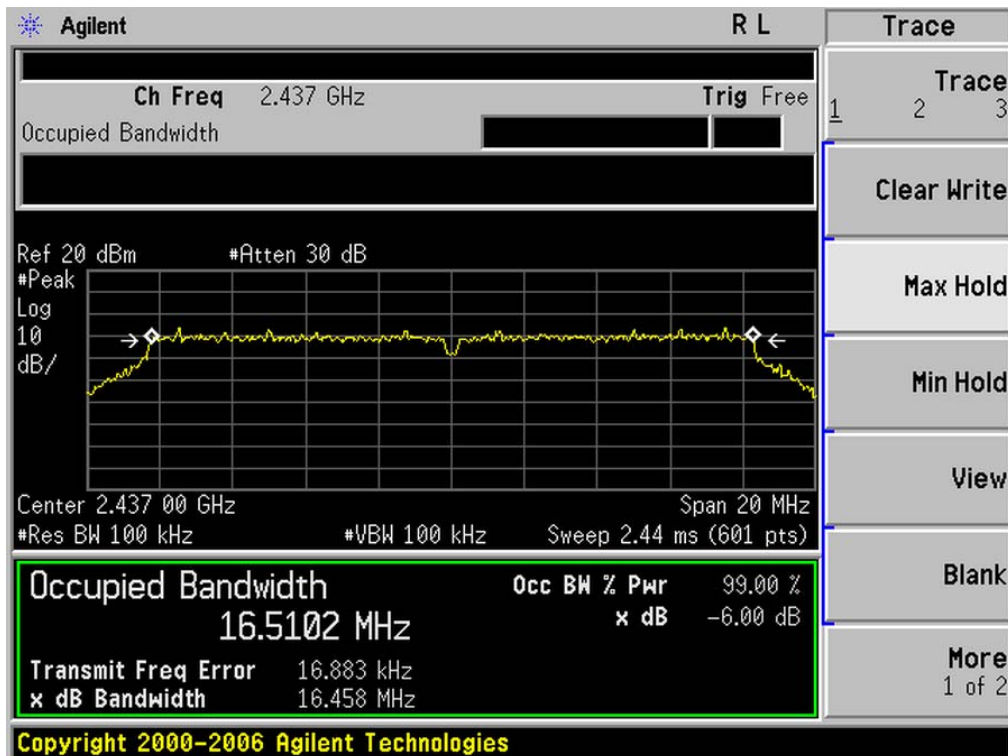

TEST PLOT OF BANDWIDTH FOR HIGH CHANNEL

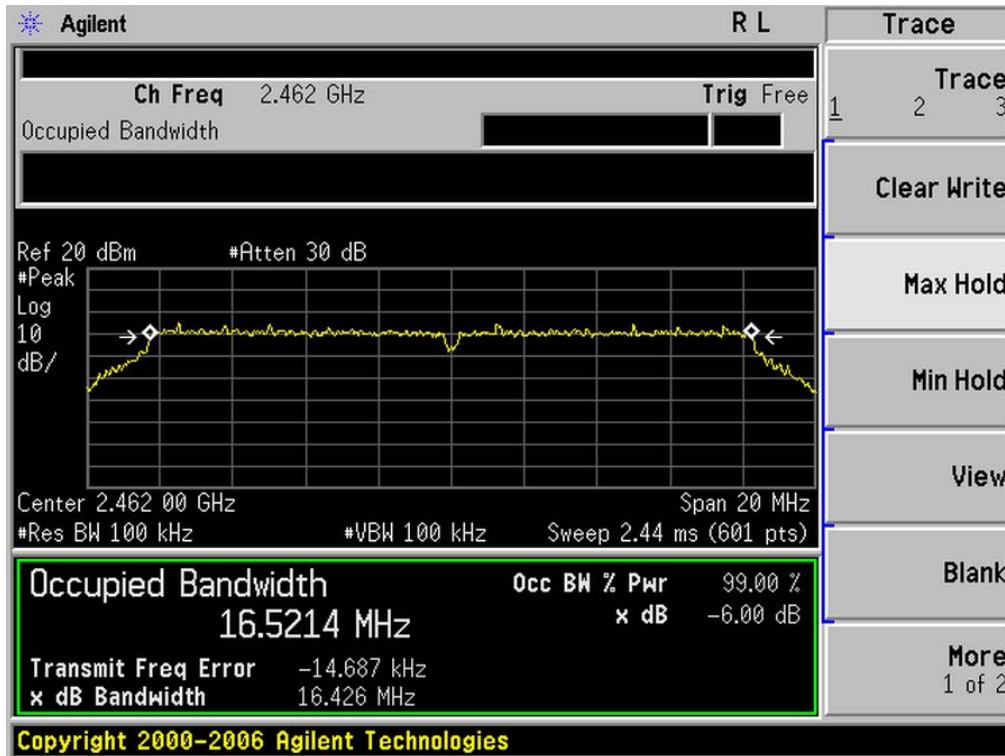

802.11n (20) TEST RESULT

TEST PLOT OF BANDWIDTH FOR LOW CHANNEL

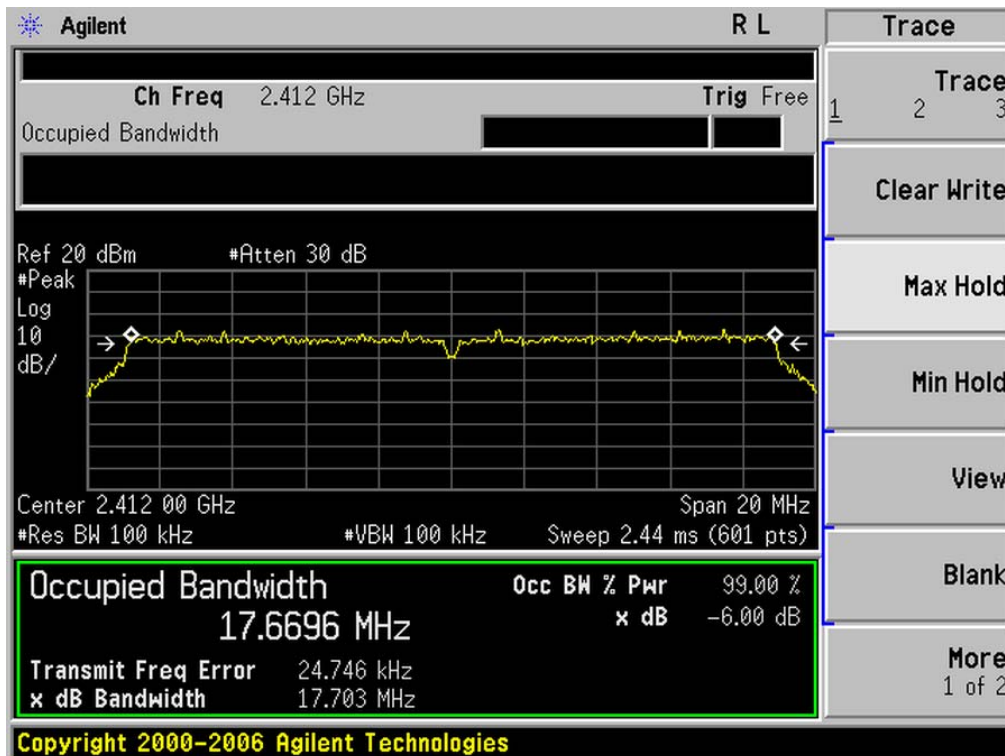

TEST PLOT OF BANDWIDTH FOR MIDDLE CHANNEL

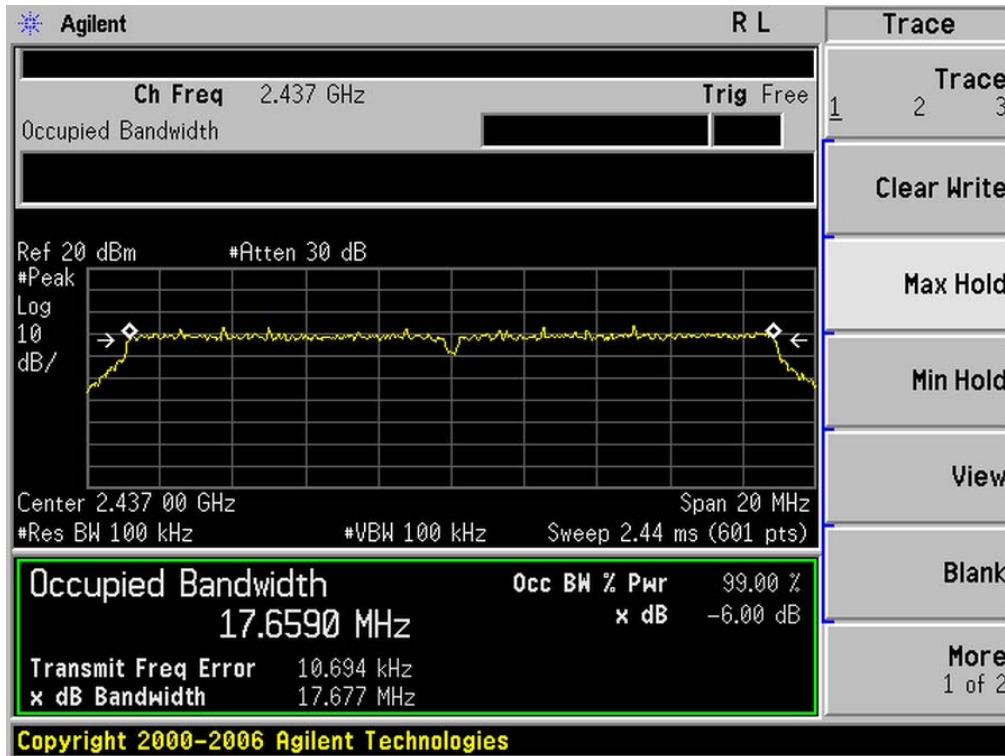

TEST PLOT OF BANDWIDTH FOR HIGH CHANNEL

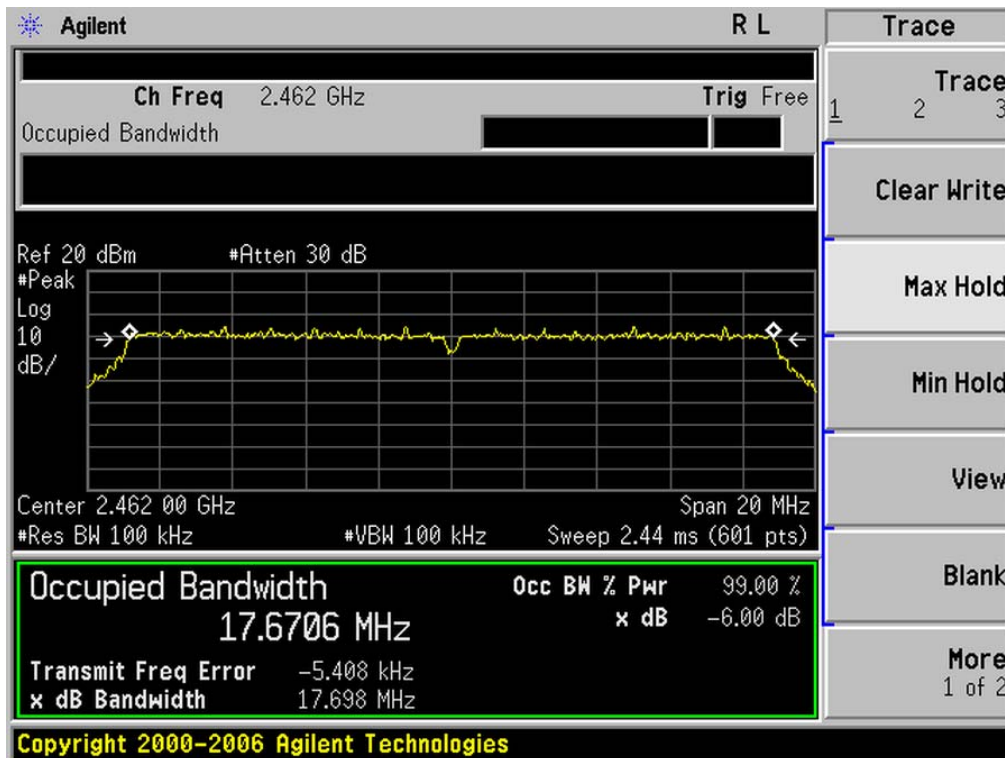

### 802.11n(40) TEST RESULT

#### TEST PLOT OF BANDWIDTH FOR LOW CHANNEL

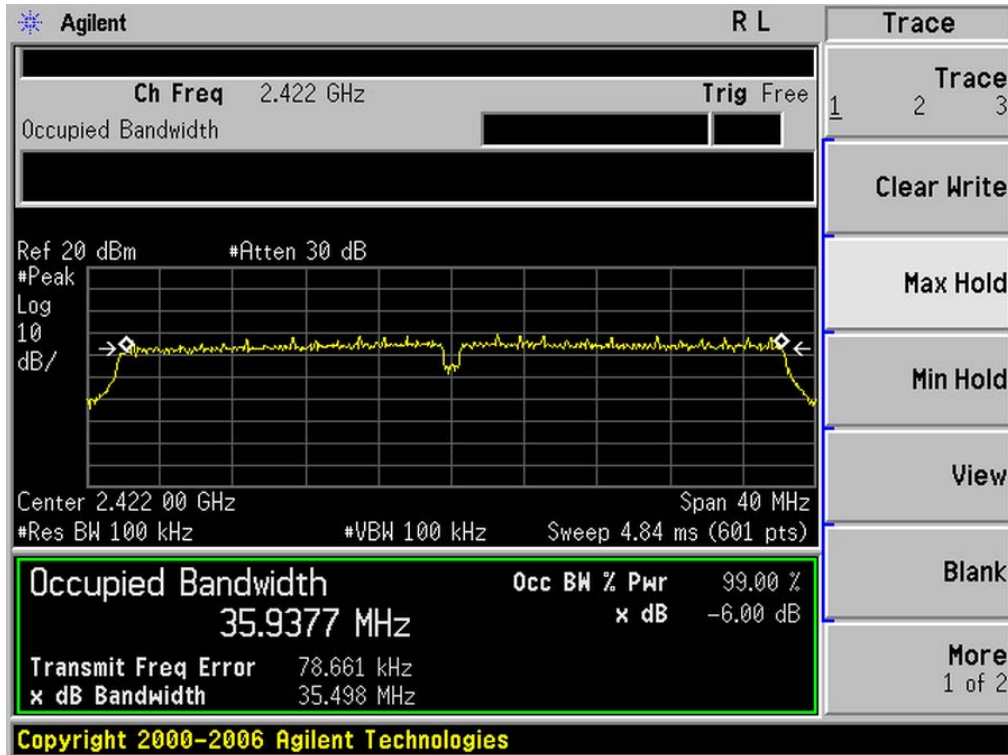

#### TEST PLOT OF BANDWIDTH FOR MIDDLE CHANNEL

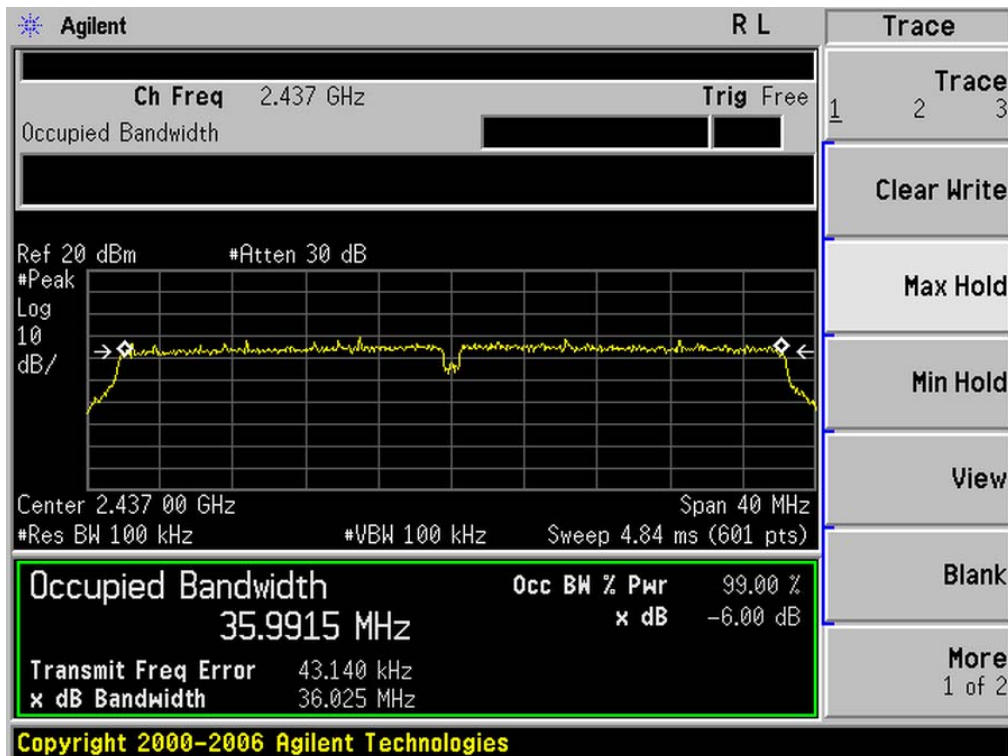

TEST PLOT OF BANDWIDTH FOR HIGH CHANNEL

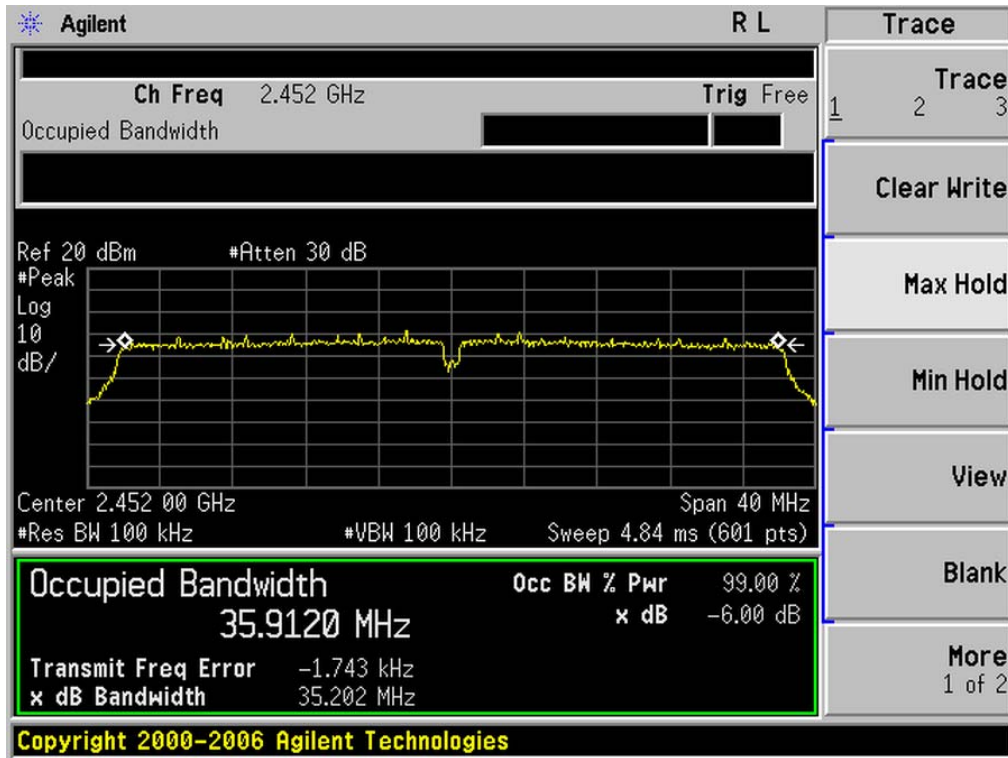

## 9. CONDUCTED SPURIOUS EMISSION

### 9.1. MEASUREMENT PROCEDURE

1. The EUT was placed on a turn table which is 0.8m above ground plane.
1. The EUT was placed on a turn table which is 0.8m above ground plane.
2. Connect EUT RF output port to the Spectrum Analyzer through an RF attenuator
- 3, Set the EUT Work on the top, the middle and the bottom operation frequency individually.
4. Set SPA Trace 1 Max hold, then View.

**Note:** The EUT was tested according to KDB 558074 for compliance to FCC 47CFR 15.247 requirements.  
Set RBW = 100 kHz, Set VBW > RBW, scan up through 10th harmonic.

### 9.2. TEST SET-UP (BLOCK DIAGRAM OF CONFIGURATION)

The same as described in section 6.2

### 9.3. MEASUREMENT EQUIPMENT USED

The same as described in section 6.3

### 9.4. LIMITS AND MEASUREMENT RESULT

LIMITS AND MEASUREMENT RESULT		
Applicable Limits	Measurement Result	
	Test Data	Criteria
In any 100 KHz Bandwidth Outside the frequency band in which the spread spectrum intentional radiator is operating, the radio frequency power that is produce by the intentional radiator shall be at least 20 dB below that in 100KHz bandwidth within the band that contains the highest level of the desired power. In addition, radiation emissions which fall in the restricted bands, as defined in §15.205(a), must also comply with the radiated emission limits specified in§15.209(a)	At least -20dBc than the limit Specified on the BOTTOM Channel	PASS
	At least -20dBc than the limit Specified on the TOP Channel	PASS

TEST PLOT OF OUT OF BAND EMISSIONS WITH THE WORST CASE  
 OF 802.11b FOR MODULATION IN LOW CHANNEL

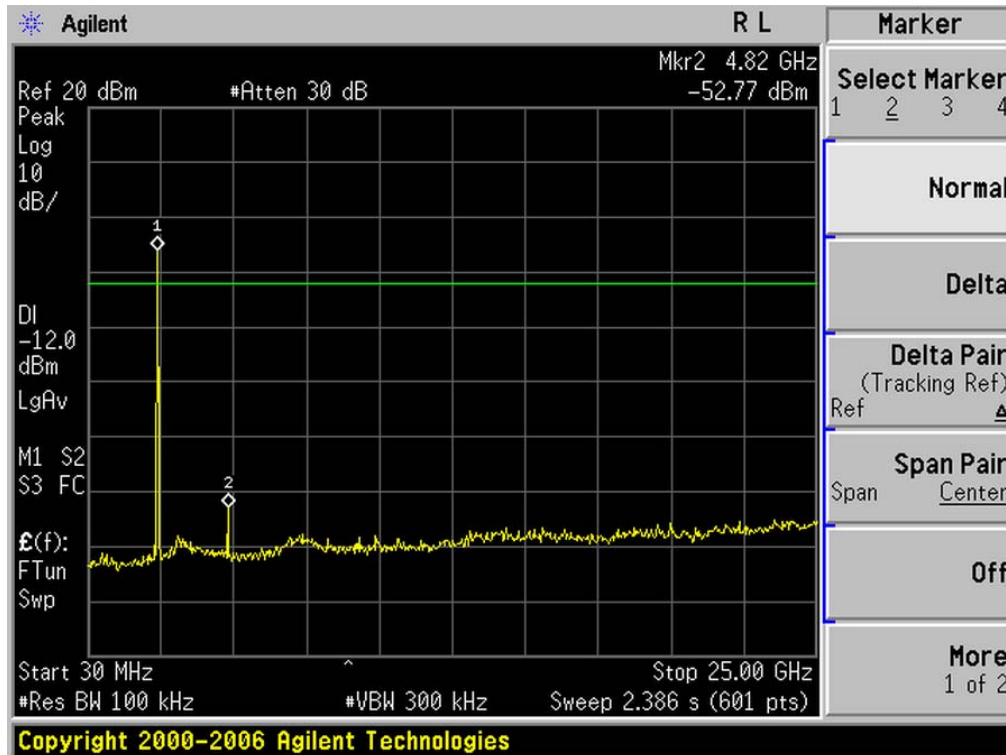

TEST PLOT OF OUT OF BAND EMISSIONS  
 OF 802.11b FOR MODULATION IN MIDDLE CHANNEL

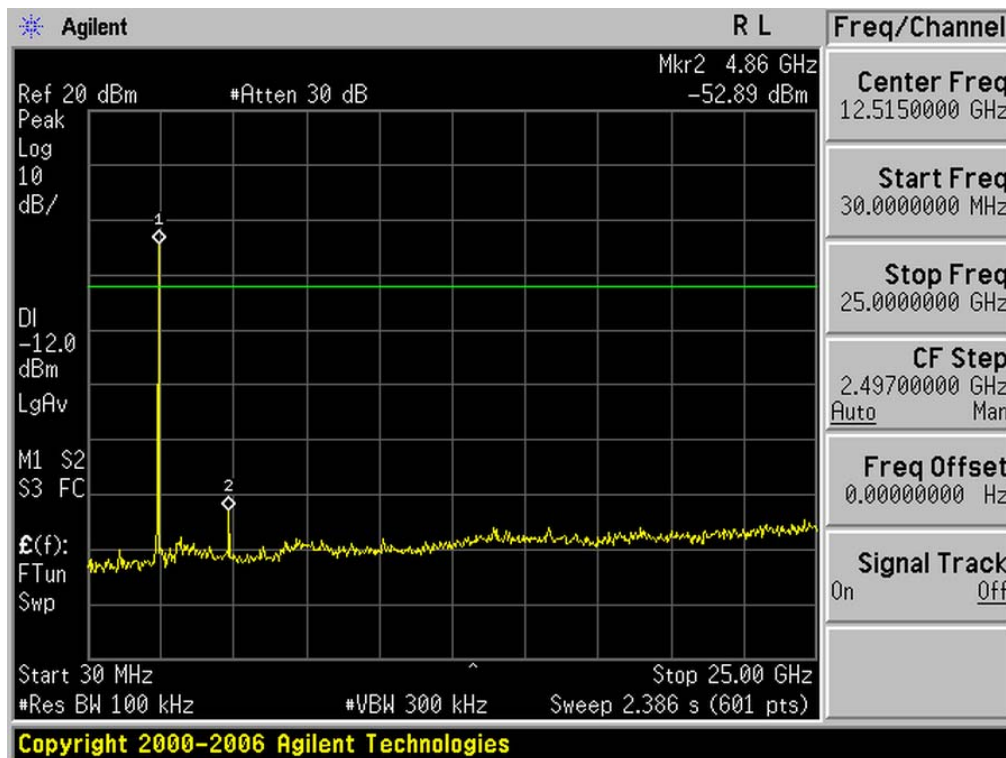



TEST PLOT OF OUT OF BAND EMISSIONS  
OF 802.11b FOR MODULATION IN HIGH CHANNEL

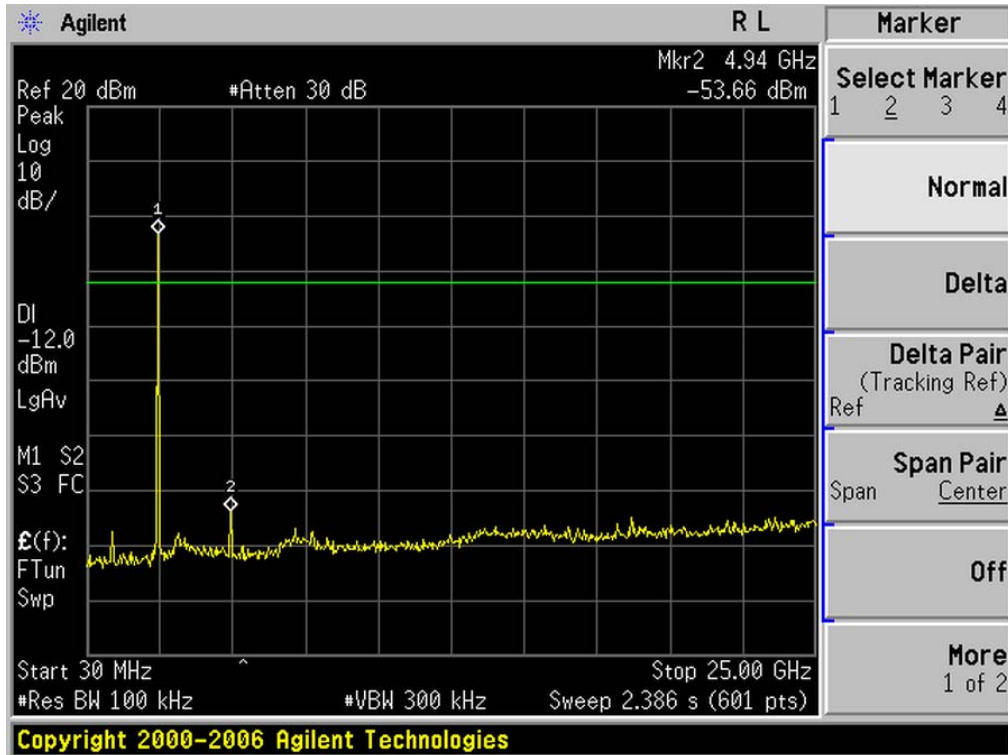

## 10. MAXIMUM CONDUCTED OUTPUT POWER SPECTRAL DENSITY

### 10.1 MEASUREMENT PROCEDURE

- (1). The EUT was placed on a turn table which is 0.8m above ground plane.
- (2). Connect EUT RF output port to the Spectrum Analyzer through an RF attenuator
- (3). Set the EUT Work on the top, the middle and the bottom operation frequency individually.
- (4). Set SPA Trace 1 Max hold, then View.

**Note:** The EUT was tested according to KDB 558074 for compliance to FCC 47CFR 15.247 requirements. Set RBW= 100 kHz, VBW $\geq$ 300kHz, SPAN to 5-30 % greater than the EBW, Scale the observed power level to an equivalent value in 3 kHz by adjusting (reducing) the measured power by a bandwidth correction factor (BWCF) where BWCF =  $10\log(3\text{ kHz}/100\text{kHz}) = -15.2\text{ dB}$ .

### 10.2 TEST SET-UP (BLOCK DIAGRAM OF CONFIGURATION)

Refer To Section 6.2

### 10.3 MEASUREMENT EQUIPMENT USED

Refer To Section 6.3

### 10.4 LIMITS AND MEASUREMENT RESULT

<b>TEST ITEM</b>	POWER PECTRAL DENSITY
<b>TEST MODE</b>	802.11b with data rate 1

Channel No.	Reading Value (dBm)	BWCF (dB)	PSD (dBm)	Limit (dBm)	Result
Low Channel	-3.43	-15.2	-18.63	8	Pass
Middle Channel	-2.12	-15.2	-17.32	8	Pass
High Channel	-1.56	-15.2	-16.76	8	Pass

<b>TEST ITEM</b>	POWER PECTRAL DENSITY
<b>TEST MODE</b>	802.11g with data rate 6

Channel No.	Reading Value (dBm)	BWCF (dB)	PSD (dBm)	Limit (dBm)	Result
Low Channel	-6.37	-15.2	-21.57	8	Pass
Middle Channel	-5.92	-15.2	-21.12	8	Pass
High Channel	-6.84	-15.2	-22.04	8	Pass

<b>TEST ITEM</b>	POWER PECTRAL DENSITY
<b>TEST MODE</b>	802.11n 20 with data rate 6.5

Channel No.	Reading Value (dBm)	BWCF (dB)	PSD (dBm)	Limit (dBm)	Result
Low Channel	-6.85	-15.2	-22.05	8	Pass
Middle Channel	-7.55	-15.2	-22.75	8	Pass
High Channel	-7.6	-15.2	-22.8	8	Pass

<b>TEST ITEM</b>	POWER PECTRAL DENSITY
<b>TEST MODE</b>	802.11n 40 with data rate 13.5

Channel No.	Reading Value (dBm)	BWCF (dB)	PSD (dBm)	Limit (dBm)	Result
Low Channel	-12.71	-15.2	-27.91	8	Pass
Middle Channel	-12.04	-15.2	-27.24	8	Pass
High Channel	-11.85	-15.2	-27.05	8	Pass

### 802.11b TEST RESULT

#### TEST PLOT OF SPECTRAL DENSITY FOR LOW CHANNEL

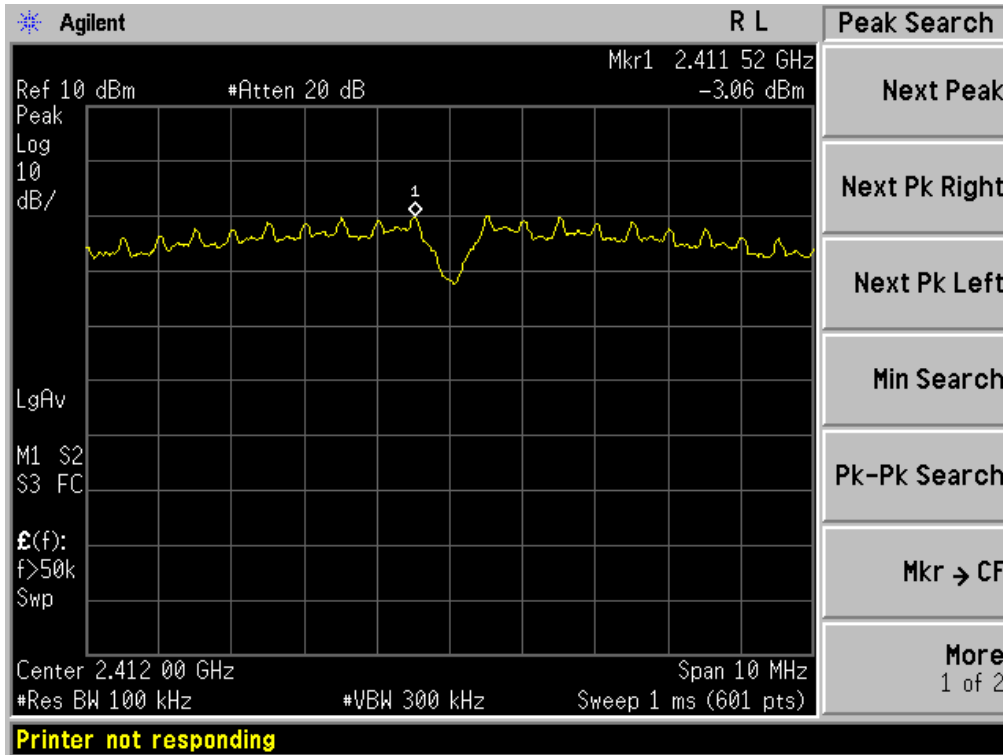

#### TEST PLOT OF SPECTRAL DENSITY FOR MIDDLE CHANNEL

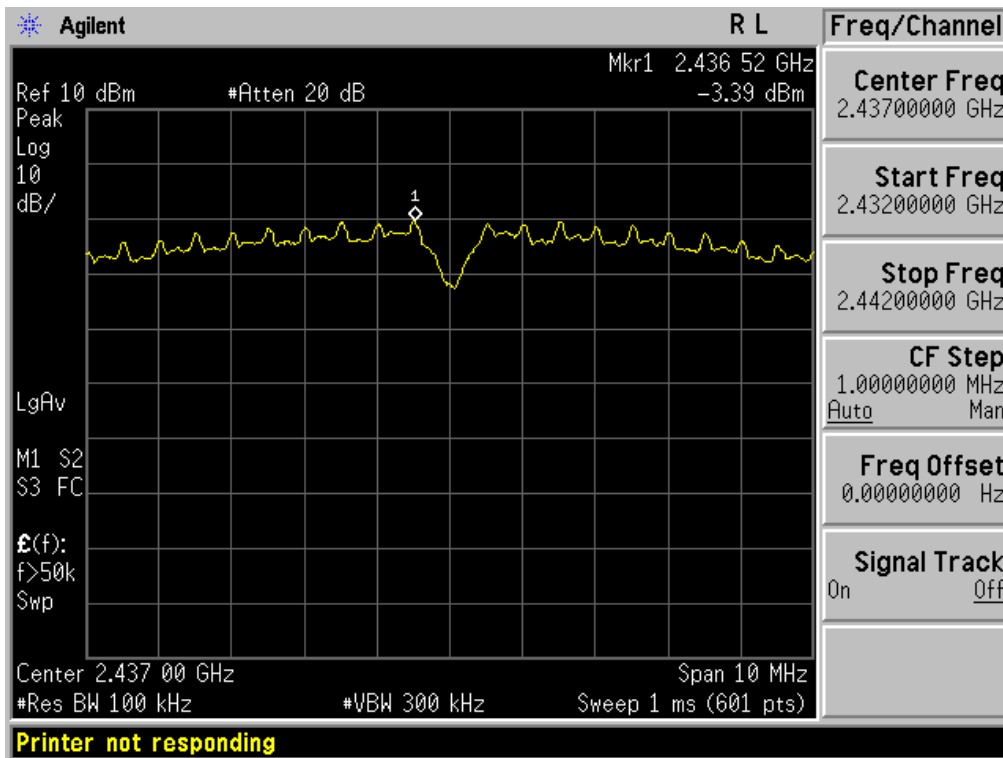

TEST PLOT OF SPECTRAL DENSITY FOR HIGH CHANNEL

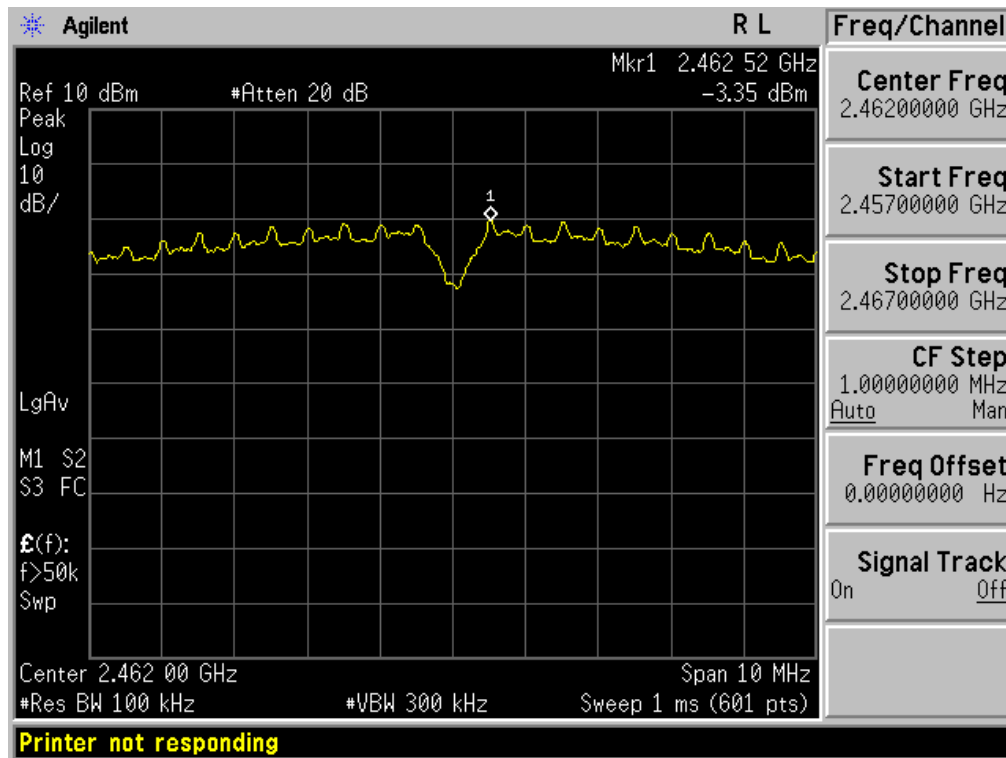

**802.11g TEST RESULT**  
 TEST PLOT OF SPECTRAL DENSITY FOR LOW CHANNEL

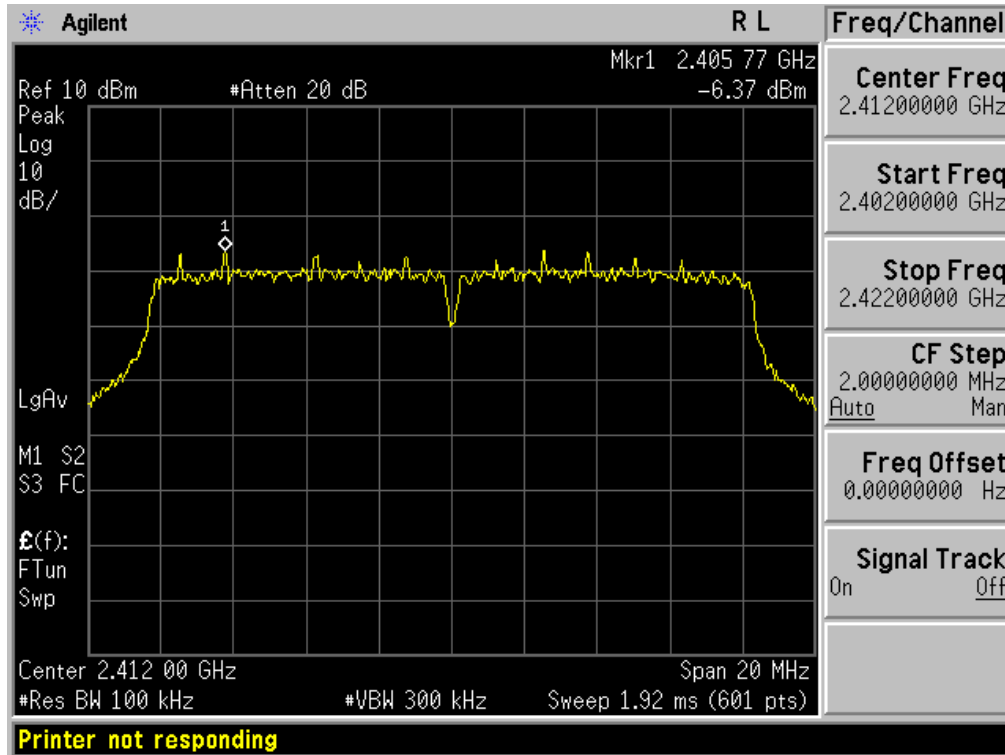

TEST PLOT OF SPECTRAL DENSITY FOR MIDDLE CHANNEL

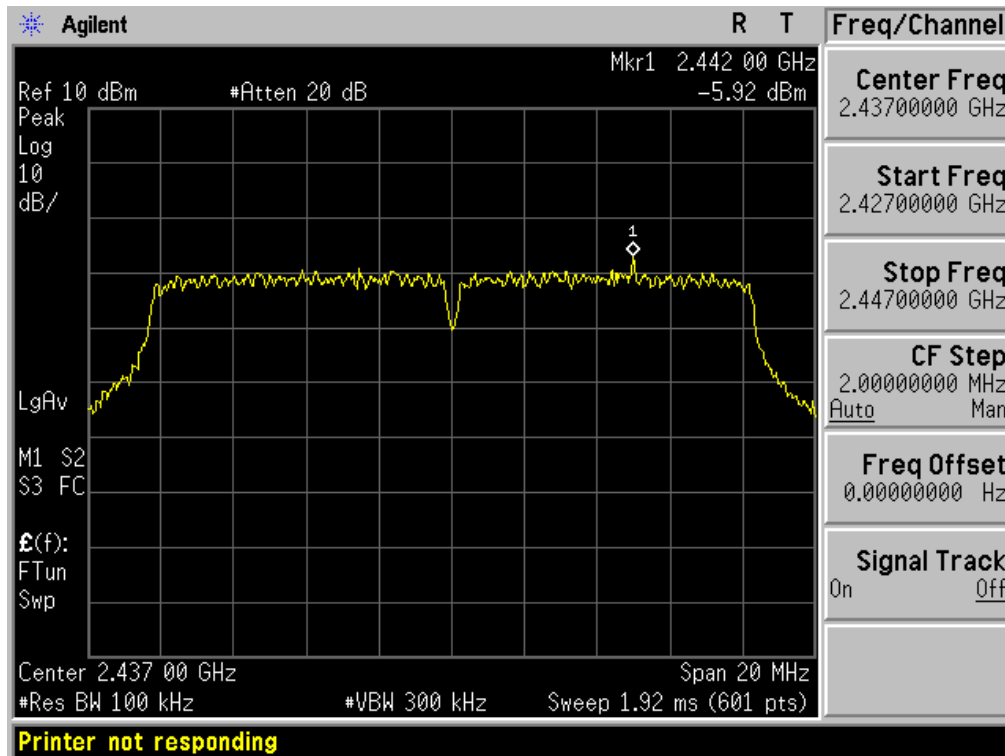

TEST PLOT OF SPECTRAL DENSITY FOR HIGH CHANNEL

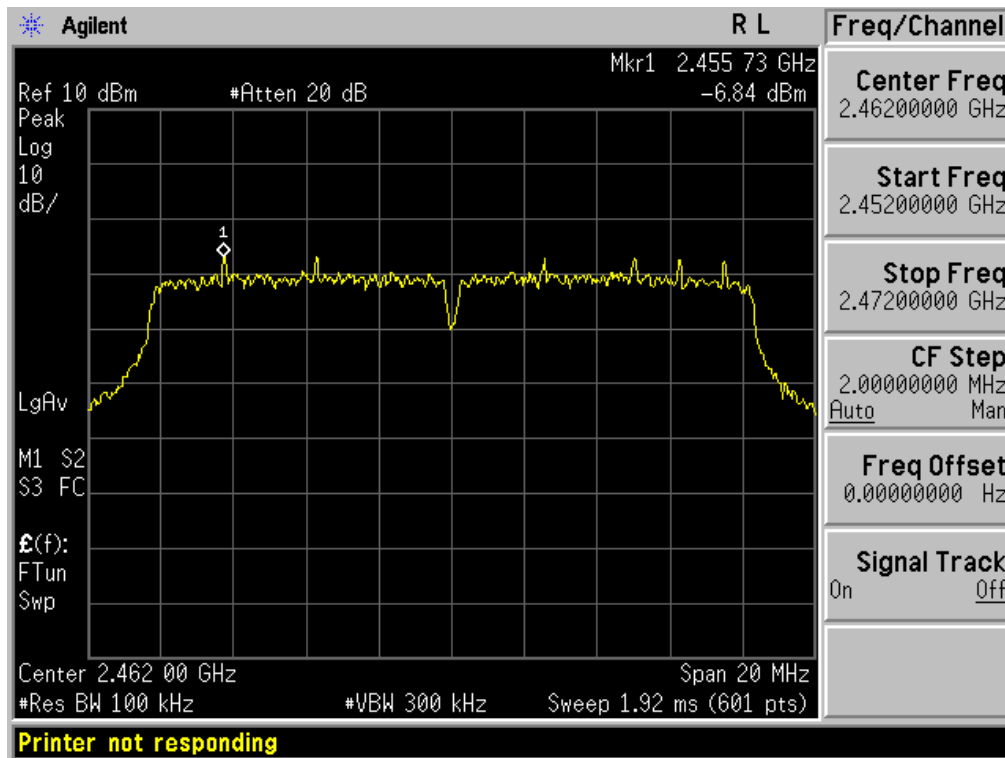

**802.11n 20 TEST RESULT**  
**TEST PLOT OF SPECTRAL DENSITY FOR LOW CHANNEL**

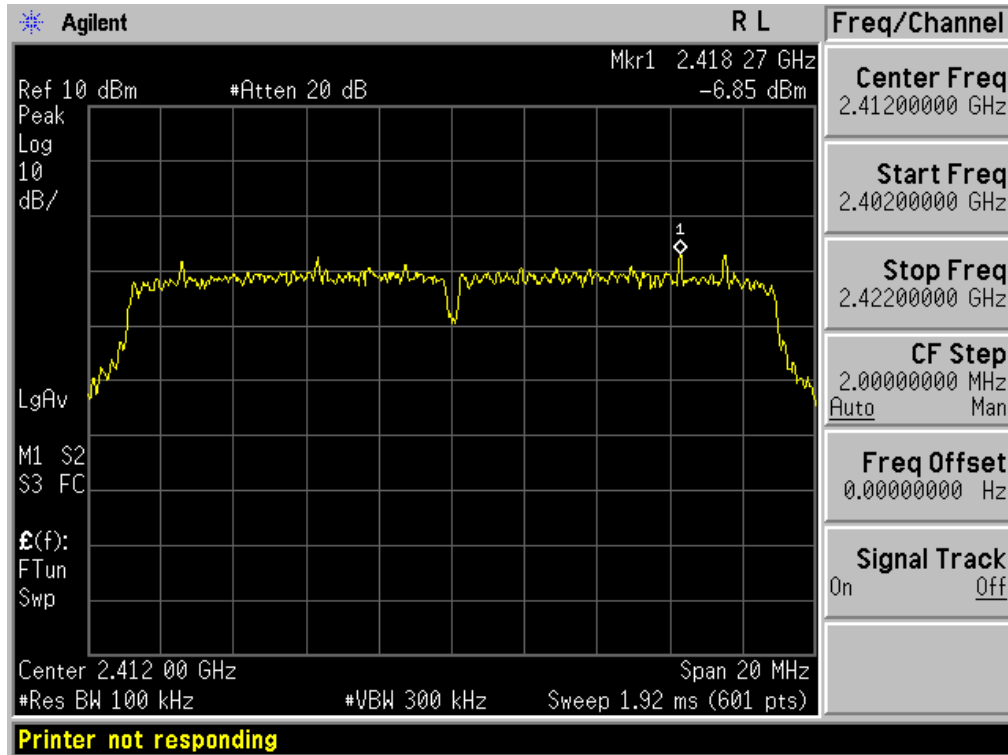

**TEST PLOT OF SPECTRAL DENSITY FOR MIDDLE CHANNEL**

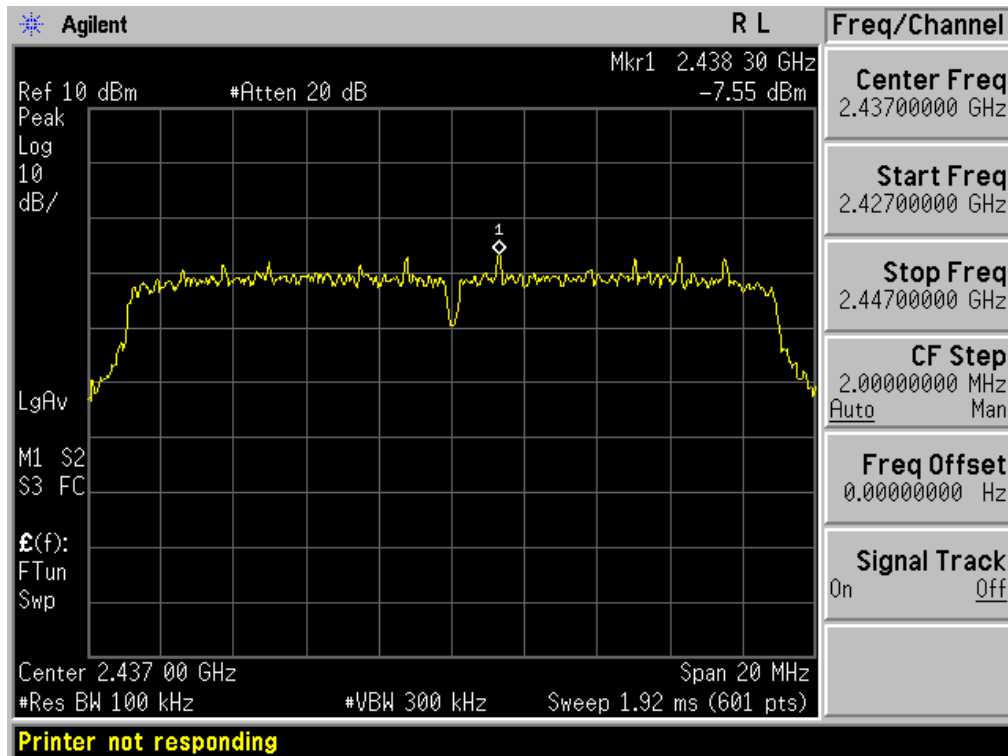



TEST PLOT OF SPECTRAL DENSITY FOR HIGH CHANNEL

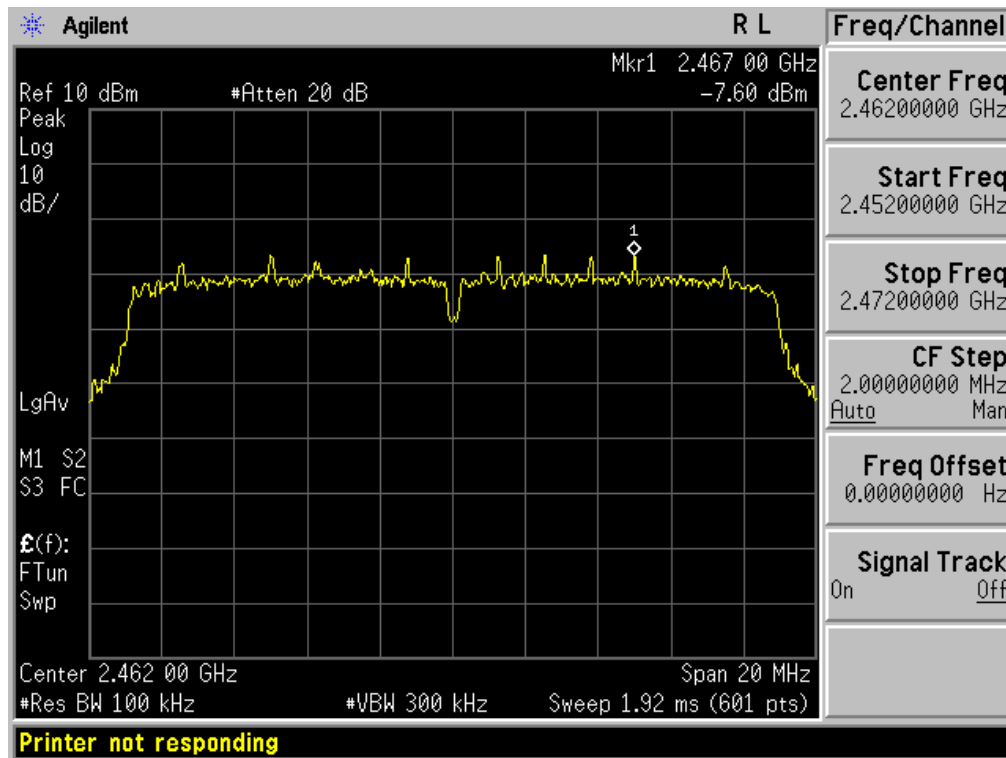

**802.11n 40 TEST RESULT**  
 TEST PLOT OF SPECTRAL DENSITY FOR LOW CHANNEL

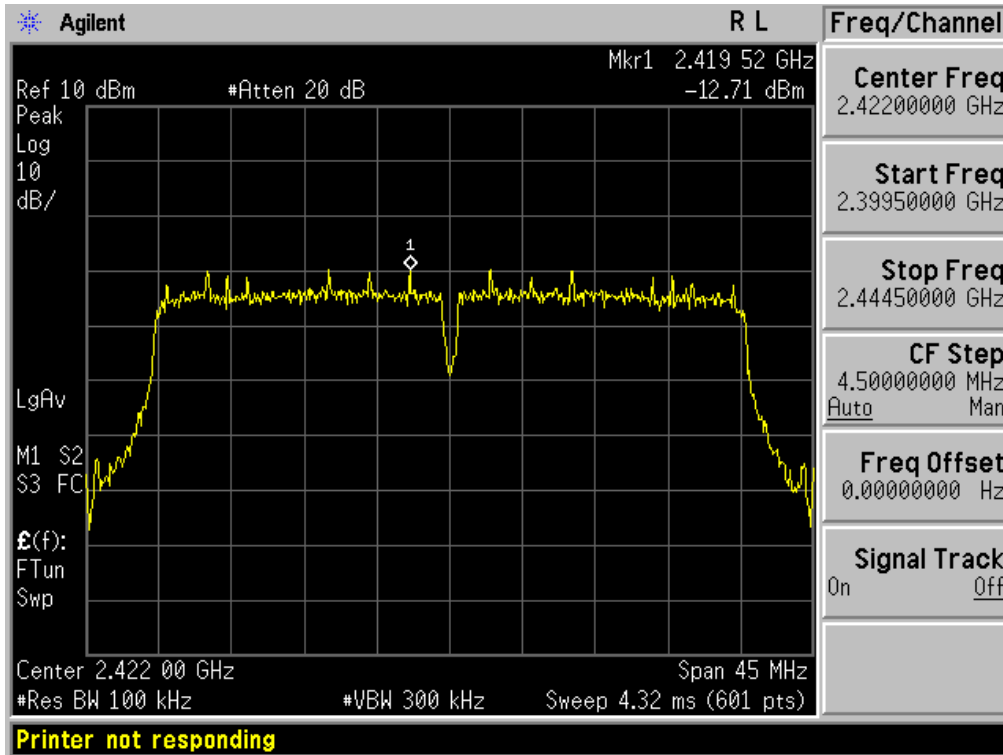

TEST PLOT OF SPECTRAL DENSITY FOR MIDDLE CHANNEL

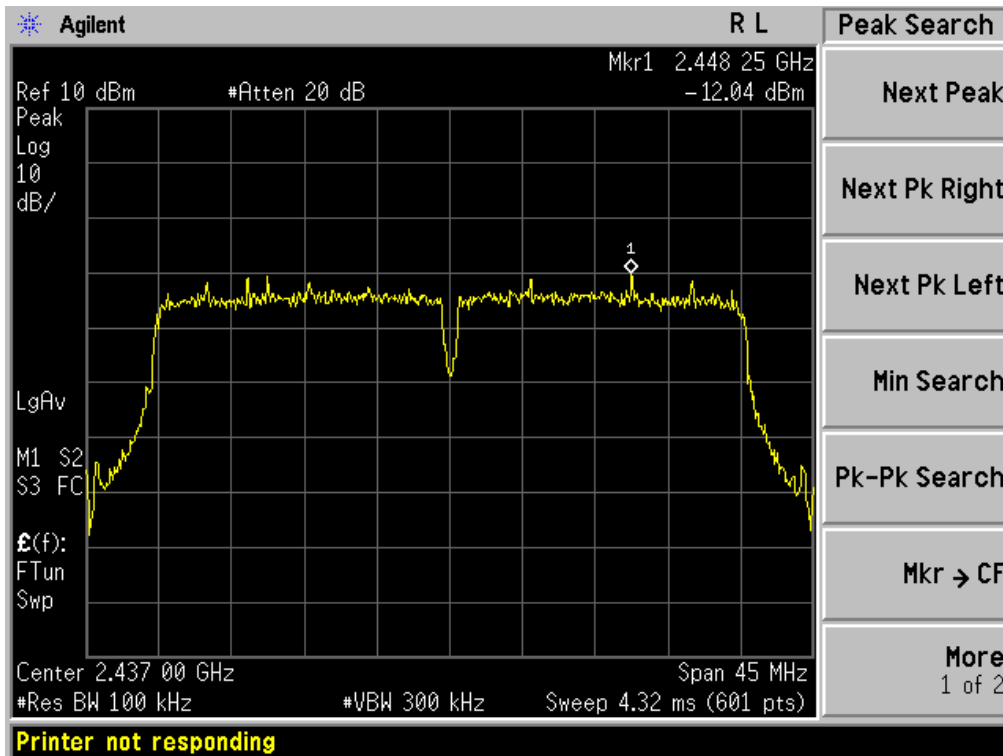

### TEST PLOT OF SPECTRAL DENSITY FOR HIGH CHANNEL

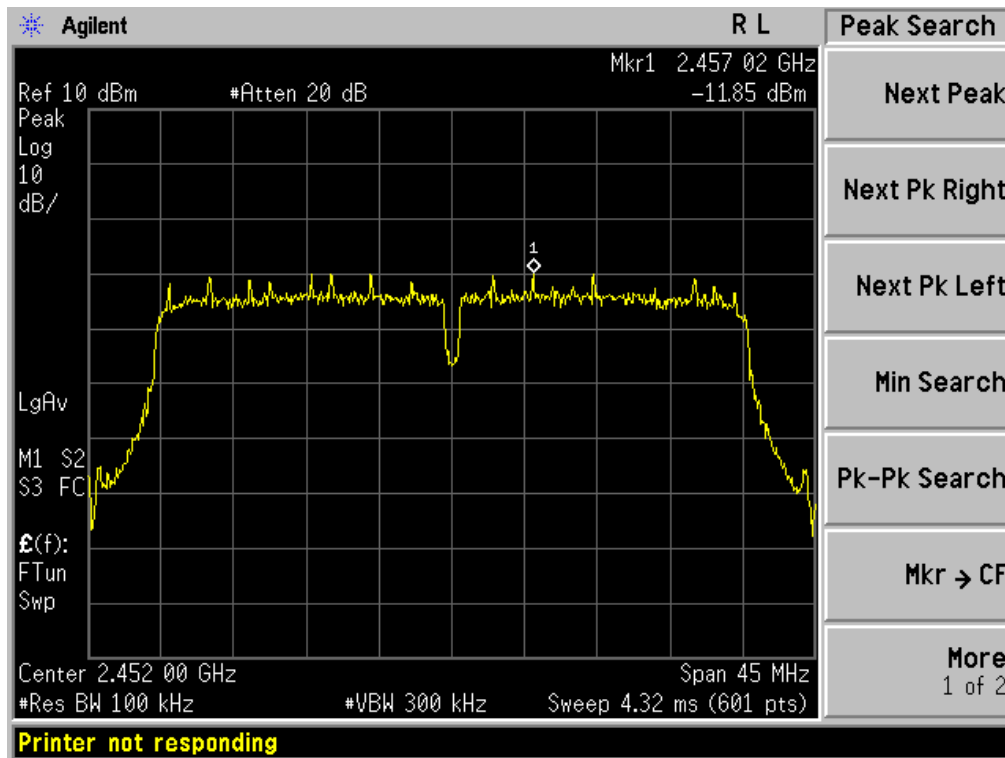

## 11. RADIATED EMISSION

### 11.1. MEASUREMENT PROCEDURE

1. Configure the EUT according to ANSI C63.4. The EUT was placed on the top of the turntable 0.8 meter above ground. The phase center of the receiving antenna mounted on the top of a height-variable antenna tower was placed 3 meters far away from the turntable.
2. Power on the EUT and all the supporting units. The turntable was rotated by 360 degrees to determine the position of the highest radiation.
3. The height of the broadband receiving antenna was varied between one meter and four meters above ground to find the maximum emissions field strength of both horizontal and vertical polarization.
4. For each suspected emissions, the antenna tower was scan (from 1 M to 4 M) and then the turntable was rotated (from 0 degree to 360 degrees) to find the maximum reading.
5. Set the test-receiver system to Peak or CISPR quasi-peak Detect Function with specified bandwidth under Maximum Hold Mode.
6. For emissions above 1GHz, use 1MHz VBW and RBW for peak reading. Then 1MHz RBW and 10Hz VBW for average reading in spectrum analyzer.
7. When the radiated emissions limits are expressed in terms of the average value of the emissions, and pulsed operation is employed, the measurement field strength shall be determined by averaging over one complete pulse train, including blanking intervals, as long as the pulse train does not exceed 0.1 seconds. As an alternative (provided the transmitter operates for longer than 0.1 seconds) or in cases where the pulse train exceeds 0.1 seconds, the measured field strength shall be determined from the average absolute voltage during a 0.1 second interval during which the field strength is at its maximum values.
8. If the emissions level of the EUT in peak mode was 3 dB lower than the average limit specified, then testing will be stopped and peak values of EUT will be reported, otherwise, the emissions which do not have 3 dB margin will be repeated one by one using the quasi-peak method for below 1GHz.
9. For testing above 1GHz, the emissions level of the EUT in peak mode was lower than average limit (that means the emissions level in peak mode also complies with the limit in average mode), then testing will be stopped and peak values of EUT will be reported, otherwise, the emissions will be measured in average mode again and reported.
10. In case the emission is lower than 30MHz, loop antenna has to be used for measurement and the recorded data should be QP measured by receiver. High - Low scan is not required in this case.

## 11.2. TEST SETUP

### RADIATED EMISSION TEST SETUP BELOW 30MHz

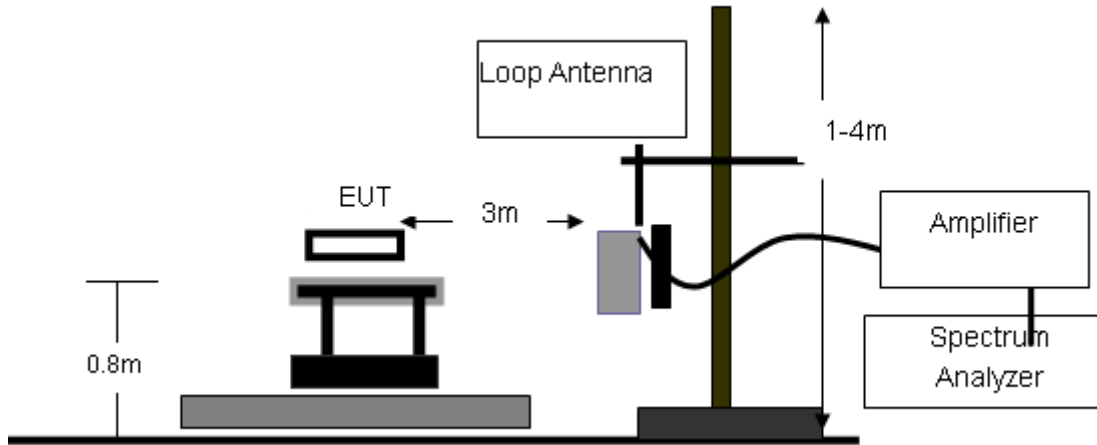

### RADIATED EMISSION TEST SETUP 30MHz-1000MHz

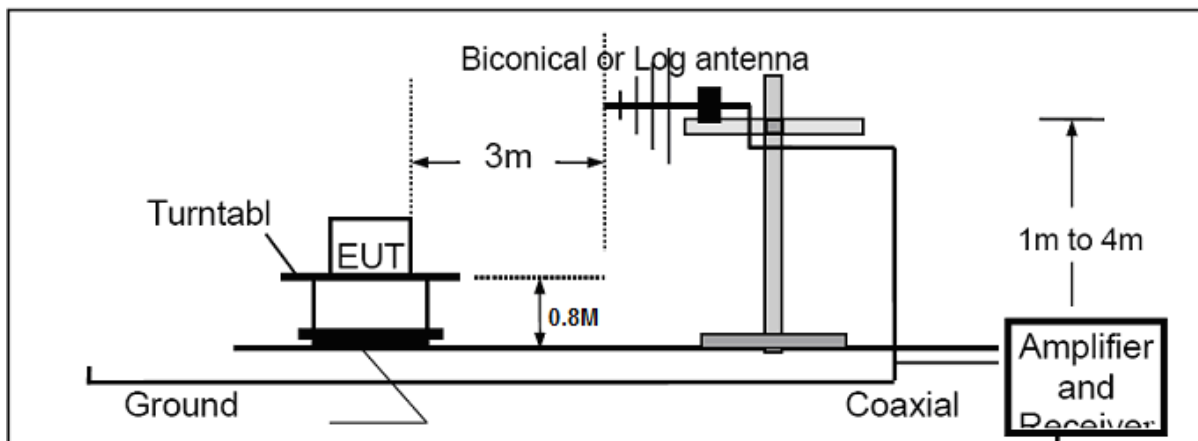

### RADIATED EMISSION TEST SETUP ABOVE 1000MHz

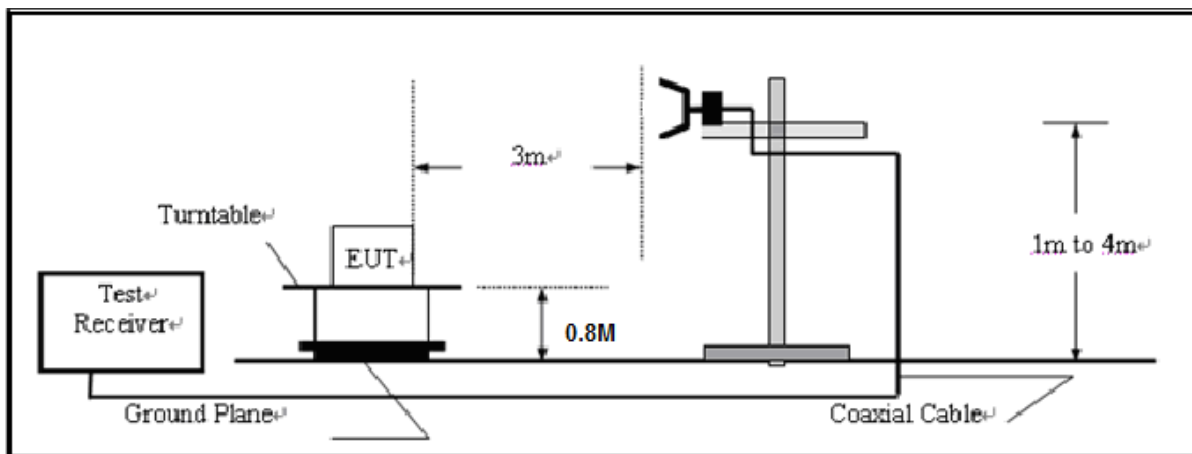

### 11.3. LIMITS AND MEASUREMENT RESULT

15.209(a) Limit in the below table has to be followed

<b>Frequencies (MHz)</b>	<b>Field Strength (micorvolts/meter)</b>	<b>Measurement Distance (meters)</b>
0.009~0.490	2400/F(KHz)	300
0.490~1.705	24000/F(KHz)	30
1.705~30.0	30	30
30~88	100	3
88~216	150	3
216~960	200	3
Above 960	500	3

Note: All modes were tested For restricted band radiated emission,  
the test records reported below are the worst result compared to other modes.

### 11.4. TEST RESULT

#### **RADIATED EMISSION BELOW 30MHZ**

No emission found between lowest internal used/generated frequencies to 30MHz.

**RADIATED EMISSION BELOW 1GHZ**

<b>EUT</b>	HD Sports Video Camera/ iON Air Pro 2 WiFi/Air Pro 2 WiFi/Gen 2 with WiFi	<b>Test Model</b>	#1023
<b>Temperature</b>	25°C	<b>Relative Humidity</b>	55.4%
<b>Pressure</b>	960hPa	<b>Test Voltage</b>	Normal Voltage
<b>Test Mode</b>	802.11b with data rate 1 2412MHZ	<b>Antenna</b>	Horizontal



Site: site #1  
 Limit: FCC Class B 3M Radiation  
 EUT: HD Sports Video Camera  
 M/N: #1023  
 Mode: Low channel TX  
 Note:

Polarization: *Horizontal*  
 Power:  
 Distance:

Temperature: 26  
 Humidity: 60 %

No.	Mk	Freq.	Reading	Factor	Measurement	Limit	Over	Detector	Antenna Height	Table Degree	Comment
		MHz	dBuV	dB/m	dBuV/m	dBuV/m	dB		cm	degree	
1		84.9666	2.93	13.89	16.82	40.00	-23.18	peak			
2		351.7167	1.98	19.06	21.04	46.00	-24.96	peak			
3		400.2167	18.86	15.88	34.74	46.00	-11.26	peak			
4		487.5167	4.33	22.15	26.48	46.00	-19.52	peak			
5		600.6833	10.69	24.92	35.61	46.00	-10.39	peak			
6	*	856.1167	10.11	29.54	39.65	46.00	-6.35	peak			

**RESULT: PASS**

<b>EUT</b>	HD Sports Video Camera/ iON Air Pro 2 WiFi/Air Pro 2 WiFi/Gen 2 with WiFi	<b>Test Model</b>	#1023
<b>Temperature</b>	25°C	<b>Relative Humidity</b>	55.4%
<b>Pressure</b>	960hPa	<b>Test Voltage</b>	Normal Voltage
<b>Test Mode</b>	802.11b with data rate 1 2412MHZ	<b>Antenna</b>	Vertical

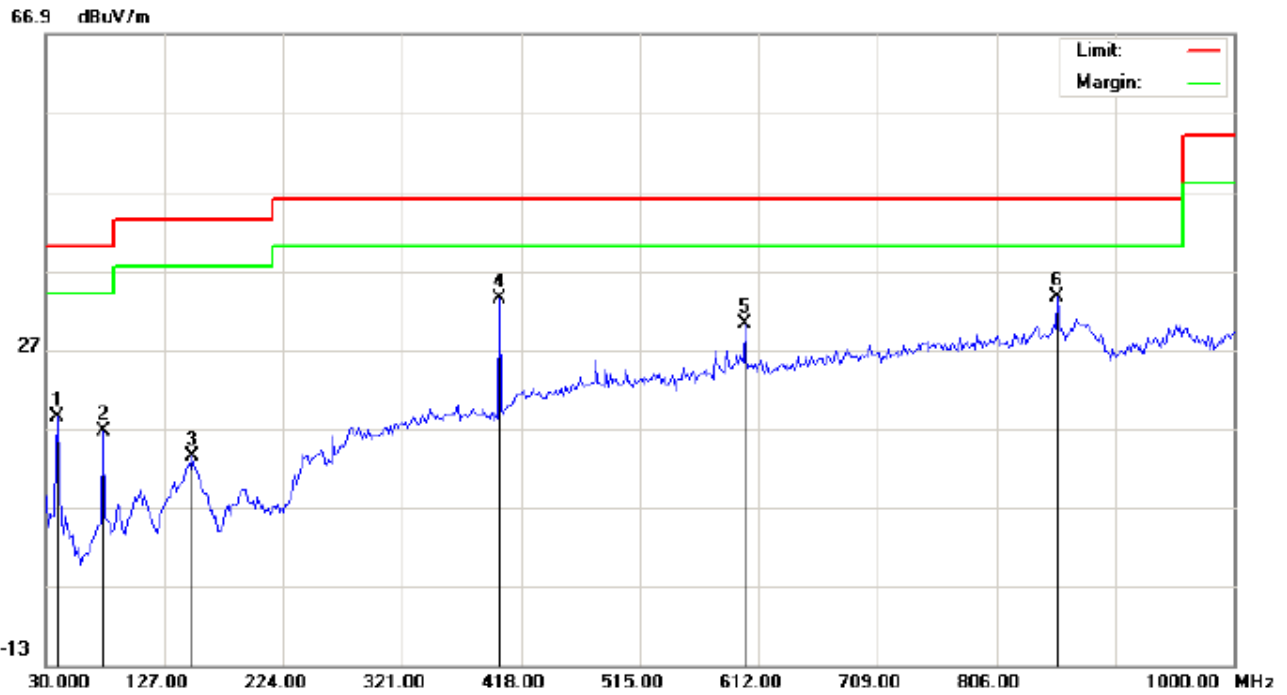

Site: site #1  
 Limit: FCC Class B 3M Radiation  
 EUT: HD Sports Video Camera  
 M/N: #1023  
 Mode: Low channel TX  
 Note:

Polarization: *Vertical*  
 Power:  
 Distance:

Temperature: 26  
 Humidity: 60 %

No.	Mk	Freq.	Reading	Factor	Measurement	Limit	Over	Detector	Antenna Height	Table Degree	Comment
		MHz	dBuV	dB/m	dBuV/m	dBuV/m	dB		cm	degree	
1		39.7000	10.68	7.76	18.44	40.00	-21.56	peak			
2		76.8833	10.91	5.64	16.55	40.00	-23.45	peak			
3		149.6333	-0.75	14.15	13.40	43.50	-30.10	peak			
4		400.2167	14.59	18.86	33.45	46.00	-12.55	peak			
5		600.6833	5.36	24.92	30.28	46.00	-15.72	peak			
6	*	856.1167	4.46	29.05	33.51	46.00	-12.49	peak			

**RESULT: PASS**



<b>EUT</b>	HD Sports Video Camera/ iON Air Pro 2 WiFi/Air Pro 2 WiFi/Gen 2 with WiFi	<b>Test Model</b>	#1023
<b>Temperature</b>	25°C	<b>Relative Humidity</b>	55.4%
<b>Pressure</b>	960hPa	<b>Test Voltage</b>	Normal Voltage
<b>Test Mode</b>	802.11b with date rate 1 2437MHZ	<b>Antenna</b>	Horizontal

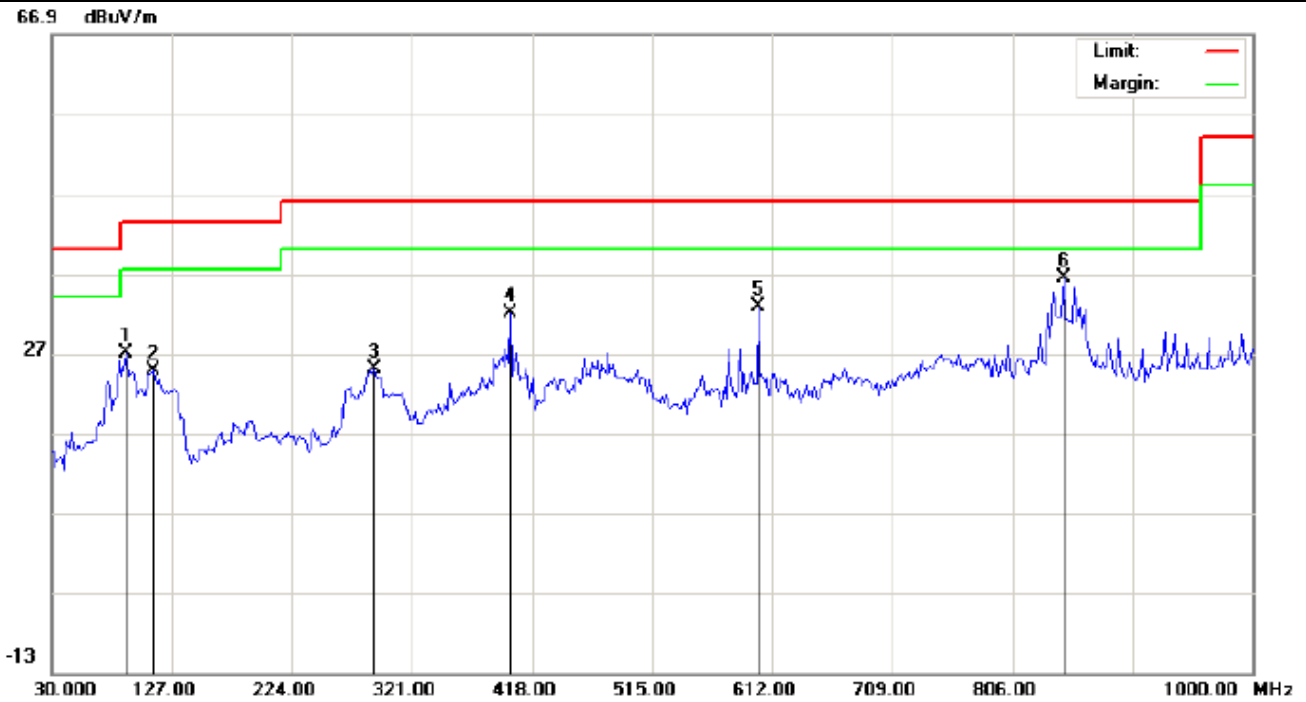

Site: site #1  
 Limit: FCC Class B 3M Radiation  
 EUT: HD Sports Video Camera  
 M/N: #1023  
 Mode: Middle channel TX  
 Note:

Polarization: *Horizontal*  
 Power:  
 Distance:

Temperature: 26  
 Humidity: 60 %

No.	Mk	Freq.	Reading	Factor	Measurement	Limit	Over	Detector	Antenna Height	Table Degree	Comment
		MHz	dBuV	dB/m	dBuV/m	dBuV/m	dB		cm	degree	
1		89.8165	9.93	17.11	27.04	43.50	-16.46	peak			
2		112.4500	12.09	12.63	24.72	43.50	-18.78	peak			
3		290.2832	7.89	17.10	24.99	46.00	-21.01	peak			
4		400.2167	16.08	15.88	31.96	46.00	-14.04	peak			
5		600.6833	7.97	24.92	32.89	46.00	-13.11	peak			
6	*	848.0333	6.03	30.45	36.48	46.00	-9.52	peak			

**RESULT: PASS**

<b>EUT</b>	HD Sports Video Camera/ iON Air Pro 2 WiFi/Air Pro 2 WiFi/Gen 2 with WiFi	<b>Test Model</b>	#1023
<b>Temperature</b>	25°C	<b>Relative Humidity</b>	55.4%
<b>Pressure</b>	960hPa	<b>Test Voltage</b>	Normal Voltage
<b>Test Mode</b>	802.11b with date rate 1 2437MHZ	<b>Antenna</b>	Vertical

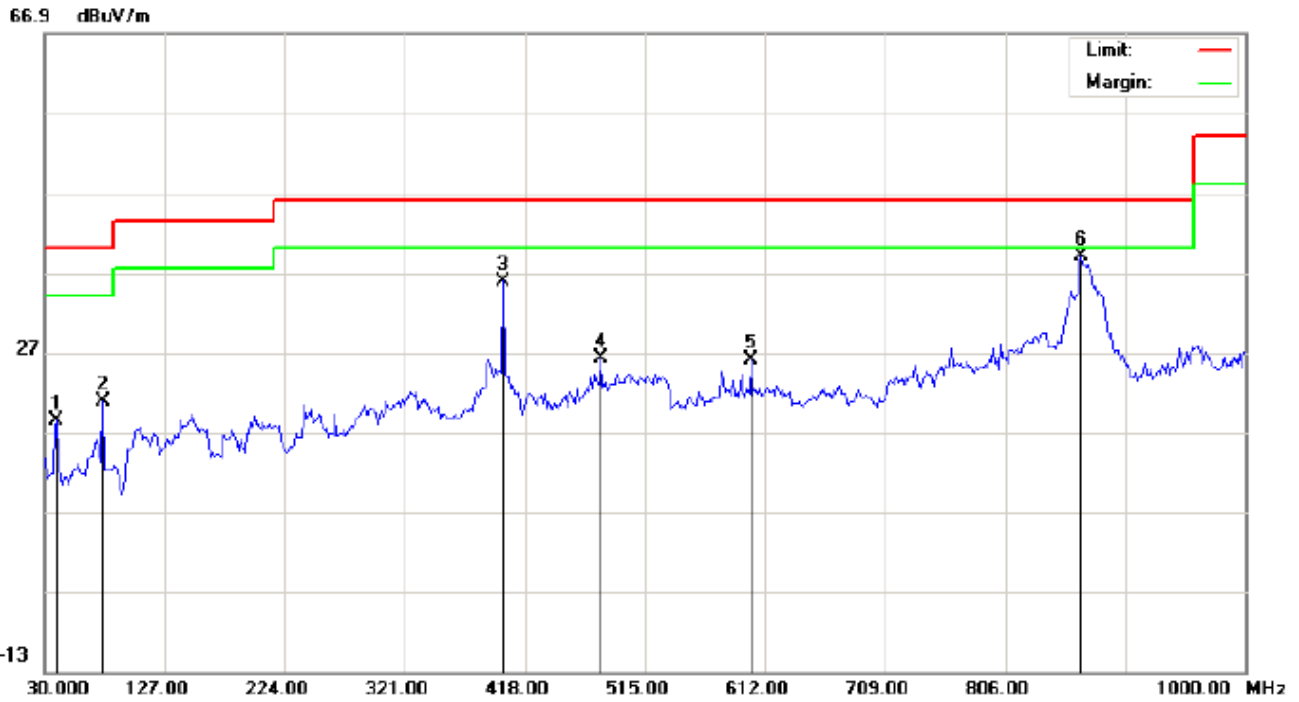

Site: site #1  
Limit: FCC Class B 3M Radiation  
EUT: HD Sports Video Camera  
M/N: #1023  
Mode: Middle channel TX  
Note:

Polarization: *Vertical*  
Power:  
Distance:

Temperature: 26  
Humidity: 60 %

No.	Mk	Freq.	Reading	Factor	Measurement	Limit	Over	Detector	Antenna Height	Table Degree	Comment
		MHz	dBuV	dB/m	dBuV/m	dBuV/m	dB		cm	degree	
1		39.7000	10.62	7.76	18.38	40.00	-21.62	peak			
2		76.8833	15.09	5.64	20.73	40.00	-19.27	peak			
3		400.2167	17.04	18.86	35.90	46.00	-10.10	peak			
4		479.4332	4.62	21.67	26.29	46.00	-19.71	peak			
5		600.6833	1.09	24.92	26.01	46.00	-19.99	peak			
6	*	867.4333	9.40	29.60	39.00	46.00	-7.00	peak			

**RESULT: PASS**

<b>EUT</b>	HD Sports Video Camera/ iON Air Pro 2 WiFi/Air Pro 2 WiFi/Gen 2 with WiFi	<b>Test Model</b>	#1023
<b>Temperature</b>	25°C	<b>Relative Humidity</b>	55.4%
<b>Pressure</b>	960hPa	<b>Test Voltage</b>	Normal Voltage
<b>Test Mode</b>	802.11b with date rate 1 2462MHZ	<b>Antenna</b>	Horizontal

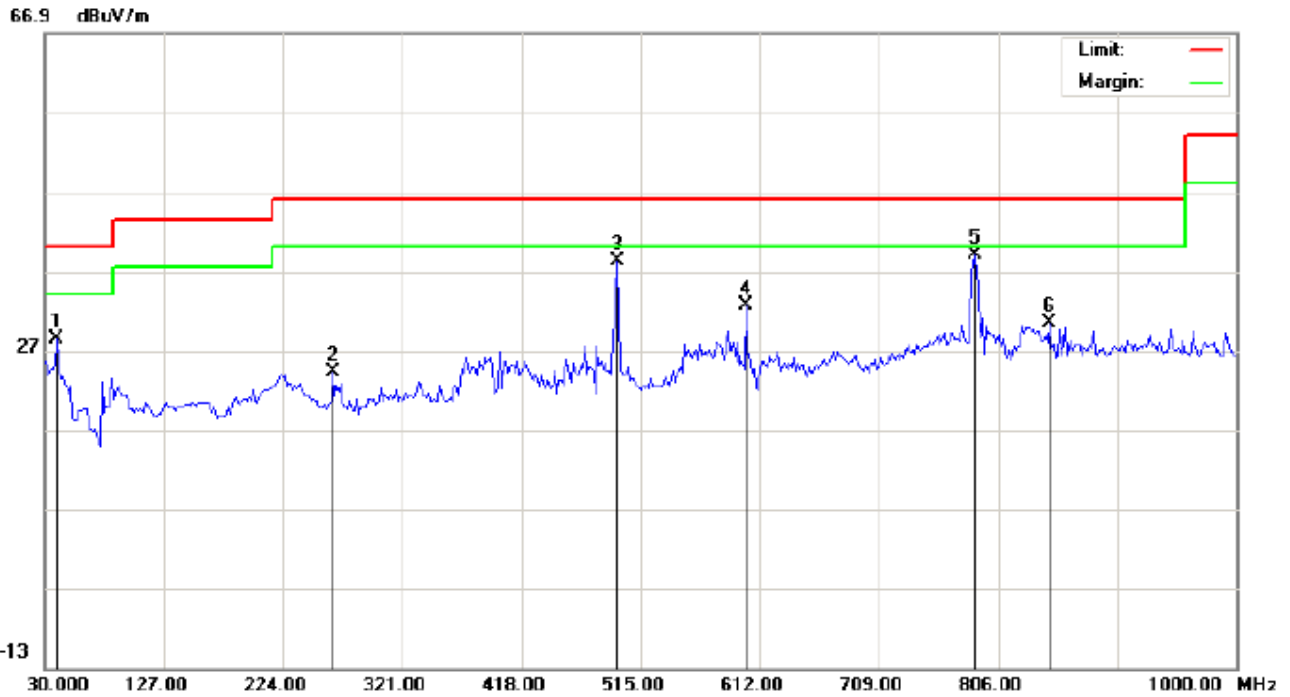

Site: site #1  
 Limit: FCC Class B 3M Radiation  
 EUT: HD Sports Video Camera  
 M/N: #1023  
 Mode: High channel TX  
 Note:

Polarization: *Horizontal*  
 Power:  
 Distance:

Temperature: 26  
 Humidity: 60 %

No.	Mk	Freq.	Reading	Factor	Measurement	Limit	Over	Detector	Antenna Height	Table Degree	Comment
		MHz	dBuV	dB/m	dBuV/m	dBuV/m	dB		cm	degree	
1		39.7000	20.35	8.04	28.39	40.00	-11.61	peak			
2		264.4166	9.56	14.71	24.27	46.00	-21.73	peak			
3		495.6000	15.43	22.68	38.11	46.00	-7.89	peak			
4		600.6833	7.69	24.92	32.61	46.00	-13.39	peak			
5	*	786.6000	10.96	28.10	39.06	46.00	-6.94	peak			
6		848.0333	-0.13	30.45	30.32	46.00	-15.68	peak			

**RESULT: PASS**

<b>EUT</b>	HD Sports Video Camera/ iON Air Pro 2 WiFi/Air Pro 2 WiFi/Gen 2 with WiFi	<b>Test Model</b>	#1023
<b>Temperature</b>	25°C	<b>Relative Humidity</b>	55.4%
<b>Pressure</b>	960hPa	<b>Test Voltage</b>	Normal Voltage
<b>Test Mode</b>	802.11b with data rate 1 2462MHZ	<b>Antenna</b>	Vertical

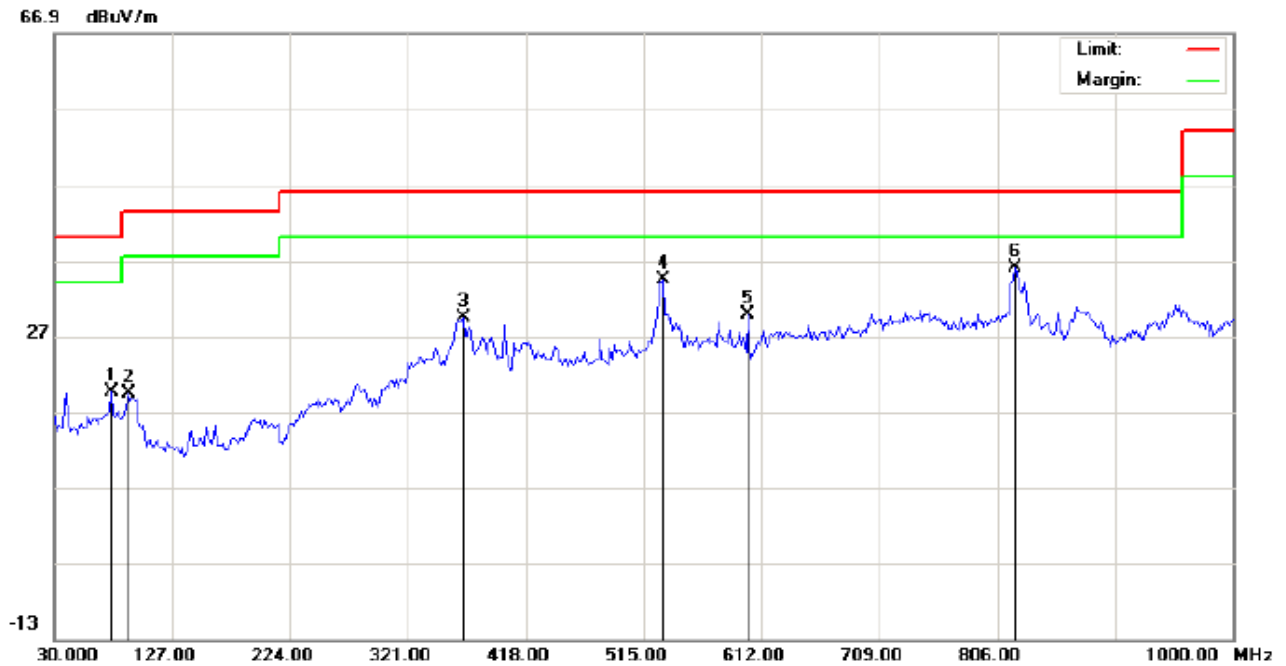

Site: site #1  
 Limit: FCC Class B 3M Radiation  
 EUT: HD Sports Video Camera  
 M/N: #1023  
 Mode: High channel TX  
 Note:

Polarization: *Vertical*  
 Power:  
 Distance:

Temperature: 26  
 Humidity: 60 %

No.	Mk	Freq.	Reading	Factor	Measurement	Limit	Over	Detector	Antenna Height	Table Degree	Comment
		MHz	dBuV	dB/m	dBuV/m	dBuV/m	dB		cm	degree	
1		76.8833	13.91	5.64	19.55	40.00	-20.45	peak			
2		91.4333	11.81	7.58	19.39	43.50	-24.11	peak			
3		366.2667	10.32	19.15	29.47	46.00	-16.53	peak			
4		531.1666	10.98	23.37	34.35	46.00	-11.65	peak			
5		600.6833	4.86	24.92	29.78	46.00	-16.22	peak			
6	*	820.5499	7.98	28.09	36.07	46.00	-9.93	peak			

**RESULT: PASS**

**Note:** Measurement= Reading + Factor, Over=Measure-Limit.

**RADIATED EMISSION ABOVE 1GHZ**

<b>EUT</b>	HD Sports Video Camera/ iON Air Pro 2 WiFi/Air Pro 2 WiFi/Gen 2 with WiFi	<b>Test Model</b>	#1023
<b>Temperature</b>	25°C	<b>Relative Humidity</b>	55.4%
<b>Pressure</b>	960hPa	<b>Test Voltage</b>	Normal Voltage
<b>Test Mode</b>	802.11b with date rate 1 2412MHZ	<b>Antenna</b>	Horizontal

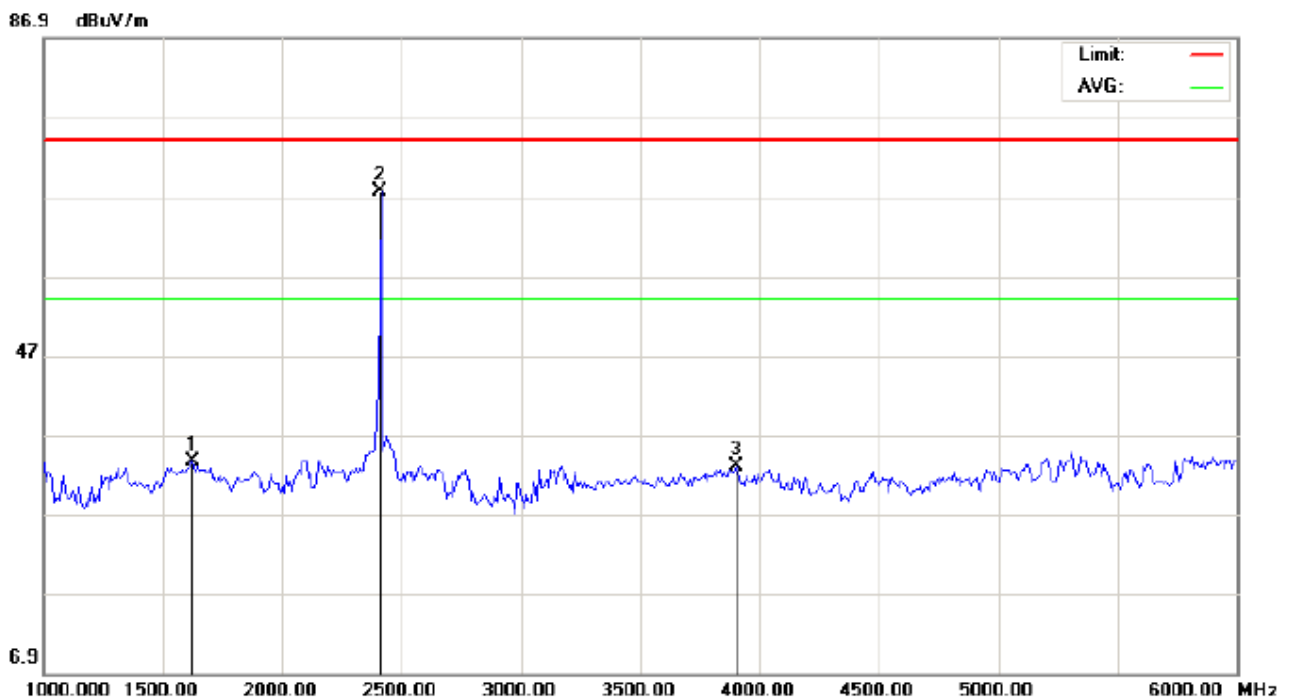

Site: site #1  
Limit: FCC Class B 3M Radiation above 1GHZ(PK)  
EUT: HD Sports Video Camera  
M/N: #1023  
Mode: Low channel TX  
Note:

Polarization: *Horizontal*  
Power:  
Distance: 3m

Temperature: 26  
Humidity: 60 %

No.	Mk	Freq.	Reading	Factor	Measurement	Limit	Over	Detector	Antenna	Table	Comment
		MHz	dBuV	dB/m	dBuV/m	dBuV/m	dB		Height	Degree	
									cm	degree	
1		1625.000	33.58	0.00	33.58	74.00	-40.42	peak			
2	*	2412.002	67.66	0.00	67.66	74.00	-6.34	peak			
3		3900.000	32.93	0.00	32.93	74.00	-41.07	peak			

**RESULT: PASS**

<b>EUT</b>	HD Sports Video Camera/ iON Air Pro 2 WiFi/Air Pro 2 WiFi/Gen 2 with WiFi	<b>Test Model</b>	#1023
<b>Temperature</b>	25°C	<b>Relative Humidity</b>	55.4%
<b>Pressure</b>	960hPa	<b>Test Voltage</b>	Normal Voltage
<b>Test Mode</b>	802.11b with date rate 1 2412MHZ	<b>Antenna</b>	Vertical

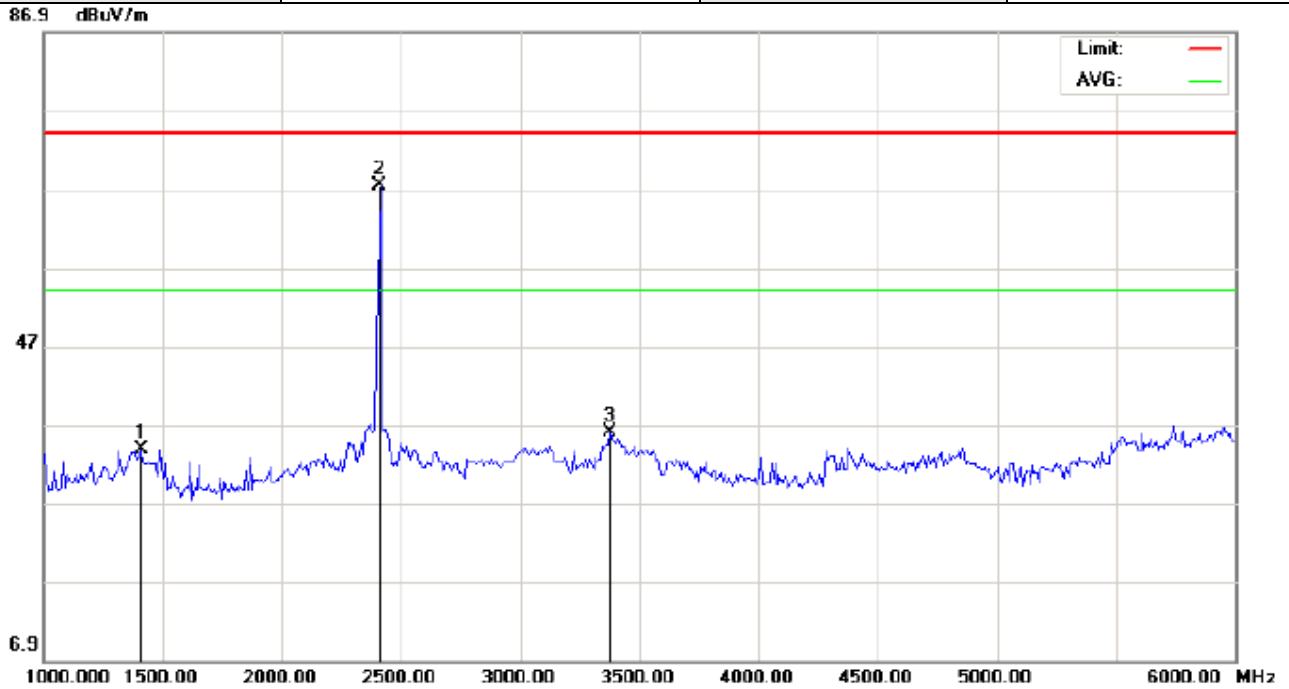

Site: site #1  
 Limit: FCC Class B 3M Radiation above 1GHZ(PK)  
 EUT: HD Sports Video Camera  
 M/N: #1023  
 Mode: Low channel TX  
 Note:

Polarization: *Vertical*  
 Power:  
 Distance: 3m

Temperature: 26  
 Humidity: 60 %

No.	Mk	Freq.	Reading	Factor	Measurement	Limit	Over	Detector	Antenna Height	Table Degree	Comment
		MHz	dBuV	dB/m	dBuV/m	dBuV/m	dB		cm	degree	
1		1408.333	33.85	0.00	33.85	74.00	-40.15	peak			
2	*	2412.005	67.42	0.00	67.42	74.00	-6.58	peak			
3		3375.000	35.98	0.00	35.98	74.00	-38.02	peak			

**RESULT: PASS**

**Note:** The other modes radiation emissions have more than 20dB margin.

Measurement= Reading + Factor, Over=Measure-Limit.

All modes radiation emission from 6GHz to 25GHz at least have 20dB margin.

## **12. BAND EDGE EMISSION**

### **12.1. MEASUREMENT PROCEDURE**

1. Set the EUT Work on the top, the bottom operation frequency individually.
2. Set SPA Start or Stop Frequency = Operation Frequency,  $RBW \geq 1\% \text{span}$ ,  $VBW \geq RBW$
3. The band edges was measured and recorded.

### **12.2. TEST SET-UP**

Radiated same as 8.2

12.3. TEST RESULT

<b>EUT</b>	HD Sports Video Camera/ iON Air Pro 2 WiFi/Air Pro 2 WiFi/Gen 2 with WiFi	<b>Test Model</b>	#1023
<b>Temperature</b>	25°C	<b>Relative Humidity</b>	55.4%
<b>Pressure</b>	960hPa	<b>Test Voltage</b>	Normal Voltage
<b>Test Mode</b>	802.11b with data rate 1 2412MHZ	<b>Antenna</b>	Horizontal

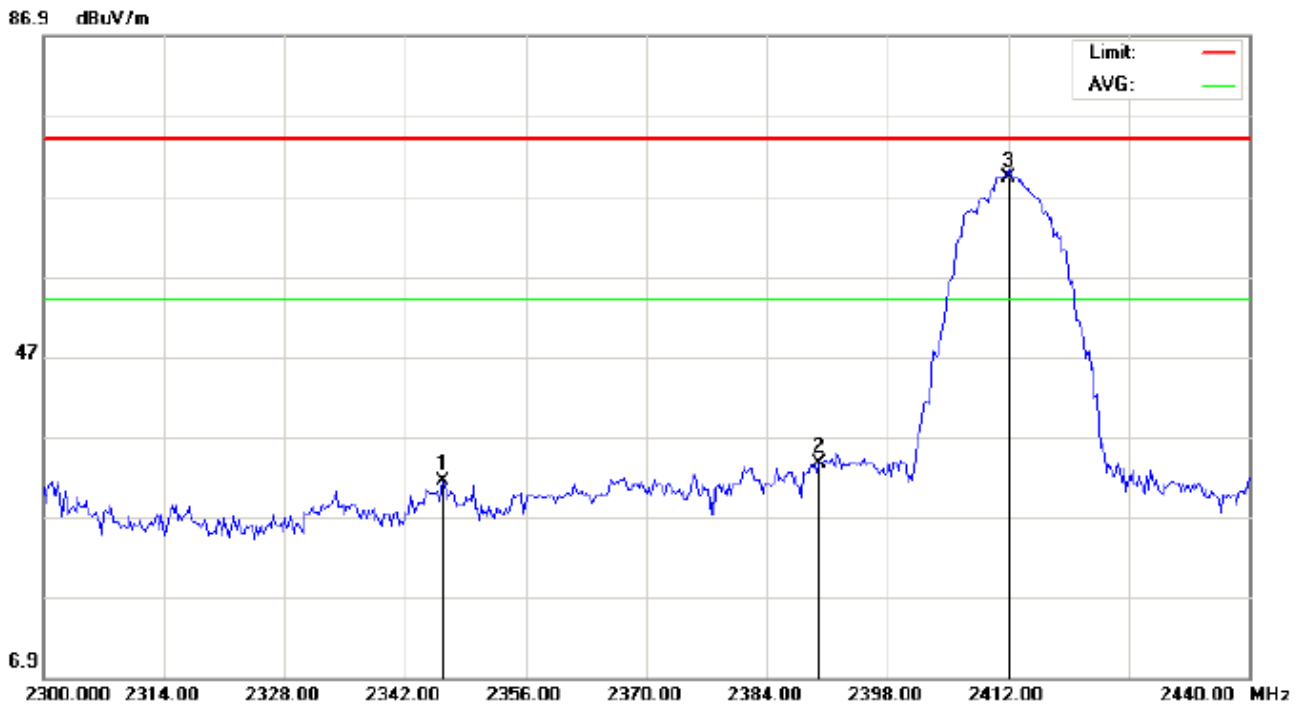

Site: site #1  
 Limit: FCC Class B 3M Radiation above 1GHZ(PK)  
 EUT: HD Sports Video Camera  
 M/N: #1023  
 Mode: 802.11b Low channel TX  
 Note:

Polarization: **Horizontal**  
 Power:  
 Distance: 3m

Temperature: 26  
 Humidity: 60 %

No.	Mk	Freq.	Reading	Factor	Measurement	Limit	Over	Detector	Antenna Height	Table Degree	Comment
		MHz	dBuV	dB/m	dBuV/m	dBuV/m	dB		cm	degree	
1		2346.433	31.45	0.00	31.45	74.00	-42.55	peak			
2		2390.003	33.60	0.00	33.60	74.00	-40.40	peak			
3	*	2412.003	69.23	0.00	69.23	74.00	-4.77	peak			

**RESULT: PASS**



<b>EUT</b>	HD Sports Video Camera/ iON Air Pro 2 WiFi/Air Pro 2 WiFi/Gen 2 with WiFi	<b>Test Model</b>	#1023
<b>Temperature</b>	25°C	<b>Relative Humidity</b>	55.4%
<b>Pressure</b>	960hPa	<b>Test Voltage</b>	Normal Voltage
<b>Test Mode</b>	802.11b with data rate 1 2412MHZ	<b>Antenna</b>	Vertical

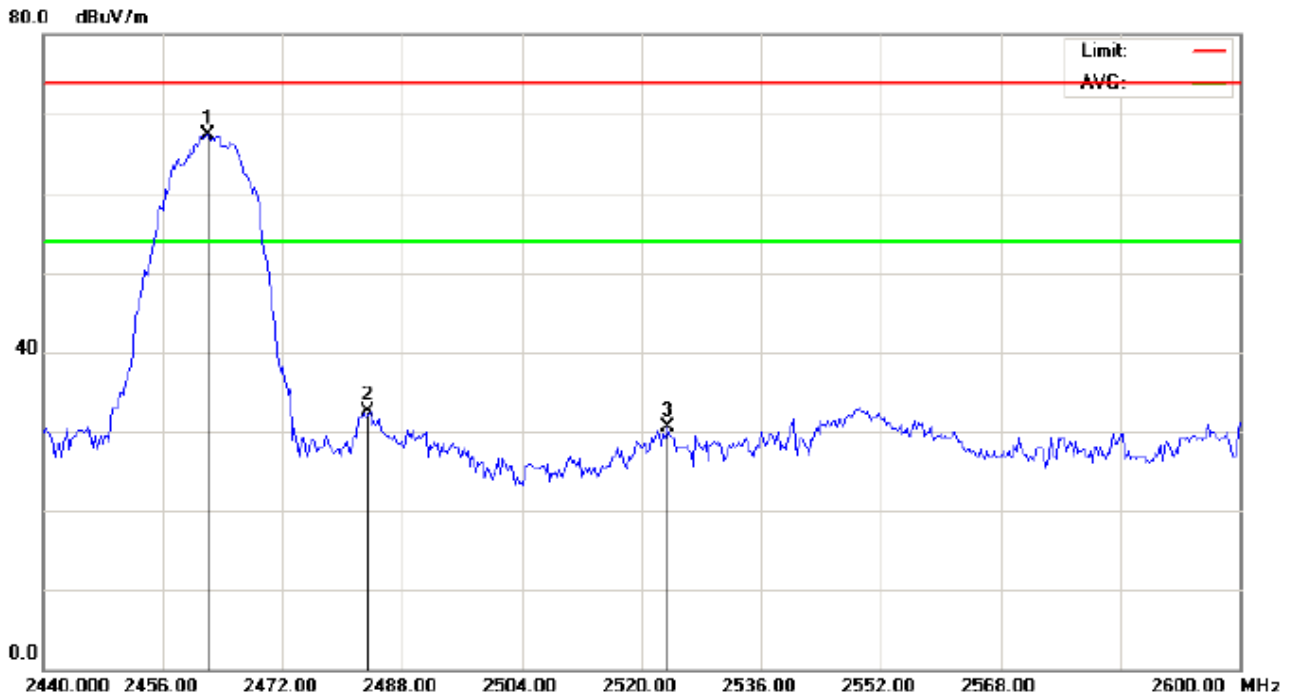

Site: site #1 Polarization: *Horizontal* Temperature: 26  
 Limit: FCC Class B 3M Radiation above 1GHZ(PK) Power: Humidity: 60 %  
 EUT: HD Sports Video Camera Distance: 3m  
 M/N: #1023  
 Mode: 802.11b High channel TX  
 Note:

No.	Mk	Freq.	Reading	Factor	Measurement	Limit	Over	Detector	Antenna Height	Table Degree	Comment
		MHz	dBuV	dB/m	dBuV/m	dBuV/m	dB		cm	degree	
1	*	2462.004	67.26	0.00	67.26	74.00	-6.74	peak			
2		2483.502	32.58	0.00	32.58	74.00	-41.42	peak			
3		2523.467	30.42	0.00	30.42	74.00	-43.58	peak			

**RESULT: PASS**

<b>EUT</b>	HD Sports Video Camera/ iON Air Pro 2 WiFi/Air Pro 2 WiFi/Gen 2 with WiFi	<b>Test Model</b>	#1023
<b>Temperature</b>	25°C	<b>Relative Humidity</b>	55.4%
<b>Pressure</b>	960hPa	<b>Test Voltage</b>	Normal Voltage
<b>Test Mode</b>	802.11b with data rate 1 2462MHZ	<b>Antenna</b>	Horizontal

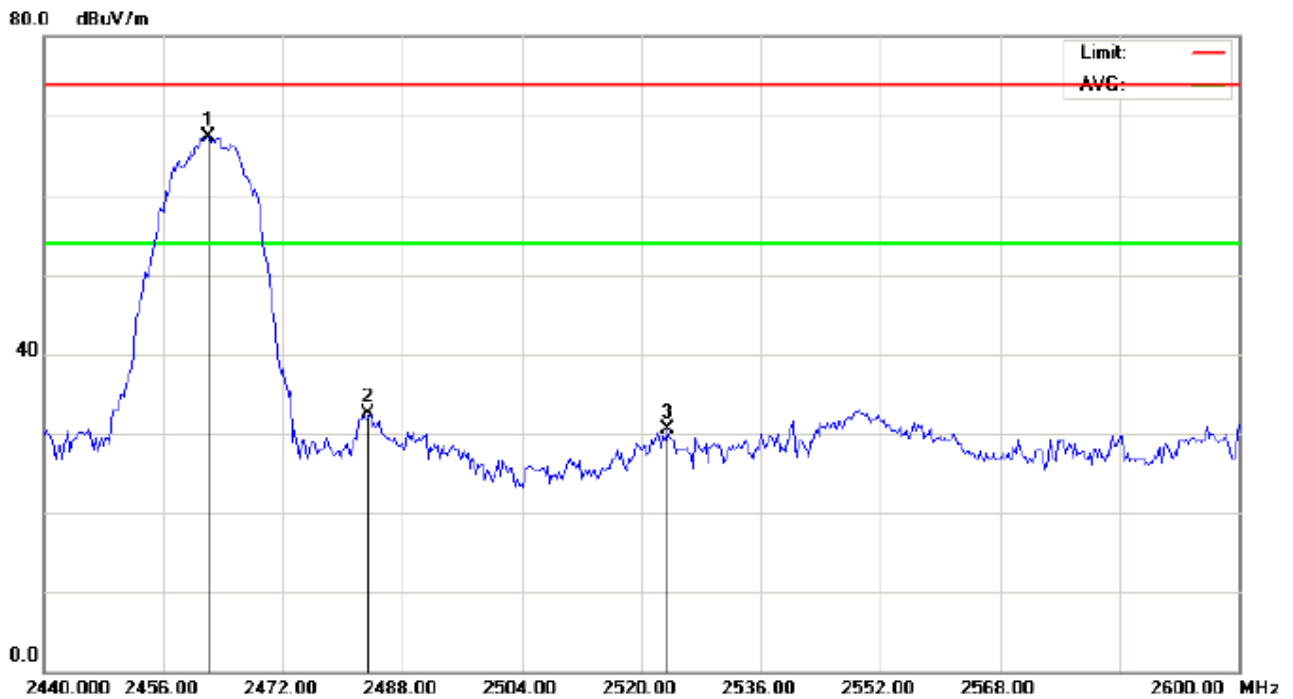

Site: site #1  
 Limit: FCC Class B 3M Radiation above 1GHZ(PK)  
 EUT: HD Sports Video Camera  
 M/N: #1023  
 Mode: 802.11b High channel TX  
 Note:

Polarization: *Horizontal*  
 Power:  
 Distance: 3m

Temperature: 26  
 Humidity: 60 %

No.	Mk	Freq.	Reading	Factor	Measurement	Limit	Over	Detector	Antenna	Table	Comment
		MHz	dBuV	dB/m	dBuV/m	dBuV/m	dB		Height	Degree	
									cm	degree	
1	*	2462.004	67.26	0.00	67.26	74.00	-6.74	peak			
2		2483.502	32.58	0.00	32.58	74.00	-41.42	peak			
3		2523.467	30.42	0.00	30.42	74.00	-43.58	peak			

**RESULT: PASS**

<b>EUT</b>	HD Sports Video Camera/ iON Air Pro 2 WiFi/Air Pro 2 WiFi/Gen 2 with WiFi	<b>Test Model</b>	#1023
<b>Temperature</b>	25°C	<b>Relative Humidity</b>	55.4%
<b>Pressure</b>	960hPa	<b>Test Voltage</b>	Normal Voltage
<b>Test Mode</b>	802.11b with data rate 1 2462MHZ	<b>Antenna</b>	Vertical

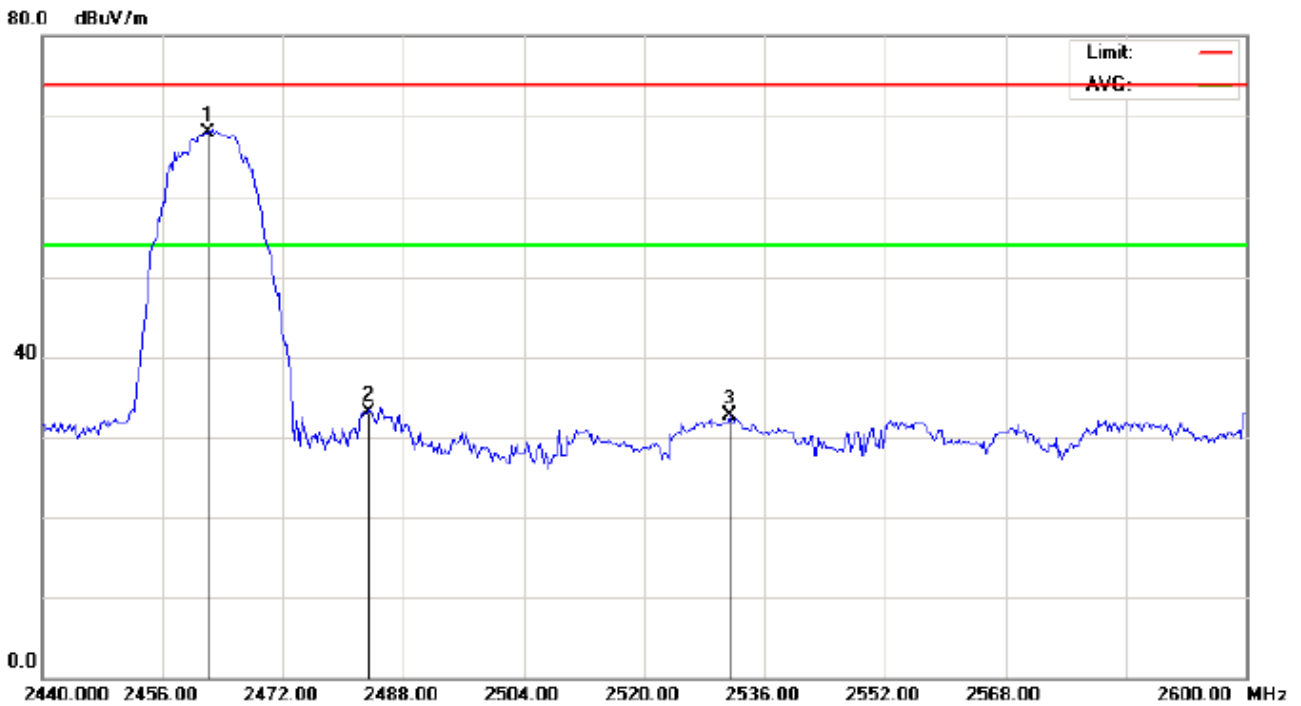

Site: site #1      Polarization: **Vertical**      Temperature: 26  
 Limit: FCC Class B 3M Radiation above 1GHZ(PK)      Power:      Humidity: 60 %  
 EUT: HD Sports Video Camera      Distance: 3m  
 M/N: #1023  
 Mode: 802.11b High channel TX  
 Note:

No.	Mk	Freq.	Reading	Factor	Measurement	Limit	Over	Detector	Antenna Height	Table Degree	Comment
		MHz	dBuV	dB/m	dBuV/m	dBuV/m	dB		cm	degree	
1	*	2462.004	67.99	0.00	67.99	74.00	-6.01	peak			
2		2483.503	33.13	0.00	33.13	74.00	-40.87	peak			
3		2531.467	32.75	0.00	32.75	74.00	-41.25	peak			

**RESULT: PASS**



<b>EUT</b>	HD Sports Video Camera/ iON Air Pro 2 WiFi/Air Pro 2 WiFi/Gen 2 with WiFi	<b>Test Model</b>	#1023
<b>Temperature</b>	25°C	<b>Relative Humidity</b>	55.4%
<b>Pressure</b>	960hPa	<b>Test Voltage</b>	Normal Voltage
<b>Test Mode</b>	802.11n 40 with data rate 13.5 2422MHZ	<b>Antenna</b>	Vertical

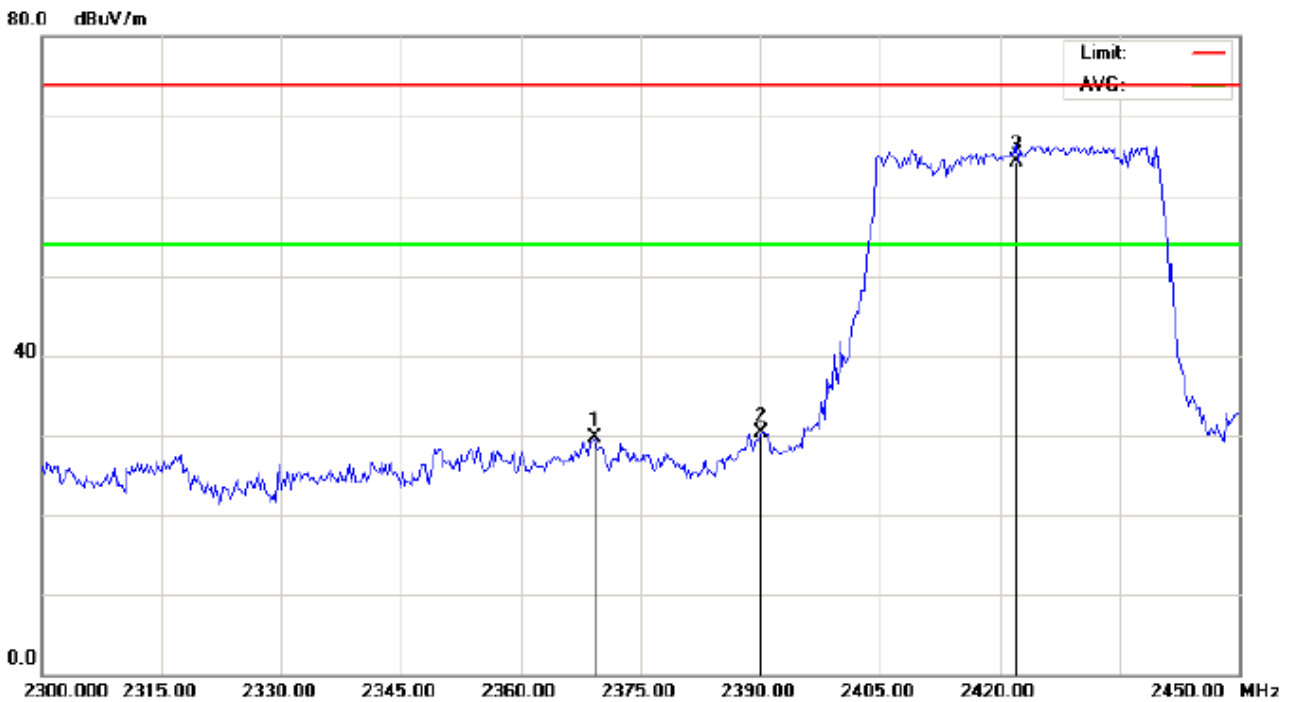

Site: site #1      Polarization: *Vertical*      Temperature: 26  
 Limit: FCC Class B 3M Radiation above 1GHZ(PK)      Power:      Humidity: 60 %  
 EUT: HD Sports Video Camera      Distance: 3m  
 M/N: #1023  
 Mode: 802.11n(40) Low channel TX  
 Note:

No.	Mk	Freq.	Reading	Factor	Measurement	Limit	Over	Detector	Antenna Height	Table Degree	Comment
		MHz	dBuV	dB/m	dBuV/m	dBuV/m	dB		cm	degree	
1		2369.250	29.72	0.00	29.72	74.00	-44.28	peak			
2		2390.006	30.31	0.00	30.31	74.00	-43.69	peak			
3	*	2422.010	64.37	0.00	64.37	74.00	-9.63	peak			

**RESULT: PASS**

<b>EUT</b>	HD Sports Video Camera/ iON Air Pro 2 WiFi/Air Pro 2 WiFi/Gen 2 with WiFi	<b>Test Model</b>	#1023
<b>Temperature</b>	25°C	<b>Relative Humidity</b>	55.4%
<b>Pressure</b>	960hPa	<b>Test Voltage</b>	Normal Voltage
<b>Test Mode</b>	802.11n 40 with data rate 13.5 2452MHZ	<b>Antenna</b>	Horizontal

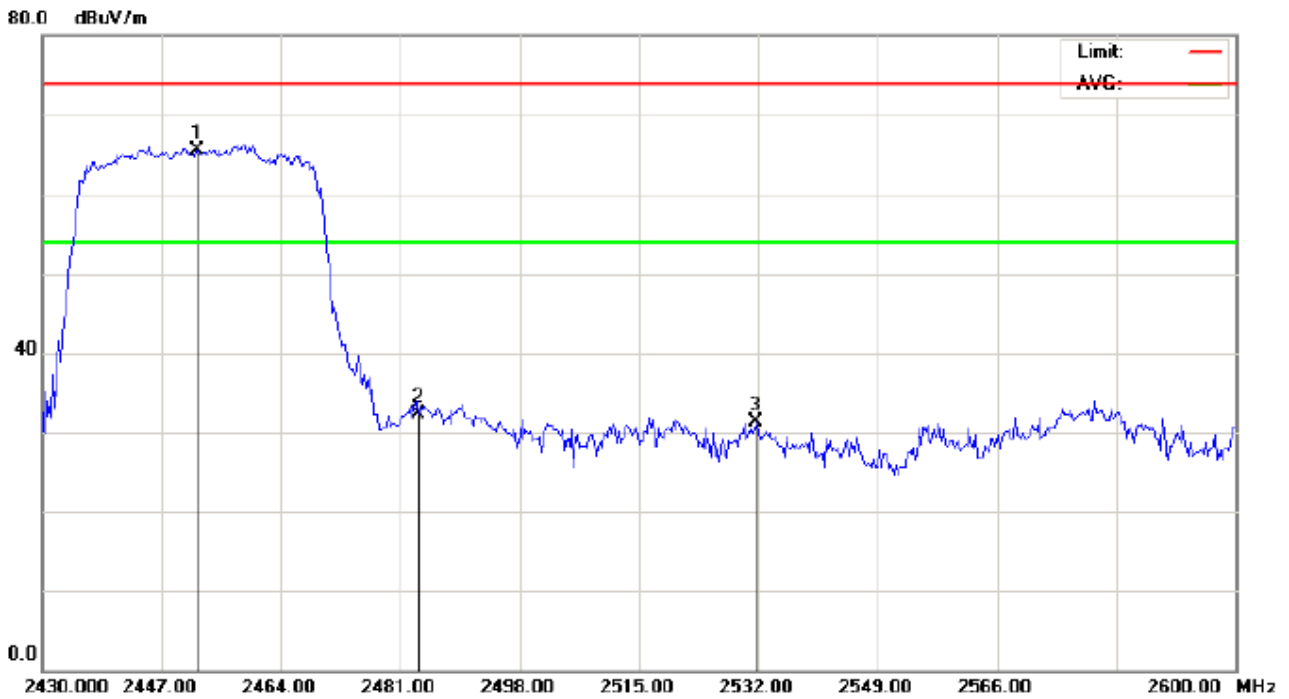

Site: site #1      Polarization: *Horizontal*      Temperature: 26  
 Limit: FCC Class B 3M Radiation above 1GHZ(PK)      Power:      Humidity: 60 %  
 EUT: HD Sports Video Camera      Distance: 3m  
 M/N: #1023  
 Mode: 802.11n(40) High channel TX  
 Note:

No.	Mk	Freq.	Reading	Factor	Measurement	Limit	Over	Detector	Antenna Height	Table Degree	Comment
		MHz	dBuV	dB/m	dBuV/m	dBuV/m	dB		cm	degree	
1	*	2452.004	65.50	0.00	65.50	74.00	-8.50	peak			
2		2483.503	32.23	0.00	32.23	74.00	-41.77	peak			
3		2531.717	31.26	0.00	31.26	74.00	-42.74	peak			

**RESULT: PASS**

<b>EUT</b>	HD Sports Video Camera/ iON Air Pro 2 WiFi/Air Pro 2 WiFi/Gen 2 with WiFi	<b>Test Model</b>	#1023
<b>Temperature</b>	25°C	<b>Relative Humidity</b>	55.4%
<b>Pressure</b>	960hPa	<b>Test Voltage</b>	Normal Voltage
<b>Test Mode</b>	802.11n 40 with data rate 13.5 2452MHZ	<b>Antenna</b>	Vertical



Site: site #1  
 Limit: FCC Class B 3M Radiation above 1GHZ(PK)  
 EUT: HD Sports Video Camera  
 M/N: #1023  
 Mode: 802.11n(40) High channel TX  
 Note:

Polarization: **Vertical**  
 Power:  
 Distance: 3m

Temperature: 26  
 Humidity: 60 %

No.	Mk	Freq.	Reading	Factor	Measurement	Limit	Over	Detector	Antenna Height	Table Degree	Comment
		MHz	dBuV	dB/m	dBuV/m	dBuV/m	dB		cm	degree	
1	*	2452.003	67.20	0.00	67.20	74.00	-6.80	peak			
2		2483.003	35.15	0.00	35.15	74.00	-38.85	peak			
3		2515.850	33.37	0.00	33.37	74.00	-40.63	peak			

**RESULT: PASS**

**Note:** the other modes radiation emission have enough 20dB margin.

Measurement= Reading + Factor, Over=Measure-Limit.

### 13. FCC LINE CONDUCTED EMISSION TEST

#### 13.1. LIMITS OF LINE CONDUCTED EMISSION TEST

Frequency	Maximum RF Line Voltage	
	Q.P.( dBuV)	Average( dBuV)
150kHz~500kHz	66-56	56-46
500kHz~5MHz	56	46
5MHz~30MHz	60	50

Note:

1. The lower limit shall apply at the transition frequency.
2. The limit decreases linearly with the logarithm of the frequency in the range 0.15 MHz to 0.50 MHz.

#### 13.2. BLOCK DIAGRAM OF LINE CONDUCTED EMISSION TEST

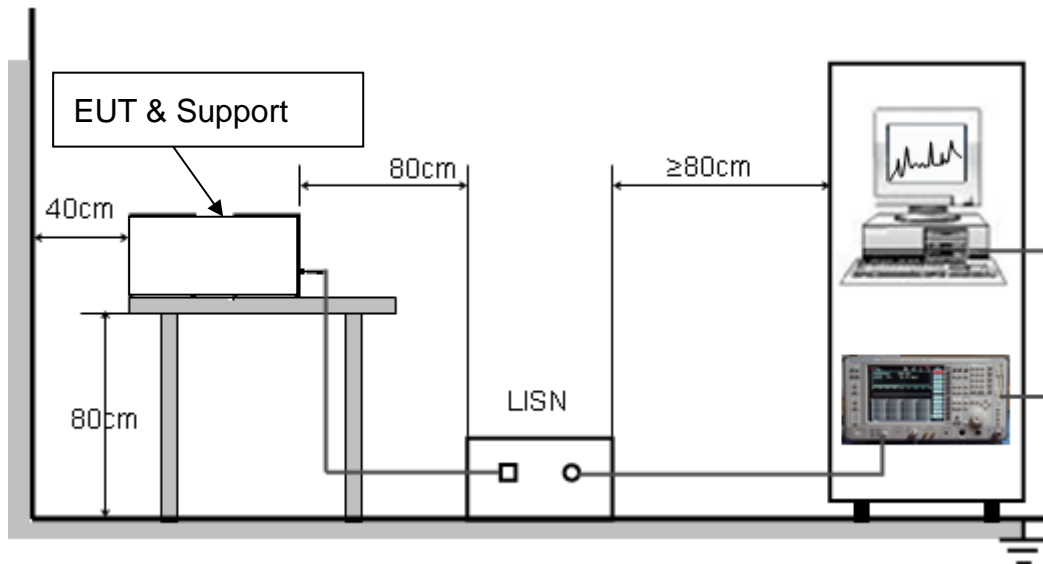



### **13.3. PRELIMINARY PROCEDURE OF LINE CONDUCTED EMISSION TEST**

1. The equipment was set up as per the test configuration to simulate typical actual usage per the user's manual. When the EUT is a tabletop system, a wooden table with a height of 0.8 meters is used and is placed on the ground plane as per ANSI C63.4 (see Test Facility for the dimensions of the ground plane used). When the EUT is a floor-standing equipment, it is placed on the ground plane which has a 3-12 mm non-conductive covering to insulate the EUT from the ground plane.
2. Support equipment, if needed, was placed as per ANSI C63.4.
3. All I/O cables were positioned to simulate typical actual usage as per ANSI C63.4.
4. All support equipments received AC120V/60Hz power from a LISN, if any.
5. The EUT received DC5V charging voltage by adapter which received 120V/60Hz power by a LISN..
6. The test program was started. Emissions were measured on each current carrying line of the EUT using a spectrum Analyzer / Receiver connected to the LISN powering the EUT. The LISN has two monitoring points: Line 1 (Hot Side) and Line 2 (Neutral Side). Two scans were taken: one with Line 1 connected to Analyzer / Receiver and Line 2 connected to a 50 ohm load; the second scan had Line 1 connected to a 50 ohm load and Line 2 connected to the Analyzer / Receiver.
7. Analyzer / Receiver scanned from 150 kHz to 30MHz for emissions in each of the test modes.
8. During the above scans, the emissions were maximized by cable manipulation.
9. The test mode(s) were scanned during the preliminary test.

Then, the EUT configuration and cable configuration of the above highest emission level were recorded for reference of final testing.

### **13.4. FINAL PROCEDURE OF LINE CONDUCTED EMISSION TEST**

1. EUT and support equipment was set up on the test bench as per step 2 of the preliminary test.
2. A scan was taken on both power lines, Line 1 and Line 2, recording at least the six highest emissions. Emission frequency and amplitude were recorded into a computer in which correction factors were used to calculate the emission level and compare reading to the applicable limit. If EUT emission level was less -2dB to the A.V. limit in Peak mode, then the emission signal was re-checked using Q.P and Average detector.
3. The test data of the worst case condition(s) was reported on the Summary Data page.

### **13.5. TEST RESULT OF LINE CONDUCTED EMISSION TEST**

N/A

Note : According to FCC Part 15 Rules 15.207, the Conducted Emission test is not applicable, so do not need to test.

**APPENDIX A: PHOTOGRAPHS OF TEST SETUP**  
FCC RADIATED EMISSION TEST SETUP

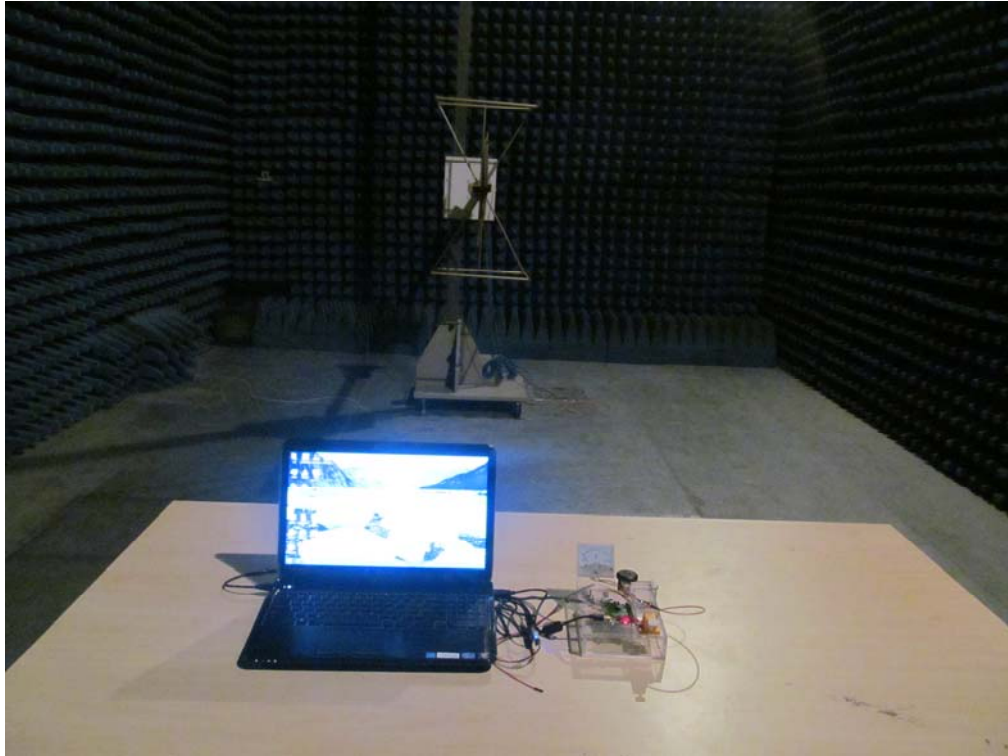

**APPENDIX B: PHOTOGRAPHS OF EUT**  
TOTAL VIEW OF EUT



TOP VIEW OF EUT



BOTTOM VIEW OF EUT



FRONT VIEW OF EUT



BACK VIEW OF EUT



LEFT VIEW OF EUT



RIGHT VIEW OF EUT



OPEN VIEW OF EUT-1



OPEN VIEW OF EUT-2



OPEN VIEW OF EUT-3



INTERNAL VIEW OF EUT-1

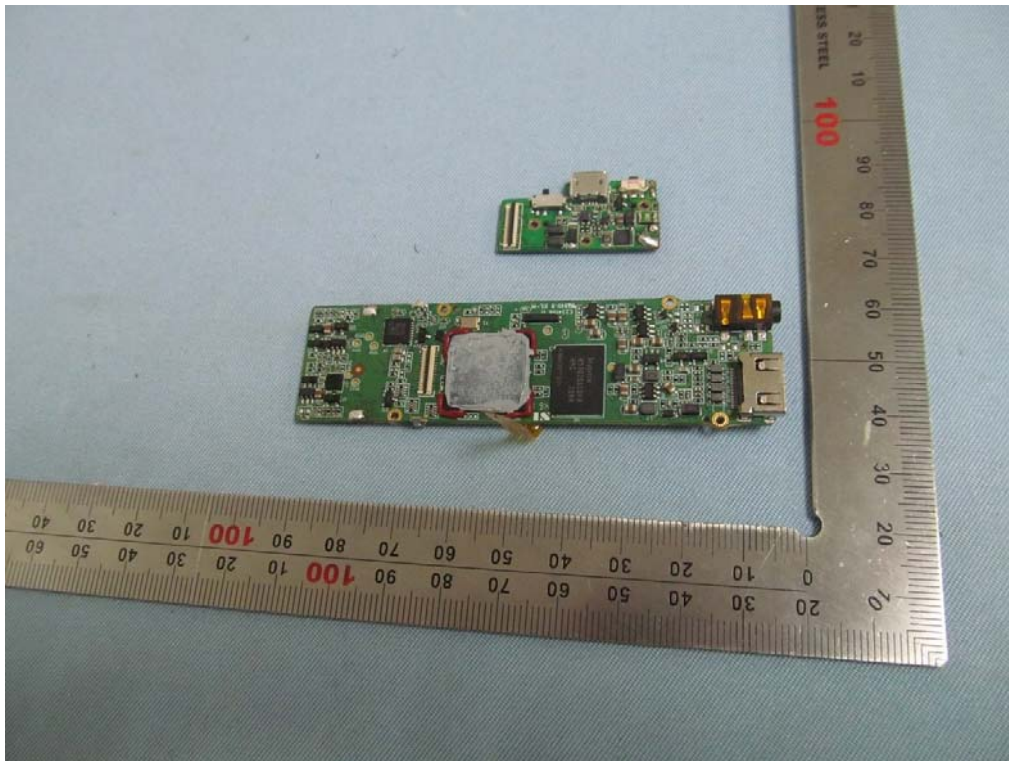

INTERNAL VIEW OF EUT-2

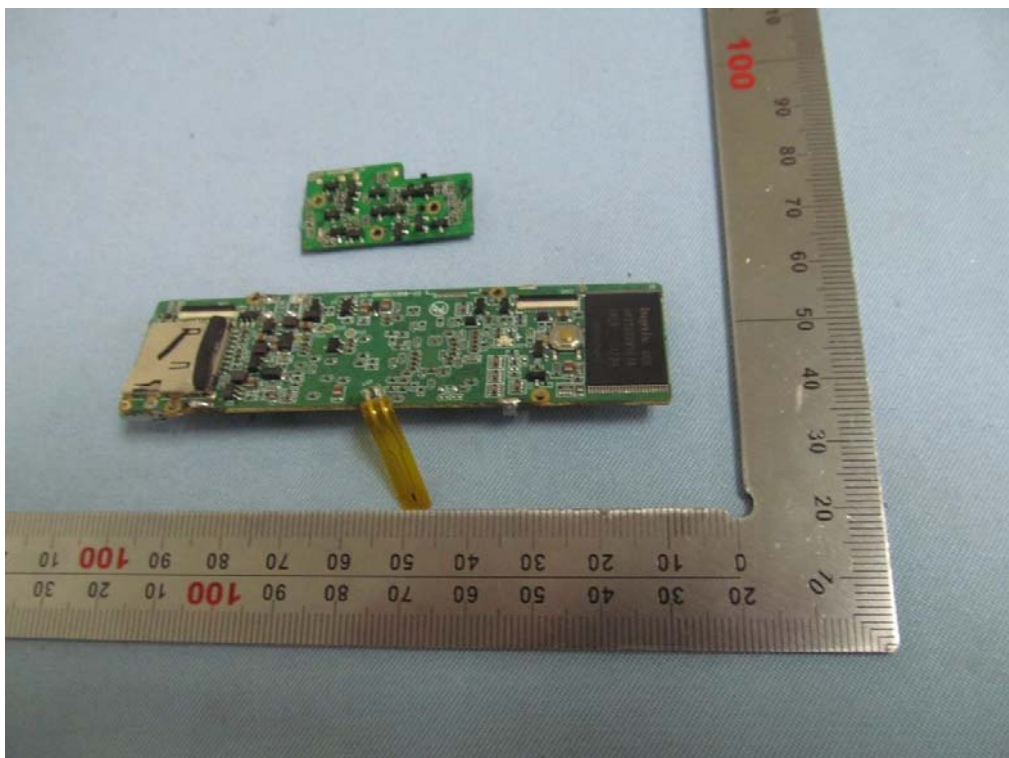



INTERNAL VIEW OF EUT-3

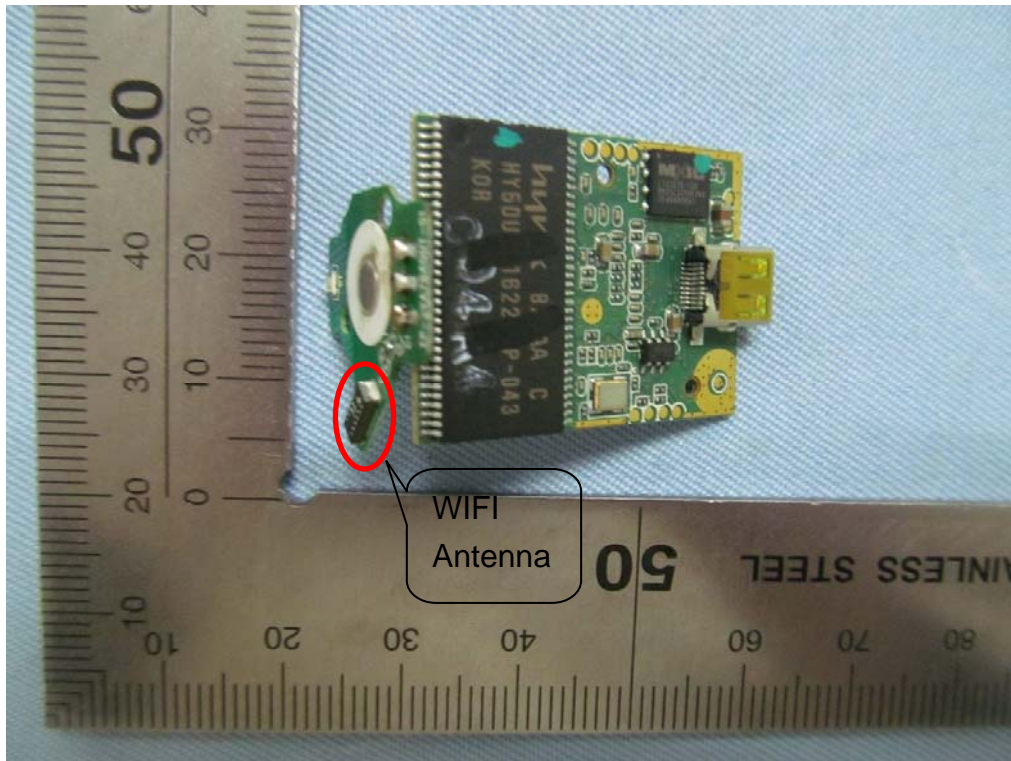

INTERNAL VIEW OF EUT-4

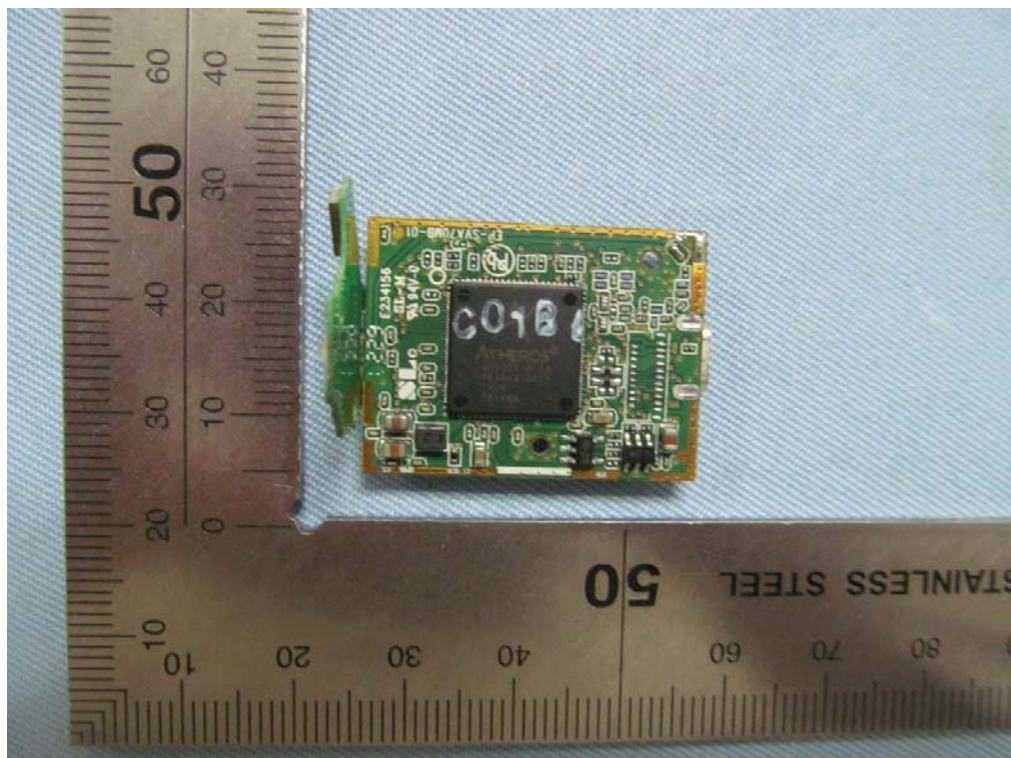

----END OF REPORT----