

**COMPLIANCE WORLDWIDE INC.
TEST REPORT 143-16R3**

In Accordance with the Requirements of
**FCC PART 90:2015 Subpart S
Operation in the 806 to 816 MHz and 851 to 861 MHz bands
and PART 20:2015**

Issued to

**Westell, Inc.
670 North Commercial Street
Manchester, NH 03101
(603) 626-6677**

for

**NFPA 72 Public Safety Signal Booster
Model: PS51080**

FCC ID: NVRCSIPS51080PS78

**Original Report Issued on April 12, 2016
Revision R3 Issued on July 24, 2016**

Tested by

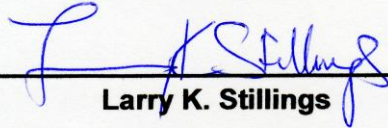

Larry K. Stillings

Reviewed By



Brian F. Breault

This test report shall not be reproduced, except in full, without written permission from Compliance Worldwide, Inc.

Table of Contents

1. Scope	3
2. Product Details	3
2.1. Manufacturer	3
2.2. Model Number	3
2.3. Serial Number	3
2.4. Description	3
2.5. Power Source	3
2.6. Software Version	3
2.7. EMC Modifications	3
3. Product Configuration	4
3.1. Support Equipment	4
3.2. Cables	4
3.3. Operational Characteristics & Software	5
3.4. Block Diagram	5
4. Measurement Parameters	6
4.1. Measurement Equipment Used to Perform Test	6
4.2. Measurement & Equipment Setup	6
4.3. Test Procedure	6
5. Measurement Summary	7
6. Measurement Data	8
6.1. Broadband Transmitting Power Limits 90.635	8
6.2. Bandwidth Limitations (FCC Part 2.1049) and Emission Mask 90.210	34
6.3. Spurious Emissions at the Antenna Terminals 90.669	72
6.4. Field Strength of Spurious Emissions 90.669	85
6.5. Frequency Stability 90.539	89
6.6. Out of Band Rejection	90
6.7. Noise Figure	92
6.8. Public Exposure to Radio Frequency Energy Levels 1.1307 (b)(1)	94
7. Test Site Description	95
8. Test Setup Photographs	96
Appendix A	98

1. Scope

This test report certifies that the Westell Public Safety Repeater Model PS51080, as tested, meets the FCC Part 90 Subpart S requirements. The scope of this test report is limited to the test sample provided by the client, only in as much as that sample represents other production units. If any significant changes are made to the unit, the changes shall be evaluated and a retest may be required. Revision R1 adds noise figure measurements of the uplink and downlink bands in new section 6.7 and 90.210 (h) Emission Mask H to new section 6.8 of the test report. Revision R2 updates the report for narrowband operation in the 806 to 813.5 MHz and 851 to 858.5 MHz bands. Revision R3 removes all test data using CDMA 1.25 MHz signal and replaces that data with CW, 6.25, 12.5 and 25 kHz FM, CPAO P25 Phase 1 (C4FM) and Phase 2 ($\pi/4$ -DQPSK) modulated signals.

2. Product Details

2.1. Manufacturer: Westell, Inc.

2.2. Model Numbers: PS51080

2.3. Serial Number: 15100001 (Radiated Emissions), 16030031

2.4. Description: The PS51080 repeater was developed for use in enclosed structures where signals from local public safety towers to operate mobile units is poor or unavailable. Adequate signal strength must be available outside the structure as a prerequisite to achieving in-building coverage. The device is connected to an external antenna, normally located on a roof, and to one or more internal antennas placed strategically throughout the area where wireless service is desired. The PS51080 supports uplink bands of 788-805/806-809 or 806-816 MHz and downlink bands of 758-775/851-854 or 851-861 MHz.

2.5. Power Source: 120 VAC, 60 Hz

2.6. Software Version: 1.9

2.7. EMC Modifications: None

3. Product Configuration

3.1. Support Equipment

Device	Manufacturer	Model	Serial No.	Comment
Power Supply	APX Technologies	SP130P966ER	n/a	
Notebook PC	Dell	Latitude C400	9760689253	Configuring Unit

3.2. Cables

Cable Type	Length	Shield	From	To
RF, 50 Ω , N male – N male	1M	Yes	EUT	Signal Generator
RF, 50 Ω , N male – N male	1M	Yes	EUT	50 Ω Load
Power Supply	2M + 2M	Yes	EUT	120 VAC, 60 Hz
Ethernet	2M	No	EUT	Notebook PC
DB-9 Alarm Relays	2M	Yes	EUT	Un-terminated

Notebook PC is connected only during setup and configuration

3.3. Operational Characteristics & Software

- (1) The unit was allowed to power up normally and go through its configuration cycle.
- (2) Using an RF Signal Generator on the Input and a Spectrum Analyzer on the output Downlink or Uplink frequencies a signal was generated over the intended bandwidth of operation.
- (3) The signal generator was configured to provide CW, 6.25, 12.5 and 25 kHz FM modulated, CPAO P25 Phase 1 and Phase 2 signals to the input of the amplifier across the public safety bands to be used by the product.
- (4) The units internal AGC threshold was determined by applying an input signal until a 1 dB increase in input signal did not cause a 1 dB in output signal for each of the Uplink and Downlink frequencies.

3. Product Configuration (continued)

3.3. Operational Characteristics & Software

Emission Designator	Modulation	Occupied Bandwidth	Channel Bandwidth	Audio Frequency
16K0F3E	FM	16 kHz	25 kHz	1 kHz
11K3F3E	FM	11.3 kHz	12.5 kHz	1 kHz
4K05F1E	FM	4 kHz	6.25 kHz	1 kHz
N/A	CW	N/A	N/A	N/A
8K12F1D	C4FM	8.09 kHz	12.5 kHz	N/A
9K80G1D	$\pi/4$ -DQPSK	9.8 kHz	12.5 kHz	N/A

3.4. Block Diagram

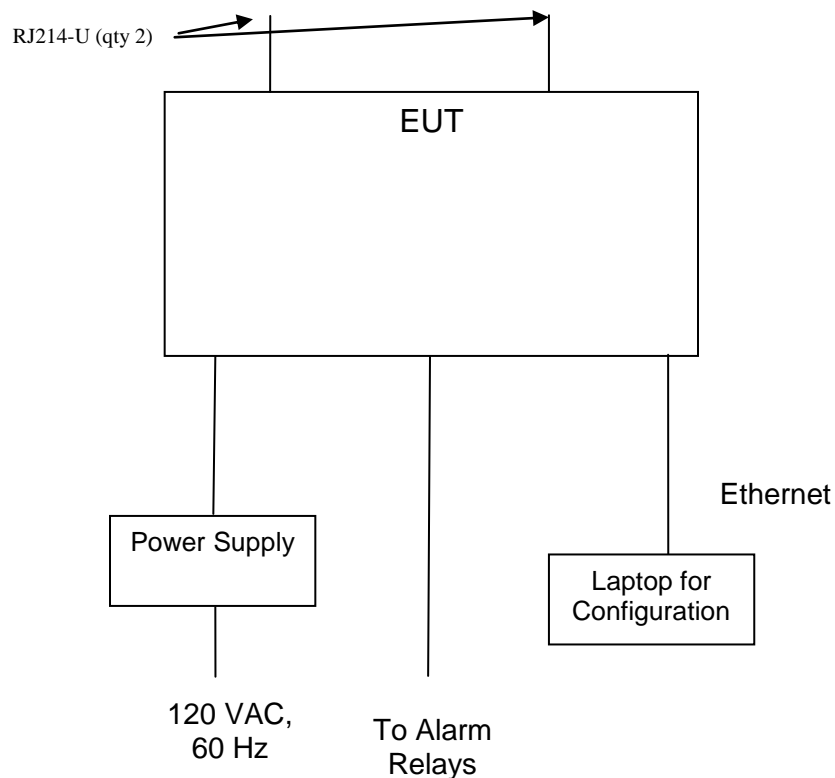

4. Measurements Parameters

4.1. Measurement Equipment Used to Perform Test

Device	Manufacturer	Model No.	Serial No.	Cal Due	Interval
EMI Test Receiver, 9kHz - 7GHz ¹	Rohde & Schwarz	ESR7	101156	7/23/2017	2 Years
Spectrum Analyzer 20 Hz – 40 GHz ²	Rohde & Schwarz	FSV40	100899	7/23/2017	2 Years
Spectrum Analyzer, 9 kHz to 40 GHz ³	Rohde & Schwarz	FSVR40	100909	7/23/2017	2 Years
EMI Receiver, 9 kHz to 6.5 GHz	Hewlett Packard	8546A	3650A00360	6/4/2016	2 Years
Biconilog Antenna, 30 MHz to 2 GHz	Sunol Sciences Corp	JB1	A050913	5/15/2016	3 Years
Horn Antenna, 960 MHz – 18 GHz	Electro-Metrics	RGA-50 / 60	2813	7/15/2016	2 Years
Preamplifier, 1 GHz to 26.5 GHz	Hewlett Packard	8449B	3008A01323	7/21/2017	2 Years
RF Signal Generator 5kHz to 6 GHz	Rohde & Schwarz	SMIQ06B	10090	7/23/2017	2 Years
Noise Source 10 MHz to 6 GHz	Micronetics	NS346B	17883	10/15/2016	1 Year
Digital Barometer	Control Company	4195	ID236	10/8/2017	2 Years

¹ ESR7 Firmware revision: V2.26, Date installed: 8/15/2014 Previous V2.17, installed 6/11/2014.
² FSV40 Firmware revision: V2.30 SP1 Date installed: 10/22/2014 Previous V2.30, installed 7/23/2014.
³ FSVR40 Firmware revision: V2.23, Date installed: 10/20/2014 Previous V1.63 SP1, installed 8/28/2013.

4.2. Measurement & Equipment Setup

Test Dates: 1/20/2016, 1/25/2016,
2/1/2016, 2/6/2016,
5/12/2016, 6/24/2016
7/20 to 7/24 2016

Test Engineer: Larry Stillings

Normal Site Temperature (15 – 35°C): 24

Relative Humidity (20 -75%RH): 33

4.3. Test Procedure

The test measurements contained in this report are based on the requirements detailed in FCC Part 90 and Subpart S.

The test methods used to generate the data in this test report are in accordance with ANSI C63.4:2014, American National Standard for Methods of Measurement of Radio-Noise Emissions from Low-Voltage Electrical and Electronic Equipment in the Range of 9 kHz to 40 GHz, FCC OET KDB 935210 D05 Indus Booster Basic Meas v01 dated 2-12-2016, Measurements Guidance for Industrial and Non-Consumer Signal Booster, Repeater and Amplifier Devices and FCC OET KDB 971168 D01 Power Meas License Digital Systems v02r02 dated 10-17-2014.

Measurements were also made in accordance with TIA-603-C:2004 Land Mobile FM or PM Communications Equipment Measurement and Performance Standard.

5. Measurement Summary

Section Description or Test Requirement	FCC Part 90 Reference	Test Report Section	Result	Comment
Limitations on power and antenna height	90.219(e)(1) 90.635	6.1	Compliant	
Occupied Bandwidth and Emission Mask	90.219(e)(4)(ii) Part 2.1049 90.210	6.2	Compliant	
Spurious Emissions at Antenna Terminals	90.219(e)(3) 90.543	6.3	Compliant	
Field Strength of Spurious Emissions	90.219(e)(3) 90.543	6.4	Compliant	
Frequency Stability	90.213	6.5	N/A	The EUT does not translate the frequency of the input signal
Out of Band Rejection	N/A	6.6	Compliant	
Noise Figure	90.219(e)(2)	6.7	Compliant	
Public Exposure to Radio Frequency Energy Levels	Section 1.1307 (b)(1)	6.8	Compliant	

6. Measurement Data

6.1. Limitations on power and antenna height 90.219(e)(1), 90.635

Requirement: The transmitter output power of mobile and control transmitters operating in the 806 to 824 MHz, 851 to 869 MHz, 896 to 901 MHz and 935 to 940 MHz bands must not exceed 1 kilowatt (30 dBw) and 304 meters (1,000 ft) above average terrain.

The output power capability of a signal booster must be designed for deployments providing a radiated power not exceeding 5 Watts ERP for each retransmitted channel.

Measurement of AGC Threshold

Test Method: KDB 935210 Section 4.2 & KDB 971168 Section 5.2

6.1.1. Mean Transmitter Output Power, Transmitter Only

Modulation Type	Center Frequency	Output Power		Input Power (dBm)	Result
	(MHz)	(dBm)	(Watts)		
FM Modulation	806	27.46	0.557	-52.04	Compliant
FM Modulation	811	26.94	0.494	-52.04	Compliant
FM Modulation	816	24.98	0.315	-52.03	Compliant
CW	806	27.48	0.560	-52.02	Compliant
CW	811	26.96	0.497	-52.01	Compliant
CW	816	24.99	0.316	-52.01	Compliant
C4FM Modulation	806	27.56	0.570	-51.99	Compliant
C4FM Modulation	811	27.04	0.506	-51.92	Compliant
C4FM Modulation	816	25.07	0.321	-51.92	Compliant
$\pi/4$ -DQPSK Modulation	806	27.44	0.555	-52.08	Compliant
$\pi/4$ -DQPSK Modulation	811	27.11	0.514	-52.25	Compliant
$\pi/4$ -DQPSK Modulation	816	25.10	0.324	-52.24	Compliant
FM Modulation	851	26.62	0.459	-52.61	Compliant
FM Modulation	856	27.33	0.541	-52.61	Compliant
FM Modulation	861	27.25	0.531	-52.60	Compliant
CW	851	26.86	0.485	-52.00	Compliant
CW	856	27.45	0.556	-52.00	Compliant
CW	861	27.48	0.560	-51.98	Compliant
C4FM Modulation	851	26.61	0.458	-52.57	Compliant
C4FM Modulation	856	27.30	0.537	-52.56	Compliant
C4FM Modulation	861	27.24	0.530	-52.57	Compliant
$\pi/4$ -DQPSK Modulation	851	26.28	0.425	-53.45	Compliant
$\pi/4$ -DQPSK Modulation	856	27.01	0.502	-52.91	Compliant
$\pi/4$ -DQPSK Modulation	861	26.91	0.491	-52.82	Compliant

Note: Input Power is at the 1 dB AGC threshold Level

6. Measurement Data

6.1. Limitations on power and antenna height 90.219(e)(1), 90.635 (cont)

6.1.2. Mean Transmitter Output Power, 806 MHz, FM Modulation

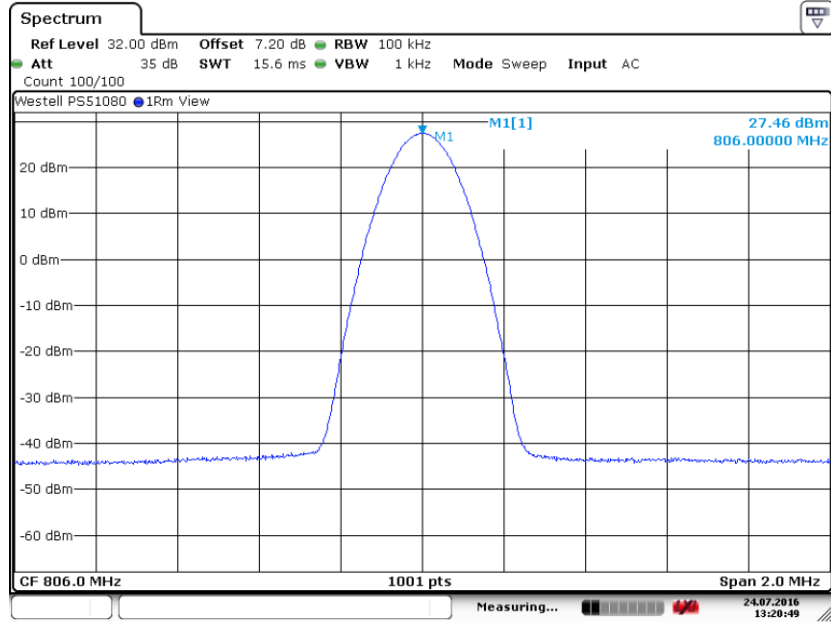

Date: 24.JUL.2016 13:20:48

6.1.3. Mean Transmitter Input Power, 806 MHz, FM Modulation

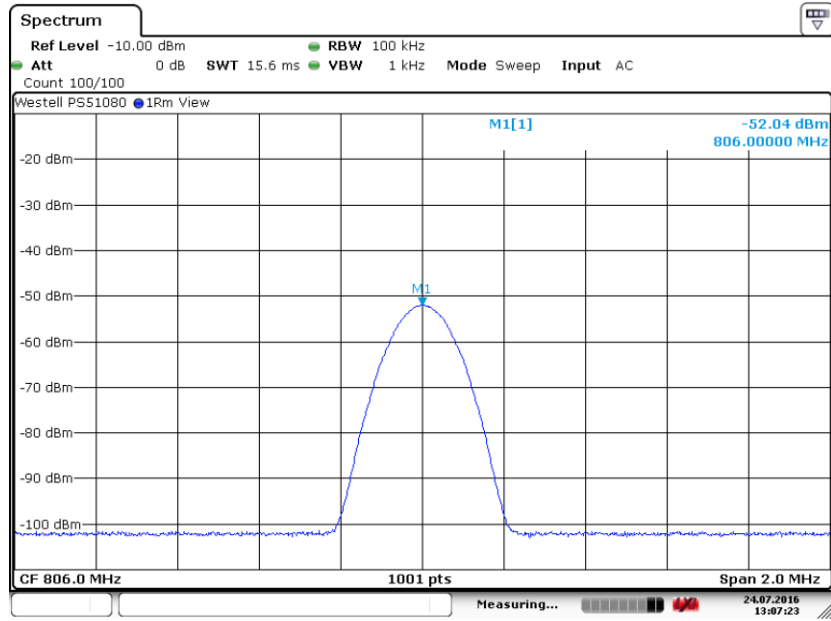

Date: 24.JUL.2016 13:07:22

6. Measurement Data

6.1. Limitations on power and antenna height 90.219(e)(1), 90.635 (cont)

6.1.4. Mean Transmitter Output Power, 811 MHz, FM Modulation

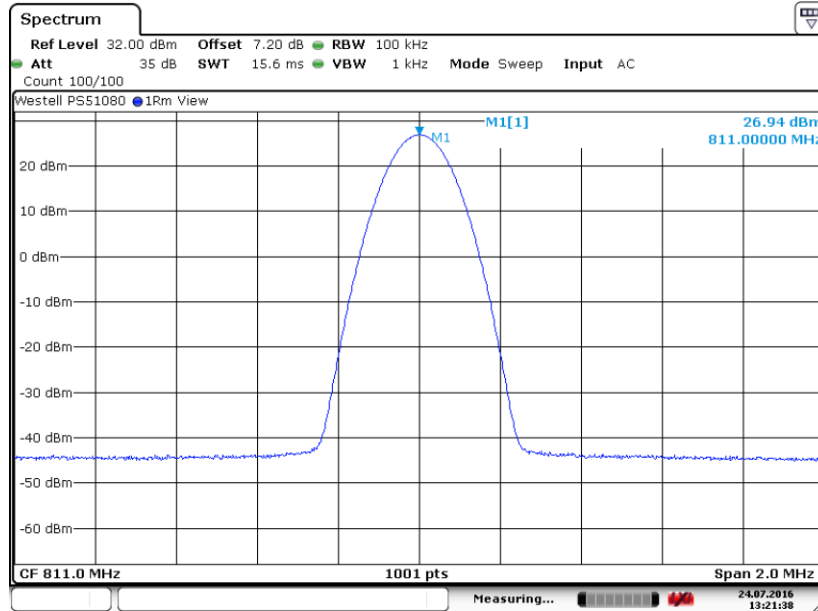

6.1.5. Mean Transmitter Input Power, 811 MHz, FM Modulation

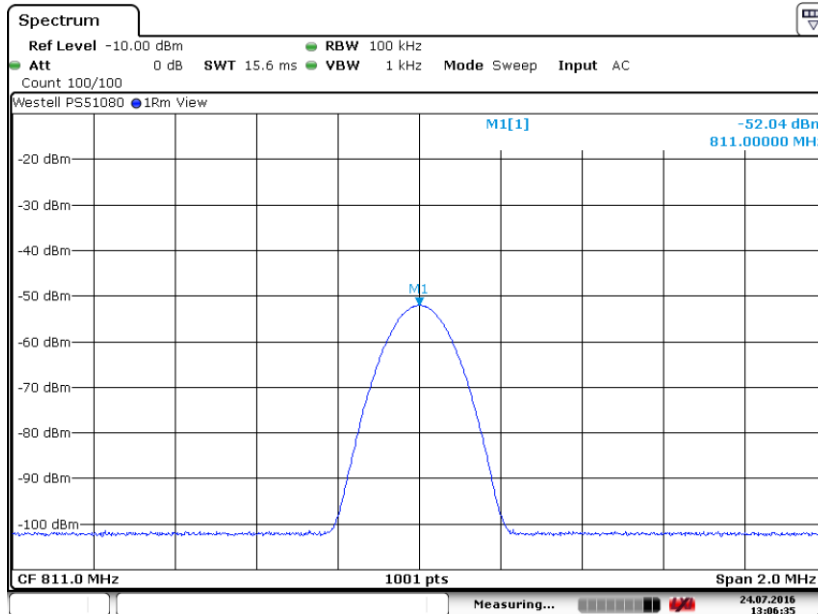

6. Measurement Data

6.1. Limitations on power and antenna height 90.219(e)(1), 90.635 (cont)

6.1.6. Mean Transmitter Output Power, 816 MHz, FM Modulation

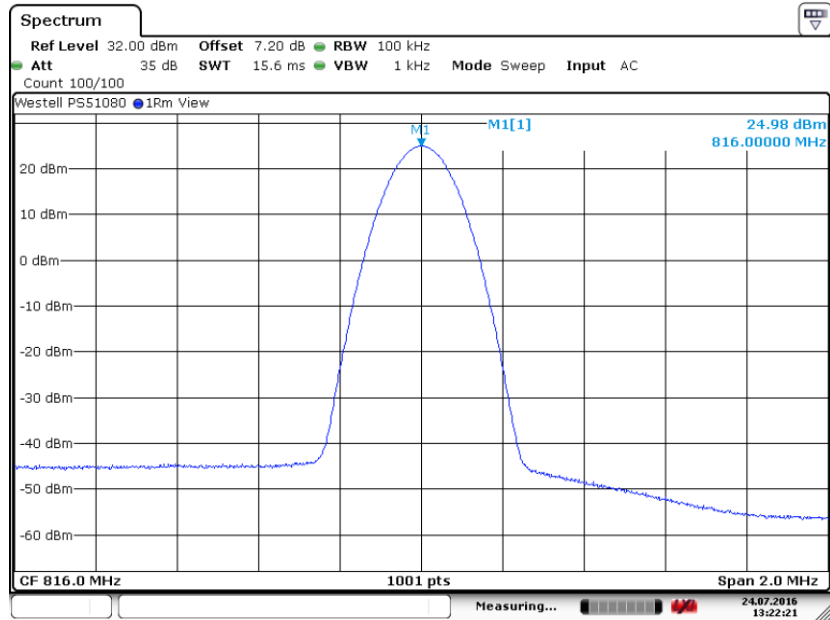

Date: 24.JUL.2016 13:22:21

6.1.7. Mean Transmitter Input Power, 816 MHz, FM Modulation

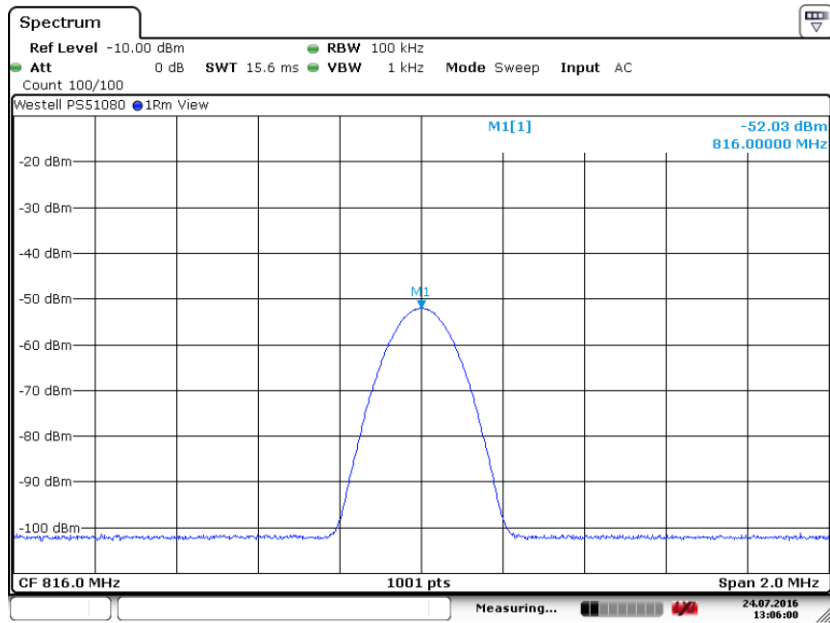

Date: 24.JUL.2016 13:06:00

6. Measurement Data

6.1. Limitations on power and antenna height 90.219(e)(1), 90.635 (cont)

6.1.8. Mean Transmitter Output Power, 806 MHz, CW Signal

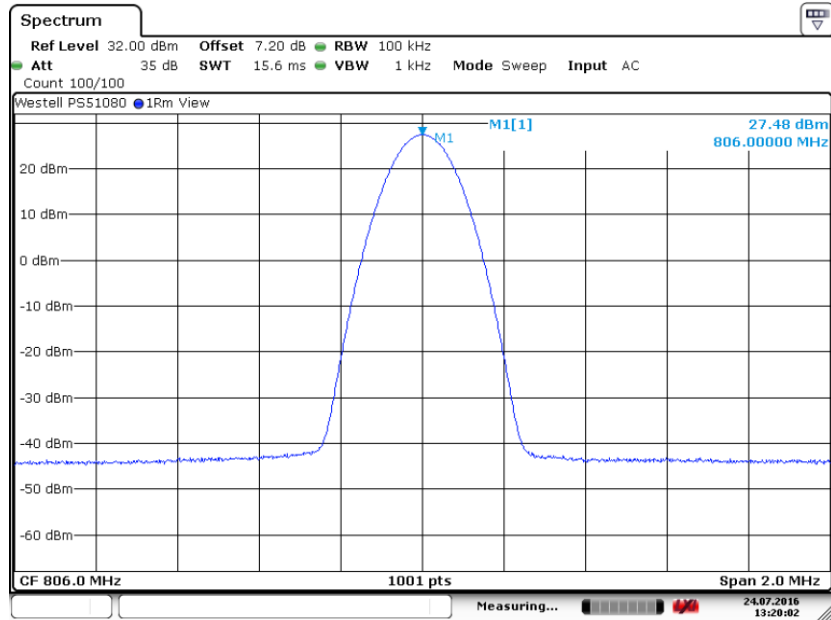

Date: 24.JUL.2016 13:20:01

6.1.9. Mean Transmitter Input Power, 806 MHz, CW Signal

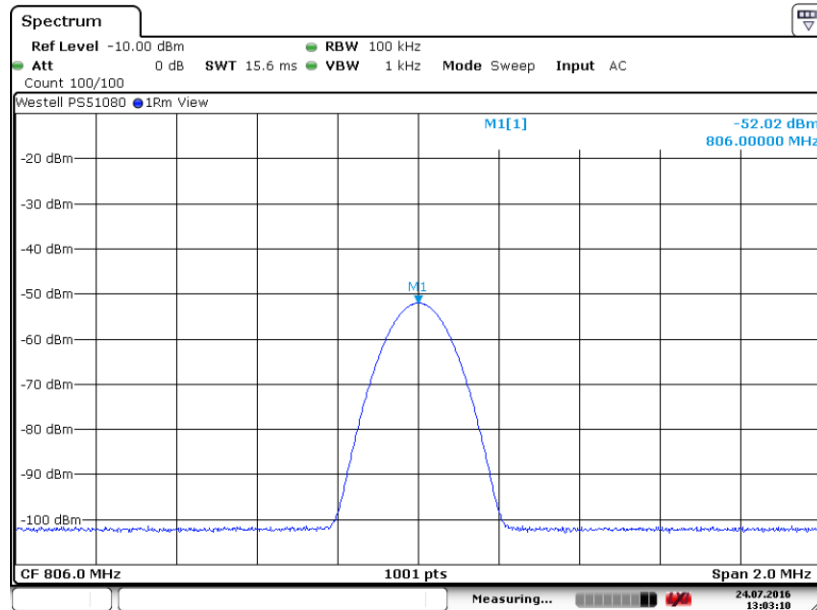

Date: 24.JUL.2016 13:03:09

6. Measurement Data

6.1. Limitations on power and antenna height 90.219(e)(1), 90.635 (cont)

6.1.10. Mean Transmitter Output Power, 811 MHz, CW Signal

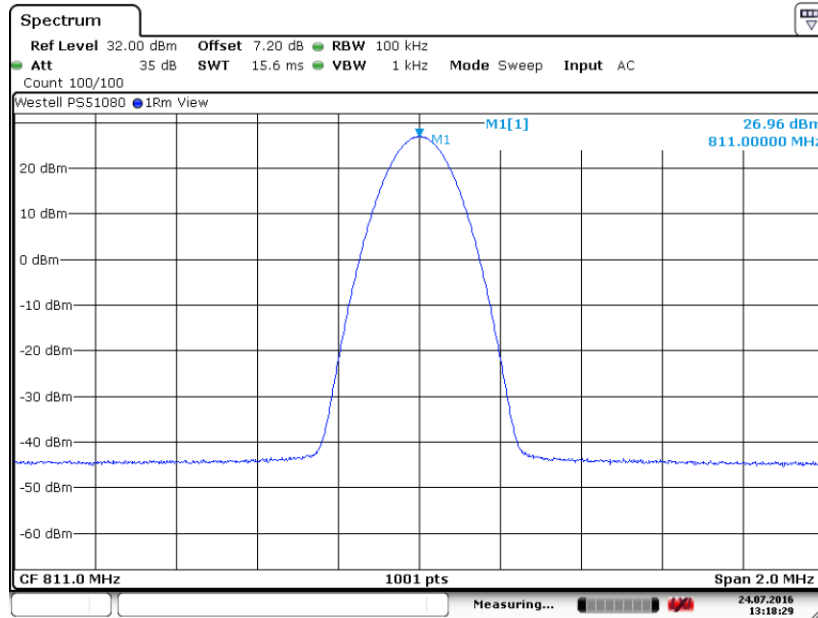

Date: 24.JUL.2016 13:18:29

6.1.11. Mean Transmitter Input Power, 811 MHz, CW Signal

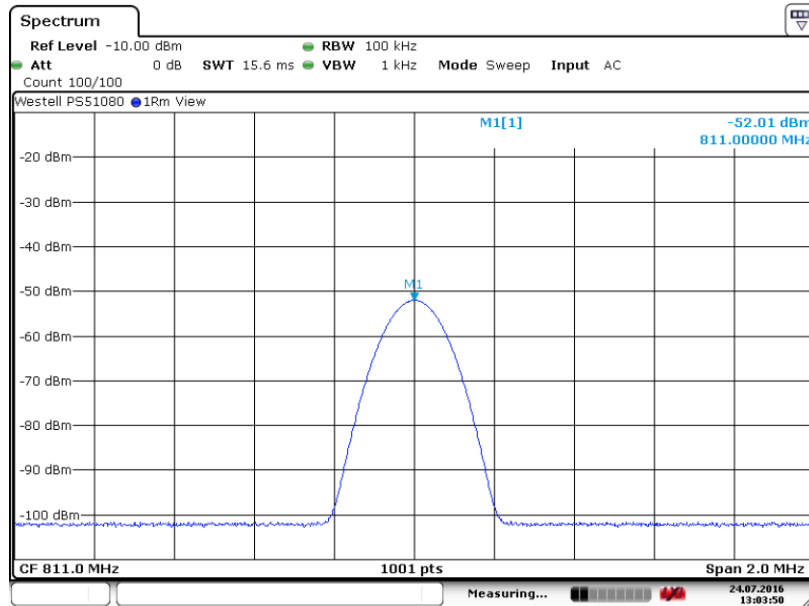

Date: 24.JUL.2016 13:03:50

6. Measurement Data

6.1. Limitations on power and antenna height 90.219(e)(1), 90.635 (cont)

6.1.12. Mean Transmitter Output Power, 816 MHz, CW Signal

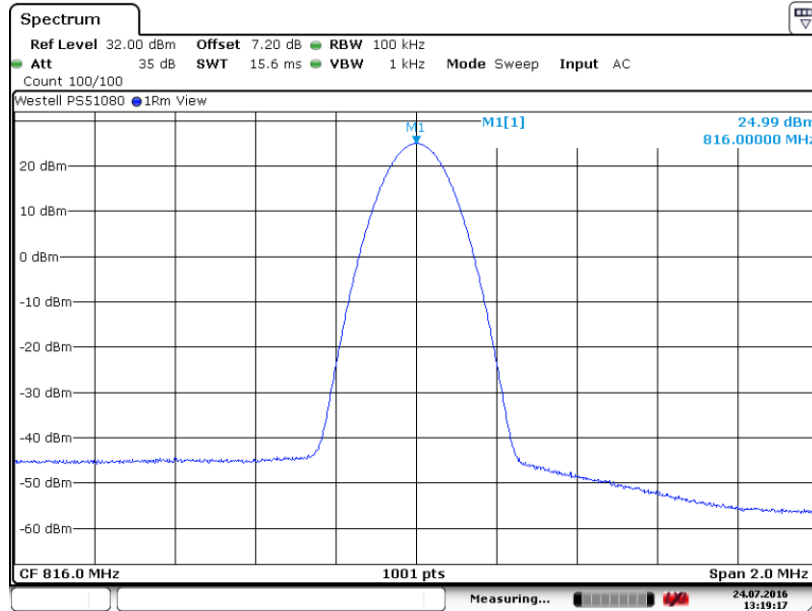

Date: 24.JUL.2016 13:19:16

6.1.13. Mean Transmitter Input Power, 816 MHz, CW Signal

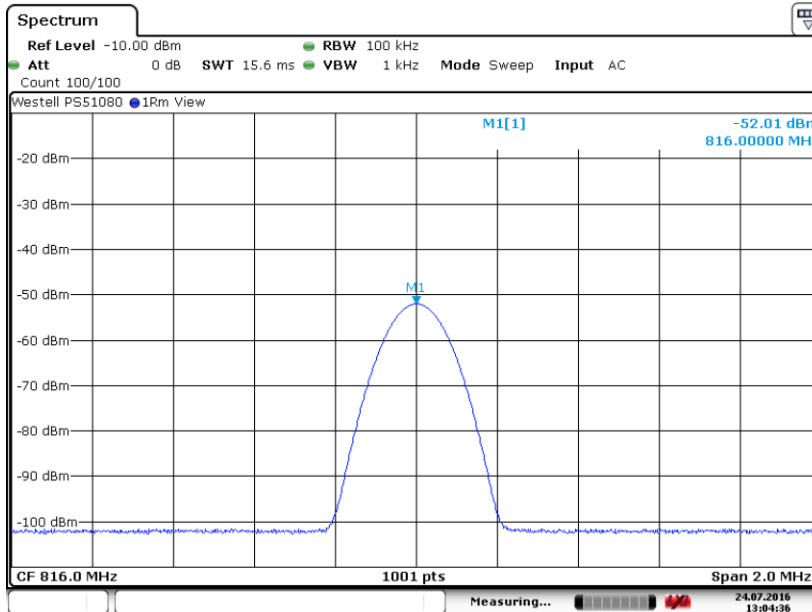

Date: 24.JUL.2016 13:04:35

6. Measurement Data

6.1. Limitations on power and antenna height 90.219(e)(1), 90.635 (cont)

6.1.14. Mean Transmitter Output Power, 806 MHz, C4FM Modulation

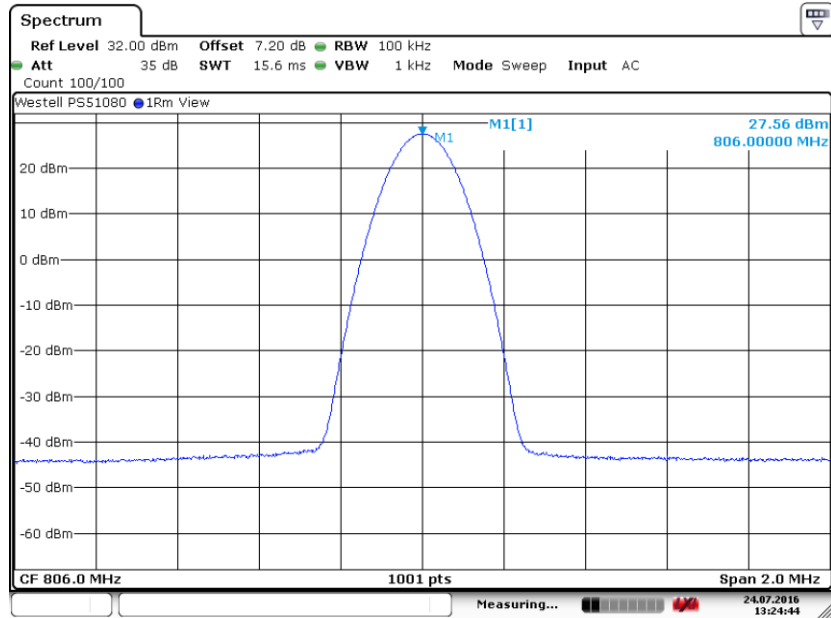

Date: 24.JUL.2016 13:24:43

6.1.15. Mean Transmitter Input Power, 806 MHz, C4FM Modulation

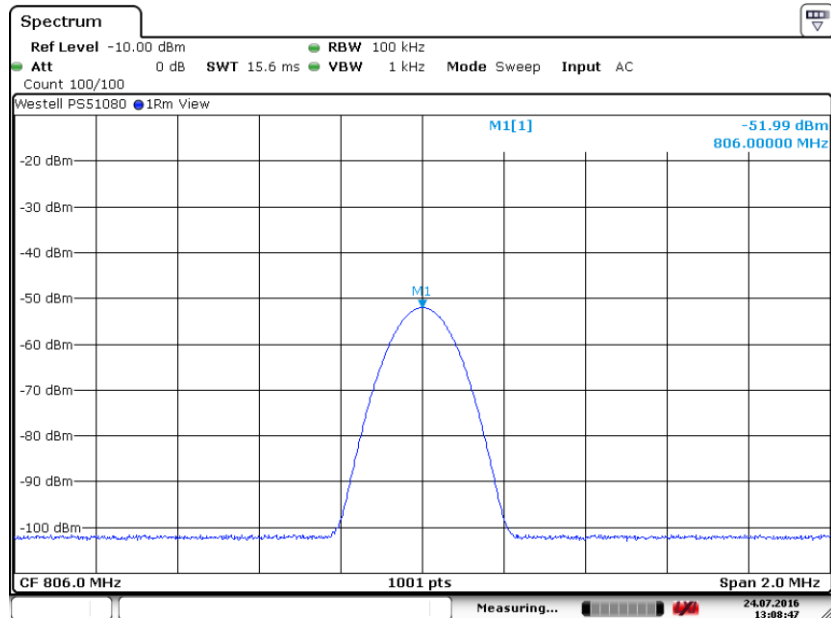

Date: 24.JUL.2016 13:08:46

6. Measurement Data

6.1. Limitations on power and antenna height 90.219(e)(1), 90.635 (cont)

6.1.16. Mean Transmitter Output Power, 811 MHz, C4FM Modulation

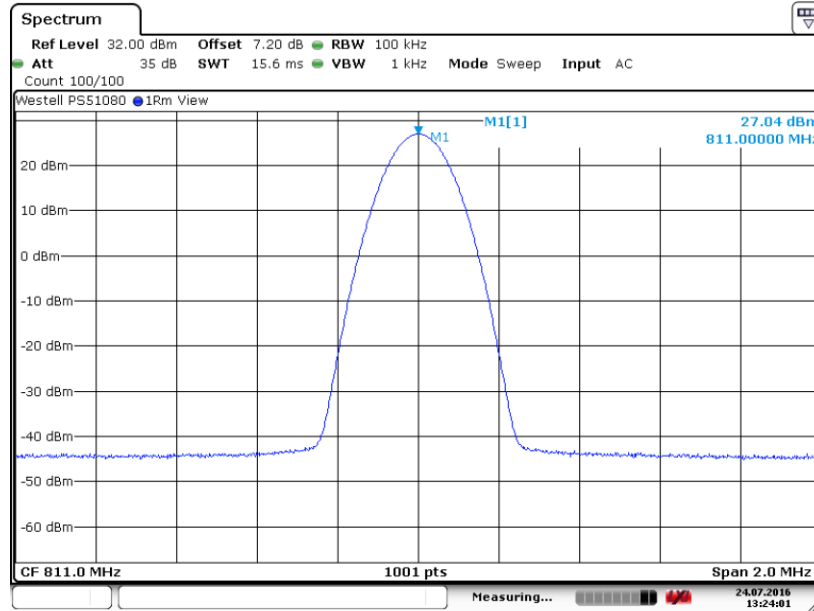

Date: 24.JUL.2016 13:24:00

6.1.17. Mean Transmitter Input Power, 811 MHz, C4FM Modulation

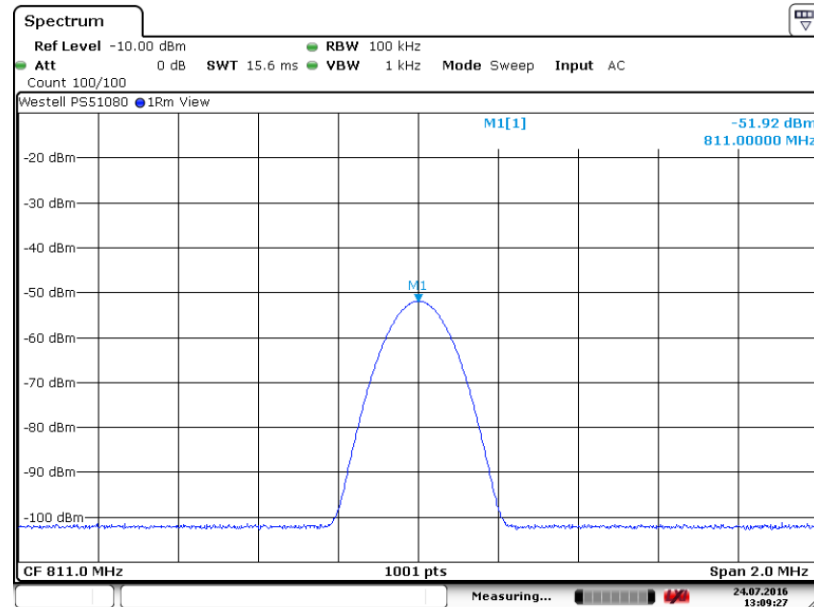

Date: 24.JUL.2016 13:09:26

6. Measurement Data

6.1. Limitations on power and antenna height 90.219(e)(1), 90.635 cont.

6.1.18. Mean Transmitter Output Power, 816 MHz, C4FM Modulation

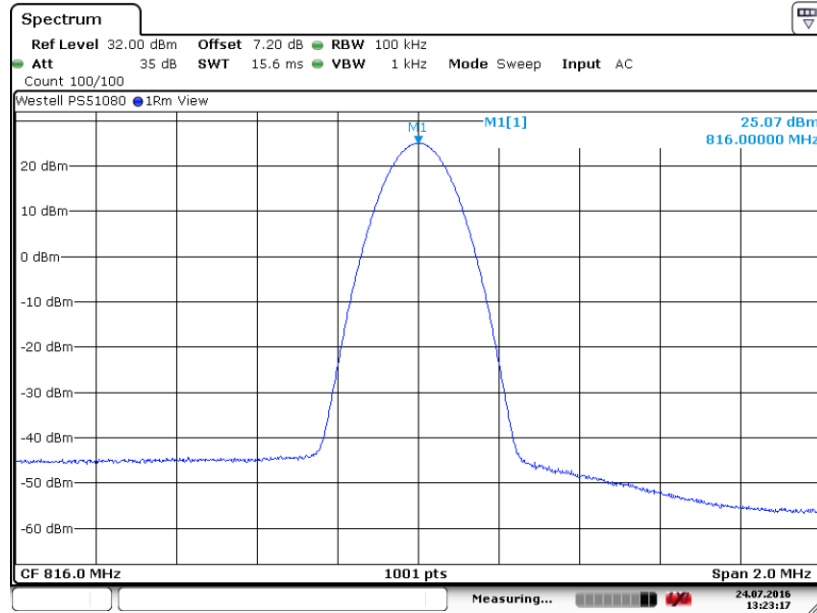

Date: 24.JUL.2016 13:23:16

6.1.19. Mean Transmitter Input Power, 816 MHz, C4FM Modulation

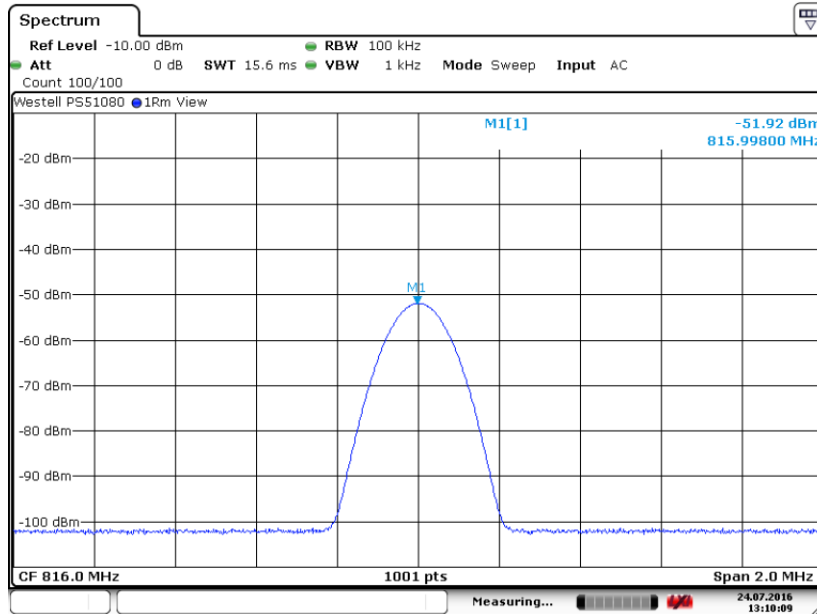

Date: 24.JUL.2016 13:10:08

6. Measurement Data

6.1. Limitations on power and antenna height 90.219(e)(1), 90.635 cont.

6.1.20. Mean Transmitter Output Power, 806 MHz, $\pi/4$ -DQPSK Modulation

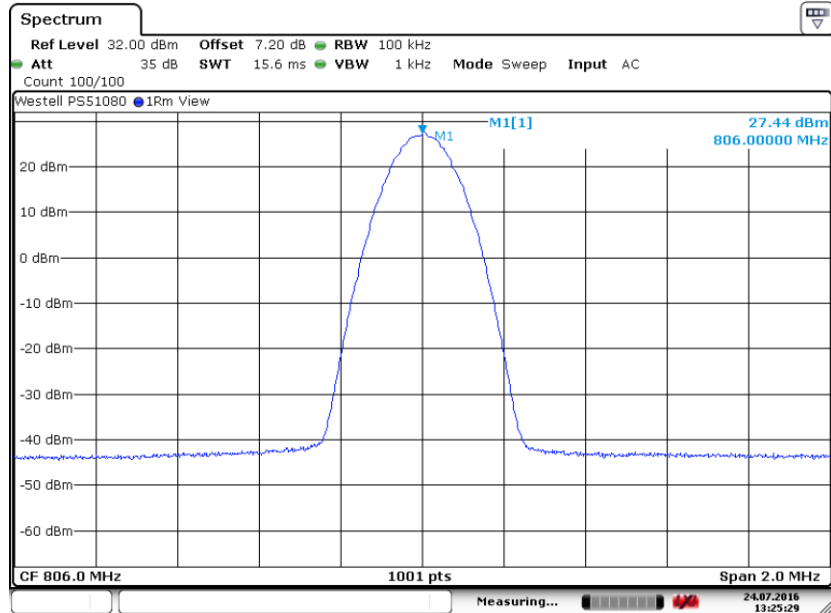

Date: 24.JUL.2016 13:25:28

6.1.21. Mean Transmitter Input Power, 806 MHz, $\pi/4$ -DQPSK Modulation

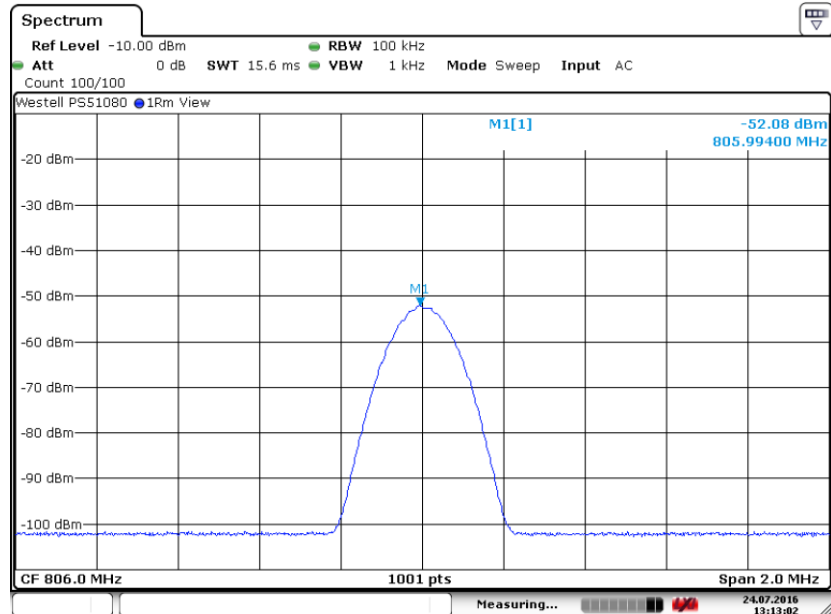

Date: 24.JUL.2016 13:13:02

6. Measurement Data

6.1. Limitations on power and antenna height 90.219(e)(1), 90.635 (cont)

6.1.22. Mean Transmitter Output Power, 811 MHz, $\pi/4$ -DQPSK Modulation

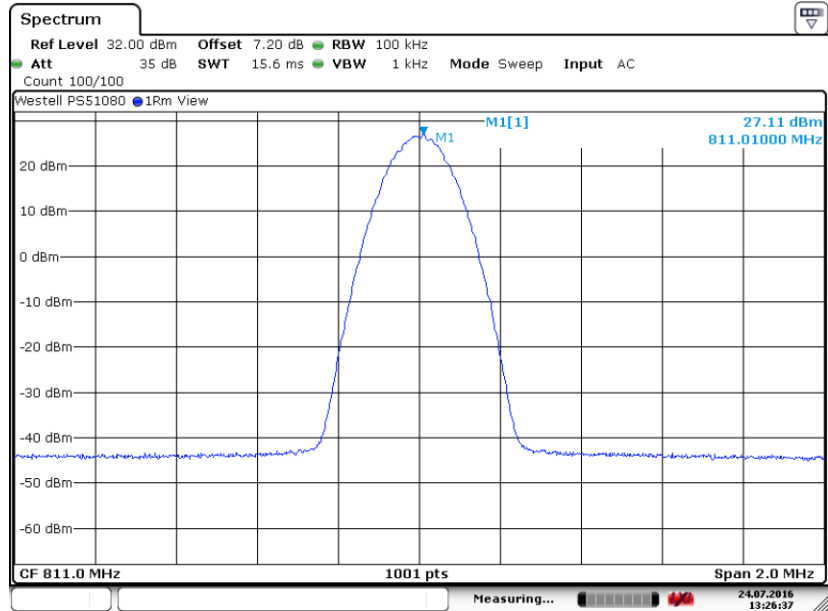

6.1.23. Mean Transmitter Input Power, 811 MHz, $\pi/4$ -DQPSK Modulation

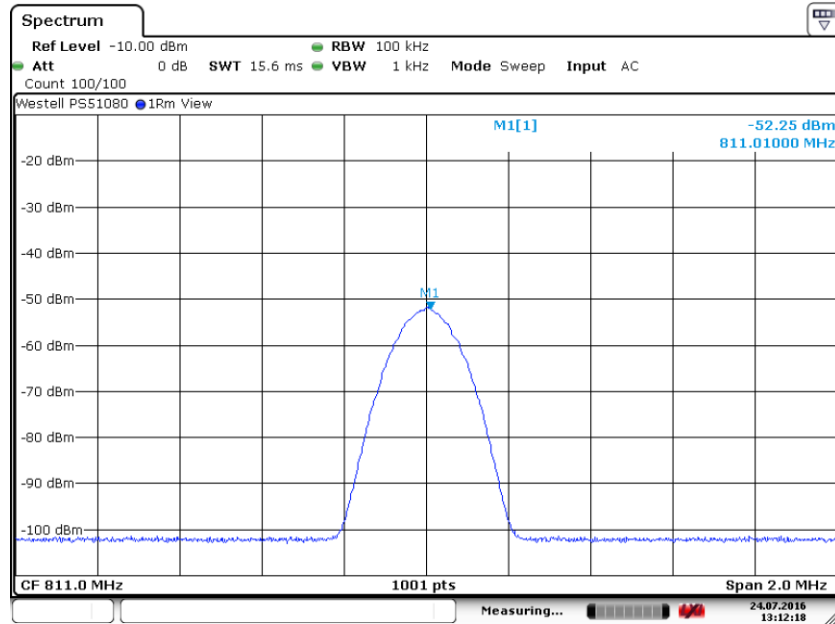

6. Measurement Data

6.1. Limitations on power and antenna height 90.219(e)(1), 90.635 (cont)

6.1.24. Mean Transmitter Output Power, 816 MHz, $\pi/4$ -DQPSK Modulation

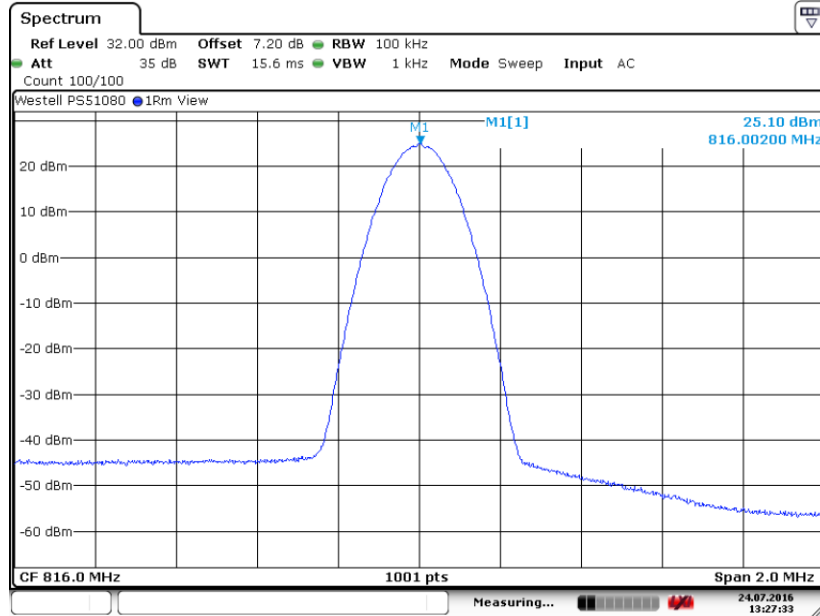

Date: 24.JUL.2016 13:27:32

6.1.25. Mean Transmitter Input Power, 816 MHz, $\pi/4$ -DQPSK Modulation

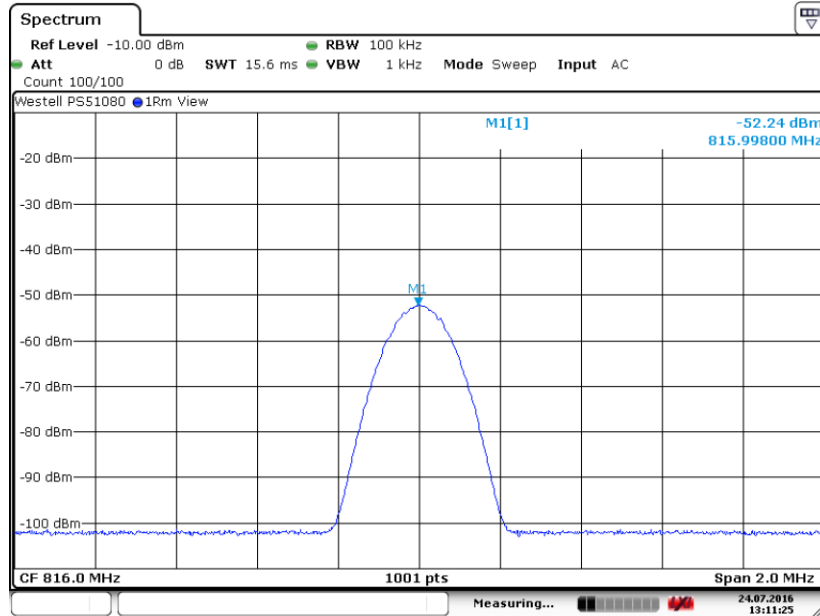

Date: 24.JUL.2016 13:11:24

6. Measurement Data

6.1. Limitations on power and antenna height 90.219(e)(1), 90.635 (cont)

6.1.26. Mean Transmitter Output Power, 851 MHz, FM Modulation

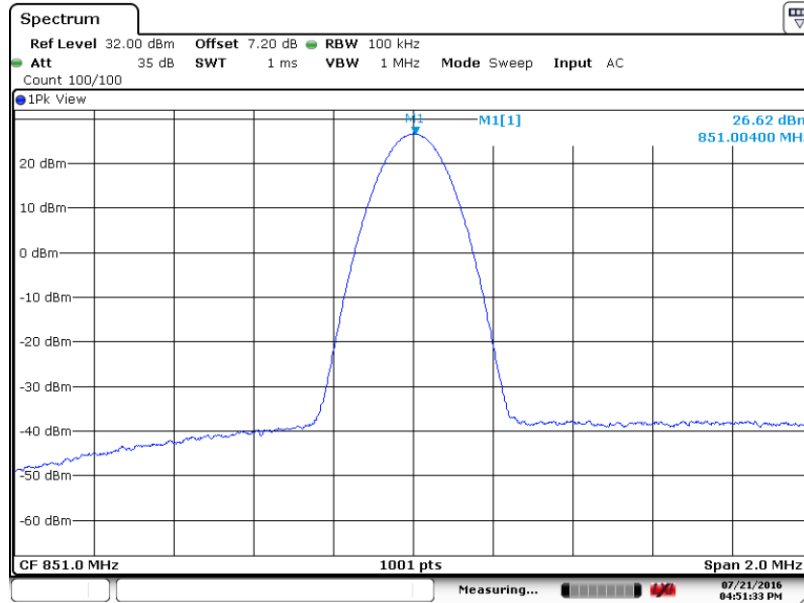

Date: 21.JUL.2016 16:51:32

6.1.27. Mean Transmitter Input Power, 851 MHz, FM Modulation

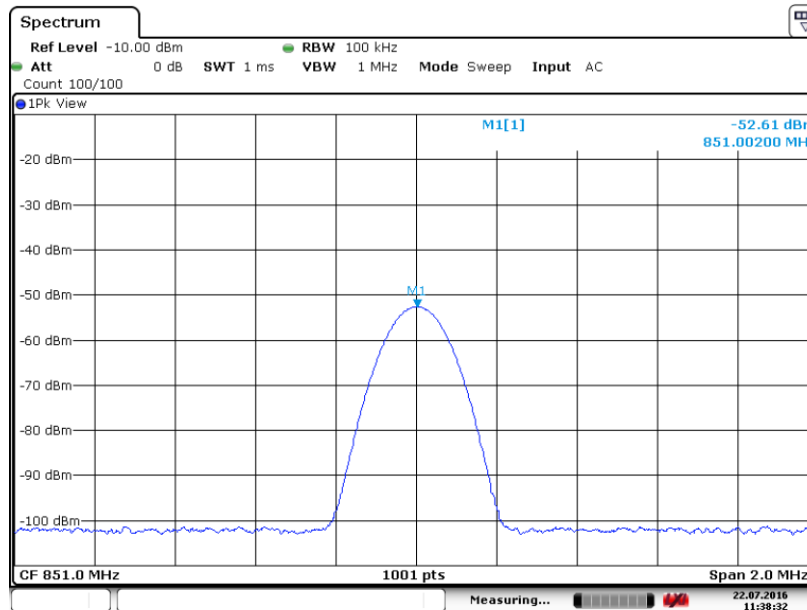

Date: 22.JUL.2016 11:38:31

6. Measurement Data

6.1. Limitations on power and antenna height 90.219(e)(1), 90.635 (cont)

6.1.28. Mean Transmitter Output Power, 856 MHz, FM Modulation

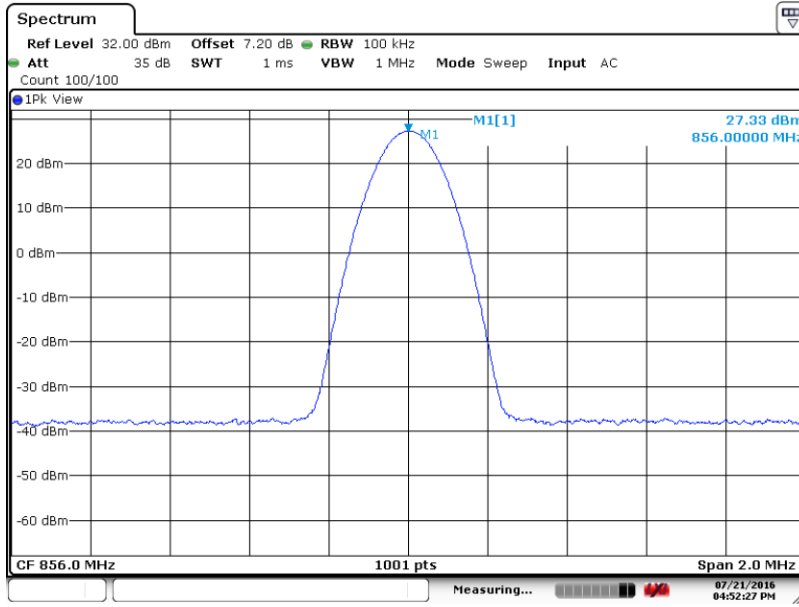

Date: 21.JUL.2016 16:52:26

6.1.29. Mean Transmitter Input Power, 856 MHz, FM Modulation

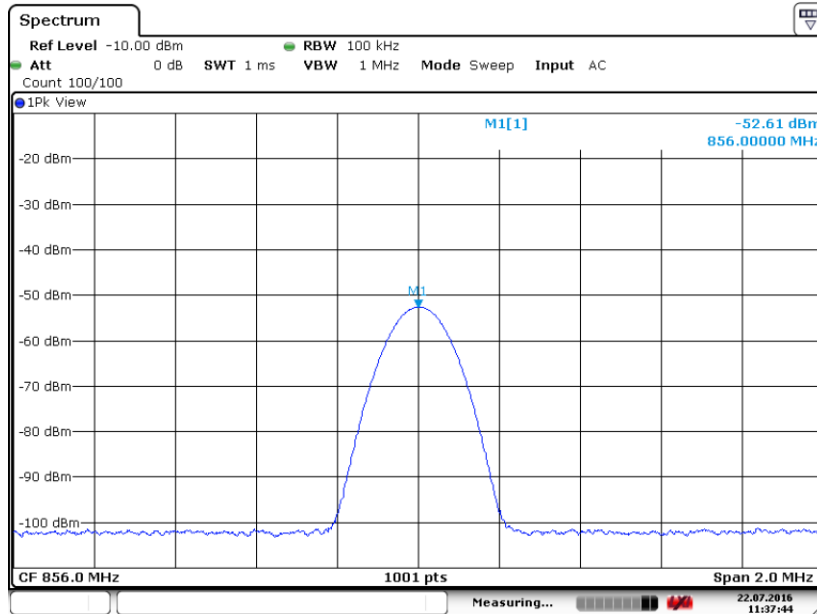

Date: 22.JUL.2016 11:37:43

6. Measurement Data

6.1. Limitations on power and antenna height 90.219(e)(1), 90.635 (cont)

6.1.30. Mean Transmitter Output Power, 861 MHz, FM Modulation

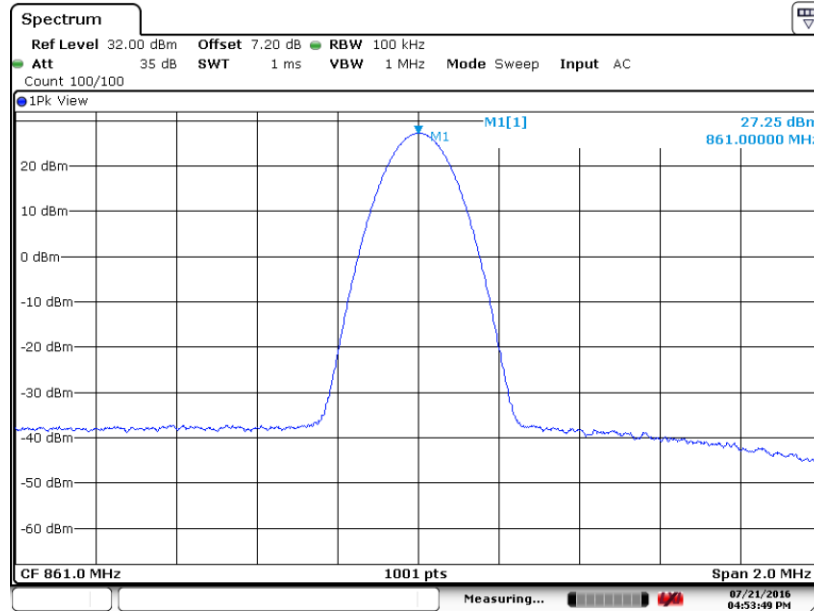

Date: 21.JUL.2016 16:53:49

6.1.31. Mean Transmitter Input Power, 861 MHz, FM Modulation

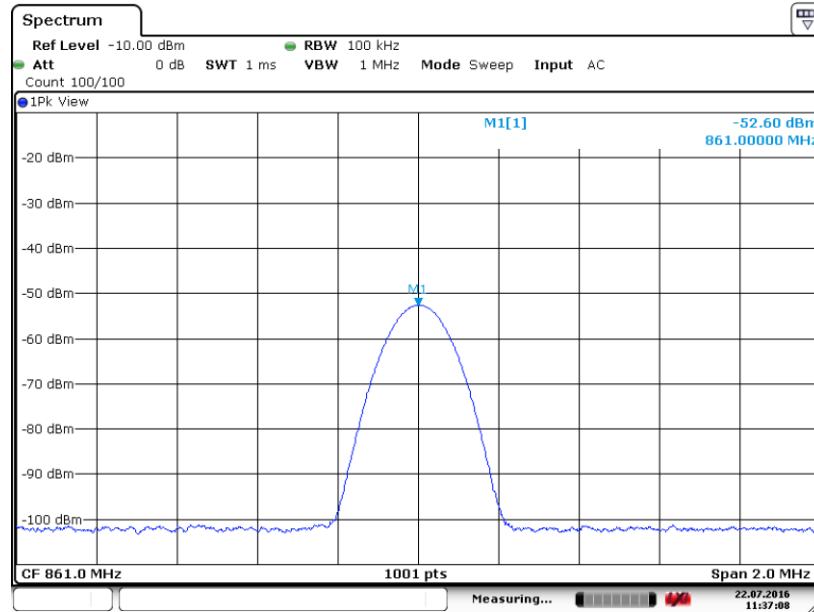

Date: 22.JUL.2016 11:37:07

6. Measurement Data

6.1. Limitations on power and antenna height 90.219(e)(1), 90.635 (cont)

6.1.32. Mean Transmitter Output Power, 851 MHz, CW Signal

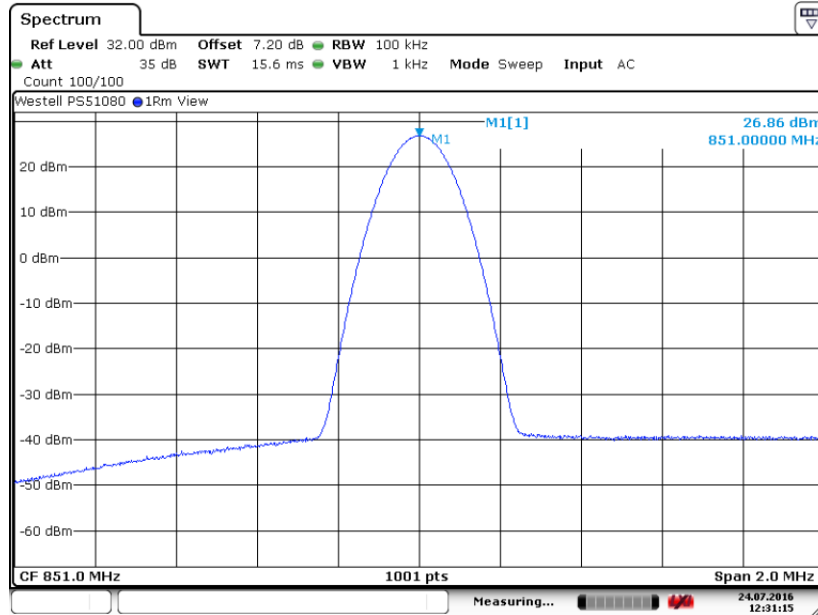

Date: 24.JUL.2016 12:31:14

6.1.33. Mean Transmitter Input Power, 851 MHz, CW Signal

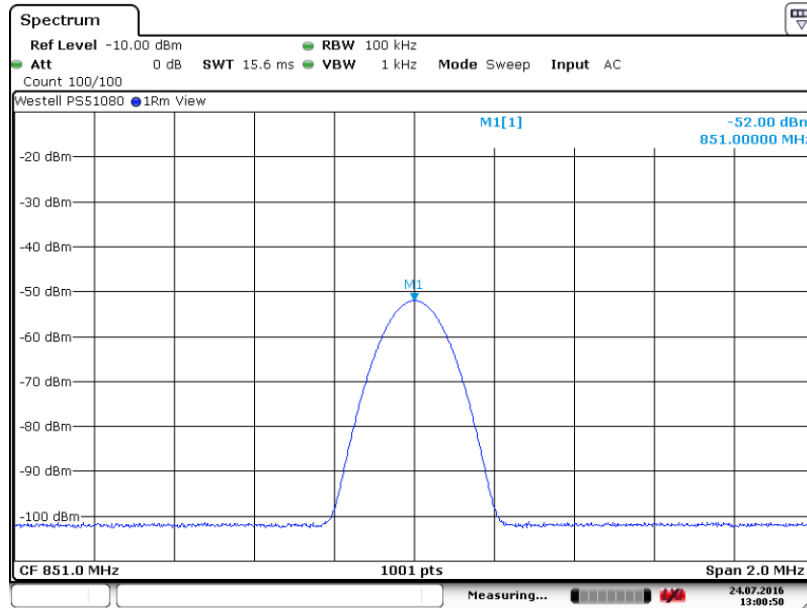

Date: 24.JUL.2016 13:00:49

6. Measurement Data

6.1. Limitations on power and antenna height 90.219(e)(1), 90.635 (cont)

6.1.34. Mean Transmitter Output Power, 856 MHz, CW Signal

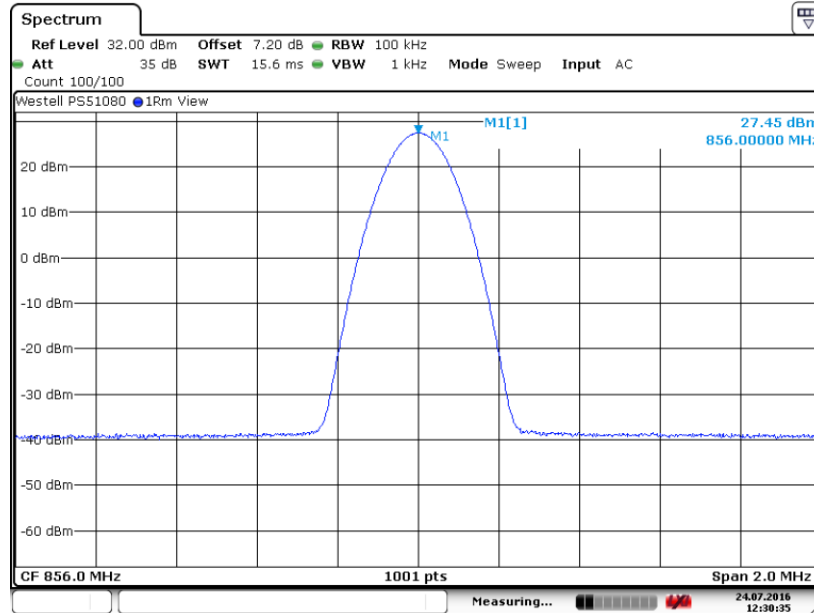

Date: 24.JUL.2016 12:30:34

6.1.35. Mean Transmitter Input Power, 856 MHz, CW Signal

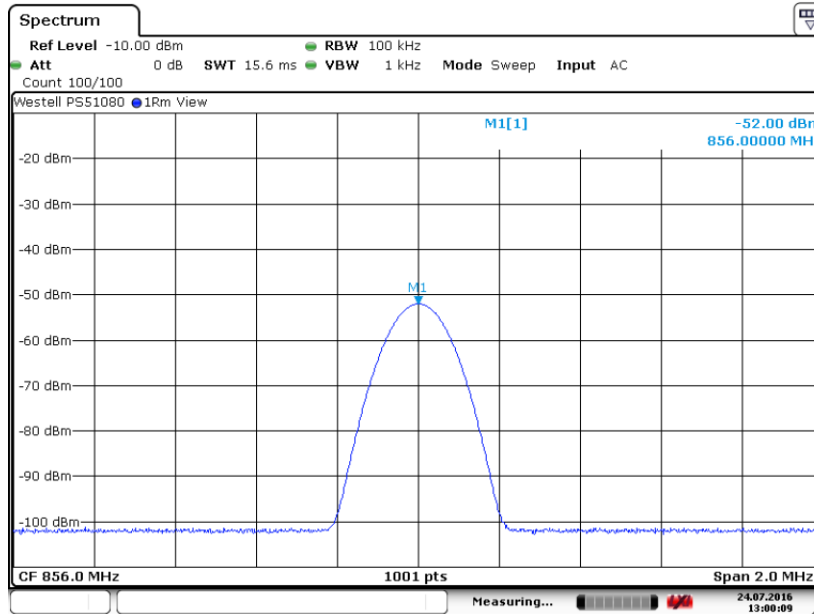

Date: 24.JUL.2016 13:00:08

6. Measurement Data

6.1. Limitations on power and antenna height 90.219(e)(1), 90.635 (cont)

6.1.36. Mean Transmitter Output Power, 861 MHz, CW Signal

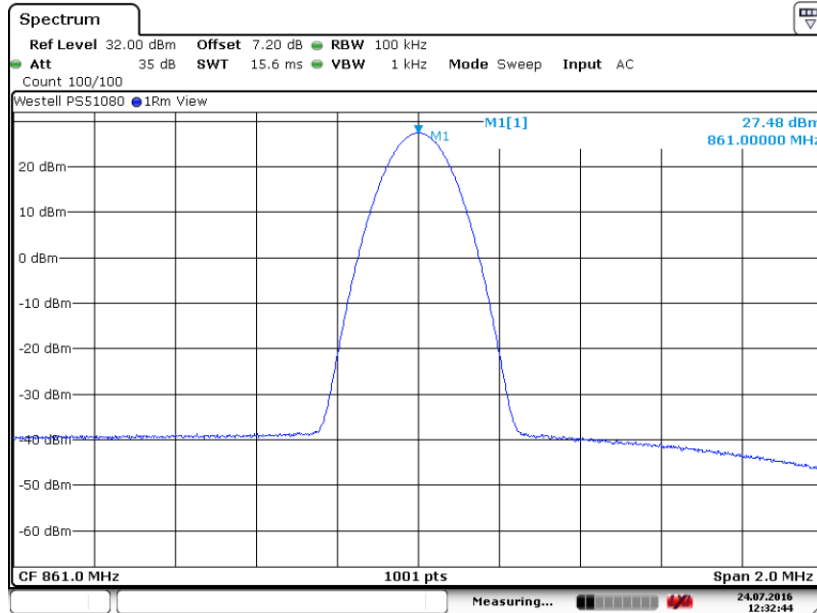

Date: 24.JUL.2016 12:32:43

6.1.37. Mean Transmitter Input Power, 861 MHz, CW Signal

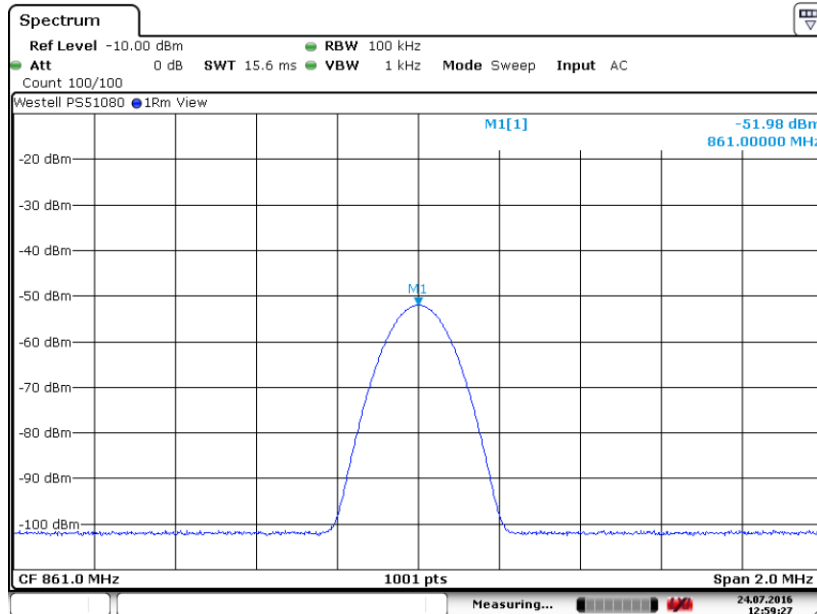

Date: 24.JUL.2016 12:59:26

6. Measurement Data

6.1. Limitations on power and antenna height 90.219(e)(1), 90.635 (cont)

6.1.38. Mean Transmitter Output Power, 851 MHz, C4FM Modulation

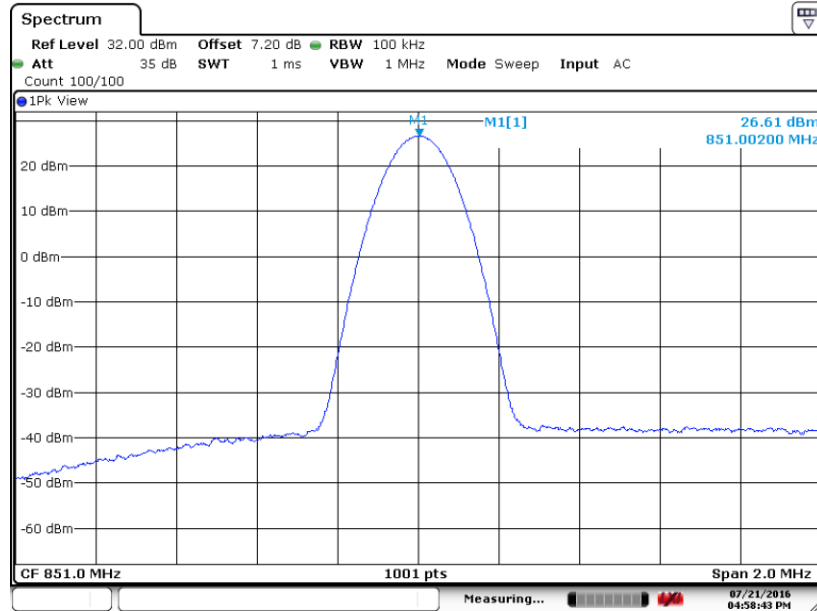

Date: 21.JUL.2016 16:58:42

6.1.39. Mean Transmitter Input Power, 851 MHz, C4FM Modulation

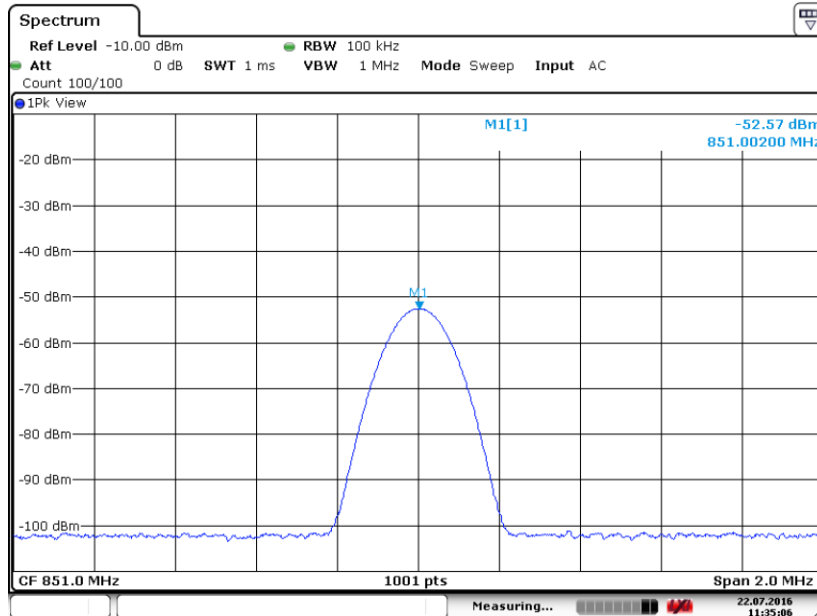

Date: 22.JUL.2016 11:35:05

6. Measurement Data

6.1. Limitations on power and antenna height 90.219(e)(1), 90.635 (cont)

6.1.40. Mean Transmitter Output Power, 856 MHz, C4FM Modulation

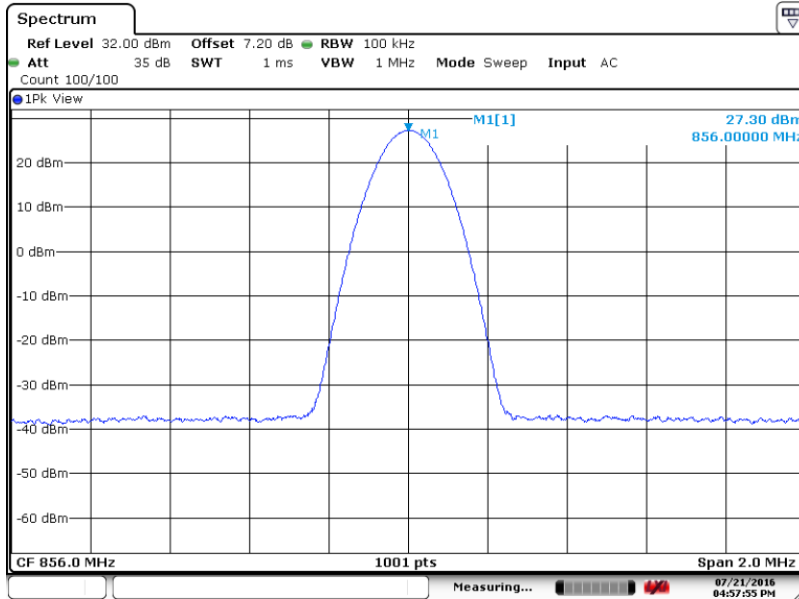

Date: 21.JUL.2016 16:57:55

6.1.41. Mean Transmitter Input Power, 856 MHz, C4FM Modulation

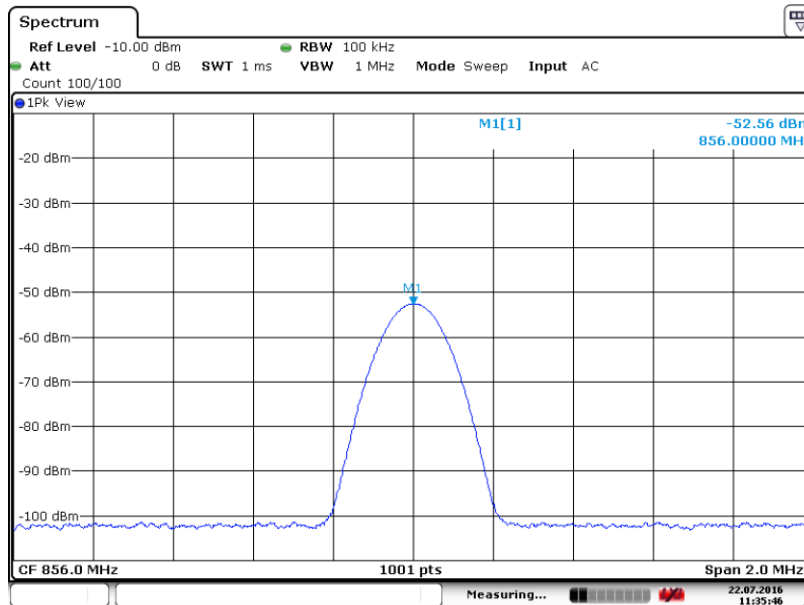

Date: 22.JUL.2016 11:35:46

6. Measurement Data

6.1. Limitations on power and antenna height 90.219(e)(1), 90.635 (cont)

6.1.42. Mean Transmitter Output Power, 861 MHz, C4FM Modulation

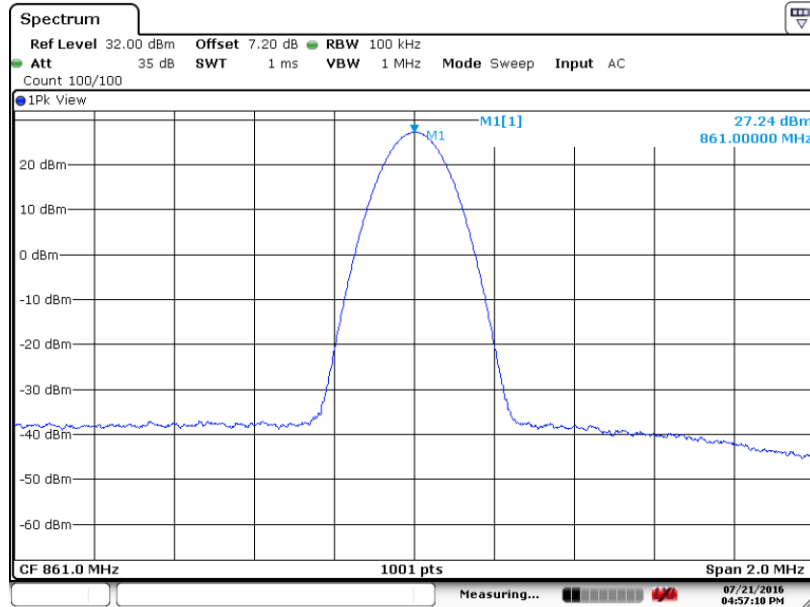

Date: 21.JUL.2016 16:57:10

6.1.43. Mean Transmitter Input Power, 861 MHz, C4FM Modulation

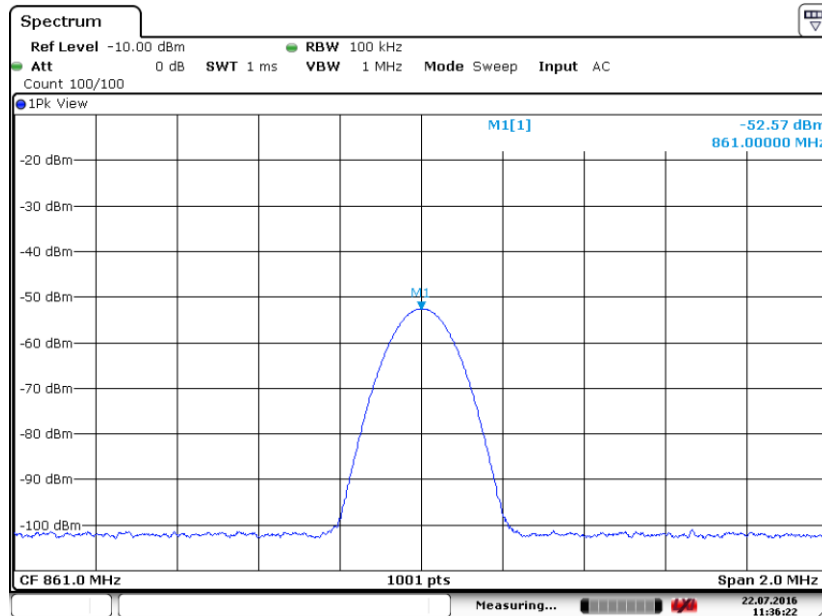

Date: 22.JUL.2016 11:36:21

6. Measurement Data

6.1. Limitations on power and antenna height 90.219(e)(1), 90.635 (cont)

6.1.44. Mean Transmitter Output Power, 851 MHz, $\pi/4$ -DQPSK Modulation

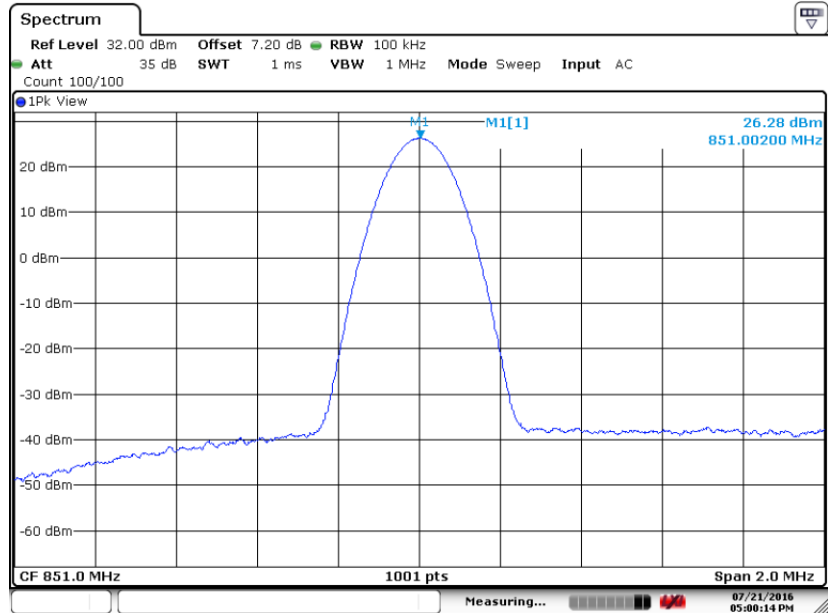

Date: 21.JUL.2016 17:00:13

6.1.45. Mean Transmitter Input Power, 851 MHz, $\pi/4$ -DQPSK Modulation

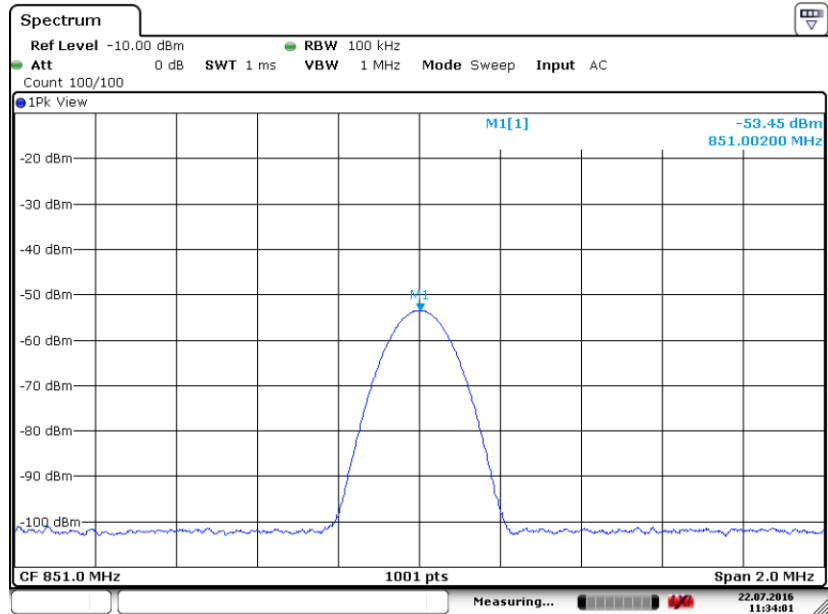

Date: 22.JUL.2016 11:34:01

6. Measurement Data

6.1. Limitations on power and antenna height 90.219(e)(1), 90.635 (cont)

6.1.46. Mean Transmitter Output Power, 856 MHz, $\pi/4$ -DQPSK Modulation

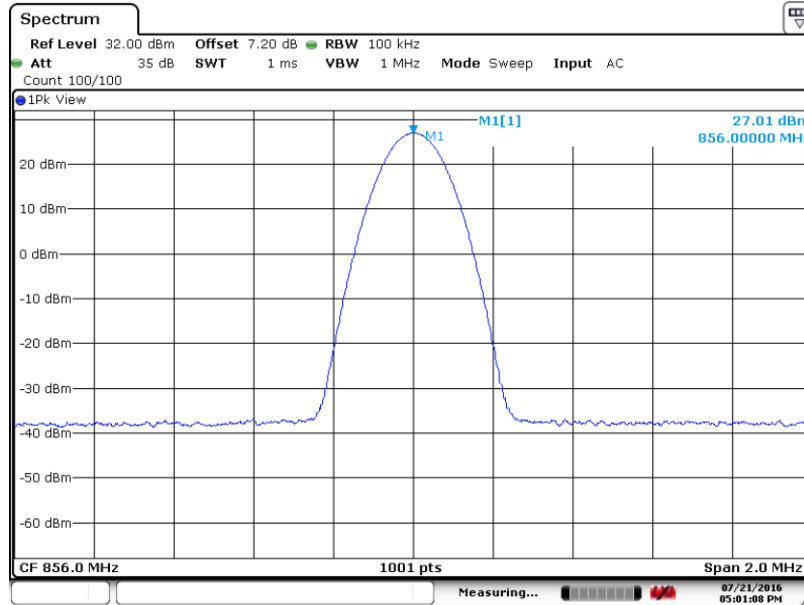

Date: 21.JUL.2016 17:01:07

6.1.47. Mean Transmitter Input Power, 856 MHz, $\pi/4$ -DQPSK Modulation

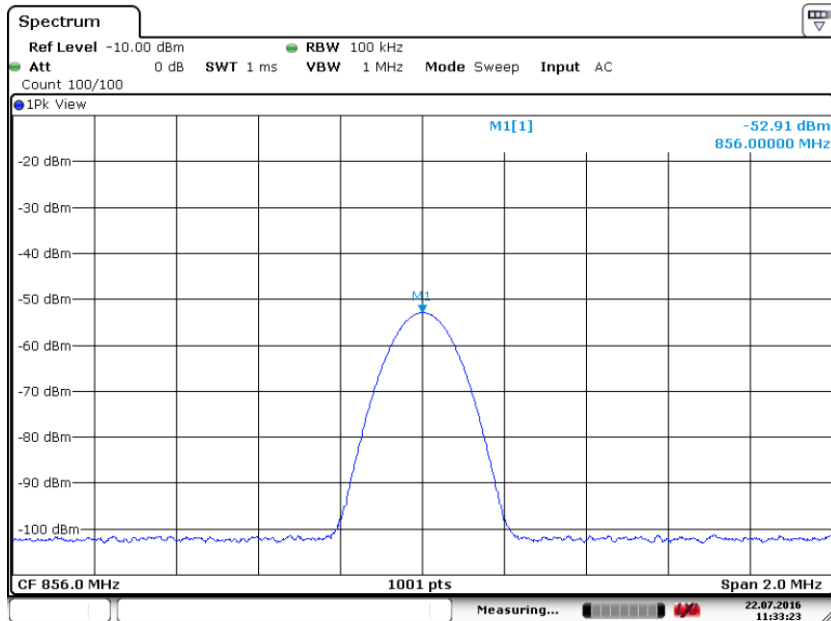

Date: 22.JUL.2016 11:33:22

6. Measurement Data

6.1. Limitations on power and antenna height 90.219(e)(1), 90.635 (cont)

6.1.48. Mean Transmitter Output Power, 861 MHz, $\pi/4$ -DQPSK Modulation

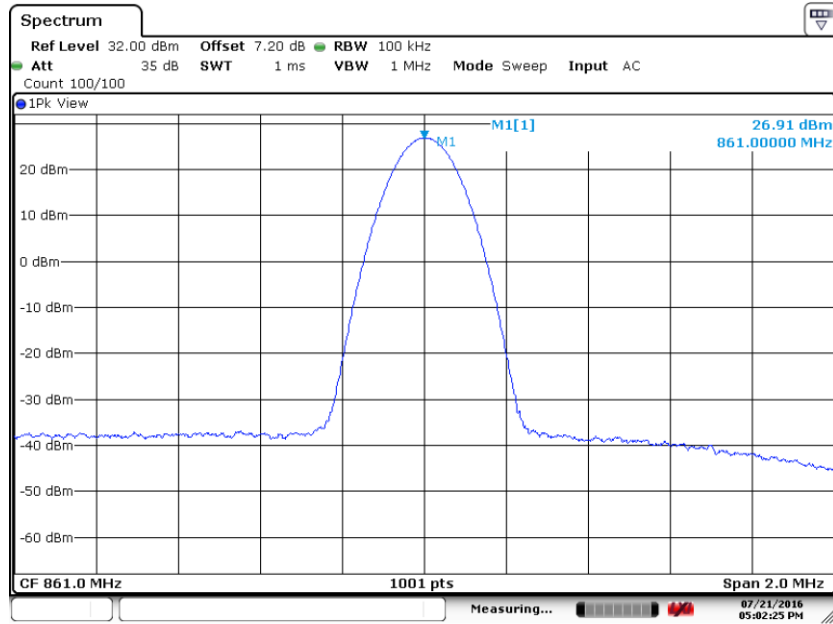

Date: 21.JUL.2016 17:02:24

6.1.49. Mean Transmitter Input Power, 861 MHz, $\pi/4$ -DQPSK Modulation

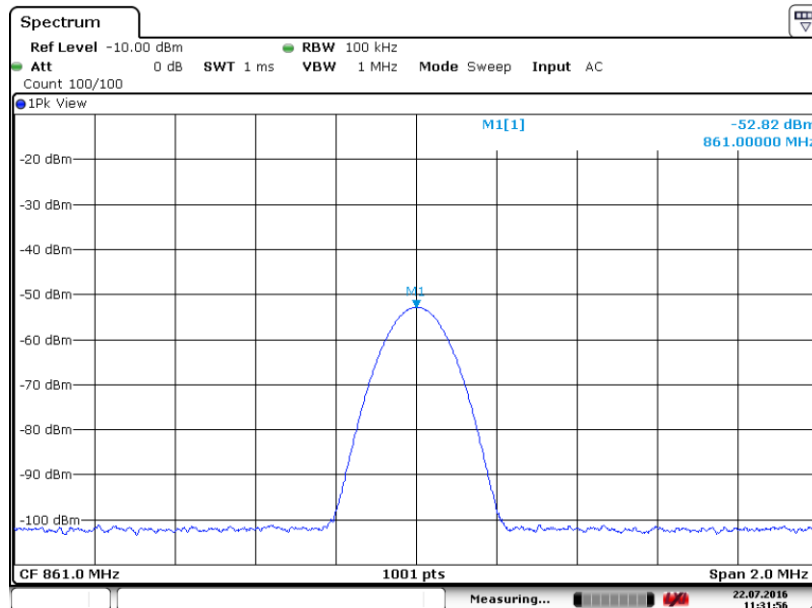

Date: 22.JUL.2016 11:31:55

6. Measurement Data

6.1. Limitations on power and antenna height 90.219(e)(1), 90.635 (continued)

6.1.2. Maximum ERP

ERP is defined in FCC Title 47, Chapter I, Part 2, Subpart A, Section 2.1 as "Effective Radiated Power. The product of the power supplied to the antenna and its gain relative to a half-wave dipole in a given direction."

$$ERP = \text{Transmitter Power (dBm)} - \text{Cable Loss (dB)} + \text{Antenna Gain (dBi)}$$

The manufacturer of the device under test recommends one antenna and cable combination for use with their product. The following table provides the worst case effective radiated power based on the measured transmitter output power and the antenna gain:

Modulation Type	Center Frequency	Transmitter Power	Cable Insertion Loss	Antenna Gain	Total Output Power	
	MHz	dBm	dB	dBi	dBm	Watts
FM Modulation	806	27.46	0.00	3.00	30.46	1.11
FM Modulation	811	26.94	0.00	3.00	29.94	0.99
FM Modulation	816	24.98	0.00	3.00	27.98	0.63
CW	806	27.48	0.00	3.00	30.48	1.12
CW	811	26.96	0.00	3.00	29.96	0.99
CW	816	24.99	0.00	3.00	27.99	0.63
C4FM Modulation	806	27.56	0.00	3.00	30.56	1.14
C4FM Modulation	811	27.04	0.00	3.00	30.04	1.01
C4FM Modulation	816	25.07	0.00	3.00	28.07	0.64
$\pi/4$ -DQPSK Modulation	806	27.44	0.00	3.00	30.44	1.11
$\pi/4$ -DQPSK Modulation	811	27.11	0.00	3.00	30.11	1.03
$\pi/4$ -DQPSK Modulation	816	25.10	0.00	3.00	28.10	0.65
FM Modulation	851	26.62	0.00	3.00	29.62	0.92
FM Modulation	856	27.33	0.00	3.00	30.33	1.08
FM Modulation	861	27.25	0.00	3.00	30.25	1.06
CW	851	26.86	0.00	3.00	29.86	0.97
CW	856	27.45	0.00	3.00	30.45	1.11
CW	861	27.48	0.00	3.00	30.48	1.12
C4FM Modulation	851	26.61	0.00	3.00	29.61	0.91
C4FM Modulation	856	27.30	0.00	3.00	30.30	1.07
C4FM Modulation	861	27.24	0.00	3.00	30.24	1.06
$\pi/4$ -DQPSK Modulation	851	26.28	0.00	3.00	29.28	0.85
$\pi/4$ -DQPSK Modulation	856	27.01	0.00	3.00	30.01	1.00
$\pi/4$ -DQPSK Modulation	861	26.91	0.00	3.00	29.91	0.98

¹ Measured. See section 6.1.1.

² Customer supplied 3 dBi. Factor is a combination of both antenna gain and cable loss.

6. Measurement Data (continued)**6.2. Bandwidth Limitations 90.219(e)(4)(ii), FCC Part 2.1049 and Emission Mask 90.210**

Requirement: Each authorization issued to a station licensed under this part will show an emission designator representing the class of emission authorized. The designator will be prefixed by a specified necessary bandwidth. This number does not necessarily indicate the bandwidth occupied by the emission at any instant.

There is no significant change in the occupied bandwidth of the retransmitted signal.

Emission Mask shall also be met for each modulation type. Emission Mask H is used for the 806 to 809 MHz and 851 to 854 MHz bands and Emission Mask G is used for the 809 to 816(824) MHz and 854 to 861(869) MHz Bands per the table in section 90.210.

FM modulation at 16 kHz was used as worst case against emission Masks H and G at AGC threshold and 3 dB above AGC threshold as the other modulations are narrower.

Test Method: KDB 935210 Section 4.4

6. Measurement Data (continued)

6.2. Bandwidth Limitations 90.219(e)(4)(ii), FCC Part 2.1049 and Emission Mask 90.210

6.2.1. Occupied (99% Power) Bandwidth

Modulation Type	Frequency	Output Occupied Bandwidth	Input Occupied Bandwidth	Difference	Result
	MHz	kHz	kHz	kHz	
FM 16K0F3E	806	16.034	16.034	0.000	Compliant
FM 16K0F3E	811	16.034	16.034	0.000	Compliant
FM 16K0F3E	816	16.034	16.034	0.000	Compliant
FM 11K3F3E	806	11.329	11.329	0.000	Compliant
FM 11K3F3E	811	11.329	11.329	0.000	Compliant
FM 11K3F3E	816	11.329	11.329	0.000	Compliant
FM 4K05F1E	806	4.046	4.046	0.000	Compliant
FM 4K05F1E	811	4.046	4.046	0.000	Compliant
FM 4K05F1E	816	4.046	4.046	0.000	Compliant
C4FM	806	8.122	8.122	0.000	Compliant
C4FM	811	8.092	8.152	-0.060	Compliant
C4FM	816	8.092	8.122	-0.030	Compliant
$\pi/4$ -DQPSK	758	9.800	9.800	0.000	Compliant
$\pi/4$ -DQPSK	766	9.770	9.770	0.000	Compliant
$\pi/4$ -DQPSK	775	9.740	9.770	-0.030	Compliant
FM 16K0F3E	851	16.034	16.034	0.000	Compliant
FM 16K0F3E	856	16.034	16.034	0.000	Compliant
FM 16K0F3E	861	16.034	16.034	0.000	Compliant
FM 11K3F3E	788	11.329	11.329	0.000	Compliant
FM 11K3F3E	796	11.329	11.299	0.030	Compliant
FM 11K3F3E	805	11.329	11.329	0.000	Compliant
FM 4K05F1E	788	4.046	4.046	0.000	Compliant
FM 4K05F1E	796	4.046	4.046	0.000	Compliant
FM 4K05F1E	805	4.046	4.046	0.000	Compliant
C4FM	788	8.122	8.092	0.030	Compliant
C4FM	796	8.092	8.122	-0.030	Compliant
C4FM	805	8.092	8.092	0.000	Compliant
$\pi/4$ -DQPSK	788	9.770	9.740	0.030	Compliant
$\pi/4$ -DQPSK	796	9.800	9.830	-0.030	Compliant
$\pi/4$ -DQPSK	805	9.770	9.770	0.000	Compliant

6. Measurement Data (continued)

6.2. Bandwidth Limitations 90.219(e)(4)(ii), FCC Part 2.1049 (continued)

6.2.1.1. Occupied (99% Power) Bandwidth Measurement, 806 MHz, 16k FM

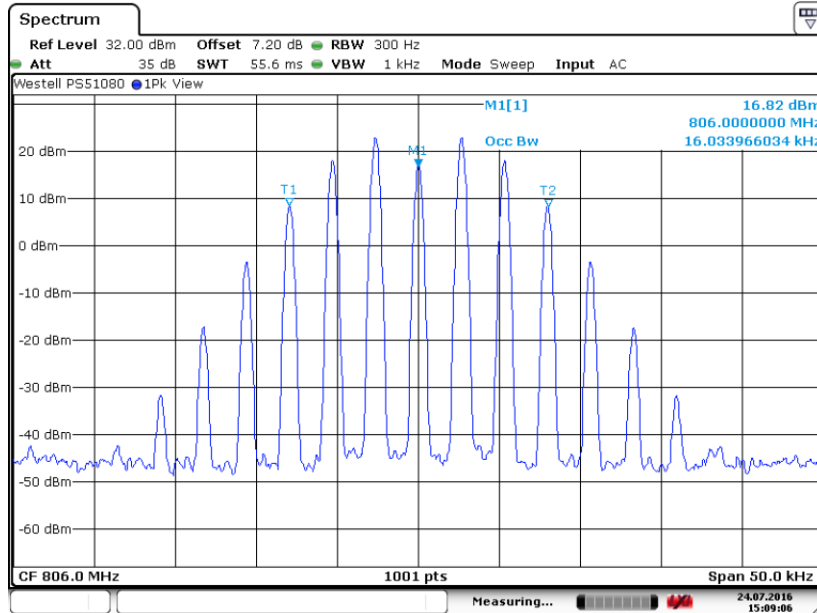

Date: 24.JUL.2016 15:09:05

6.2.1.2. Occupied (99% Power) Bandwidth Input, 806 MHz, 16k FM

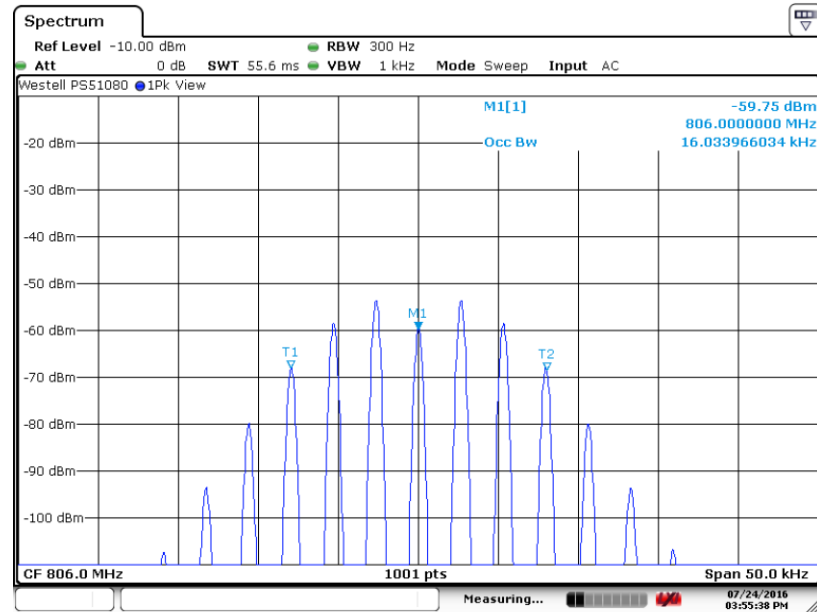

Date: 24.JUL.2016 15:55:37

6. Measurement Data (continued)

6.2. Bandwidth Limitations 90.219(e)(4)(ii), FCC Part 2.1049 (continued)

6.2.1.3. Occupied (99% Power) Emissions Mask H, 806 MHz, 16k FM

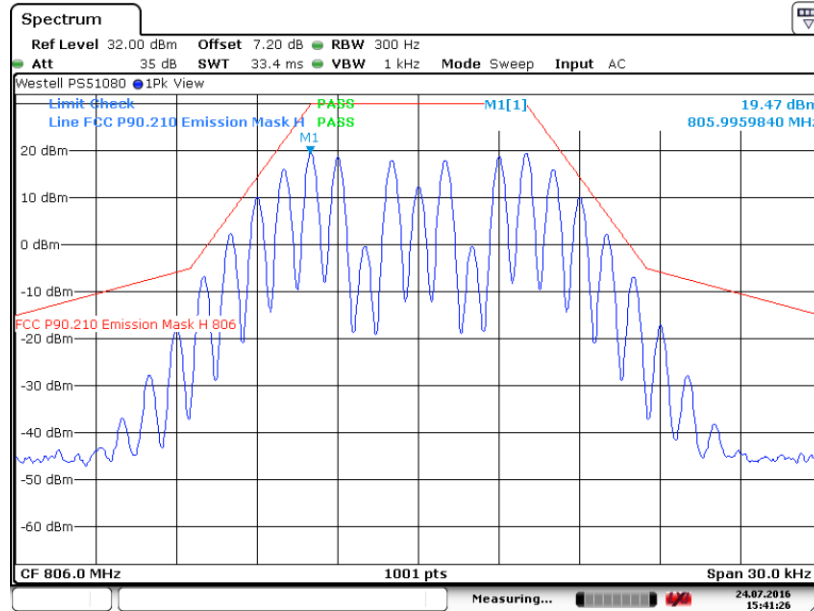

Date: 24.JUL.2016 15:41:25

6.2.1.4. Occupied (99% Power) Emissions Mask H plus 3 dB, 806 MHz, 16k FM

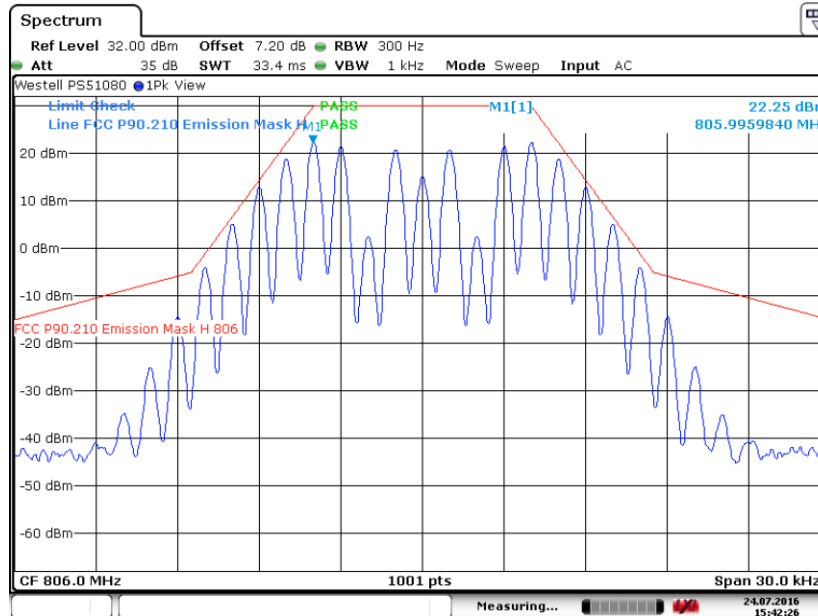

Date: 24.JUL.2016 15:42:25

6. Measurement Data (continued)

6.2. Bandwidth Limitations 90.219(e)(4)(ii), FCC Part 2.1049 (continued)

6.2.1.5. Occupied (99% Power) Bandwidth Measurement, 806 MHz, 11k FM

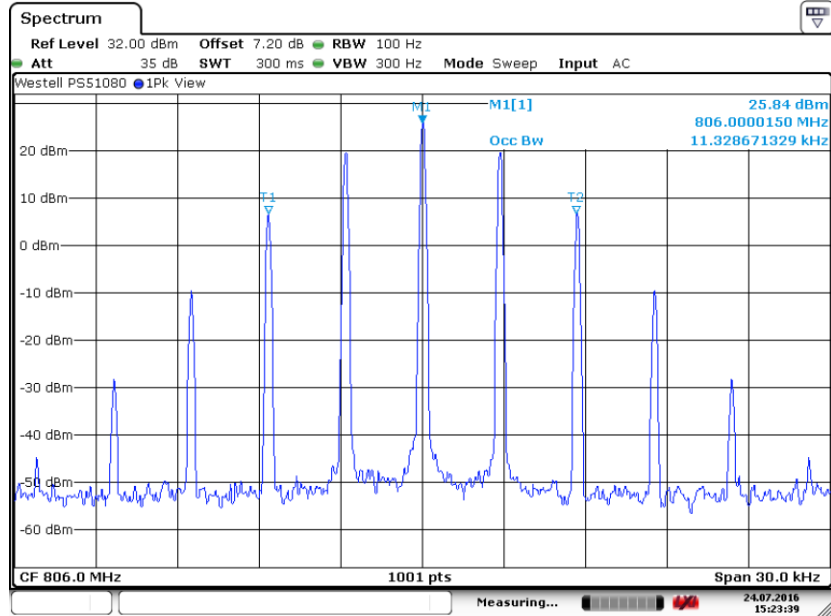

6.2.1.6. Occupied (99% Power) Bandwidth Input, 806 MHz, 11k FM

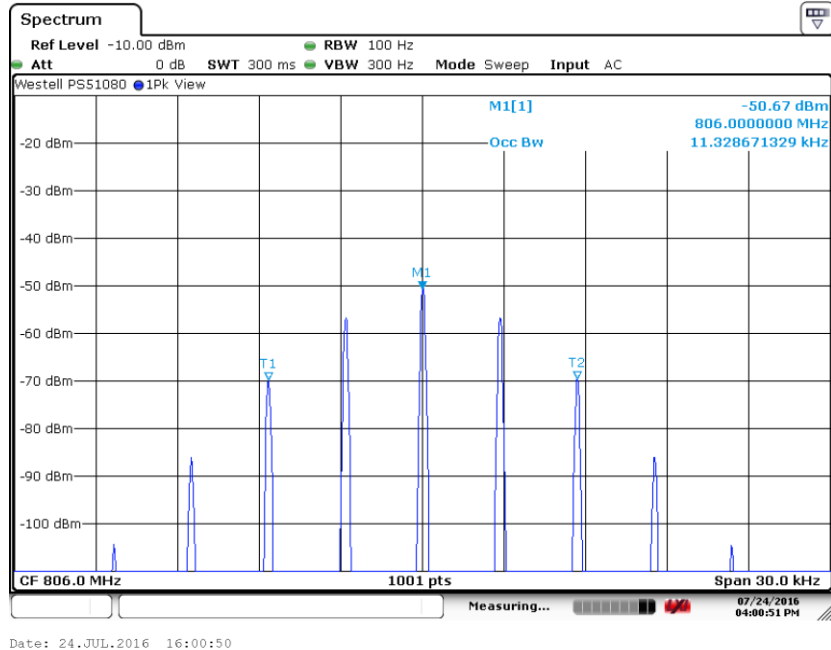

6. Measurement Data (continued)

6.2. Bandwidth Limitations 90.219(e)(4)(ii), FCC Part 2.1049 (continued)

6.2.1.7. Occupied (99% Power) Bandwidth Measurement, 806 MHz, 4k FM

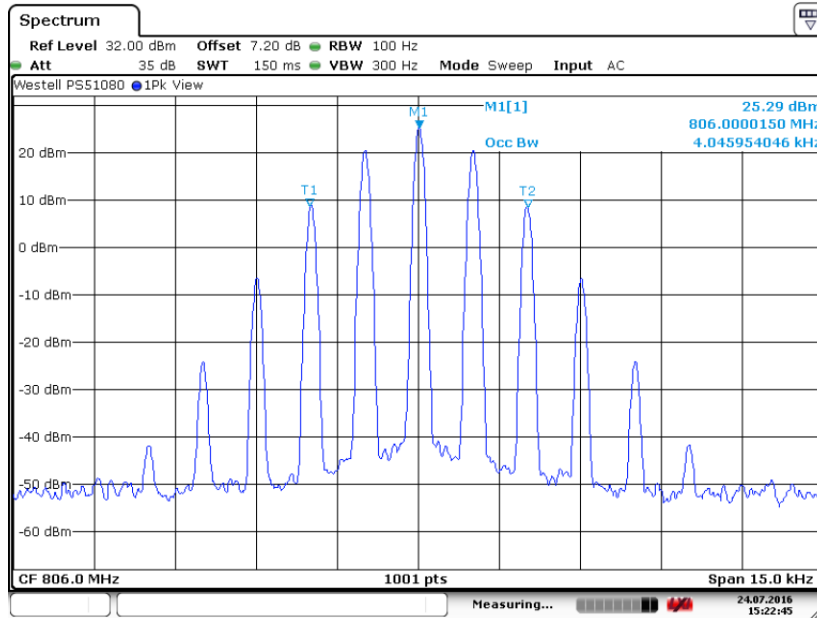

6.2.1.8. Occupied (99% Power) Bandwidth Input, 806 MHz, 4k FM

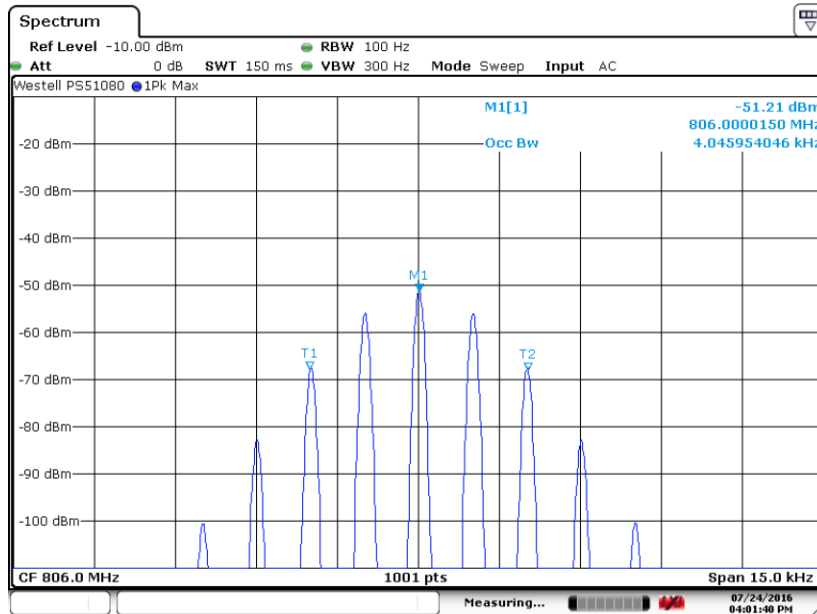

6. Measurement Data (continued)

6.2. Bandwidth Limitations 90.219(e)(4)(ii), FCC Part 2.1049 (continued)

6.2.1.9. Occupied (99% Power) Bandwidth Measurement, 806 MHz, C4FM

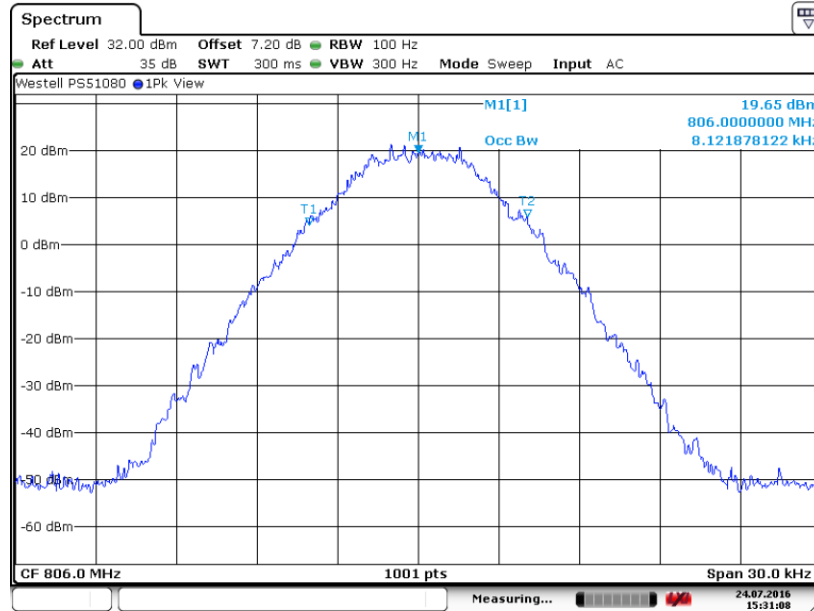

6.2.1.10. Occupied (99% Power) Bandwidth Input, 806 MHz, C4FM

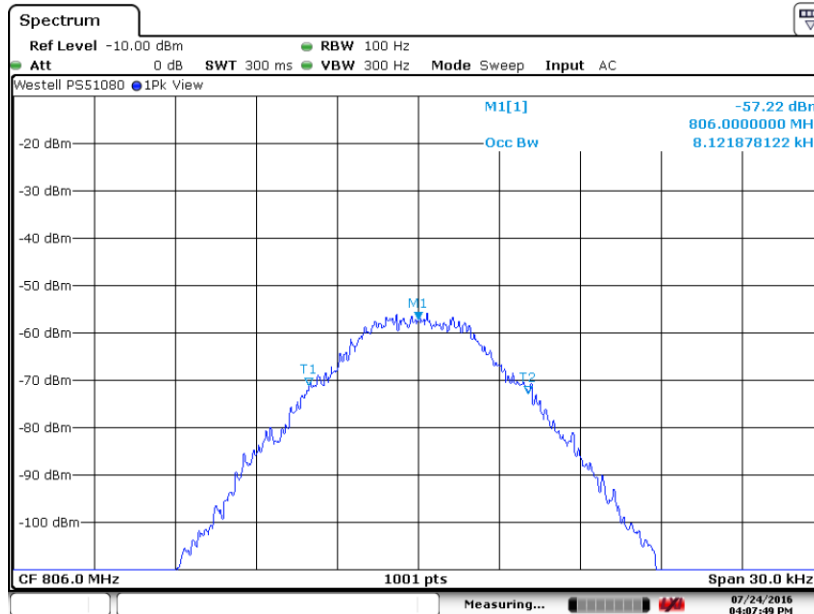

6. Measurement Data (continued)

6.2. Bandwidth Limitations 90.219(e)(4)(ii), FCC Part 2.1049 (continued)

6.2.1.11. Occupied (99% Power) Bandwidth Measurement, 806 MHz, $\pi/4$ -DQPSK

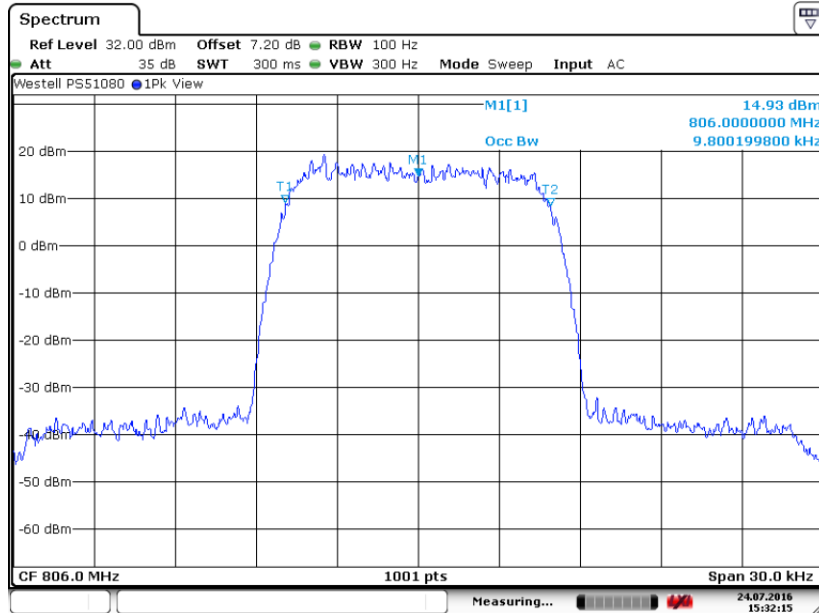

Date: 24.JUL.2016 15:32:15

6.2.1.12. Occupied (99% Power) Bandwidth Input, 806 MHz, $\pi/4$ -DQPSK

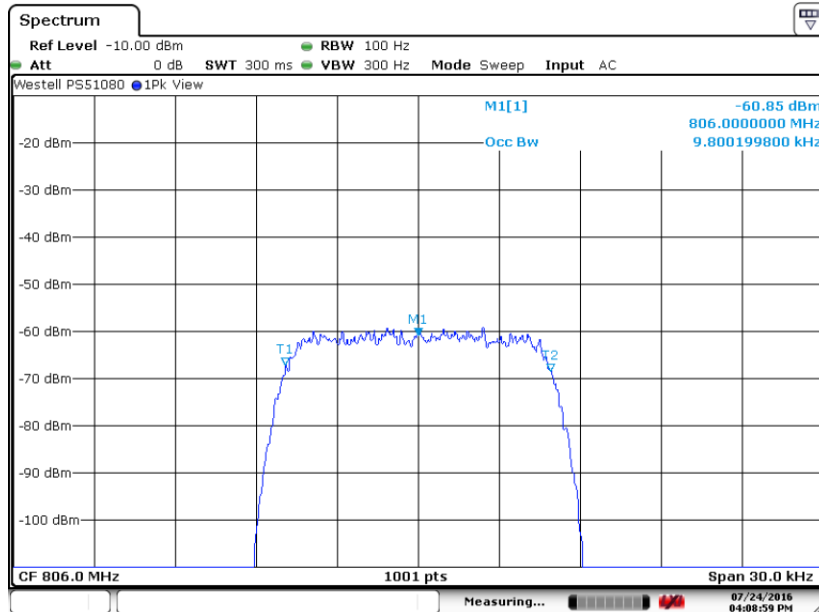

Date: 24.JUL.2016 16:08:59

6. Measurement Data (continued)

6.2. Bandwidth Limitations 90.219(e)(4)(ii), FCC Part 2.1049 (continued)

6.2.1.13. Occupied (99% Power) Bandwidth Measurement, 811 MHz, 16k FM

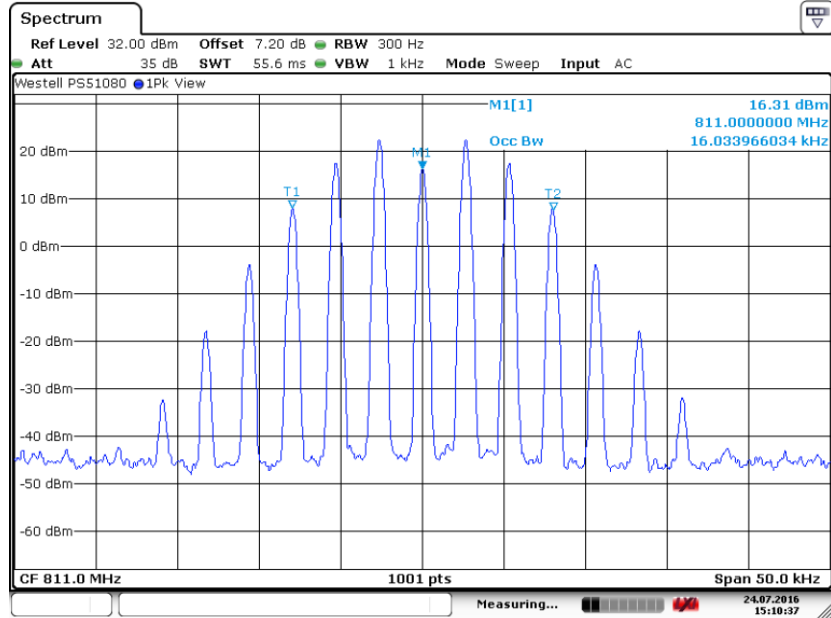

Date: 24.JUL.2016 15:10:37

6.2.1.14. Occupied (99% Power) Bandwidth Input, 811 MHz, 16k FM

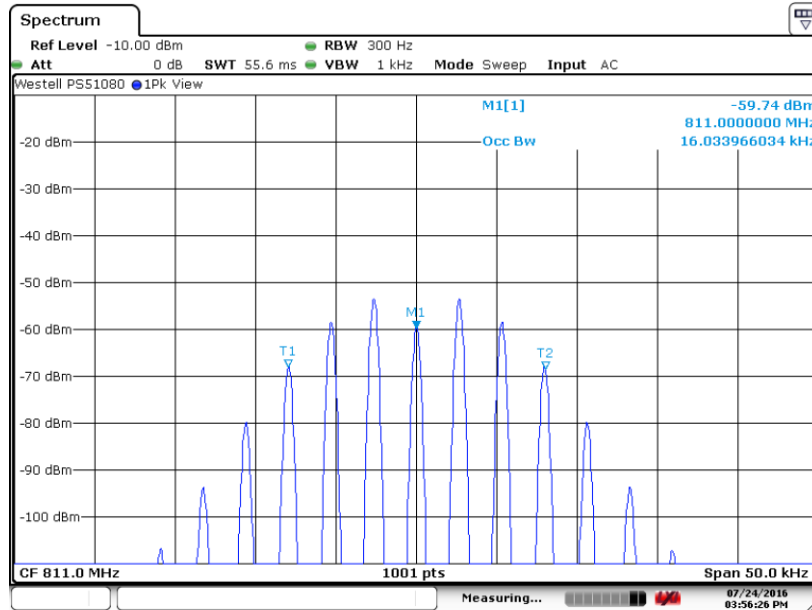

Date: 24.JUL.2016 15:56:25