

**COMPLIANCE WORLDWIDE INC.
TEST REPORT 143-16R2**

In Accordance with the Requirements of
FCC PART 90:2015 Subpart S
Operation in the 806 to 816 MHz and 851 to 861 MHz bands
FCC PART 20:2015

Issued to

Westell, Inc.
670 North Commercial Street
Manchester, NH 03101
(603) 626-6677

for

Public Safety Repeater
PS51080

FCC ID: NVRCSIPS51080PS78

Original Report Issued on April 12, 2016
Revision R2 Issued on June 24, 2016

Tested by

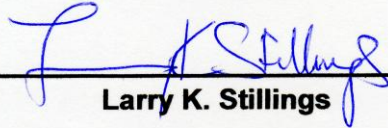

Larry K. Stillings

Reviewed By



Brian F. Breault

This test report shall not be reproduced, except in full, without written permission from Compliance Worldwide, Inc.

Table of Contents

1. Scope	3
2. Product Details	3
2.1. Manufacturer	3
2.2. Model Number	3
2.3. Serial Number	3
2.4. Description	3
2.5. Power Source	3
2.6. Software Version	3
2.7. EMC Modifications	3
3. Product Configuration	4
3.1. Support Equipment	4
3.2. Cables	4
3.3. Operational Characteristics & Software	5
3.4. Block Diagram	5
4. Measurement Parameters	6
4.1. Measurement Equipment Used to Perform Test	6
4.2. Measurement & Equipment Setup	6
4.3. Test Procedure	6
5. Measurement Summary	7
6. Measurement Data	8
6.1. Broadband Transmitting Power Limits 90.635	8
6.2. Bandwidth Limitations (FCC Part 2.1049)	28
6.3. Spurious Emissions at the Antenna Terminals 90.669	41
6.4. Field Strength of Spurious Emissions 90.669	57
6.5. Frequency Stability 90.539	61
6.6. Out of Band Rejection	62
6.7. Noise Figure	64
6.8. Emission Mask H	66
6.9. Public Exposure to Radio Frequency Energy Levels 1.1307 (b)(1)	69
7. Test Site Description	70
8. Test Setup Photographs	71
Appendix A	73

1. Scope

This test report certifies that the Westell Public Safety Repeater Model PS51080, as tested, meets the FCC Part 90 Subpart S requirements. The scope of this test report is limited to the test sample provided by the client, only in as much as that sample represents other production units. If any significant changes are made to the unit, the changes shall be evaluated and a retest may be required. Revision R1 adds noise figure measurements of the uplink and downlink bands in new section 6.7 and 90.210 (h) Emission Mask H to new section 6.8 of the test report. Revision R2 updates the report for narrowband operation in the 806 to 813.5 MHz and 851 to 858.5 MHz bands.

2. Product Details

2.1. Manufacturer: Westell, Inc.

2.2. Model Numbers: PS51080

2.3. Serial Number: 15100001

2.4. Description: The PS51080 repeater was developed for use in enclosed structures where signals from local public safety towers to operate mobile units is poor or unavailable. Adequate signal strength must be available outside the structure as a prerequisite to achieving in-building coverage. The device is connected to an external antenna, normally located on a roof, and to one or more internal antennas placed strategically throughout the area where wireless service is desired.

2.5. Power Source: 120 VAC, 60 Hz

2.6. Software Version: 1.0

2.7. EMC Modifications: None

3. Product Configuration

3.1. Support Equipment

Device	Manufacturer	Model	Serial No.	Comment
RF Signal Generator	R & S	SMIQ06B	10090	Generating W-CDMA Signals
IQ Modulation Generator	R & S	AMIQ04	100540	Generating AWS Signals
Power Supply	APX Technologies	SP130P966ER	n/a	
Notebook PC	Dell	Latitude C400	9760689253	Configuring Unit

3.2. Cables

Cable Type	Length	Shield	From	To
RF, 50 Ω , N male – N male	1M	Yes	DUT	Signal Generator
RF, 50 Ω , N male – N male	1M	Yes	DUT	50 Ω Load
Power Supply	2M + 2M	Yes	DUT	120 VAC, 60 Hz
Ethernet	2M	No	DUT	Notebook PC

Notebook PC is connected only during setup and configuration

3. Product Configuration (continued)

3.3. Operational Characteristics & Software

- (1) The unit was allowed to power up normally and go through its configuration cycle.
- (2) Using an RF Signal Generator on the Input and a Spectrum Analyzer on the output Downlink or Uplink frequencies a signal was generated over the intended bandwidth of operation.
- (3) The signal generator was configured to provide a wideband 1.25 MHz CDMA digital modulation to the input of the amplifier across the public safety bands to be used by the product.
- (4) The units internal AGC threshold was determined by applying an input signal until a 1 dB increase in input signal did not cause a 1 dB in output signal for each of the Uplink and Downlink frequencies.

3.4. Block Diagram

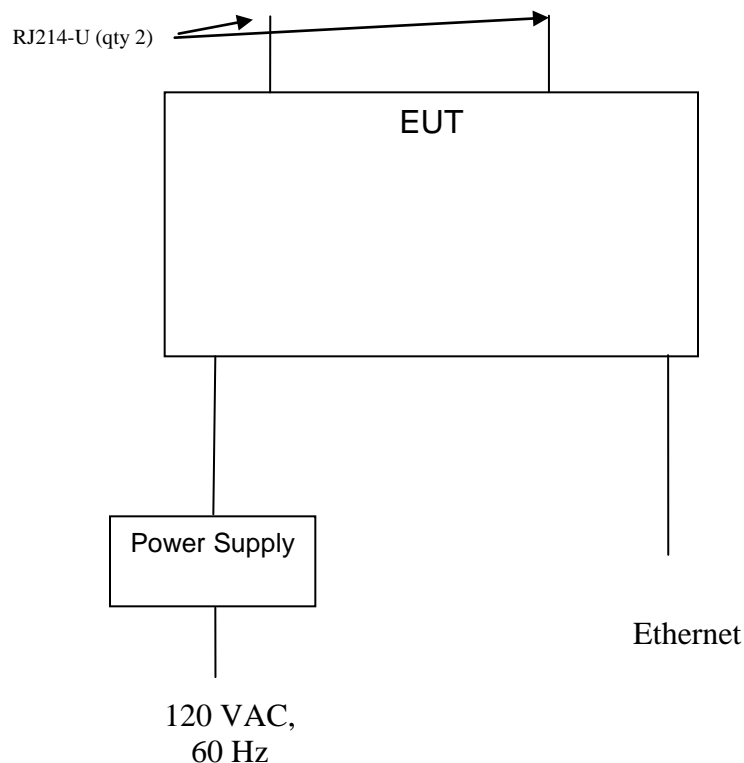

4. Measurements Parameters

4.1. Measurement Equipment Used to Perform Test

Device	Manufacturer	Model No.	Serial No.	Cal Due	Interval
EMI Test Receiver, 9kHz - 7GHz ¹	Rohde & Schwarz	ESR7	101156	7/23/2017	2 Years
Spectrum Analyzer 20 Hz – 40 GHz ²	Rohde & Schwarz	FSV40	100899	7/23/2017	2 Years
Spectrum Analyzer, 9 kHz to 40 GHz ³	Rohde & Schwarz	FSVR40	100909	7/23/2017	2 Years
EMI Receiver, 9 kHz to 6.5 GHz	Hewlett Packard	8546A	3650A00360	6/4/2016	2 Years
Biconilog Antenna, 30 MHz to 2 GHz	Sunol Sciences Corp	JB1	25509	5/15/2016	3 Years
Horn Antenna, 960 MHz – 18 GHz	Electro-Metrics	RGA-50 / 60	2813	7/15/2016	2 Years
Preamplifier, 1 GHz to 26.5 GHz	Hewlett Packard	8449B	3008A01323	7/21/2017	2 Years
Noise Source 10 MHz to 6 GHz	Micronetics	NS346B	17883	10/15/2016	1 Year
Digital Barometer	Control Company	4195	ID236	10/8/2017	2 Years

¹ ESR7 Firmware revision: V2.26, Date installed: 8/15/2014 Previous V2.17, installed 6/11/2014.
² FSV40 Firmware revision: V2.30 SP1 Date installed: 10/22/2014 Previous V2.30, installed 7/23/2014.
³ FSVR40 Firmware revision: V2.23, Date installed: 10/20/2014 Previous V1.63 SP1, installed 8/28/2013.

4.2. Measurement & Equipment Setup

Test Dates: 1/20/2016, 1/25/2016,
 2/1/2016, 2/6/2016,
 5/12/2016, 6/24/2016

Test Engineer: Larry Stillings

Normal Site Temperature (15 – 35°C): 24

Relative Humidity (20 -75%RH): 33

4.3. Test Procedure

The test measurements contained in this report are based on the requirements detailed in FCC Part 90.219 and Subpart S.

The test methods used to generate the data in this test report are in accordance with ANSI C63.4:2014, American National Standard for Methods of Measurement of Radio-Noise Emissions from Low-Voltage Electrical and Electronic Equipment in the Range of 9 kHz to 40 GHz, FCC OET KDB 935210 D05 Indus Booster Basic Meas v01 dated 2-12-2016, Measurements Guidance for Industrial and Non-Consumer Signal Booster, Repeater and Amplifier Devices and FCC OET KDB 971168 D01 Power Meas License Digital Systems v02r02 dated 10-17-2014.

Measurements were also made in accordance with TIA-603-C:2004 Land Mobile FM or PM Communications Equipment Measurement and Performance Standard.

5. Measurement Summary

Section Description or Test Requirement	FCC Part 90 Reference	Test Report Section	Result	Comment
Limitations on power and antenna height	90.219(e)(1) 90.635	6.1	Compliant	
Occupied Bandwidth	90.219(e)(4)(ii) Part 2.1049	6.2	Compliant	
Spurious Emissions at Antenna Terminals	90.219(e)(3) 90.543	6.3	Compliant	
Field Strength of Spurious Emissions	90.219(e)(3) 90.543	6.4	Compliant	
Frequency Stability	90.213	6.5	N/A	The EUT does not translate the frequency of the input signal
Out of Band Rejection	N/A	6.6	Compliant	
Noise Figure	90.219(e)(2)	6.7	Compliant	
Emission Mask H	90.210(h)	6.8	Compliant	
Public Exposure to Radio Frequency Energy Levels	Section 1.1307 (b)(1)	6.9	Compliant	

6. Measurement Data

6.1. Limitations on power and antenna height 90.219(e)(1), 90.635

Requirement: The transmitter output power of mobile and control transmitters operating in the 806 to 824 MHz, 851 to 869 MHz, 896 to 901 MHz and 935 to 940 MHz bands must not exceed 1 kilowatt (30 dBw) and 304 meters (1,000 ft) above average terrain.

Test Method: KDB 935210 Section 3.5 & KDB 971168 Section 5.2

6.1.1. Mean Transmitter Output Power, Transmitter Only

Description of Measurement	Center Frequency	Output Power	
	(MHz)	(dBm)	(Watts)
Output Power	807	28.04	0.637
Output Power	811	27.39	0.548
Output Power	815	26.13	0.410
Output Power	852	26.79	0.478
Output Power	856	26.96	0.497
Output Power	860	27.20	0.525
3 dB Above AGC	807	30.58	1.143
3 dB Above AGC	811	29.81	0.957
3 dB Above AGC	815	28.73	0.746
3 dB Above AGC	852	29.52	0.895
3 dB Above AGC	856	29.70	0.933
3 dB Above AGC	860	30.07	1.016
Input Power	807	-55.72	0.000
Input Power	811	-55.73	0.000
Input Power	815	-55.89	0.000
Input Power	852	-52.94	0.000
Input Power	856	-52.97	0.000
Input Power	860	-53.00	0.000

Note: Input Power is at the 1 dB AGC threshold Level

6. Measurement Data

6.1. Limitations on power and antenna height 90.219(e)(1), 90.635 (cont)

6.1.2. Mean Transmitter Output Power, 807 MHz

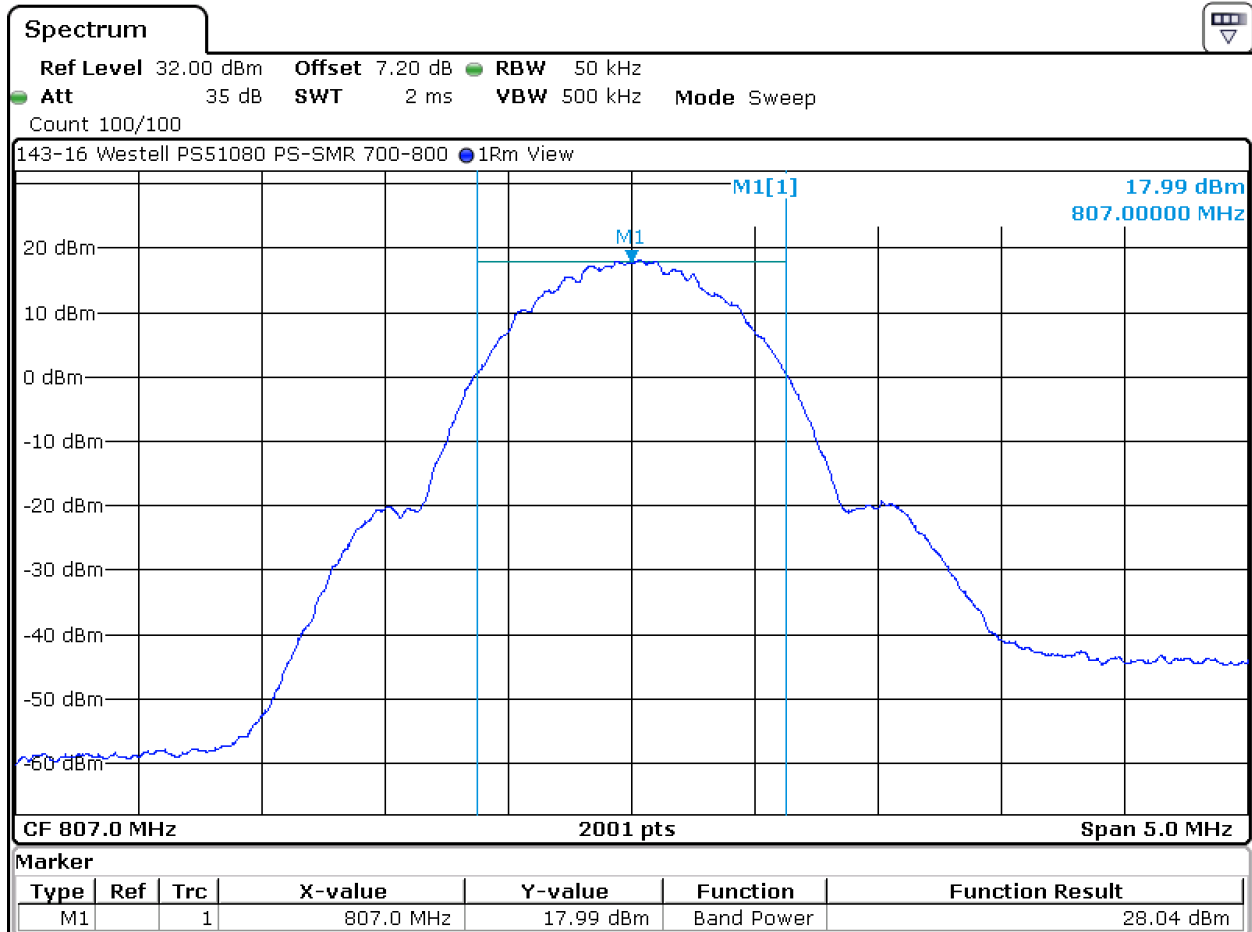

Date: 25.JAN.2016 14:35:24

6. Measurement Data

6.1. Limitations on power and antenna height 90.219(e)(1), 90.635 (cont)

6.1.3. Mean Transmitter Output Power, 811 MHz

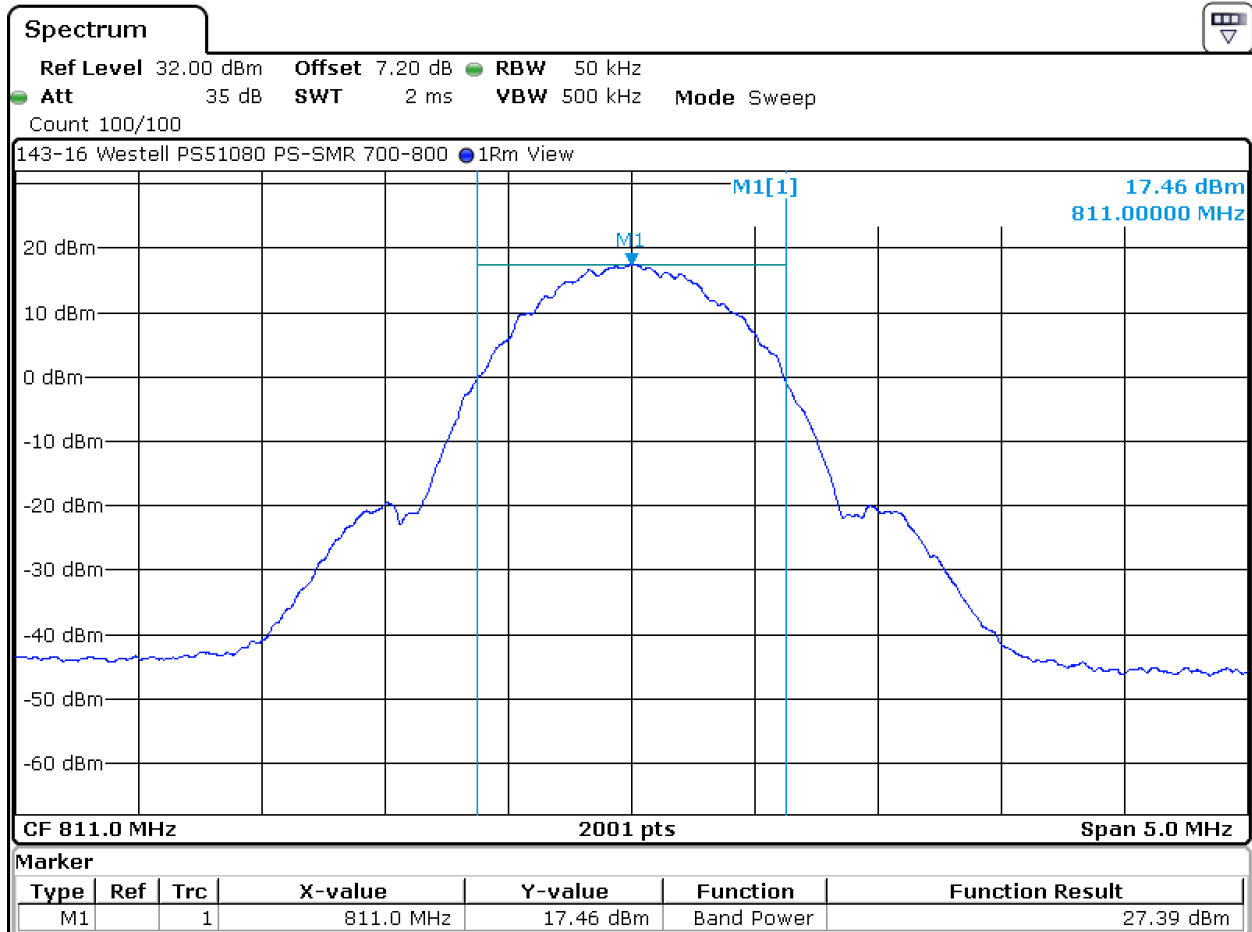

Date: 25.JAN.2016 14:34:12

6. Measurement Data

6.1. Limitations on power and antenna height 90.219(e)(1), 90.635 (cont)

6.1.4. Mean Transmitter Output Power, 815 MHz

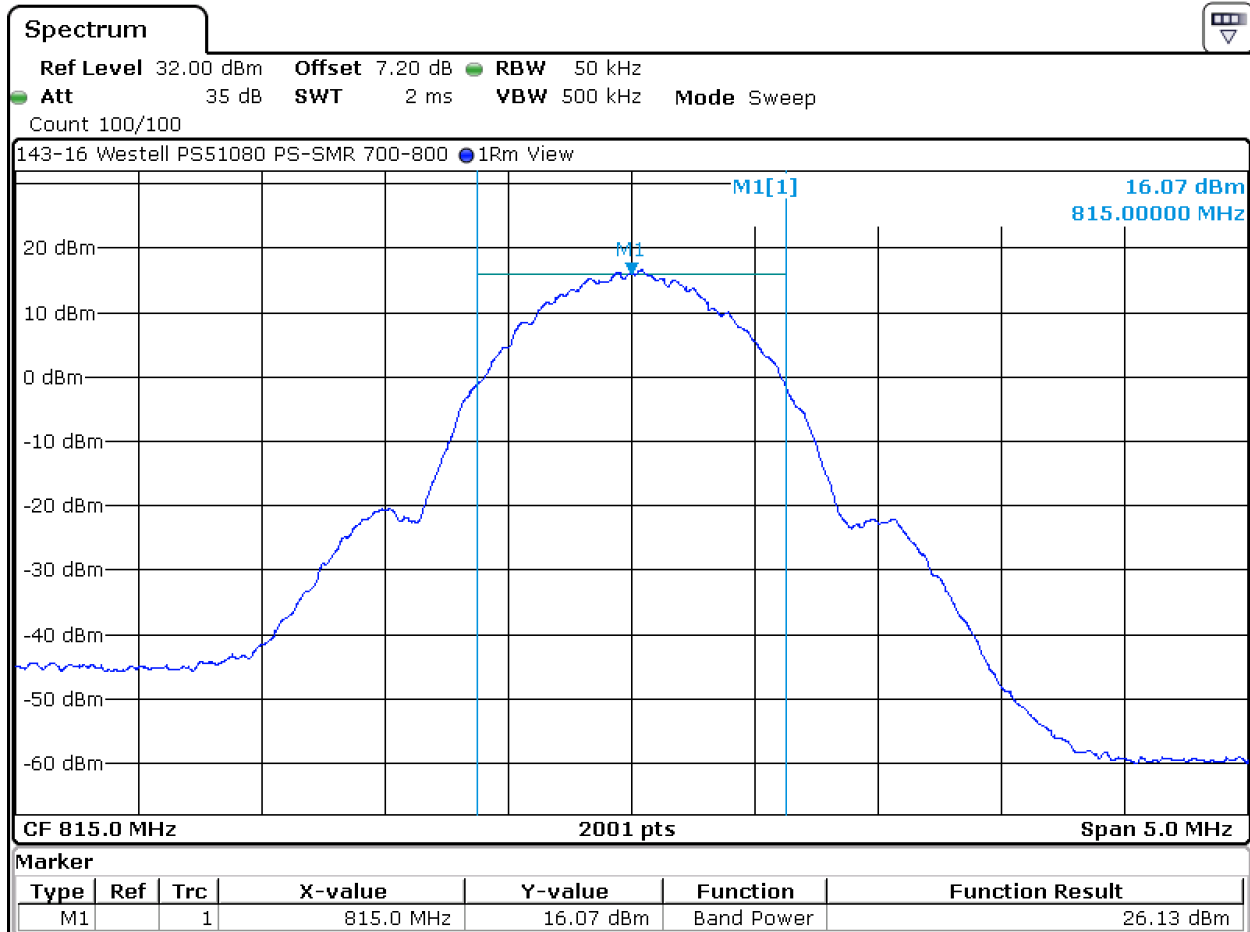

Date: 25.JAN.2016 14:36:24

6. Measurement Data

6.1. Limitations on power and antenna height 90.219(e)(1), 90.635 (cont)

6.1.5. Mean Transmitter Output Power, 852 MHz

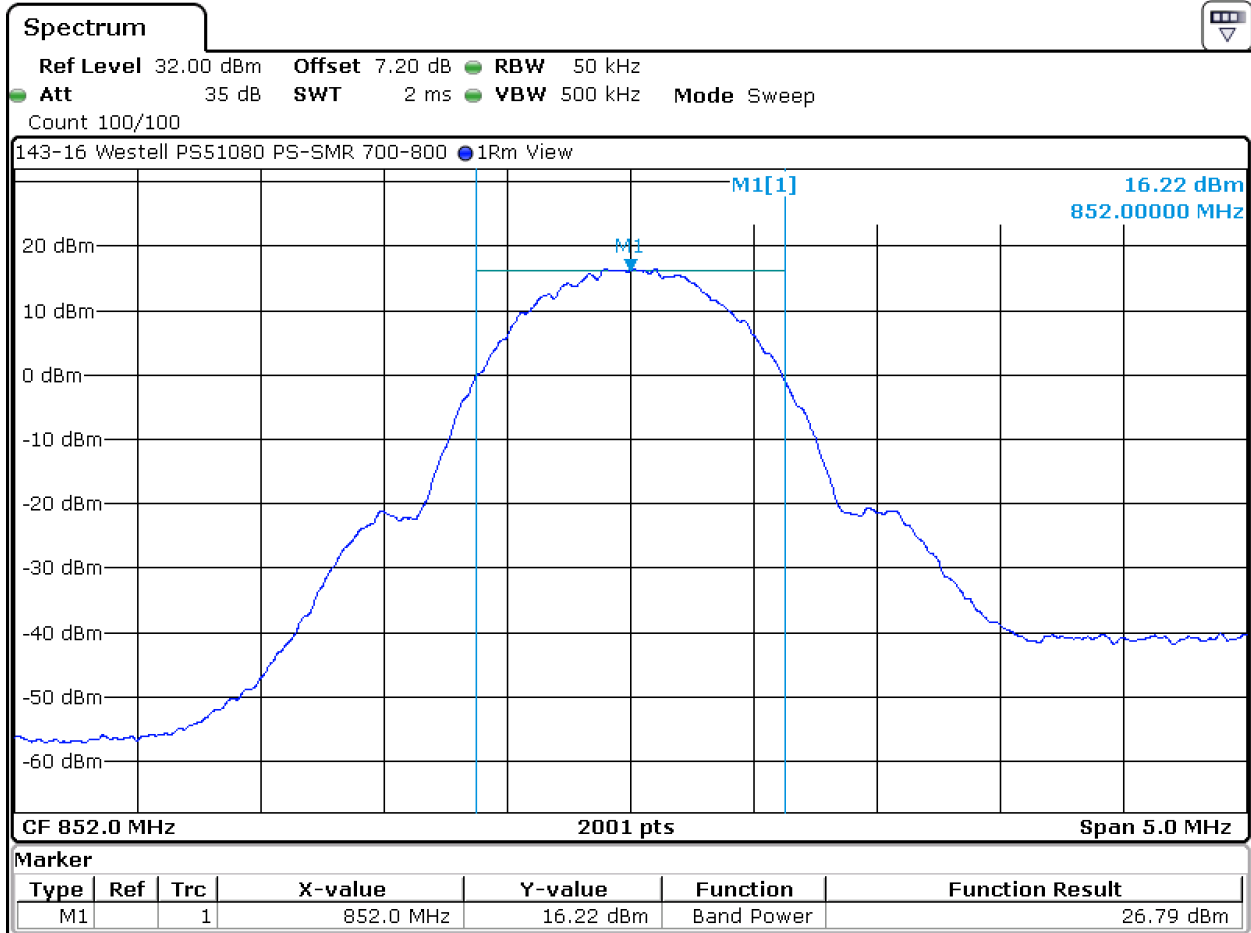

Date: 20.JAN.2016 16:09:58

6. Measurement Data

6.1. Limitations on power and antenna height 90.219(e)(1), 90.635 (cont)

6.1.6. Mean Transmitter Output Power, 856 MHz

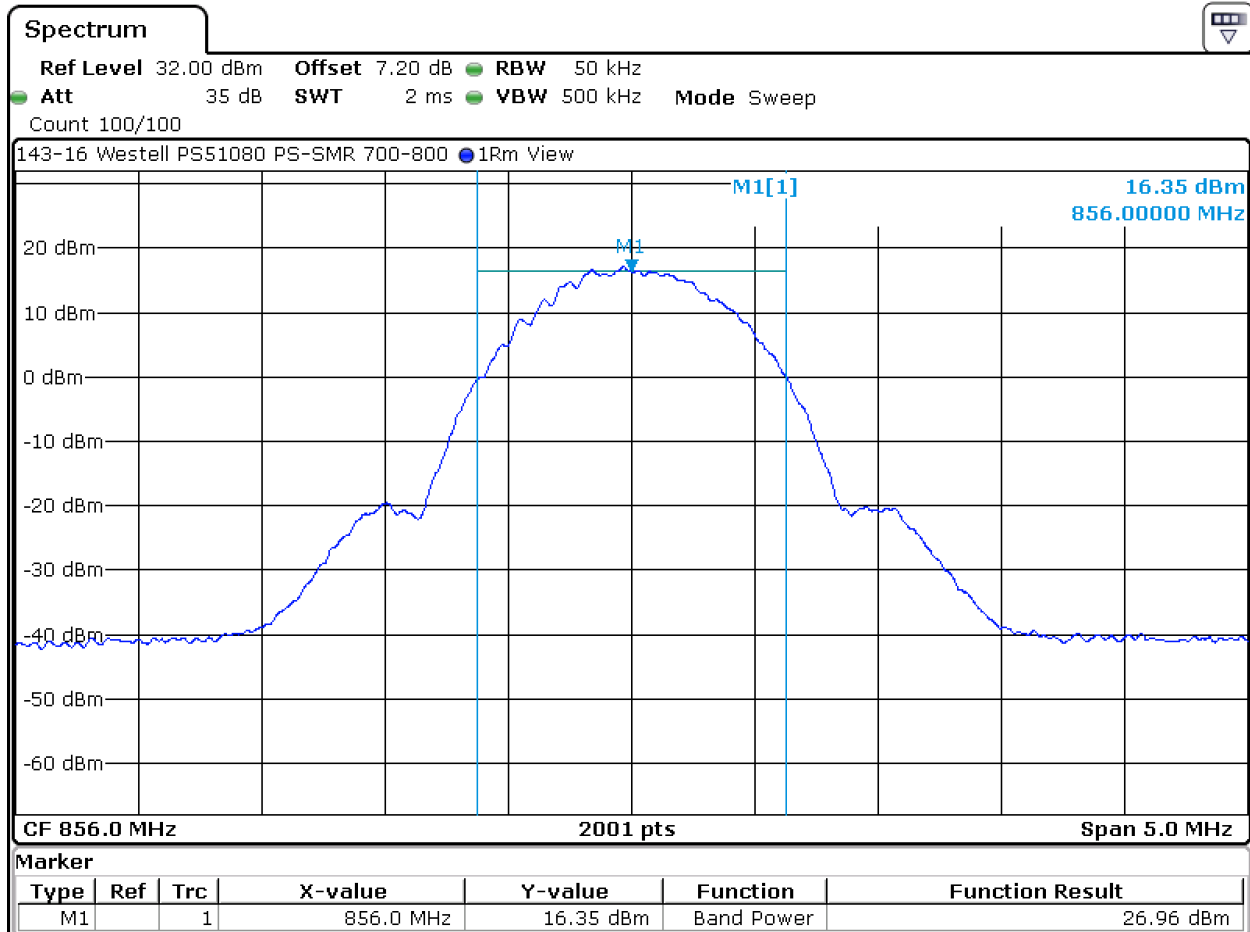

Date: 20.JAN.2016 16:08:50

6. Measurement Data

6.1. Limitations on power and antenna height 90.219(e)(1), 90.635 (cont)

6.1.7. Mean Transmitter Output Power, 860 MHz

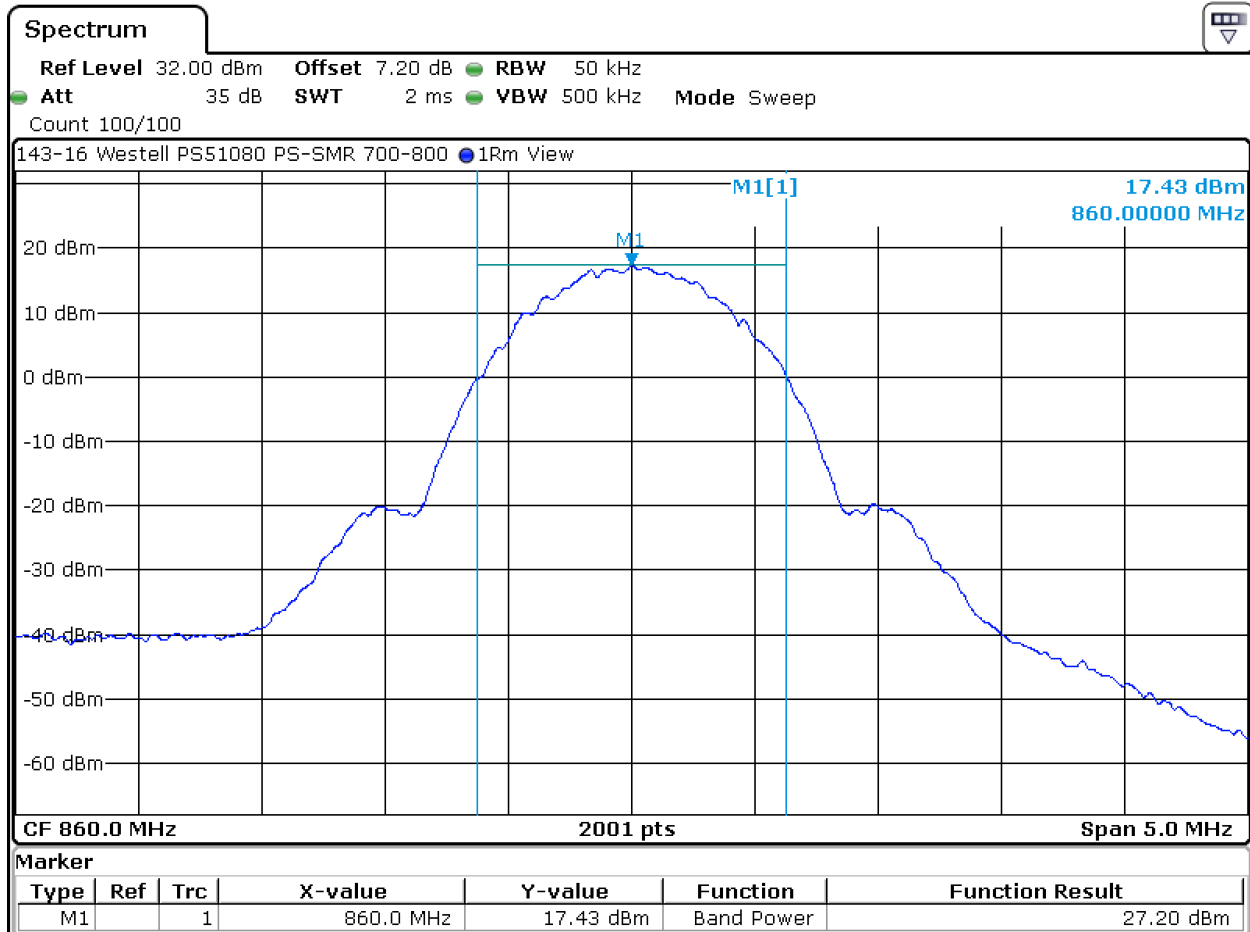

Date: 20.JAN.2016 16:11:05

6. Measurement Data

6.1. Limitations on power and antenna height 90.219(e)(1), 90.635 (cont)

6.1.8. Mean Transmitter Output Power, 807 MHz – 3 dB Increase to Input

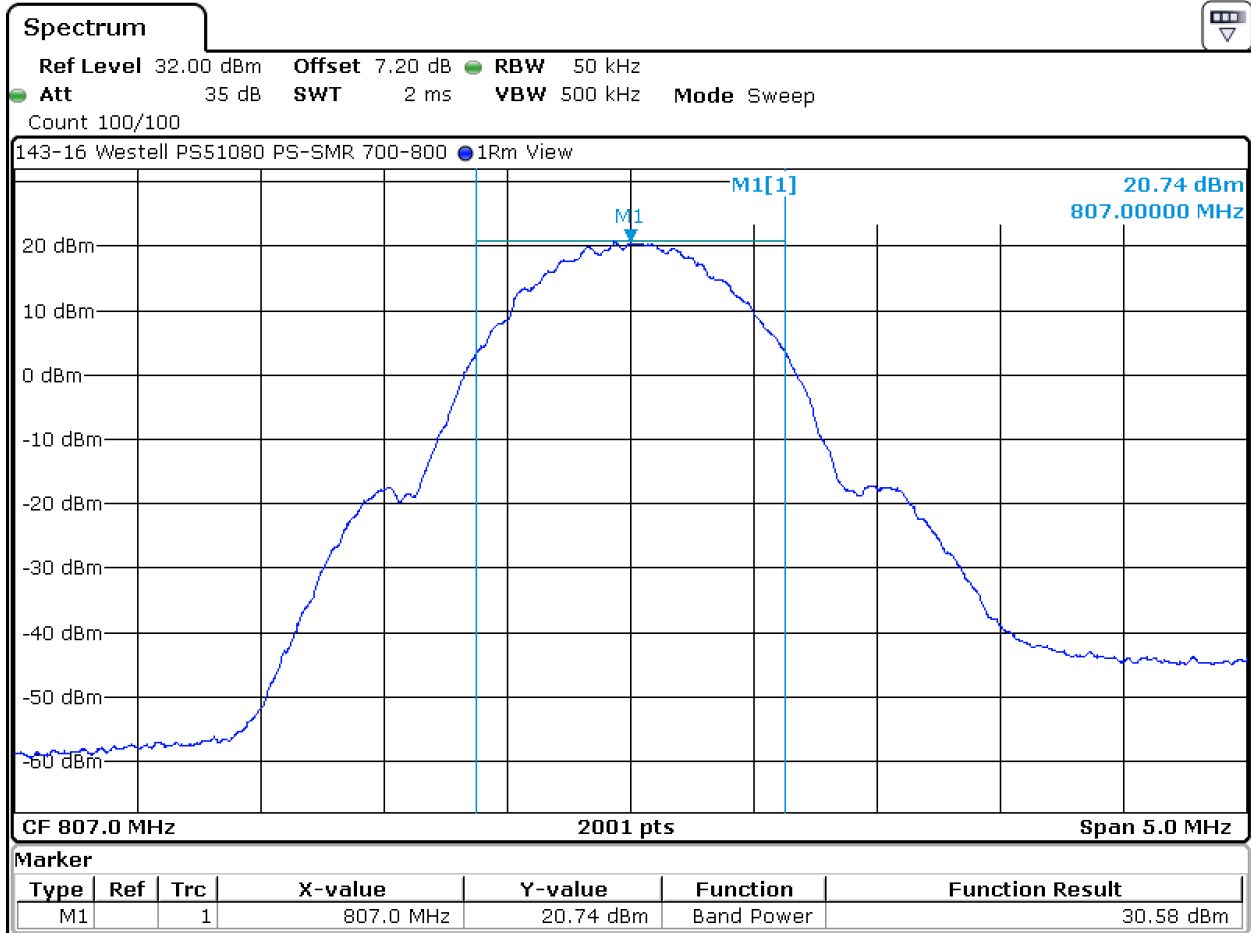

Date: 25.JAN.2016 14:39:33

6. Measurement Data

6.1. Limitations on power and antenna height 90.219(e)(1), 90.635 (cont)

6.1.9. Mean Transmitter Output Power, 811 MHz – 3 dB Increase to Input

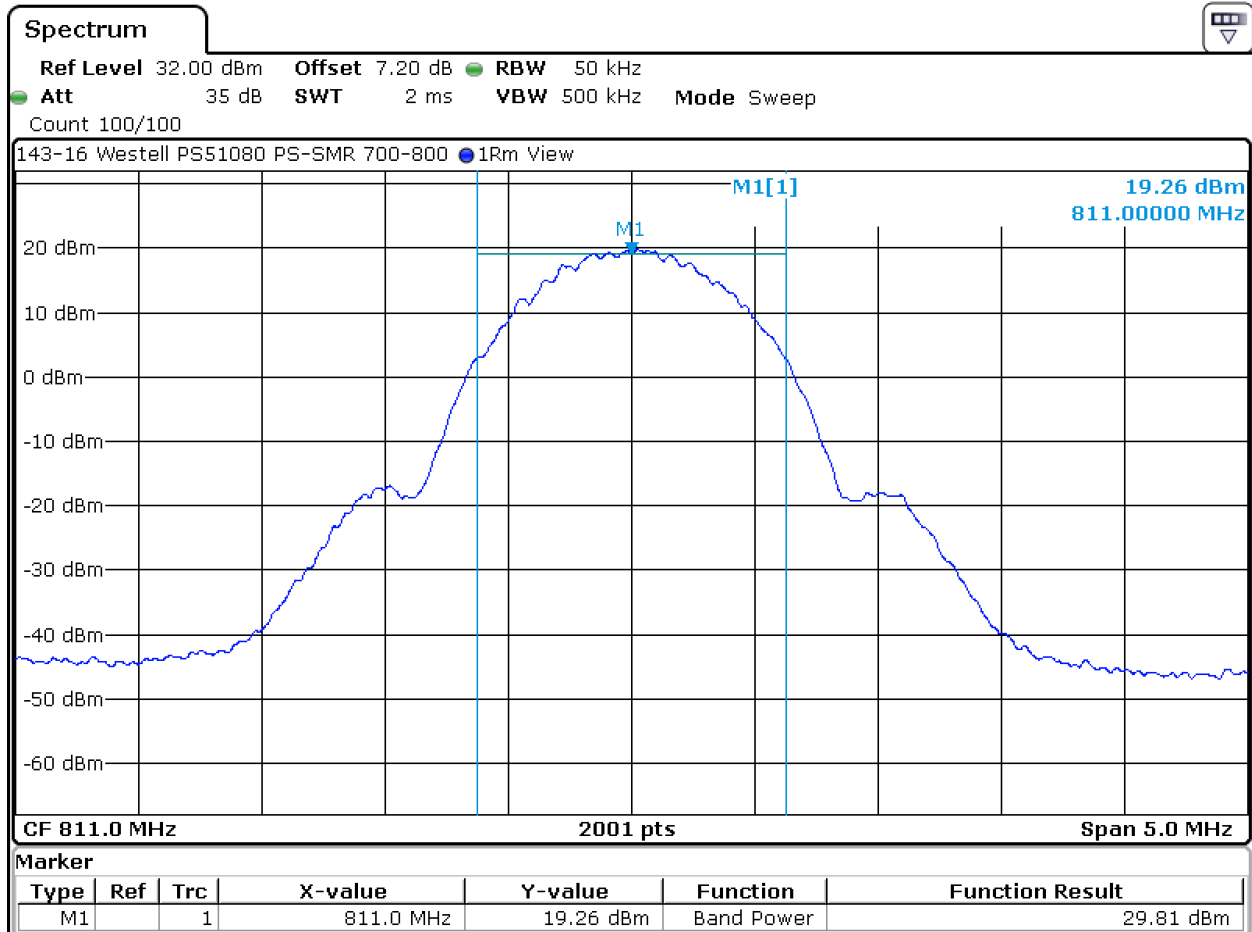

Date: 25.JAN.2016 14:38:37

6. Measurement Data

6.1. Limitations on power and antenna height 90.219(e)(1), 90.635 cont.

6.1.10. Mean Transmitter Output Power, 815 MHz – 3 dB Increase to Input

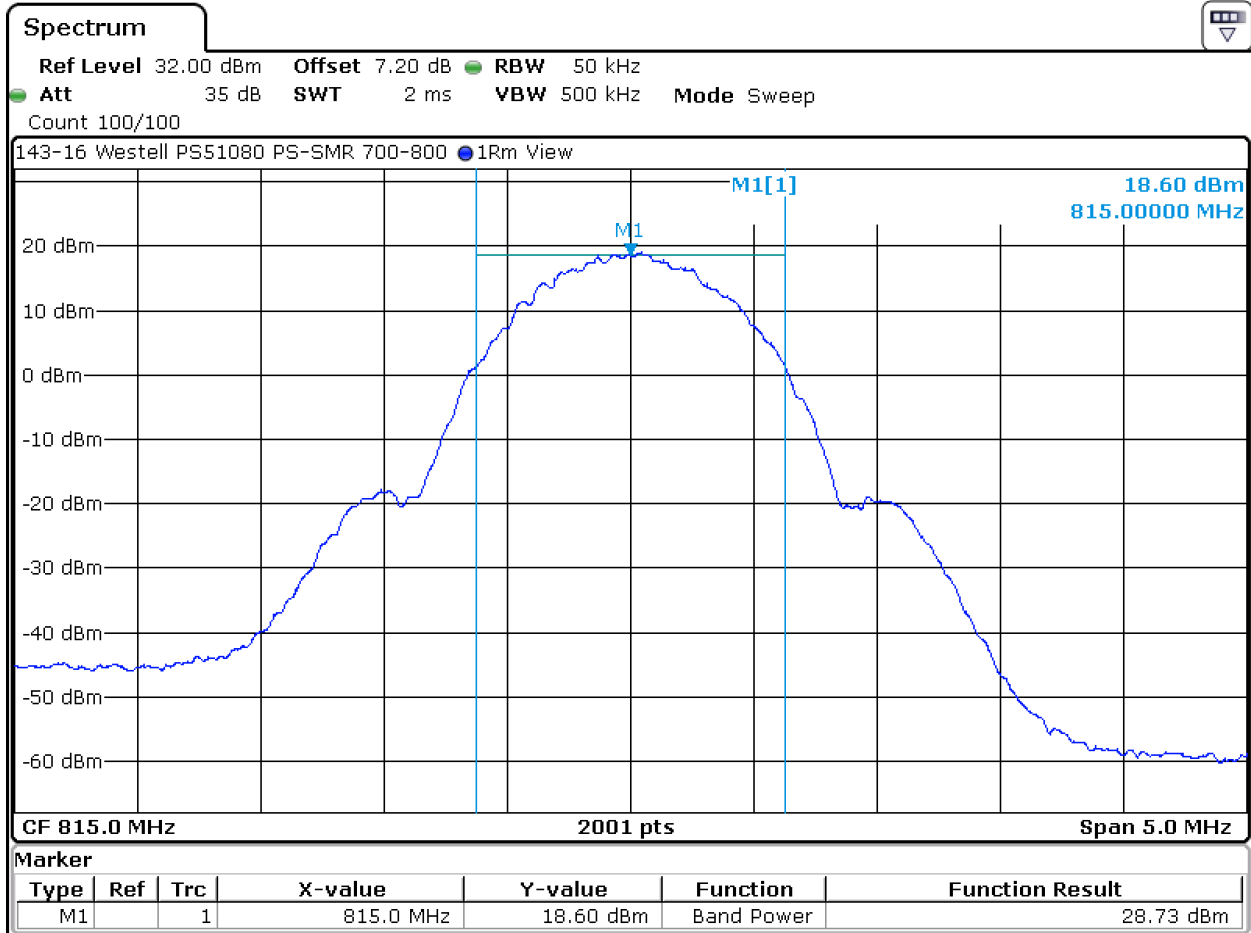

Date: 25.JAN.2016 14:37:41

6. Measurement Data

6.1. Limitations on power and antenna height 90.219(e)(1), 90.635 cont.

6.1.11. Mean Transmitter Output Power, 852 MHz – 3 dB Increase to Input

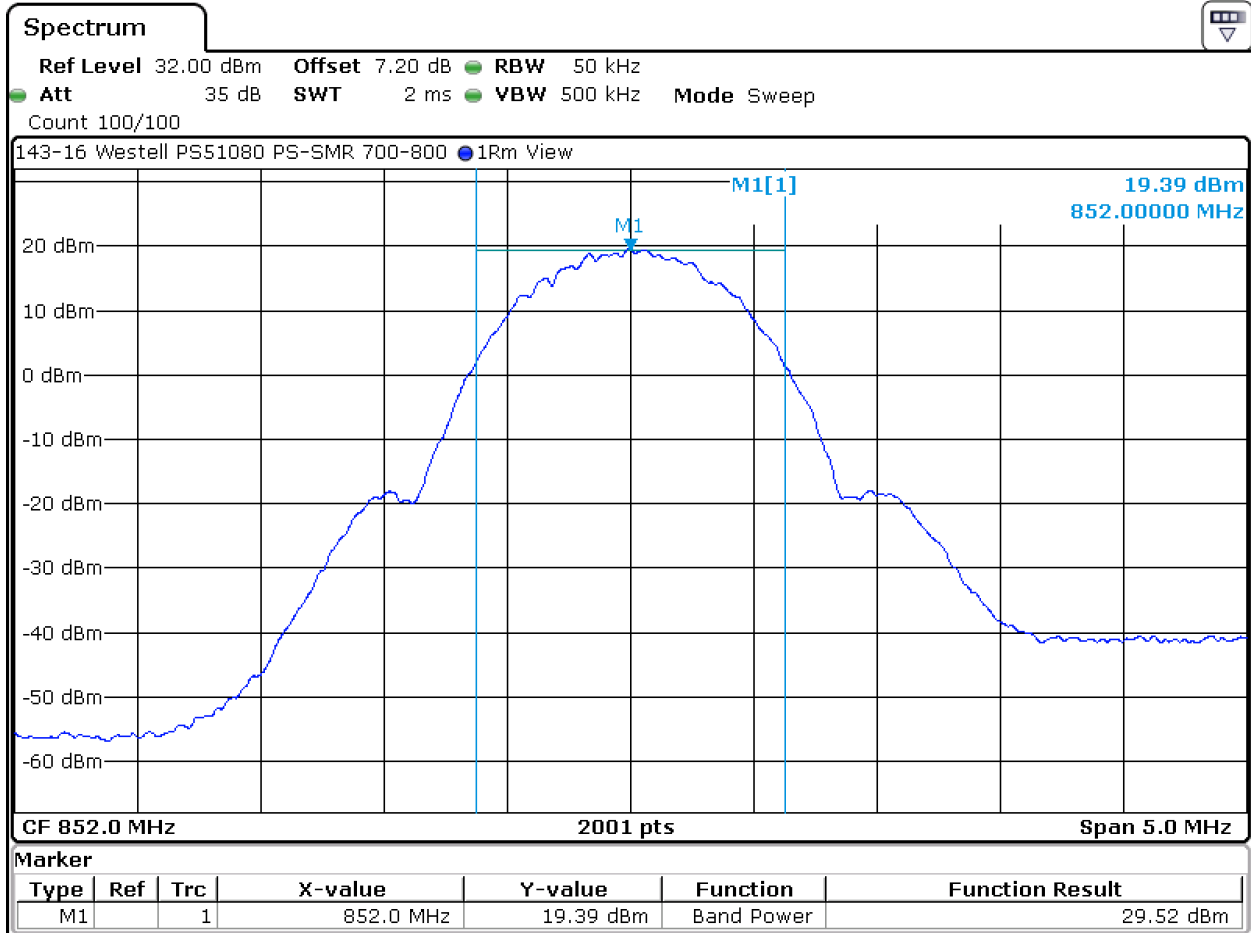

Date: 20.JAN.2016 16:14:35

6. Measurement Data

6.1. Limitations on power and antenna height 90.219(e)(1), 90.635 (cont)

6.1.12. Mean Transmitter Output Power, 856 MHz – 3 dB Increase to Input

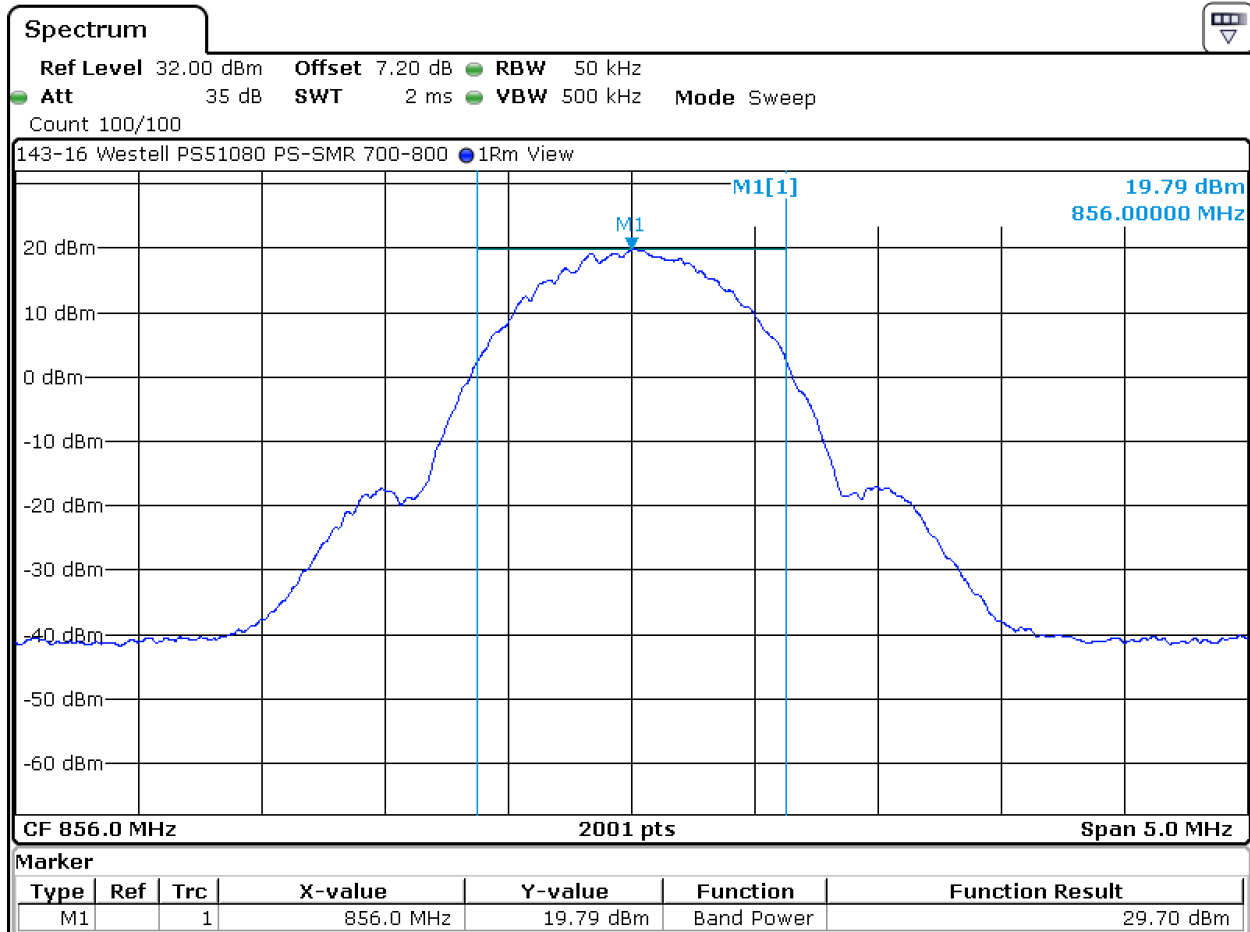

Date: 20.JAN.2016 16:13:49

6. Measurement Data

6.1. Limitations on power and antenna height 90.219(e)(1), 90.635 (cont)

6.1.13. Mean Transmitter Output Power, 860 MHz – 3 dB Increase to Input

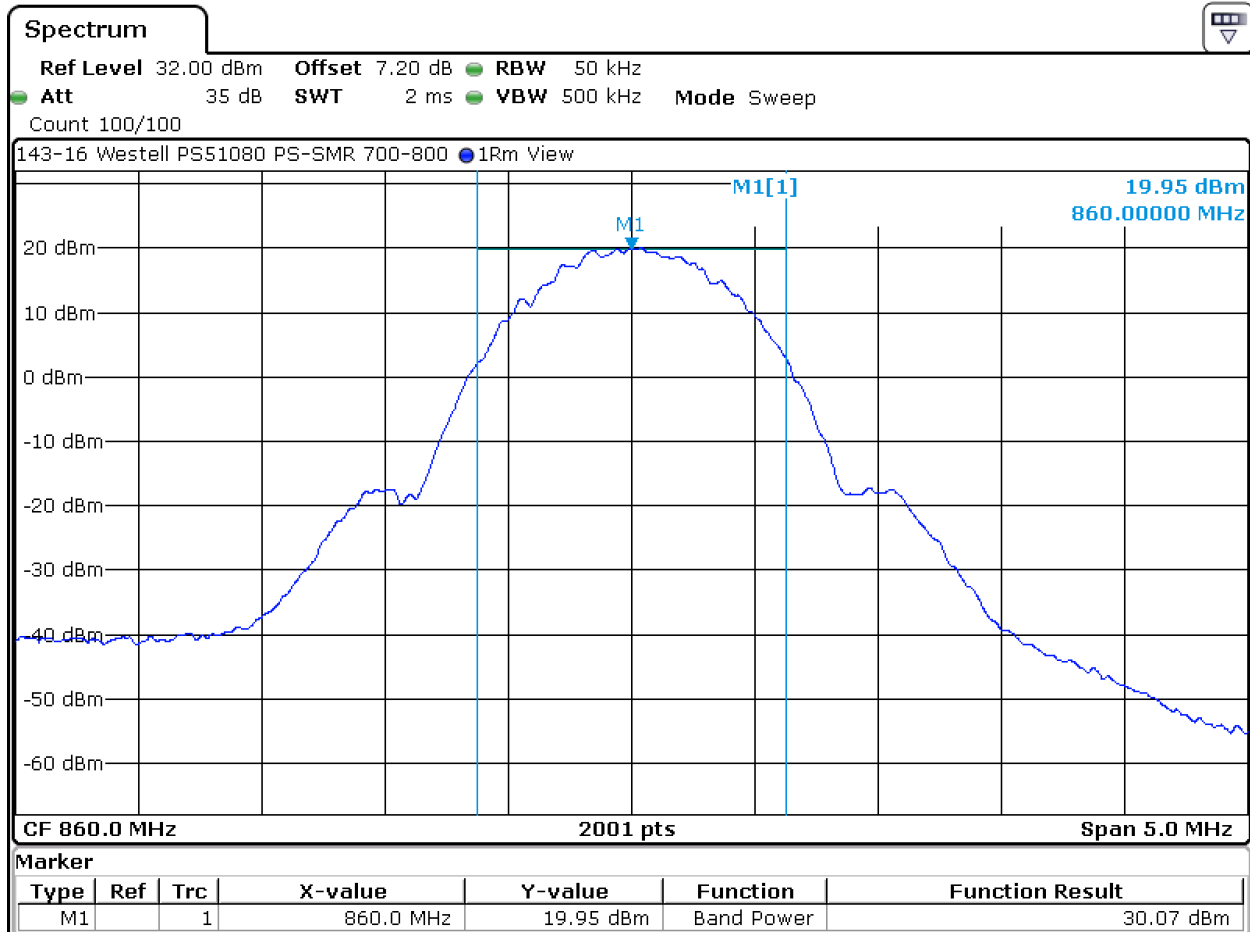

Date: 20.JAN.2016 16:12:51

6. Measurement Data

6.1. Limitations on power and antenna height 90.219(e)(1), 90.635 (cont)

6.1.14. Mean Transmitter Output Power, 807 MHz – Input Power

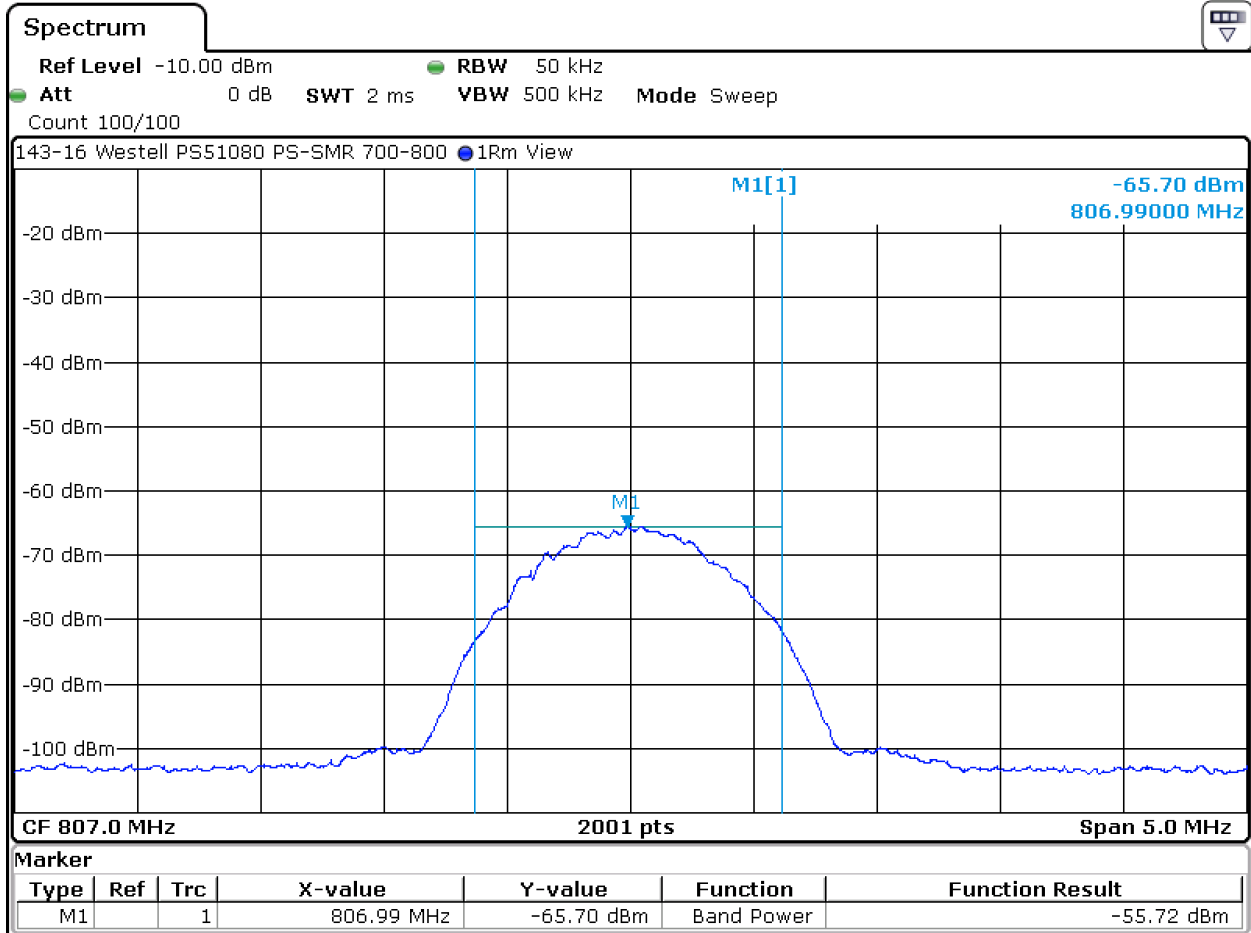

Date: 20.JAN.2016 17:30:59

6. Measurement Data

6.1. Limitations on power and antenna height 90.219(e)(1), 90.635 (cont)

6.1.15. Mean Transmitter Output Power, 811 MHz – Input Power

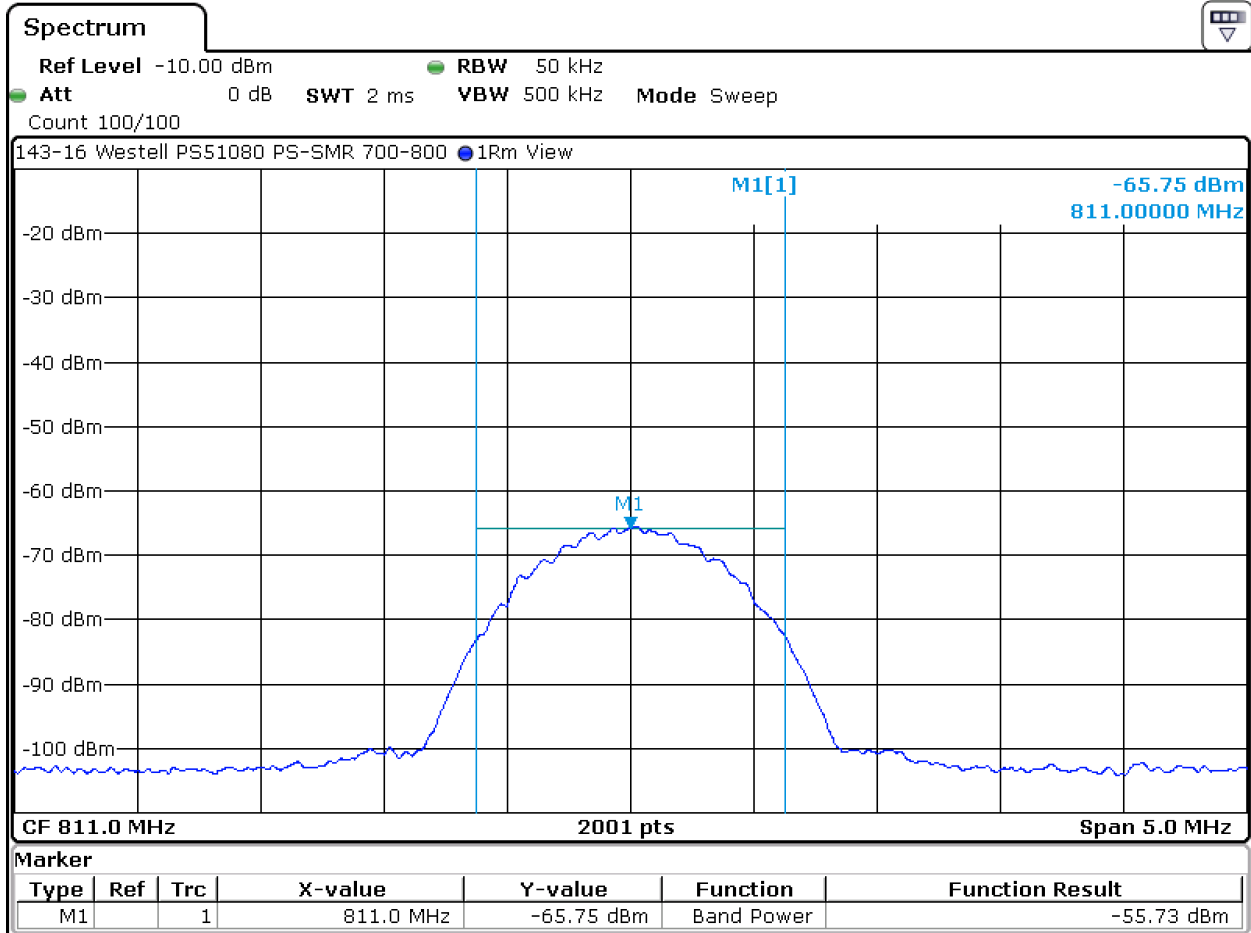

Date: 20.JAN.2016 17:31:54

6. Measurement Data

6.1. Limitations on power and antenna height 90.219(e)(1), 90.635 (cont)

6.1.16. Mean Transmitter Output Power, 815 MHz – Input Power

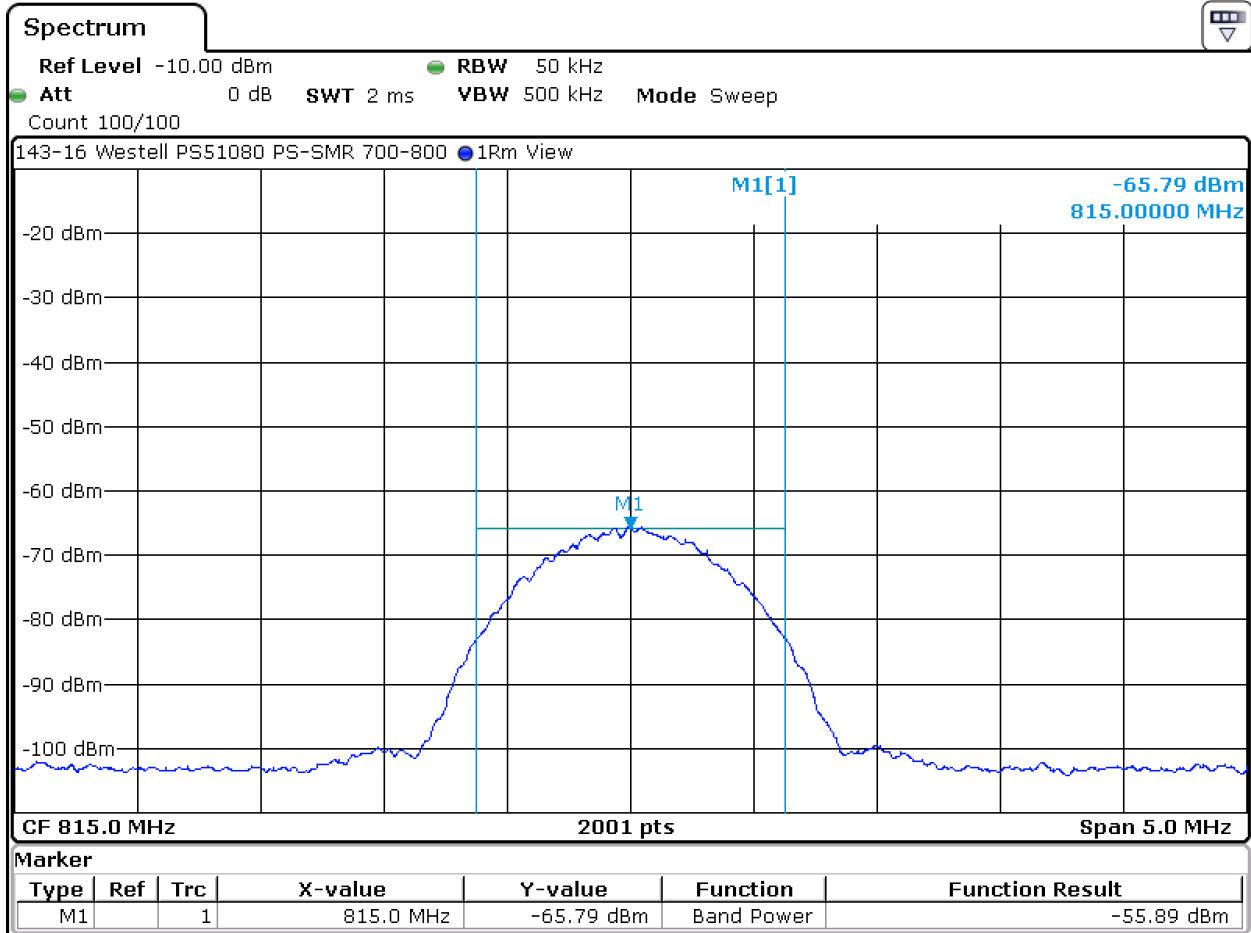

Date: 20.JAN.2016 17:32:40

6. Measurement Data

6.1. Limitations on power and antenna height 90.219(e)(1), 90.635 (cont)

6.1.17. Mean Transmitter Output Power, 852 MHz – Input Power

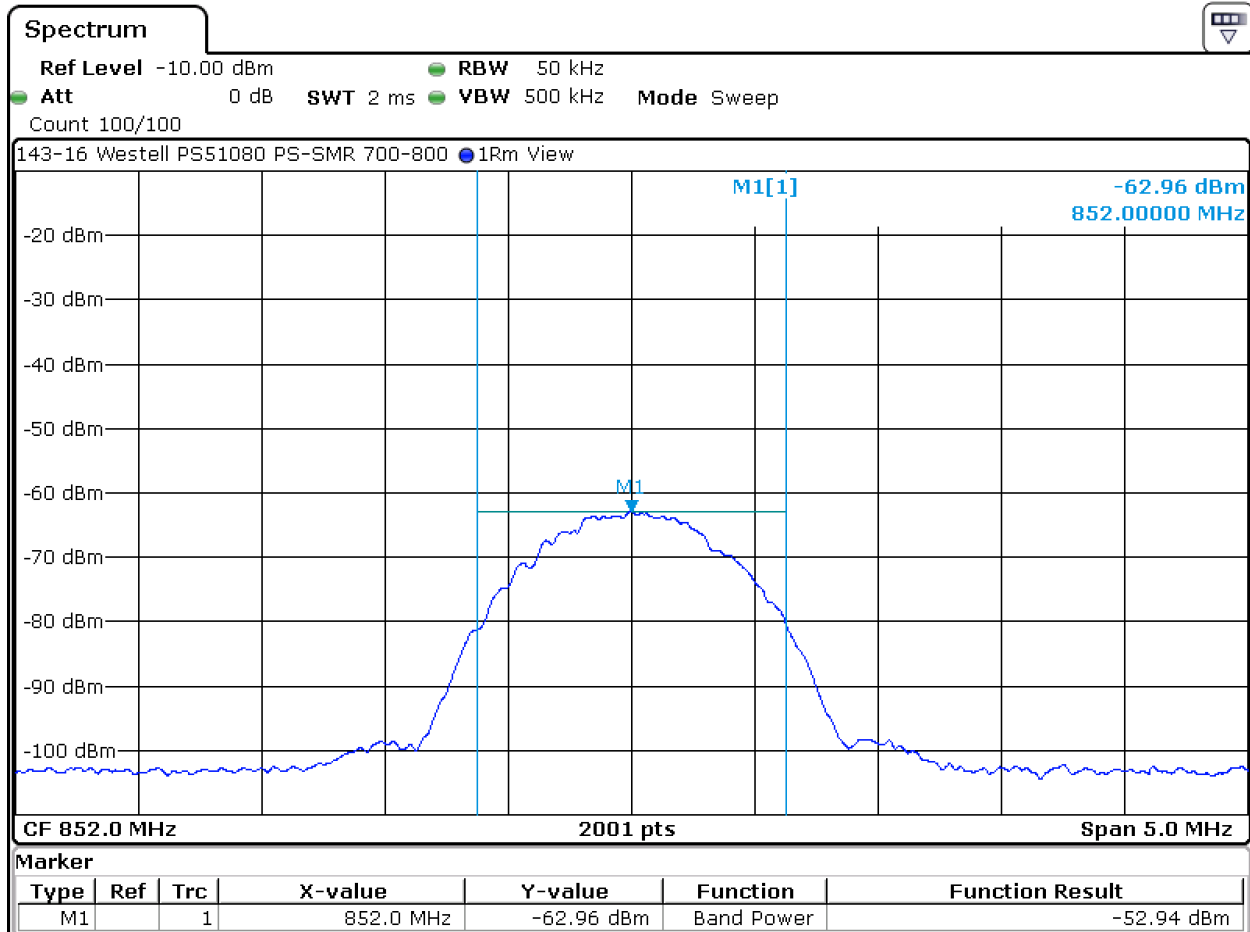

Date: 20.JAN.2016 16:36:05

6. Measurement Data

6.1. Limitations on power and antenna height 90.219(e)(1), 90.635 (cont)

6.1.18. Mean Transmitter Output Power, 856 MHz – Input Power

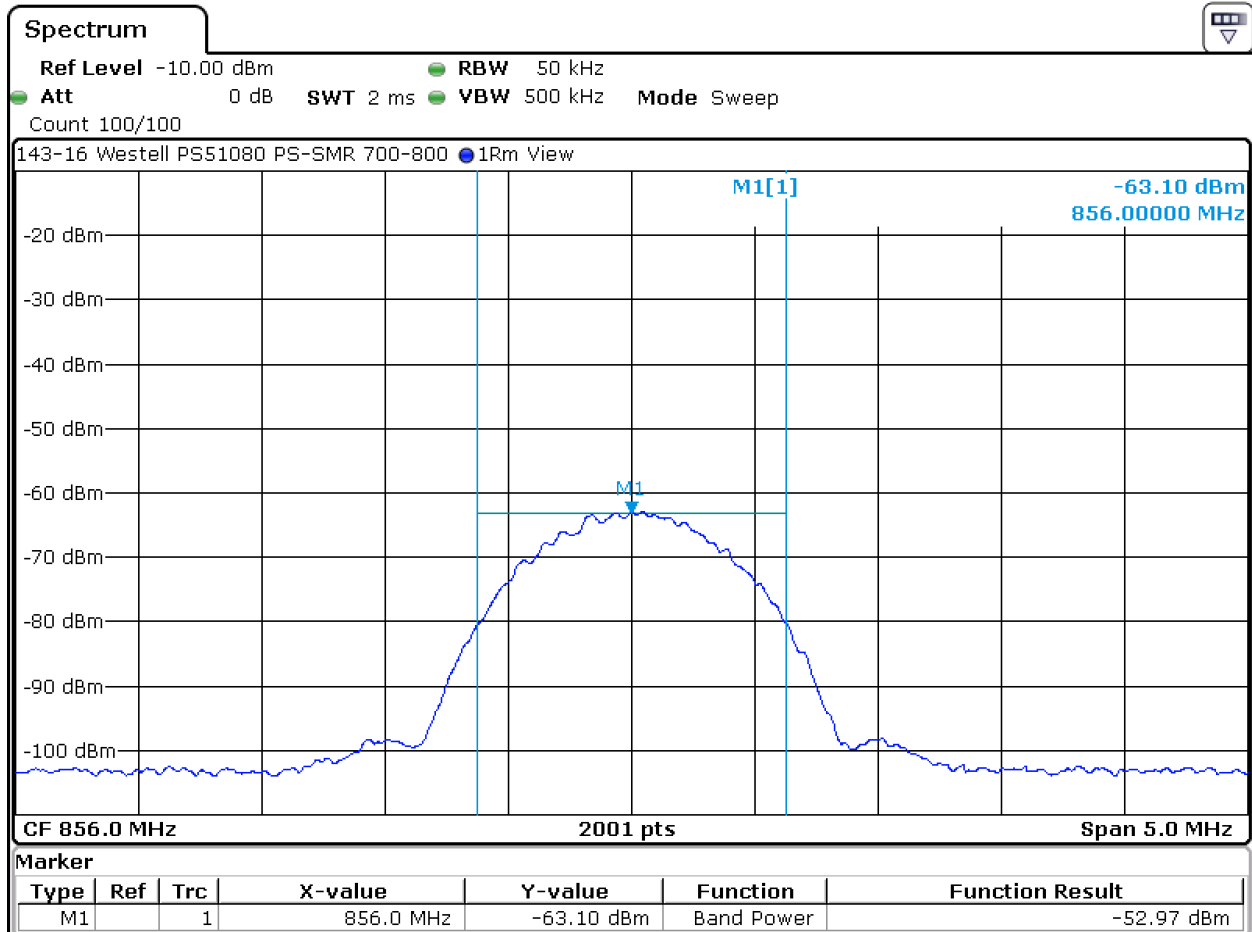

Date: 20.JAN.2016 16:37:21

6. Measurement Data

6.1. Limitations on power and antenna height 90.219(e)(1), 90.635 (cont)

6.1.19. Mean Transmitter Output Power, 860 MHz – Input Power

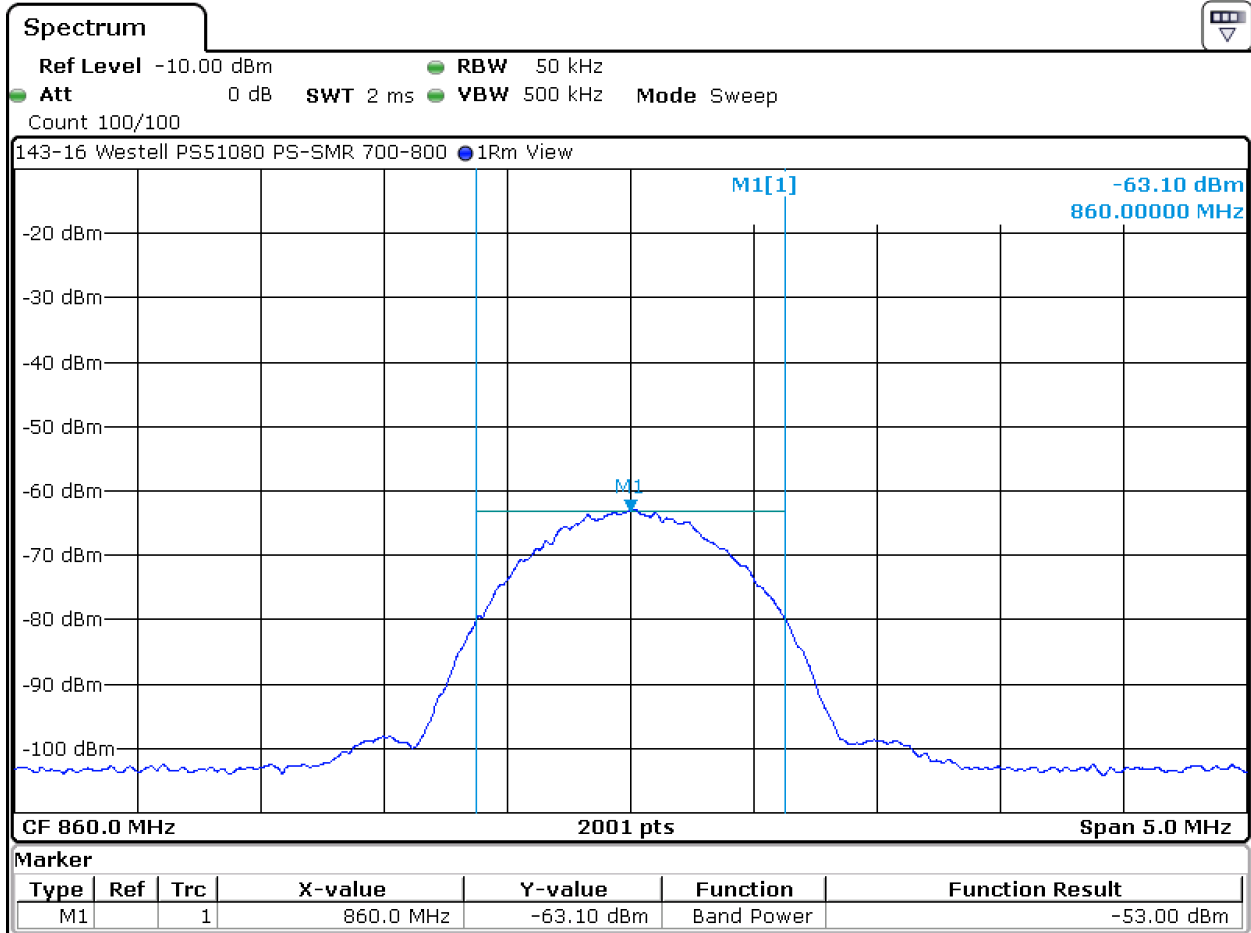

Date: 20.JAN.2016 16:38:22

6. Measurement Data

6.1. Limitations on power and antenna height 90.219(e)(1), 90.635 (continued)

6.1.2. Maximum ERP

ERP is defined in FCC Title 47, Chapter I, Part 2, Subpart A, Section 2.1 as "Effective Radiated Power. The product of the power supplied to the antenna and its gain relative to a half-wave dipole in a given direction."

$$\text{ERP} = \text{Transmitter Power (dBm)} - \text{Cable Loss (dB)} + \text{Antenna Gain (dBi)}$$

The manufacturer of the device under test recommends one antenna and cable combination for use with their product. The following table provides the worst case effective radiated power based on the measured transmitter output power and the antenna gain:

Description of Measurement	Center Frequency	Transmitter Power ¹	Cable Insertion Loss	Antenna Gain ²	Total Output Power	
	(MHz)	(dBm)	(dB)	(dBi)	(dBm)	(Watts)
Output Power	807	28.04	0.00	3.00	31.04	1.27
Output Power	811	27.39	0.00	3.00	30.39	1.09
Output Power	815	26.13	0.00	3.00	29.13	0.82
Output Power	852	26.79	0.00	3.00	29.79	0.95
Output Power	856	26.96	0.00	3.00	29.96	0.99
Output Power	860	27.20	0.00	3.00	30.20	1.05
3 dB Above AGC	807	30.58	0.00	3.00	33.58	2.28
3 dB Above AGC	811	29.81	0.00	3.00	32.81	1.91
3 dB Above AGC	815	28.73	0.00	3.00	31.73	1.49
3 dB Above AGC	852	29.52	0.00	3.00	32.52	1.79
3 dB Above AGC	856	29.70	0.00	3.00	32.70	1.86
3 dB Above AGC	860	30.07	0.00	3.00	33.07	2.03

¹ Measured. See section 6.1.1.

² Customer supplied 3 dBi. Factor is a combination of both antenna gain and cable loss.

6. Measurement Data (continued)

6.2. Bandwidth Limitations 90.219(e)(4)(ii), FCC Part 2.1049

Requirement: Each authorization issued to a station licensed under this part will show an emission designator representing the class of emission authorized. The designator will be prefixed by a specified necessary bandwidth. This number does not necessarily indicate the bandwidth occupied by the emission at any instant.

There is no change in the occupied bandwidth of the retransmitted signal.

Test Method: KDB 935210 Section 3.4

6.2.1. Occupied (99% Power) Bandwidth

Description of Measurement	Center Frequency	Occupied Bandwidth	Result
	MHz	MHz	
Output	807	0.1099	Compliant
Output	811	0.1099	Compliant
Output	815	1.1419	Compliant
Output	852	0.1099	Compliant
Output	856	0.1099	Compliant
Output	860	1.1419	Compliant
Input	807	0.1129	Compliant
Input	811	0.1129	Compliant
Input	815	1.1969	Compliant
Input	852	0.1129	Compliant
Input	856	0.1129	Compliant
Input	860	1.1669	Compliant

Test Number: 143-16R2

Issue Date: 6/24/2016

6. Measurement Data (continued)

6.2. Bandwidth Limitations 90.219(e)(4)(ii), FCC Part 2.1049 (continued)

6.2.1.1. Occupied (99% Power) Bandwidth Measurement, 807 MHz

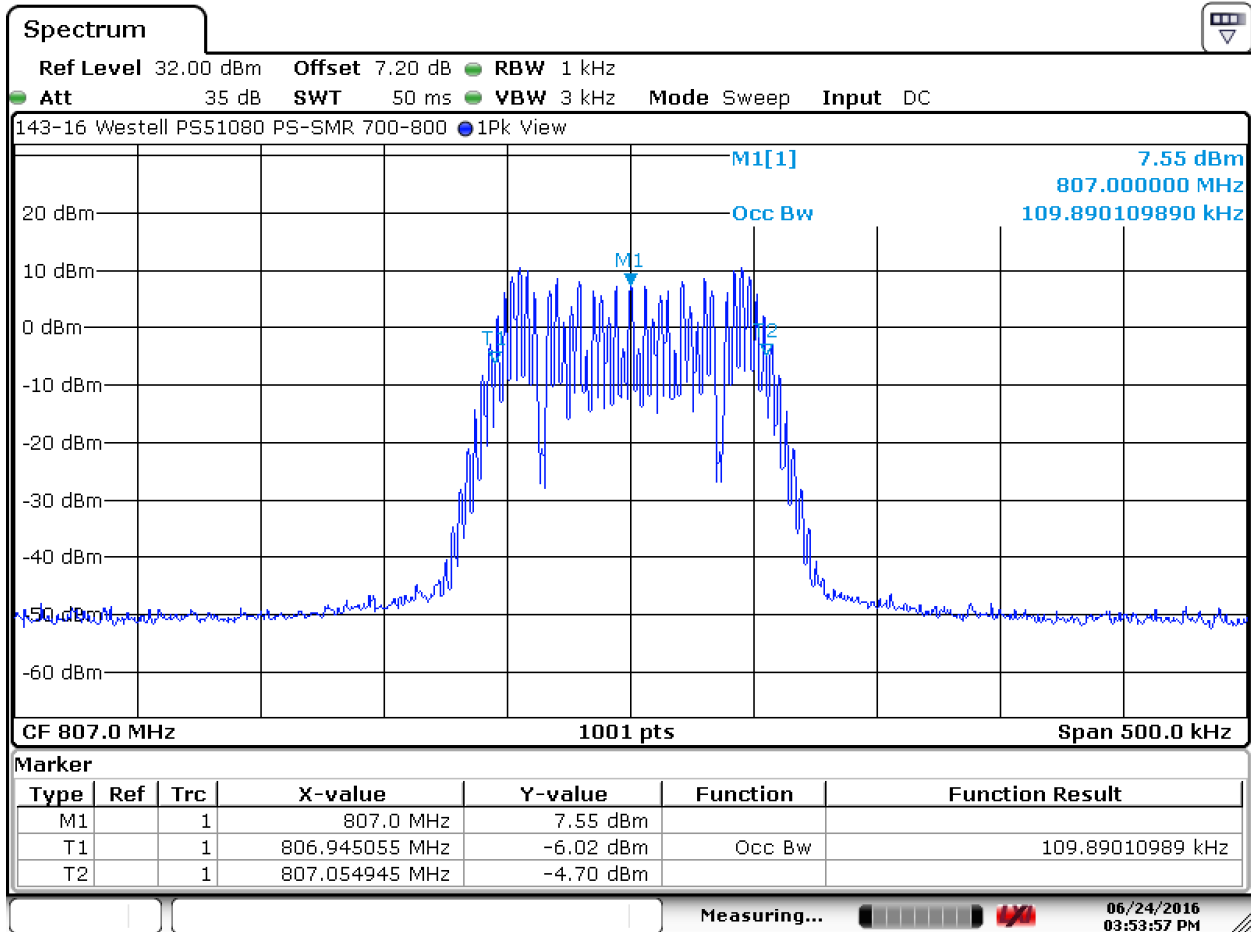

Date: 24.JUN.2016 15:53:57

Test Number: 143-16R2

Issue Date: 6/24/2016

6. Measurement Data (continued)

6.2. Bandwidth Limitations 90.219(e)(4)(ii), FCC Part 2.1049 (continued)

6.2.1.2. Occupied (99% Power) Bandwidth Input Signal, 807 MHz

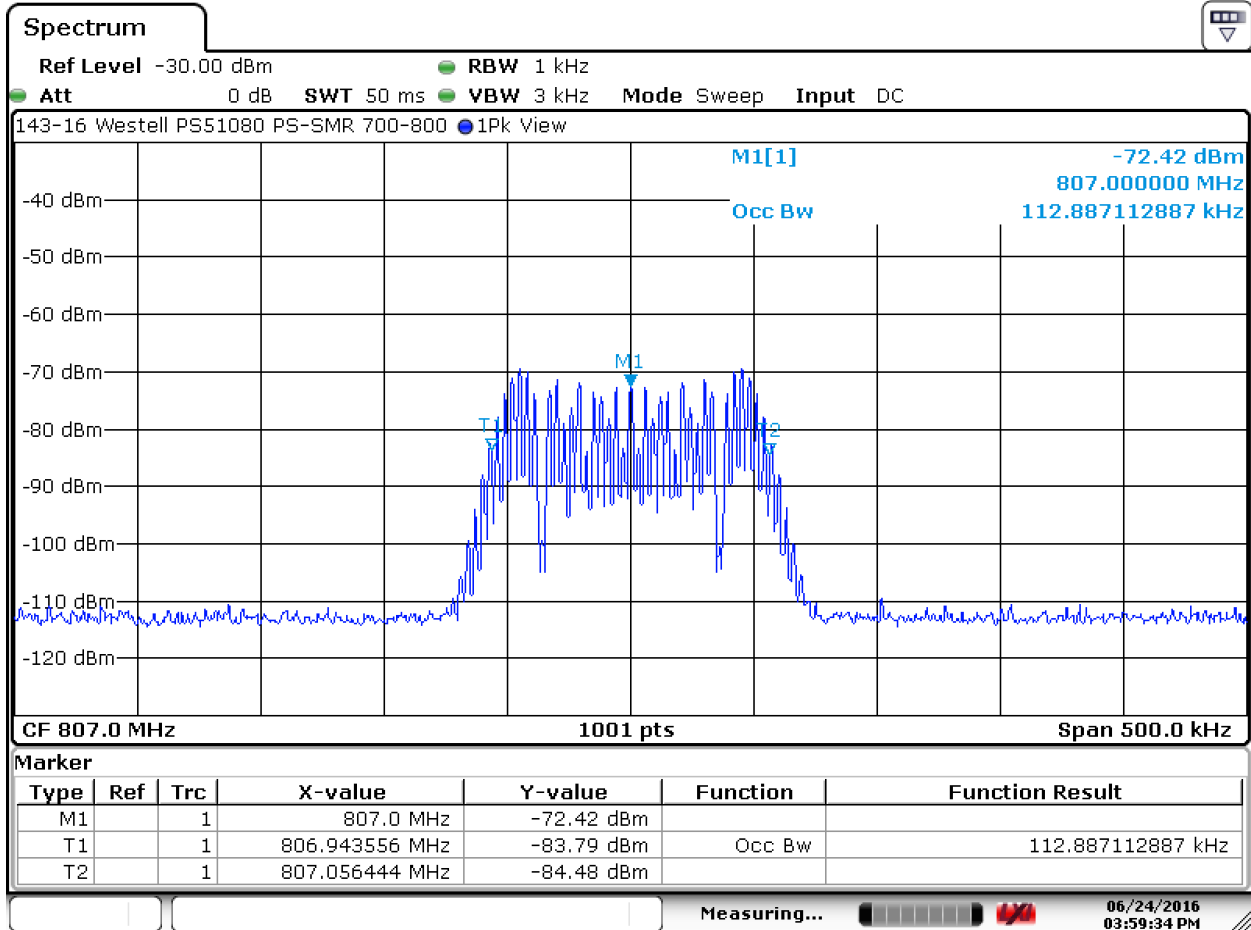

Date: 24.JUN.2016 15:59:33

Test Number: 143-16R2

Issue Date: 6/24/2016

6. Measurement Data (continued)

6.2. Bandwidth Limitations 90.219(e)(4)(ii), FCC Part 2.1049 (continued)

6.2.1.3. Occupied (99% Power) Bandwidth Measurement, 811 MHz

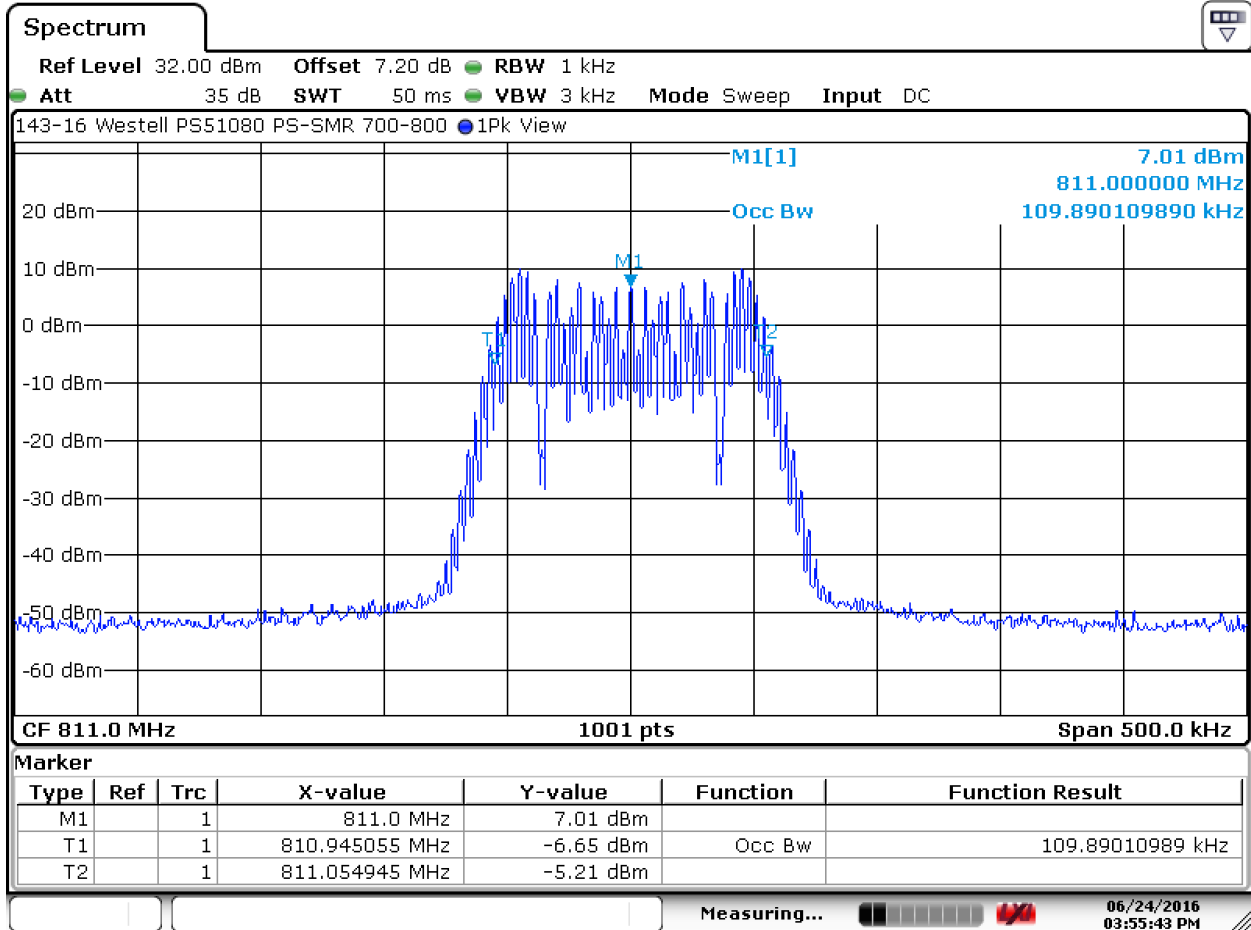

Date: 24.JUN.2016 15:55:43

Test Number: 143-16R2

Issue Date: 6/24/2016

6. Measurement Data (continued)

6.2. Bandwidth Limitations 90.219(e)(4)(ii), FCC Part 2.1049 (continued)

6.2.1.4. Occupied (99% Power) Bandwidth Input Signal, 811 MHz

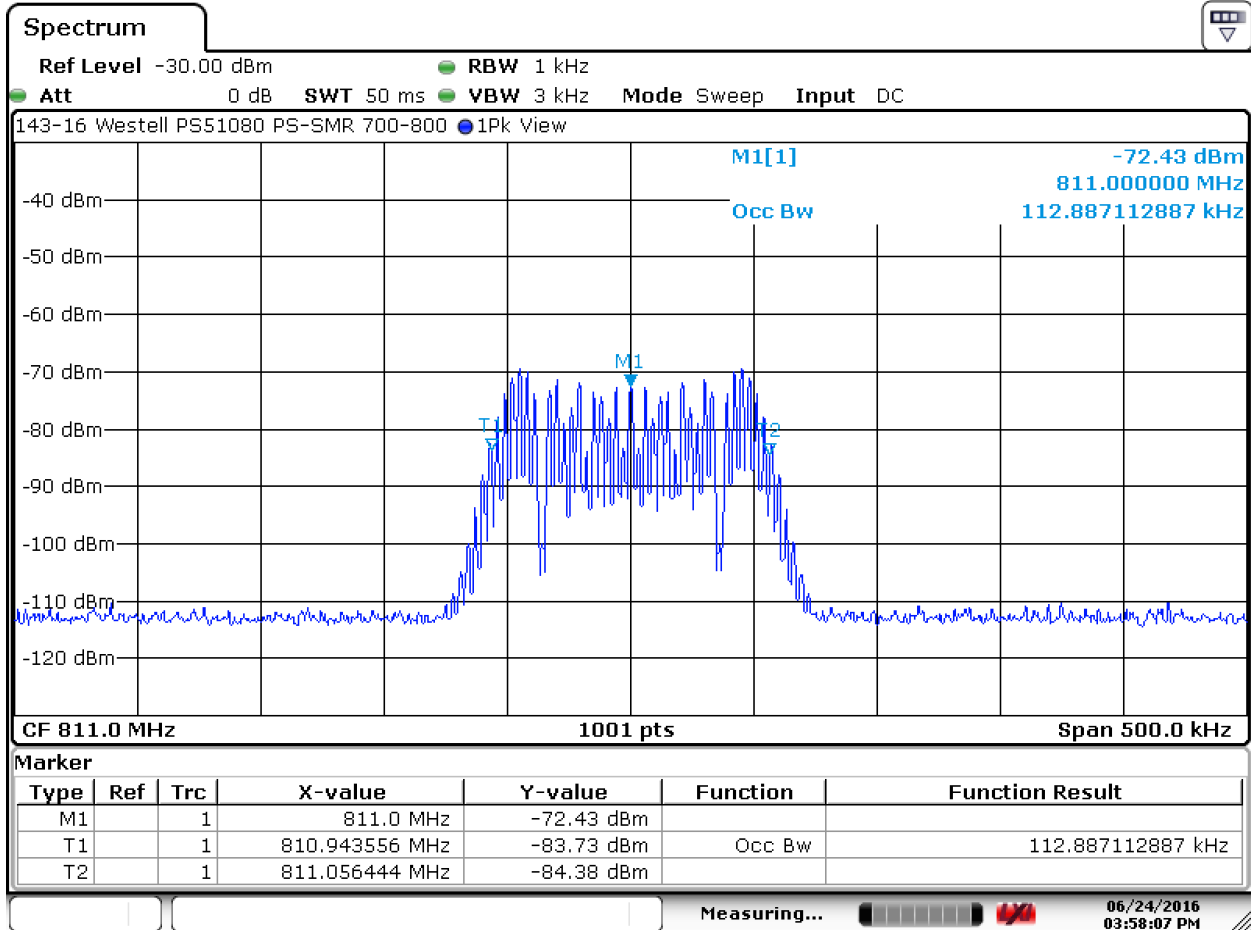

Date: 24.JUN.2016 15:58:06

6. Measurement Data (continued)

6.2. Bandwidth Limitations 90.219(e)(4)(ii), FCC Part 2.1049 (continued)

6.2.1.5. Occupied (99% Power) Bandwidth Measurement, 815 MHz

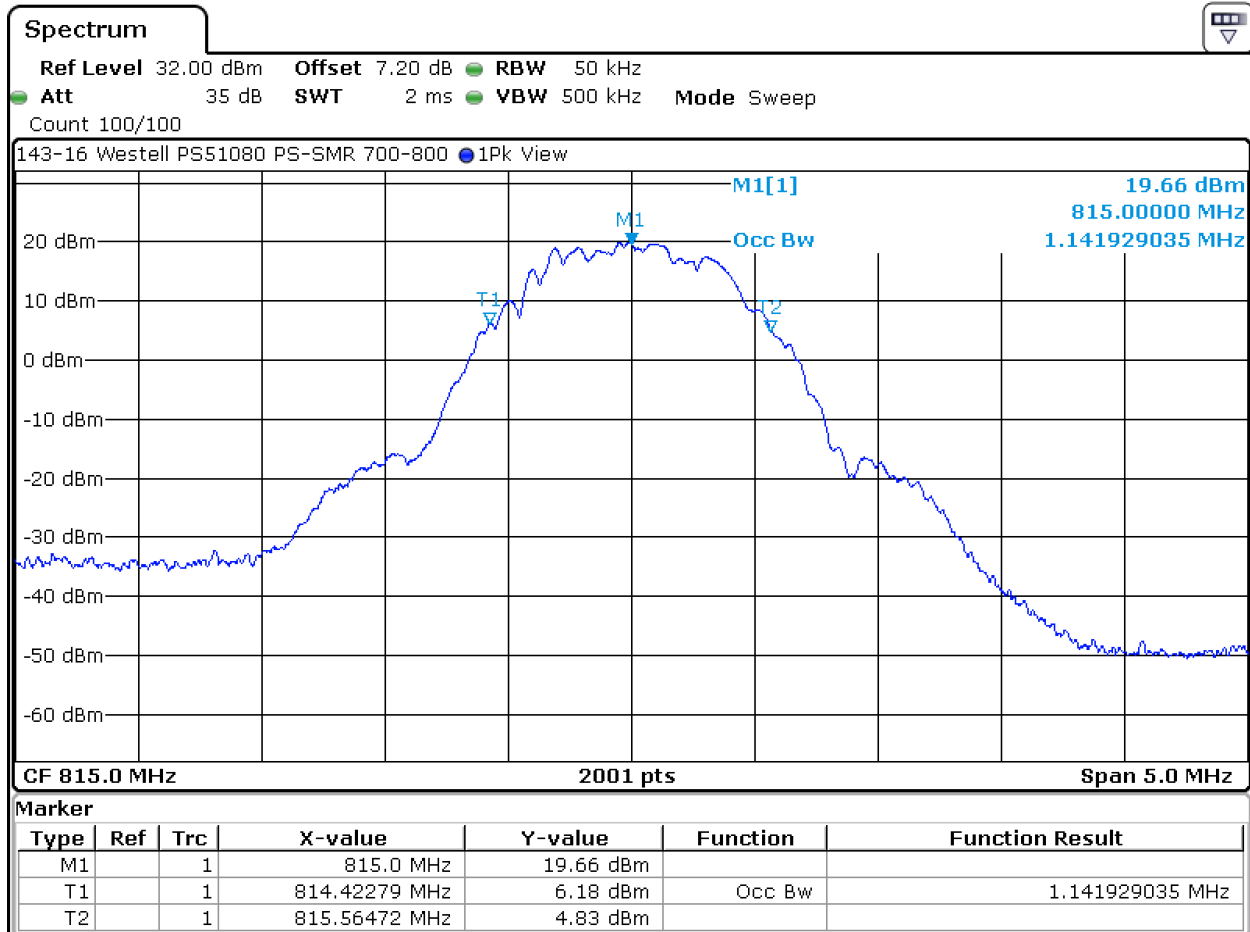

Date: 20.JAN.2016 17:25:14

6. Measurement Data (continued)

6.2. Bandwidth Limitations 90.219(e)(4)(ii), FCC Part 2.1049 (continued)

6.2.1.6. Occupied (99% Power) Bandwidth Input Signal, 815 MHz

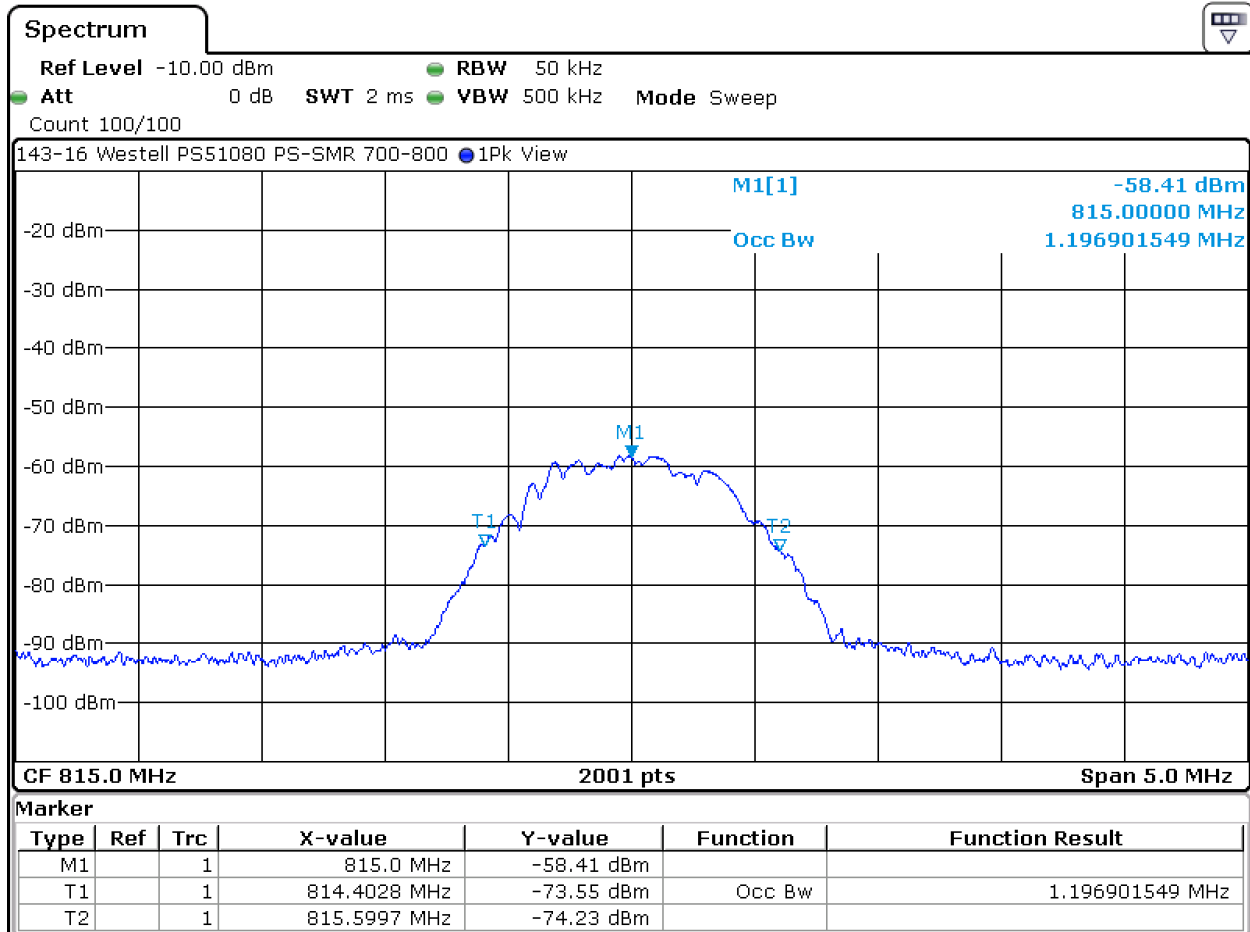

Date: 20.JAN.2016 17:27:31

Test Number: 143-16R2

Issue Date: 6/24/2016

6. Measurement Data (continued)

6.2. Bandwidth Limitations 90.219(e)(4)(ii), FCC Part 2.1049 (continued)

6.2.1.7. Occupied (99% Power) Bandwidth Measurement, 852 MHz

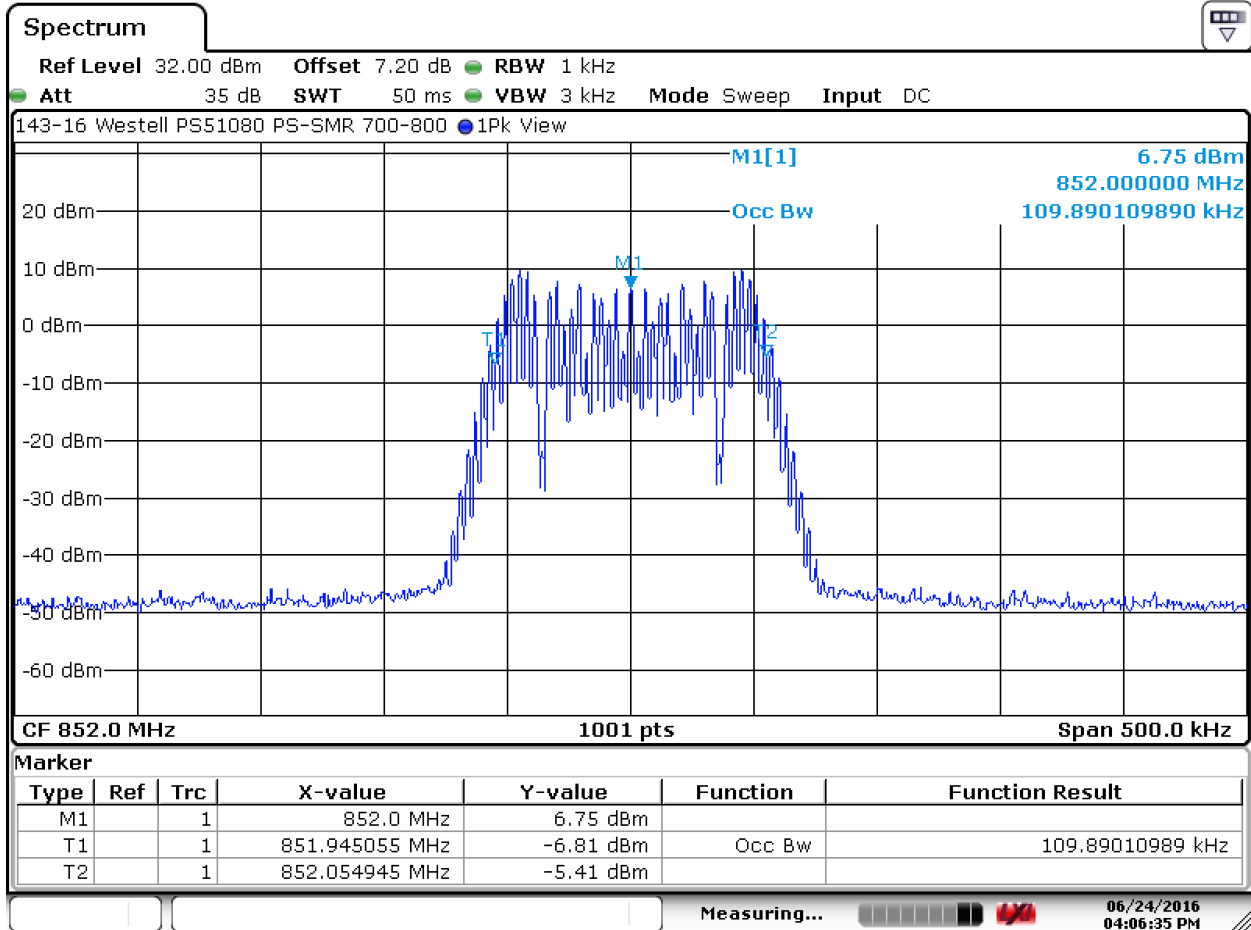

Date: 24.JUN.2016 16:06:34

Test Number: 143-16R2

Issue Date: 6/24/2016

6. Measurement Data (continued)

6.2. Bandwidth Limitations 90.219(e)(4)(ii), FCC Part 2.1049 (continued)

6.2.1.8. Occupied (99% Power) Bandwidth Input Signal, 852 MHz

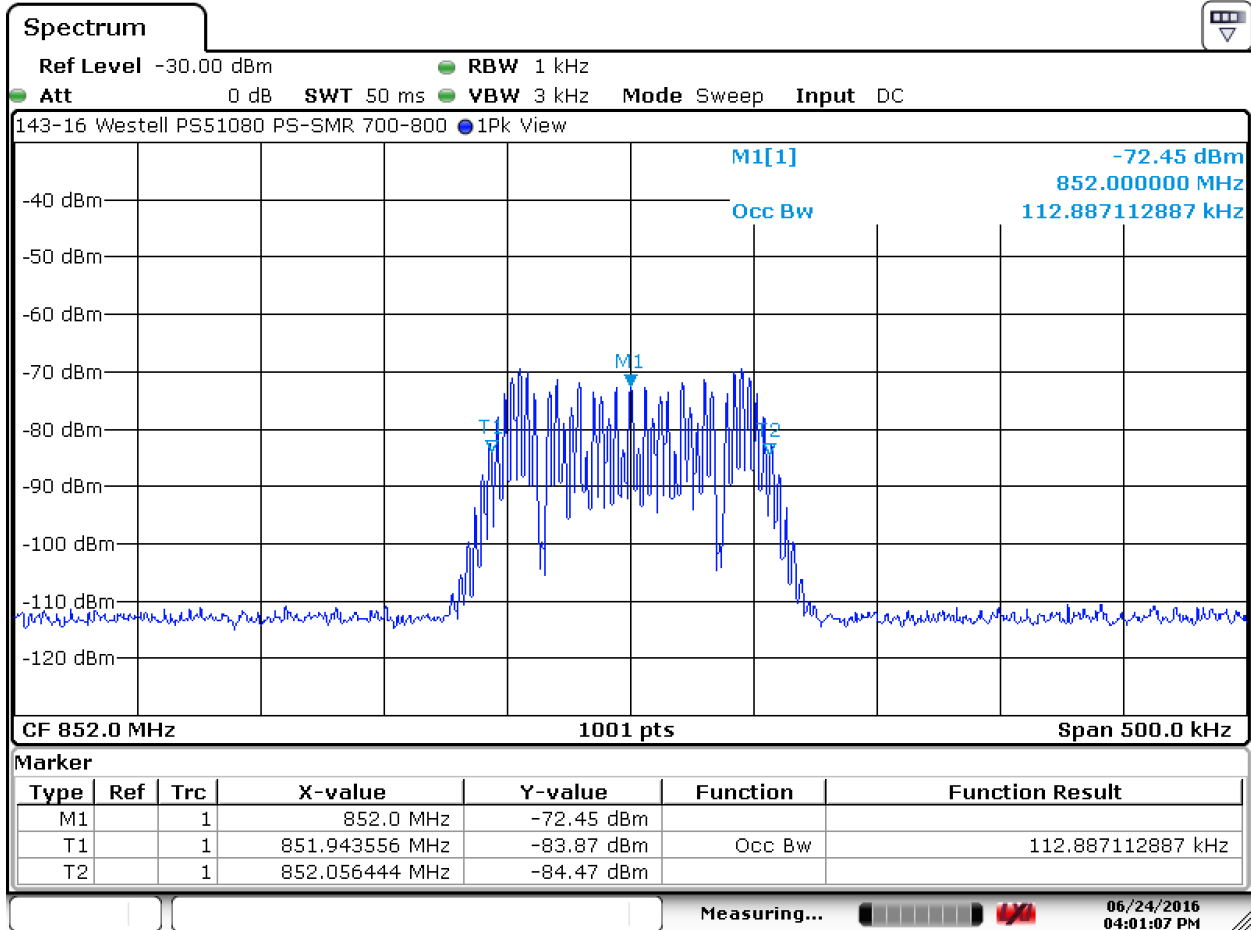

Date: 24.JUN.2016 16:01:07

Test Number: 143-16R2

Issue Date: 6/24/2016

6. Measurement Data (continued)

6.2. Bandwidth Limitations 90.219(e)(4)(ii), FCC Part 2.1049 (continued)

6.2.1.9. Occupied (99% Power) Bandwidth Measurement, 856 MHz

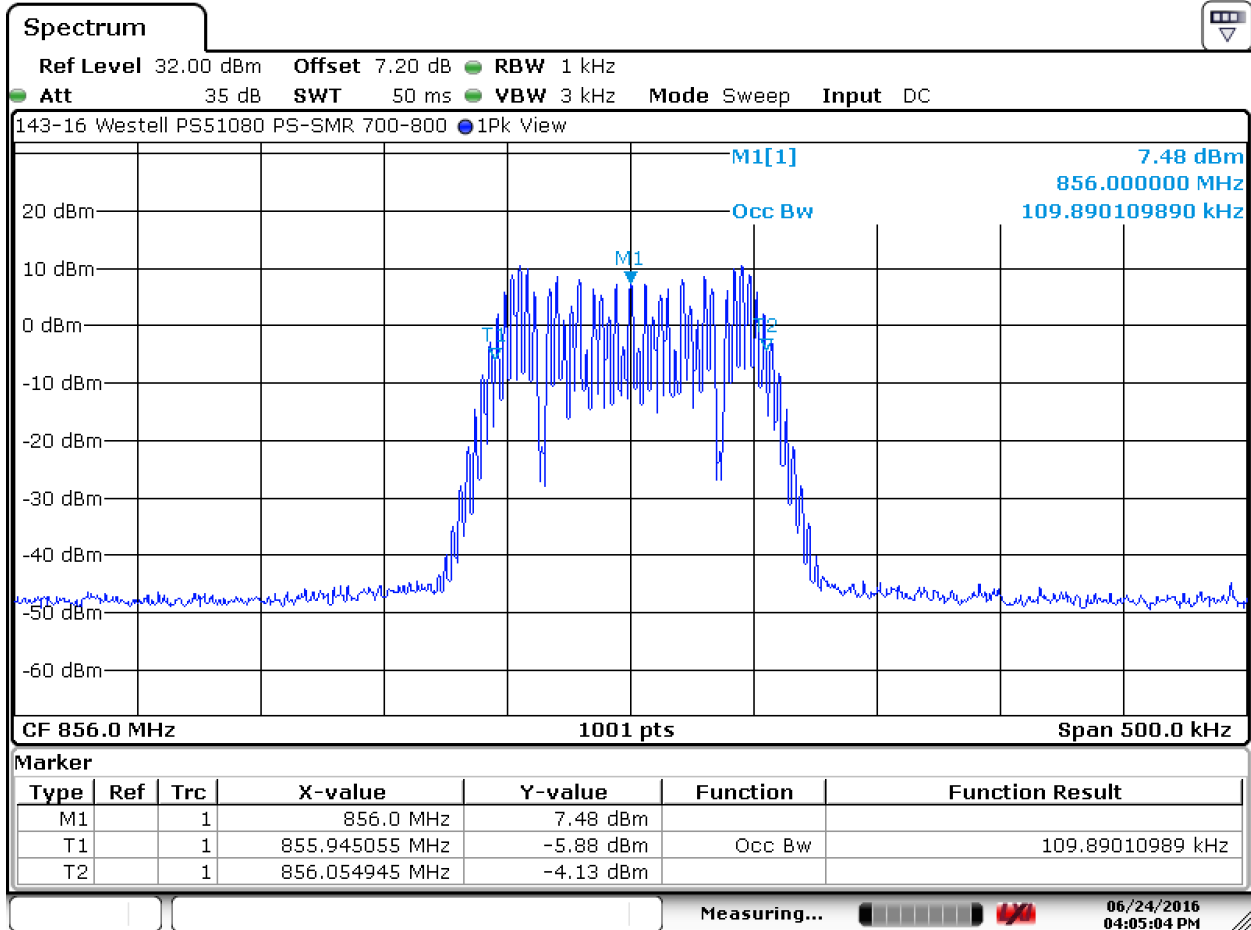

Date: 24.JUN.2016 16:05:03

Test Number: 143-16R2

Issue Date: 6/24/2016

6. Measurement Data (continued)

6.2. Bandwidth Limitations 90.219(e)(4)(ii), FCC Part 2.1049 (continued)

6.2.1.10. Occupied (99% Power) Bandwidth Input Signal, 856 MHz

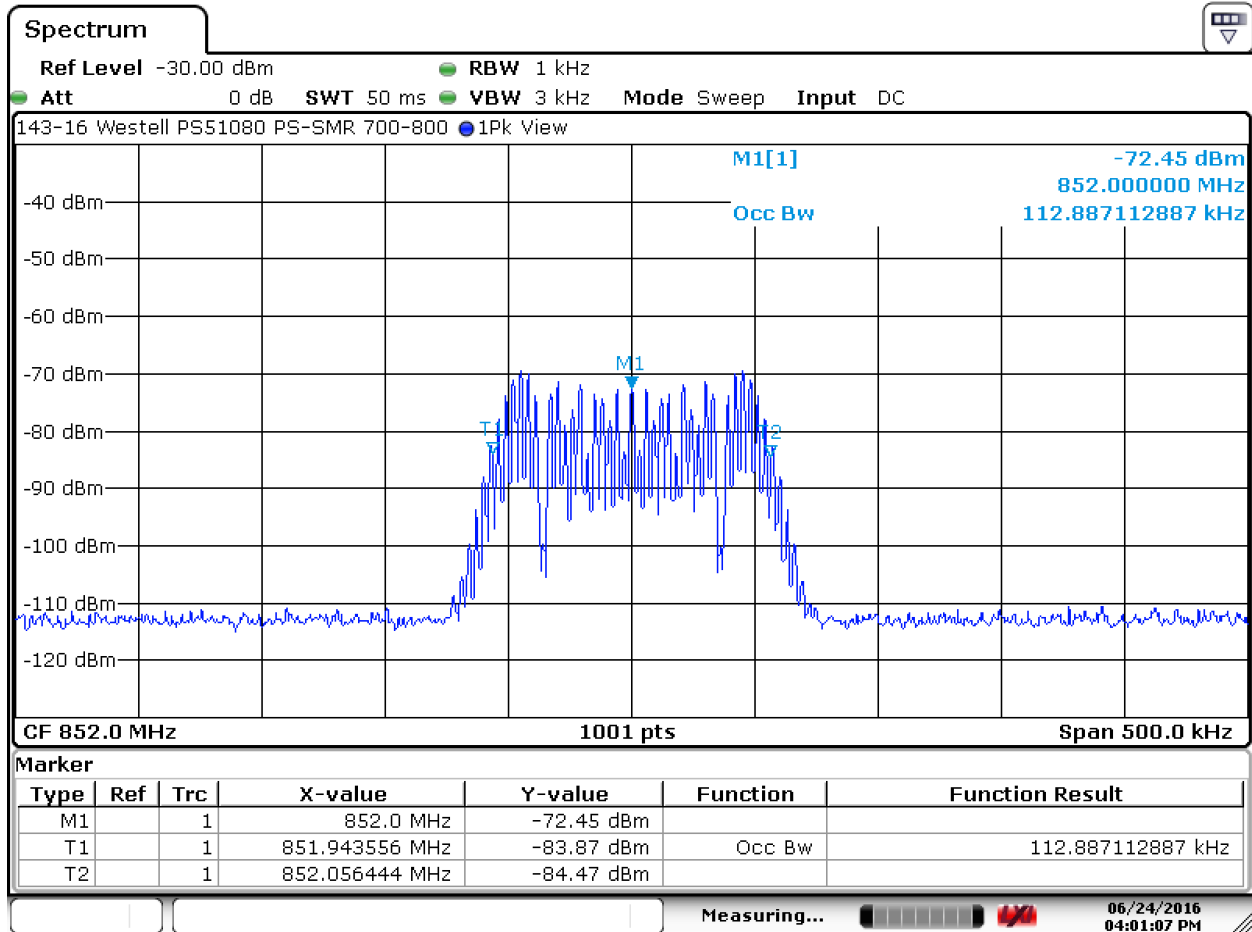

Date: 24.JUN.2016 16:01:07

6. Measurement Data (continued)

6.2. Bandwidth Limitations 90.219(e)(4)(ii), FCC Part 2.1049 (continued)

6.2.1.11. Occupied (99% Power) Bandwidth Measurement, 860 MHz

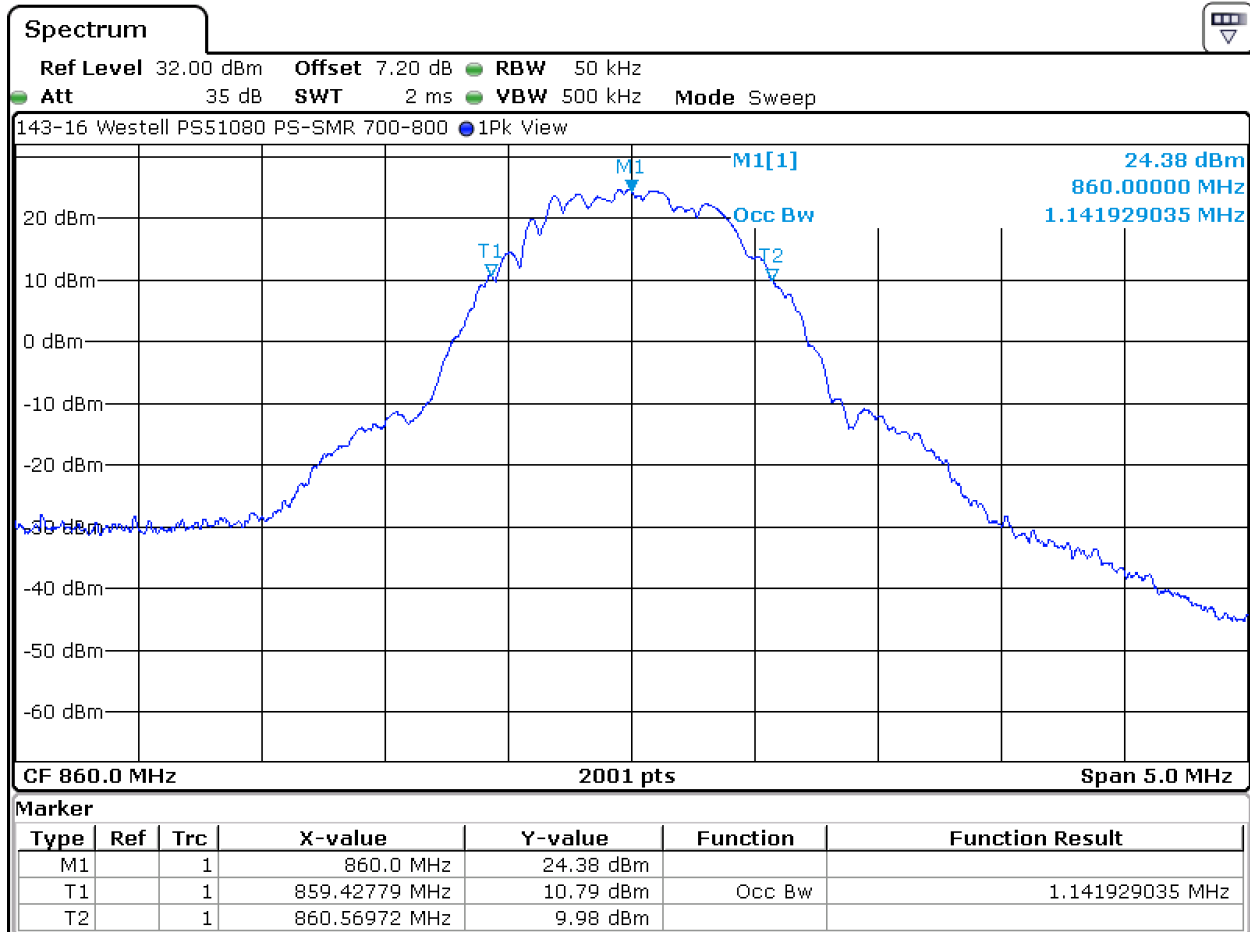

Date: 20.JAN.2016 16:30:18

6. Measurement Data (continued)

6.2. Bandwidth Limitations 90.219(e)(4)(ii), FCC Part 2.1049 (continued)

6.2.1.12. Occupied (99% Power) Bandwidth Input Signal, 860 MHz

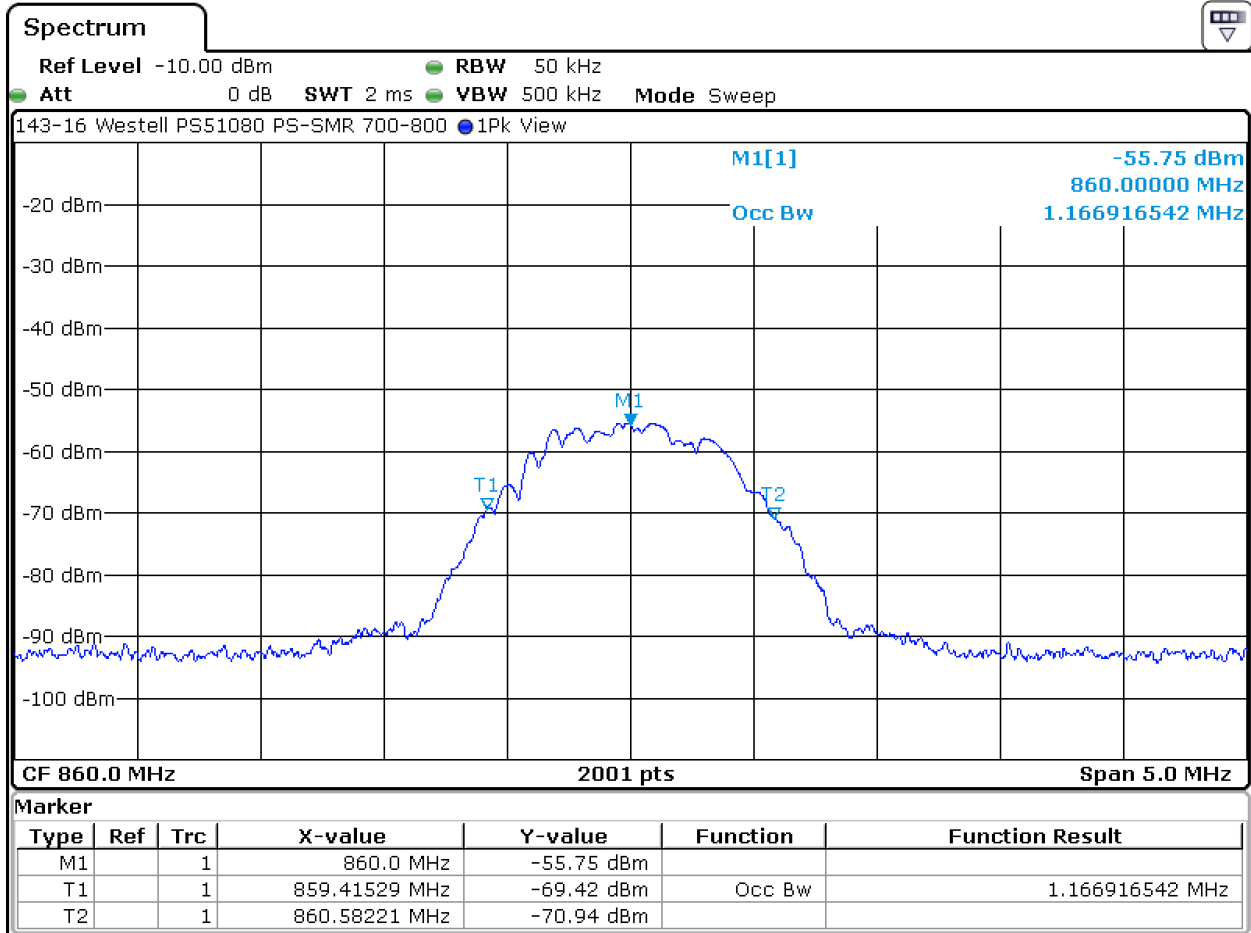

Date: 20.JAN.2016 16:32:38

6. Measurement Data (continued)

6.3. Spurious Emissions at the Antenna Terminals 90.219(e)(3), 90.669

Requirement: Transmitters designed to operate in the 806 to 824 MHz, 851 to 869 MHz, 896 to 901 MHz and 935 to 940 MHz bands, any emission outside of the MTA licensee's spectrum shall be attenuated below the transmitter power (P) by at least $43 + 10 \log (P)$ dB or 80 decibels, whichever is the lesser attenuation.

Compliance with this provision is based upon the use of measurement instrumentation employing a resolution bandwidth of 100 kHz bandwidth for frequencies less than 1 GHz, and in a 1 MHz bandwidth for frequencies greater than 1 GHz.

Test Method: KDB 935210 Section 3.6.3

6.3.1. 807 MHz, 30 MHz to 1 GHz

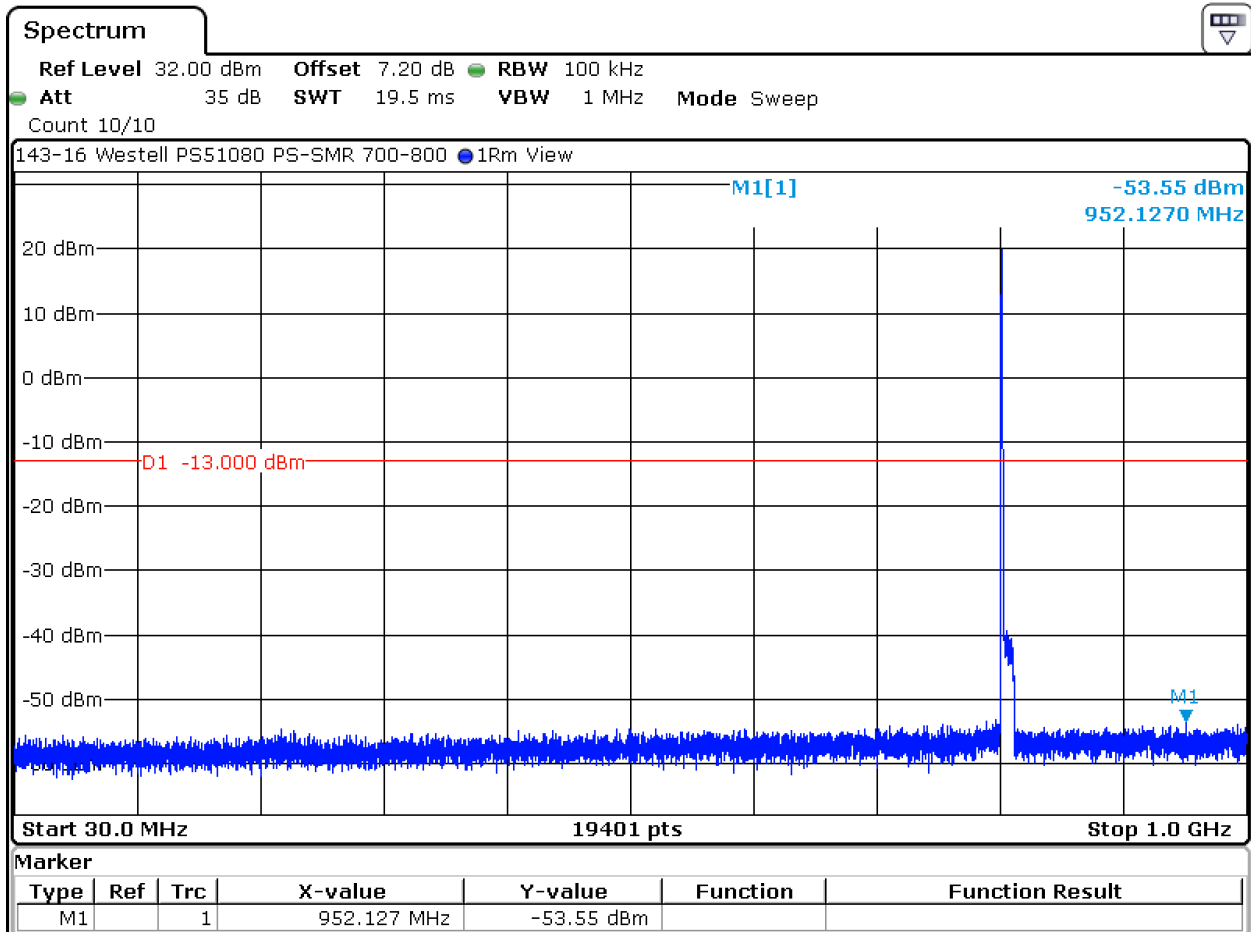

Date: 20.JAN.2016 17:12:26

6. Measurement Data (continued)

6.3. Spurious Emissions at the Antenna Terminals 90.219(e)(3), 90.669 (continued)

6.3.2. 807 MHz, 1 to 9 GHz

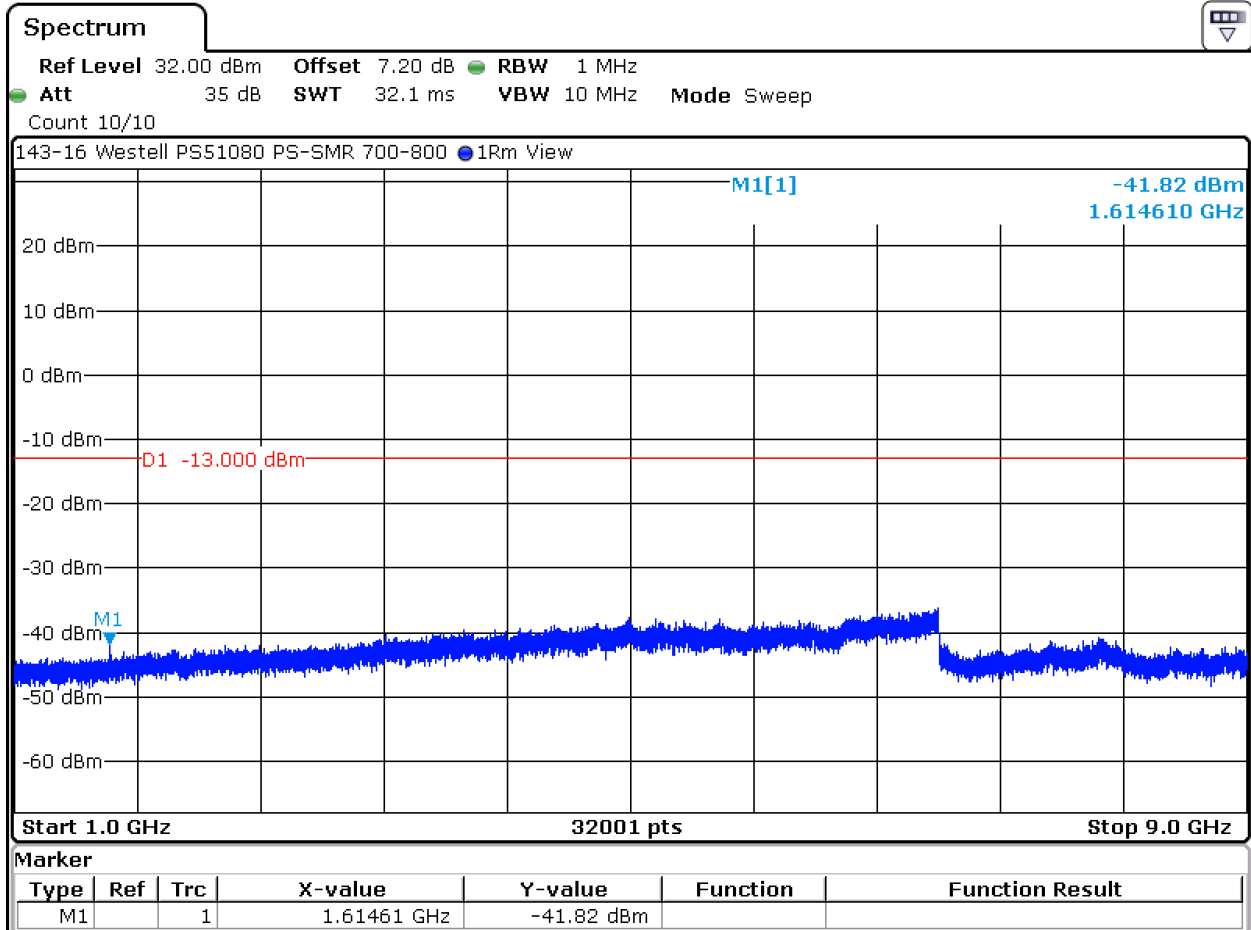

Date: 20.JAN.2016 17:14:09

6. Measurement Data (continued)

6.3. Spurious Emissions at the Antenna Terminals 90.219(e)(3), 90.669 (continued)

6.3.3. 811 MHz, 30 MHz to 1 GHz

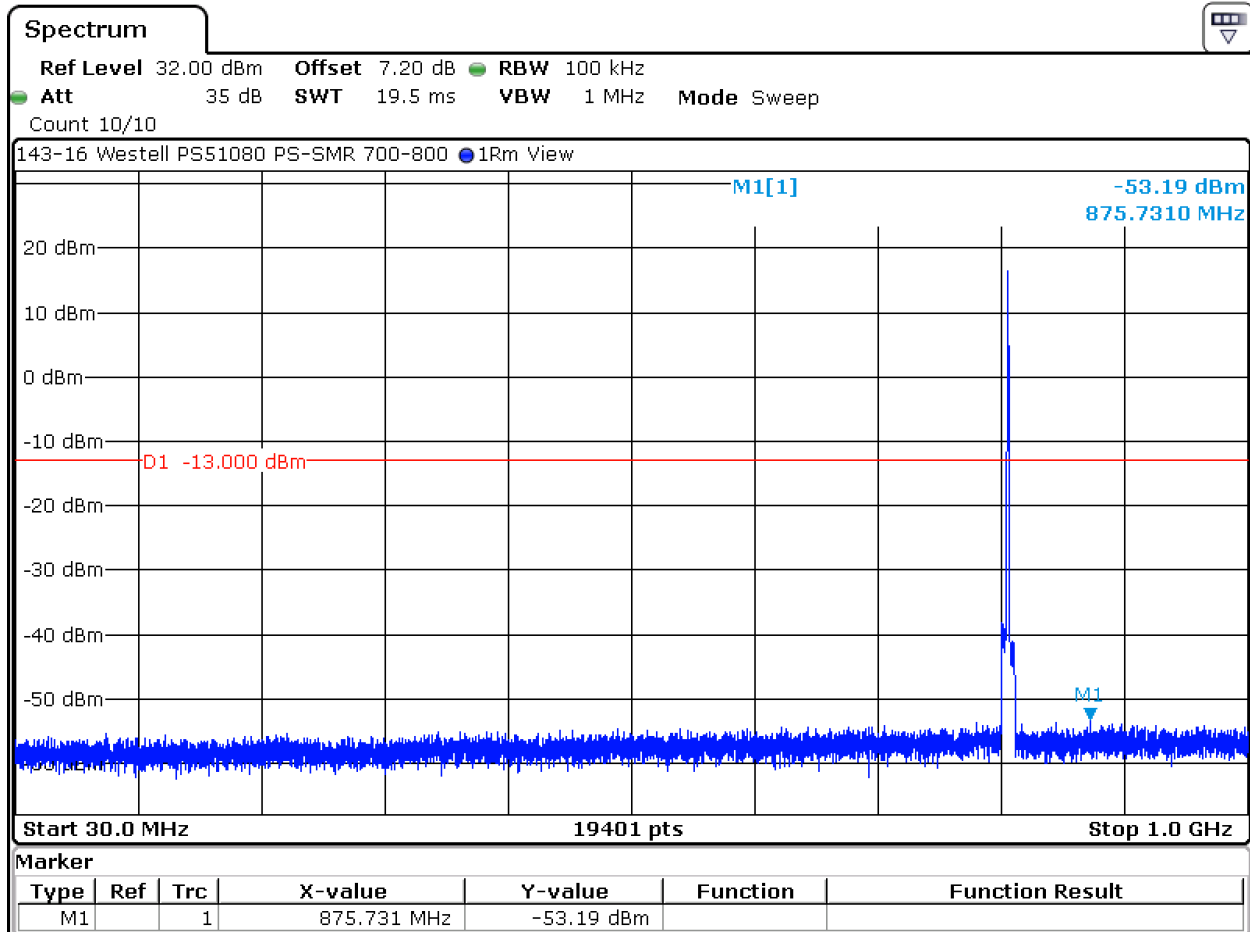

Date: 20.JAN.2016 17:16:03

6. Measurement Data (continued)

6.3. Spurious Emissions at the Antenna Terminals 90.219(e)(3), 90.669 (continued)

6.3.4. 811 MHz, 1 to 9 GHz

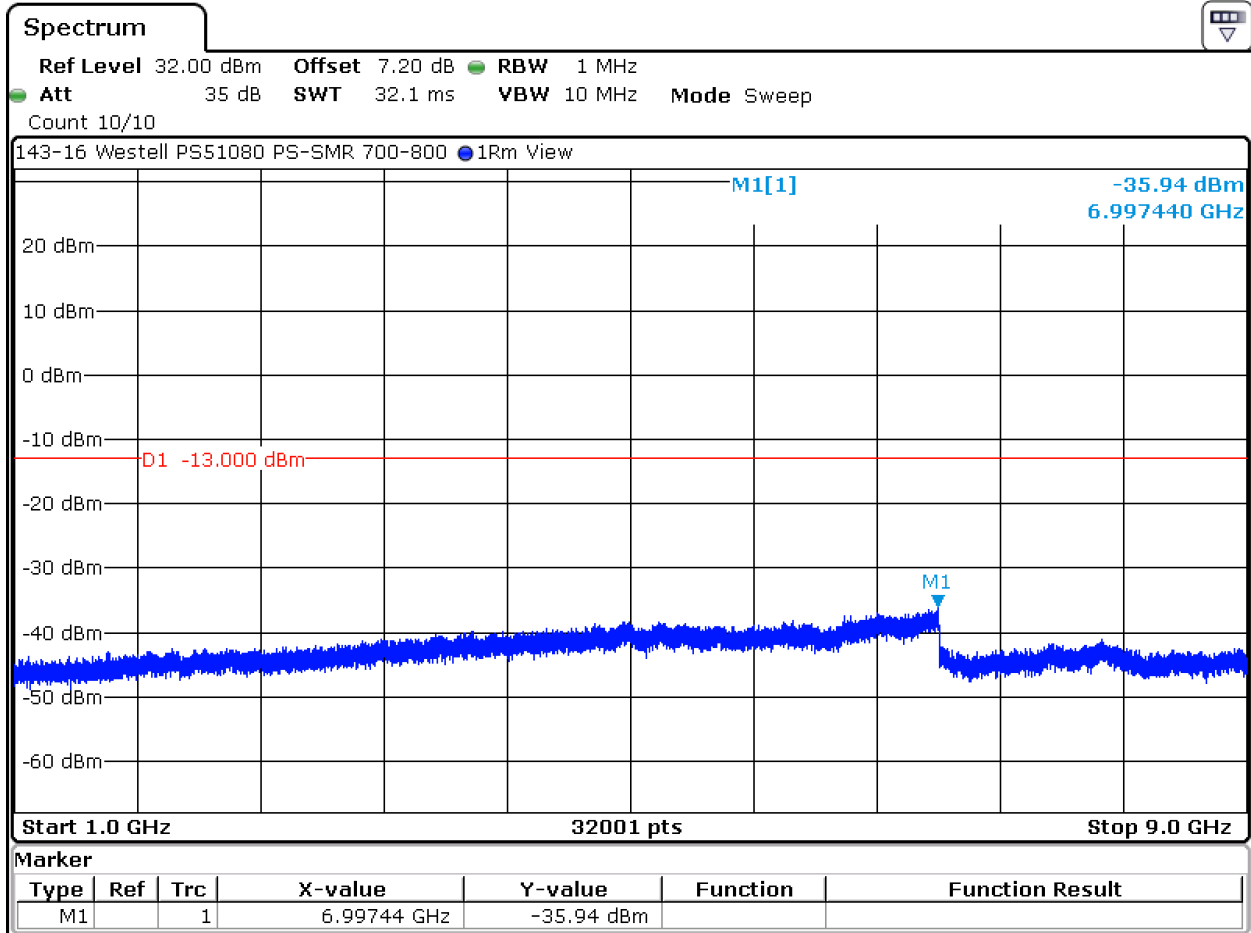

Date: 20.JAN.2016 17:15:07

6. Measurement Data (continued)

6.3. Spurious Emissions at the Antenna Terminals 90.219(e)(3), 90.669 (continued)

6.3.5. 815 MHz, 30 MHz to 1 GHz

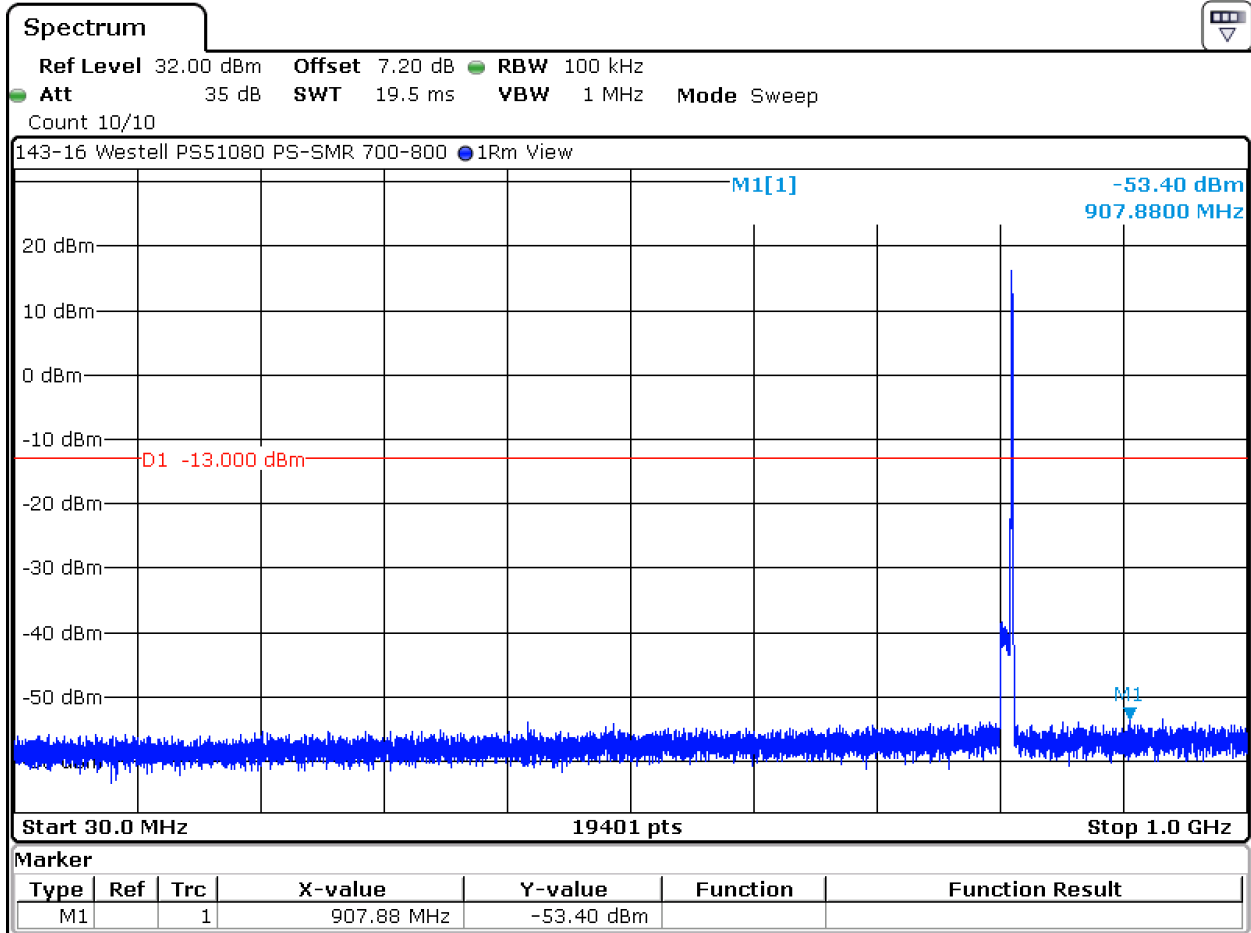

Date: 20.JAN.2016 17:16:47

6. Measurement Data (continued)

6.3. Spurious Emissions at the Antenna Terminals 90.219(e)(3), 90.669 (continued)

6.3.6. 815 MHz, 1 to 9 GHz

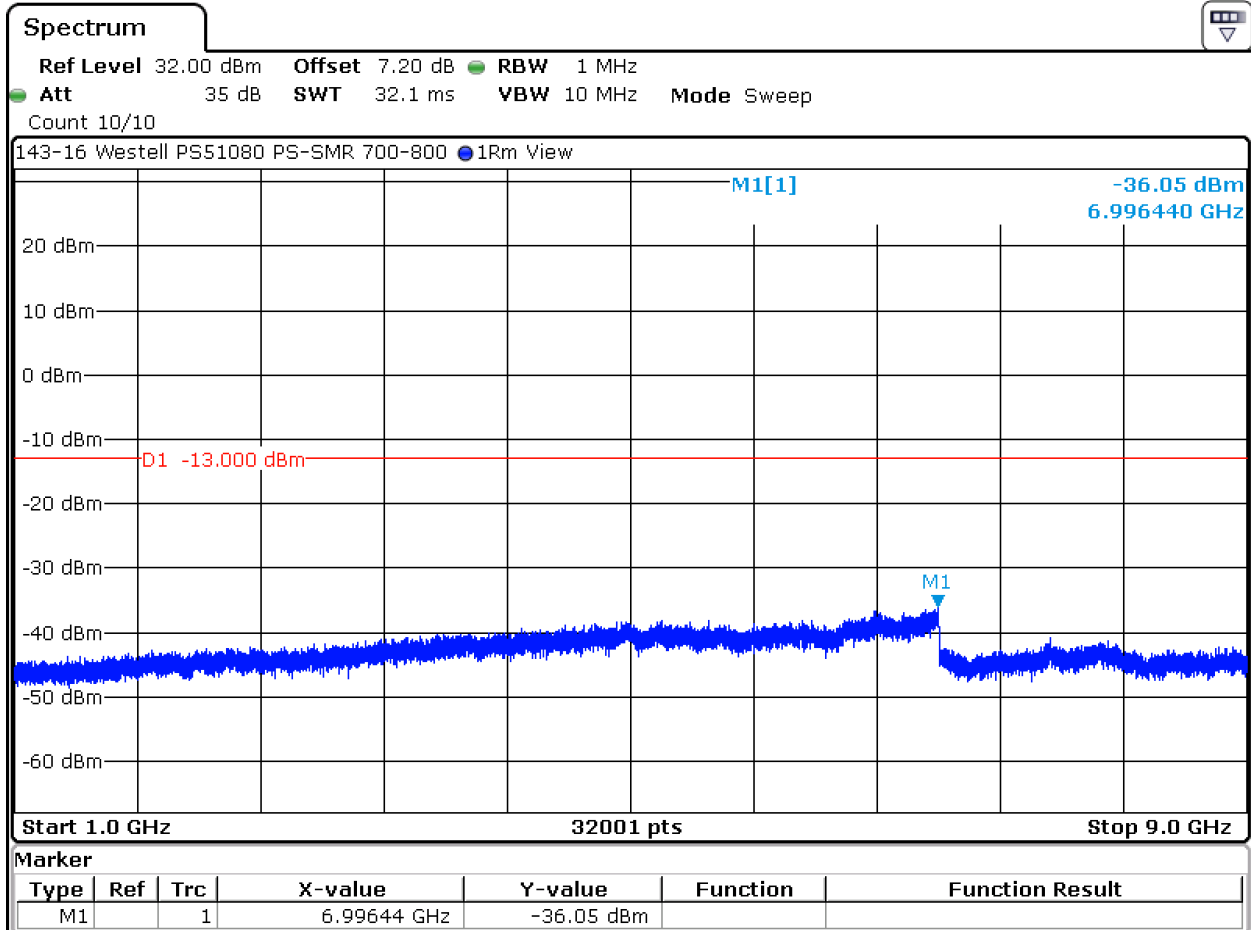

Date: 20.JAN.2016 17:17:38

6. Measurement Data (continued)

6.3. Spurious Emissions at the Antenna Terminals 90.219(e)(3), 90.669 (continued)

6.3.7. 852 MHz, 30 MHz to 1 GHz

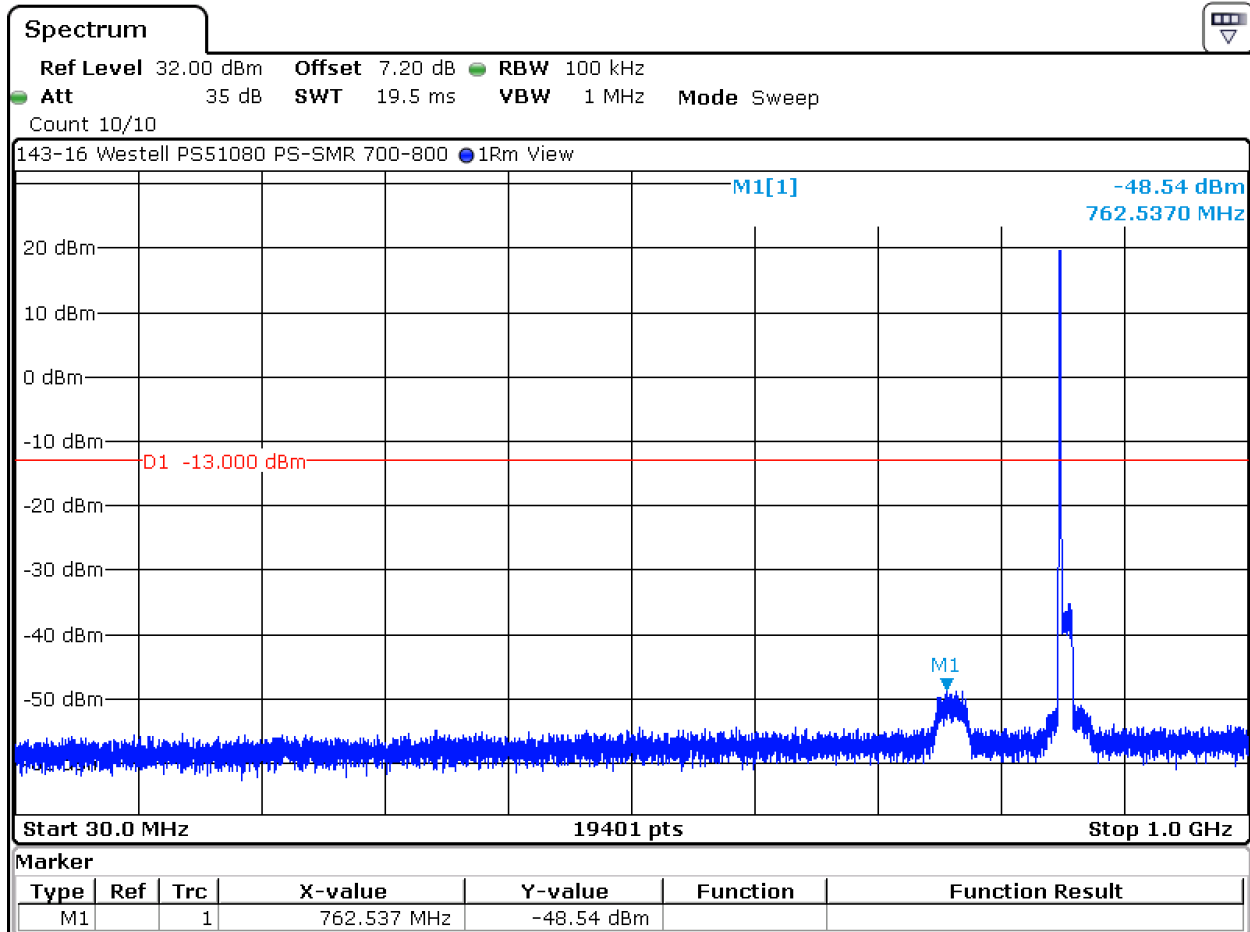

Date: 20.JAN.2016 16:16:06

Test Number: 143-16R2

Issue Date: 6/24/2016

6. Measurement Data (continued)

6.3. Spurious Emissions at the Antenna Terminals 90.219(e)(3), 90.669 (continued)

6.3.8. 852 MHz, 1 to 9 GHz

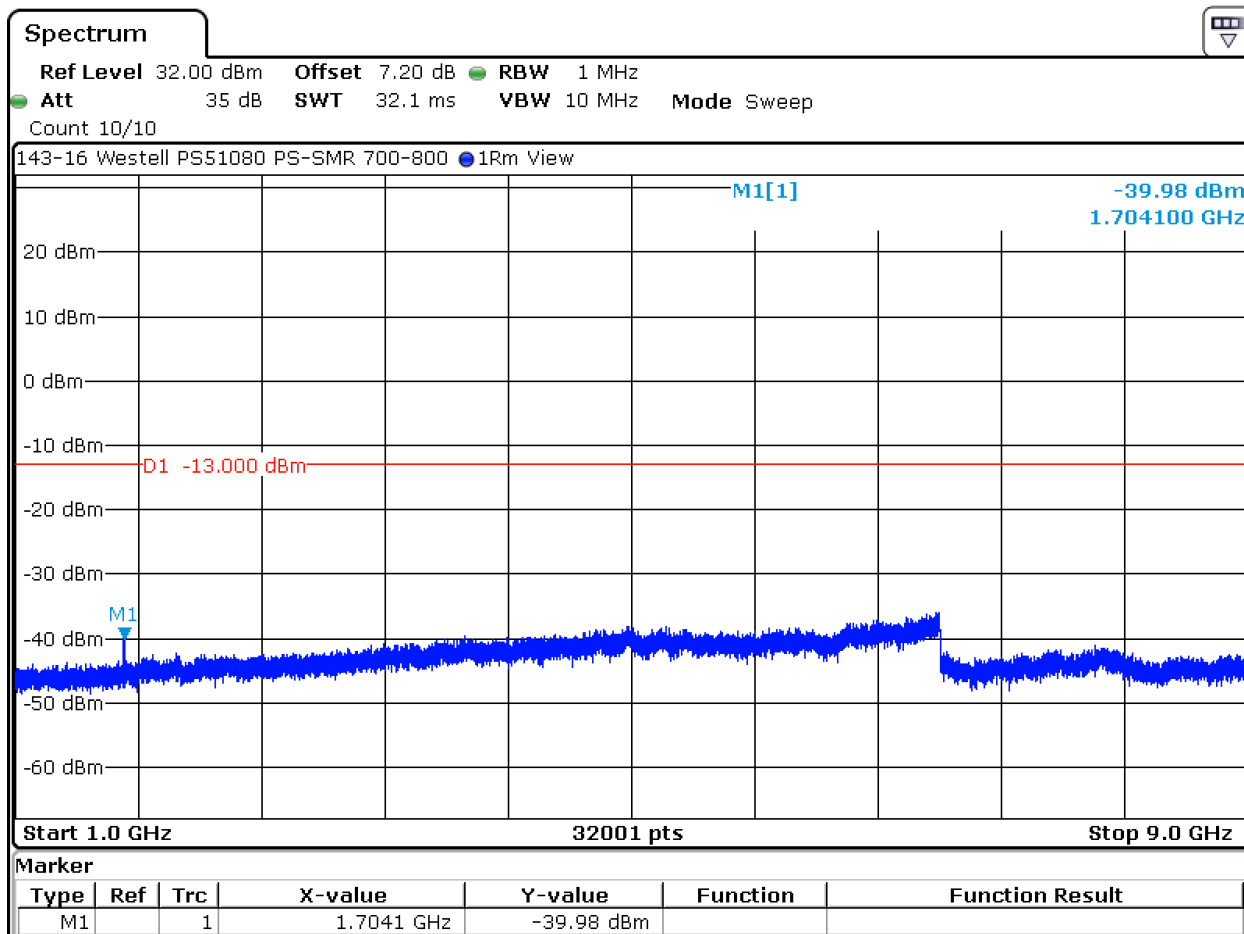

Date: 20.JAN.2016 16:16:57

Test Number: 143-16R2

Issue Date: 6/24/2016

6. Measurement Data (continued)

6.3. Spurious Emissions at the Antenna Terminals 90.219(e)(3), 90.669 (continued)

6.3.9. 856 MHz, 30 MHz to 1 GHz

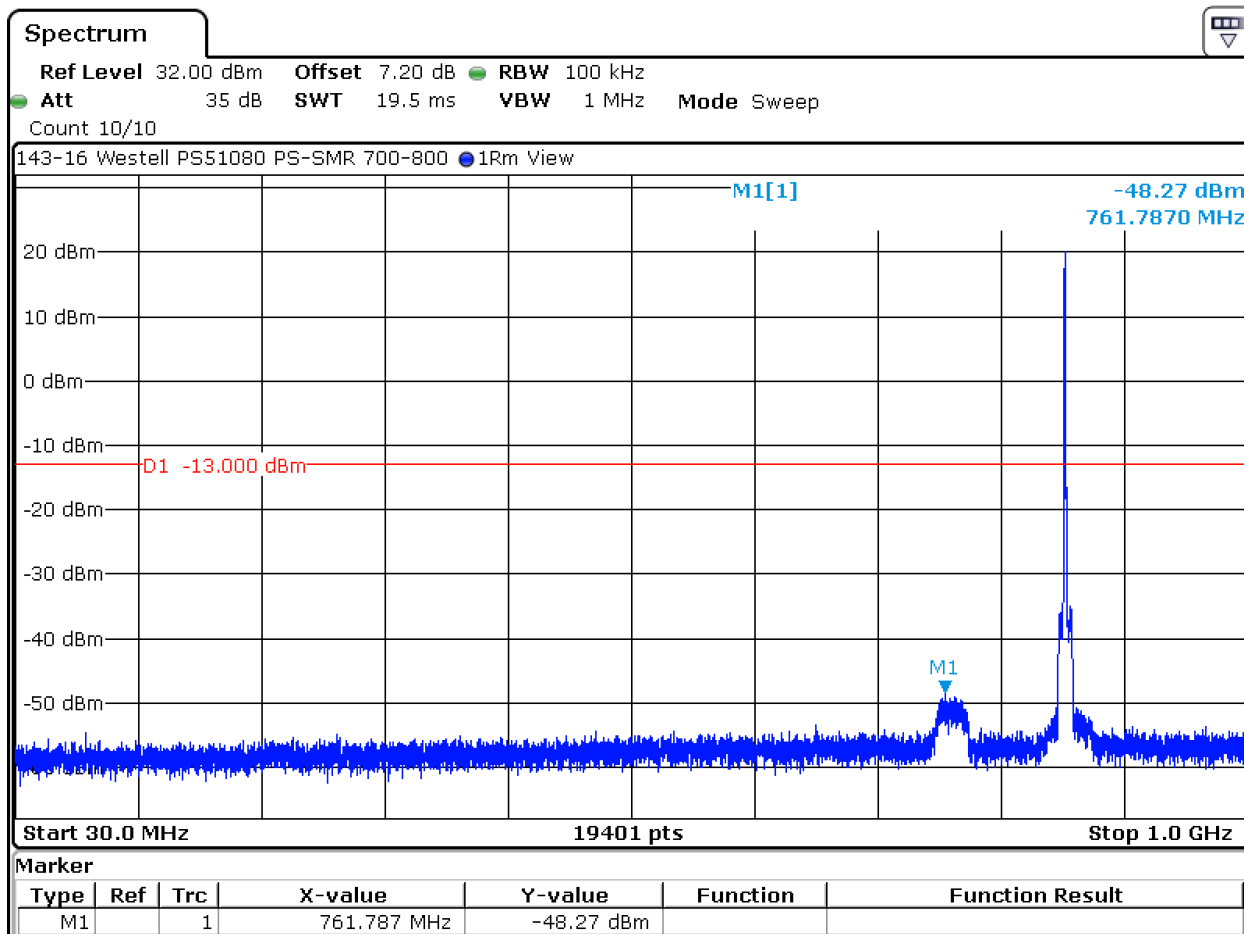

Date: 20.JAN.2016 16:19:09

6. Measurement Data (continued)

6.3. Spurious Emissions at the Antenna Terminals 90.219(e)(3), 90.669 (continued)

6.3.10. 856 MHz, 1 to 9 GHz

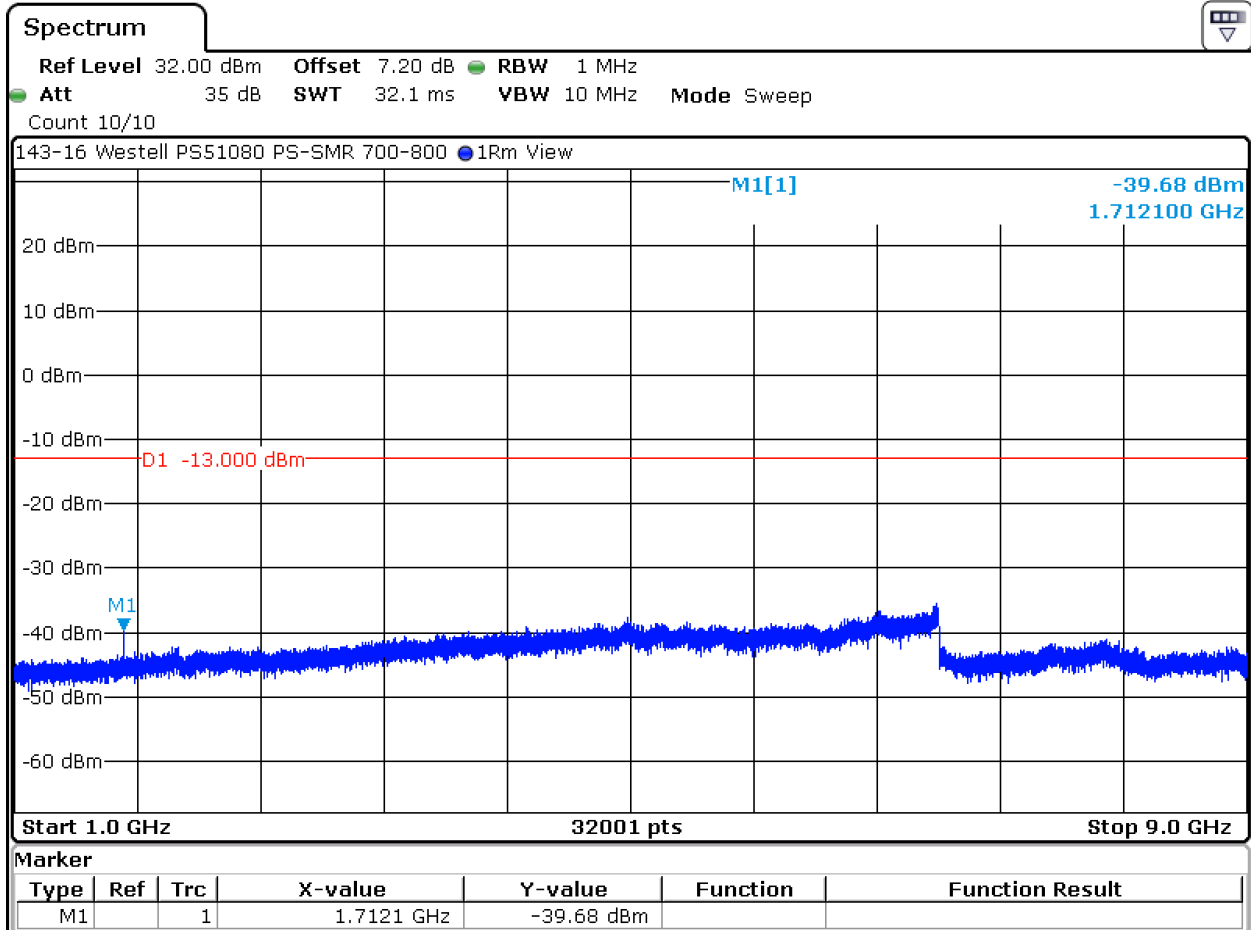

Date: 20.JAN.2016 16:18:09

Test Number: 143-16R2

Issue Date: 6/24/2016

6. Measurement Data (continued)

6.3. Spurious Emissions at the Antenna Terminals 90.219(e)(3), 90.669 (continued)

6.3.11. 860 MHz, 30 MHz to 1 GHz

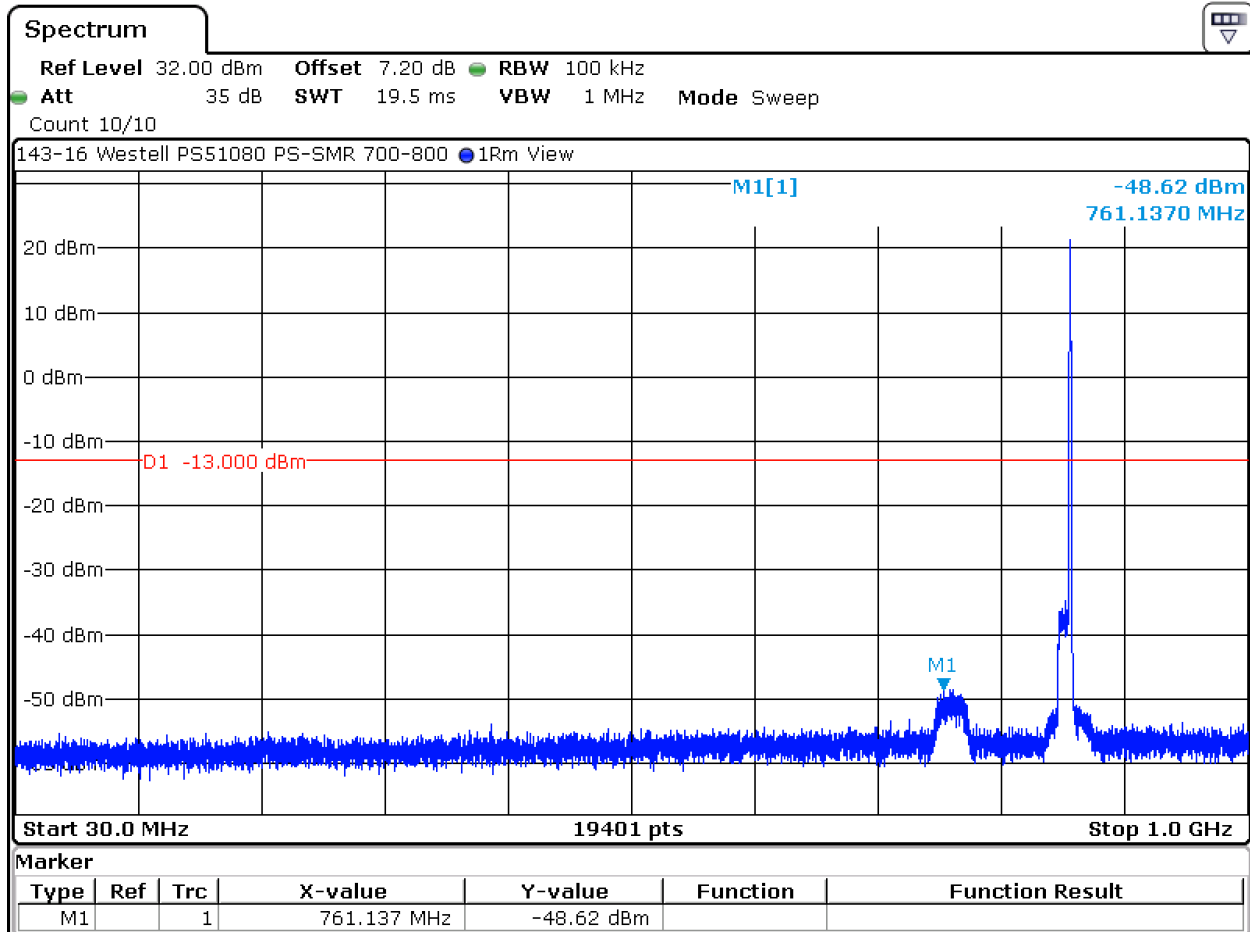

Date: 20.JAN.2016 16:20:03

6. Measurement Data (continued)

6.3. Spurious Emissions at the Antenna Terminals 90.219(e)(3), 90.669 (continued)

6.3.13. 806 MHz Lower Bandedge

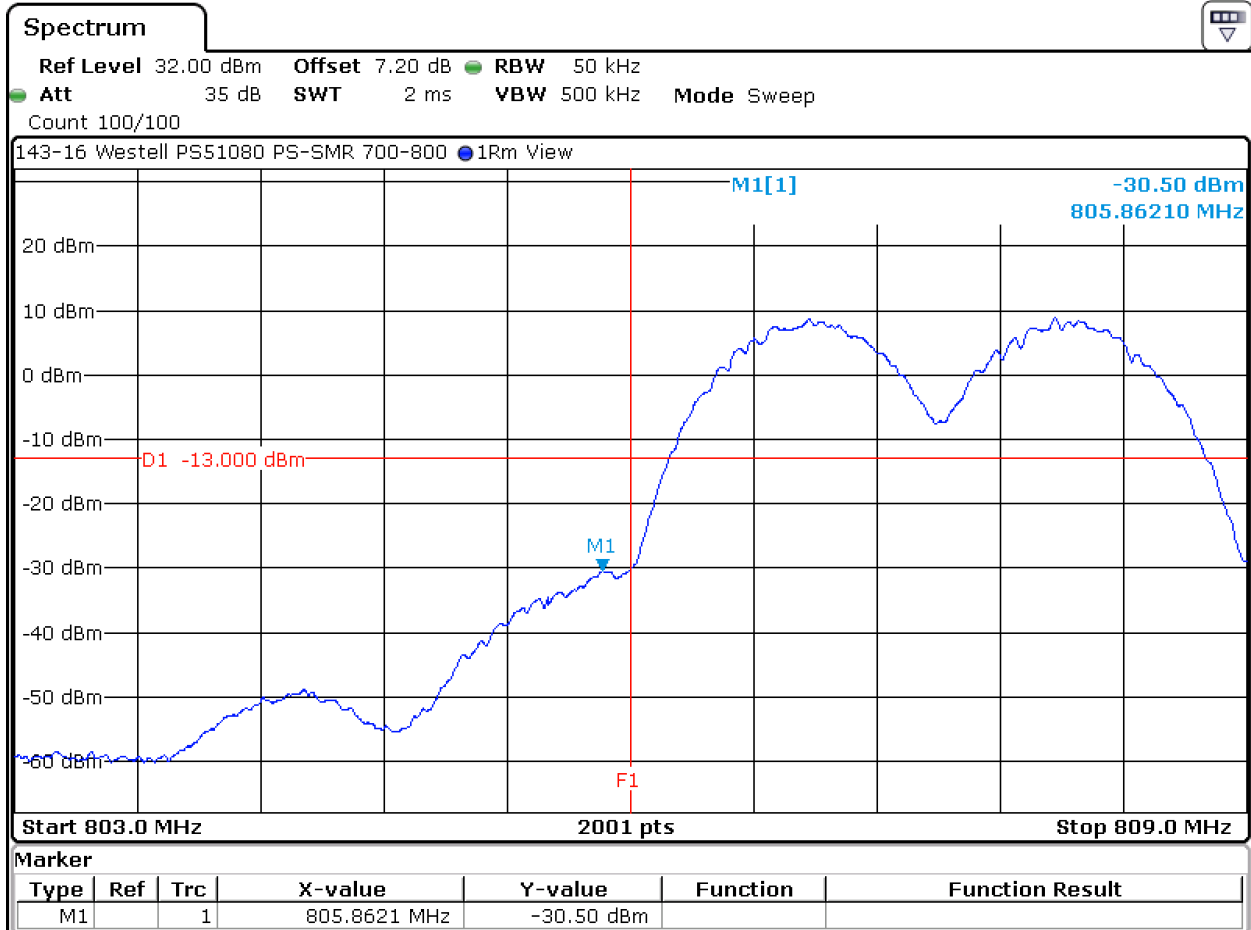

Date: 20.JAN.2016 17:19:37

6. Measurement Data (continued)

6.3. Spurious Emissions at the Antenna Terminals 90.219(e)(3), 90.669 (continued)

6.3.14. 816 MHz Upper Bandedge

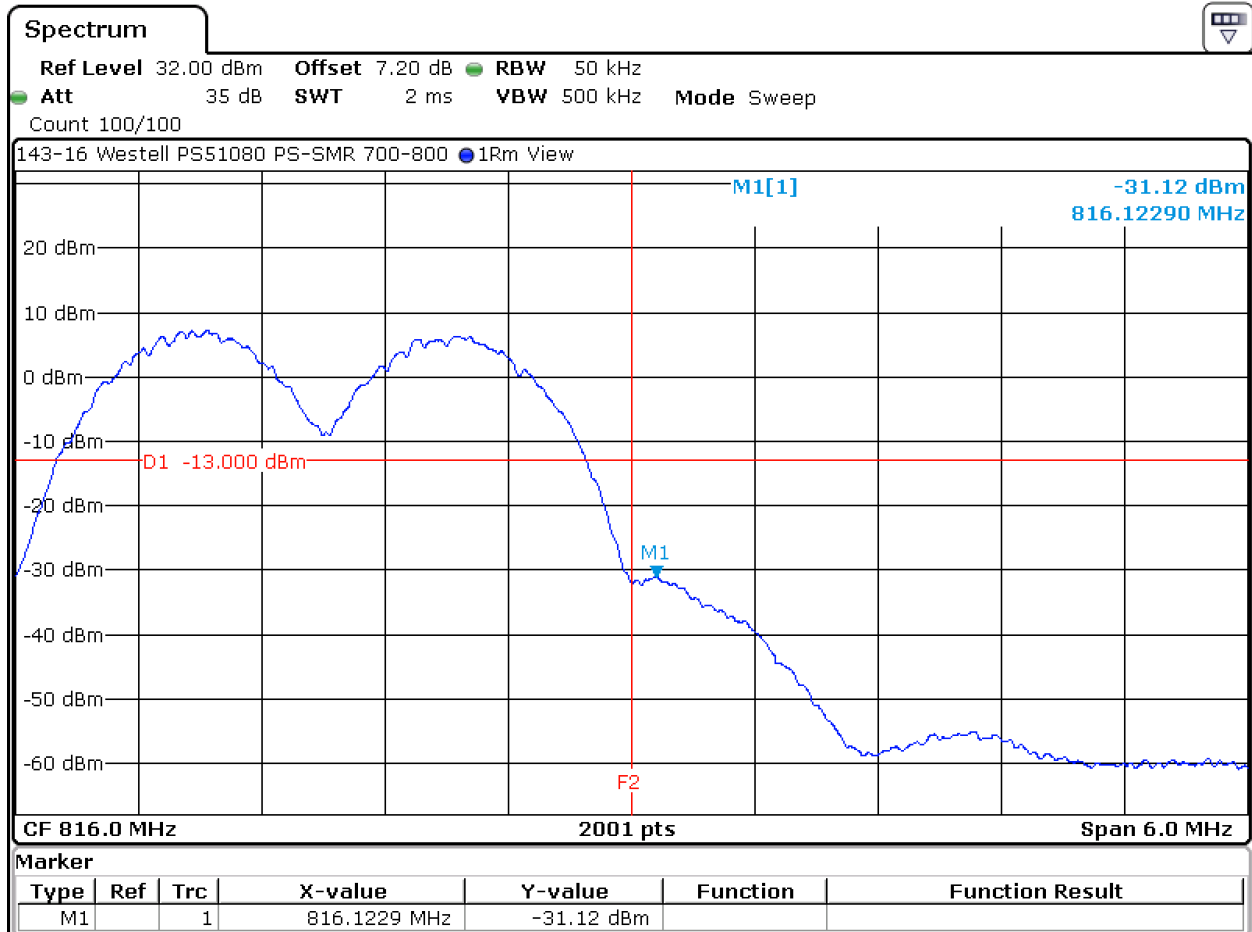

Date: 20.JAN.2016 17:20:54

6. Measurement Data (continued)

6.3. Spurious Emissions at the Antenna Terminals 90.219(e)(3), 90.669 (continued)

6.3.15. 851 MHz, Lower Bandedge

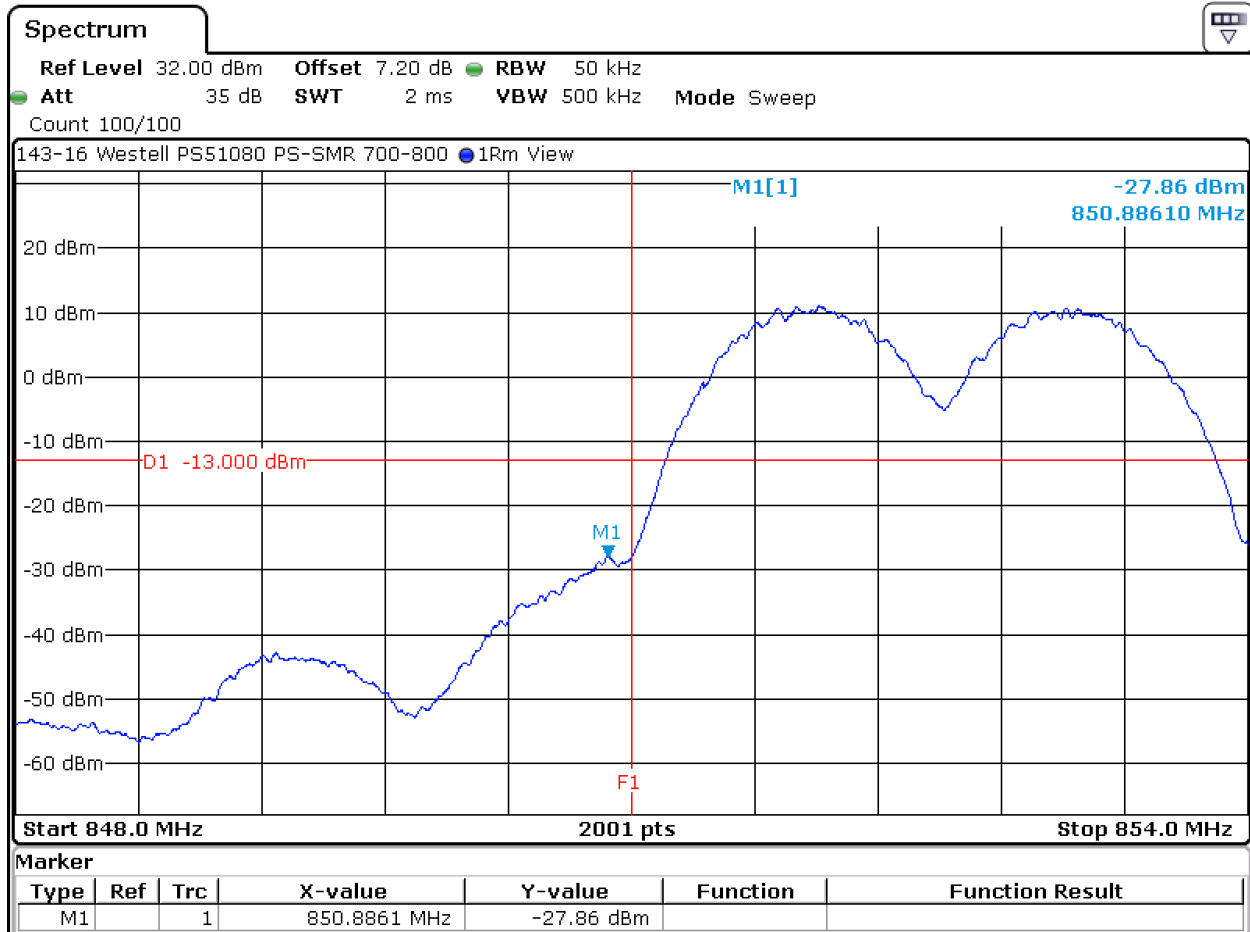

Date: 20.JAN.2016 16:23:36

6. Measurement Data (continued)

6.3. Spurious Emissions at the Antenna Terminals 90.219(e)(3), 90.669 (continued)

6.3.16. 861 MHz, Upper Bandedge

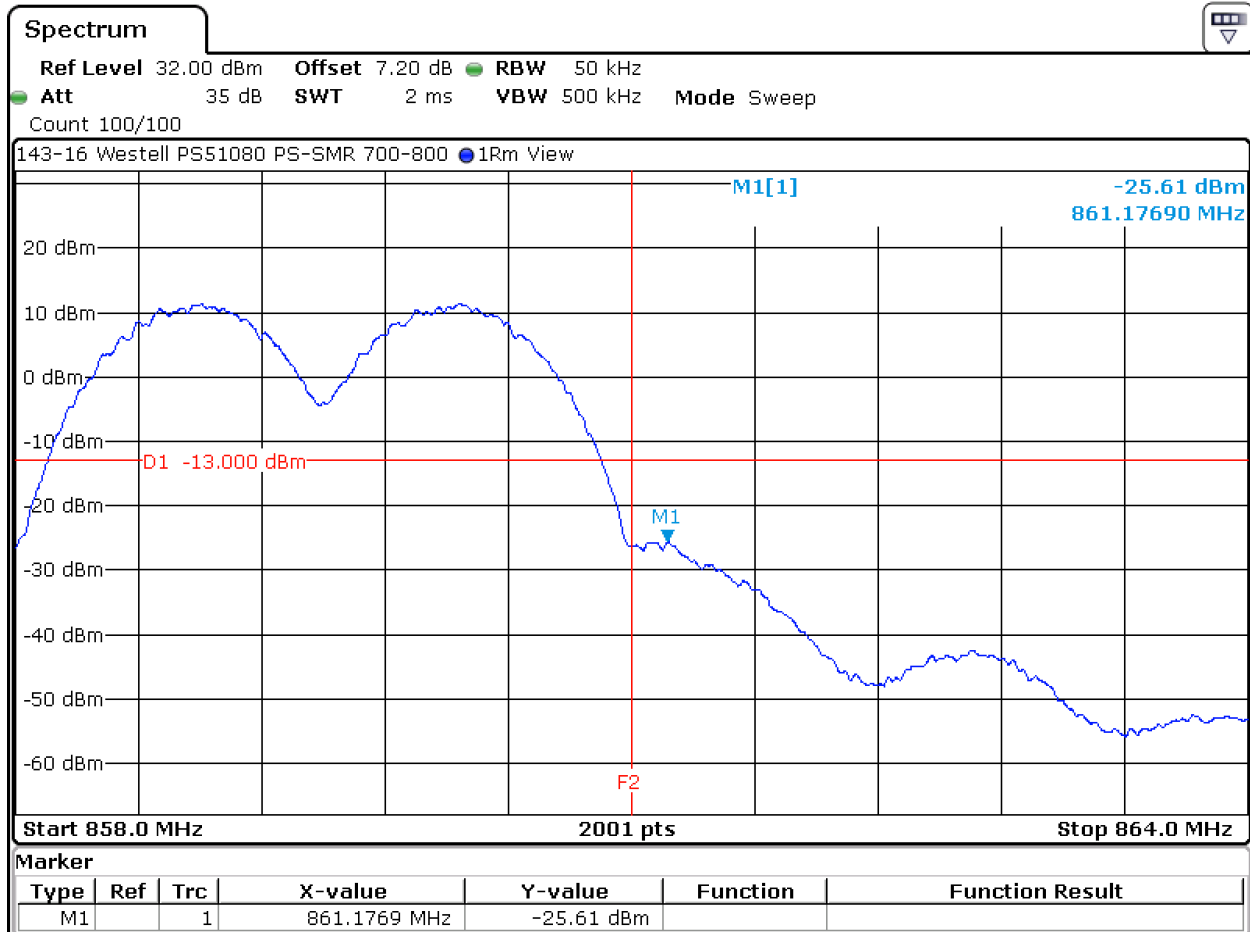

Date: 20.JAN.2016 16:24:56

6. Measurement Data (continued)

6.4. Field Strength of Spurious Emissions 90.219(e)(3), 90.669

Requirement: Transmitters designed to operate in the 806 to 824 MHz, 851 to 869 MHz, 896 to 901 MHz and 935 to 940 MHz bands, any emission outside of the MTA licensee's spectrum shall be attenuated below the transmitter power (P) by at least $43 + 10 \log (P)$ dB.

Compliance with this provision is based upon the use of measurement instrumentation employing a resolution bandwidth of 100 kHz bandwidth for frequencies less than 1 GHz, and in a 1 MHz bandwidth for frequencies greater than 1 GHz.

Test Method: KDB 935210 Section 3.8

6.4.1. Measurement and Equipment Setup

Test Date:	2/1/2016
Test Engineer:	Cody Merry
Site Temperature (°C):	22
Relative Humidity (%RH):	32
Frequency Range:	30 MHz to 1 GHz
Measurement Distance:	3 Meters
EMI Receiver IF Bandwidth:	120 kHz
EMI Receiver Avg Bandwidth:	300 kHz
Detector Functions:	Peak and Quasi-Peak.
Antenna Height:	1 to 4 meters

6.4.2 Test Procedure

Test measurements were made in accordance with ANSI C63.4-2014, Standard Methods of Measurement of Radio Noise Emissions from Low-Voltage Electrical and Electronics Equipment in the Range of 9 kHz to 40 GHz.

6. Measurement Data (continued)

6.4. Field Strength of Spurious Emissions 90.219(e)(3), 90.669 (continued)

6.4.3. Horizontal Polarity

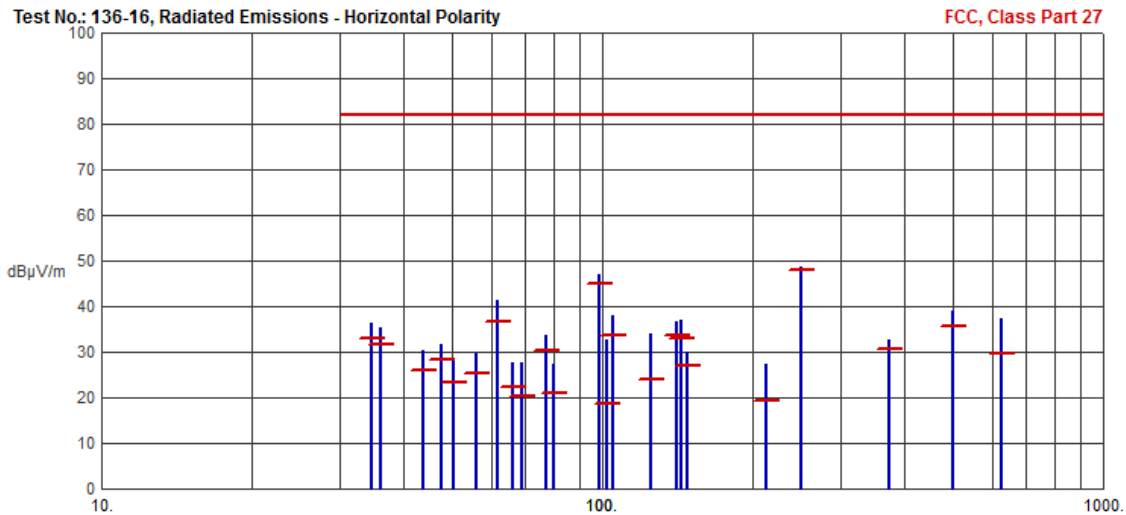

Frequency (MHz)	Pk Amp (dBµV/m)	QP Amp (dBµV/m)	QP Limit (dBµV/m)	Margin (dB)	Ant Ht (cm)	Table (Deg)	Comments
34.6273	36.17	32.87	82.00	-49.13	N/A	N/A	
36.1486	35.24	31.68	82.00	-50.32	N/A	N/A	
43.7770	30.21	26.11	82.00	-55.89	N/A	N/A	
47.7902	31.57	28.20	82.00	-53.80	N/A	N/A	
50.4102	27.88	23.31	82.00	-58.69	N/A	N/A	
55.8835	29.81	25.35	82.00	-56.65	N/A	N/A	
61.9982	41.29	36.51	82.00	-45.49	N/A	N/A	
66.2841	27.70	22.46	82.00	-59.54	N/A	N/A	
68.9830	27.82	20.31	82.00	-61.69	N/A	N/A	
77.1777	33.80	30.46	82.00	-51.54	N/A	N/A	
79.8064	27.38	20.99	82.00	-61.01	N/A	N/A	
98.4490	47.08	44.89	82.00	-37.11	N/A	N/A	
101.8657	32.55	18.82	82.00	-63.18	N/A	N/A	
104.8044	38.15	33.71	82.00	-48.29	N/A	N/A	
124.9922	34.16	24.15	82.00	-57.85	N/A	N/A	
141.1696	36.62	33.67	82.00	-48.33	N/A	N/A	
143.2824	36.87	33.09	82.00	-48.91	N/A	N/A	
148.1194	30.02	27.11	82.00	-54.89	N/A	N/A	
212.8925	27.38	19.22	82.00	-62.78	N/A	N/A	
249.9882	48.53	47.91	82.00	-34.09	N/A	N/A	
374.9902	32.50	30.63	82.00	-51.37	N/A	N/A	
499.9859	39.00	35.78	82.00	-46.22	N/A	N/A	
625.0010	37.47	29.59	82.00	-52.41	N/A	N/A	

6. Measurement Data (continued)

6.4. Field Strength of Spurious Emissions 90.219(e)(3), 90.669 (continued)

6.4.4. Vertical Polarity

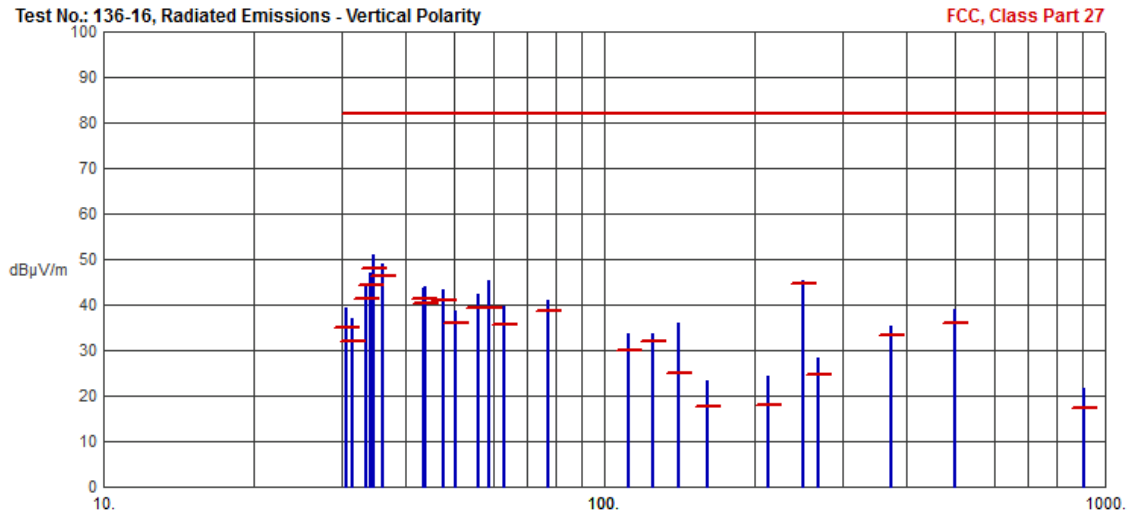

Frequency (MHz)	Pk Amp (dBµV/m)	QP Amp (dBµV/m)	QP Limit (dBµV/m)	Margin (dB)	Ant Ht (cm)	Table (Deg)	Comments
30.6174	39.24	34.97	82.00	-47.03	N/A	N/A	
31.4082	36.98	32.01	82.00	-49.99	N/A	N/A	
33.4300	43.96	41.43	82.00	-40.57	N/A	N/A	
34.0650	47.05	44.25	82.00	-37.75	N/A	N/A	
34.6388	50.99	47.95	82.00	-34.05	N/A	N/A	
36.1518	49.06	46.36	82.00	-35.64	N/A	N/A	
43.5020	43.75	41.28	82.00	-40.72	N/A	N/A	
43.8006	43.84	40.17	82.00	-41.83	N/A	N/A	
47.7690	43.30	40.91	82.00	-41.09	N/A	N/A	
50.4247	38.81	35.92	82.00	-46.08	N/A	N/A	
55.9910	42.29	39.35	82.00	-42.65	N/A	N/A	
58.7035	45.21	39.42	82.00	-42.58	N/A	N/A	
62.9352	39.69	35.62	82.00	-46.38	N/A	N/A	
77.1893	40.98	38.65	82.00	-43.35	N/A	N/A	
111.5913	33.76	29.88	82.00	-52.12	N/A	N/A	
124.9831	33.82	31.97	82.00	-50.03	N/A	N/A	
141.2108	36.05	24.96	82.00	-57.04	N/A	N/A	
161.1294	23.43	17.63	82.00	-64.37	N/A	N/A	
212.3355	24.20	17.84	82.00	-64.16	N/A	N/A	
249.9882	45.45	44.80	82.00	-37.20	N/A	N/A	
268.2679	28.31	24.51	82.00	-57.49	N/A	N/A	
374.9832	35.27	33.49	82.00	-48.51	N/A	N/A	
499.9842	38.99	35.86	82.00	-46.14	N/A	N/A	
905.0078	21.52	17.26	82.00	-64.74	N/A	N/A	

6. Measurement Data (continued)**6.4. Field Strength of Spurious Emissions 90.219(e)(3), 90.669 (continued)**

6.4.5. Measurement and Equipment Setup

Test Date:	02/01/2016
Test Engineer:	Cody Merry
Site Temperature (°C):	24
Relative Humidity (%RH):	33
Frequency Range:	Above 1 GHz
Measurement Distance:	3 Meters
EMI Receiver IF Bandwidth:	1 MHz
EMI Receiver Avg Bandwidth:	3 MHz
Detector Functions:	Peak and Average
Antenna Height:	1 to 4 meters

6.4.6. Radiated Emissions above 1 GHz

There were no measureable emissions above 1 GHz

6. Measurement Data (continued)

6.5. Frequency Stability 90.213

Requirement: Fixed and base stations designed to operating in the 806 to 809 MHz, 809 to 824 MHz, 851 to 854 MHz and 854 to 869 MHz frequency bands must meet the frequency stability requirements of this section which is either 1.0 or 1.5 ppm respectively.

Test Method: KDB 935210 Section 3.7

Note: The EUT does not translate the input frequency and therefore this testing was not performed.

6. Measurement Data (continued)

6.6. Out of Band Rejection

Requirement: Over a +/- 250 % span of the passband of the EUT measure the 20 dB bandwidth of the pass band of the EUT.

Test Method: KDB 935210 Section 3.3

6.6.1. 811 MHz Center Frequency

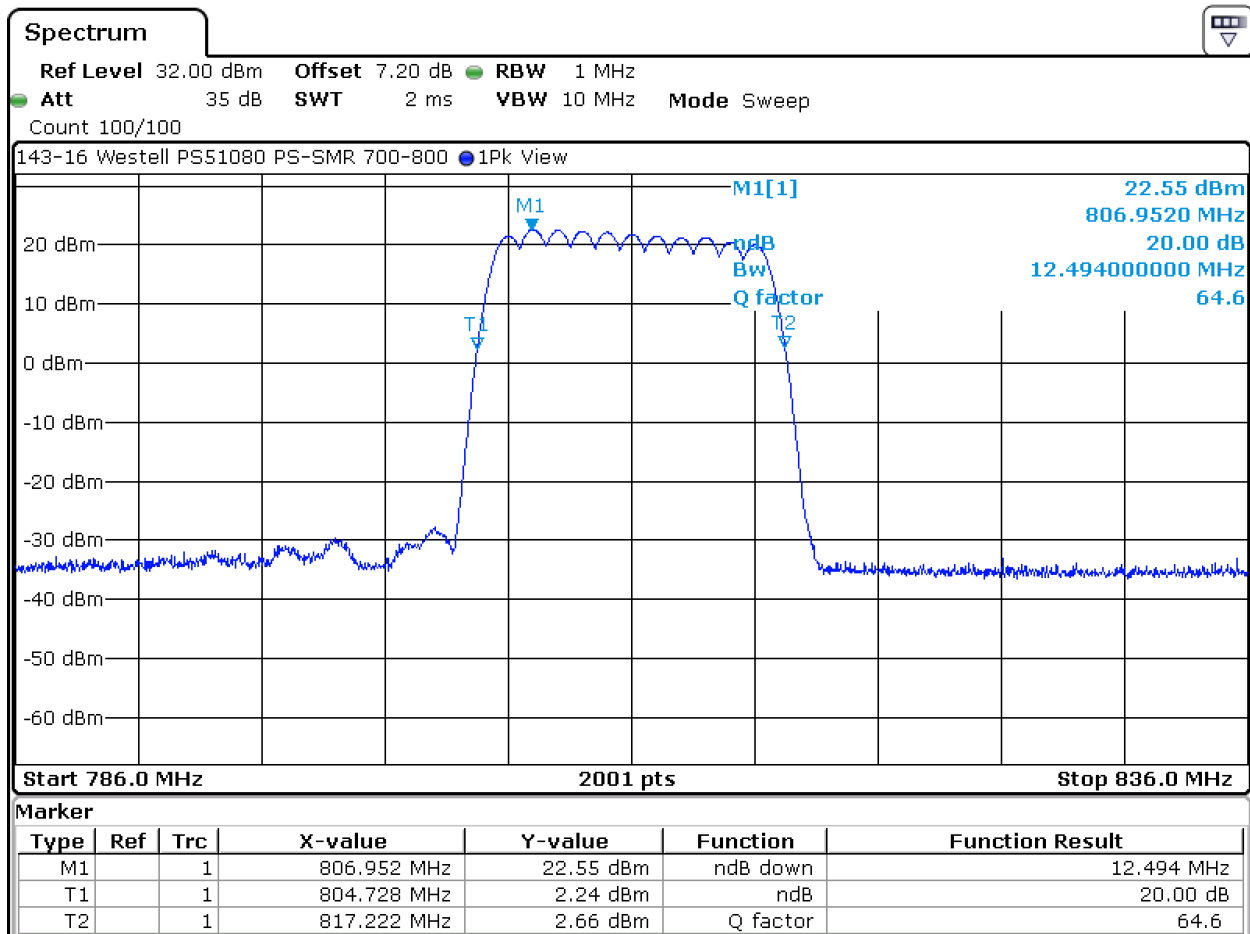

Date: 20.JAN.2016 16:58:34

6. Measurement Data (continued)

6.6. Out of Band Rejection (continued)

6.6.2. 856 MHz, Center Frequency

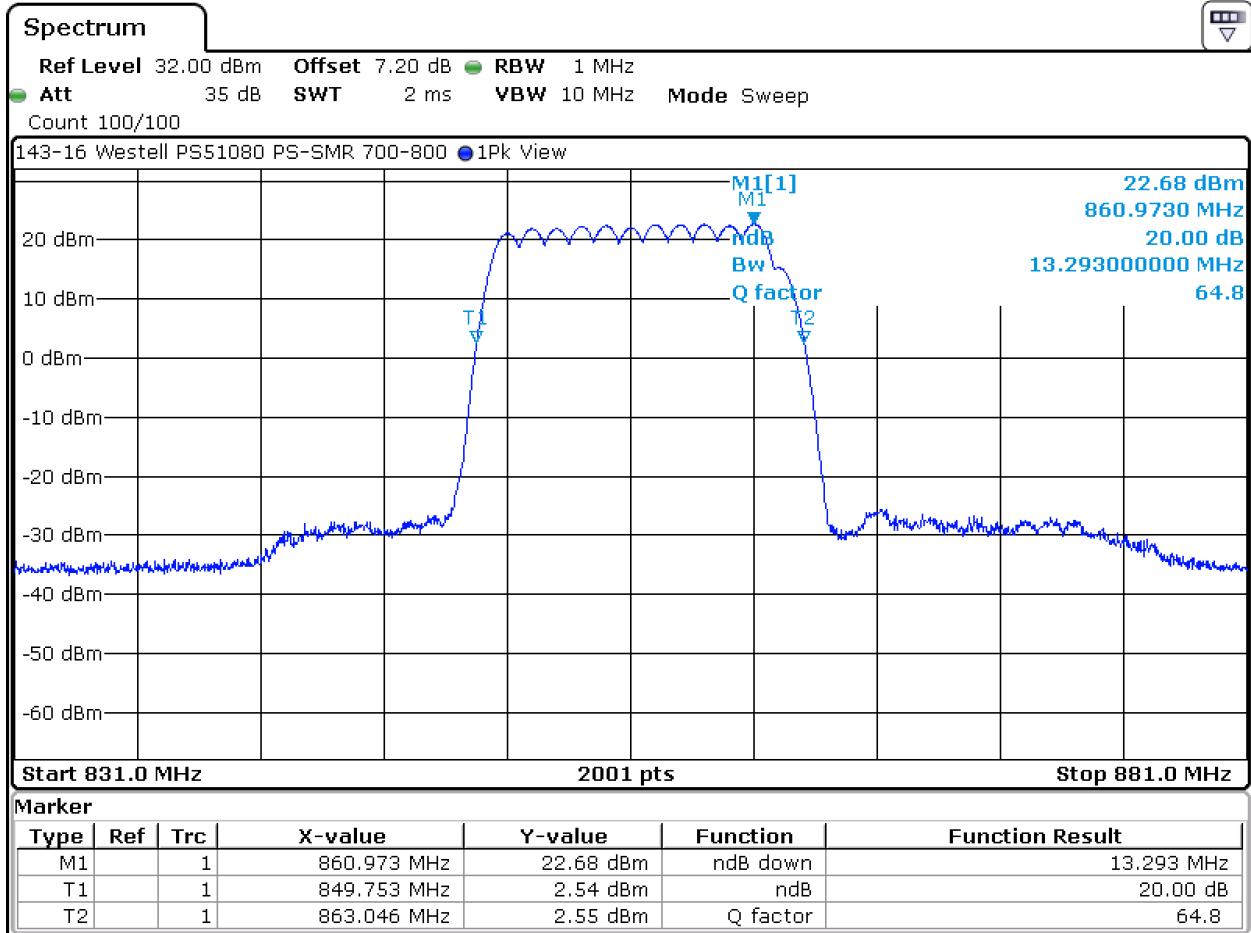

Date: 20.JAN.2016 16:43:02

6. Measurement Data (continued)

6.7. Noise Figure

Requirement: The noise figure of a signal booster must not exceed 9 dB in either direction.

Result: Compliant, 3.939 dB

6.7.1. 806 to 816 MHz band

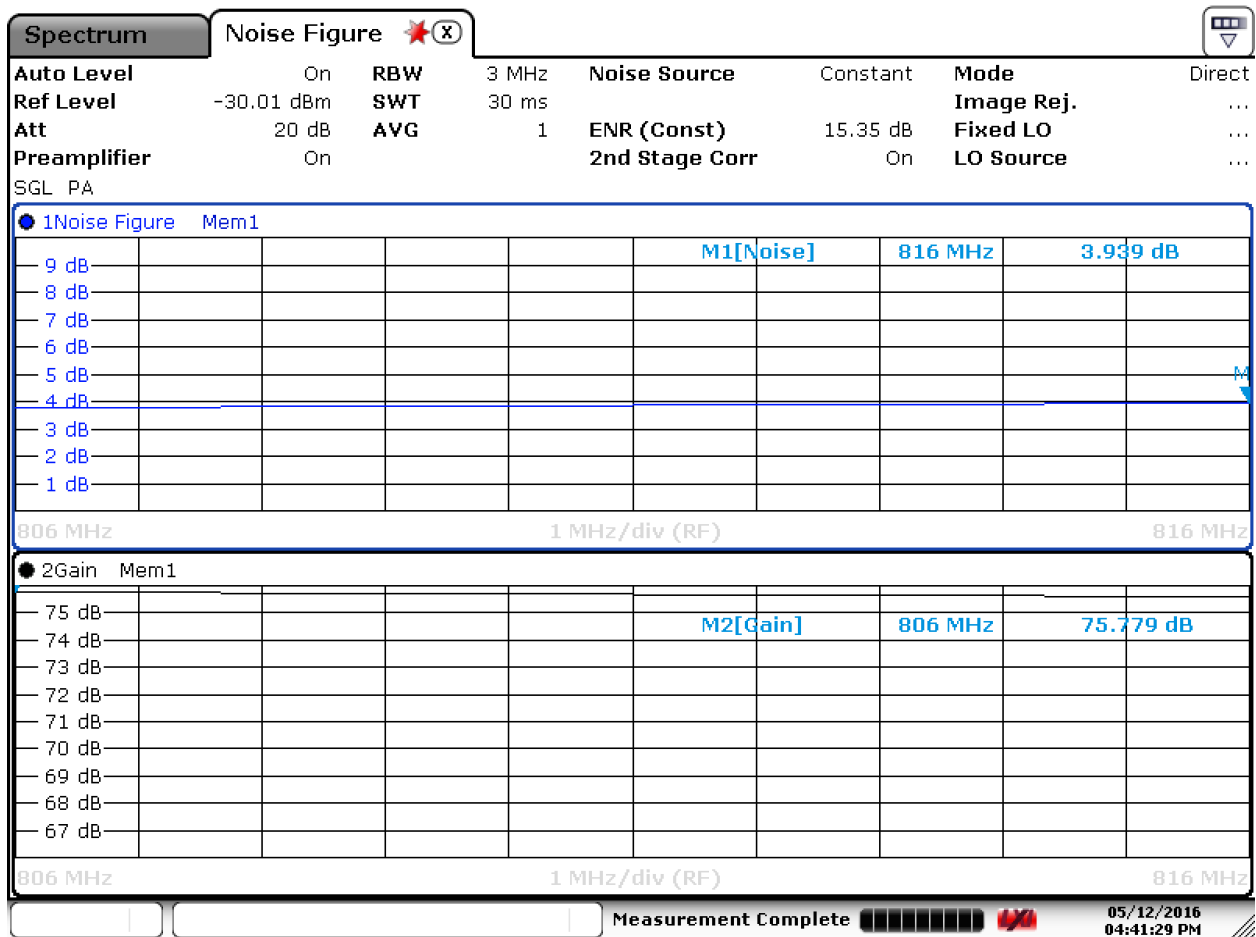

Date: 12.MAY.2016 16:41:28

6. Measurement Data (continued)

6.7. Noise Figure (continued)

Requirement: The noise figure of a signal booster must not exceed 9 dB in either direction.

Result: Compliant, 6.757 dB

6.7.2. 851 to 861 MHz band

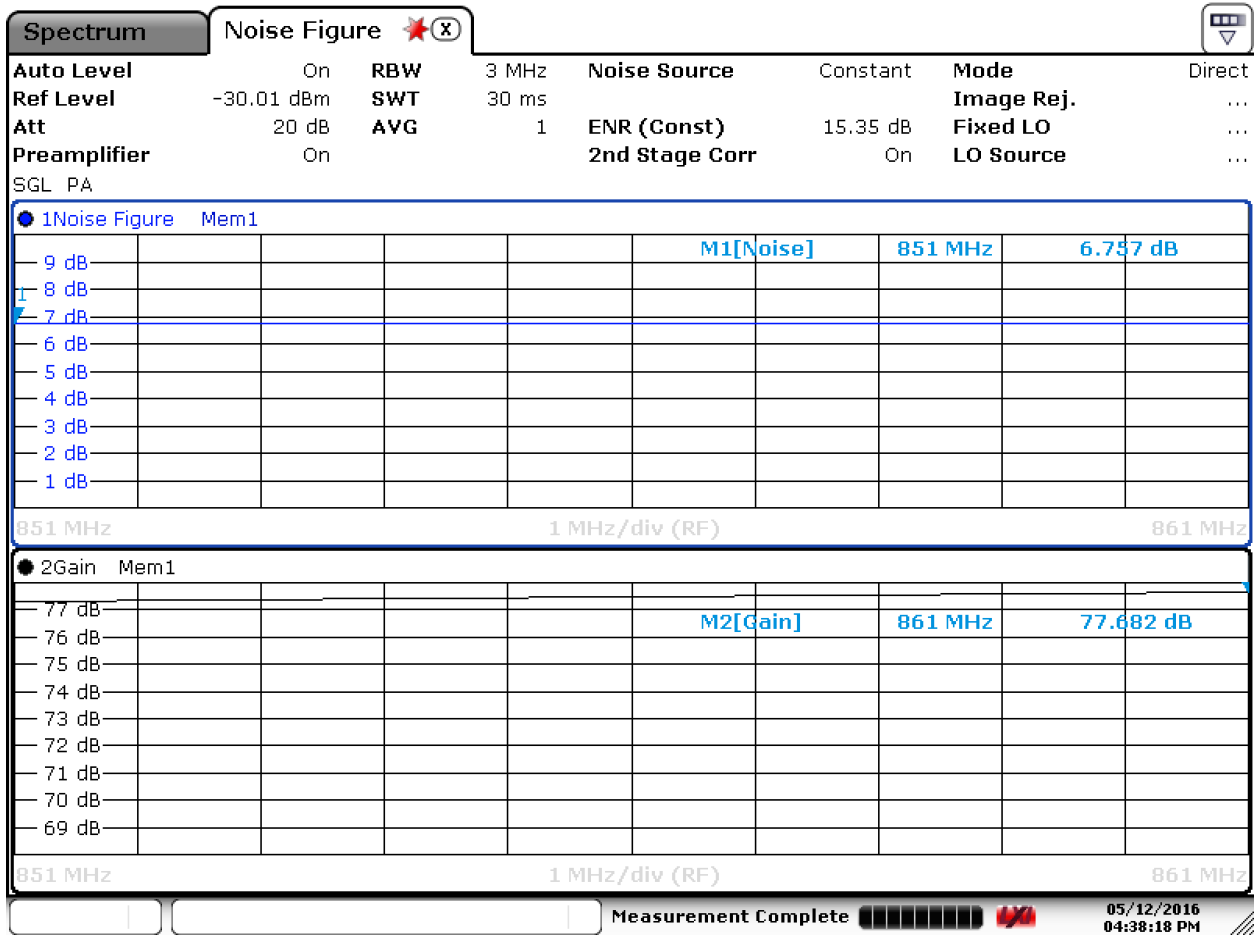

Date: 12.MAY.2016 16:38:17

6. Measurement Data (continued)**6.8. Emission Mask H 90.210(h)**

Requirement: For transmitters that are not equipment with an audio low-pass filter, the power of any emission must be attenuated below the unmodulated carrier power (P) as follows in the 806 to 809 MHz and 851 to 854 MHz bands:

(1) On any frequency removed from the center of the authorized bandwidth by a displacement frequency (f_d in kHz) of 4 kHz or less: Zero dB.

(2) On any frequency removed from the center of the authorized bandwidth by a displacement frequency (f_d in kHz) of more than 4 kHz, but no more than 8.5 kHz: At least $107 \log(f_d/4)$ dB;

(3) On any frequency removed from the center of the authorized bandwidth by a displacement frequency (f_d in kHz) of more than 8.5 kHz, but no more than 15 kHz: At least $40.5 \log(f_d/1.16)$ dB;

(4) On any frequency removed from the center of the authorized bandwidth by a displacement frequency (f_d in kHz) of more than 15 kHz, but no more than 25 kHz: At least $116 \log(f_d/6.1)$ dB;

(5) On any frequency removed from the center of the authorized bandwidth by more than 25 kHz: At least $43 \log(P)$ dB.

The EUT shall be modulated with an FM signal with an audio Frequency of 2.5 kHz and a Deviation of 5 kHz measured with a 300 Hz resolution bandwidth (RBW) against this mask.

Result: Compliant

Test Number: 143-16R2

Issue Date: 6/24/2016

6. Measurement Data (continued)

6.8. Emission Mask H 90.210(h) (continued)

6.8.1. 807 MHz Emission Mask H

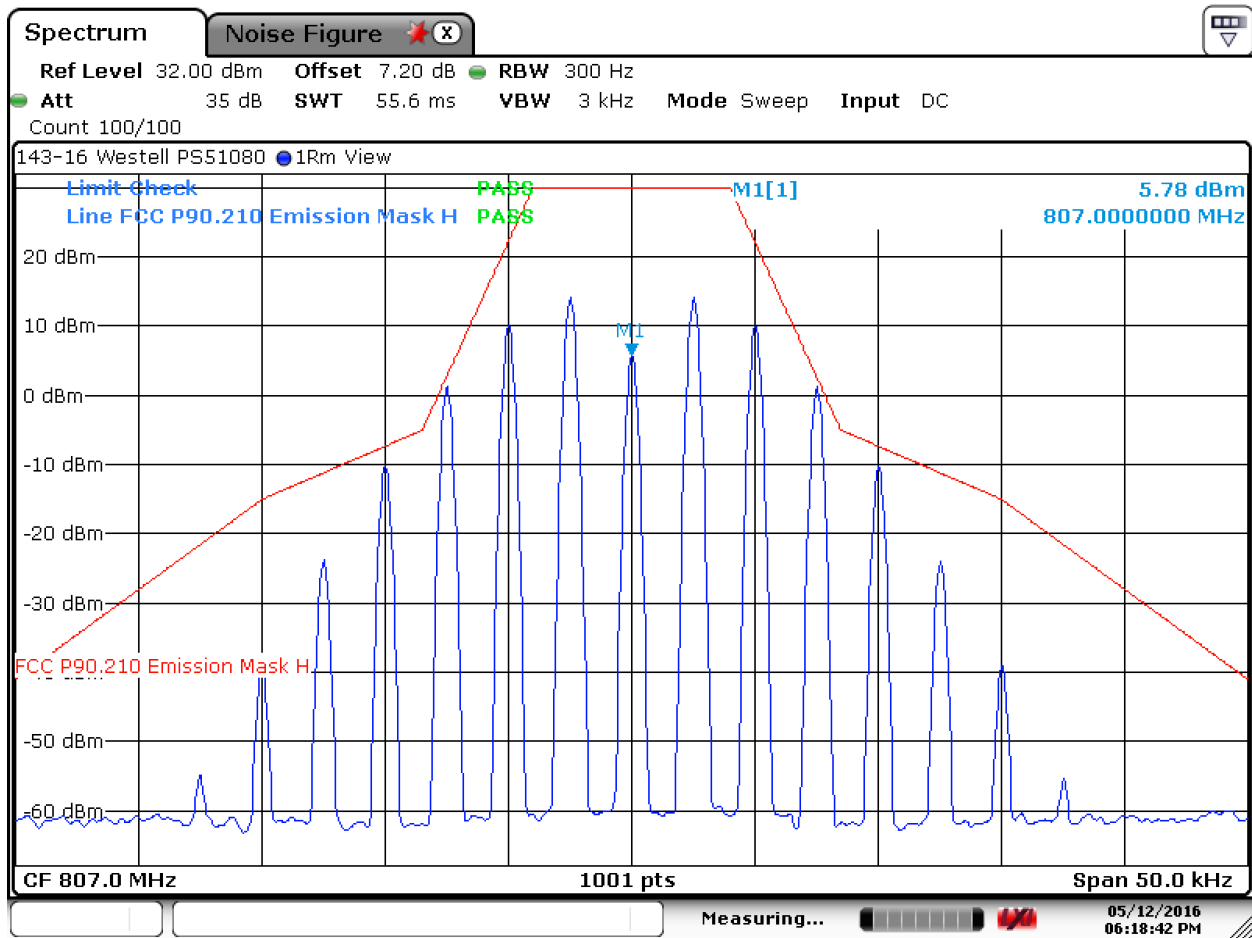

Date: 12.MAY.2016 18:18:42

Test Number: 143-16R2

Issue Date: 6/24/2016

6. Measurement Data (continued)

6.8. Emission Mask H 90.210(h) (continued)

6.8.2. 852 MHz Emission Mask H

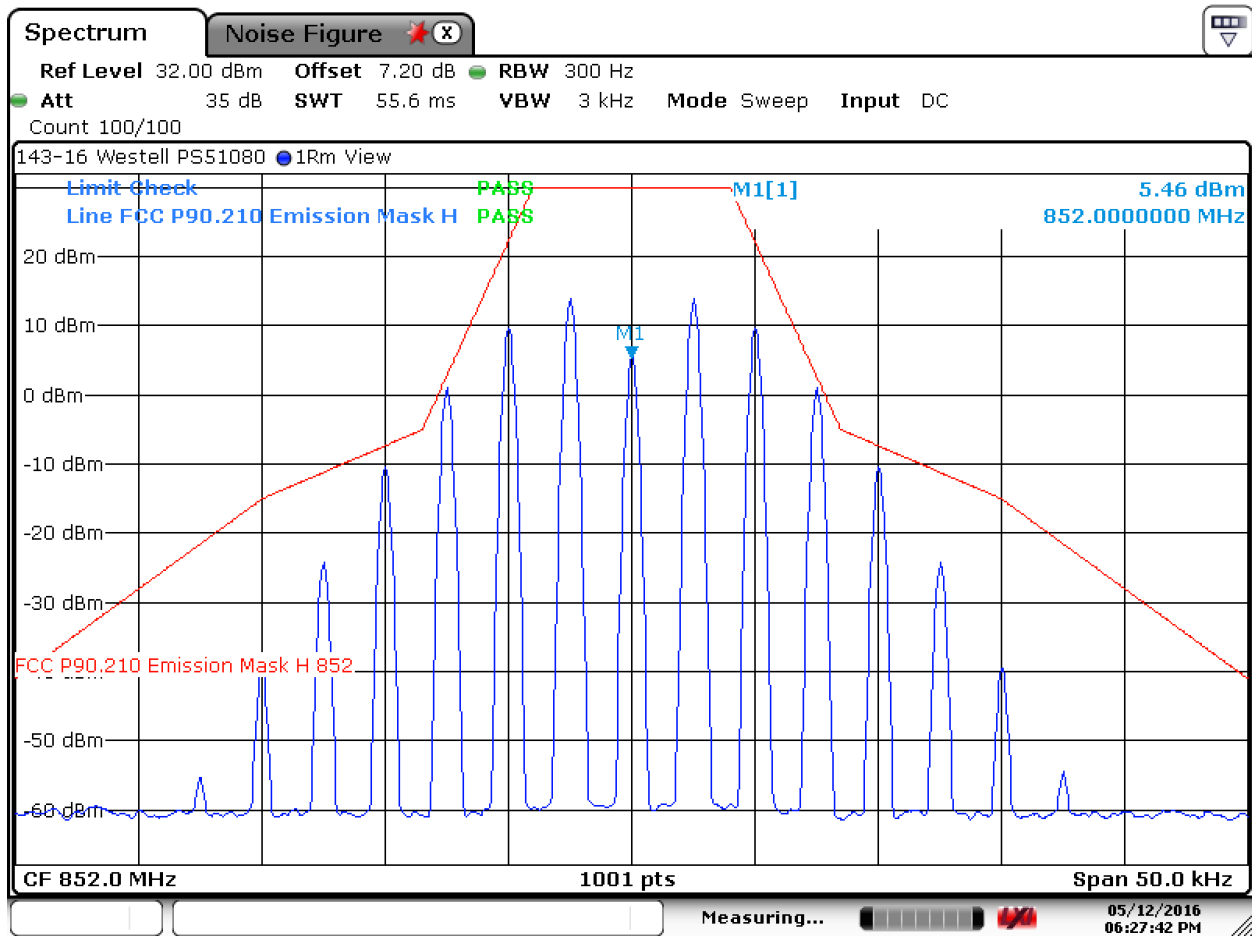

Date: 12.MAY.2016 18:27:41

6. Measurement Data (continued)

6.9. Public Exposure to Radio Frequency Energy Levels 1.1307 (b)(1)

Center Frequency (MHz)	MPE Distance (cm)	DUT Output Power (dBm)	DUT Antenna Gain (dBi)	Power Density		Limit (mW/cm ²)	Result
				(mW/cm ²)	(W/m ²)		
	(1)	(2)	(3)	(4)		(5)	
807	20.0	28.04	3.00	0.2527727	2.5277269	1	Compliant
811	20.0	27.39	3.00	0.2176357	2.1763570	1	Compliant
815	20.0	26.13	3.00	0.1628284	1.6282840	1	Compliant
852	20.0	26.79	3.00	0.1895528	1.8955277	1	Compliant
856	20.0	26.96	3.00	0.1971198	1.9711975	1	Compliant
860	20.0	27.20	3.00	0.2083196	2.0831961	1	Compliant

$$PD = \frac{OP + AG}{(4 \times \pi \times d^2)}$$

1. Reference CFR 2.1093(b): For purposes of this section, a portable device is defined as a transmitting device designed to be used so that the radiating structure(s) of the device is/are within 20 centimeters of the body of the user.
2. Section 6.1.2 of this test report. Note that the value has been adjusted to include the cable insertion loss.
3. Data supplied by the client for combination of cable loss and antenna gain.
4. Power density is calculated from field strength measurement and antenna gain.
5. Reference CFR 1.1310, Table 1: Limits for Maximum Permissible Exposure (MPE), Section (B): Limits for General Population/Uncontrolled Exposure.

7. Test Site Description

Compliance Worldwide is located at 357 Main Street in Sandown, New Hampshire. The test sites at Compliance Worldwide are used for conducted and radiated emissions testing in accordance with Federal Communications Commission (FCC) and Industry Canada standards. A description of the test sites is on file with the FCC (registration number **96392**) and Industry Canada (file number **IC 3023A-1**).

The radiated emissions test site is a 3 and 10 meter enclosed open area test site (OATS). Personnel, support equipment and test equipment are located in the basement beneath the OATS ground plane.

The conducted emissions site is part of a 16' x 20' x 12' ferrite tile chamber and uses one of the walls for the vertical ground plane required by EN 55022.

Both sites are designed to test products or systems 1.5 meter W x 1.5 meter L x 2.0 meter H, floor standing or table top.

8. Test Setup Photographs

Antenna Port Conducted Emissions



8. Test Setup Photographs (cont)

Radiated Emissions



Appendix A

RF Output Power

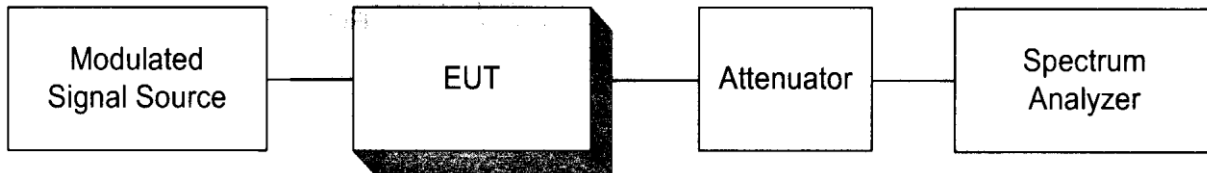

Occupied Bandwidth

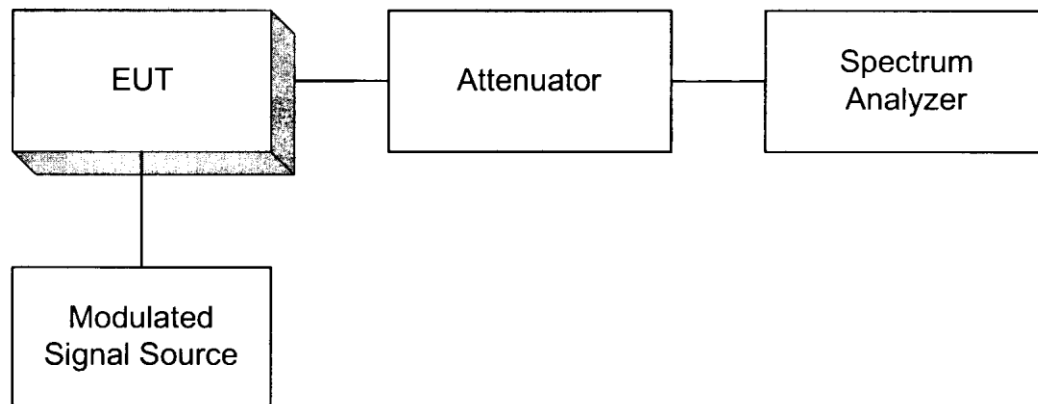

Noise Figure

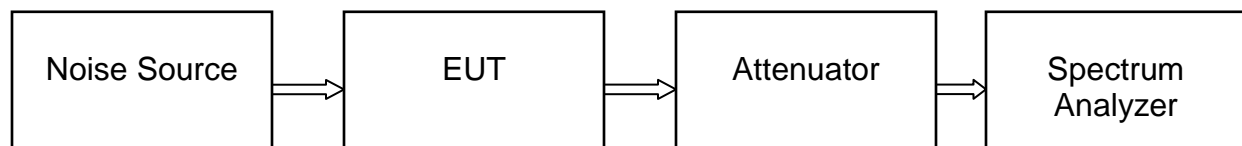

Appendix A

Spurious Emissions at the Antenna Terminals

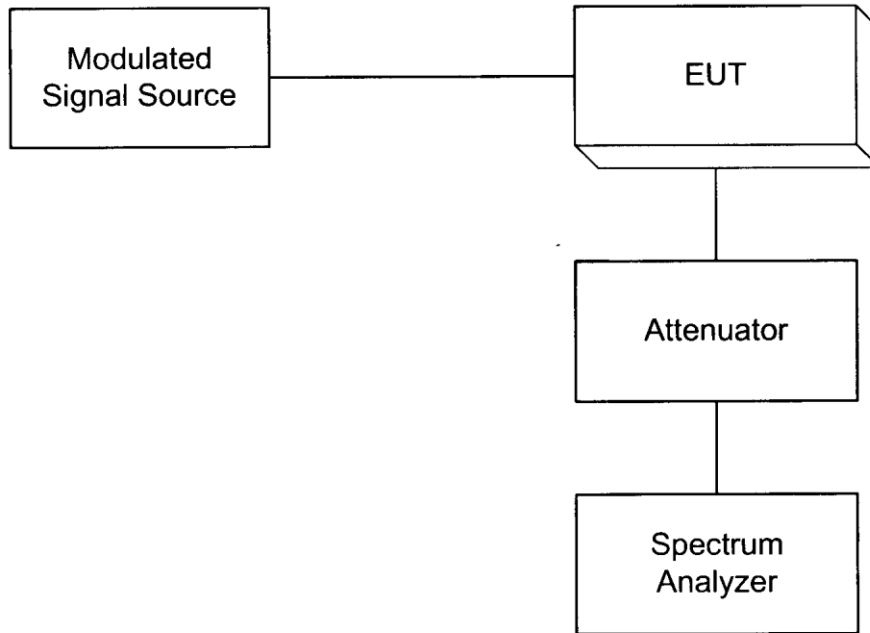

Field Strength of Spurious Radiation

