

**COMPLIANCE WORLDWIDE INC.  
TEST REPORT 205-11**

In Accordance with the Requirements of  
**FCC PART 27:2010 Subpart C**

Issued to

**Cellular Specialties, Inc.  
670 North Commercial Street  
Manchester, NH 03101  
(603) 626-6677**

for

**DSP2.5: Digital Repeater  
Model: CSI-DSP95-255-U7C**

**FCC ID: NVRCSIDSP95255U7C**

**Report Issued on April 26,2011**

Tested by

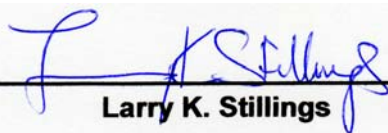
  
\_\_\_\_\_  
**Larry K. Stillings**

Reviewed By

  
\_\_\_\_\_  
**Brian F. Breault**

This test report shall not be reproduced, except in full, without written permission from Compliance Worldwide, Inc.

## Table of Contents

1. Scope .....	3
2. Product Details .....	3
2.1. Manufacturer .....	3
2.2. Model Number .....	3
2.3. Serial Number .....	3
2.4. Description .....	3
2.5. Power Source .....	3
2.6. Software Version .....	3
2.7. EMC Modifications .....	3
3. Product Configuration .....	3
3.1. Support Equipment .....	3
3.2. Cables .....	3
3.3. Operational Characteristics & Software .....	4
3.4. Block Diagram .....	4
4. Measurement Parameters .....	5
4.1. Measurement Equipment Used to Perform Test .....	5
4.2. Measurement & Equipment Setup .....	5
4.3. Test Procedure .....	5
5. Measurement Summary .....	6
6. Measurement Data .....	7
6.1. Power and Antenna Height Limits 27.50 (b)(4) .....	7
6.2. Bandwidth Limitations (FCC Part 2.1049) .....	10
6.3. Spurious Emissions at the Antenna Terminals 27.53 (c) .....	13
6.4. Spurious Emissions at the Antenna Terminals - Additional Requirements 27.53(f) .....	19
6.5. Field Strength of Spurious Emissions 27.53 (c) .....	20
6.6. Frequency Stability 27.54 .....	24
6.7. Inter-modulation .....	25
6.8. Public Exposure to Radio Frequency Energy Levels 1.1307 (b)(1) .....	26
7. Test Site Description .....	27
8. Test Setup Photographs .....	28
Appendix A .....	30

**1. Scope**

This test report certifies that the Cellular Specialties DSP95: Digital Repeater 2.5 U7C, as tested, meets the FCC Part 27 Subpart C requirements. The scope of this test report is limited to the test sample provided by the client, only in as much as that sample represents other production units. If any significant changes are made to the unit, the changes shall be evaluated and a retest may be required.

**2. Product Details**

- 2.1. Manufacturer:** Cellular Specialties
- 2.2. Model Number:** CSI-DSP95-255-U7C
- 2.3. Serial Number:** 1 – Hardware Rev F
- 2.4. Description:** The CSI Digital Repeater is designed for use within enclosed structures where sufficient signal from local cell sites to operate cell phones or data cards is limited or unavailable. Adequate signal must be available outside the structure as a prerequisite to achieving in-building coverage. The CSI-DSP95-255-U7C provides 95 dB of gain in the 746-757 MHz Downlink and 776-787 MHz Uplink bands.
- 2.5. Power Source:** 120 VAC, 60 Hz
- 2.6. Software Version:** 02.0700rc30
- 2.7. EMC Modifications:** None

**3. Product Configuration**

**3.1. Support Equipment**

Device	Manufacturer	Model	Serial No.	Comment
RF Signal Generator	Rohde & Schwarz	SMIQ06B	10090	Generating W-CDMA Signals
Power Supply	DuraComm Corp	SM-250-48	020896	
Notebook PC	Dell	Latitude C400	9760689253	Configuring Unit

**3.2. Cables**

Cable Type	Length	Shield	From	To
RF, 50 Ω, N male – N male	1M	Yes	DUT	Signal Generator
RF, 50 Ω, N male – N male	1M	Yes	DUT	50 Ω Load
Power Supply	2M + 2M	Yes	DUT	120 VAC, 60 Hz
Serial 1	2M	Yes	DUT	Notebook PC
USB 1	2M	Yes	DUT	Notebook PC
Ethernet	2M	No	DUT	Notebook PC

Notebook PC is connected only during setup

### 3. Product Configuration (continued)

#### 3.3. Operational Characteristics & Software

- (1) The unit was allowed to power up normally and go through its configuration cycle.
- (2) Using an RF Signal Generator on the Input and a Spectrum Analyzer on the output Downlink or Uplink frequencies a signal was generated over the intended bandwidth of operation.
- (3) The signal generator was configured to provide several digital modulations to the input of the amplifier including W-CDMA w/ QPSK, 16QAM and 64QAM modulations.
- (4) After examining each of the modulation types it was determined that W-CDMA with QPSK at 11 MS/s provided the worst case configuration.
- (5) The units internal AGC circuitry was toggled on and off to determine the maximum output power for each of the Uplink and Downlink frequencies and still maintain compliance with the standard.

#### 3.4. Block Diagram

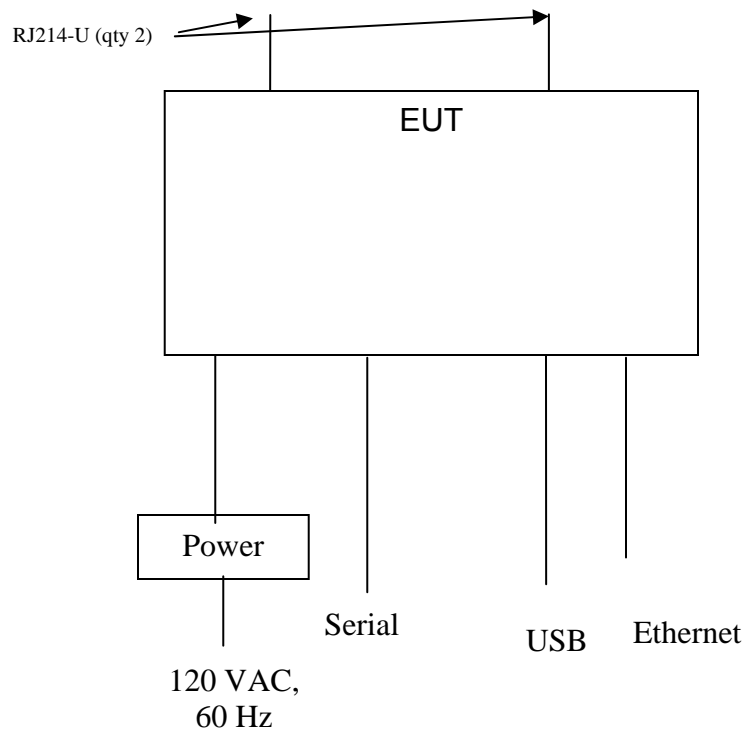

#### 4. Measurements Parameters

##### 4.1. Measurement Equipment Used to Perform Test

Device	Manufacturer	Model No.	Serial No.	Cal Due
Spectrum Analyzer	Agilent	E4407B	MY45104493	12/22/2012
EMI Receiver	Hewlett Packard	8546A	3330A00115	10/28/2011
Microwave Preamp	Hewlett Packard	8449B	3008A01323	12/1/2012
Bilog Antenna	Com-Power	AC-220	25509	8/30/2011
Horn Antenna	Electro-Metrics	EM-6961	6337	10/19/2012
RF Signal Generator	Rohde & Schwarz	SMIQ06B	100090	12/17/2012
Power Attenuator	Aeroflex / Weinschel	41-10-12	75411	CBU
Power Attenuator	Pasternack	PE7017-6	Cal ID# 233	CBU

##### 4.2. Measurement & Equipment Setup

Test Date: 4/8 to 4/27 2011  
 Test Engineer: Larry Stillings  
 Normal Site Temperature (15 – 35°C): 24  
 Relative Humidity (20 -75%RH): 33

##### 4.3. Test Procedure

The test measurements contained in this report are based on the requirements detailed in FCC Part 27, Subpart C.

The test methods used to generate the data in this test report are in accordance with ANSI C63.4:2009, American National Standard for Methods of Measurement of Radio-Noise Emissions from Low-Voltage Electrical and Electronic Equipment in the Range of 9 kHz to 40 GHz.

Measurements were made in accordance with TIA-603-C:2004 Land Mobile FM or PM Communications Equipment Measurement and Performance Standard.

**5. Measurement Summary**

Section Description or Test Requirement	FCC Part 27 Reference	Test Report Section	Result	Comment
Power and Antenna height limits, Output Power	27.50	6.1	Compliant	
Occupied Bandwidth	Part 2.1049	6.2	Compliant	
Spurious Emissions at Antenna Terminals	27.53 (c)	6.3	Compliant	
Spurious Emissions at the Antenna Terminals Additional Requirements	27.53 (f)	6.4	Compliant	
Field Strength of Spurious Emissions	27.53 (c)	6.5	Compliant	
Frequency Stability	27.54	6.6	N/A	The EUT does not translate the frequency of the input signal
Inter-modulation	N/A	6.7	Compliant	
Public Exposure to Radio Frequency Energy Levels	Section 1.1307 (b)(1)	6.8	Compliant	

6. Measurement Data

6.1. Power and Antenna Height Limits 27.50 (b)(4)

Requirement: Fixed and base stations transmitting a signal in the 746-757 MHz, 758-763 MHz, 776-787 MHz and 788-793 MHz bands with an emissions bandwidth greater than 1 MHz must not exceed an ERP of 1000 watts/MHz and an antenna height of 305 m HAAT.

6.1.1. Peak Transmitter Output Power, Transmitter Only

Upper C Bands	Frequency	Output Power	
	(MHz)	(W)	(dBm)
Downlink	746-757 MHz	6.531	38.15
Uplink	776-787 MHz	0.841	29.25

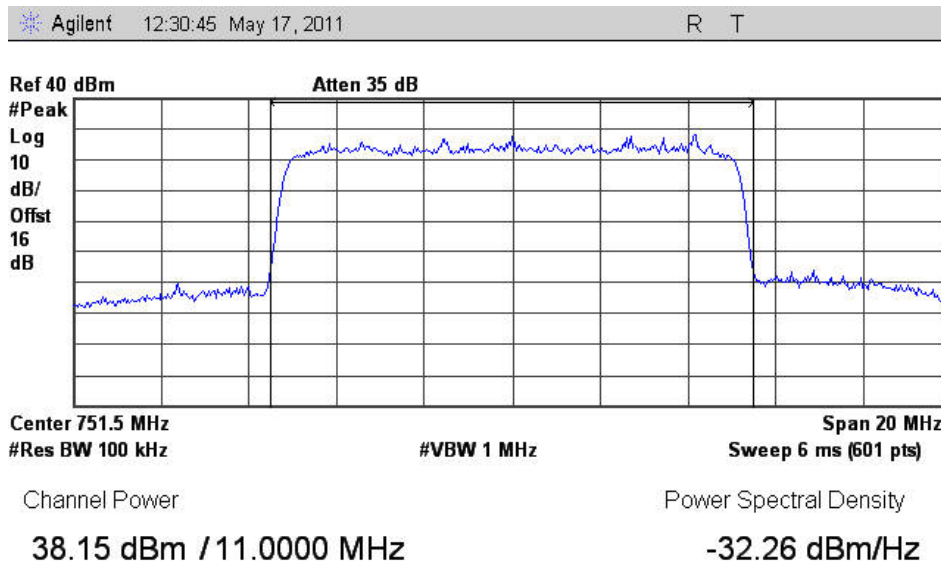

6. Measurement Data

6.1. Power and Antenna Height Limits 27.50 (b)(4) (cont)

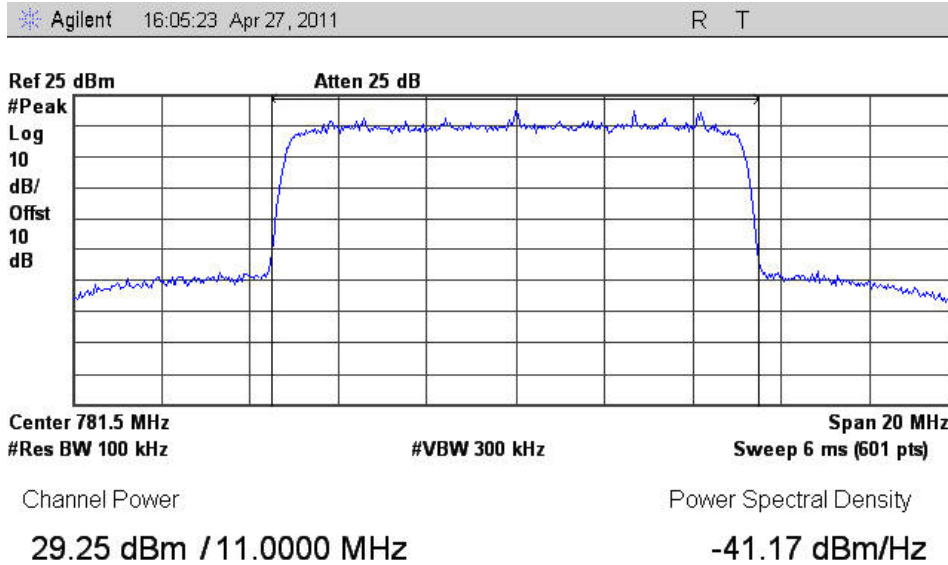



**6. Measurement Data**

**6.1. Power and Antenna Height Limits (continued)**

**6.1.2. Maximum ERP**

ERP is defined in FCC Title 47, Chapter I, Part 2, Subpart A, Section 2.1 as "Effective Radiated Power. The product of the power supplied to the antenna and its gain relative to a half-wave dipole in a given direction."

$$\text{ERP} = \text{Transmitter Power (dBm)} - \text{Cable Loss (dB)} + \text{Antenna Gain (dBi)}$$

The manufacturer of the device under test recommends 2 antennas for use with their product. The following table provides the worst case effective radiated power based on the measured transmitter output power and the antenna gain:

	Frequency	Transmitter Power <sup>1</sup>	Cable Insertion Loss	Antenna Gain <sup>2</sup>	Total Output Power	
	(MHz)	(dBm)	(dB)	(dBi)	(dBm)	(Watts)
Downlink	746-757	38.15	0.00	+3	41.15	13.03
Uplink	776-787	29.25	0.00	+3	32.25	1.68
Downlink	746-757	38.15	0.00	+14	52.15	164.05
Uplink	776-787	29.25	0.00	+14	43.25	21.13

<sup>1</sup> Measured. See section 6.1.1.

<sup>2</sup> Customer supplied. 3 dBi for Indoor Applications, 14 dBi for Outdoor Applications

**6. Measurement Data (continued)**

**6.2. Bandwidth Limitations (FCC Part 2.1049)**

Requirement: Each authorization issued to a station licensed under this part will show an emission designator representing the class of emission authorized. The designator will be prefixed by a specified necessary bandwidth. This number does not necessarily indicate the bandwidth occupied by the emission at any instant.

**6.2.1. Occupied (99% Power) Bandwidth**

	Frequency	Occupied Bandwidth	Result
	(MHz)	(MHz)	
Downlink	746-757	10.0402	Compliant
Uplink	776-787	10.0336	Compliant

NOTE: A slightly wider input signal was used then the bandwidth required to demonstrate the digital filtering of the EUT's output signal.

**6.2.1.1. Occupied (99% Power) Bandwidth Measurement, 746-757 MHz**

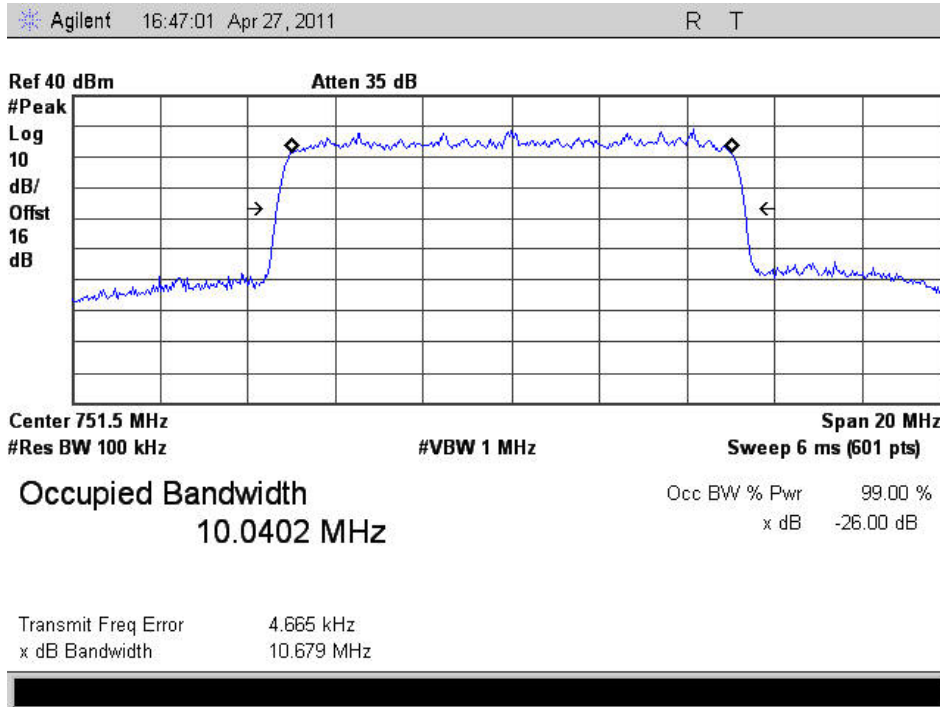

6. Measurement Data (continued)

6.2. Bandwidth Limitations (FCC Part 2.1049) (continued)

6.2.1. Occupied (99% Power) Bandwidth (continued)

6.2.1.2. Occupied (99% Power) Bandwidth Input Signal, 746-757 MHz

Agilent 16:37:05 Apr 27, 2011 R T

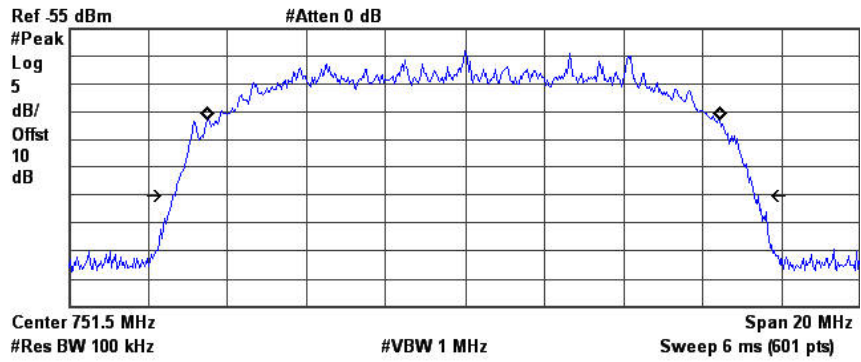

Occupied Bandwidth 12.9152 MHz  
Occ BW % Pwr 99.00 %  
x dB -26.00 dB

Transmit Freq Error -38.172 kHz  
x dB Bandwidth 14.746 MHz

6.2.1.3. Occupied (99% Power) Bandwidth Measurement, 776-787 MHz

Agilent 16:11:31 Apr 27, 2011 R T

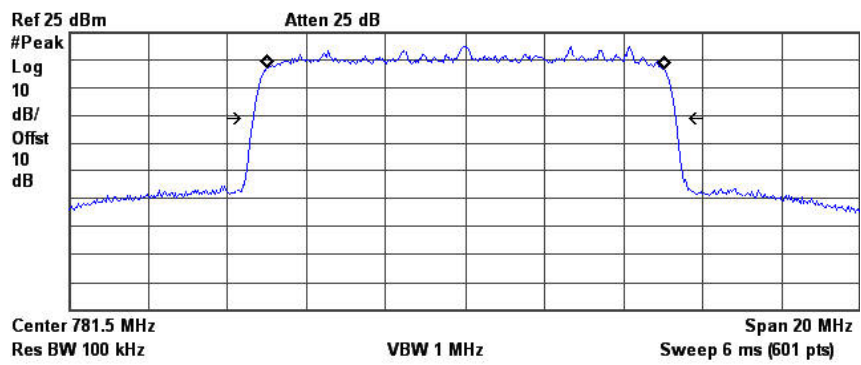

Occupied Bandwidth 10.0336 MHz  
Occ BW % Pwr 99.00 %  
x dB -26.00 dB

Transmit Freq Error 1.724 kHz  
x dB Bandwidth 10.676 MHz

**6. Measurement Data (continued)**

**6.2. Bandwidth Limitations (FCC Part 2.1049) (continued)**

**6.2.1. Occupied (99% Power) Bandwidth (continued)**

**6.2.1.4. Occupied (99% Power) Bandwidth Input Signal, 776-787 MHz**

Agilent 16:36:04 Apr 27, 2011 R T

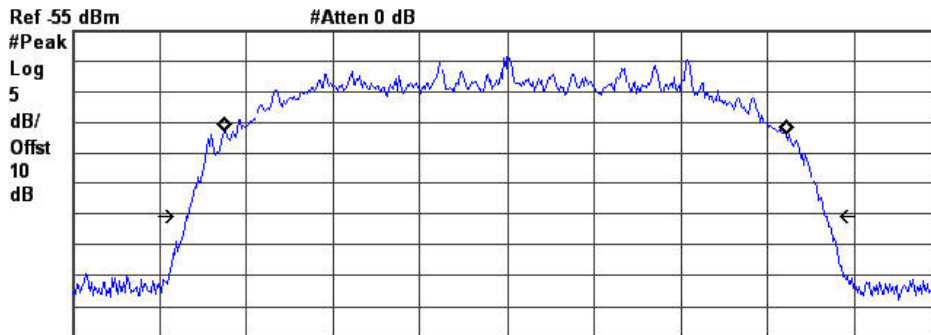

Center 781.5 MHz #Res BW 100 kHz #VBW 1 MHz Span 20 MHz Sweep 6 ms (601 pts)

**Occupied Bandwidth**  
**12.9149 MHz**

Occ BW % Pwr 99.00 %  
x dB -26.00 dB

Transmit Freq Error -26.169 kHz  
x dB Bandwidth 14.659 MHz



6. Measurement Data (continued)

6.3. Spurious Emissions at the Antenna Terminals 27.53 (c)

Requirement: For operations in the 746-758 MHz band and the 776-788 MHz band, the power of any emission outside of the licensee's frequency band(s) of operation shall be attenuated below the transmitter power (P) within the licensed band(s) of operation, measured in watts, in accordance with the following:

(1) On any frequency outside of the 746-758 MHz band, the power of any emission shall be attenuated outside the band below the transmitter power (P) by at least  $43 + 10 \log (P)$  dB;

(2) On any frequency outside of the 776-787 MHz band, the power of any emission shall be attenuated outside the band below the transmitter power (P) by at least  $43 + 10 \log (P)$  dB;

(3) On all frequencies between 763-775 MHz and 793-805 MHz, by a factor not less than  $76 + 10 \log (P)$  in a 6.25 KHz band segment for base and fixed stations;

(5) Compliance with the provisions of paragraphs (c)(1) and (c)(2) of this section is based upon the use of measurement instrumentation employing a resolution bandwidth of 100 kHz or greater. However, in the 100 kHz bands immediately outside and adjacent to the frequency block a resolution bandwidth of 30 kHz may be employed.

6.3.1. 746-757 MHz, 30 MHz to 1 GHz

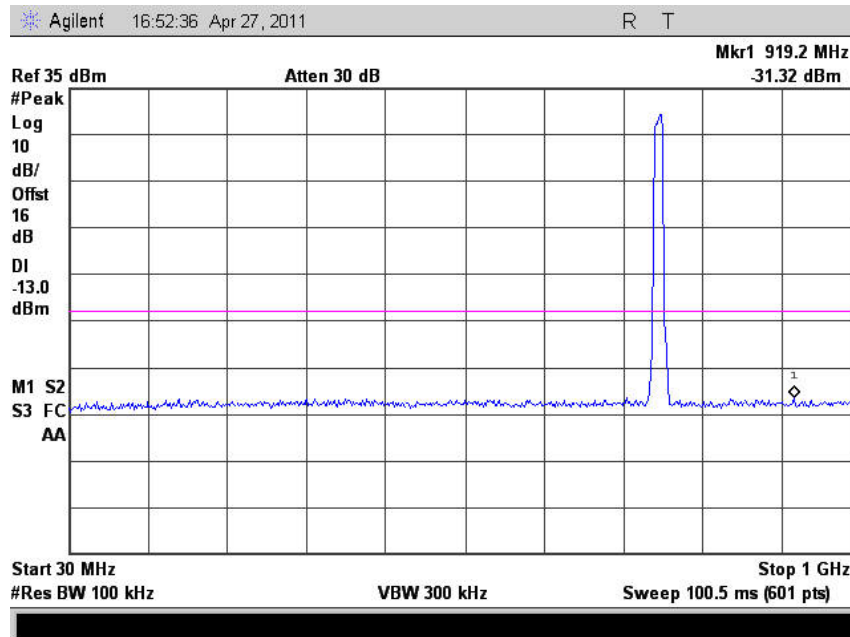

6. Measurement Data (continued)

6.3. Spurious Emissions at the Antenna Terminals 27.53 (c) (continued)

6.3.2. 746-757 MHz, 1 to 26.5 GHz

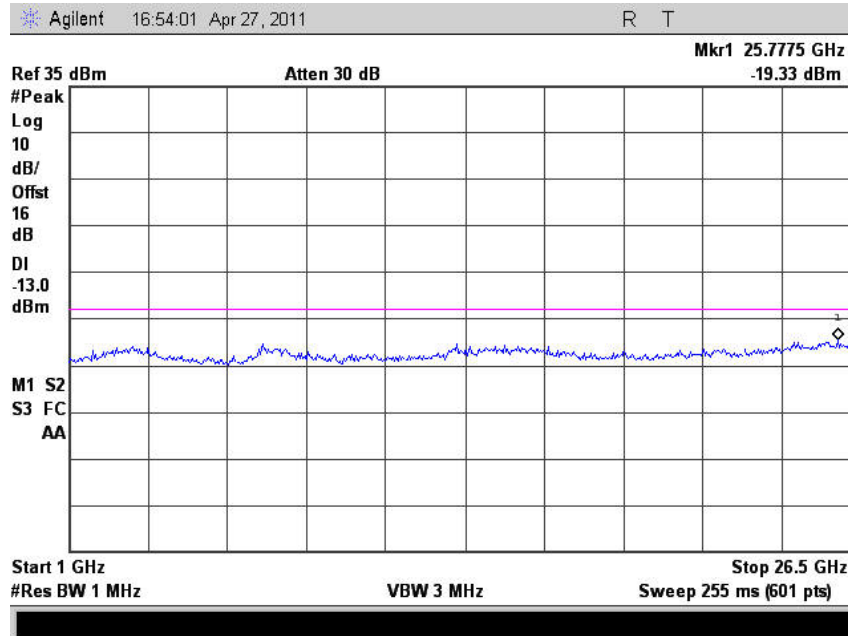

6.3.3. 776-787 MHz, 30 MHz to 1 GHz

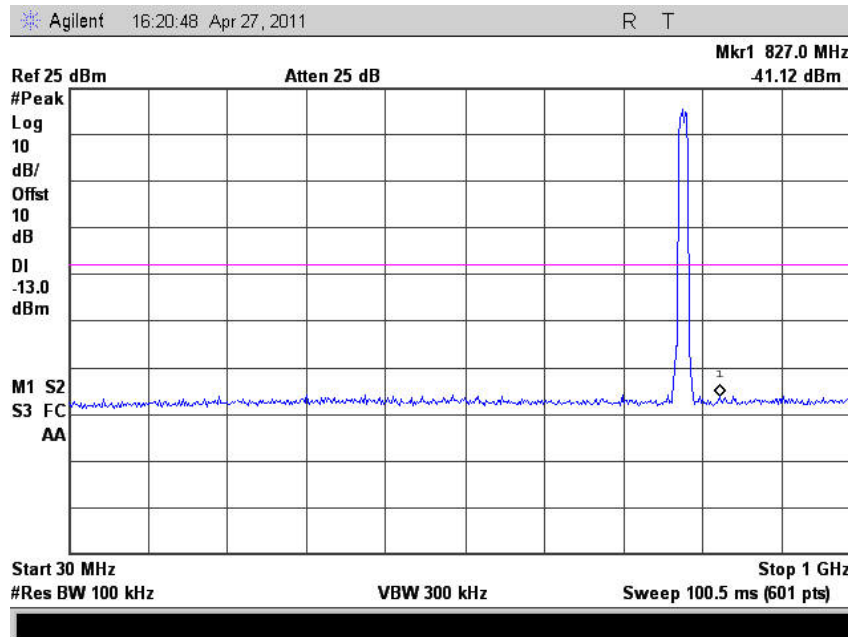

6. Measurement Data (continued)

6.3. Spurious Emissions at the Antenna Terminals 27.53 (c) (continued)

6.3.4. 776-787 MHz, 1 to 26.5 GHz

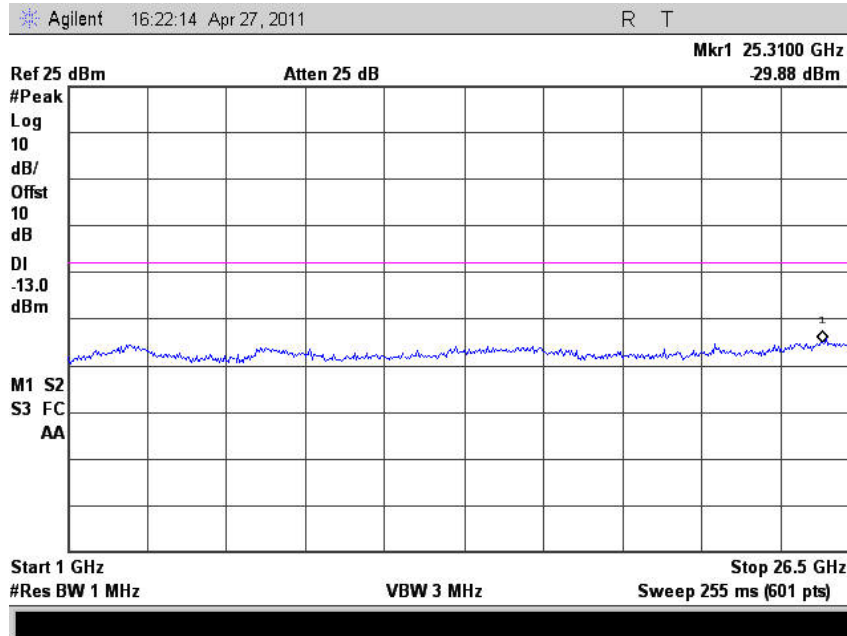

6.3.5. 763-775 MHz

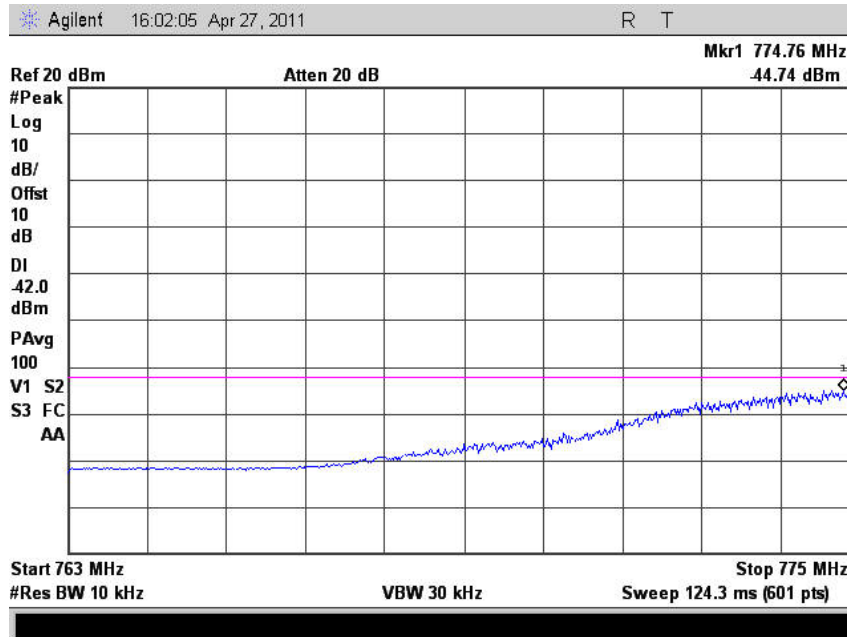

6. Measurement Data (continued)

6.3. Spurious Emissions at the Antenna Terminals 27.53 (c) (continued)

6.3.6. 793-805 MHz

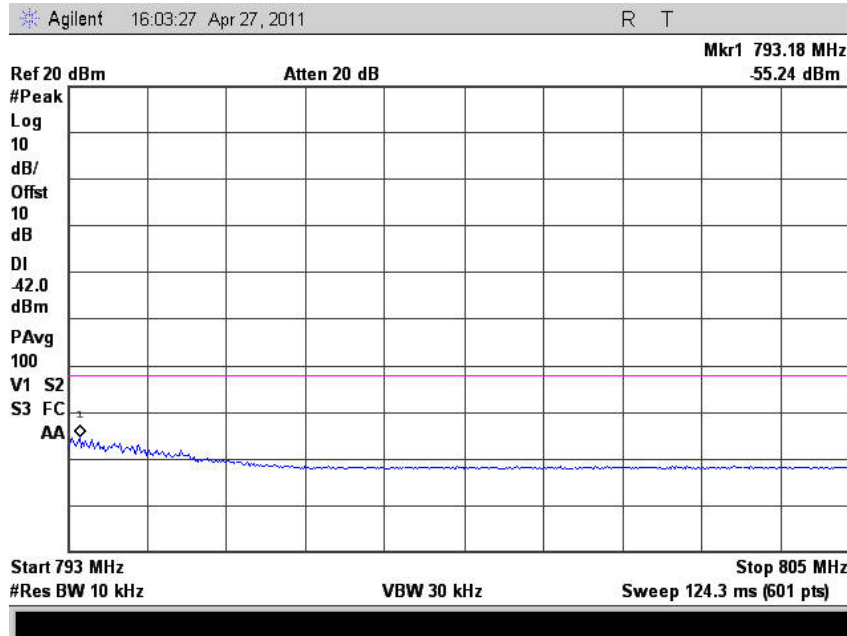

6.3.7. 746 MHz Bandedge Measurement

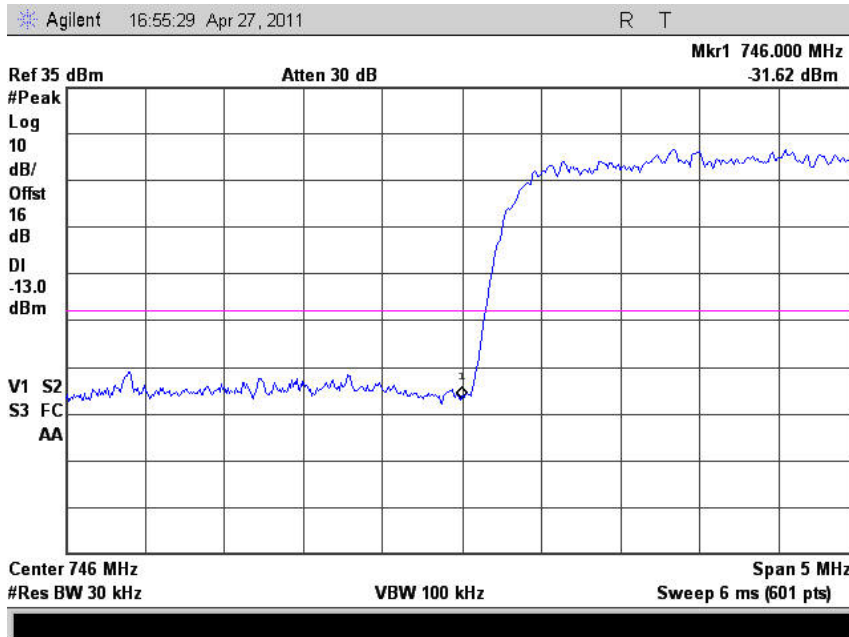



6. Measurement Data (continued)

6.3. Spurious Emissions at the Antenna Terminals 27.53 (c) (continued)

6.3.8. 757 MHz Bandedge Measurement

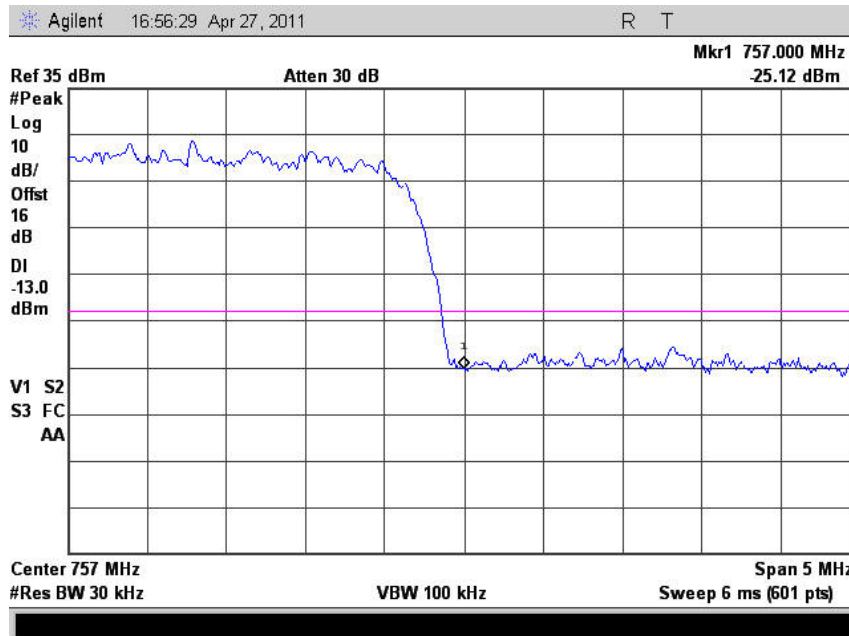

6.3.9. 776 MHz Bandedge Measurement

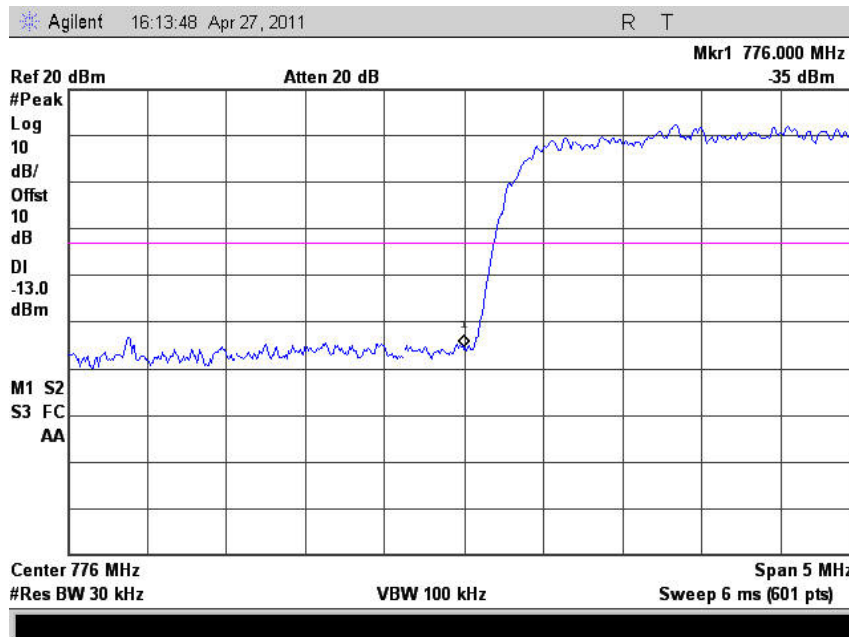

6. Measurement Data (continued)

6.3. Spurious Emissions at the Antenna Terminals 27.53 (c) (continued)

6.3.10. 787 MHz Bandedge Measurement

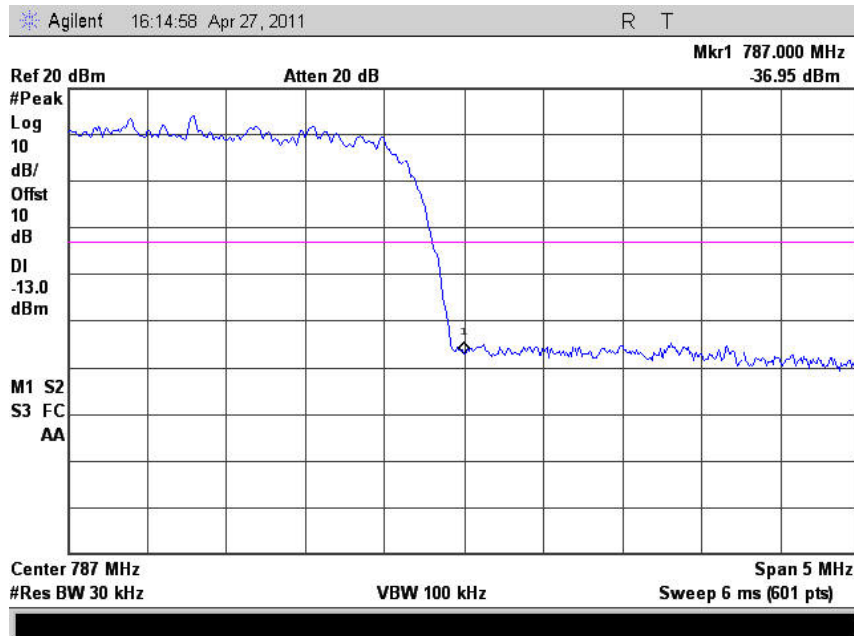

6. Measurement Data (continued)

6.4. Spurious Emissions at the Antenna Terminals – Additional Requirements 27.53 (f)

Requirement: For operations in the 746-758 MHz, 775-793 MHz and the 805-806 MHz bands, emissions in the band 1559-1610 MHz shall be limited to -70 dBW/MHz equivalent isotropically radiated power (EIRP) for wideband signals and -80 dBW EIRP for discrete emissions of less than 700 Hz bandwidth.

6.4.1. 1559-1610 MHz

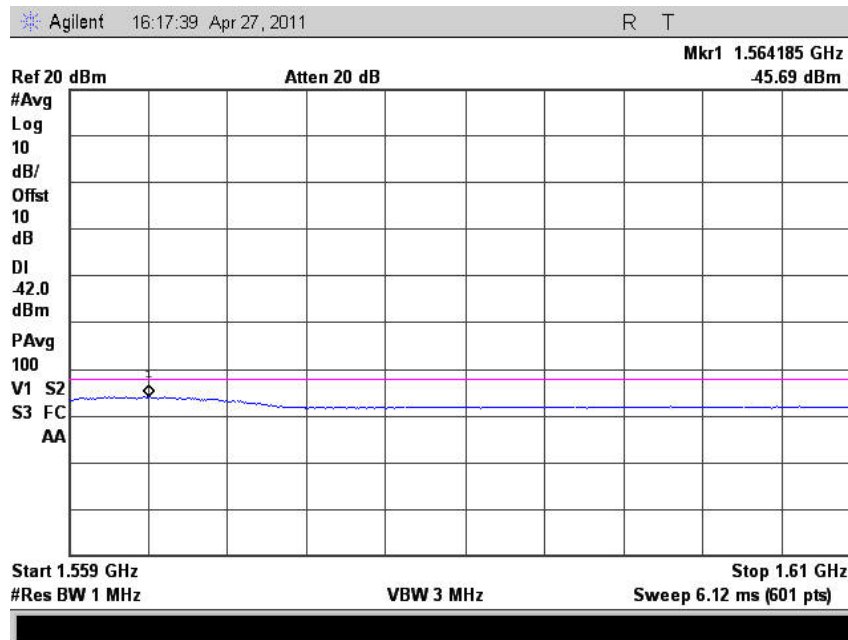

## 6. Measurement Data (continued)

### 6.5. Field Strength of Spurious Emissions 27.53 (c)

Requirement: For operations in the 746-758 MHz band and the 776-788 MHz band, the power of any emission outside of the licensee's frequency band(s) of operation shall be attenuated below the transmitter power (P) within the licensed band(s) of operation, measured in watts, in accordance with the following:

(1) On any frequency outside of the 746-758 MHz band, the power of any emission shall be attenuated outside the band below the transmitter power (P) by at least  $43 + 10 \log (P)$  dB;

(2) On any frequency outside of the 776-787 MHz band, the power of any emission shall be attenuated outside the band below the transmitter power (P) by at least  $43 + 10 \log (P)$  dB;

#### 6.5.1. Measurement and Equipment Setup

Test Date:	04/20/2011
Test Engineer:	Cody Merry
Site Temperature (°C):	24
Relative Humidity (%RH):	33
Frequency Range:	30 MHz to 1 GHz
Measurement Distance:	3 Meters
EMI Receiver IF Bandwidth:	120 kHz
EMI Receiver Avg Bandwidth:	300 kHz
Detector Functions:	Peak and Quasi-Peak.
Antenna Height:	1 to 4 meters

#### 6.5.2 Test Procedure

Test measurements were made in accordance with ANSI C63.4-2003, Standard Methods of Measurement of Radio Noise Emissions from Low-Voltage Electrical and Electronics Equipment in the Range of 9 kHz to 40 GHz.

6. Measurement Data (continued)

6.5. Field Strength of Spurious Emissions 27.53 (c) (continued)

6.5.3. Horizontal Polarity

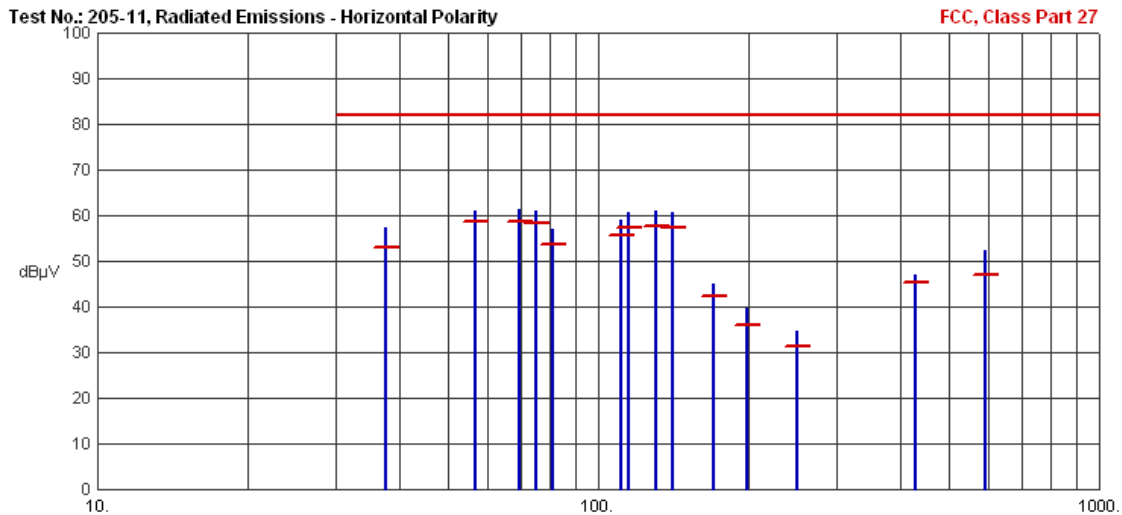

Frequency (MHz)	Pk Amp (dBµV/m)	QP Amp (dBµV/m)	QP Limit (dBµV/m)	Margin (dB)	Ant Ht (cm)	Table (Deg)	Comments
37.7301	57.38	53.13	82.00	-28.87	N/A	N/A	
56.8257	60.91	58.65	82.00	-23.35	N/A	N/A	
69.6849	61.20	58.71	82.00	-23.29	N/A	N/A	
75.3288	60.88	58.19	82.00	-23.81	N/A	N/A	
80.8738	57.05	53.59	82.00	-28.41	N/A	N/A	
110.6986	59.00	55.53	82.00	-26.47	N/A	N/A	
114.6194	60.64	57.20	82.00	-24.80	N/A	N/A	
130.8113	61.04	57.54	82.00	-24.46	N/A	N/A	
141.0684	60.81	57.40	82.00	-24.60	N/A	N/A	
169.9874	45.07	42.48	82.00	-39.52	N/A	N/A	
197.9927	39.72	36.12	82.00	-45.88	N/A	N/A	
250.0194	34.64	31.27	82.00	-50.73	N/A	N/A	
428.9937	46.85	45.41	82.00	-36.59	N/A	N/A	
593.9897	52.18	47.09	82.00	-34.91	N/A	N/A	

6. Measurement Data (continued)

6.5. Field Strength of Spurious Emissions 27.53 (c) (continued)

6.5.4. Vertical Polarity

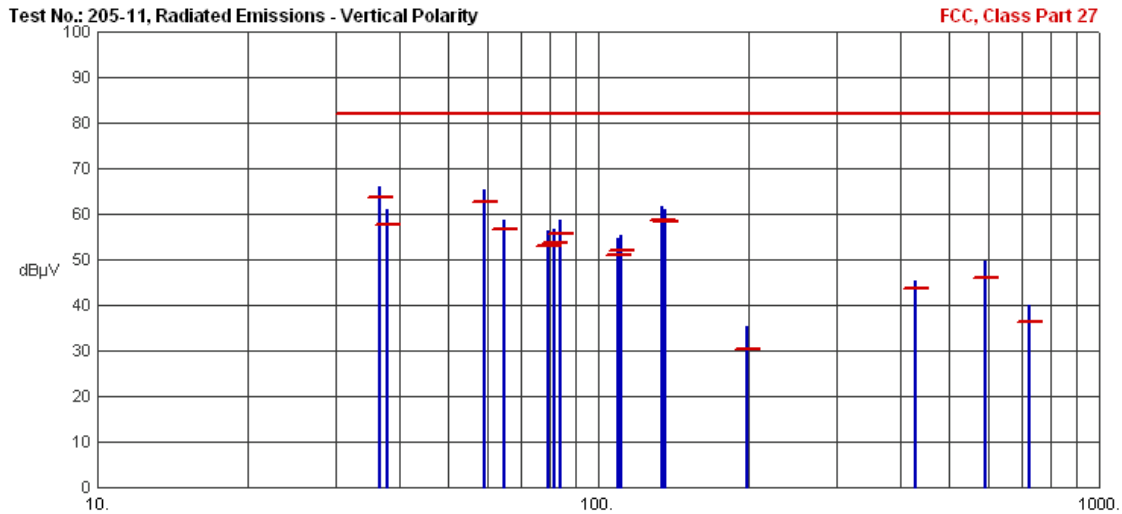

Frequency (MHz)	Pk Amp (dBµV/m)	QP Amp (dBµV/m)	QP Limit (dBµV/m)	Margin (dB)	Ant Ht (cm)	Table (Deg)	Comments
36.7129	65.95	63.58	82.00	-18.42	N/A	N/A	
37.7922	61.03	57.60	82.00	-24.40	N/A	N/A	
59.3004	65.26	62.65	82.00	-19.35	N/A	N/A	
64.6793	58.81	56.61	82.00	-25.39	N/A	N/A	
79.5772	56.17	52.91	82.00	-29.09	N/A	N/A	
81.7014	56.82	53.61	82.00	-28.39	N/A	N/A	
84.2843	58.56	55.79	82.00	-26.21	N/A	N/A	
109.7546	54.73	51.13	82.00	-30.87	N/A	N/A	
110.7323	55.32	51.95	82.00	-30.05	N/A	N/A	
133.7442	61.70	58.60	82.00	-23.40	N/A	N/A	
136.2066	61.10	58.23	82.00	-23.77	N/A	N/A	
197.9964	35.50	30.24	82.00	-51.76	N/A	N/A	
428.9895	45.30	43.55	82.00	-38.45	N/A	N/A	
594.0021	49.75	45.87	82.00	-36.13	N/A	N/A	
725.9895	39.94	36.30	82.00	-45.70	N/A	N/A	

**6. Measurement Data (continued)****6.5. Field Strength of Spurious Emissions 27.53 (c) (continued)**

## 6.5.5. Measurement and Equipment Setup

Test Date:	04/20/2011
Test Engineer:	Cody Merry
Site Temperature (°C):	24
Relative Humidity (%RH):	33
Frequency Range:	Above 1 GHz
Measurement Distance:	3 Meters
EMI Receiver IF Bandwidth:	1 MHz
EMI Receiver Avg Bandwidth:	3 MHz
Detector Functions:	Peak and Average
Antenna Height:	1 to 4 meters

## 6.5.6. Radiated Emissions above 1 GHz

There were no measureable emissions above 1 GHz

**6. Measurement Data (continued)**

**6.6. Frequency Stability 27.54**

Requirement: The frequency stability shall be sufficient to ensure that the fundamental emissions stay within the authorized band of operation.

Note: The EUT does not translate the input frequency and therefore this testing was not performed.



6. Measurement Data (continued)

6.7. Inter-modulation

Requirement: Using the maximum drive level determined in the output power section apply three CW tones at low, mid and high frequencies in the band and verify the inter-modulation products do not exceed -13 dBm conducted.

6.7.1. 751.5 MHz Inter-modulation products, with 3 CW Signals

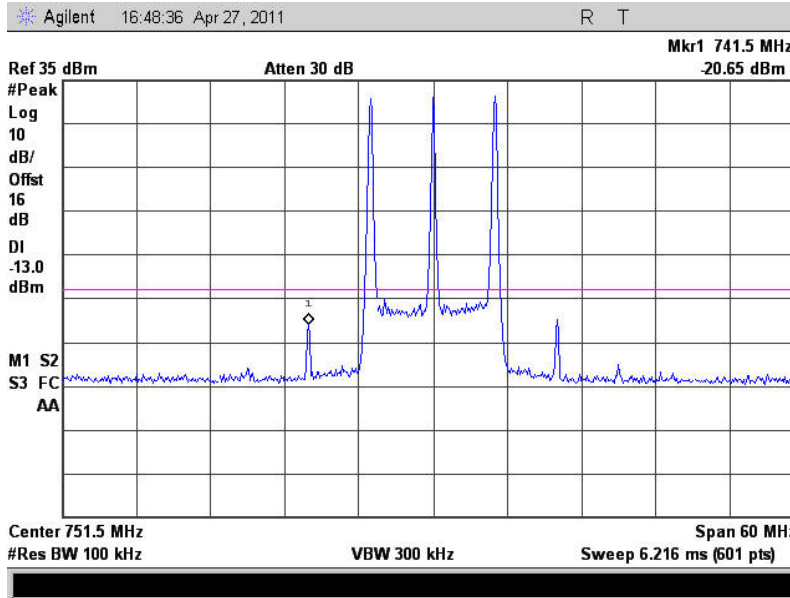

6.7.2. 751.5 MHz Inter-modulation products, with LTE 16QAM Signal

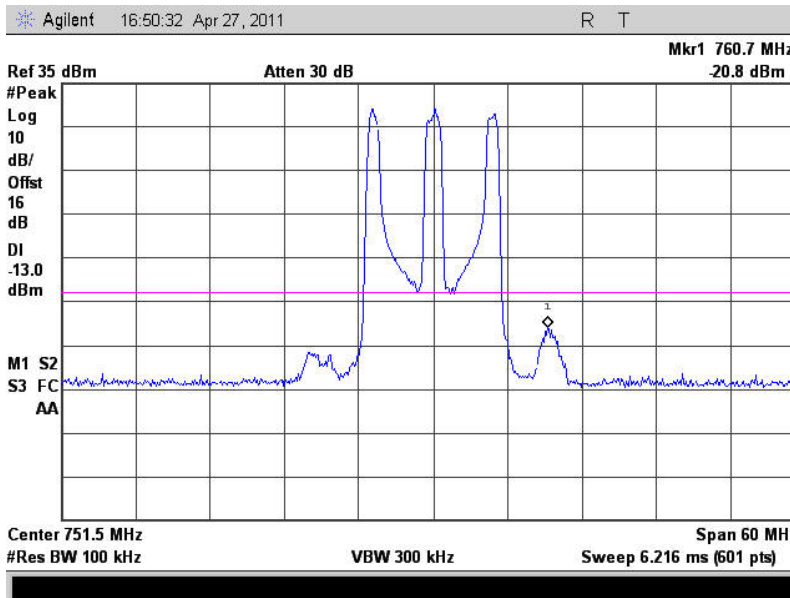

6. Measurement Data (continued)

6.7. Inter-modulation (continued)

6.7.3. 751.5 MHz Inter-modulation products, with LTE Signal

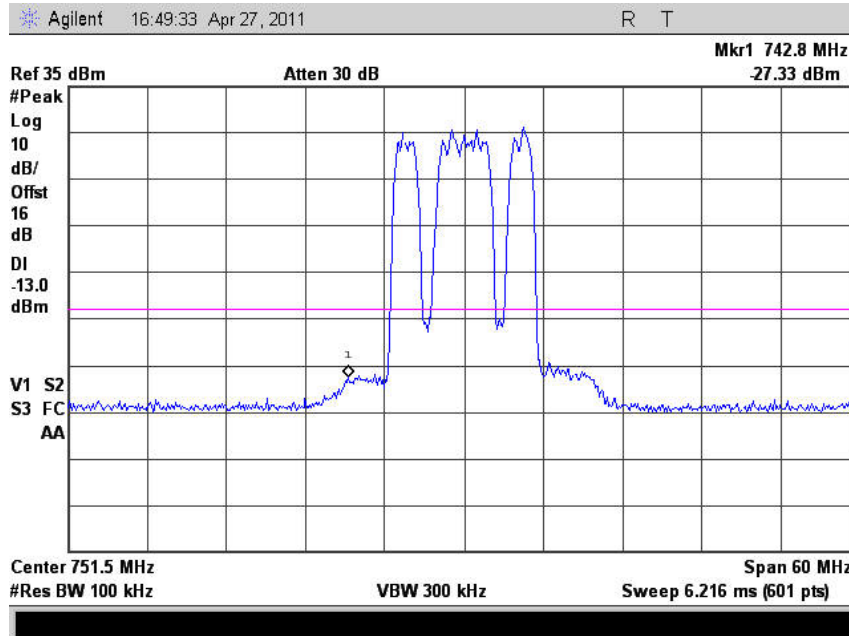

6.7.4. 781.5 MHz Inter-modulation products, with 3 CW Signals

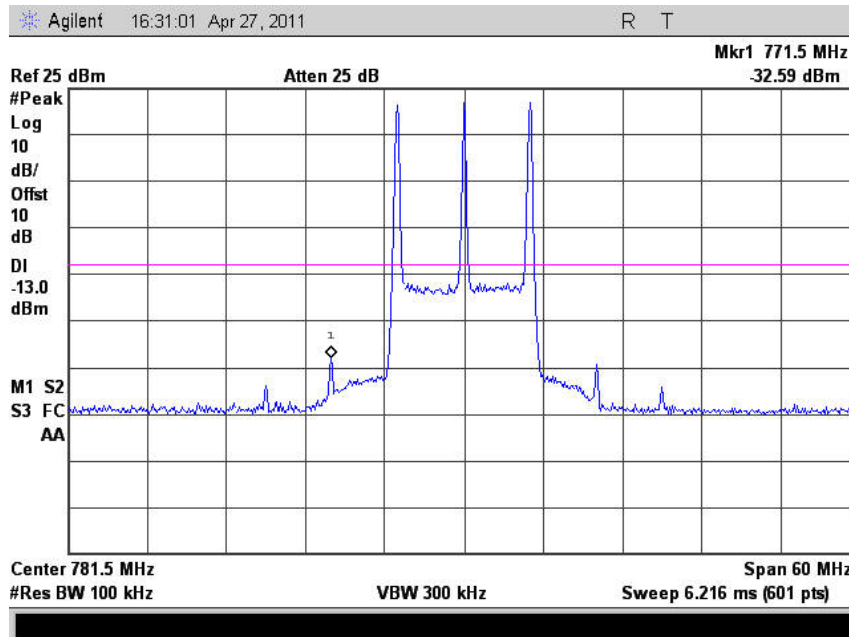

6. Measurement Data (continued)

6.7. Inter-modulation (continued)

6.7.5. 781.5 MHz Inter-modulation products, with LTE 16QAM Signal

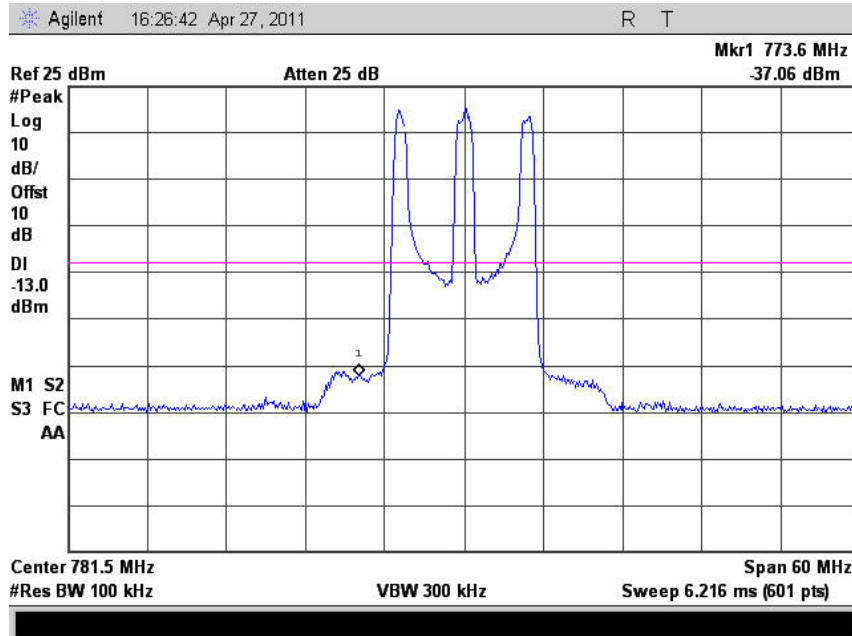

6.7.6. 781.5 MHz Inter-modulation products, with LTE Signal

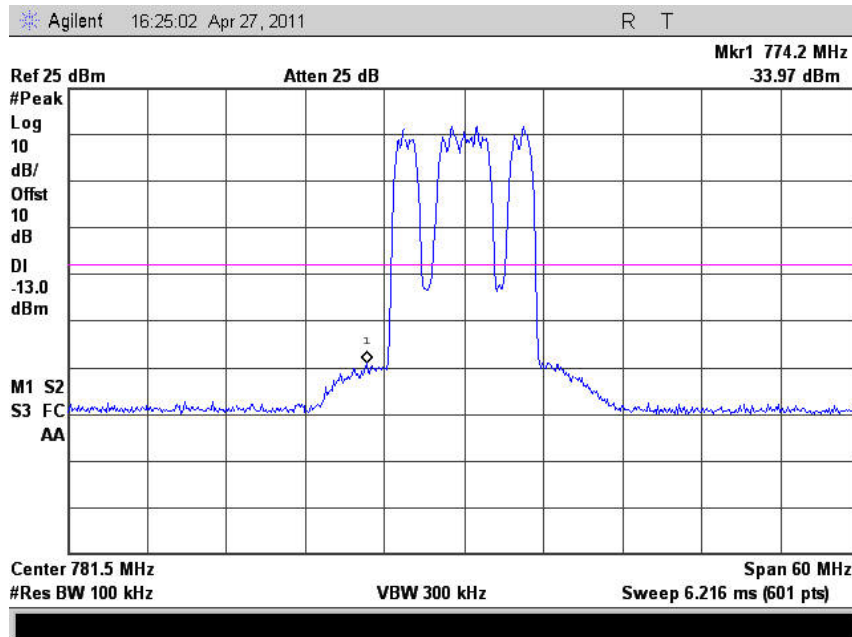

**6. Measurement Data (continued)**

**6.8. Public Exposure to Radio Frequency Energy Levels 1.1307 (b)(1)**

Channel	MPE Distance (cm)	DUT Output Power (dBm)	DUT Antenna Gain (dBi)	Power Density		Limit (mW/cm <sup>2</sup> )	Result
				(mW/cm <sup>2</sup> )	(W/m <sup>2</sup> )		
	(1)	(2)	(3)	(4)		(5)	
Downlink	33.0	38.15	3.0000	0.9522747	9.5227472	1	Compliant
Uplink	20.0	29.25	3.0000	0.3339874	3.3398745	1	Compliant
Downlink	115.0	38.15	14.0000	0.9871757	9.8717570	1	Compliant
Uplink	42.0	29.25	14.0000	0.9534360	9.5343602	1	Compliant

$$PD = \frac{OP + AG}{(4 \times \pi \times d^2)}$$

1. Reference CFR 2.1093(b): For purposes of this section, a portable device is defined as a transmitting device designed to be used so that the radiating structure(s) of the device is/are within 20 centimeters of the body of the user. Actual separation distance was calculated for outdoor applications.
2. Section 6.1.2 of this test report. Note that the value has been adjusted to include the cable insertion loss.
3. Data supplied by the client. 3 dBi for Indoor, 14 dBi for Outdoor Applications
4. Power density is calculated from field strength measurement and antenna gain.
5. Reference CFR 1.1310, Table 1: Limits for Maximum Permissible Exposure (MPE), Section (B): Limits for General Population/Uncontrolled Exposure.

## 7. Test Site Description

Compliance Worldwide is located at 357 Main Street in Sandown, New Hampshire. The test sites at Compliance Worldwide are used for conducted and radiated emissions testing in accordance with Federal Communications Commission (FCC) and Industry Canada standards. A description of the test sites is on file with the FCC (registration number **96392**) and Industry Canada (file number **IC 3023A-1**).

The radiated emissions test site is a 3 and 10 meter enclosed open area test site (OATS). Personnel, support equipment and test equipment are located in the basement beneath the OATS ground plane.

The conducted emissions site is part of a 16' x 20' x 12' ferrite tile chamber and uses one of the walls for the vertical ground plane required by EN 55022.

Both sites are designed to test products or systems 1.5 meter W x 1.5 meter L x 2.0 meter H, floor standing or table top.

## 8. Test Setup Photographs

### Antenna Port Conducted Emissions



8. Test Setup Photographs (cont)

Radiated Emissions (Front & Rear)



Appendix A

RF Output Power

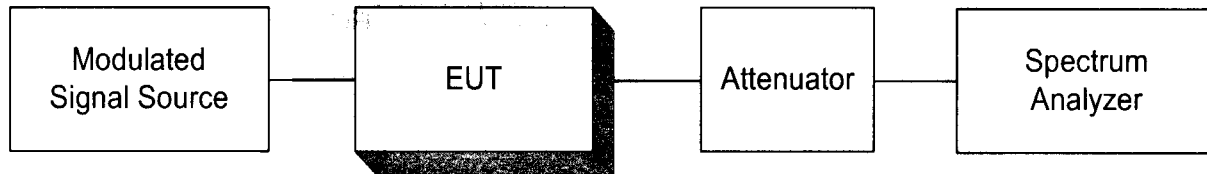

Occupied Bandwidth

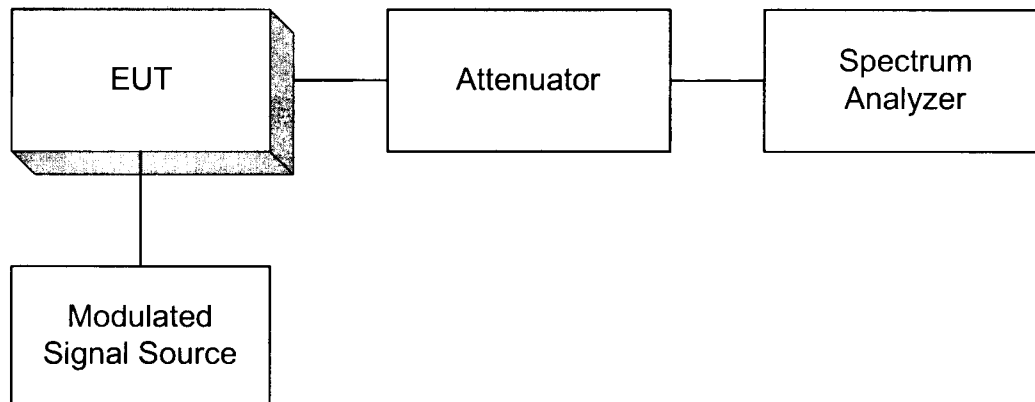



### Appendix A

#### Spurious Emissions at the Antenna Terminals

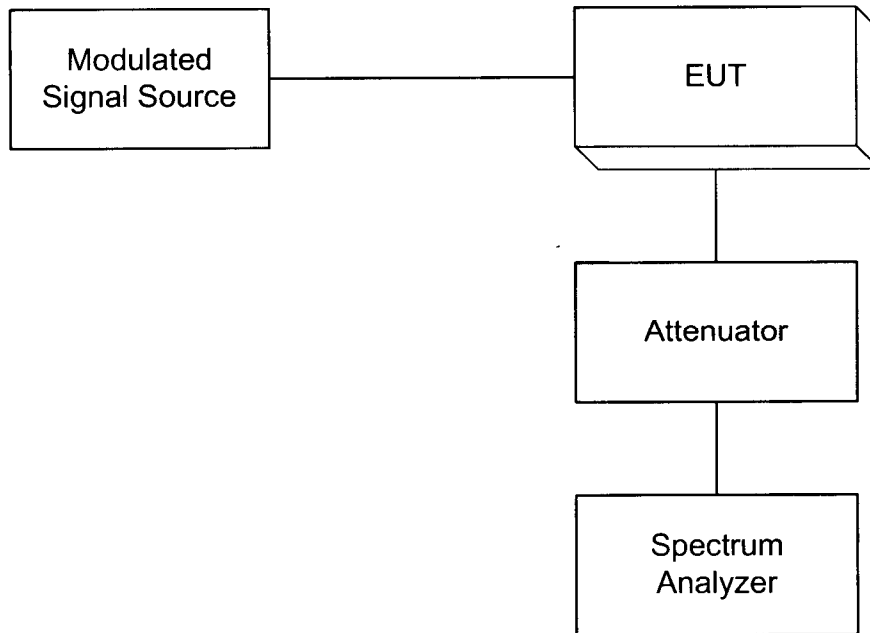

#### Field Strength of Spurious Radiation

