

# csi

## Product Manual

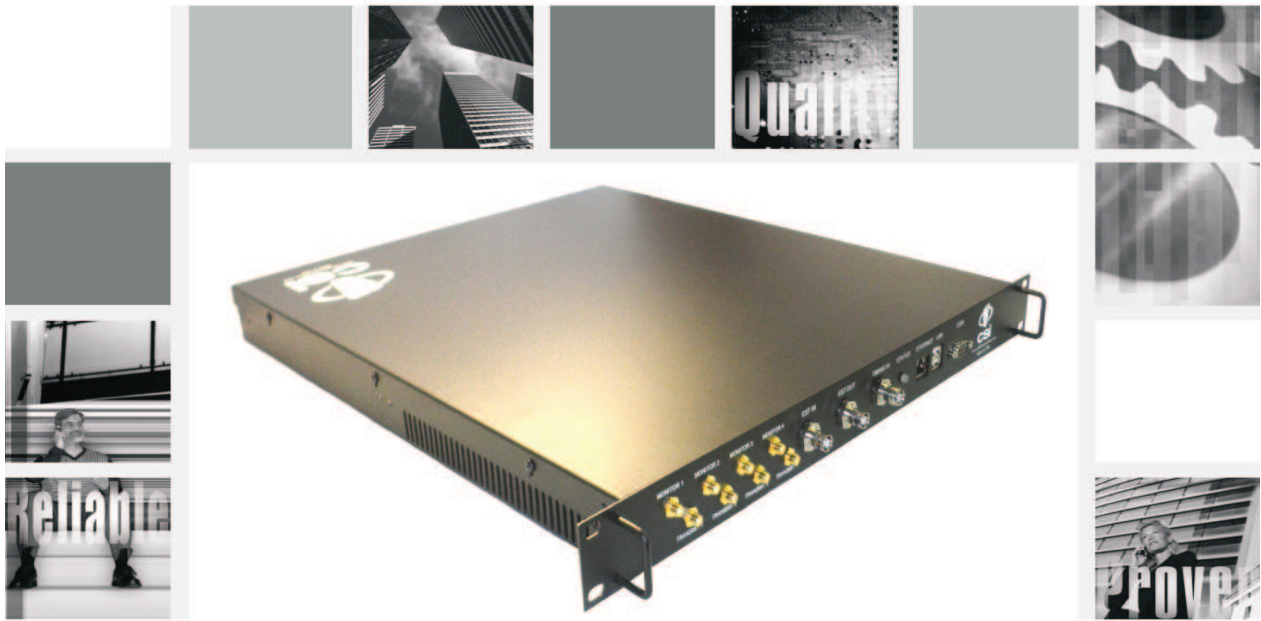

CSI-CPBH-MG-C4, CSI-CPBH-MG-P4,  
CSI-CPBH-MG-C2/P2, CSI-CPBH-MG-AW4,  
CSI-CPBH-MG-C2/AW2, CSI-CPBH-MG-P2/AW2,  
CSI-CPBH-MO-C4, CSI-CPBH-MO-P4,  
CSI-CPBH-MO-C2/P2, CSI-CPBH-MO-AW4,  
CSI-CPBH-MO-C2/AW2, CSI-CPBH-MO-P2/AW2,  
CSI-CPBH-MX-C4, CSI-CPBH-MX-P4,  
CSI-CPBH-MX-C2/P2, CSI-CPBH-MX-AW4,  
CSI-CPBH-MX-C2/AW2, CSI-CPBH-MX-P2/AW2,

This page intentionally left blank.

## Table of Contents

Product Registration Information .....	4
Document Purpose / Intended Users .....	4
Radio and Television Interference .....	4
Application .....	4
Safety Guidelines .....	4
Important Safety Information .....	4
Acronyms and Definitions .....	5
Product Introduction .....	5
Functional Overview .....	6
Electrical Characteristics .....	6
Mechanical Specifications .....	6
AC Power Specifications .....	6
Environmental Requirements .....	6
Mechanical Drawing .....	7
System Set-Up Considerations .....	7
Mounting the Co-Pilot Beacon .....	7
Typical Co-Pilot/BTS Interconnection with Internal CDMA Timing (MO Series) .....	8
Typical Co-Pilot/Repeater Interconnection with Internal GPS Timing (MG Series) .....	9
Typical Co-Pilot/Repeater Interconnection with External TM-4 (MX Series) .....	10
Optional Accessories .....	11
Important Installation Notes .....	11
Powering Up the Unit .....	11
Local Communication Interface Ports .....	11
EIA232 Pin Specifications .....	12
USB Interface .....	12
Ethernet .....	12
Monitoring & Alarms .....	12
Text Menu Interface .....	13
Local Access .....	13
User Interface .....	15
Login .....	15
Main Menu .....	15
Telnet Session (Remote Access) .....	16
Set Parameters Menu .....	16
Set Parameters Menu .....	19
Co-Pilot Beacon Configuration .....	20
Transmitter Configuration .....	20
System Configuration .....	21
Networking Configuration .....	22
System Commands .....	23
Key Features .....	24
Multiple Beacon Configuration .....	24
Detected RF Power Shutdown .....	24
Timing Reference Source .....	24
Control Parameter Details .....	24
Master Shutdown .....	24
Timing Reference Selection .....	24
Channel Frequency Numbers .....	25
Signal Transmit Enables .....	25
PN Offset .....	26
Tau (Delay Correction) .....	26
Co-pilot beacon Per Channel Transmit Power .....	26
Composite Transmit Power .....	26
Manual Shutdown .....	26
Auto Shutdown Enable .....	26
Auto Shutdown Threshold .....	26
Index .....	30

## Product Registration Information

The serial number may be found on the label on the bottom panel near the power connectors. Note this number below. Retain this manual, along with proof of purchase, to serve as a permanent record of your purchase.

MODEL NUMBER	SERIAL NUMBER	PURCHASE DATE
<input type="text"/>	<input type="text"/>	<input type="text"/>
POINT OF SALE COMPANY		
<input type="text"/>		

DISCLAIMER: All information and statements contained herein are accurate to the best of the knowledge of Cellular Specialties, Inc. (CSI), but Cellular Specialties makes no warranty with respect thereto, including without limitation any results that may be obtained from the products described herein or the infringement by such products of any proprietary rights of any persons. Use or application of such information or statements is at the users sole risk, without any liability on the part of Cellular Specialties, Inc. Nothing herein shall be construed as licence or recommendation for use, which infringes upon any proprietary rights of any person. Product material and specifications are subject to change without notice. Cellular Specialties' standard terms of sale and the specific terms of any particular sale apply.

## Document Purpose / Intended Users

The purpose of this document is to provide a step-by-step procedure to help the experienced technician/engineer install and commission an in-building wireless enhancement pilot beacon system. Following the procedures outlined will minimize risks associated with modifying a live system and prevent service interruptions. This document assumes the technician/engineer understands the basic principles and functionality involved with the system. It is geared to the practical concerns of the installer.

## Radio and Television Interference

NOTE: This equipment has been tested and found to comply with the limits for a Class A digital device, pursuant to Part 15 of the FCC rules. These limits are designed to provide reasonable protection against harmful interference when the equipment is operated in a commercial environment. This equipment generates, uses and can radiate radio frequency energy and, if not installed and used in accordance with the instruction manual, may cause harmful interference to radio communications. Operation of this equipment in a residential area is likely to cause harmful interference in which case the user will be required to correct the interference at his own expense. Changes and Modifications not expressly approved by Cellular Specialties, Inc. can void your authority to operate this equipment under Federal Communications Commission's rules.

## Application

This guide should be applied whenever a need exists to add pilot beacon capability to an existing system or when this capability is being included with a new installation.

## Safety Guidelines

The general safety information in this guideline applies to both operating and service personnel. Specific warnings and cautions will be found in other parts of this manual where they apply, but may not appear in this summary. Failure to comply with these precautions or specific warnings elsewhere in the manual violates safety standards of design, manufacture, and intended use of equipment. Cellular Specialties, Inc. assumes no liability for the customer's failure to comply with these requirements:

### Grounding

This pilot beacon system is designed to operate from 100-240 VAC and should always be operated with the ground wire properly connected. Do not remove or otherwise alter the grounding lug on the power cord.

### Explosive Atmospheres

To avoid explosion or fire, do not operate this product in the presence of flammable gases or fumes.

### Lightning Danger

Do not install or make adjustments to this unit during an electrical storm. Use of a suitable lightning arrester, such as CSI's model number CSI-CAP, is very strongly recommended.

### No User Serviceable Parts Inside

**HAZARDOUS VOLTAGES ARE PRESENT WHEN THE COVER IS REMOVED.** Opening the chassis will void your warranty. If you suspect a malfunction with this product, call your dealer or the Cellular Specialties Support Line at: **(603) 626-6677, Toll Free (USA) 1-877-844-4274.**

## Important Safety Information

Antennas used for the purpose of radiating signals indoors are limited to a *maximum* gain of 3 dBi. Each antenna must be positioned to observe minimum separation requirements from all users and bystanders. The following guidelines should be used when considering separation distances.

**INDOOR antennas must be placed such that, under normal conditions, personnel cannot come within 20 cm (~8.0 in.) from any inside antenna. Adhering to this minimum separation will ensure that the employee or bystander cannot exceed RF exposures beyond the maximum permissible limit as defined by section 1.1310 i.e. limits for General Population/Uncontrolled Exposure.**

## Acronyms and Definitions

<b>3GPP2</b>	The standards body comprised of representatives of interested companies that is responsible for the development and maintenance of the operational standards for the CDMA2000 system. <a href="http://www.3gpp2.org">Http://www.3gpp2.org</a>
<b>AGC</b>	Automatic Gain Control
<b>CDMA</b>	Code Division (or, Domain) Multiple Access: The general term for the technology used in the CDMA2000 system as well as others. Also a shorthand reference to the CDMA2000 system and its derivatives such as 1xEV-DO
<b>Chip</b>	A single element, a '1' or a '0', of the PN Sequence in a CDMA system. The chip rate for the CDMA2000 system is 1.2288 Mchips/second.
<b>CSI</b>	Cellular Specialties Incorporated
<b>DAS</b>	Distributed Antenna System
<b>ERP</b>	Effective Radiated Power
<b>EST</b>	Even Second Tick: In the CDMA2000 cellular system all time values are referenced to the start of the even seconds of time as indicated by GPS.
<b>FCC</b>	Federal Communications Commission
<b>FPGA</b>	Field Programmable Gate Array
<b>GPS</b>	Global Positioning System
<b>IF</b>	Intermediate Frequency
<b>LED</b>	Light Emitting Diode
<b>NEMA</b>	National Electrical Manufacturers Association
<b>PA</b>	Power Amplifier
<b>PN</b>	Pseudo random Number: A number chosen by some algorithm that approximates a random process. Can be short for "PN Sequence", "PN Number", or "PN Offset" when discussing the CDMA2000 system.
<b>PN Number</b>	In the CDMA2000 system only a subset of the possible PN Offsets are used for base station identification. Each of these allowed offsets is given a unique number from 0 to 511.
<b>PN Offset</b>	In the CDMA2000 System each base station is identified by the offset in time from the EST at which the start of the Pilot PN Sequence occurs. The offset is specified in terms of number of chips.
<b>PN Sequence</b>	A sequence of pseudo random numbers. In the CDMA2000 system several such sequences are used. The one relevant to ICEBreaker is the Pilot, or Short, sequence which is a $2^{15}$ element long sequence of ones and zeros.
<b>PPS</b>	Pulse per Second: Refers the pulse repetition rate of the timing signal used as a time reference.
<b>RF</b>	Radio Frequency
<b>SBC</b>	Single Board Computer
<b>Tau</b>	Timing Offset or Delay Adjustment: In the CDMA2000 system the timing of the downlink signal is required to be aligned with the EST as it is transmitted from the antenna. Tau allows the timing of the internal PN Sequence to be adjusted to compensate for the delays of the base station hardware such that the timing will be correct at the antenna
<b>USB</b>	Universal Serial Bus

## Product Introduction

The pilot beacon generator facilitates E911 and other location based services (LBS) for in building and/or DAS based installations of CDMA2000/1xEV-DO cellular networks. In these situations the normal methods based for location determination, direct reception of GPS by the mobile station or triangulation using the signals from multiple base stations, do not work. Signals from the GPS system are sufficiently weak that even if the mobile station's GPS receiver might ultimately be able to lock on to the satellites, the acquisition time will be too long. And since indoor service is typically provided either by a single strong local cell or by using a repeater, there aren't multiple signals on which to triangulate while DAS based deployments result in too many signals with indeterminate timing. By placing a pilot signal at a known PN offset the LBS algorithm can quickly and reliably be made aware that it is within a specific building or other location where normal location determining solutions are ineffective. This information can be used to aid the GPS receiver in acquiring signals if they are present or be used as a position report directly until more accurate information becomes available.

## Functional Overview

### Electrical Characteristics

Characteristic	Performance Limit
Number of Bands per Beacon	1
CDMA Band Class	0 (Cell), 1 (PCS) and 15 (AWS)
Max # Simultaneous Channels/Beacon	8 (Cell) 11 (PCS and AWS)
Number of Unique PN Offsets/Beacon	1
Composite TX Power	+20 dBm
Spurious Emissions Limits	< -45 dBc $\Delta f$ .75 to 1.98 MHz < -60 dBc $\Delta f$ 1.98 to 4.0 MHz < -65 dBc $\Delta f$ 4.0 to 16 MHz < -75 dBc $\Delta f$ > 16 MHz
Carrier Frequency Accuracy	20 Hz (.2 ppm) Cell Band 40 Hz (.2 ppm) PCS Band 45 Hz (.2 ppm) AWS Band When locked to GPS
Pilot Timing Jitter	< 10 nsec rms, <50 nsec peak
Rho	> 0.98
Tau Adjustment Range	- 166.7 to + 166.7 $\mu$ sec (+/- 25.6 CDMA chips)
Tau Adjustment Resolution	20 nsec (one 40th of a CDMA chip)

### Mechanical Specifications

Parameter	Specification	Notes
<b>Pilot Beacon Size</b>		
Height	1.73 in.	
Width	19.00 in.	
Depth	18.02 in.	
<b>Weight</b>	8.4lbs / 3.8kg	
<b>Thermal Management</b>	Fan Cooled	
<b>Surface Coating</b>	Powder Coat	
<b>Color</b>	Satin Black	

### AC Power Specifications

Parameter	Specification	Notes
<b>AC Voltage</b>	100 - 240 VAC	External Power Supply
<b>AC Current</b>	1.7 Amps 0.9 Amps	@ 120 VAC @ 230 VAC
<b>AC Power Frequency</b>	47 - 63 Hz	
<b>Heat Output</b>	500 BTU/Hr	

### Environmental Requirements

Parameter	Specification	Notes
<b>Temperature Range</b>	-30° to +48°C (-22° to +118°F)	
<b>Relative Humidity</b>	5% to 95%	Non-condensing

## Mechanical Drawing

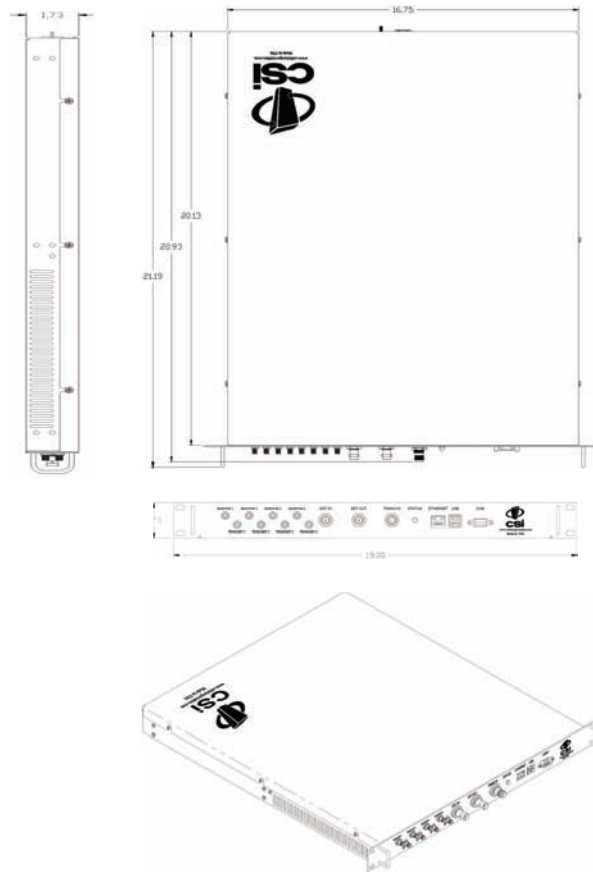

## System Set-Up Considerations

All cables should be checked for shorts and opens. Also verify that there are no cables with loose or poor connections. It is critical that the installer contact the service provider before the system is turned on.

## Mounting the Co-Pilot Beacon

The following diagram illustrates the best method for mounting the pilot beacon to a wall in an typical installation.

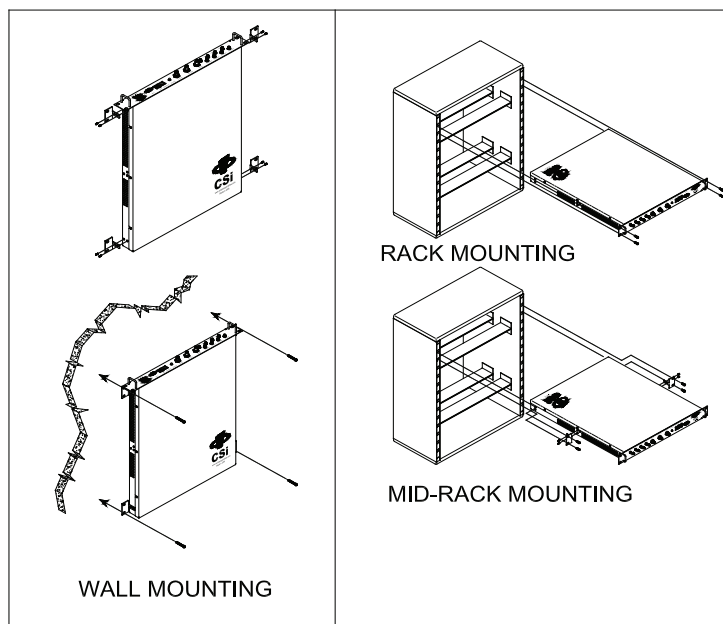

## Typical Co-Pilot/BTS Interconnection with Internal CDMA Timing (MO Series)

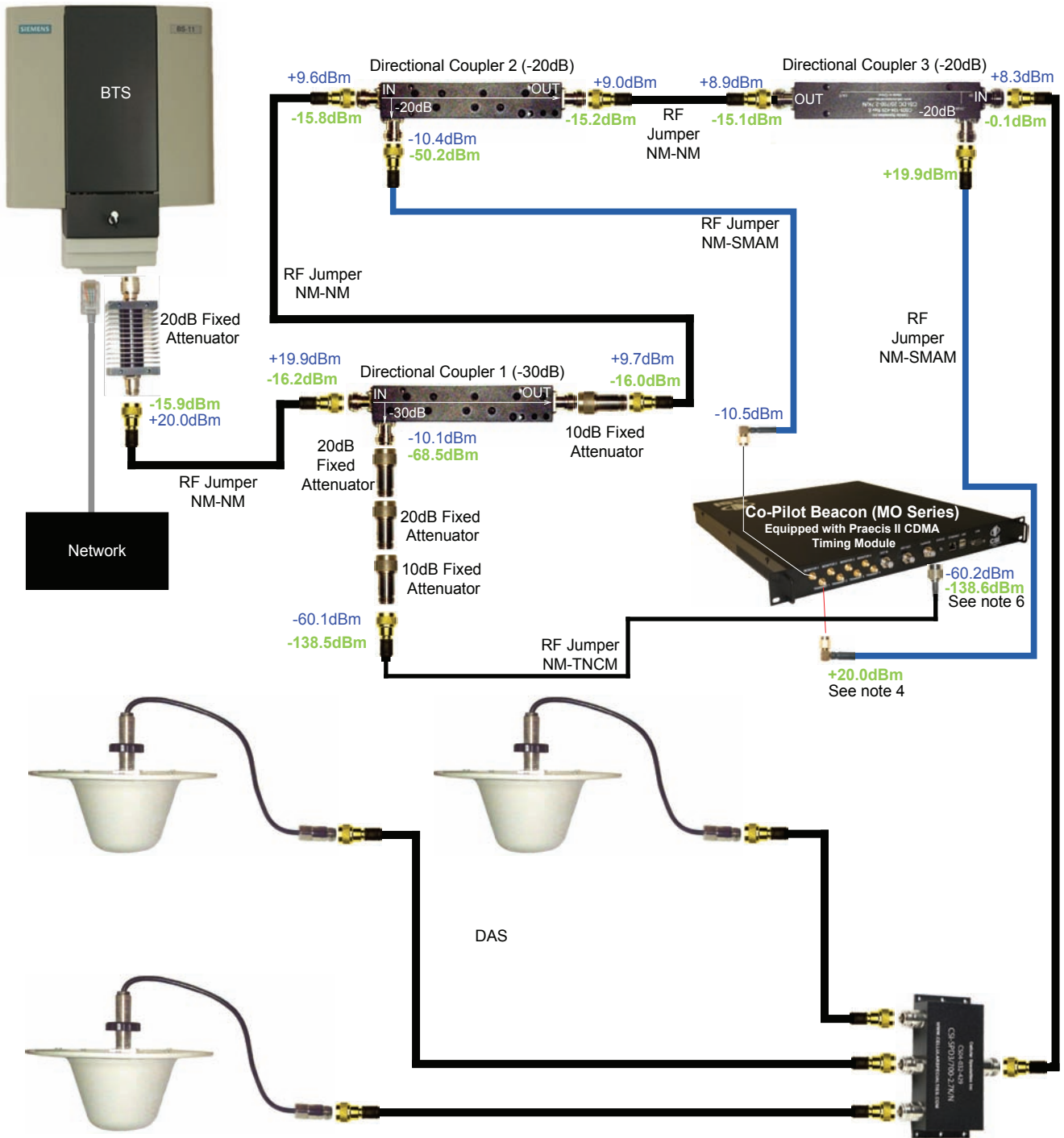

### Notes:

1. It is recommended that all unused ports be terminated at 50 ohms. When properly terminated, the possibility of false shutdown is minimized because high reflections at open ports are eliminated.
2. The values shown in this drawing are only an example. Power levels encountered at each installation may require different coupling, pads, and threshold values.
3. This example assumes a BTS with power at the output set to 40dBm, co-pilot beacon output set at 20dBm.
4. Threshold Power Level in this example is set to -20dBm (Approximately 10dB below the power level at the monitor input).
5. DAS Power Detection and Shutdown functionality:
  - If **RF Detector** measures Input power lower than the **Threshold Power Level** set by the user, then the Co-Pilot Beacon's RF power output will be shut down.
  - An alarm occurs. (Delay approximately one second on-off and one second off-on.)
6. Co-pilot beacon signal reflecting back to the input of the CDMA timing source must never be allowed to exceed -124dBm.



## Typical Co-Pilot/Repeater Interconnection with Internal GPS Timing (MG Series)

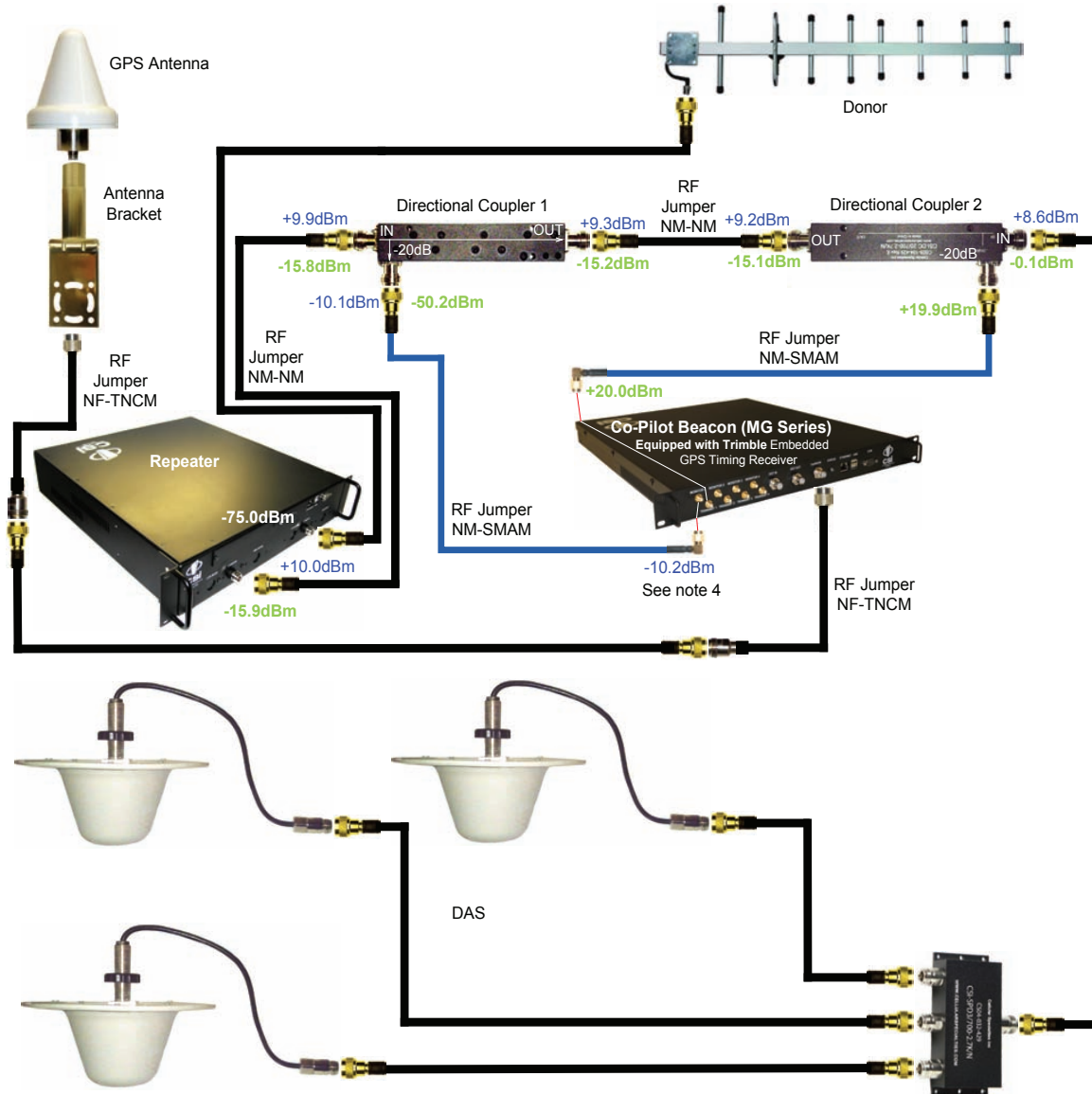

### Notes:

1. It is recommended that all unused ports be terminated at 50 ohms. When properly terminated, the possibility of false shutdown is minimized because high reflections at open ports are eliminated.
2. The values shown in this drawing are only an example. Power levels encountered at each installation may require different coupling, pads, and threshold values.
3. This example assumes -75dBm input at the repeater, repeater gain set to 85dB, co-pilot beacon output set at 20dBm and use of 20dB directional couplers with 20dB coupling, and assumed 15dB worst case directivity.
4. Threshold Power Level in this example is set to -20dBm (Approximately 10dB below the power level at the monitor input.)
5. DAS Power Detection and Shutdown functionality:
  - If **RF Detector** measures Input power lower than the **Threshold Power Level** set by the user, then the Co-Pilot Beacon's RF power output will be shut down.
  - An alarm occurs. (Delay approximately one second on-off and one second off-on.)

## Typical Co-Pilot/Repeater Interconnection with External TM-4 (MX Series)

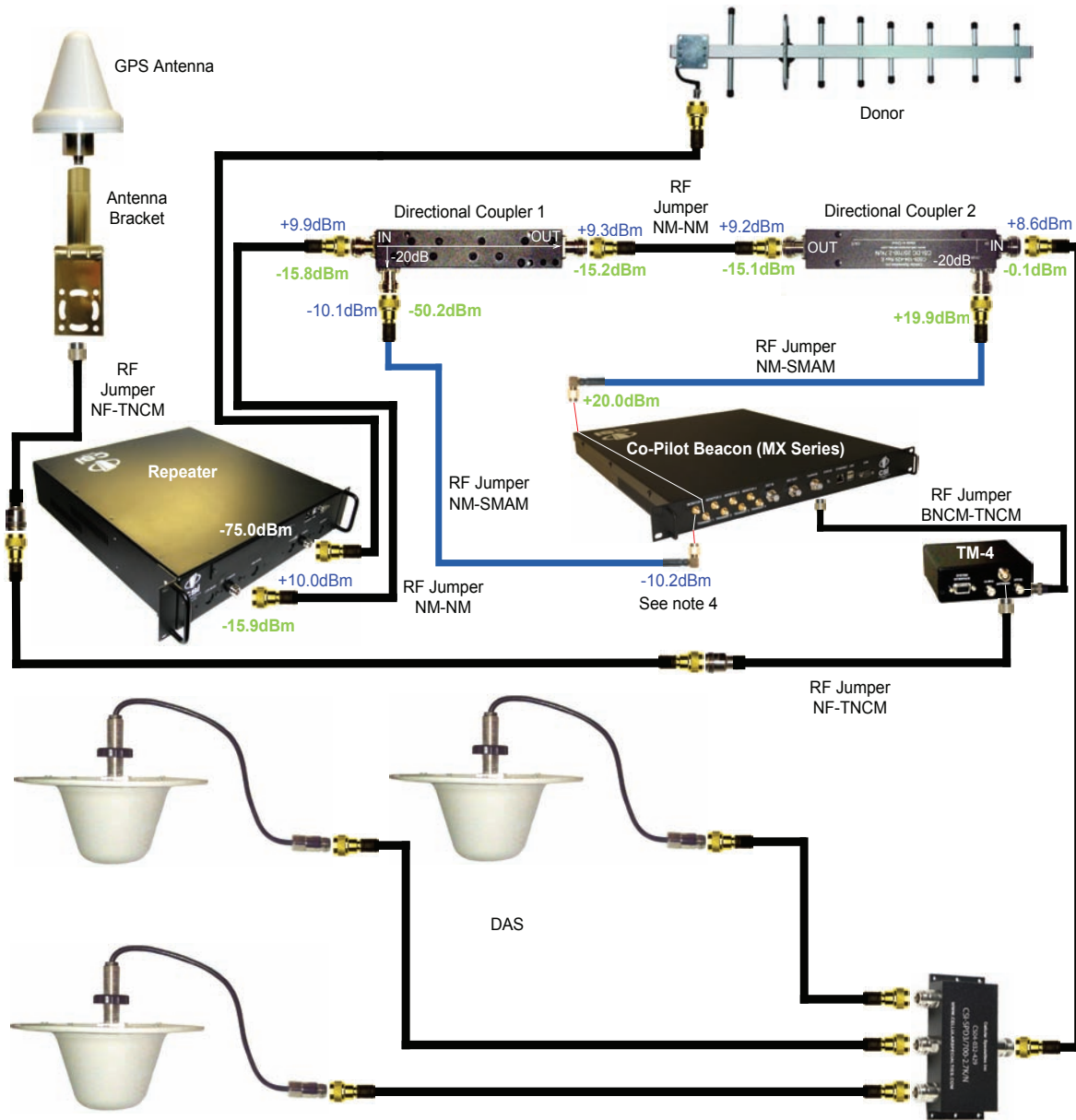

### Notes:

1. It is recommended that all unused ports be terminated at 50 ohms. When properly terminated, the possibility of false shutdown is minimized because high reflections at open ports are eliminated.
2. The values shown in this drawing are only an example. Power levels encountered at each installation may require different coupling, pads, and threshold values.
3. This example assumes -75dBm input at the repeater, repeater gain set to 85dB, co-pilot beacon output set at 20dBm and use of 20dB directional couplers with 20dB coupling, and assumed 15dB worst case directivity.
4. Threshold Power Level in this example is set to -20dBm (Approximately 10dB below the power level at the monitor input.)
5. DAS Power Detection and Shutdown functionality:
  - If **RF Detector** measures Input power lower than the **Threshold Power Level** set by the user, then the Co-Pilot Beacon's RF power output will be shut down.
  - An alarm occurs. (Delay approximately one second on-off and one second off-on.)

**Warning:** Power supply cable connector is keyed for proper orientation and is designed to lock into place.

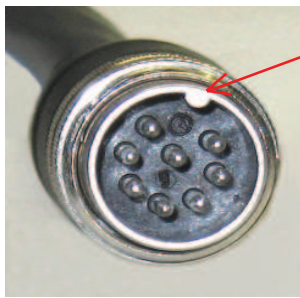

**Keyed for proper alignment, do not force connector into place.**

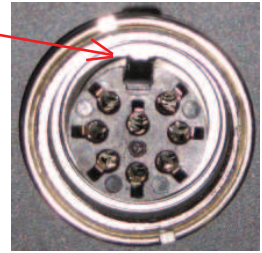

## Optional Accessories

A complete line of accessories is available from Cellular Specialties, Inc. Check with your CSI distributor for any additional items needed. Below are just a few examples suitable for most in-building needs.

- **Inside Omnidirectional Antenna**
  - Quad-band - model number: **CSI-AO/700/2.7K/3**
- **Directional Couplers**
  - 6dB - model number: **CSI-DC6/700-2.7K/N**
  - 10dB - model number: **CSI-DC10/700-2.7K/N**
  - 15dB - model number: **CSI-DC15/700-2.7K/N**
  - 20dB - model number: **CSI-DC20/700-2.7K/N**
  - 30dB - model number: **CSI-DC30/700-2.7K/N**
- **Battery backup, 4 hr Single band**
  - 2 hour dual band - model number: **CS48-985-601**
- **Power Dividers**
  - 2:1 - model number: **CSI-SPD2/700-2.7K/N**
  - 3:1 - model number: **CSI-SPD3/700-2.7K/N**
  - 4:1 - model number: **CSI-SPD4/700-2.7K/N**
- **Grounding Kit** - model number: **CSI-GKIT**
- **Lightning Arrestor** - model number: **CSI-CAP**

## Important Installation Notes

- The installer should refer to the Safety Guidelines section and the Important Safety Information section for proper antenna selection and installation. To avoid serious injury or death and damage to the pilot beacon, do not install server antennas near overhead power lines or high power components. Allow enough distance so that if antennas should fall they will not come in contact with those components.
- Close proximity to the server antennas with the pilot beacon in operation may expose the user or installer to RF fields that exceed FCC limits for human exposure.

**WARNING!** PILOT BEACON AND/OR HANDSET DAMAGE **MAY** OCCUR IF A HANDSET IS CONNECTED DIRECTLY TO THE PILOT BEACON OR THE COAX THAT LEADS TO THE PILOT BEACON.

## Powering Up the Unit

During Power up, the pilot beacon will require approximately three minutes for the internal computer to boot up. During this time the LED on the front panel may light and go out several times. When boot is complete and no alarm conditions exist, the LED indicators will be illuminated green.

**Do not unplug the unit while it is in the boot up process!**

## Local Communication Interface Ports

To allow monitoring and control, the pilot beacon is equipped with four ports that provide external communication access (1 Ethernet CAT-5, 1 DB-9 serial, and 2 USB). The Ethernet, CAT-5 port is provided as a primary communications port to the PC. One serial interface, COM 1, can provide communications to local PC. The USB interface provides a means to download files from a memory device. The DB-9 pin assignments of COM 1 conform to the standard Electronic Industries Association (EIA232) specification. A diagram of the pin descriptions is provided on the next page for reference.

Connecting a null modem cable to the COM 1 port and using a terminal emulation program with a PC will allow communication to the control processor's Text Menu Interface (TMI) for trouble shooting and advanced diagnostics. Call CSI technical support for assistance if you need to access these advanced features or for further information.

The proprietary external GPS receiver connection is made at the port labeled "GPS". ***Do not connect other devices or non-straight-through serial extension cables to this port.*** Place the GPS receiver in a location with the best view of the unobstructed sky that is possible, although a 100% open view of the sky is not necessary to achieve a stable time lock.

## EIA232 Pin Specifications

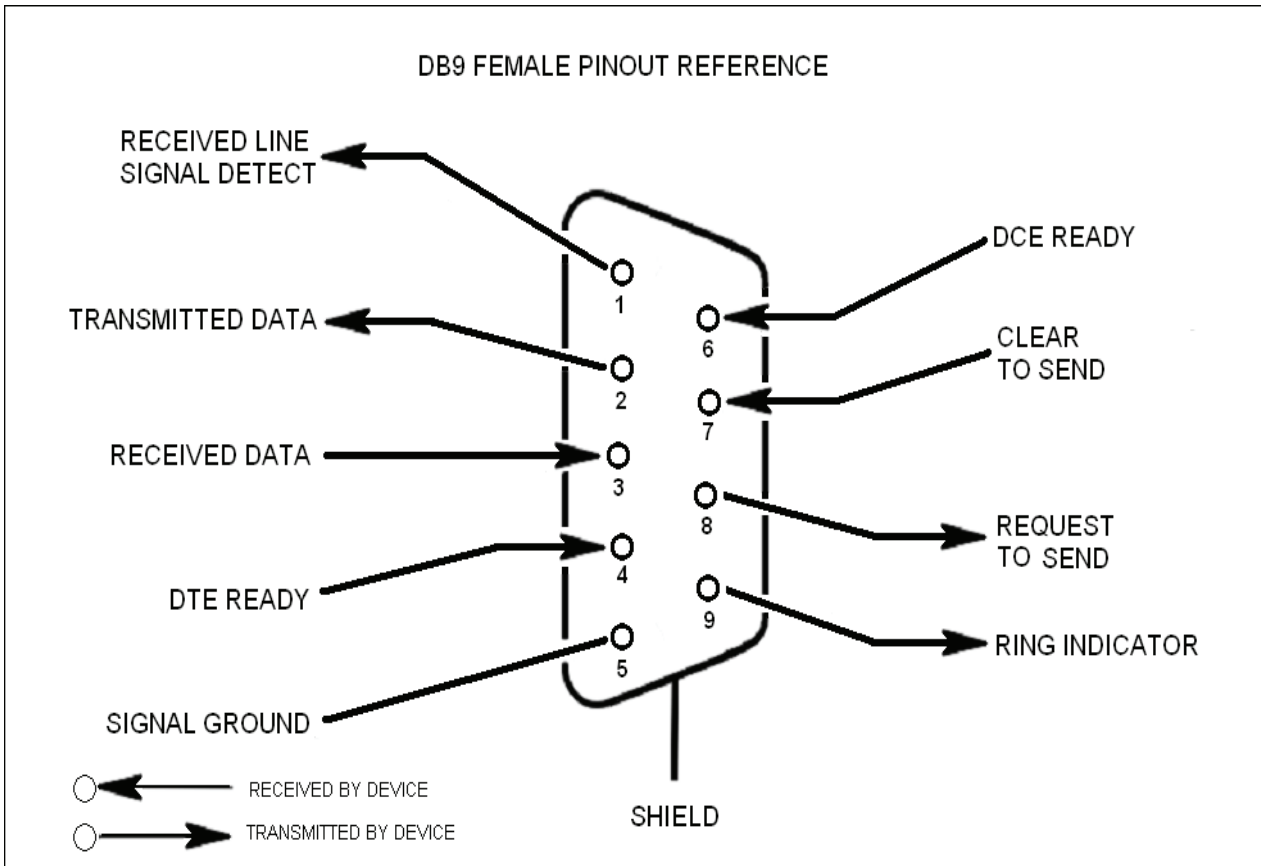

The diagram above is for reference only, it's intended to provide a quick source for pinout information in the event it should be necessary to adapt your serial cable because of an unusual connector configuration. In the vast majority of cases this information will not be needed.

## USB Interface

The Universal Serial Bus (USB) interface conforms to Intel's Universal Host Controller Interface (UHCI) version 1.1 dated March 21, 1996. This interface will support data transfer rates up to 12 Mbps and can be used for software updates.

## Ethernet

The Ethernet AUI conforms to IEEE 802.3 and is capable of supporting 10/100 Mbps communications speeds. This port is used to provide access to the UI.

## Monitoring & Alarms

There are no physical connections provided to exclusively and specifically communicate system or alarm status. Information with regard to system or alarm status is provided by the GUI accessible via the communication ports described earlier.

## Text Menu Interface

### Local Access

Local access to the pilot beacon TMI, also known as the console interface, is made by connecting a serial cable (optional), as shown in figure 1, from the serial connector of the laptop the serial port on the bottom end panel of the pilot beacon. This connector is labeled COM . In some cases, if the gender of the connector is not the same as shown in figure 1, a null modem adapter (optional) as shown in figure 2 may also be required.



Figure 1

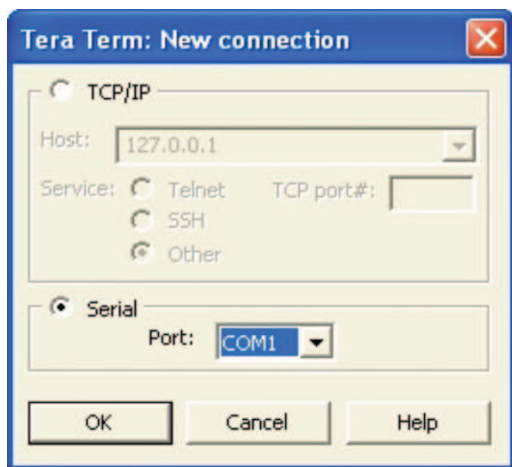
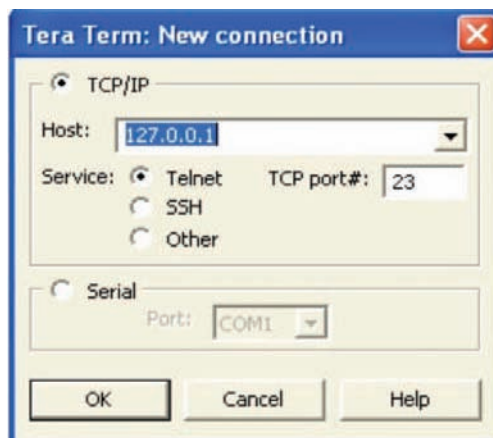

Figure 2

Many terminal emulation programs will work if properly configured. In the following description, "TeraTerm" is used to establish the TMI session. This program is readily available via the Internet and is free from Ayera Technologies at: <http://www.ayera.com/teraterm/>

TeraTerm Pro Web works on Windows 95/98, 2000, XP. Here is the latest TeraTerm Pro Web release: Version 3.1.3, October 8, 2002. ttp313.zip

When the program is started, the following screen is displayed.



Select the Serial radio button and press OK as shown below.

Note: It may be necessary, in the System Properties section of the control panel; using Device Manager to determine what COM port your computer uses for the communications port. In this case it is COM 1. This is not to be confused with the serial port on the bottom panel of the repeater labeled COM 1.

Pressing "OK" will open up a blank dialog screen. Go to the setup dropdown menu and select Serial port to make changes to the serial port setup.

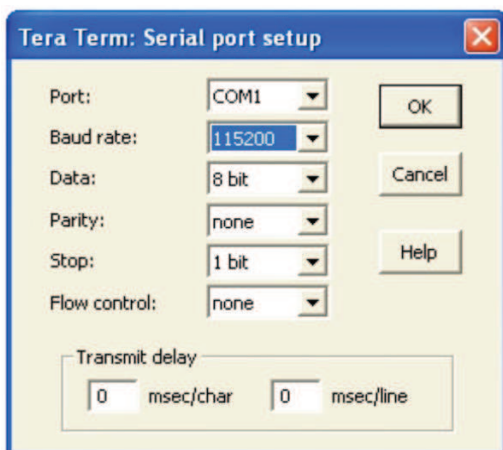
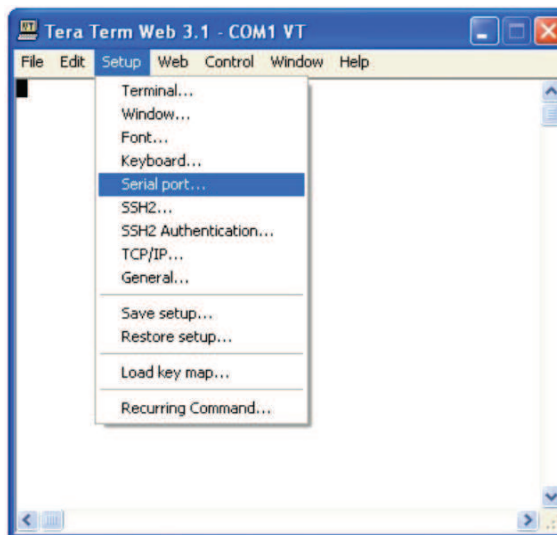

Configure the terminal program for the correct COM port, in this case COM 1 and 115200 baud rate as shown below.

## User Interface

### Login

Once the unit has completed its boot up and link initialization phases it will display the login prompt. The username is "bandone" for the first two beacons and "bandtwo" for the second two beacons. The password is "csi1234".

### Main Menu

Upon successful login the unit displays the main menu.

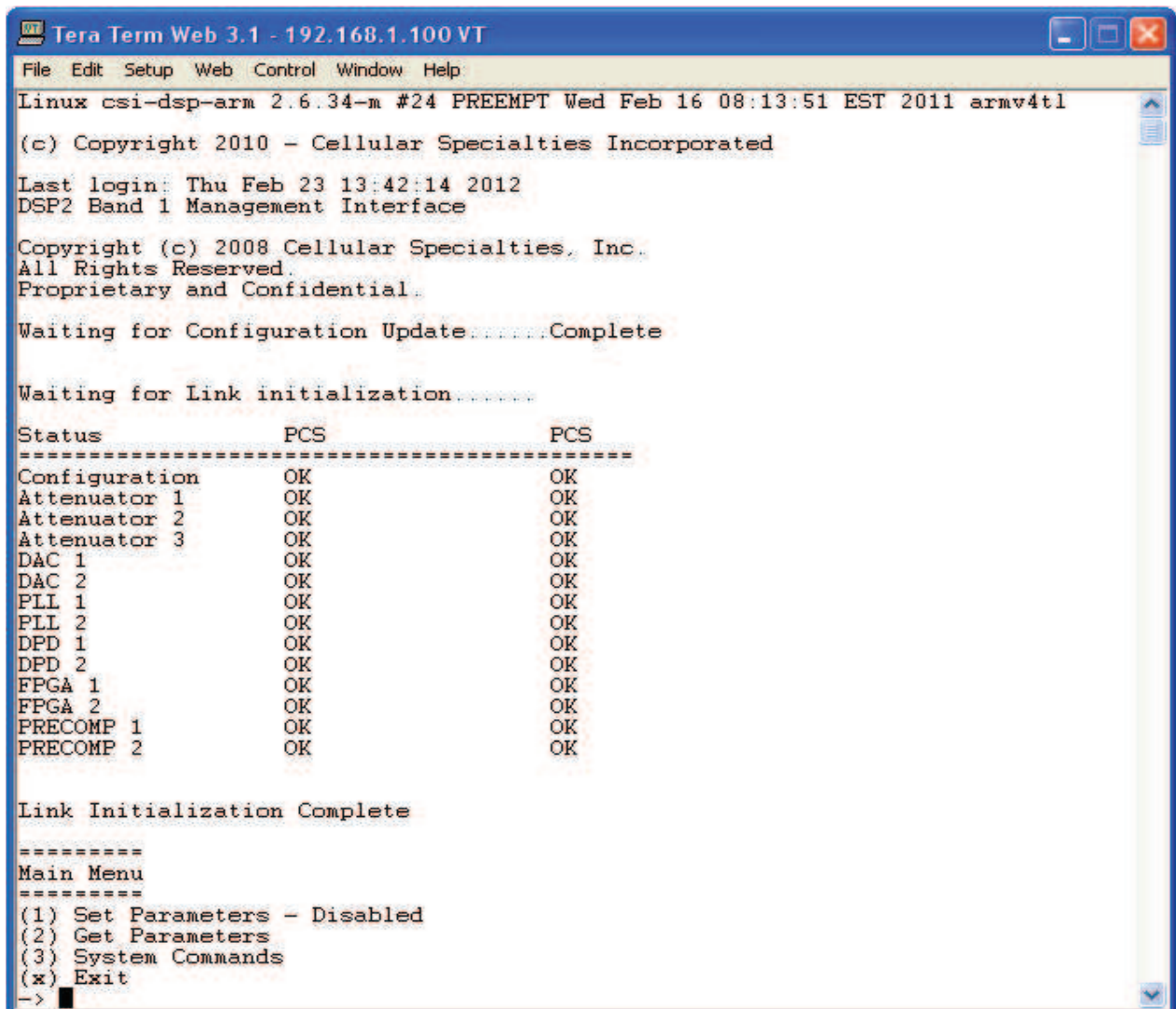

```
Tera Term Web 3.1 - 192.168.1.100 VT
File Edit Setup Web Control Window Help
Linux csi-dsp-arm 2.6.34-m #24 PREEMPT Wed Feb 16 08:13:51 EST 2011 armv4tl
(c) Copyright 2010 - Cellular Specialties Incorporated
Last login: Thu Feb 23 13:42:14 2012
DSP2 Band 1 Management Interface
Copyright (c) 2008 Cellular Specialties, Inc.
All Rights Reserved.
Proprietary and Confidential.
Waiting for Configuration Update.....Complete
Waiting for Link initialization.....
Status          PCS          PCS
-----
Configuration    OK           OK
Attenuator 1     OK           OK
Attenuator 2     OK           OK
Attenuator 3     OK           OK
DAC 1            OK           OK
DAC 2            OK           OK
PLL 1            OK           OK
PLL 2            OK           OK
DPD 1            OK           OK
DPD 2            OK           OK
FPGA 1           OK           OK
FPGA 2           OK           OK
PRECOMP 1        OK           OK
PRECOMP 2        OK           OK
Link Initialization Complete
=====
Main Menu
=====
(1) Set Parameters - Disabled
(2) Get Parameters
(3) System Commands
(x) Exit
-> █
```

When "Set Parameters" is first selected the unit will ask for the maintenance mode login. (The default username for the maintenance mode is "csi" and the password is "csi1234".)

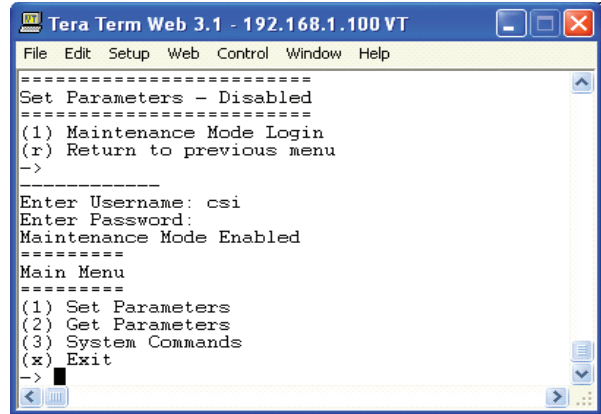
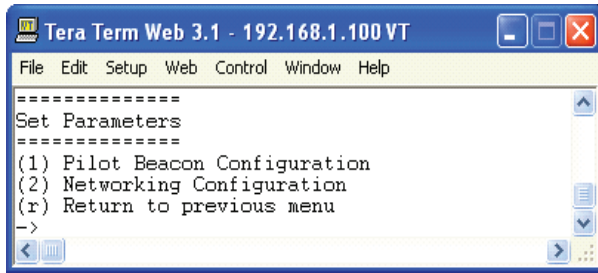

### Set Parameters Menu

Once the maintenance mode login is performed successfully the main menu will be displayed again but without the "(Disabled)" qualifier on the "Set Parameters" choice.

## Telnet Session (Remote Access)

The diagram below shows the normal use of Crossed and Straight cables.

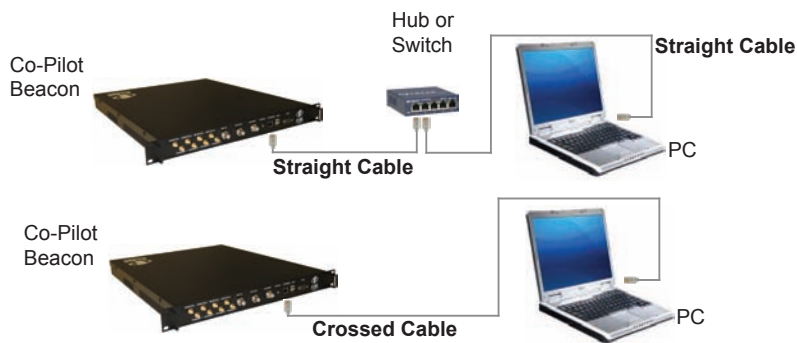

Pin #	Signal	AT&T 258A	Cable Type
1	Transmit+	White/Orange	<b>Straight Cable</b> 
2	Transmit-	Orange/White or Orange	
3	Receive+	White/Green	
4	N/A	Blue/White or Blue	
5	N/A	White/Blue	
6	Receive-	Green/White or Green	
7	N/A	White/Brown	
8	N/A	Brown/White or Brown	
Pin #	Signal	AT&T 258A	Cable Type
1	Receive+	White/Orange	<b>Crossed Cable</b> 
2	Receive-	Orange/White or Orange	
3	Transmit+	White/Green	
4	N/A	Blue/White or Blue	
5	N/A	White/Blue	
6	Transmit-	Green/White or Green	
7	N/A	White/Brown	
8	N/A	Brown/White or Brown	



Remote access to the repeater may be gained through a LAN connection and a terminal emulation program for TCP/IP. As with the serial connection, many terminal emulation programs will work, if properly configured. In the following description, "TeraTerm" is used to establish the Telnet session. Also, it will be required that the network configuration of the computer and the repeater being controlled be set up with the same Sub Net and Sub Net Mask in order to establish a link. In other words, the IP addresses of both the computer used and the repeater must use the same group of IP address number sets. For example, the repeater ships with the default IP address of 192.168.1.100 and a Sub Net Mask of 255.255.255.0. In order to connect, the computer to be used for the link would normally need an IP address of something like 192.168.1.12 with a Sub Net Mask of 255.255.255.0, the same Sub Net Mask as the repeater. In this example note: the last digit of the IP address may be any number except 1,100 and 255. Configuring your PC is normally fairly straight forward but it does vary somewhat with the operating system involved. If you require assistance, contact your IT department and they will be able to set up your PC for you or you may review the Additional Tips Section at the end of the manual.

When the TeraTerm program is started, the following screen is displayed. Change the default host IP address to the IP address of the repeater to be controlled. In the case of a new install, the default address is 192.168.1.100 and has been assigned at the factory. Select the service Telnet. The TCP Port must be 23.

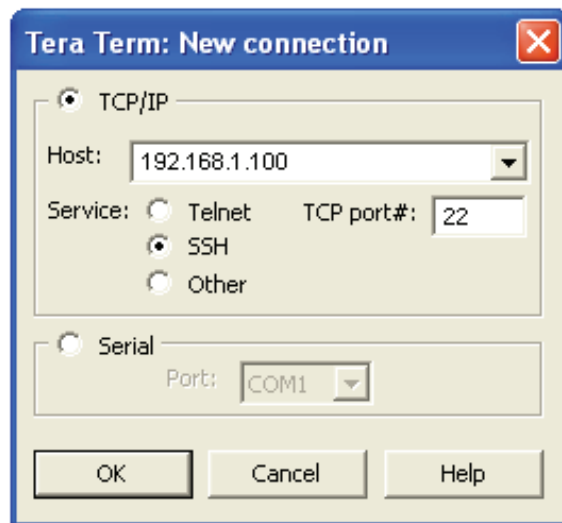

Pressing the "OK" button will display the security alert shown below.

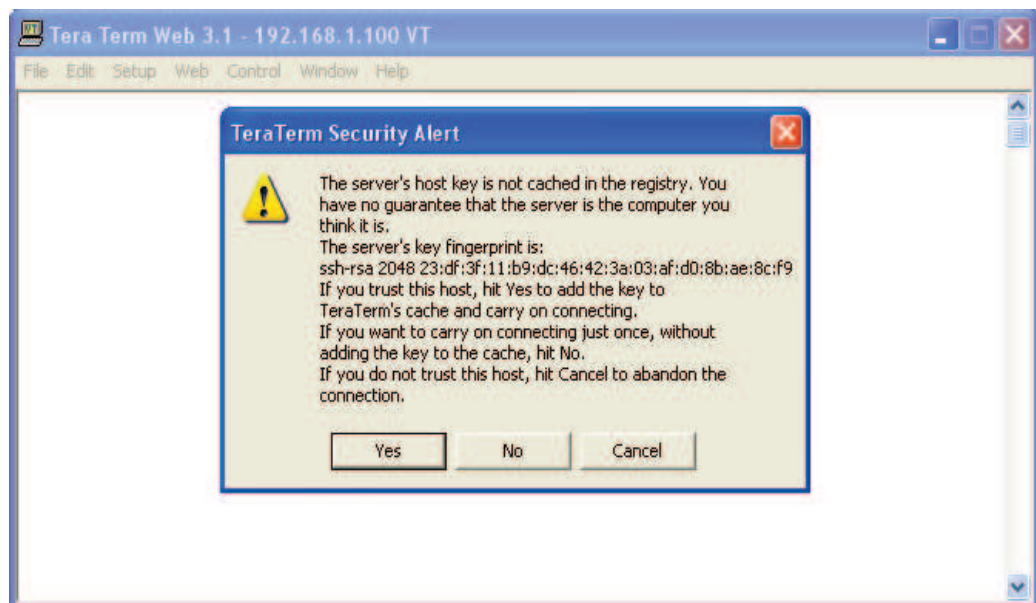

Click the yes button and the first SSH2 Authentication Challenge screen is displayed. The user then types the username in the space provided. In multi beacon units, each set of beacons are changed independently and requires an independent login. To make changes default user names are "bandone" for the first two beacons and "bandtwo" for the second two beacons respectively .

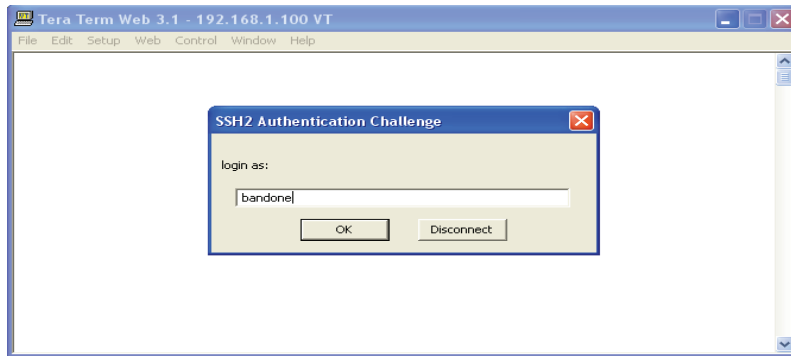

Press OK after entering the user name and the second SSH2 Authentication Challenge will be displayed.

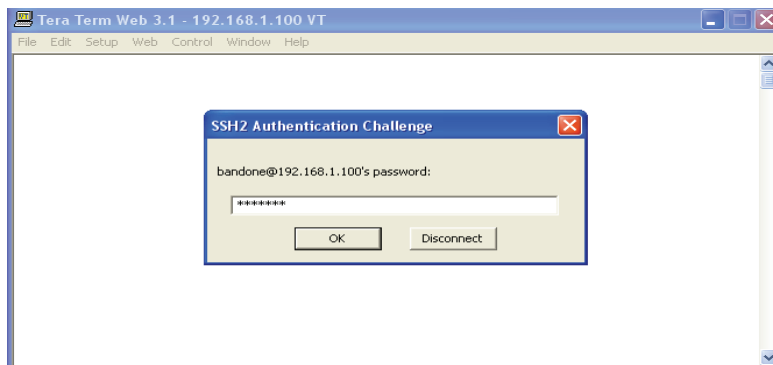

In the field provided, type the user name for the beacon to be changed. The default password is "csi1234" for all beacons. After typing the password press OK and the main menu will be displayed as shown next.

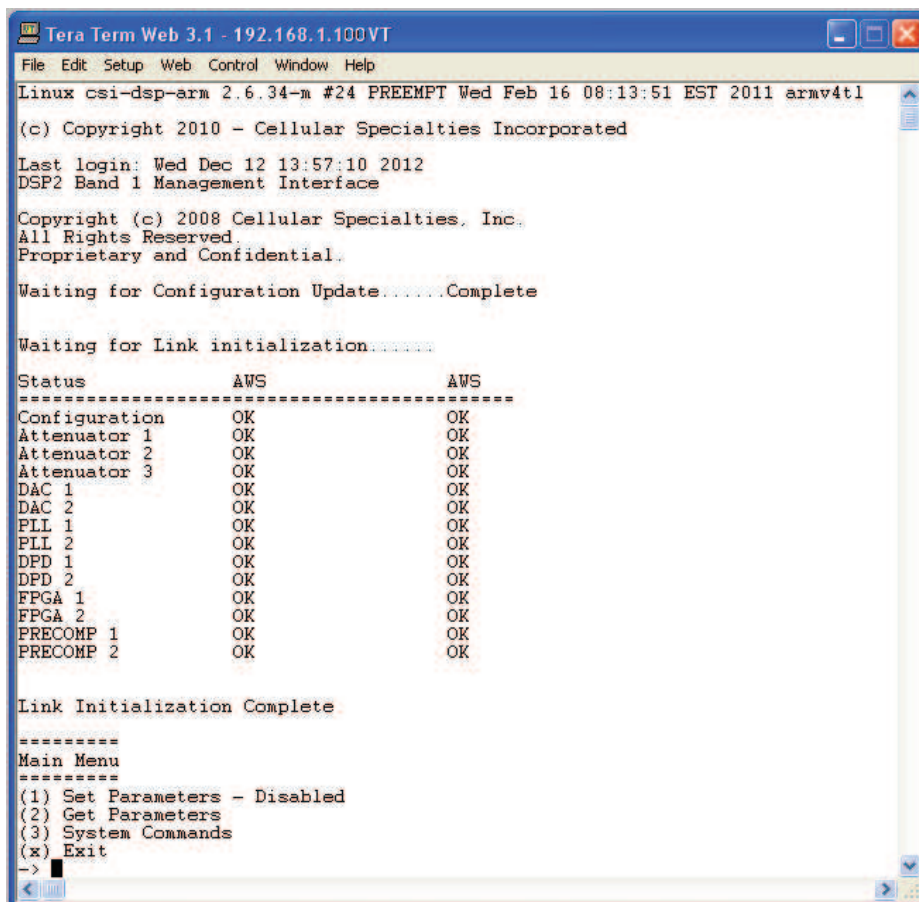

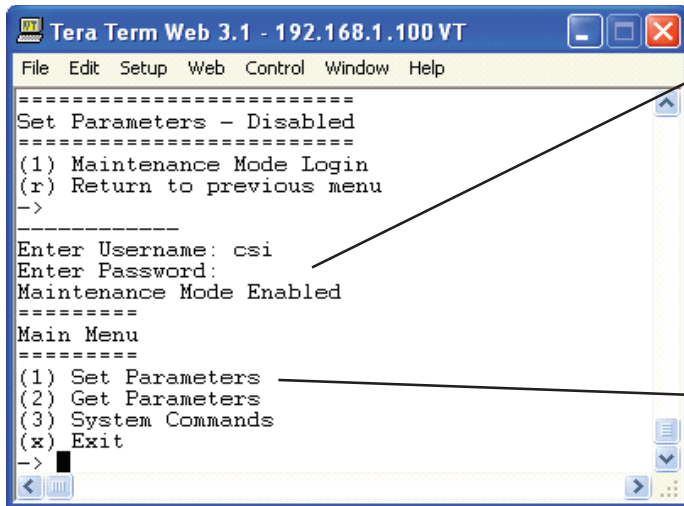

When "Set Parameters" is first selected the unit will ask for the maintenance mode login. (The default username for the maintenance mode is "csi" and the password is "csi1234".)

Once the maintenance mode login is performed successfully the main menu will be displayed again but without the "(Disabled)" qualifier on the "Set Parameters" choice.

## Set Parameters Menu

Selection of option 1 will display the Co-Pilot Configuration Menu. Option 2 displays the Networking Configuration Menu. These menus allow the user to choose set up options menus that are fairly self explanatory but are displayed in the following pages for clarification.

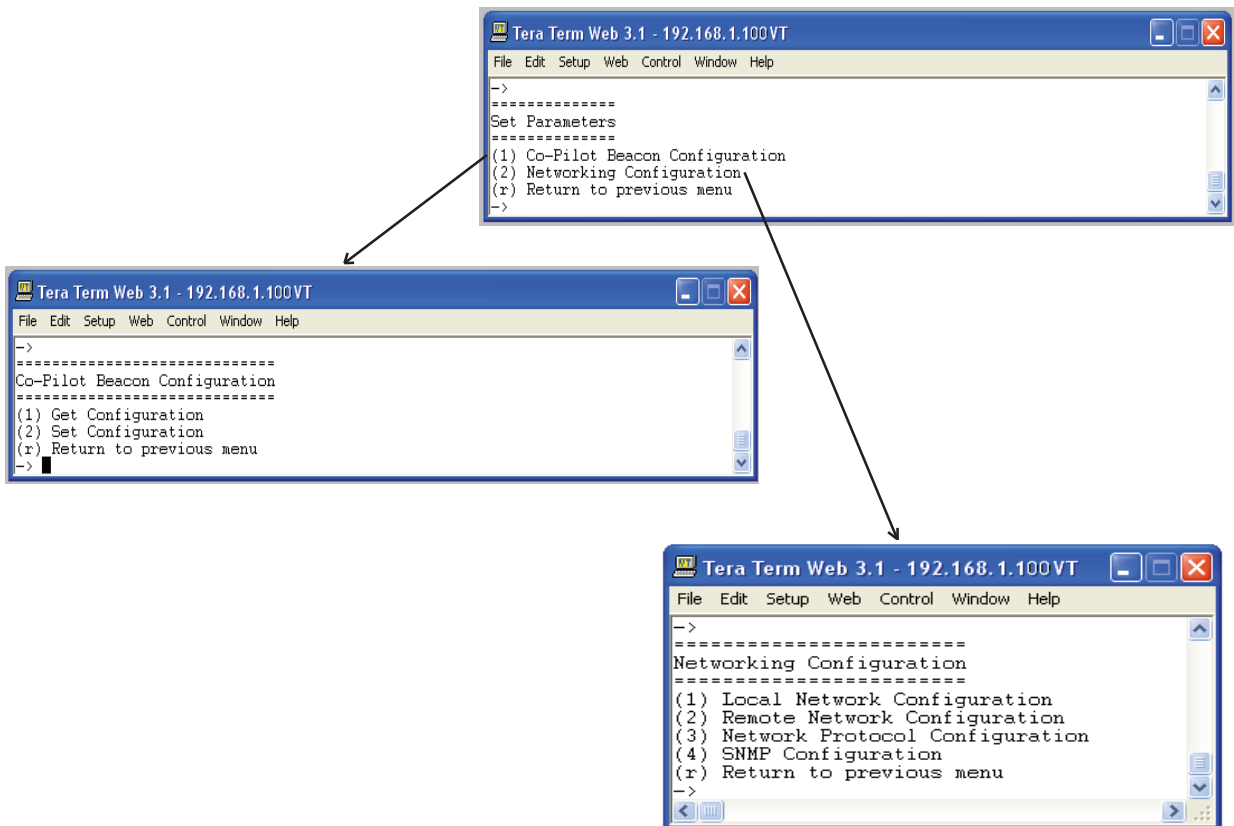

# Co-Pilot Beacon Configuration

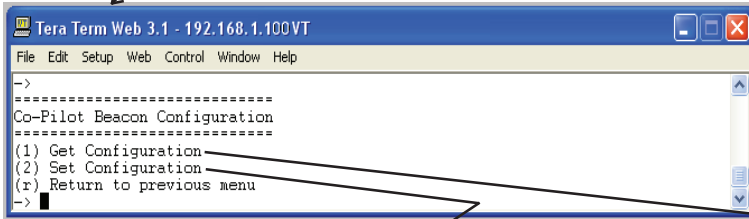
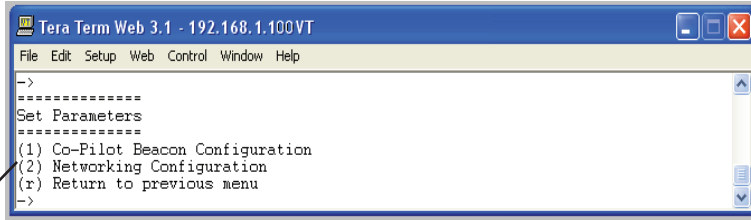

Selecting option 1 will display the current beacon configuration but does not allow the user to change any setting.

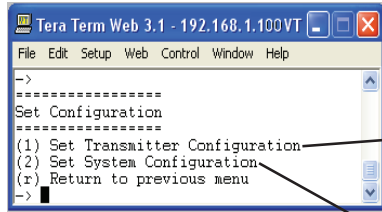
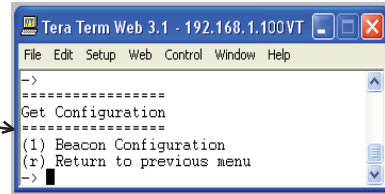

Selection of option 2 allows for the setting of Transmitter and System Configuration.

## Transmitter Configuration

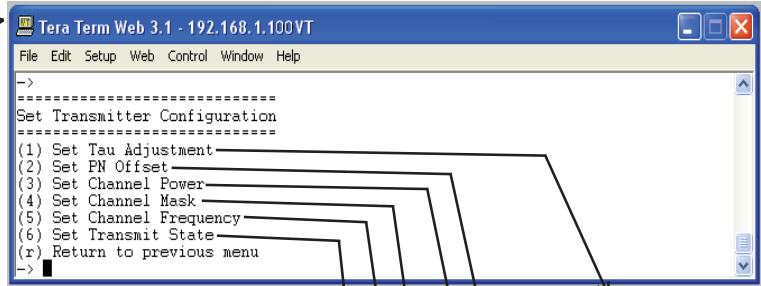

See next page for the Set System Configuration selections.

\* Note Top line parenthesis shows current value. Bottom line shows current value. Bottom line shows range of acceptable values.

When selecting each option on the Set Transmitter Configuration menu the user is presented with the Select Transmitter menu first to allow for the selection of transmitter for this section of the unit.

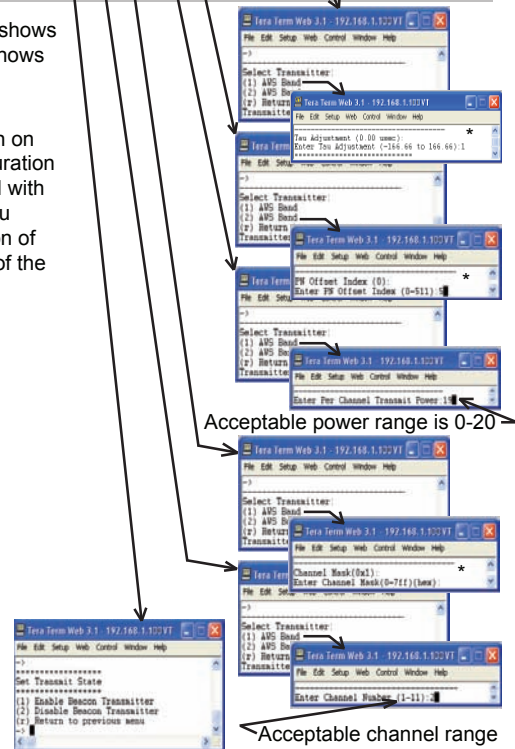

Acceptable power range is 0-20

Acceptable channel range

## System Configuration

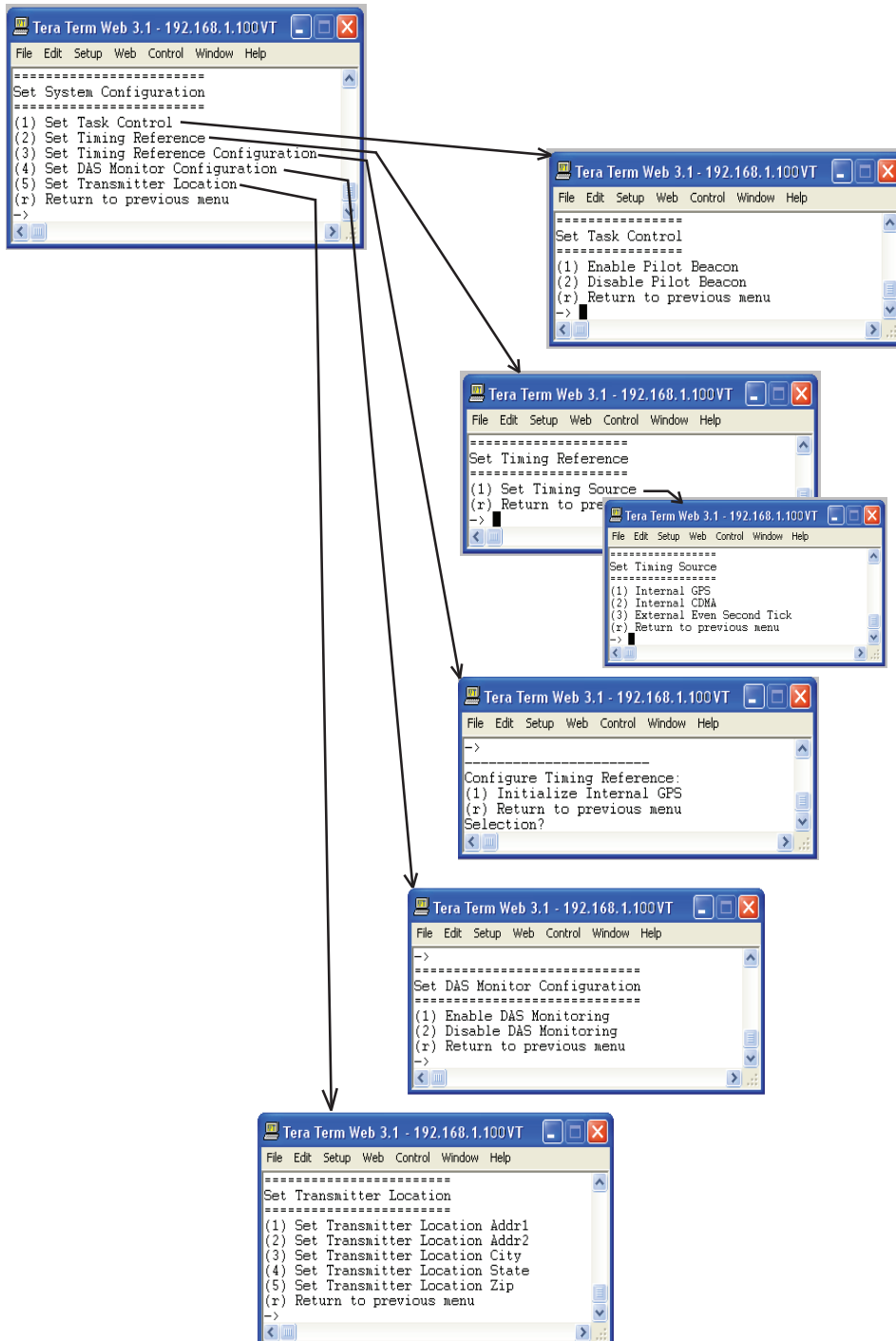

## Networking Configuration

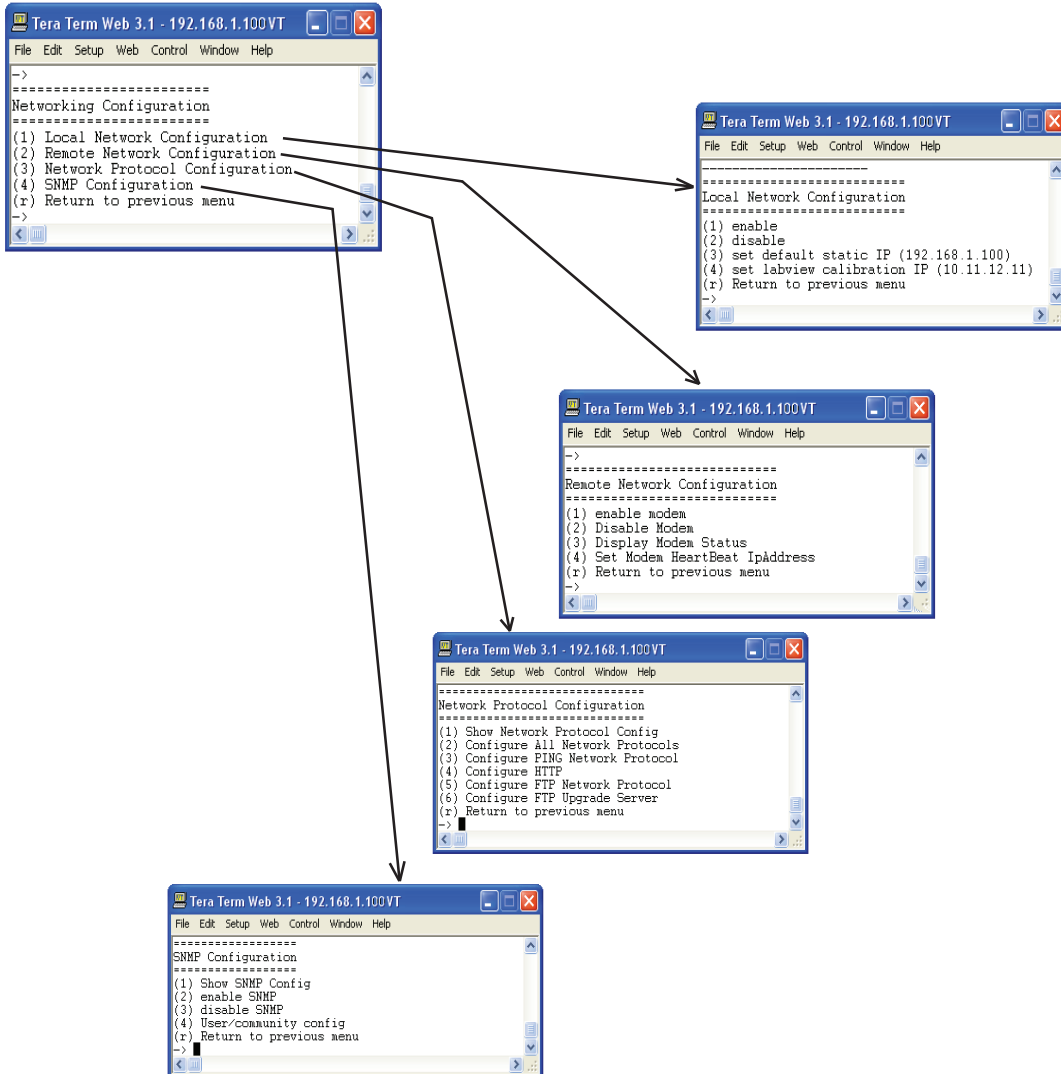

If the user is unclear about the network configuration that should be used for setup of the Co-Pilot Beacon, he or she should contact the Network Administrator for information with regard to the specific network settings.

## System Commands

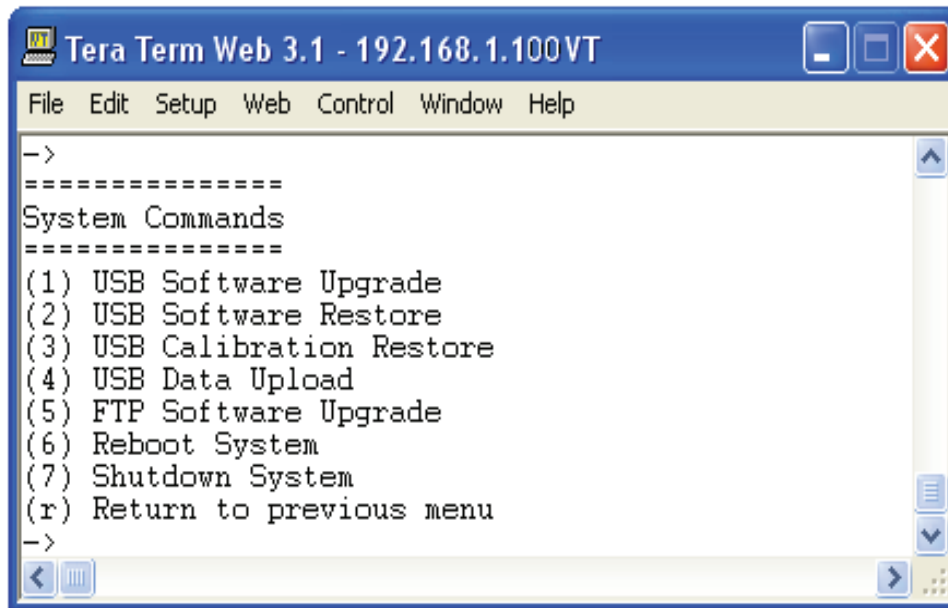

The System Commands Menu will allow the user to upgrade and restore the unit OS, restore factory calibration settings, upload new data files, upgrade FTP software, reboot and shutdown the system.

## Key Features

### Multiple Beacon Configuration

Each unit contains four independent beacons. These can be all in the same band or two of one band and two of another.

### Detected RF Power Shutdown

The product contains an RF power detector for each transmitter that can be used to sense the power being transmitted by the DAS. Loss of the DAS requires that the beacon be shut down in order to provide some possibility for mobile devices to connect to the low level signal of the macro network.

The shutdown threshold is set by the user. When the detected power falls below the set threshold the transmit power of all beacons is shut down and an alarm is issued. When the power rises above the threshold the beacons are turned back on.

### Timing Reference Source

A GPS derived timing reference is always required for the proper operation of the Co-co-pilot beacon. That timing reference can be provided by one of the following:

- An optional internal GPS receiver
- An optional internal CDMA timing receiver
- The CSI supplied external CDMA Timing Reference Receiver
- The CSI supplied external precision GPS Timing Reference (Spectrum Instruments TM-4)
- Any user-supplied GPS Receiver capable of providing a TTL compatible even second tick aligned to GPS (not UTC) time.

### Control Parameter Details

#### Master Shutdown

The Master Shutdown shuts down the transmissions from all beacons in the product.

#### Timing Reference Selection

There are three alternatives for the timing reference source and all beacons in the product use the same reference.

- Internal GPS
- Internal CDMA
- External Even Second Sync

The choices that are available will depend on the product type as follows:

- MX- "External" only
- MG- "External" and "Internal GPS"
- MO- "External" and "Internal CDMA"

The default choice will also depend on the product type as follows:

- MX- "External"
- MG- "Internal GPS"
- MO- "Internal CDMA"

Selecting "Internal GPS" enables the use of the internal GPS receiver. An appropriate antenna with a clear view of the sky must be connected to the "Timing In" connector of the Co-pilot beacon. This choice is only available if the unit includes the optional GPS timing reference.

Selecting "Internal CDMA" enables the use of the internal CDMA receiver. Either an appropriate antenna, or a cable carrying a valid CDMA Base Station signal, must be connected to the "Timing In" connector of the Co-pilot beacon. This choice is only available if the unit includes the optional CDMA timing reference.

Selecting "External Even Second" enables the use of a TTL compatible even second pulse via the "EST In" connector of the Co-Co-pilot beacon. The rising edge of the pulse is used as the time reference and must be aligned with the start of the even second of GPS (not UTC) Time.

The even second tick provided by the selected Timing Reference will appear on the "EST Out" connector.



## Channel Frequency Numbers

Each co-pilot beacon can transmit up to eleven simultaneous CDMA2000 signals. The carrier frequency for each signal is set by entering the desired CDMA channel number for that signal.

Thus, there are eleven Channel Number fields, one for each of the possible signals.

The CDMA channel number is a unit less integer value

The range is 1 to 799 and then 991 to 1023 for cell band, 1 to 1199 for PCS band, and 25 to 875 for AWS band. Duplicate channel numbers are not allowed.

The default values for a Cell Band beacon are:

Signal 1: CDMA Channel 384  
Signal 2: CDMA Channel 425  
Signal 3: CDMA Channel 466  
Signal 4: CDMA Channel 507  
Signal 5: CDMA Channel 548  
Signal 6: CDMA Channel 589  
Signal 7: CDMA Channel 770  
Signal 8: CDMA Channel 1  
Signal 9: CDMA Channel 9  
Signal 10: CDMA Channel 10  
Signal 11: CDMA Channel 11

The default values for PCS and AWS Band beacons are:

Signal 1: CDMA Channel 1  
Signal 2: CDMA Channel 2  
Signal 3: CDMA Channel 3  
Signal 4: CDMA Channel 4  
Signal 5: CDMA Channel 5  
Signal 6: CDMA Channel 6  
Signal 7: CDMA Channel 7  
Signal 8: CDMA Channel 8  
Signal 9: CDMA Channel 9  
Signal 10: CDMA Channel 10  
Signal 11: CDMA Channel 11

## Signal Transmit Enables

Each of the eleven signals for a given beacon can be individually turned on or off. There is one transmit enable field for each signal.

The default values for a Cell Band beacon are:

Signal 1: Enabled  
Signal 2: Enabled  
Signal 3: Enabled  
Signal 4: Enabled  
Signal 5: Enabled  
Signal 6: Enabled  
Signal 7: Enabled  
Signal 8: Disabled  
Signal 9: Disabled  
Signal 10: Disabled  
Signal 11: Disabled

The default values for PCS and AWS Bands beacons are:

Signal 1: Disabled  
Signal 2: Disabled  
Signal 3: Disabled  
Signal 4: Disabled  
Signal 5: Disabled  
Signal 6: Disabled  
Signal 7: Disabled  
Signal 8: Disabled  
Signal 9: Disabled  
Signal 10: Disabled  
Signal 11: Disabled

## **PN Offset**

Each beacon has its own PN Offset. The PN Offset is a unitless integer value with a range of 0 to 511. The default value is zero.

## **Tau (Delay Correction)**

There is a single Tau value for each beacon in a given product unit. Tau is a real value in units of microseconds with a range of -166.7 to +166.7  $\mu$ sec and one decimal place of precision. Internally the value will be rounded to the nearest 1/40th of a CDMA chip.

## **Co-pilot beacon Per Channel Transmit Power**

This setting controls the CDMA Channel Power output by a given Co-pilot beacon for each carrier. All enabled carriers are transmitted at the same power level. The total transmit power will be the sum of the power of all enable carriers. The user must set this power level such that the total transmit power does not exceed the specified maximum transmit power for the Co-pilot beacon.

The Output Power is specified in dBm with a range of 0.0 to 20.0 and a resolution of 0.5.

## **Composite Transmit Power**

Composite output power is a display only field. The value is calculated from the Per Channel Tx Power and the number of channels that are enabled.

## **Manual Shutdown**

Manual Shutdown allows the user to shut down transmission from the given beacon

## **Auto Shutdown Enable**

The detected power shutdown feature can be enabled or disabled.

## **Auto Shutdown Threshold**

The shutdown threshold is entered in units of dBm.

The allowable range is -26 to +4 dBm

## **Detected Power**

Detected power is a display only field that displays the current reading of the power detector for the given beacon. The measured power is displayed in units of dBm and has a range of -30 to +10.

## Additional Tips

Instructions to change TCP/IP settings on your Windows computer.

Click in the Network Connections Icon in the Control Panel. See below.

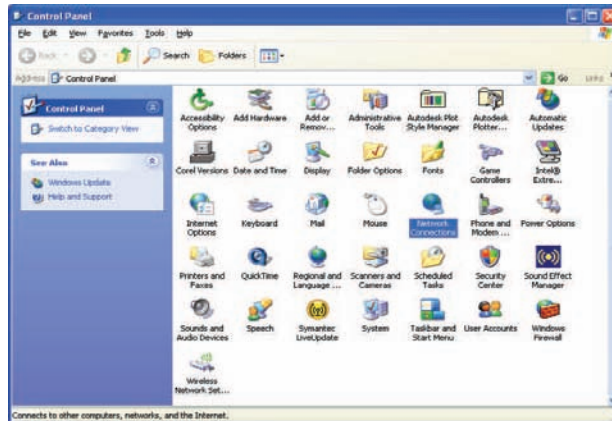

Right click on Local Area Connection - and select "Properties".

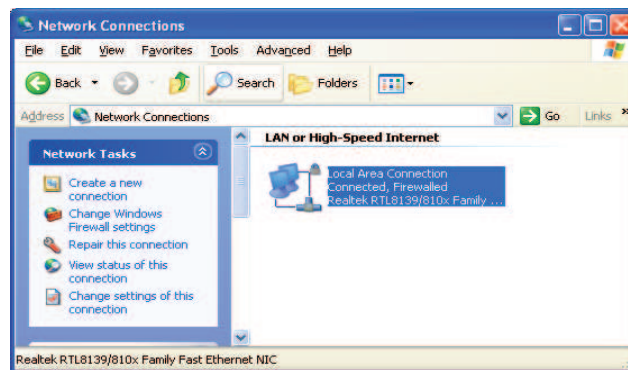

Scroll down to "Internet Protocol (TCP/IP) and click on the "Properties" button.

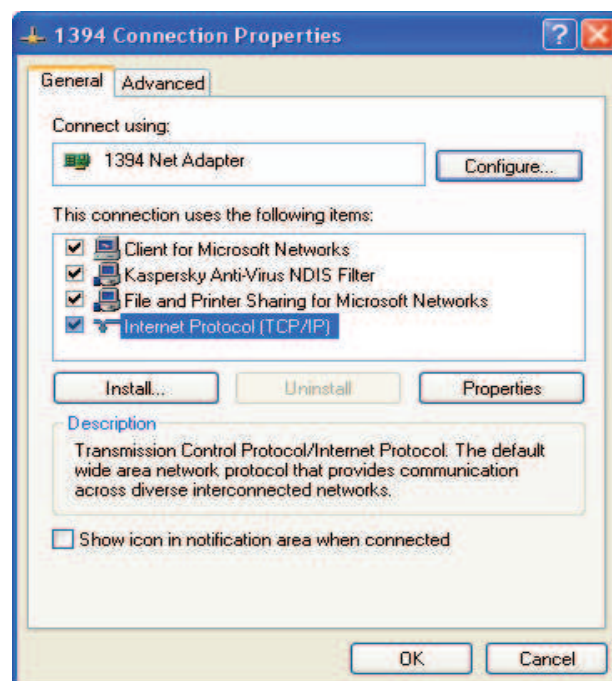

If you are set up to use DHCP, the window shown below will be displayed.

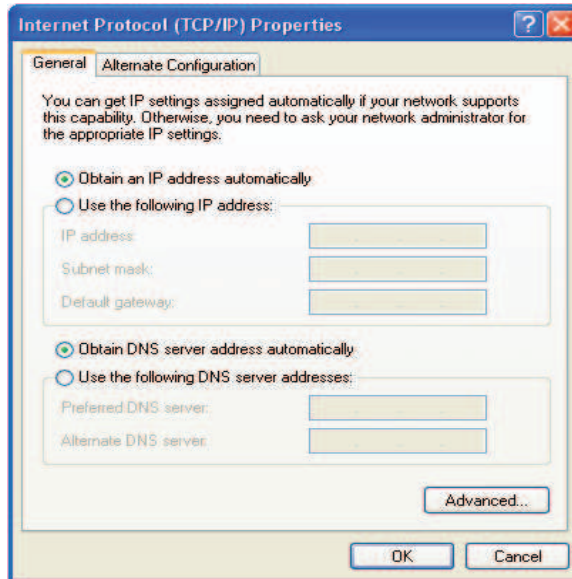

Select "Use the following IP address:" and enter "192.168.1.2." The subnet mask should automatically populate to "255.255.255.0".

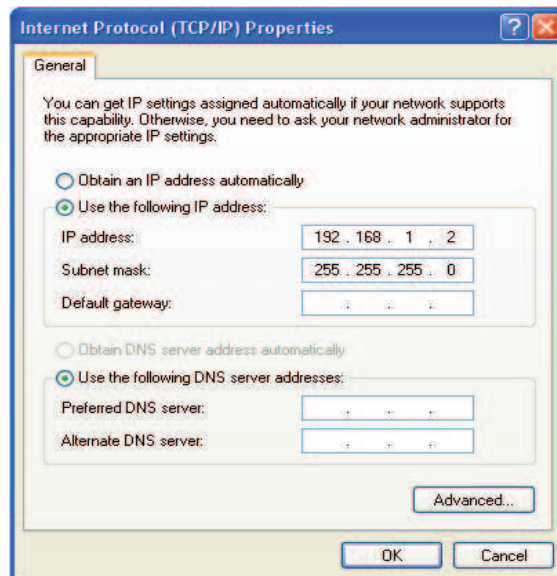

Nothing else will need to be chosen or entered. Click "OK", then "OK again and retry connection.

A crossover Ethernet cable (supplied) must be used for Web Interface access. As a reminder, you must verify the Ethernet port on your laptop is powered. If your laptop is on battery power, the Ethernet port may be inactive by default. If this is the case simply plug in the laptop to a 110vac source or change the power settings to enable the Ethernet port when the laptop is using battery power.

## **One Year Limited Warranty**

Seller warrants that its products are transferred rightfully and with good title; that its products are free from any lawful security interest or other lien or encumbrance unknown to Buyer; and that for a period of one year from the date of installation or fifteen months from the date of original shipment, whichever period expires first, such products will be free from defects in material and workmanship which arise under proper and normal use and service. Buyer's exclusive remedy hereunder is limited to Seller's correction (either at its plant or at such other place as may be agreed upon between Seller and Buyer) of such defects by repair or replacement at no cost to Buyer. Transportation costs in connection with the return of products to Seller's plant or designated facility shall be paid by Buyer. The provisions of this warranty shall be applicable with respect to any product which Seller replaces pursuant to it. SELLER MAKES NO WARRANTY, EXPRESS OR IMPLIED, OTHER THAN AS SPECIFICALLY STATED ABOVE. EXPRESSLY EXCLUDED ARE THE IMPLIED WARRANTIES OF MERCHANTABILITY AND FITNESS FOR PURPOSE. THE FOREGOING SHALL CONSTITUTE ALL OF SELLER'S LIABILITY (EXCEPT AS TO PATENT INFRINGEMENT) WITH RESPECT TO THE PRODUCTS. IN NO EVENT SHALL SELLER BE LIABLE FOR SPECIAL, CONSEQUENTIAL OR INCIDENTAL DAMAGES, INSTALLATION COSTS, LOST REVENUE OR PROFITS, OR ANY OTHER COSTS OF ANY NATURE AS A RESULT OF THE USE OF PRODUCTS MANUFACTURED BY THE SELLER, WHETHER USED IN ACCORDANCE WITH INSTRUCTIONS OR NOT. UNDER NO CIRCUMSTANCES SHALL SELLER'S LIABILITY TO BUYER EXCEED THE ACTUAL SALES PRICE OF THE PRODUCTS PROVIDED HEREUNDER. No representative is authorized to assume for Seller any other liability in connection with the products.

**Industry Certifications/Registration Numbers**

NVRCSI-CPBRW-CP, NVRCSI-CPBRW-AW

UL - Power Supply: UL60950-1

# Index

## A

AC Current 6  
AC Power Frequency 6  
AC Power Specifications 6  
Acronyms and Definitions 5  
AC Voltage 6  
Additional Tips 27  
Application 4  
Auto Shutdown Enable 26  
Auto Shutdown Threshold 26

## B

Box Weight 6

## C

Channel Frequency Numbers 25  
Composite Transmit Power 26  
Control Parameter Details 24  
Co-Pilot Beacon Configuration 20  
Co-pilot beacon Per Channel Transmit Power 26

## D

Depth 6  
Detected Power 26  
Detected RF Power Shutdown 24

## E

EIA232 Pin Specifications 12  
Environmental Requirements 6  
Explosive Atmospheres 4

## F

Functional Overview: 6

## G

Grounding 4

## H

Height 6

## I

Important Installation Notes 11  
Industry Certifications/Registration Numbers 29

## K

Key Features 24

## L

Lightning Danger 4  
Limited Warranty 29  
Local Communication Interface Ports 11  
Login 15

## M

Main Menu 15  
Manual Shutdown 26  
Master Shutdown 24  
Mechanical Drawing 7  
Mechanical Specifications 6  
Monitoring & Alarms 12

Multiple Beacon Configuration 24

## N

Networking Configuration 22  
null modem adapter 13

## O

Optional Accessories 11

## P

PN Offset 26  
Powering Up the Unit 11  
Power supply cable connectors 11  
Product Introduction 5  
Product Registration Information 4

## R

Relative Humidity 6

## S

serial cable 13  
Set Parameters Menu 16, 19  
Signal Transmit Enables 25  
Surface Coating 6  
System Commands 23  
System Configuration 21  
System Set-Up Considerations 7

## T

Tau (Delay Correction) 26  
TCP/IP settings 27  
Telnet Session 16  
Telnet Session (Remote Access) 16  
Temperature Range 6  
terminal emulation programs 14  
Text Menu Interface 13  
Thermal Management 6  
Timing Reference Selection 24  
Timing Reference Source 24  
Transmitter Configuration 20

## U

UL - Power Supply 29  
USB Interface 12  
User Interface 15

## W

Warranty 29  
Web based GUI Session 13  
Width 6

## Notes

---

## Notes

---

---



## Notes

---

---

## Notes

---

---

## Notes

---

---



**960-1146-002 rev 004**



670 North Commercial Street  
Manchester, NH 03101

Toll Free: 1.877.844.4274  
Phone: 603.626.6677  
Fax: 603.626.6042

[www.cellularspecialties.com](http://www.cellularspecialties.com)