

Regulatory Compliance

This product complies with standards established by the following regulatory bodies:

- Federal Communications Commission (FCC)
- Industry Canada

FCC

This device complies with Part 15 of the FCC Rules. Operation is subject to the following two conditions: (1) this device may not cause harmful interference, and (2) this device must accept any interference received, including interference that may cause undesired operation.

This equipment has been tested and found to comply with the limits for a Class B digital device, pursuant to Part 15 of the FCC Rules. These limits are designed to provide reasonable protection against harmful interference in a residential installation. This equipment generates, uses, and can radiate radio frequency energy and, if not installed and used in accordance with the instructions, may cause harmful interference to radio communications. However, there is no guarantee that interference will not occur in a particular installation. If this equipment does cause harmful interference to radio or television reception, which can be determined by turning the equipment off and on, the user is encouraged to try to correct the interference by one or more of the following measures:

- Reorient or relocate the receiving antenna.
- Increase the separation between the equipment and receiver.
- Connect the equipment into an outlet on a circuit different from that to which the receiver is connected.
- Consult the dealer or an experienced radio/TV technician for help.

IMPORTANT! Changes or modifications not expressly approved by the manufacturer could void the user's authority to operate the equipment.

Industry Canada

This device complies with Industry Canada licence-exempt RSS standard(s). Operation is subject to the following two conditions: (1) this device may not cause interference, and (2) this device must accept any interference, including interference that may cause undesired operation of the device.

Cumplimiento Normativo

Este producto cumple con las normas establecidas por los siguientes organismos reguladores:

- Comisión Federal de Comunicaciones (FCC)
- Industry Canada

FCC

Este dispositivo cumple con la 15ª parte del reglamento de la FCC. Su funcionamiento está sujeto a las siguientes dos condiciones: (1) este dispositivo no deberá causar ninguna interferencia dañina, y (2) este dispositivo deberá aceptar cualquier interferencia recibida, incluyendo aquella que podría causar un funcionamiento no deseado.

Se realizaron pruebas a este equipo cuyos resultados revelaron que cumple con los límites establecidos para un dispositivo digital de la Clase B, conforme a la 15ª parte del reglamento de la FCC. Estos límites han sido impuestos para proporcionar protección razonable contra interferencias dañinas en una instalación residencial. Este equipo genera, utiliza y puede irradiar energía de radiofrecuencia y, si no se instala y utiliza según lo que indican las instrucciones, podría causar interferencia dañina en radiocomunicaciones. Sin embargo, no hay garantía de que la interferencia no ocurrirá en determinadas instalaciones. Si este equipo efectivamente causa interferencia en la recepción de radio o televisión, la cual puede determinarse encendiendo y apagando el equipo, sugerimos al usuario que intente corregir dicha interferencia tomando una o más de las siguientes medidas:

- Volver a orientar o ubicar la antena receptora.
- Incrementar la distancia entre el equipo y el receptor.
- Conectar el equipo a una toma de corriente en un circuito distinto del circuito en el cual está conectado el receptor.
- Consultar con el distribuidor o un técnico de radio y TV con experiencia para obtener su ayuda.

¡IMPORTANTE! Todo cambio o modificación no aprobado expresamente por el fabricante podría desautorizar al usuario para operar el equipo.

Industria de Canada

Este dispositivo cumple con las normas de la Industria de Canada licencia-exenta RSS. Su funcionamiento está sujeto a las siguientes dos condiciones: (1) este dispositivo no deberá causar ninguna interferencia dañina, y (2) este dispositivo deberá aceptar cualquier interferencia, incluyendo aquella que podría causar el funcionamiento no deseado del dispositivo.

Conformité réglementaire

Ce produit est conforme aux normes établies par les organismes de réglementation suivants :

- Federal Communications Commission (FCC)
- Industrie Canada

FCC

Cet appareil est conforme aux limites prescrites dans la partie 15 des règlements de la Federal Communication Commission (FCC) des États-Unis. Son utilisation est subordonnée aux conditions suivantes : (1) l'appareil ne doit pas causer d'interférence nuisibles, et (2) il doit accepter toute interférence, y compris celles qui peuvent causer son mauvais fonctionnement.

Lors des tests effectués, cet appareil s'est révélé conforme aux limites prescrites dans la partie 15 des règlements de la Federal Communications Commission (FCC) des États-Unis pour un appareil numérique de Classe B. Ces limites ont été fixées pour protéger raisonnablement les installations résidentielles contre les interférences nuisibles. L'appareil produit, utilise et peut émettre des radiofréquences. S'il n'est pas installé et utilisé de la façon prescrite, il peut brouiller les communications radio. Il n'est pas garanti qu'aucune interférence ne se produira. Si l'appareil brouille la réception d'une radio ou d'un téléviseur (pour savoir s'il est à l'origine du brouillage, il suffit de l'éteindre et de le rallumer), l'utilisateur est invité à tenter de corriger la situation en prenant une ou plusieurs des mesures suivantes :

- réorienter ou déplacer l'antenne réceptrice;
- éloigner davantage l'appareil émetteur du récepteur;
- brancher l'appareil dans une prise reliée à un circuit différent de celui auquel le récepteur est relié;
- consulter le détaillant ou un technicien de radiotélévision expérimenté pour obtenir de l'aide.











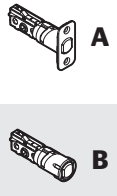

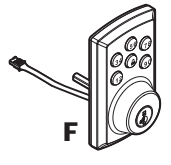









IMPORTANT! Les modifications qui n'ont pas été expressément approuvées par le fabricant de l'appareil peuvent annuler l'autorisation d'utiliser l'appareil.

Industrie Canada

Cet appareil est conforme aux normes d'Industrie Canada exemptes de licence RSS. L'opération est soumise aux deux conditions: (1) ce dispositif peut ne pas causer l'interférence et (2) ce dispositif doit accepter n'importe quelle interférence, y compris l'interférence qui peut causer le fonctionnement non souhaité du dispositif.



Parts in the box

<p>Latch</p>  <p>A B</p> <p>*"B" is not included. If needed, please contact Kwikset to order a drive-in latch for your lock.</p>	<p>Interior Assembly</p>  <p>M K L</p>	<p>Exterior Assembly</p>  <p>F</p>					
<p>Strike</p>  <p>C</p>	<p>Keys</p>  <p>E</p>	<p>Fasteners</p> <table border="1"> <tr> <td> <p>03809</p>  <p>N P</p> </td> <td> <p>46780</p>  <p>Q S</p> </td> </tr> <tr> <td> <p>66128</p>  <p>T</p> </td> <td> <p>49191</p>  <p>U</p> </td> <td> <p>64109</p>  <p>V</p> </td> </tr> </table>	<p>03809</p>  <p>N P</p>	<p>46780</p>  <p>Q S</p>	<p>66128</p>  <p>T</p>	<p>49191</p>  <p>U</p>	<p>64109</p>  <p>V</p>
<p>03809</p>  <p>N P</p>	<p>46780</p>  <p>Q S</p>						
<p>66128</p>  <p>T</p>	<p>49191</p>  <p>U</p>	<p>64109</p>  <p>V</p>					
<p>Adapter Ring</p>  <p>D</p>	<p>Mounting Plate</p>  <p>G</p>	<p>SmartKey Tool</p>  <p>H</p>					

ENGLISH

SMARTCODE 888

TOUCHPAD ELECTRONIC DEADBOLT

Installation and User Guide

Required tools

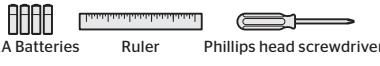

4 AA Batteries Ruler Phillips head screwdriver

Additional Tools (depending on application)

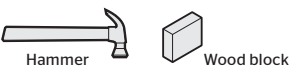

Hammer Wood block

Kwikset Technical Support

1-866-863-6584
www.kwikset.com

1 Prepare the door and check dimensions

If drilling a new door, use the supplied template and the complete door drilling instructions available at www.kwikset.com/doorprep.

<p>A Measure to confirm that the hole in the door is either 2-1/8" (54 mm) or 1-1/2" (38 mm).</p>	<p>B Measure to confirm that the backset is either 2-3/8" or 2-3/4" (60 or 70 mm).</p>	<p>C Measure to confirm that the hole in the door edge is 1" (25 mm).</p>	<p>D Measure to confirm that the door is between 1-3/8" and 2" (35 mm and 51 mm) thick.</p>
--	---	--	--

Note: Additional door preparation may be required for doors with 1-1/2" (38 mm) holes. Consult the deadbolt drilling instructions at www.kwikset.com/doorprep.

2 Install the latch and strike

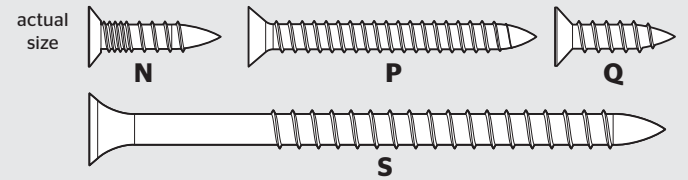

<p>A Is the door edge chiseled?</p> <div style="display: flex; justify-content: space-around;"> <div style="width: 45%;"> <p>YES</p> <p>Use latch "A". If the latch bolt is not already extended, extend the latch bolt as shown.</p> </div> <div style="width: 45%;"> <p>NO</p> <p>Use latch "B" (not included). If the latch bolt is not already extended, extend the latch bolt as shown.</p> </div> </div>

3 Install the exterior keypad



A What is the diameter of the hole in the door?

<p>Diameter is 2-1/8" (54 mm)</p>	<p>or</p>	<p>Diameter is 1-1/2" (38 mm)</p>
<p>"D" is required for installation. Install "D" on "F".</p>		
	<p>"D" is not needed for installation. Discard "D".</p>	

B Locate screws for step 3C and keep them within reach.



C Install exterior keypad and mounting plate.

<p>a</p>	<p>b</p> <p>Support exterior assembly during mounting plate installation.</p> <p>Route cable through center hole, then push cable into bottom hole.</p>
<p>c</p> <p>Keep parallel to edge of door.</p> <p>Tighten T (2x) screws evenly.</p>	<p>d</p> <p>Insert key and test latch. If latch does not extend or retract smoothly, adjust screws (T).</p> <p>Remove key when finished and make sure the latch bolt is fully extended.</p>

4 Install the interior assembly

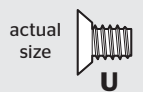

A Remove battery cover and battery pack from interior assembly.

<p>a</p> <p>Make sure turnpiece is in the vertical position.</p>	<p>b</p>
<p>c</p> <p>Make sure turnpiece shaft is rotated as shown.</p>	<p>d</p> <p>Do not install batteries until step 5.</p>

B Install interior assembly onto mounting plate.

<p>a</p> <p>align</p> <p>Ensure tight cable connection.</p>	<p>b</p> <p>Lay excess cable flat inside the bottom of the interior housing.</p>
<p>c</p>	<p>d</p> <p>U (2x) bottom hole</p>

5 Install the batteries and perform the door handing process

This step will teach your lock the orientation of your door and is crucial to lock operation.

A Install 4 AA batteries in battery pack.

Ensure correct polarity. For best results, use new, non-rechargeable Alkaline batteries only.

B Make sure the door is open, and insert the battery pack.

C After a few seconds, the latch bolt will retract and extend on its own to learn the orientation of the door. This is called the **door handing process**, and it is crucial to lock operation.

Status LED will indicate success or failure.

Success: LED flashes green
Failure: LED remains solid red

Note: Latch bolt will only retract half way.

D If the latch bolt does not move on its own, or if the Status LED indicates a door handing failure, make sure the cables are connected, the batteries are installed correctly, and attempt this procedure again. If the door handing process is still unsuccessful after a second attempt, perform the "Manual Door Handing" procedure on page 4.

6 Add the lock to your smart home system

A Initiate the process to add the lock to your system at your smart home controller. Refer to your smart home system instructions for more information.

B When prompted by your smart home system to add the lock, press button "A" on the lock interior one time. The red LED will illuminate when the lock enters Add Mode.

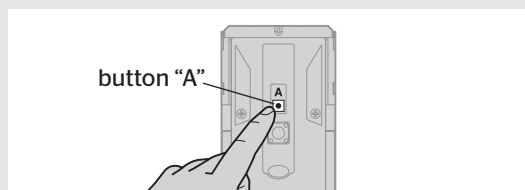

Please allow time for the controller to add the lock.

C If successful, re-name the lock in your system (if applicable).

D If unsuccessful, follow your system's instructions to remove the lock from the controller and any other network, then press button "A" on the lock one time. Perform steps 6A-6C again.

If still unsuccessful, consult the Programming and Troubleshooting Guide on the SmartCode 888 page at kwikset.com.

7 Add user codes (30 max)

It is recommended that you add and delete all user codes through your smart home control system. If your system does not allow this, codes may be added directly to the lock as shown here.

Programming Timeout

During programming, if no button is pressed for five seconds, the system will time out (indicated by three beeps and a red flashing lock button), and you will need to restart the procedure.

A Make sure the door is open. Press the Program button once.

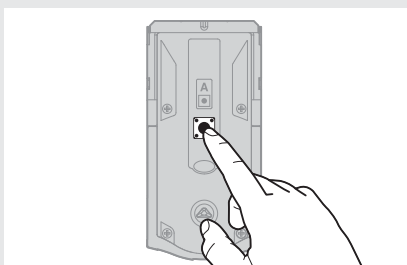

B Enter user code. A total of 30 user codes may be programmed.

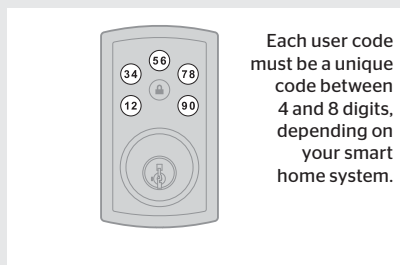

Each user code must be a unique code between 4 and 8 digits, depending on your smart home system.

C Press Lock button once.

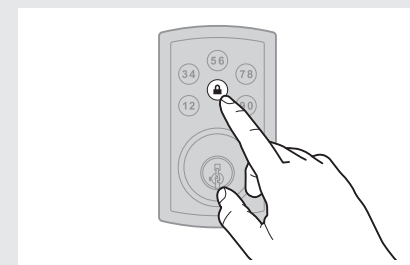

D What lights and sounds does the lock produce?

Mastercode

For enhanced security, a mastercode may be used when adding and deleting user codes. For more information about the mastercode, download the Programming and Troubleshooting Guide on the SmartCode 888 page at kwikset.com.

Lock button flashes green once with one beep

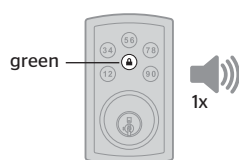

Programming was successful.

or

Lock button flashes three times with three beeps

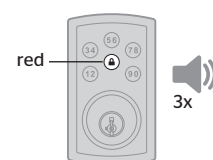

Programming was unsuccessful.

Make sure not to pause for more than 5 seconds during programming. Make sure the user code is not a duplicate and that it is between 4 and 8 digits during your next attempt. Make sure the lock has room for an additional code. If all user code positions are filled, delete a code to make room for this one.

8 Test the lock (review normal operation) and re-key the lock (if needed)

Confirm that the code(s) added in previous step can unlock the door.

Locking the Door

Press Lock button once.

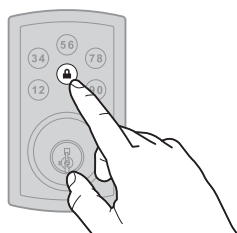

Unlocking the Door

Enter user code.



Re-Key with SmartKey

Re-key the lock to work with your existing key. See the supplied SmartKey Re-key instructions for more information.



9 Install the interior cover

actual size  V

A Install the interior cover.

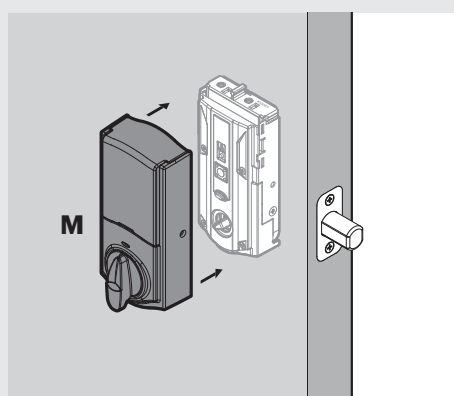

B Secure the interior cover with three (3) screws.

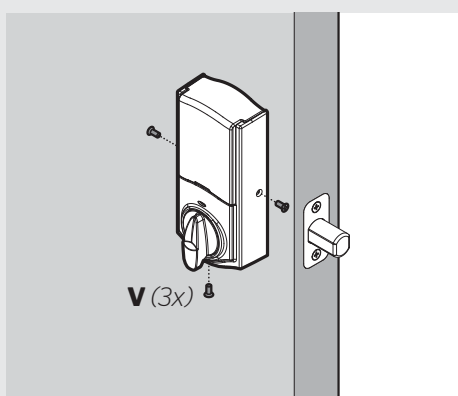

Note: To access the battery pack or back panel, slide up the window on the interior cover.

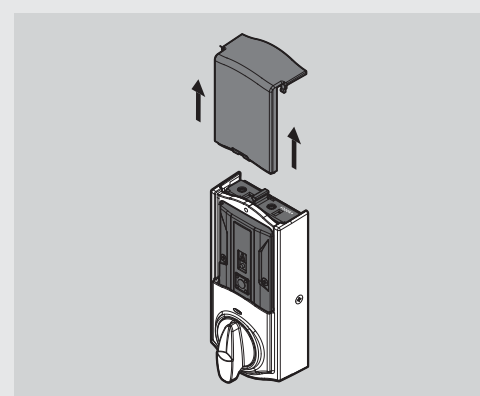

SmartCode 888 at a Glance

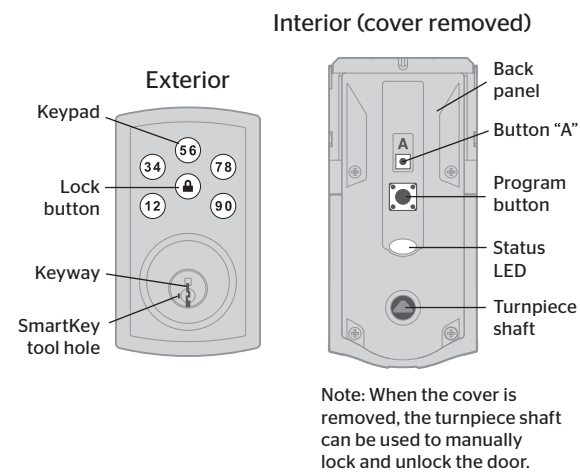

Troubleshooting

A complete Programming and Troubleshooting Guide is available on the SmartCode 888 page at www.kwikset.com.

Status LED

The Status LED blinks every 6 seconds to communicate whether the door is locked or unlocked. This feature is on by default.

- Blinking Green: Unlocked
- Blinking Amber: Locked
- Blinking Red: Low battery
- Solid Red: Unsuccessful door handing process. See online Programming and Troubleshooting Guide.

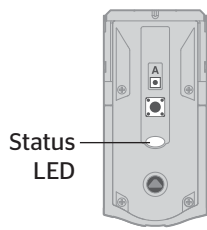

Turn Status LED On/Off

- Press Program button once.
- Press button "A" once.



- Press button "1-2" multiple times if needed to reach desired state.
- Press Lock button once.



Green Lock Button: Feature is enabled.
Red Lock Button: Feature is disabled.

System Alerts

Alert	Reason	Solution
Lock button flashes red once with one beep*.	One incorrect code entered.	Re-enter code.
Lock button flashes red three times with three beeps*.	No user code programmed.	Program at least one user code.
	Programming timeout after five seconds. Unsuccessful programming.	Attempt programming procedure again.
Lock button flashes red 15 times with 15 beeps*.	Three incorrect codes entered within one minute.	Re-enter code after 60 second keypad lockout.
Lock button flashes red with fast beeping sound for three to four seconds.	Low battery.	Replace batteries.
Lock button flashes green with continuous beeping sound for two seconds.	Door jammed while attempting to lock.	Manually re-lock door. If needed, reposition strike.

Deleting a single user code

Note: All codes may be deleted at once if the mastercode is enabled. For more information about the mastercode, consult the Programming and Troubleshooting Guide.

If no button is pressed for five seconds, the system will time out, and you will need to restart the procedure.

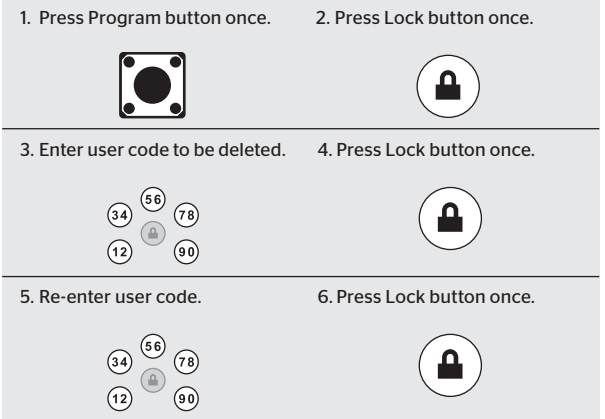

If unsuccessful: Make sure to enter the same valid code in steps 3 and 5.

Test code: While the door is open, test the user code to make sure it no longer unlocks the door.

Auto-Lock

Auto-lock automatically re-locks the door after unlocking. This feature is set to 30 seconds and is turned off by default.

Turn Auto-Lock On/Off

- Press Program button once.
- Press button "A" once.



- Press button "3-4" multiple times if needed to reach desired state.
- Press Lock button once.



Green Lock Button: Feature is enabled.
Red Lock Button: Feature is disabled.

Change Auto-Lock Time Delay

- Press Program button once.
- Press button "A" once.



- Press button "9-0" once.
- Press button once that corresponds to desired time delay:
- Press Lock button once.



"1-2" - 30 sec.
"3-4" - 60 sec.
"5-6" - 90 sec.
"7-8" - 120 sec.
"9-0" - 180 sec.

Mute/Unmute Audio

Audio is on by default.

- Press Program button once.
- Press button "A" once.
- Press button "5-6" multiple times if needed to reach desired state.
- Press Lock button once.



Green Lock Button: Feature is enabled.
Red Lock Button: Feature is disabled.

Manual Door Handing

If needed, the door handing process can be initiated manually. This is useful if the lock is being moved to a different door.

- Remove battery pack.



- Press and HOLD the Program button while reinserting the battery pack. Release button once battery pack is installed. The status LED will flash red and green.

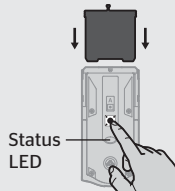

- Press the Program button once more.



- The latch bolt will extend and retract to learn the orientation of the door. The Status LED will indicate success or failure.

Success: LED flashes green
Failure: LED remains solid red
If the Status LED indicates a failure, see the online Programming and Troubleshooting Guide or call Technical Support.

Factory Reset

A factory reset will delete all codes associated with the lock, and it will remove it from your smart home system.

- Remove battery pack.



- Press and HOLD the Program button while reinserting the battery pack. Keep holding the button for 30 seconds until the lock beeps and the status LED flashes red.

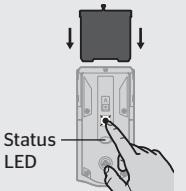

- Press the Program button once more. When the LED flashes green and you hear one beep, the lock has been reset.



- After a few seconds, the lock will initiate the door handing process, and the latch bolt will extend and retract to learn the orientation of the door.

Network Information

Removing the lock from the network

Follow your smart home system's instructions to remove the lock from the network. When prompted by the system, press button "A" on the lock interior once.

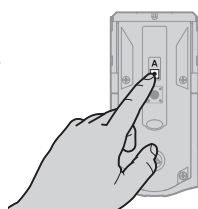

Z-Wave System Notes

This product is a security enabled Z-wave Plus product and must be used with a Security Enabled Z-Wave controller to be fully utilized. Z-Wave is a "Wireless mesh network," and results may vary based on building construction and communication path.

To assure interoperability, each Z-Wave product must pass a stringent conformance test to assure that it meets the Z-Wave standard for complete compliance with all other devices and controls. The Z-Wave identity mark assures consumers, integrators, dealers and manufacturers that their products will reliably perform with any other Z-Wave device. And, regardless of the vendor, always powered nodes may act as a repeater for Kwikset/Weiser/Baldwin products.

Z-Wave Configuration and Association Parameters are available on the SmartCode 888 page at www.kwikset.com.

Important Safeguards

- Read all instructions in their entirety.
- Familiarize yourself with all warning and caution statements.
- Remind all family members of safety precautions.
- Protect your user codes and mastercode.
- Dispose of used batteries according to local laws and regulations.

CAUTION: Prevent unauthorized entry. Since anyone with access to the back panel can change the user codes, you must restrict access to the back panel and routinely check the user codes to ensure they have not been altered without your knowledge. The use of a mastercode can help protect your system's settings.

WARNING: This Manufacturer advises that no lock can provide complete security by itself. This lock may be defeated by forcible or technical means, or evaded by entry elsewhere on the property. No lock can substitute for caution, awareness of your environment, and common sense. Builder's hardware is available in multiple performance grades to suit the application. In order to enhance security and reduce risk, you should consult a qualified locksmith or other security professional.