

FCC Test Report

Product Name	V2X DSRC Module
Model No	VTX-301
FCC ID	NUK-VTX3012

Applicant	Unex Technology Corporation
Address	7F-2, No. 100, Sec. 1, Jiafeng 11th Rd., Zhubei City, Hsinchu County 30273, Taiwan, R.O.C.

Date of Receipt	Feb. 05, 2020
Issued Date	Apr. 09, 2020
Report No.	2020046R-RFUSP77V00
Report Version	V1.0



The test results relate only to the samples tested.

The test results shown in the test report are traceable to the national/international standard through the calibration report of the equipment and evaluated measurement uncertainty herein.

This report must not be used to claim product endorsement by TAF or any agency of the government.

The test report shall not be reproduced without the written approval of DEKRA Testing and Certification Co., Ltd.

Test Report

Issued Date: Apr. 09, 2020

Report No.: 2020046R-RFUSP77V00



Product Name	V2X DSRC Module
Applicant	Unex Technology Corporation
Address	7F-2, No. 100, Sec. 1, Jiafeng 11th Rd., Zhubei City, Hsinchu County 30273, Taiwan, R.O.C.
Manufacturer	Unex Technology Corporation
Model No.	VTX-301
FCC ID.	NUK-VTX3012
EUT Rated Voltage	DC 5V
EUT Test Voltage	DC 5V by Test Fixture
Trade Name	Unex
Applicable Standard	47 CFR Part 95 Subpart L TIA/EIA-603-E-2016 TIA-102.CAAA-E-2016 ANSI C63.26-2015
Test Result	Complied

Documented By : Jinn Chen
(Senior Adm. Specialist / Jinn Chen)

Tested By : Ivan Chuang
(Senior Engineer / Ivan Chuang)

Approved By : Vincent Lin
(Director / Vincent Lin)

TABLE OF CONTENTS

Description	Page
1. GENERAL INFORMATION	5
1.1. EUT Description.....	5
1.2. Operational Description	7
1.3. Tested System Details.....	8
1.4. Configuration of tested System	8
1.5. EUT Exercise Software	8
1.6. Test Facility	9
1.7. List of Test Equipment	10
1.8. Uncertainty	11
1.9. Overview of results	12
2. Transmitter output power	13
2.1. Test Setup	13
2.2. Limits	13
2.3. Test Procedure	15
2.4. Uncertainty	15
2.5. Test Result of Transmitter output power	16
3. Occupied Bandwidth.....	18
3.1. Test Setup	18
3.2. Limits	18
3.3. Test Procedure	18
3.4. Uncertainty	18
3.5. Test Result of Occupied Bandwidth	19
4. Transmit Spectrum Mask	22
4.1. Test Setup	22
4.2. Limits	22
4.3. Test Procedure	23
4.4. Uncertainty	23
4.5. Test Result of Transmit Spectrum Mask	24
5. Spurious Emissions at Antenna Terminals	28
5.1. Test Setup	28
5.2. Limits	28
5.3. Test Procedure	28
5.4. Uncertainty	28
5.5. Test Result of Spurious Emissions at Antenna Terminals	29
6. Radiated Spurious Emission.....	35
6.1. Test Setup	35
6.2. Limits	36
6.3. Test Procedure	36
6.4. Uncertainty	36
6.5. Test Result of Radiated Emission.....	37
7. Frequency Stability.....	53
7.1. Test Setup	53
7.2. Limits	53

7.3.	Test Procedure	53
7.4.	Uncertainty	53
7.5.	Test Result of Frequency Stability.....	54
8.	EMI Reduction Method During Compliance Testing	56
Attachment 1:	EUT Test Photographs	
Attachment 2:	EUT Detailed Photographs	

1. GENERAL INFORMATION

1.1. EUT Description

Product Name	V2X DSRC Module
Trade Name	Unex
FCC ID.	NUK-VTX3012
Model No.	VTX-301
Frequency Range	5860-5920MHz
Number of Channels	10MHz Bandwidth:7CH
Data Rate	Up to 27Mbps
Type of Modulation	OFDM
Channel Control	Auto
Antenna type	OMNI Antenna
Antenna Gain	Refer to the table "Antenna List"
OBU class	<input type="checkbox"/> A / <input type="checkbox"/> B / <input checked="" type="checkbox"/> C / <input type="checkbox"/> D

Antenna List

No.	Manufacturer	Part No.	Antenna Type	Peak Gain with Antenna cable loss
1	Unex Technology Corporation	EX-32	OMNI Antenna	5.5dBi

Note: Antenna cable loss is 2.1dBi

Center Working Frequency of Each Channel: (10MHz Bandwidth)

Channel	Frequency	Channel	Frequency	Channel	Frequency	Channel	Frequency
Channel 172:	5860MHz	Channel 174:	5870MHz	Channel 176:	5880MHz	Channel 178:	5890MHz
Channel 180:	5900MHz	Channel 182:	5910MHz	Channel 184:	5920MHz		

Note:

1. This device is a V2X DSRC Module with a built-in 5GHz wireless transceiver.
2. Regarding to the operation frequency, the lowest, middle and highest frequency are selected to perform the test. Lowest and highest data rates are tested in each mode. Only worst case is shown in the report.
3. These tests were conducted on a sample of the equipment for the purpose of demonstrating compliance of transmitter with Part 95 Subpart L

Test Mode	Mode 1: Transmit (10MHz Bandwidth)
-----------	------------------------------------

1.3. Tested System Details

The types for all equipment, plus descriptions of all cables used in the tested system (including inserted cards) are:

Product	Manufacturer	Model No.	Serial No.	Power Cord
1 Notebook PC	DELL	P62G	CY9FJC2	N/A
2 Test Fixture	Unex	N/A	N/A	N/A

Signal Cable Type	Signal cable Description
A USB Cable	Non-shielded, 0.8m
B USB Cable	Shielded, 0.9m
C Antenna Cable	Non-shielded, 0.2m, two PCS.
D Antenna Cable	Non-shielded, 0.2m, two PCS.

1.4. Configuration of tested System

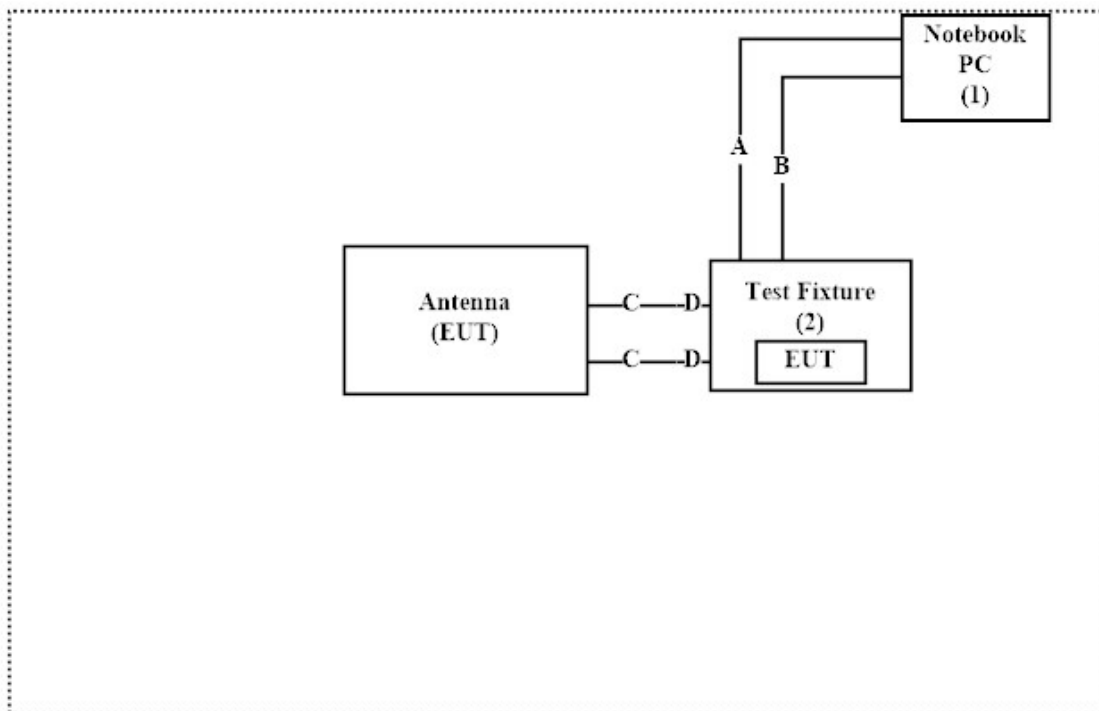

1.5. EUT Exercise Software

- (1) Setup the EUT as shown in Section 1.4.
- (2) Execute software "PuTTY V0.63" on the Notebook PC.
- (3) Configure the test mode, the test channel, and the data rate.
- (4) Press "OK" to start the continuous Transmit.
- (5) Verify that the EUT works properly.

1.6. Test Facility

Ambient conditions in the laboratory:

Performed Item	Items	Required	Actual
Radiated Emission	Temperature (°C)	10~40 °C	22.8°C
	Humidity (%RH)	10~90 %	61.2%
Conductive	Temperature (°C)	10~40 °C	22.3°C
	Humidity (%RH)	10~90 %	65.2%

USA : FCC Registration Number: TW0023

Canada : IC Registration Number: 4075A

Site Description : Accredited by TAF
Accredited Number: 3023

Test Laboratory : DEKRA Testing and Certification Co., Ltd
Address : No.159, Sec. 2, Wenhua 1st Rd., Linkou Dist.,
New Taipei City 24457, Taiwan, R.O.C.

Phone number : 886-2-2602-7968
Fax number : 866-2-2602-3286
Email address : info.tw@dekra.com
Website : <http://www.dekra.com.tw>

1.7. List of Test Equipment

For Conducted measurements /ASR3

	Equipment	Manufacturer	Model No.	Serial No.	Cali. Data	Due. Data
X	Temperature Chamber	KSON	THS-D4T-100	A0606	2019.04.29	2020.04.28
X	Spectrum Analyzer	R&S	FSV40	101149	2019.12.16	2020.12.15
X	Peak Power Analyzer	KEYSIGHT	8900B	MY51000539	2019.05.06	2020.05.05
X	Power Sensor	KEYSIGHT	N1923A	MY59240002	2019.06.12	2020.06.11
X	Power Sensor	KEYSIGHT	N1923A	MY59240003	2019.06.13	2020.06.12
X	DC Power Supply	GW Instek	SPD-3606	GEQ820915	2019.06.20	2020.06.19

Note:

1. All equipments are calibrated every one year.
2. The test instruments marked with "X" are used to measure the final test results.
3. Test Software version : DEKRA Conduction Test System V9.0.5

For Radiated measurements /ACB1

	Equipment	Manufacturer	Model No.	Serial No.	Cali. Data	Due. Data
X	Loop Antenna	AMETEK	HLA6121	49611	2020.03.16	2021.03.15
X	Bi-Log Antenna	SCHWARZBECK	VULB9168	9168-675	2019.07.01	2020.06.30
X	Horn Antenna	ETS-Lindgren	3117	00203761	2019.10.31	2020.10.30
X	Horn Antenna	Com-Power	AH-840	101087	2019.05.30	2020.05.29
X	Pre-Amplifier	EMCI	EMC001330	980301	2019.05.20	2020.05.19
X	Pre-Amplifier	EMCI	EMC051835SE	980312	2019.06.03	2020.06.02
X	Pre-Amplifier	EMCI	EMC05820SE	980308	2019.09.02	2020.09.01
X	Pre-Amplifier	EMCI	EMC184045SE	980314	2019.05.28	2020.05.27
	Filter	MICRO TRONICS	BRM50702	G251	2019.09.03	2020.09.02
X	Filter	MICRO TRONICS	BRM50716	G188	2019.09.03	2020.09.02
X	EMI Test Receiver	R&S	ESR7	101602	2019.12.16	2020.12.15
X	Spectrum Analyzer	R&S	FSV40	101148	2020.03.16	2021.03.15
X	Coaxial Cable	SUHNER	SUCOFLEX 106	RF002	2019.07.03	2020.07.02
X	Mircoflex Cable	HUBER SUHNER	SUCOFLEX 102	MY3381/2	2019.05.28	2020.05.27

Note:

1. All equipments are calibrated every one year.
2. The test instruments marked with "X" are used to measure the final test results.
3. Test Software version : DEKRA Testing System V1.1

1.8. Uncertainty

Uncertainties have been calculated according to the DEKRA internal document, and is described in each test chapter of this report.

The reported expanded uncertainties are based on a standard uncertainty multiplied by a coverage factor of $k=2$, providing a level of confidence of approximately 95%.

Measurement uncertainties evaluated for each testing system and associated connections are given here to provide the system information for reference. Compliance determinations do not take into account measurement uncertainties for each testing system, but are based on the results of the compliance measurement.

1.9. Overview of results

Requirement – Test item	Basic standard(s)	Result	Remark
Transmitter output power	FCC §2.1046; FCC §90.377 ASTM E2213-03 §8.9.1	PASS	---
Occupied Bandwidth	FCC §2.1049; ASTM E2213-03 §8.9.2	PASS	---
Transmit Spectrum Mask	ASTM E2213-03 §8.9.2	PASS	---
Spurious Emissions at Antenna Terminals	FCC §2.1051; ASTM E2213-03 §8.9.2	PASS	---
Radiated Spurious Emission	FCC §2.1053; ASTM E2213-03 §8.9.2	PASS	---
Frequency Stability	FCC §2.1055; ASTM E2213-03 §8.9.5	PASS	--

2. Transmitter output power

2.1. Test Setup

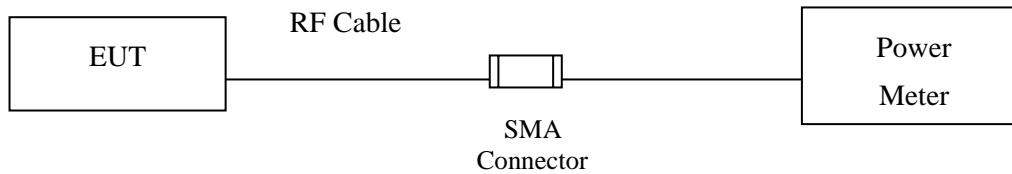

2.2. Limits

OBU class	Max. output power (dBm)	Communications zone (meters)
A	0	15
B	10	100
C	20	400
D	28.8	1000

Channel No.	Frequency range (MHz)	Max. EIRP (dBm)	Channel use
170	5850-5855	--	Reserved.
172	5855-5865	33	Service Channel
174	5865-5875	33	Service Channel
175	5865-5885	23	Service Channel
176	5875-5885	33	Service Channel
178	5885-5895	33/44.8	Service Channel
180	5895-5905	23	Service Channel
181	5895-5915	23	Service Channel
182	5905-5915	23	Service Channel
184	5915-5925	33/40	Service Channel

Private

Channel	Freq.	OBU class C	
		Max. output power (dBm)	EIRP (dBm)
172	5860	20(Note 1)	33
174	5870	20(Note 1)	33
175	5875	10	23
176	5880	20(Note 1)	33
178	5890	20(Note 1)	33
180	5900	20	23
181	5905	20	23
182	5910	20	23
184	5920	20(Note 1)	33

Public Safety

Channel	Freq.	OBU class C	
		Max. output power (dBm)	EIRP (dBm)
172	5860	20(Note 1)	33
174	5870	20(Note 1)	33
175	5875	10	23
176	5880	20(Note 1)	33
178	5890	20(Note 1)	44.8
180	5900	10	23
181	5905	10	23
182	5910	10	23
184	5920	20(Note 1)	40

Note:

1. According to Max. output power of OBU class table.
2. The maximum output power for portable On-Board Unit transmitter types is 1.0 mW. For a portable is a transmitting device designed to be used so that the radiating structure(s) of the device is/are within 20 centimeters of the body of the user.

2.3. Test Procedure

According to test procedure of ANSI C63.26-2015 and for compliance to FCC 47CFR Part 95 Subpart L requirements. The Transmitter output power using ANSI C63.26-2015 section 5.2.4.2 General procedure for measuring average power with an average power meter.

2.4. Uncertainty

$\pm 0.95\text{dB}$

2.5. Test Result of Transmitter output power

Product : V2X DSRC Module
 Test Item : Transmitter output power
 Test Mode : Mode 1: Transmit (10MHz Bandwidth)
 Test Date : 2020/03/19

Chain 0

Channel No	Frequency (MHz)	Maximum Conducted Power Output (dBm)							
		Data Rate (Mbps)							
		3	4.5	6	9	12	18	24	27
172	5860	19.74	--	--	--	--	--	--	19.98
174	5870	19.97	--	--	--	--	--	--	19.97
176	5880	19.98	--	--	--	--	--	--	19.96
178	5890	19.96	19.89	19.95	19.95	19.81	19.89	19.88	19.96
180	5900	9.98	--	--	--	--	--	--	9.95
182	5910	9.97	--	--	--	--	--	--	9.93
184	5920	19.88	--	--	--	--	--	--	19.89

Channel No	Frequency Range	Output Power	Output Power Limit	Result
	(MHz)	(dBm)	(dBm)	
172	5860	19.98	20	Pass
174	5870	19.97	20	Pass
176	5880	19.98	20	Pass
178	5890	19.96	20	Pass
180	5900	9.98	10	Pass
182	5910	9.97	10	Pass
184	5920	19.89	20	Pass

Channel No	Frequency Range	Output Power	Antenna gain	EIRP	EIRP Limit	Result
	(MHz)	(dBm)	(dBi)	(dBm)	(dBm)	
172	5860	19.98	5.5	25.48	33	Pass
174	5870	19.97	5.5	25.47	33	Pass
176	5880	19.98	5.5	25.48	33	Pass
178	5890	19.96	5.5	25.46	33	Pass
180	5900	9.98	5.5	15.48	23	Pass
182	5910	9.97	5.5	15.47	23	Pass
184	5920	19.89	5.5	25.39	33	Pass

Chain 1

Channel No	Frequency (MHz)	Maximum Conducted Power Output (dBm)							
		Data Rate (Mbps)							
		3	4.5	6	9	12	18	24	27
172	5860	19.72	--	--	--	--	--	--	19.87
174	5870	19.95	--	--	--	--	--	--	19.93
176	5880	19.97	--	--	--	--	--	--	19.93
178	5890	19.95	19.85	19.88	19.89	19.81	19.79	19.87	19.94
180	5900	9.96	--	--	--	--	--	--	9.87
182	5910	9.87	--	--	--	--	--	--	9.89
184	5920	19.81	--	--	--	--	--	--	19.79

Channel No	Frequency Range	Output Power	Output Power Limit	Result
	(MHz)	(dBm)	(dBm)	
172	5860	19.87	20	Pass
174	5870	19.95	20	Pass
176	5880	19.97	20	Pass
178	5890	19.95	20	Pass
180	5900	9.96	10	Pass
182	5910	9.89	10	Pass
184	5920	19.81	20	Pass

Channel No	Frequency Range	Output Power	Antenna gain	EIRP	EIRP Limit	Result
	(MHz)	(dBm)	(dBi)	(dBm)	(dBm)	
172	5860	19.87	5.5	25.37	33	Pass
174	5870	19.95	5.5	25.45	33	Pass
176	5880	19.97	5.5	25.47	33	Pass
178	5890	19.95	5.5	25.45	33	Pass
180	5900	9.96	5.5	15.46	23	Pass
182	5910	9.89	5.5	15.39	23	Pass
184	5920	19.81	5.5	25.31	33	Pass

3. Occupied Bandwidth

3.1. Test Setup

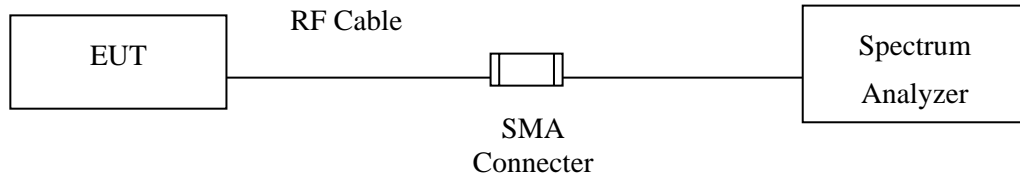

3.2. Limits

No Required

3.3. Test Procedure

The procedures of ANSI C63.26 - 2015 Section 5.4.3 and 5.4.4 were used.

3.4. Uncertainty

$\pm 671.83\text{Hz}$

3.5. Test Result of Occupied Bandwidth

Product : V2X DSRC Module
 Test Item : Occupied Bandwidth
 Test Mode : Mode 1: Transmit (10MHz Bandwidth)
 Test Date : 2020/03/19

Chain 0

Channel No	Frequency (MHz)	Data Rate 3 Mbps		Data Rate 27 Mbps	
		99 %	26 dB	99 %	26 dB
		(MHz)	(MHz)	(MHz)	(MHz)
172	5860	8.19	9.23	8.21	9.09
178	5890	8.21	9.23	8.21	9.15
184	5920	8.21	9.17	8.23	9.11

Data Rate 3 Mbps
Test Frequency: 5860MHz

99% Occupied Bandwidth

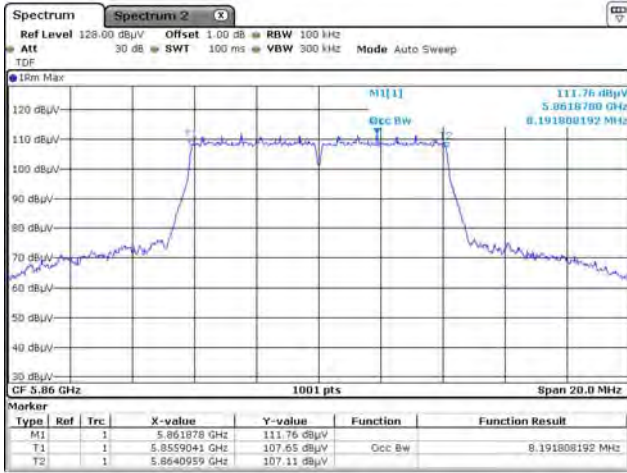

Date: 19 MAR 2020 13:19:37

26dB Occupied Bandwidth

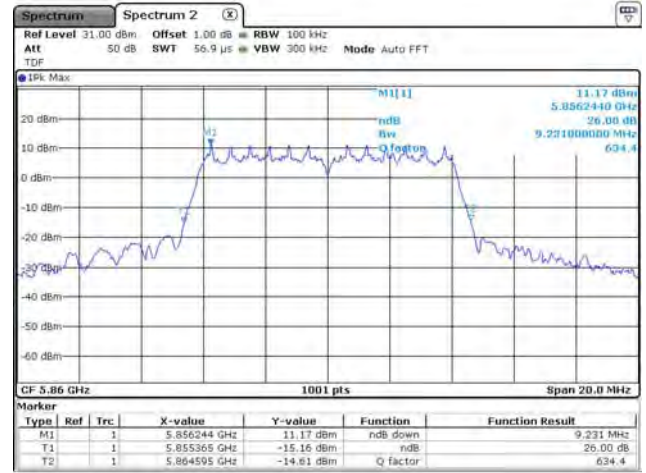

Date: 19 MAR 2020 13:20:12

Test Frequency: 5890MHz

99% Occupied Bandwidth

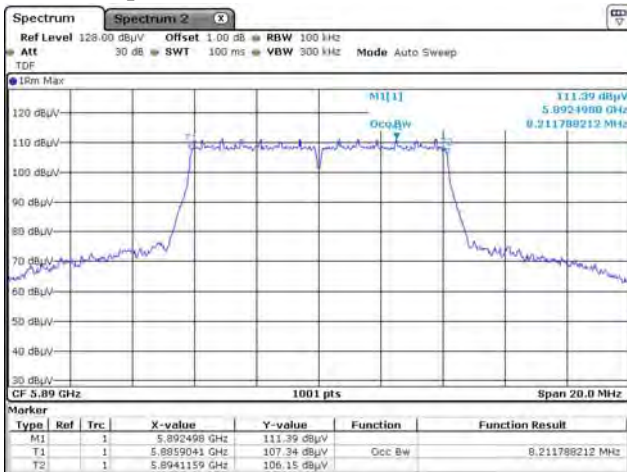

Date: 19 MAR 2020 13:15:36

26dB Occupied Bandwidth

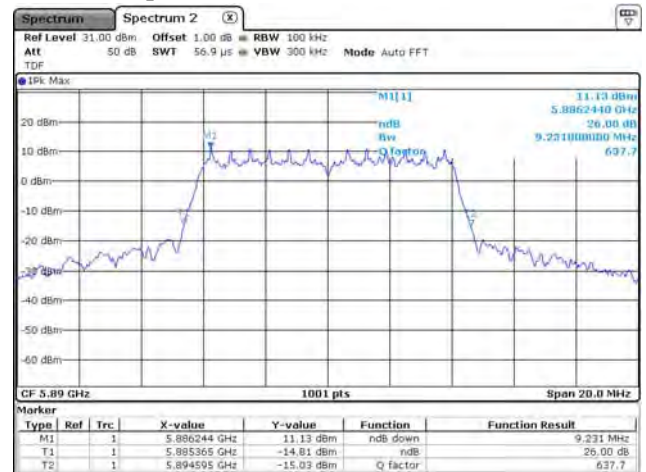

Date: 19 MAR 2020 13:16:07

Test Frequency: 5920MHz

99% Occupied Bandwidth

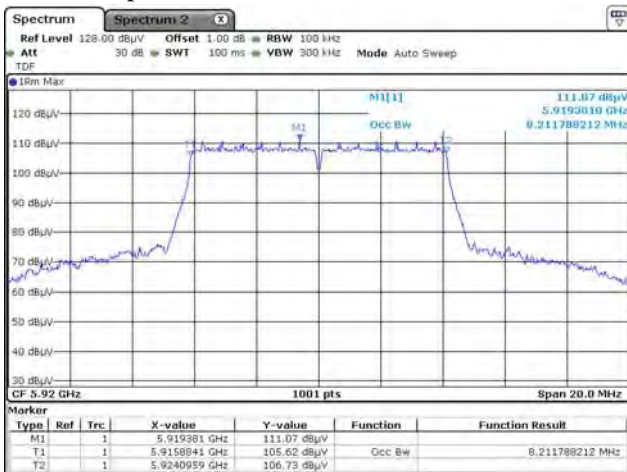

Date: 19 MAR 2020 13:18:52

26dB Occupied Bandwidth

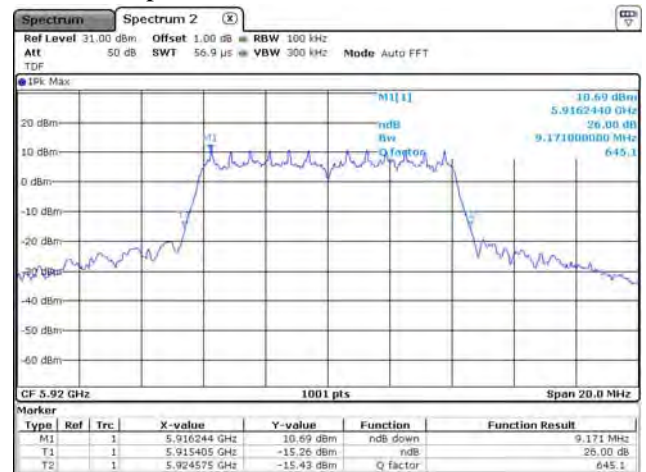

Date: 19 MAR 2020 13:18:34

Data Rate 27 Mbps
Test Frequency: 5860MHz
 99% Occupied Bandwidth

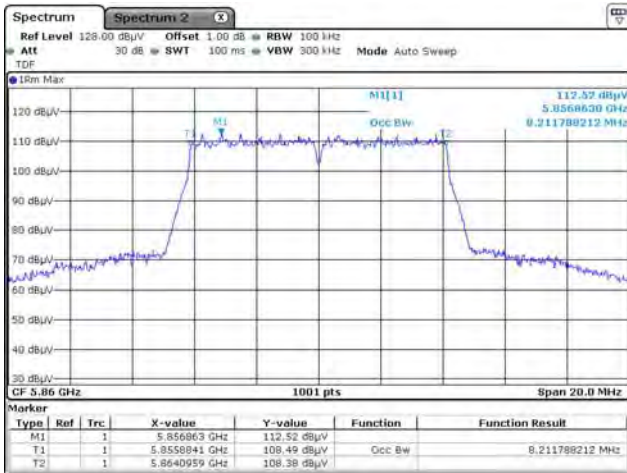

Date: 19 MAR 2020 13:30:29

26dB Occupied Bandwidth

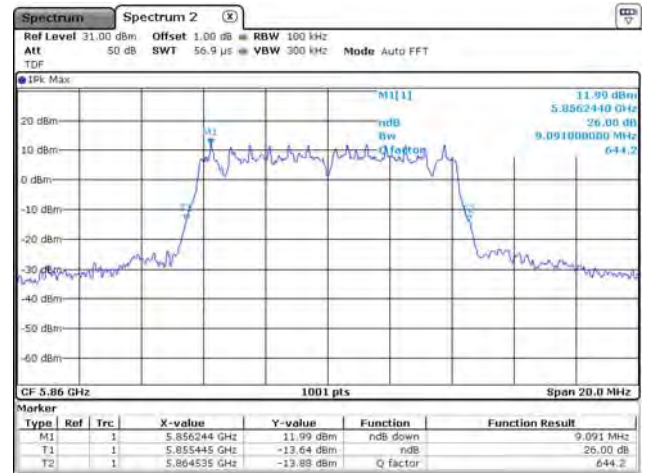

Date: 19 MAR 2020 13:30:49

Test Frequency: 5890MHz
 99% Occupied Bandwidth

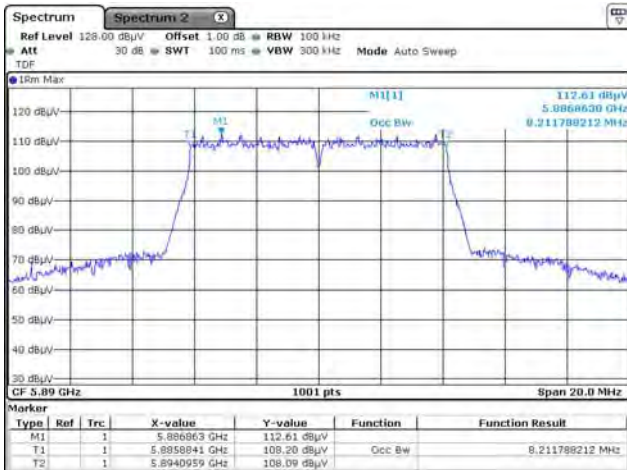

Date: 19 MAR 2020 13:31:29

26dB Occupied Bandwidth

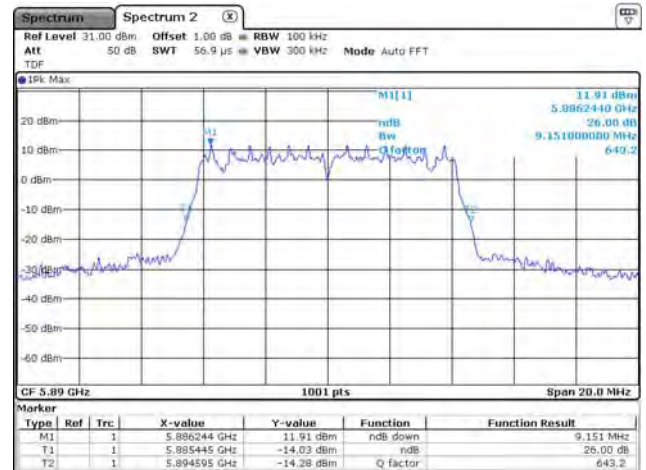

Date: 19 MAR 2020 13:31:54

Test Frequency: 5920MHz
 99% Occupied Bandwidth

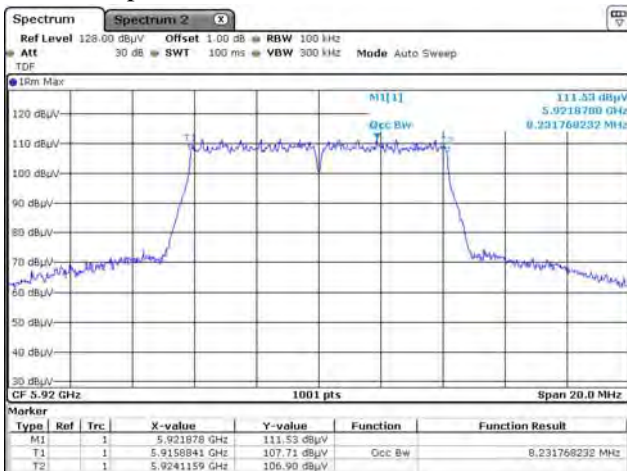

Date: 19 MAR 2020 13:25:31

26dB Occupied Bandwidth

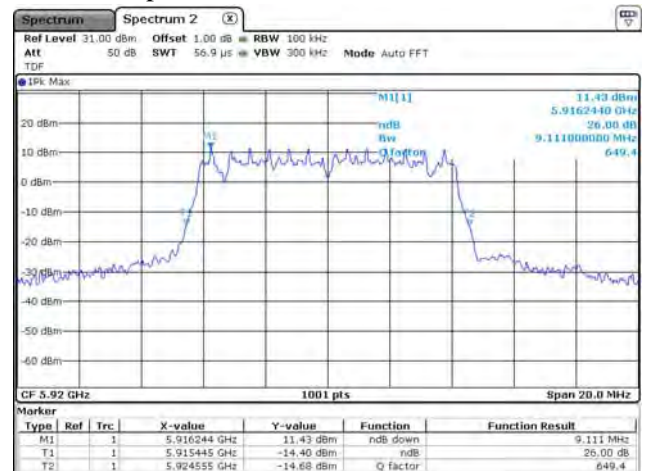

Date: 19 MAR 2020 13:26:04

4. Transmit Spectrum Mask

4.1. Test Setup

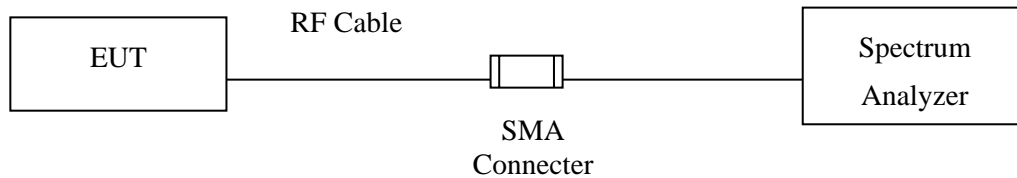

4.2. Limits

OBU class	Max. output power (dBm)	Communications zone (meters)
A	0	15
B	10	100
C	20	400
D	28.8	1000

DSRC Spectrum Mask

Class	± 4.5 MHz Offset	± 5.0 MHz Offset	± 5.5 MHz Offset	± 10 MHz Offset	± 15 MHz Offset
A	0	-10	-20	-28	-40
B	0	-16	-20	-28	-40
C	0	-26	-32	-40	-50
D	0	-35	-45	-55	-65

Note: Reduction in Power Spectral Density, dB

4.3. Test Procedure

The DSRC transmitted spectrum mask is relative to the device class of operation. The power in the transmitted spectrum for all DSRC devices shall be -25 dBm or less within 100 kHz outside all channel and band edges. This will be accomplished by attenuating the transmitted signal 100 kHz outside the channel and band edges by $55 + 10\log(P)$ dB, where P is the total transmitted power in watts. The transmitted spectral density of the transmitted signal for all devices shall fall within the spectral mask. The measurements shall be made using a 100 kHz resolution bandwidth and a 30 kHz video bandwidth.

4.4. Uncertainty

± 1.30 dB

4.5. Test Result of Transmit Spectrum Mask

Product : V2X DSRC Module
 Test Item : Transmit Spectrum Mask
 Test Mode : Mode 1: Transmit (10MHz Bandwidth)
 Test Date : 2020/03/13

Chain 0

Data Rate 3 Mbps

Test Frequency: 5860MHz

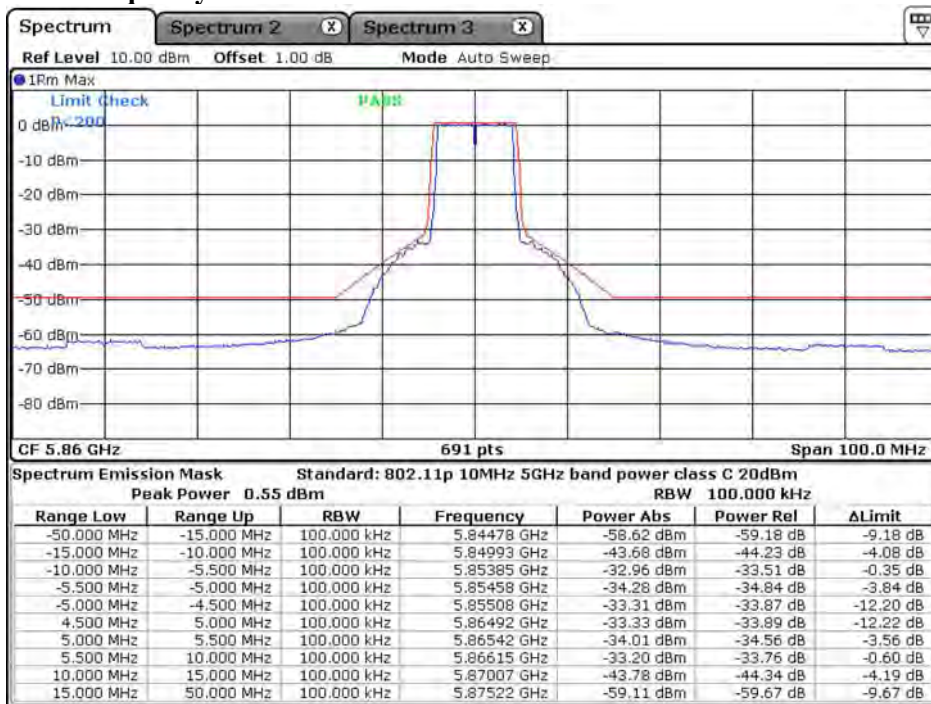

Date: 13.MAR.2020 14:23:47

Test Frequency: 5890MHz

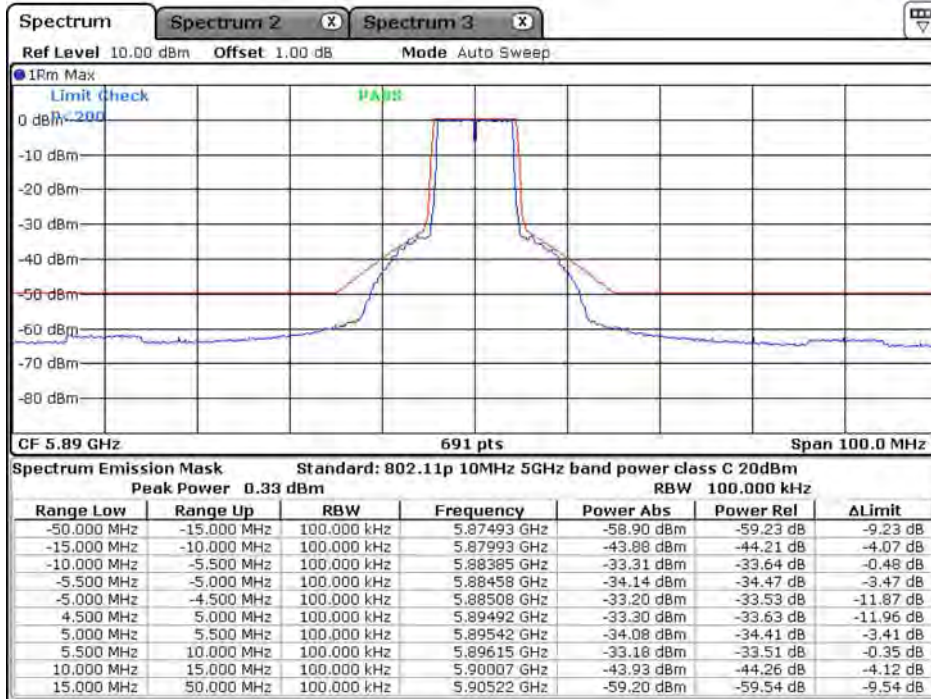

Date: 13.MAR.2020 14:28:43

Test Frequency: 5920MHz

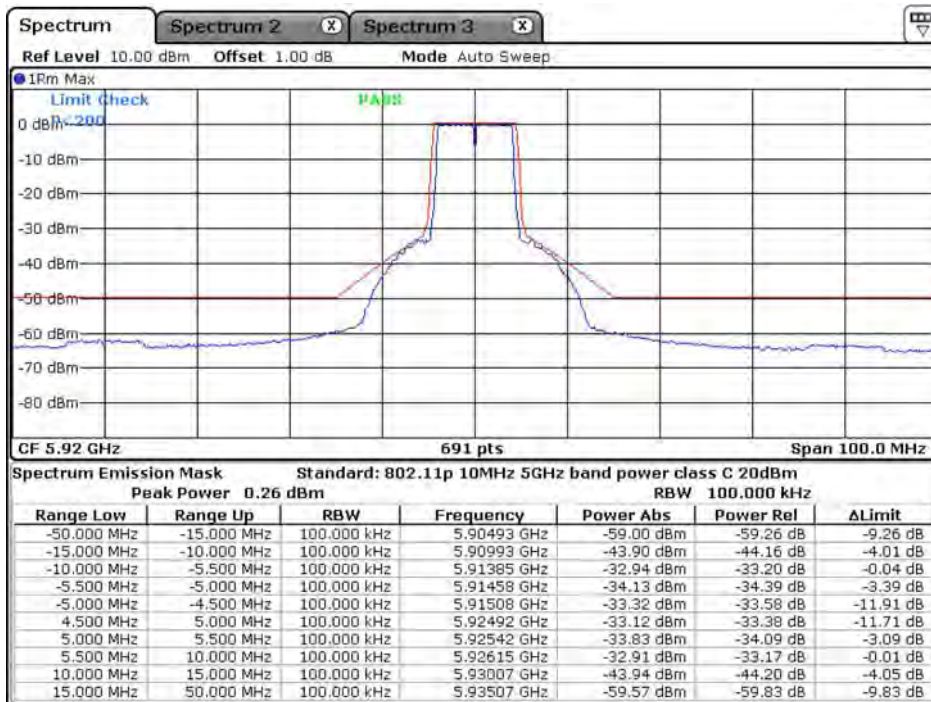

Date: 13.MAR.2020 14:34:00

Chain 0
Data Rate 27 Mbps
Test Frequency: 5860MHz

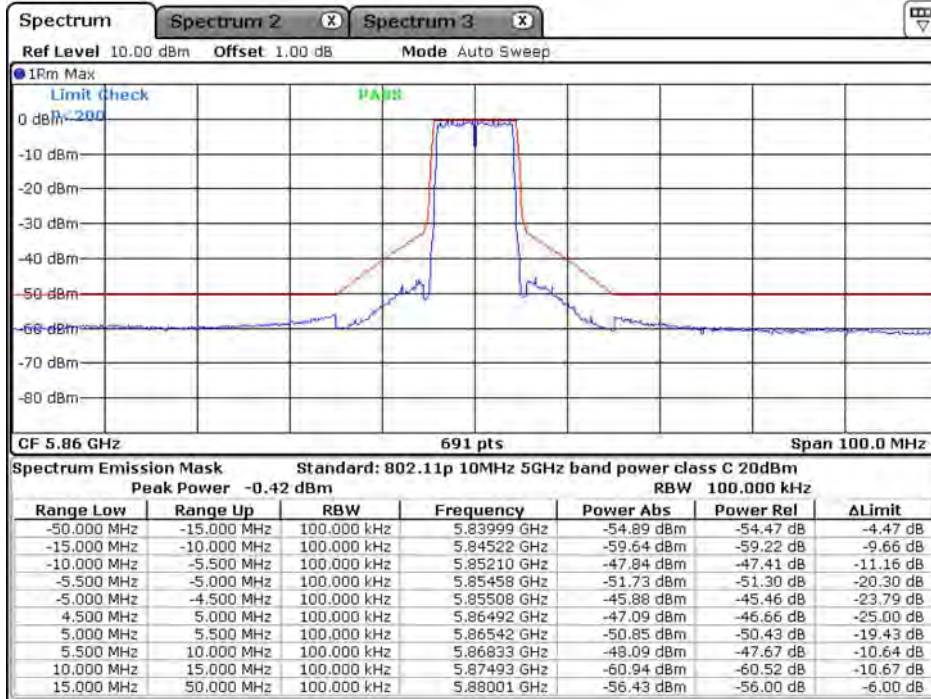

Date: 13.MAR.2020 14:53:34

Test Frequency: 5890MHz

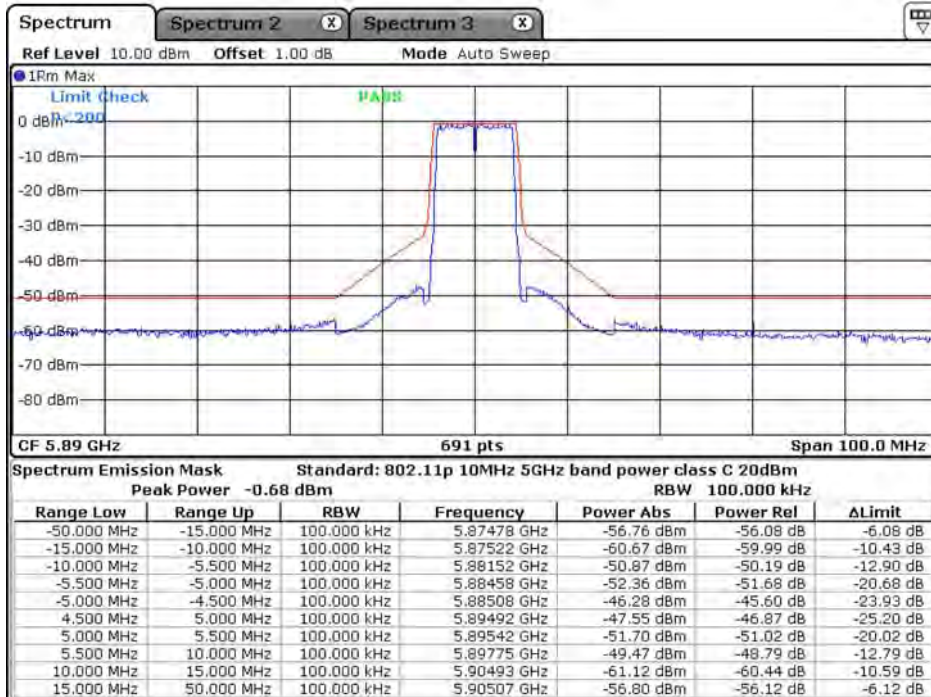

Date: 13.MAR.2020 14:57:52

Test Frequency: 5920MHz

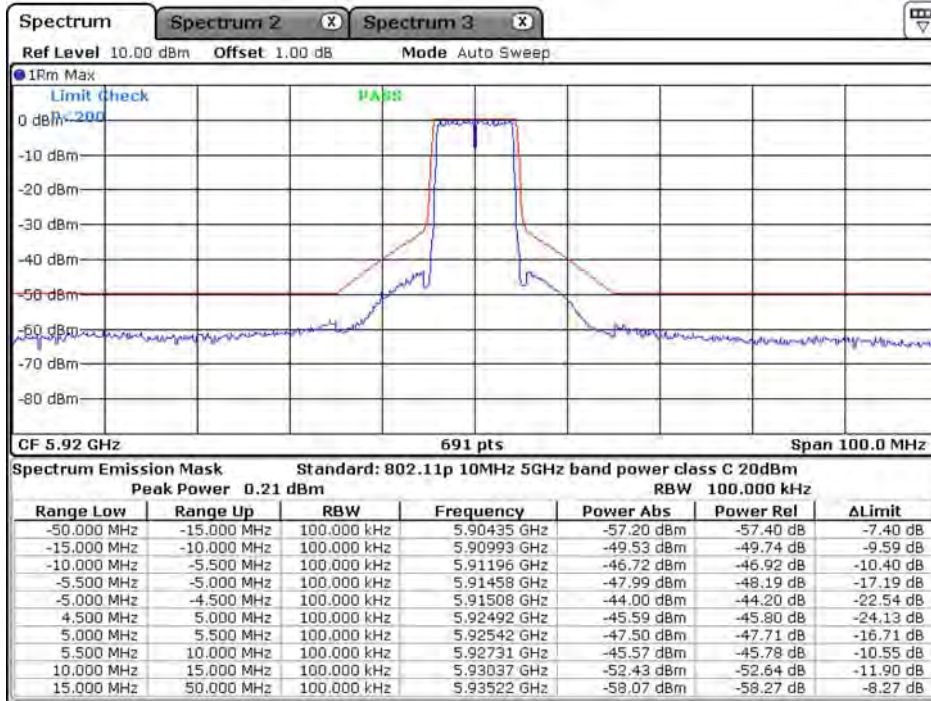

Date: 13. MAR 2020 15:01:23

5. Spurious Emissions at Antenna Terminals

5.1. Test Setup

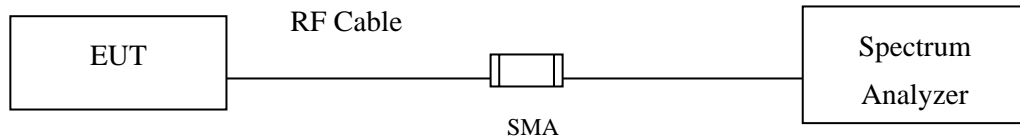

5.2. Limits

The power of any emission outside a license frequency band(s) of operation shall be attenuated below the transmitter power (P) within the licensed band(s) of operation, measured in watts, by at least $55 + 10 \log (P)$ dB (-25dBm).

5.3. Test Procedure

As required by 47 CFR 2.1051, spurious emissions at antenna terminal measurements were made at the RF output terminals using a Spectrum Analyzer.

The EUT was connected to a Spectrum Analyzer. The Spectrum Analyzer was set to sweep 30 MHz and up to 10th harmonic of the fundamental or 40GHz whichever is the lesser. Measurements were made at the low, mid and high channels.

The Conducted Spurious Emissions Limit is obtained by the following plots. Note: only noise floor was measurable above 26GHz.

5.4. Uncertainty

± 1.30 dB

5.5. Test Result of Spurious Emissions at Antenna Terminals

Product : V2X DSRC Module
Test Item : Spurious Emissions at Antenna Terminals
Test Mode : Mode 1: Transmit (10MHz Bandwidth)
Test Date : 2020/04/08

Chain 0

Data Rate 3 Mbps

Test Frequency: 5860MHz

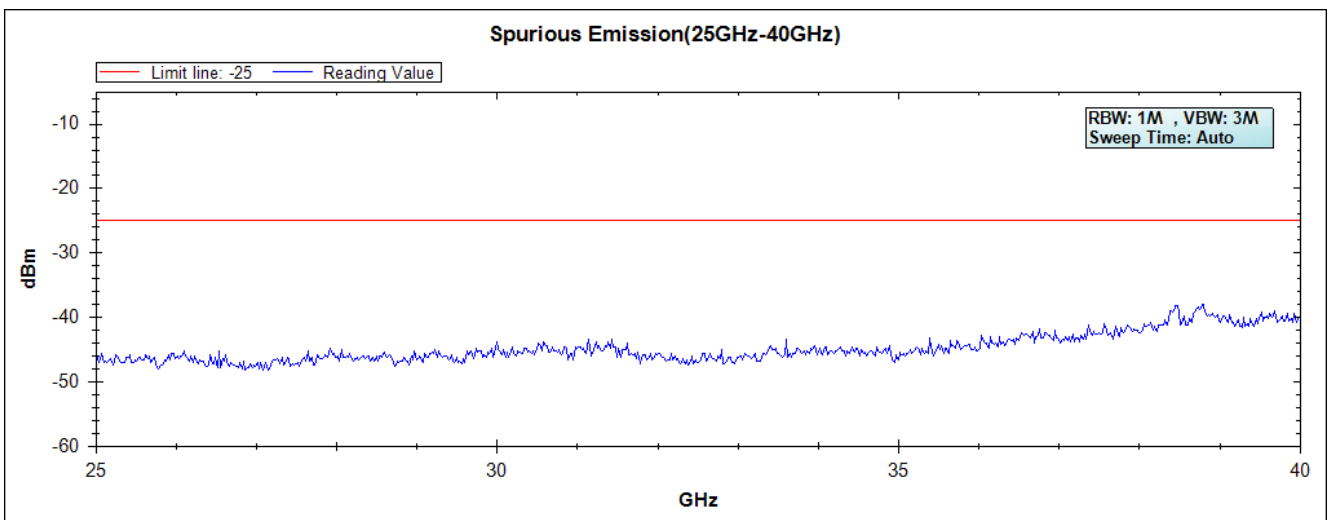
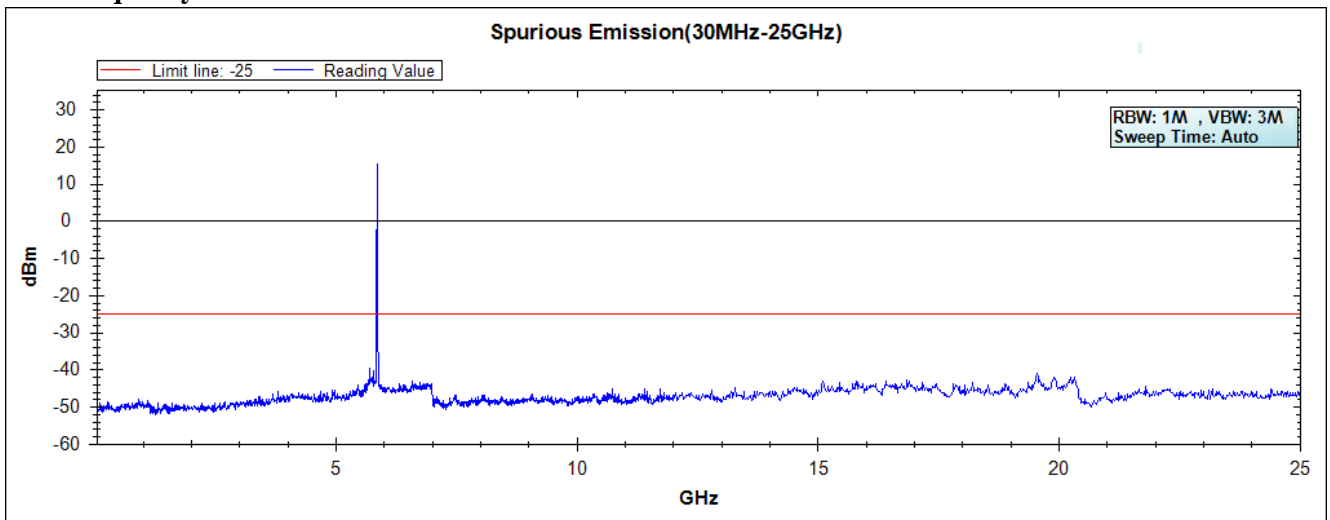

Note: The above test pattern is synthesized by multiple of the frequency range.

Test Frequency: 5890MHz

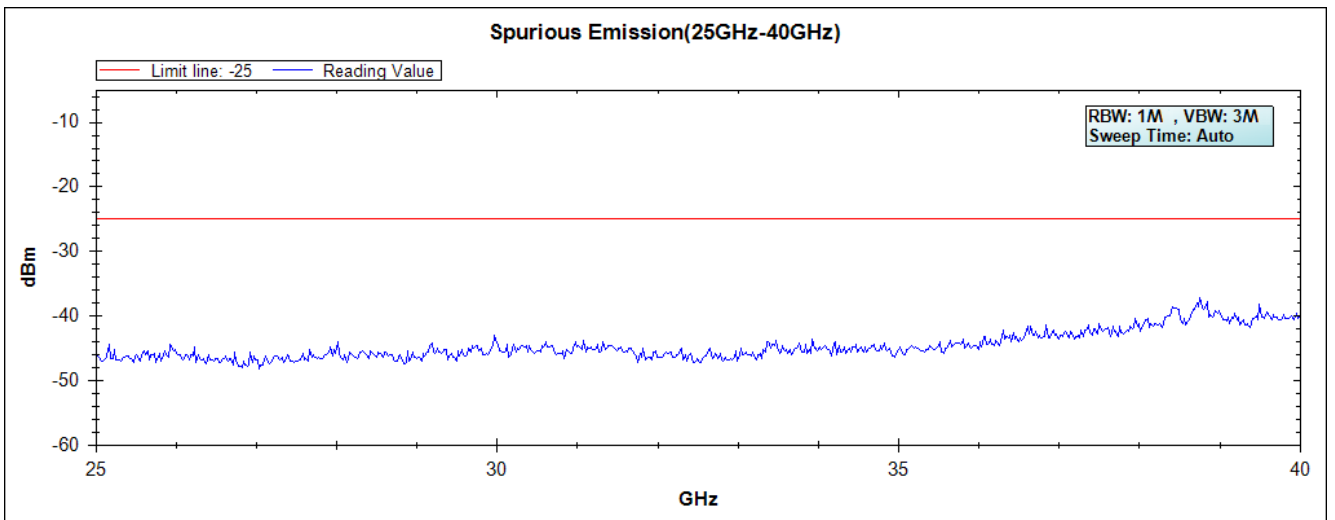
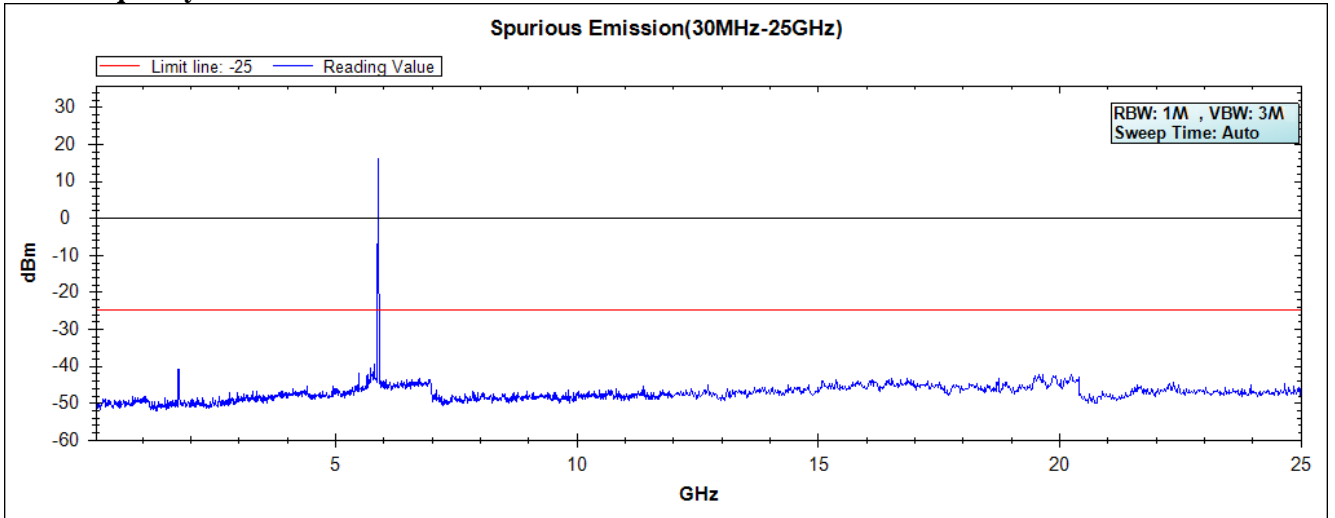

Note: The above test pattern is synthesized by multiple of the frequency range.

Test Frequency: 5920MHz

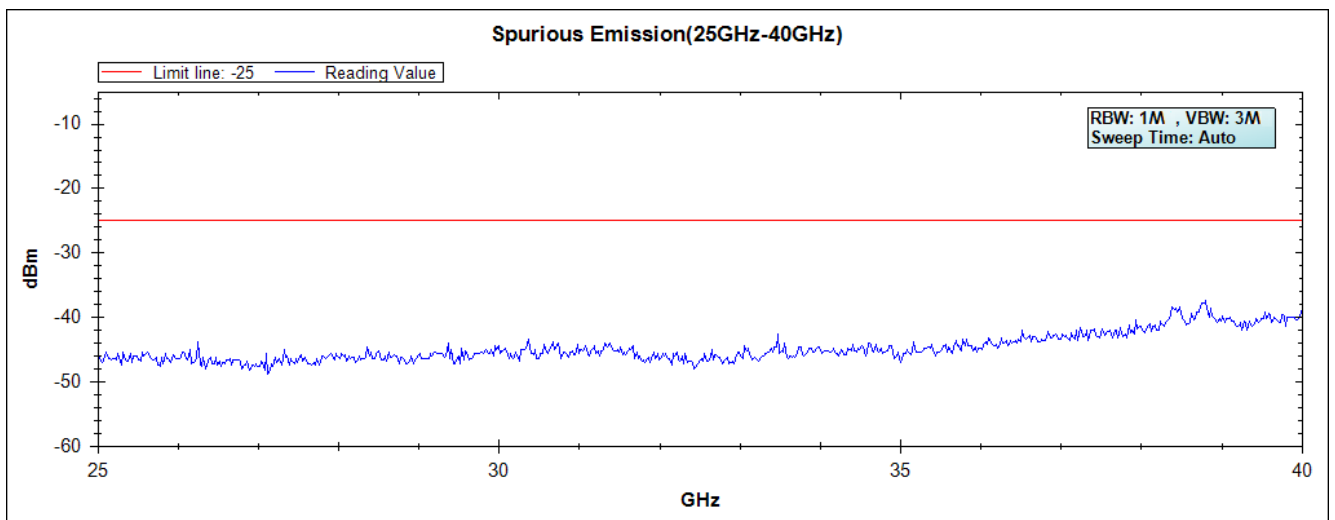
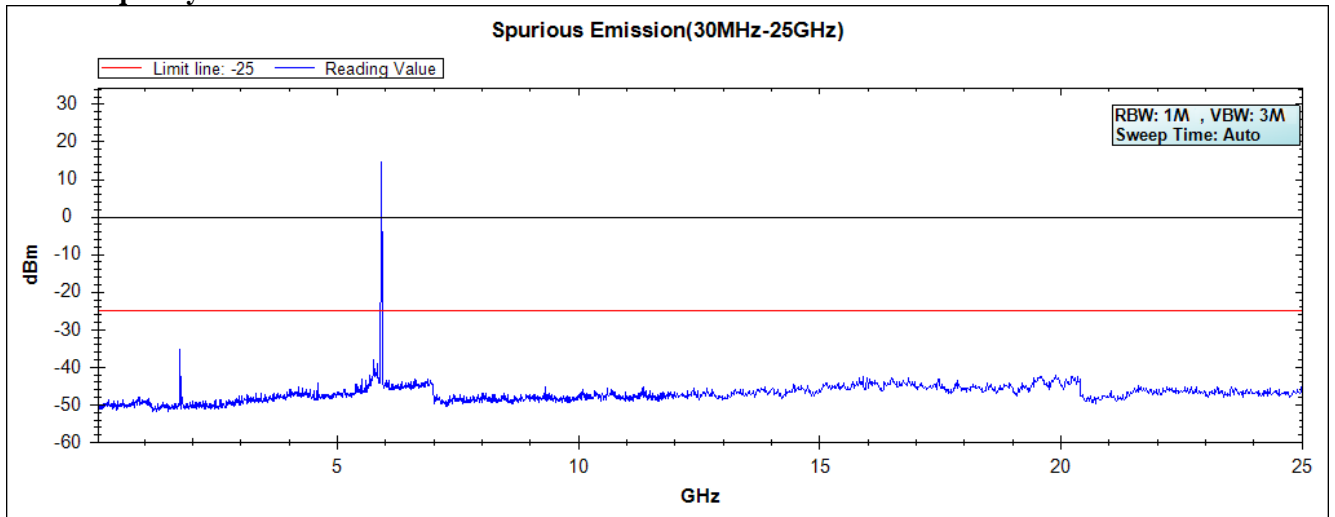

Note: The above test pattern is synthesized by multiple of the frequency range.

Chain 0

Data Rate 27 Mbps

Test Frequency: 5860MHz

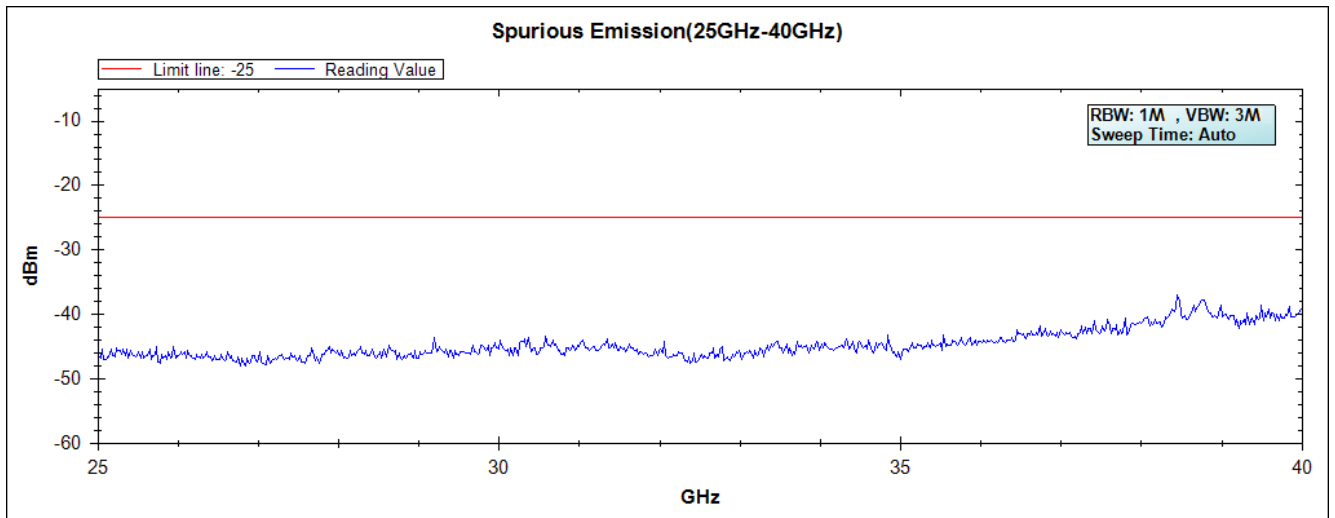
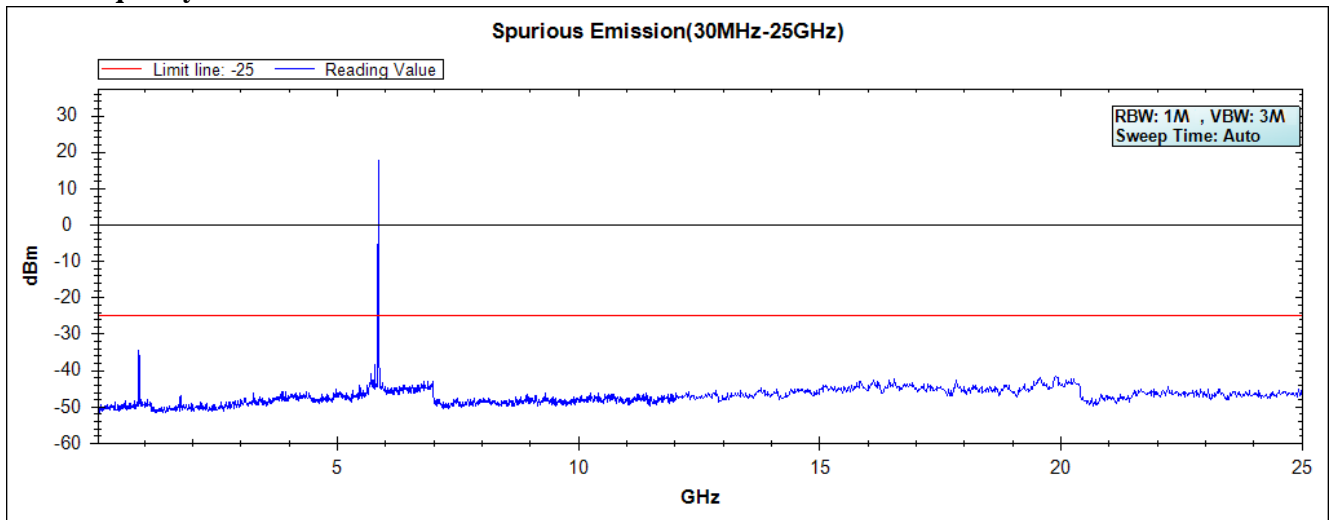

Note: The above test pattern is synthesized by multiple of the frequency range.

Test Frequency: 5890MHz

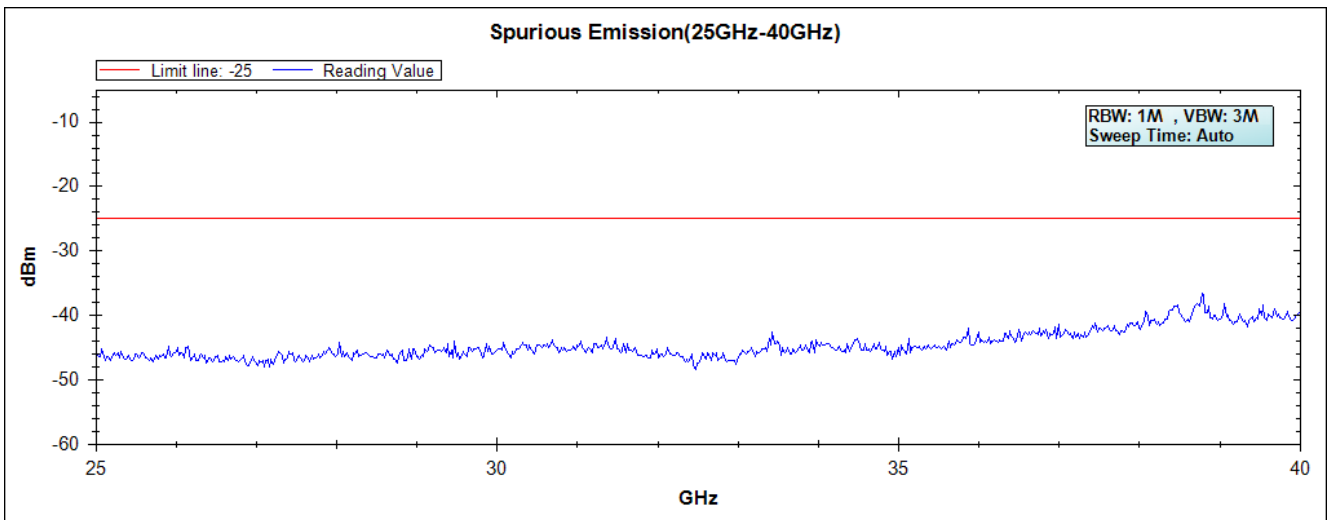
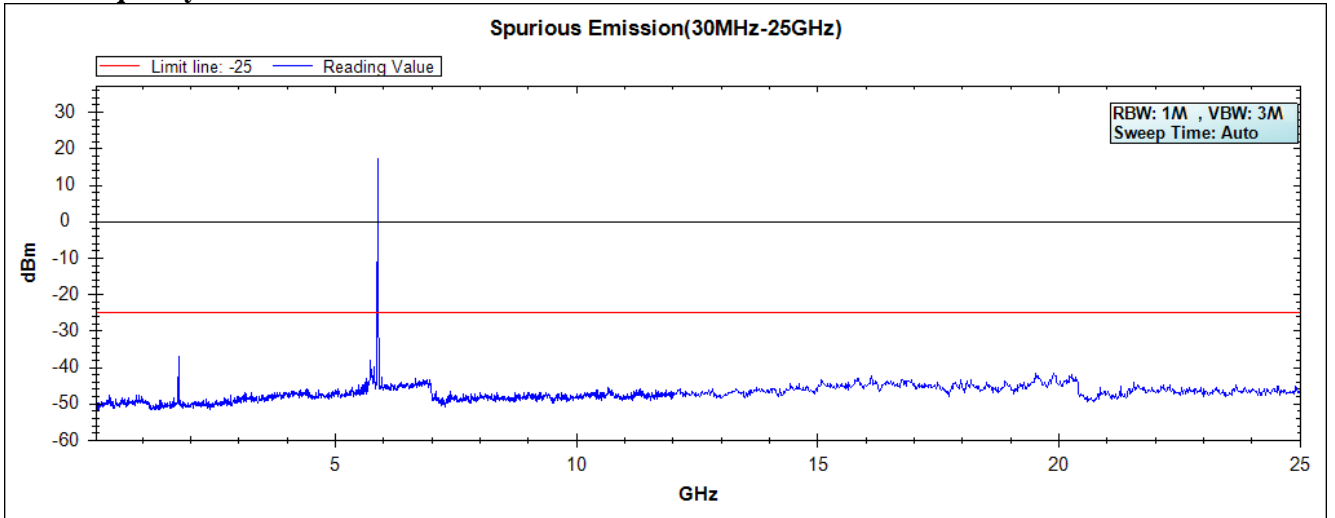

Note: The above test pattern is synthesized by multiple of the frequency range.

Test Frequency: 5920MHz

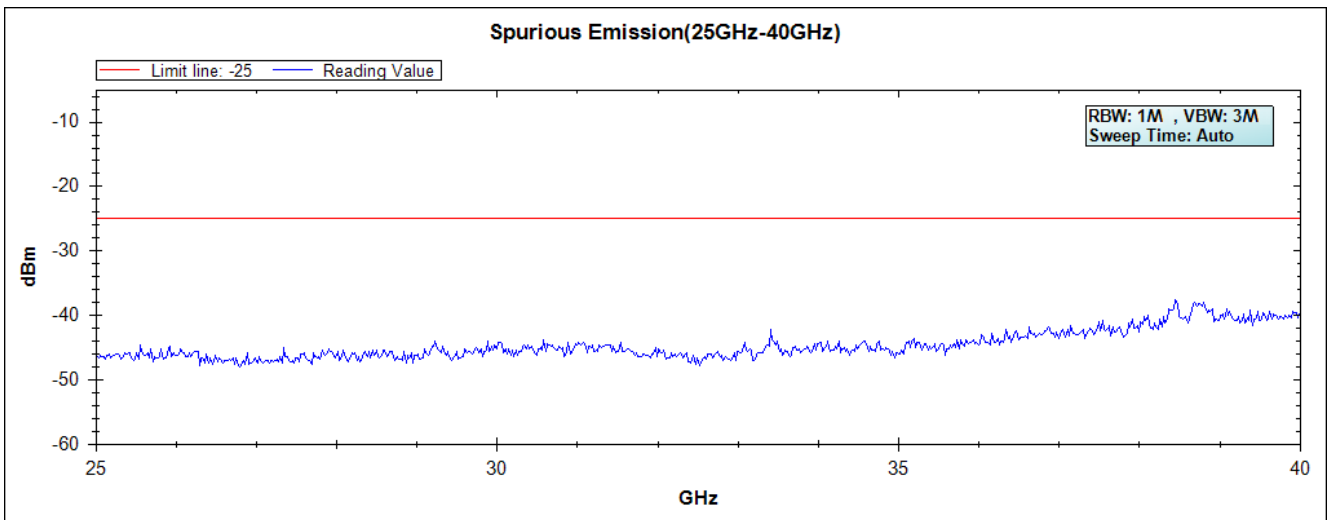
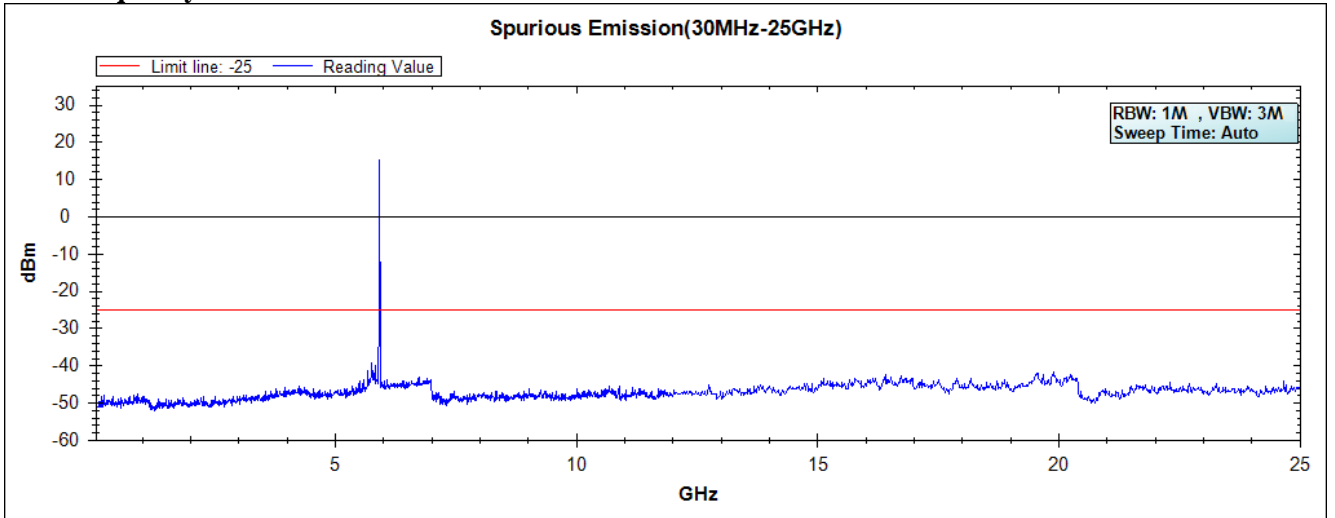

Note: The above test pattern is synthesized by multiple of the frequency range.

6. Radiated Spurious Emission

6.1. Test Setup

Radiated Emission Under 30MHz

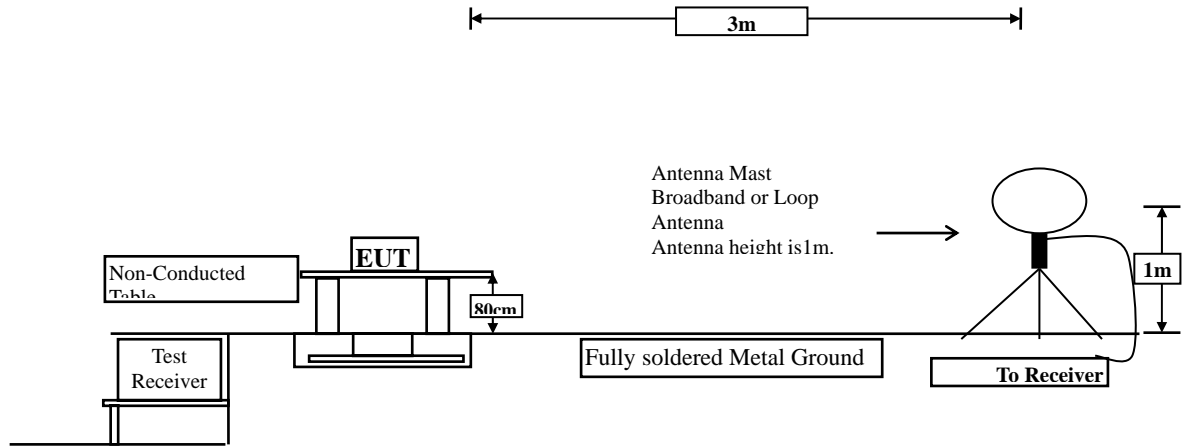

Radiated Emission Below 1GHz

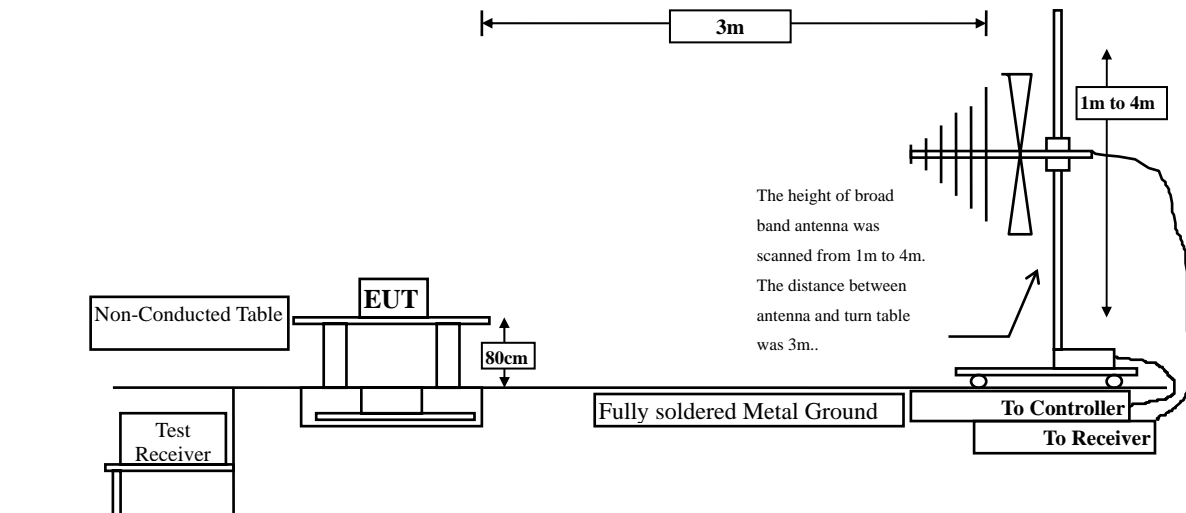

Radiated Emission Above 1GHz

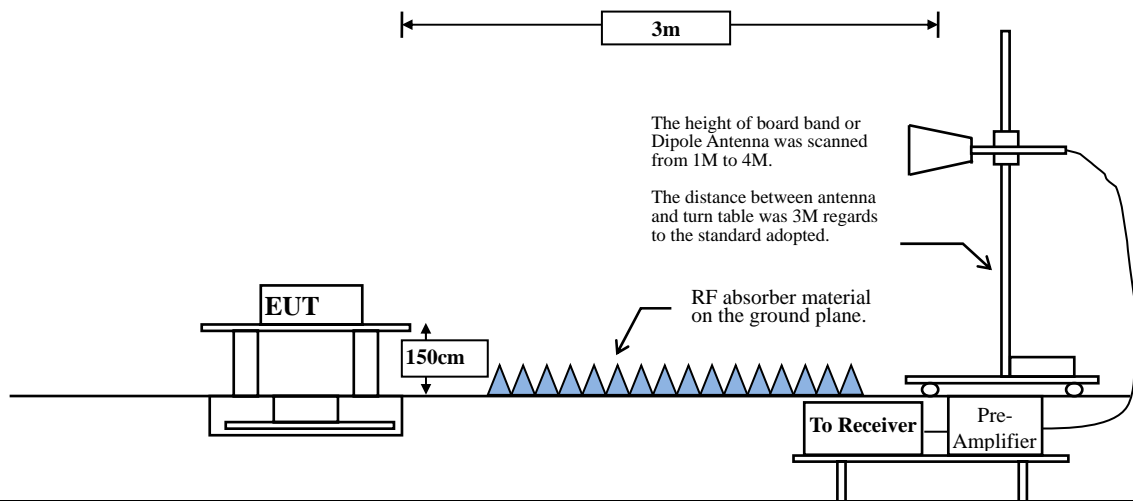

6.2. Limits

The power of any emission outside a license frequency band(s) of operation shall be attenuated below the transmitter power (P) within the licensed band(s) of operation, measured in watts, by at least $55 + 10 \log (P)$ dB (-25dBm).

$$E[\text{dB}\mu\text{V}/\text{m}] = \text{EIRP}[-25\text{dBm}] - 20 \log (d[\text{meters}]) + 104.77$$

$$E[\text{dB}\mu\text{V}/\text{m}] = 70.22 \text{ dB}\mu\text{V}/\text{m}$$

6.3. Test Procedure

Measuring the frequency range below 1GHz, the EUT is placed on a turn table which is 0.8 meter above ground, when measuring the frequency range above 1GHz, the EUT is placed on a turn table which is 1.5 meter above ground.

The turn table is rotated 360 degrees to determine the position of the maximum emission level.

The EUT was positioned such that the distance from antenna to the EUT was 3 meters.

The antenna is scanned between 1 meter and 4 meters to find out the maximum emission level. This is repeated for both horizontal and vertical polarization of the antenna. In order to find the maximum emission, all of the interface cables were manipulated according to ANSI C63.10: 2013 on radiated measurement.

The resolution bandwidth below 30MHz setting on the field strength meter is 9kHz and 30MHz~1GHz is 120kHz and above 1GHz is 1MHz.

Radiated emission measurements below 30MHz are made using Loop Antenna and 30MHz~1GHz are made using broadband Bilog antenna and above 1GHz are made using Horn Antennas.

The measurement is divided into the Preliminary Measurement and the Final Measurement.

The suspected frequencies are searched for in Preliminary Measurement with the measurement antenna kept pointed at the source of the emission both in azimuth and elevation, with the polarization of the antenna oriented for maximum response. The antenna is pointed at an angle towards the source of the emission, and the EUT is rotated in both height and polarization to maximize the measured emission. The emission is kept within the illumination area of the 3 dB bandwidth of the antenna. The measurement frequency range from 9kHz - 10th Harmonic of fundamental was investigated.

6.4. Uncertainty

Horizontal polarization :

30-300MHz: $\pm 4.08\text{dB}$; 300M-1GHz: $\pm 3.86\text{dB}$; 1-18GHz: $\pm 3.77\text{dB}$; 18-40GHz: $\pm 3.98\text{dB}$

Vertical polarization :

30-300MHz: $\pm 4.81\text{dB}$; 300M-1GHz: $\pm 3.87\text{dB}$; 1-18GHz: $\pm 3.83\text{dB}$; 18-40GHz: $\pm 3.98\text{dB}$

6.5. Test Result of Radiated Emission

Product : V2X DSRC Module
 Test Item : Radiated Emission
 Test Mode : Mode 1: Transmit (10MHz Bandwidth) (5890MHz)_3 Mbps_Chain 0
 Test Date : 2020/03/24

Horizontal

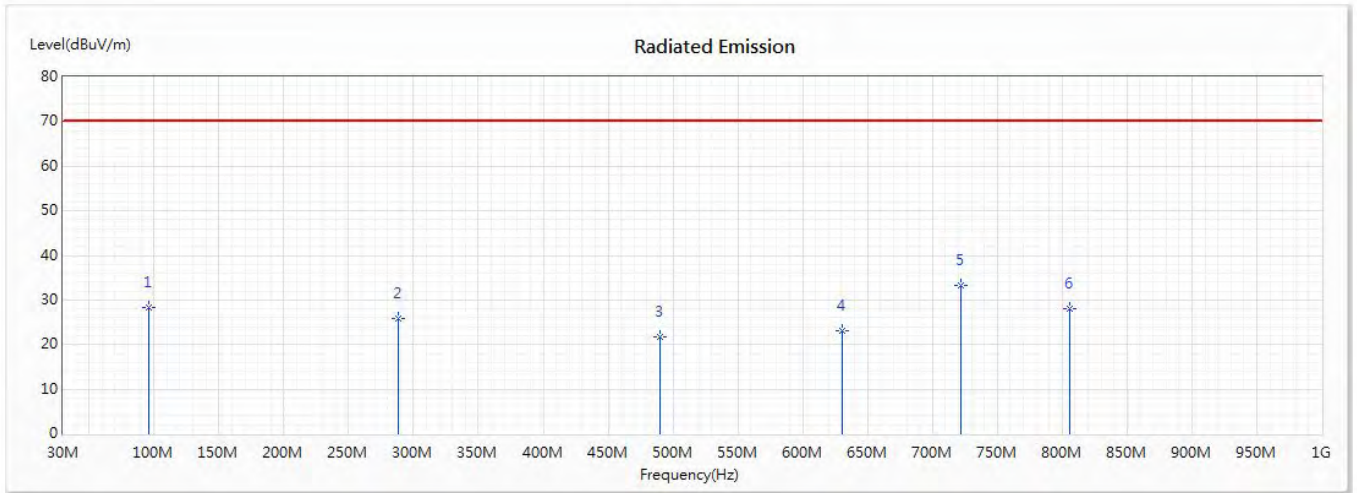

No	Frequency (MHz)	Emission Level (dBuV/m)	Limit (dBuV/m)	Margin (dB)	Reading Level (dBuV)	Correct Factor (dB/m)	Detector Type
1	96.072	28.19	70.22	-42.03	44.58	-16.39	PK
2	288.667	25.86	70.22	-44.36	35.95	-10.09	PK
3	489.696	21.68	70.22	-48.54	27.08	-5.40	PK
4	630.275	23.20	70.22	-47.02	26.08	-2.88	PK
* 5	721.652	33.16	70.22	-37.06	34.64	-1.48	PK
6	806	27.92	70.22	-42.30	28.37	-0.45	PK

Note:

1. All Readings are Peak measurements.
2. Emission Level = Reading Level + Correct Factor.
3. Correct Factor = Antenna factor + Cable loss – Amplifier gain.
4. The emission levels of other frequencies are very lower than the limit and not show in test report.
5. No emission found between lowest internal used/generated frequency to 30MHz.

Product : V2X DSRC Module
 Test Item : Radiated Emission
 Test Mode : Mode 1: Transmit (10MHz Bandwidth) (5890MHz)_3 Mbps_Chain 0
 Test Date : 2020/03/24

Vertical

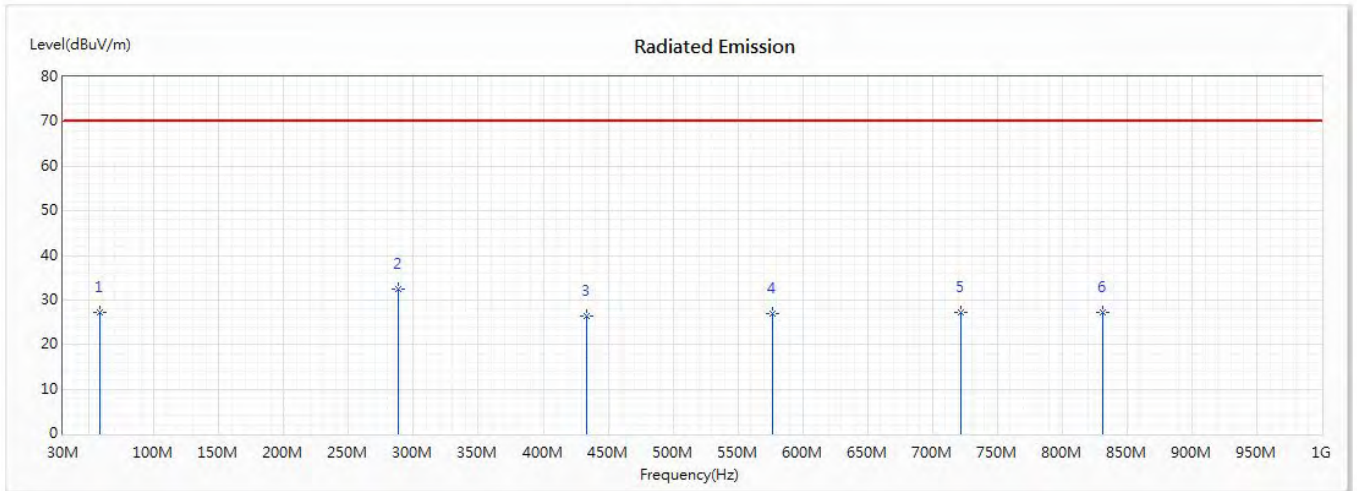

No	Frequency (MHz)	Emission Level (dBuV/m)	Limit (dBuV/m)	Margin (dB)	Reading Level (dBuV)	Correct Factor (dB/m)	Detector Type
1	58.116	27.13	70.22	-43.09	38.35	-11.22	PK
* 2	288.667	32.33	70.22	-37.89	42.42	-10.09	PK
3	433.464	26.40	70.22	-43.82	33.04	-6.64	PK
4	576.855	26.86	70.22	-43.36	30.33	-3.47	PK
5	721.652	27.13	70.22	-43.09	28.61	-1.48	PK
6	831.304	27.28	70.22	-42.94	27.35	-0.07	PK

Note:

1. All Readings are Peak measurements.
2. Emission Level = Reading Level + Correct Factor.
3. Correct Factor = Antenna factor + Cable loss – Amplifier gain.
4. The emission levels of other frequencies are very lower than the limit and not show in test report.
5. No emission found between lowest internal used/generated frequency to 30MHz.

Product : V2X DSRC Module
 Test Item : Radiated Emission
 Test Mode : Mode 1: Transmit (10MHz Bandwidth) (5890MHz)_27 Mbps_Chain 0
 Test Date : 2020/03/24

Horizontal

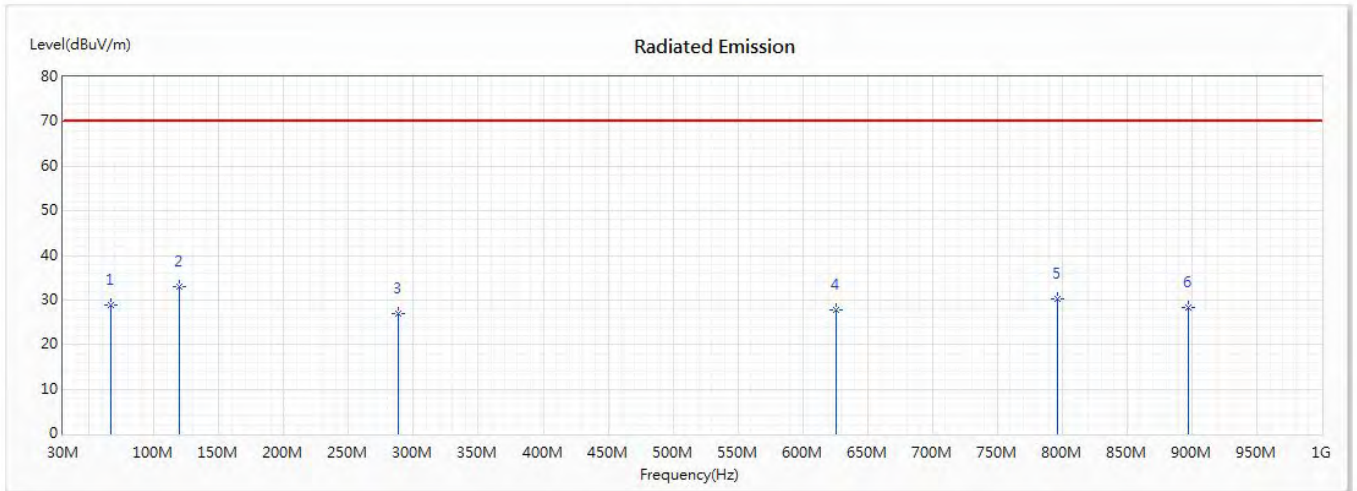

No	Frequency (MHz)	Emission Level (dBuV/m)	Limit (dBuV/m)	Margin (dB)	Reading Level (dBuV)	Correct Factor (dB/m)	Detector Type
1	66.551	28.86	70.22	-41.36	41.62	-12.76	PK
* 2	119.971	32.91	70.22	-37.31	46.05	-13.14	PK
3	288.667	26.81	70.22	-43.41	36.90	-10.09	PK
4	626.058	27.83	70.22	-42.39	30.79	-2.96	PK
5	796.159	30.15	70.22	-40.07	30.54	-0.39	PK
6	897.377	28.22	70.22	-42.00	27.49	0.73	PK

Note:

1. All Readings are Peak measurements.
2. Emission Level = Reading Level + Correct Factor.
3. Correct Factor = Antenna factor + Cable loss – Amplifier gain.
4. The emission levels of other frequencies are very lower than the limit and not show in test report.
5. No emission found between lowest internal used/generated frequency to 30MHz.

Product : V2X DSRC Module
 Test Item : Radiated Emission
 Test Mode : Mode 1: Transmit (10MHz Bandwidth) (5890MHz)_27 Mbps_Chain 0
 Test Date : 2020/03/24

Vertical

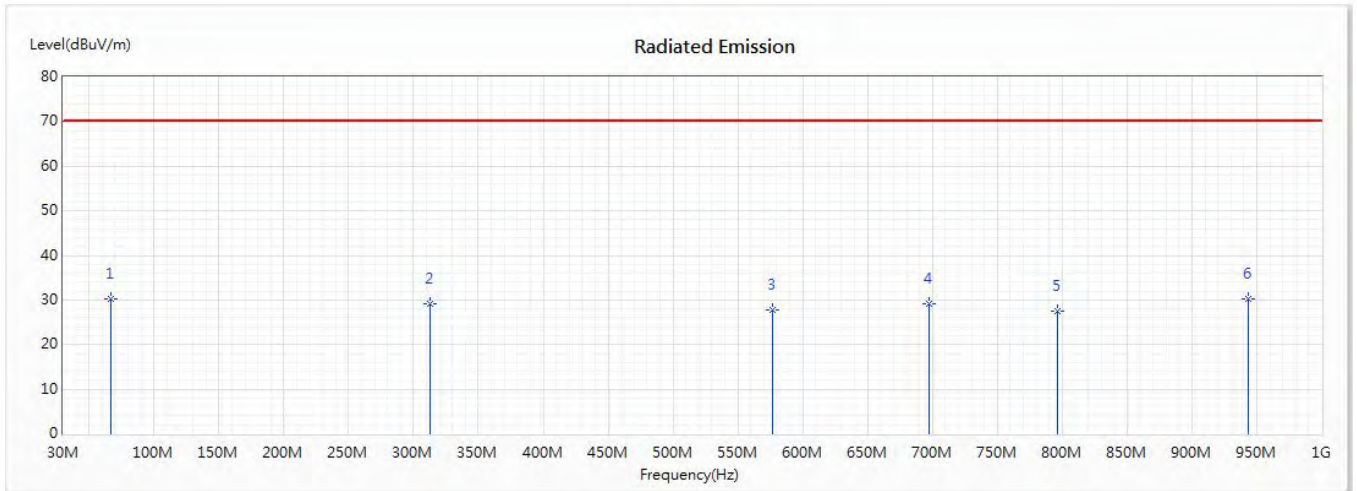

No	Frequency (MHz)	Emission Level (dBuV/m)	Limit (dBuV/m)	Margin (dB)	Reading Level (dBuV)	Correct Factor (dB/m)	Detector Type
1	66.551	30.31	70.22	-39.91	43.07	-12.76	PK
2	312.565	29.26	70.22	-40.96	38.76	-9.50	PK
3	576.855	27.89	70.22	-42.33	31.36	-3.47	PK
4	697.754	29.02	70.22	-41.20	30.88	-1.86	PK
5	796.159	27.42	70.22	-42.80	27.81	-0.39	PK
* 6	943.768	30.32	70.22	-39.90	29.04	1.28	PK

Note:

1. All Readings are Peak measurements.
2. Emission Level = Reading Level + Correct Factor.
3. Correct Factor = Antenna factor + Cable loss – Amplifier gain.
4. The emission levels of other frequencies are very lower than the limit and not show in test report.
5. No emission found between lowest internal used/generated frequency to 30MHz.

Product : V2X DSRC Module
 Test Item : Radiated Emission
 Test Mode : Mode 1: Transmit (10MHz Bandwidth) (5860MHz)_3 Mbps_Chain 0
 Test Date : 2020/03/23

Horizontal

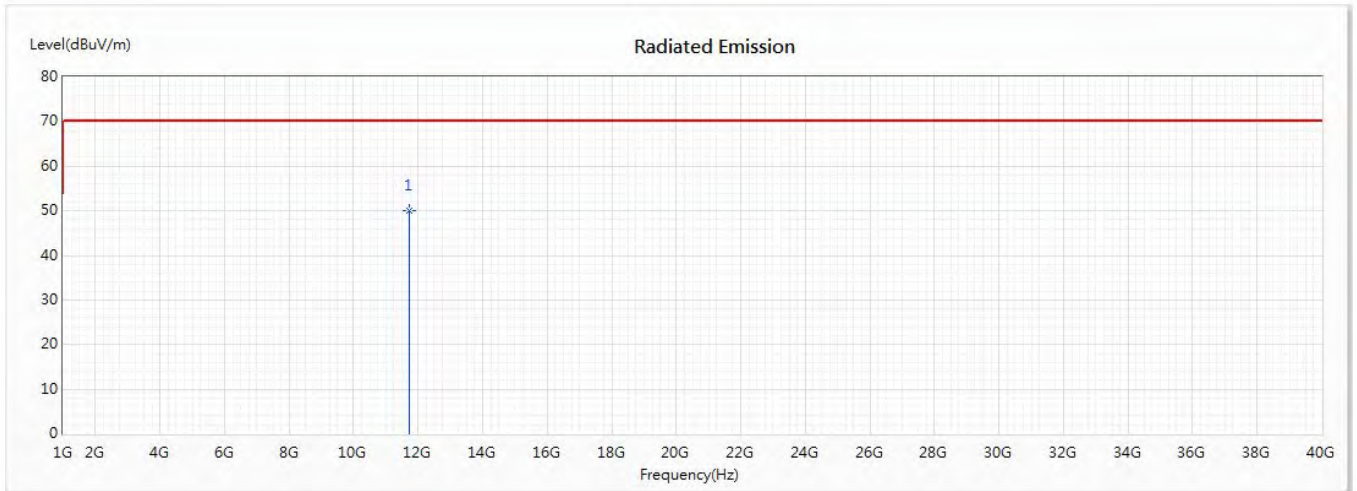

No	Frequency (MHz)	Emission Level (dBuV/m)	Limit (dBuV/m)	Margin (dB)	Reading Level (dBuV)	Correct Factor (dB/m)	Detector Type
* 1	11720	50.01	70.22	-20.21	45.16	4.85	PK

Note:

1. All Readings are Peak measurements.
2. Emission Level = Reading Level + Correct Factor.
3. Correct Factor = Antenna factor + Cable loss – Amplifier gain.
4. The emission levels of other frequencies are very lower than the limit and not show in test report.

Product : V2X DSRC Module
 Test Item : Radiated Emission
 Test Mode : Mode 1: Transmit (10MHz Bandwidth) (5860MHz)_3 Mbps_Chain 0
 Test Date : 2020/03/23

Vertical

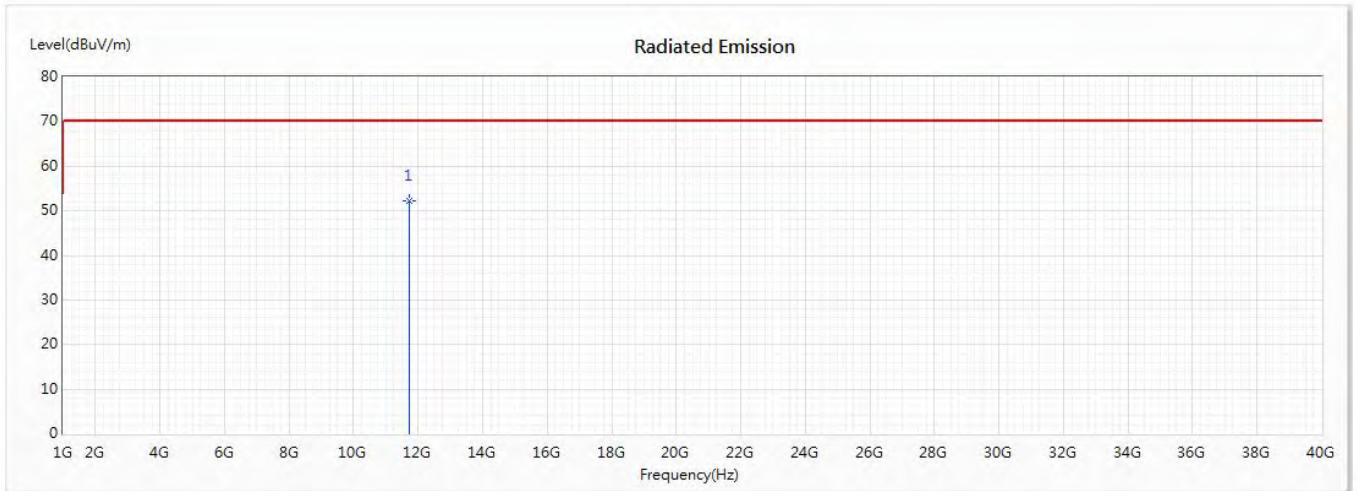

No	Frequency (MHz)	Emission Level (dBuV/m)	Limit (dBuV/m)	Margin (dB)	Reading Level (dBuV)	Correct Factor (dB/m)	Detector Type
* 1	11720	52.10	70.22	-18.12	47.25	4.85	PK

Note:

1. All Readings are Peak measurements.
2. Emission Level = Reading Level + Correct Factor.
3. Correct Factor = Antenna factor + Cable loss – Amplifier gain.
4. The emission levels of other frequencies are very lower than the limit and not show in test report.

Product : V2X DSRC Module
 Test Item : Radiated Emission
 Test Mode : Mode 1: Transmit (10MHz Bandwidth) (5890MHz)_3 Mbps_Chain 0
 Test Date : 2020/03/23

Horizontal

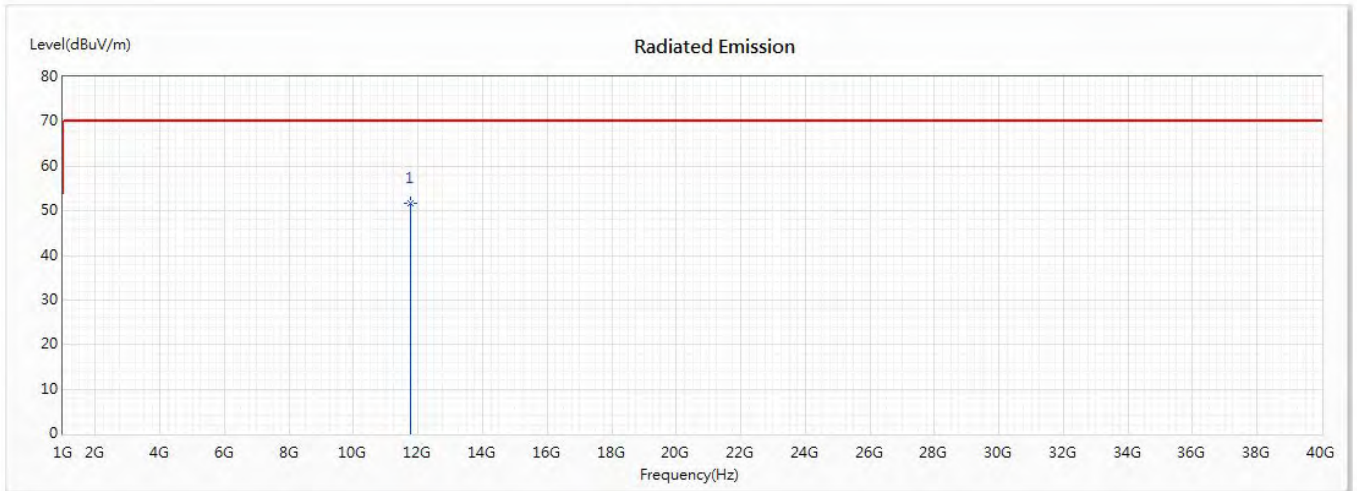

No	Frequency (MHz)	Emission Level (dBuV/m)	Limit (dBuV/m)	Margin (dB)	Reading Level (dBuV)	Correct Factor (dB/m)	Detector Type
* 1	11780	51.75	70.22	-18.47	46.82	4.93	PK

Note:

1. All Readings are Peak measurements.
2. Emission Level = Reading Level + Correct Factor.
3. Correct Factor = Antenna factor + Cable loss – Amplifier gain.
4. The emission levels of other frequencies are very lower than the limit and not show in test report.

Product : V2X DSRC Module
 Test Item : Radiated Emission
 Test Mode : Mode 1: Transmit (10MHz Bandwidth) (5890MHz)_3 Mbps_Chain 0
 Test Date : 2020/03/23

Vertical

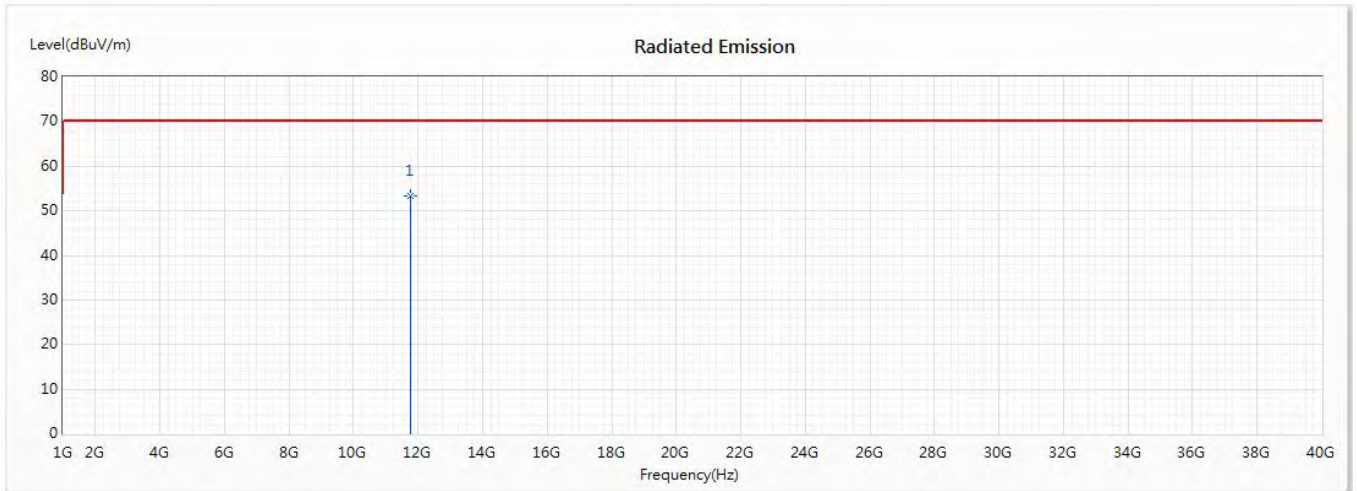

No	Frequency (MHz)	Emission Level (dBuV/m)	Limit (dBuV/m)	Margin (dB)	Reading Level (dBuV)	Correct Factor (dB/m)	Detector Type
* 1	11780	53.23	70.22	-16.99	48.30	4.93	PK

Note:

1. All Readings are Peak measurements.
2. Emission Level = Reading Level + Correct Factor.
3. Correct Factor = Antenna factor + Cable loss – Amplifier gain.
4. The emission levels of other frequencies are very lower than the limit and not show in test report.

Product : V2X DSRC Module
 Test Item : Radiated Emission
 Test Mode : Mode 1: Transmit (10MHz Bandwidth) (5920MHz)_3 Mbps_Chain 0
 Test Date : 2020/03/23

Horizontal

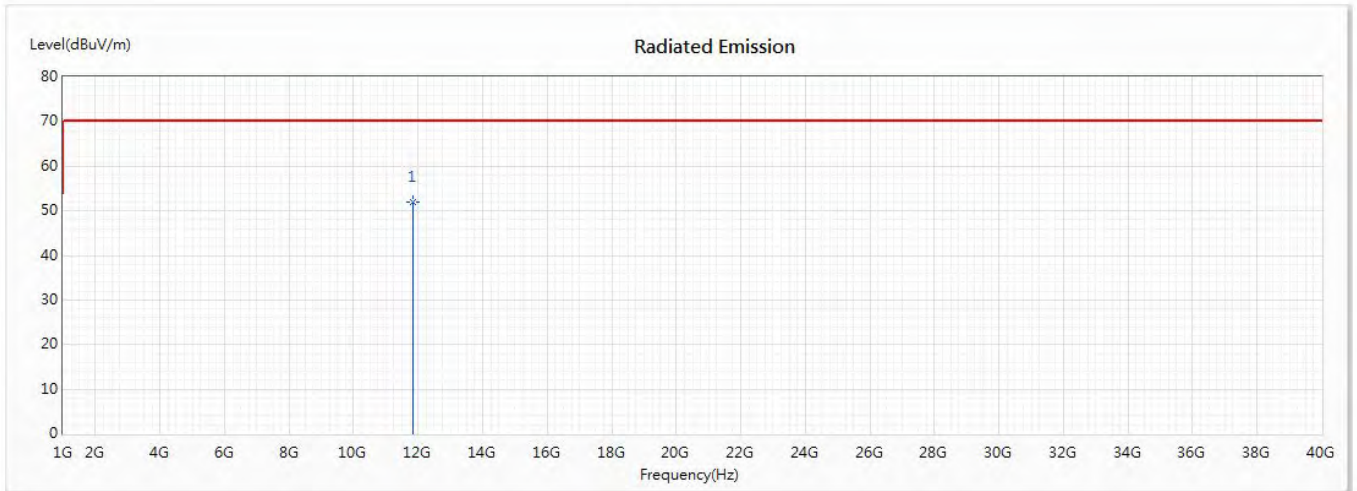

No	Frequency (MHz)	Emission Level (dBuV/m)	Limit (dBuV/m)	Margin (dB)	Reading Level (dBuV)	Correct Factor (dB/m)	Detector Type
* 1	11840	51.89	70.22	-18.33	47.08	4.81	PK

Note:

1. All Readings are Peak measurements.
2. Emission Level = Reading Level + Correct Factor.
3. Correct Factor = Antenna factor + Cable loss – Amplifier gain.
4. The emission levels of other frequencies are very lower than the limit and not show in test report.

Product : V2X DSRC Module
 Test Item : Radiated Emission
 Test Mode : Mode 1: Transmit (10MHz Bandwidth) (5920MHz)_3 Mbps_Chain 0
 Test Date : 2020/03/23

Vertical

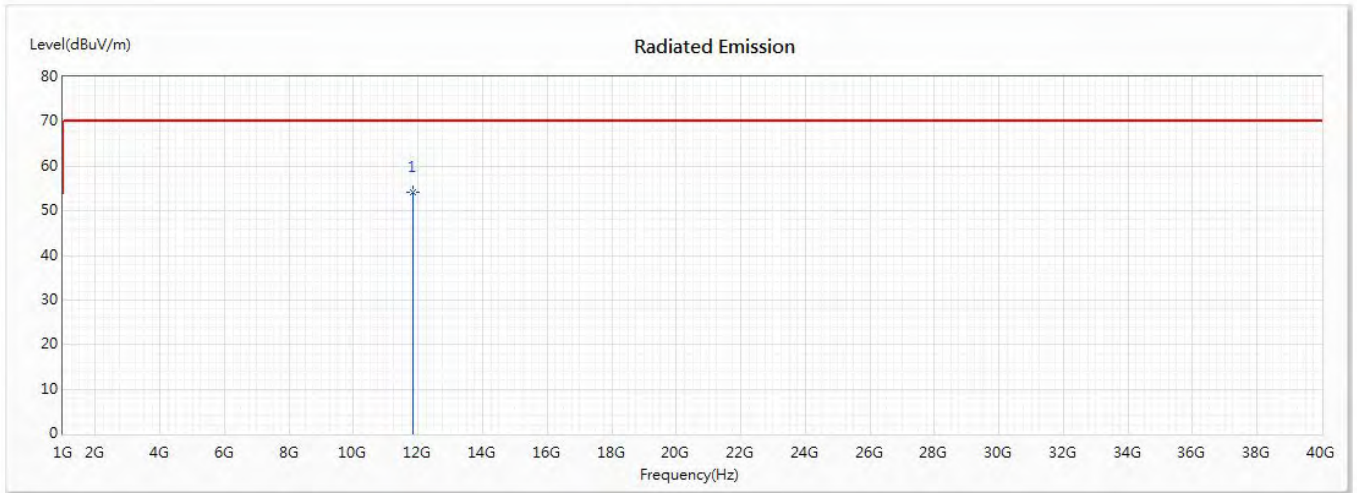

No	Frequency (MHz)	Emission Level (dBuV/m)	Limit (dBuV/m)	Margin (dB)	Reading Level (dBuV)	Correct Factor (dB/m)	Detector Type
* 1	11840	54.16	70.22	-16.06	49.35	4.81	PK

Note:

1. All Readings are Peak measurements.
2. Emission Level = Reading Level + Correct Factor.
3. Correct Factor = Antenna factor + Cable loss – Amplifier gain.
4. The emission levels of other frequencies are very lower than the limit and not show in test report.

Product : V2X DSRC Module
 Test Item : Radiated Emission
 Test Mode : Mode 1: Transmit (10MHz Bandwidth) (5860MHz)_27 Mbps_Chain 0
 Test Date : 2020/03/23

Horizontal

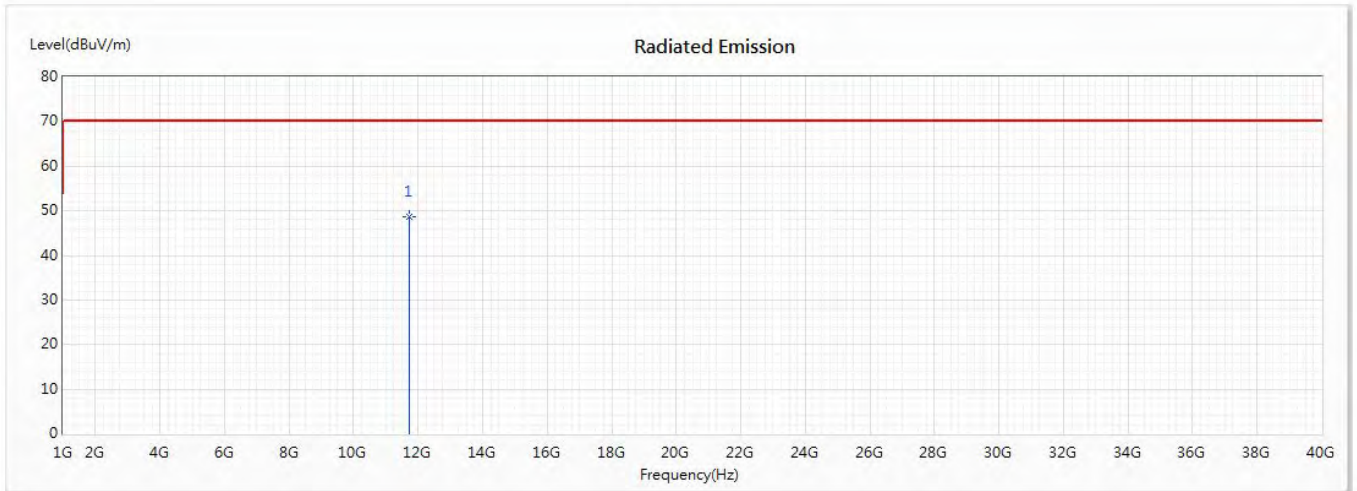

No	Frequency (MHz)	Emission Level (dBuV/m)	Limit (dBuV/m)	Margin (dB)	Reading Level (dBuV)	Correct Factor (dB/m)	Detector Type
* 1	11720	48.58	70.22	-21.64	43.73	4.85	PK

Note:

1. All Readings are Peak measurements.
2. Emission Level = Reading Level + Correct Factor.
3. Correct Factor = Antenna factor + Cable loss – Amplifier gain.
4. The emission levels of other frequencies are very lower than the limit and not show in test report.

Product : V2X DSRC Module
 Test Item : Radiated Emission
 Test Mode : Mode 1: Transmit (10MHz Bandwidth) (5860MHz)_27 Mbps_Chain 0
 Test Date : 2020/03/23

Vertical

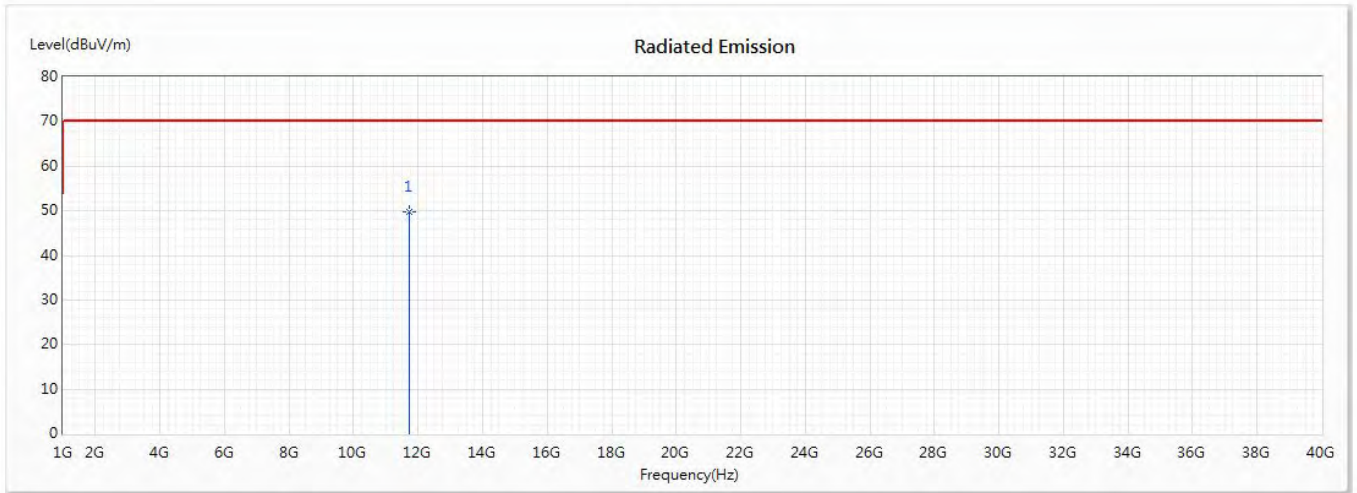

No	Frequency (MHz)	Emission Level (dBuV/m)	Limit (dBuV/m)	Margin (dB)	Reading Level (dBuV)	Correct Factor (dB/m)	Detector Type
* 1	11720	49.85	70.22	-20.37	45.00	4.85	PK

Note:

1. All Readings are Peak measurements.
2. Emission Level = Reading Level + Correct Factor.
3. Correct Factor = Antenna factor + Cable loss – Amplifier gain.
4. The emission levels of other frequencies are very lower than the limit and not show in test report.

Product : V2X DSRC Module
 Test Item : Radiated Emission
 Test Mode : Mode 1: Transmit (10MHz Bandwidth) (5890MHz)_27 Mbps_Chain 0
 Test Date : 2020/03/23

Horizontal

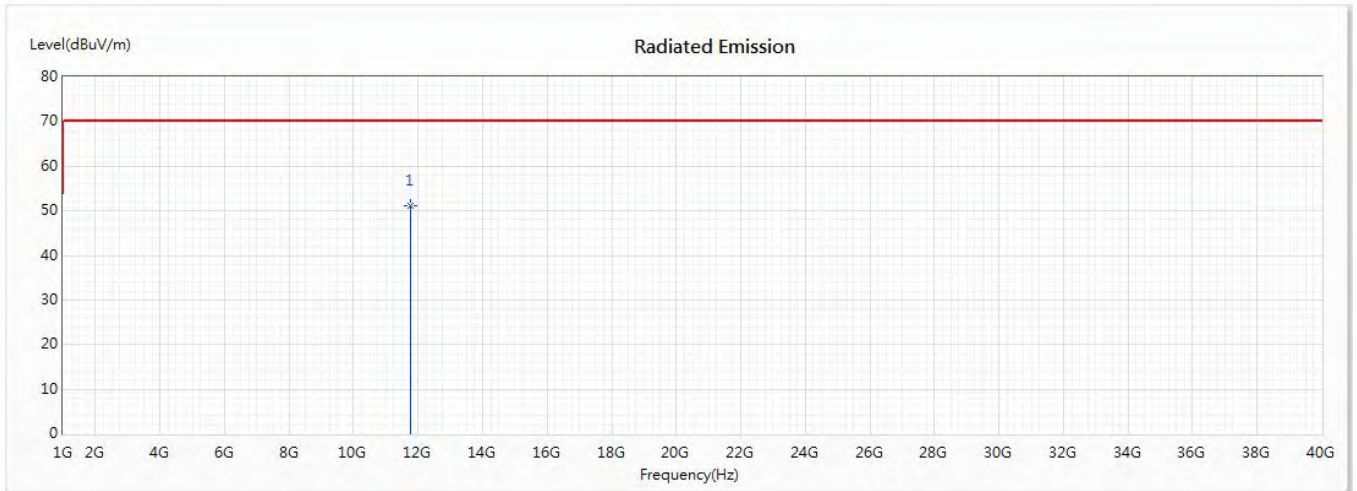

No	Frequency (MHz)	Emission Level (dBuV/m)	Limit (dBuV/m)	Margin (dB)	Reading Level (dBuV)	Correct Factor (dB/m)	Detector Type
* 1	11780	51.08	70.22	-19.14	46.15	4.93	PK

Note:

1. All Readings are Peak measurements.
2. Emission Level = Reading Level + Correct Factor.
3. Correct Factor = Antenna factor + Cable loss – Amplifier gain.
4. The emission levels of other frequencies are very lower than the limit and not show in test report.

Product : V2X DSRC Module
 Test Item : Radiated Emission
 Test Mode : Mode 1: Transmit (10MHz Bandwidth) (5890MHz)_27 Mbps_Chain 0
 Test Date : 2020/03/23

Vertical

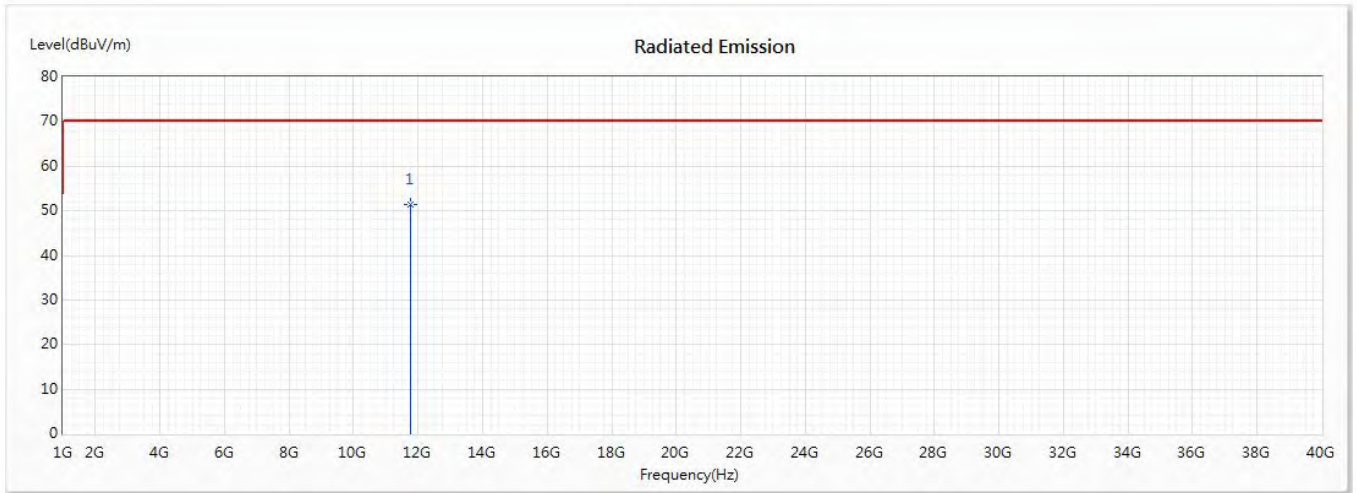

No	Frequency (MHz)	Emission Level (dBuV/m)	Limit (dBuV/m)	Margin (dB)	Reading Level (dBuV)	Correct Factor (dB/m)	Detector Type
* 1	11780	51.42	70.22	-18.80	46.49	4.93	PK

Note:

1. All Readings are Peak measurements.
2. Emission Level = Reading Level + Correct Factor.
3. Correct Factor = Antenna factor + Cable loss – Amplifier gain.
4. The emission levels of other frequencies are very lower than the limit and not show in test report.

Product : V2X DSRC Module
 Test Item : Radiated Emission
 Test Mode : Mode 1: Transmit (10MHz Bandwidth) (5920MHz)_27 Mbps_Chain 0
 Test Date : 2020/03/23

Horizontal

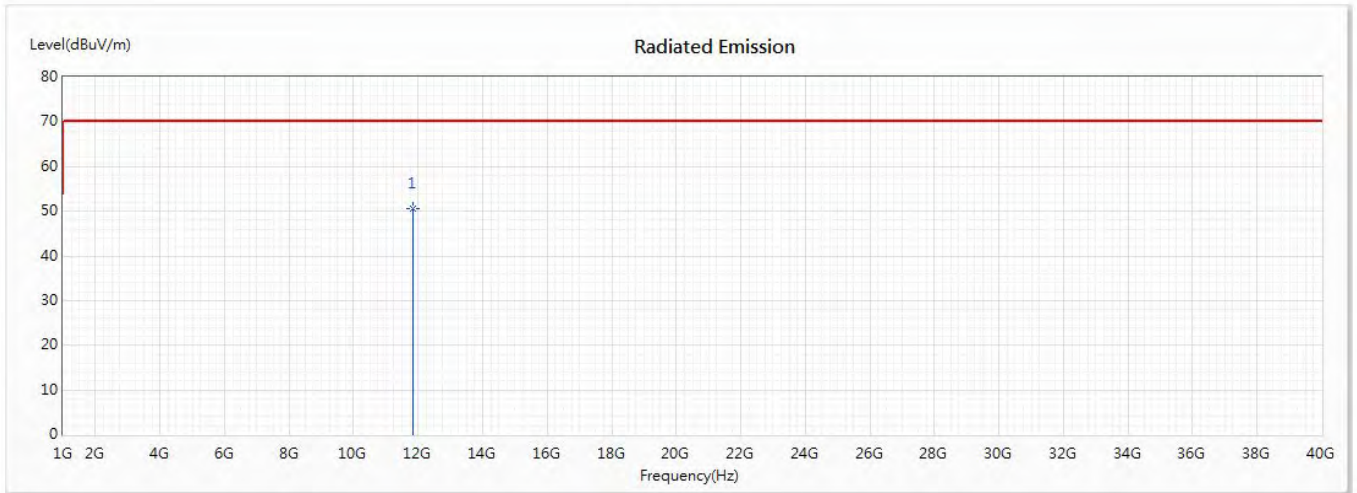

No	Frequency (MHz)	Emission Level (dBuV/m)	Limit (dBuV/m)	Margin (dB)	Reading Level (dBuV)	Correct Factor (dB/m)	Detector Type
* 1	11840	50.70	70.22	-19.52	45.89	4.81	PK

Note:

1. All Readings are Peak measurements.
2. Emission Level = Reading Level + Correct Factor.
3. Correct Factor = Antenna factor + Cable loss – Amplifier gain.
4. The emission levels of other frequencies are very lower than the limit and not show in test report.

Product : V2X DSRC Module
 Test Item : Radiated Emission
 Test Mode : Mode 1: Transmit (10MHz Bandwidth) (5920MHz)_27 Mbps_Chain 0
 Test Date : 2020/03/23

Vertical

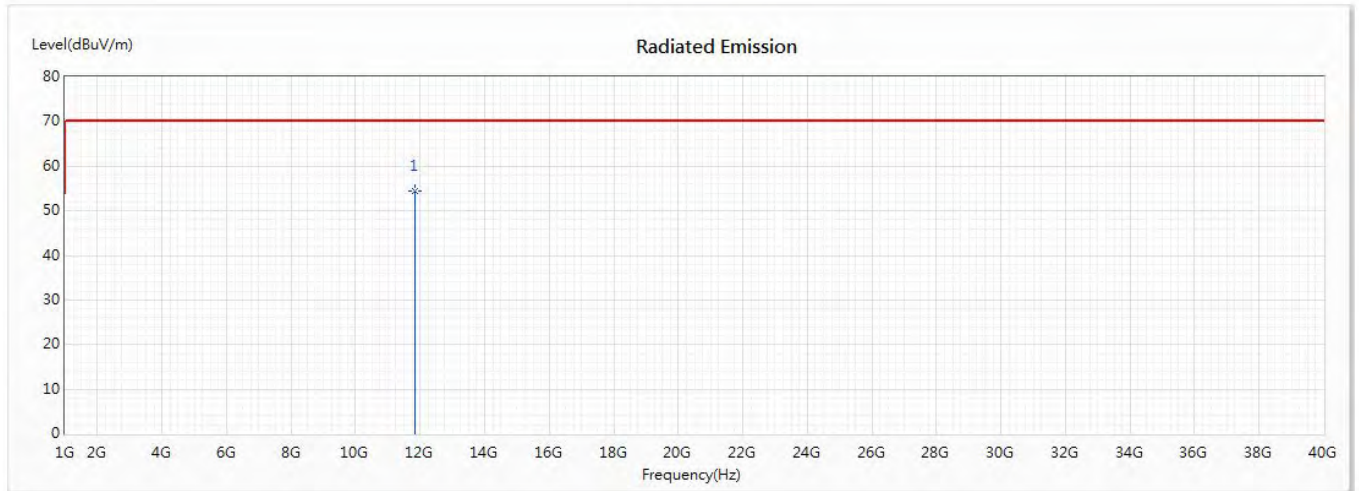

No	Frequency (MHz)	Emission Level (dBuV/m)	Limit (dBuV/m)	Margin (dB)	Reading Level (dBuV)	Correct Factor (dB/m)	Detector Type
* 1	11840	54.54	70.22	-15.68	49.73	4.81	PK

Note:

1. All Readings are Peak measurements.
2. Emission Level = Reading Level + Correct Factor.
3. Correct Factor = Antenna factor + Cable loss – Amplifier gain.
4. The emission levels of other frequencies are very lower than the limit and not show in test report.

7. Frequency Stability

7.1. Test Setup

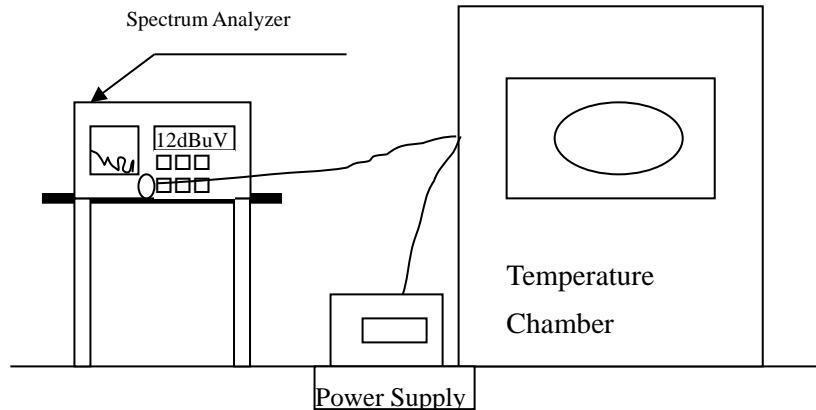

7.2. Limits

± 10 ppm maximum.

7.3. Test Procedure

The carrier frequency stability is the ability of the transmitter to maintain an assigned carrier frequency.

The EUT was evaluated over the temperature range -30°C to $+50^{\circ}\text{C}$.

The temperature was initially set to -30°C and a 2-hour period was observed for stabilization of the EUT. The frequency stability was measured within one minute after application of primary power to the transmitter. The temperature was raised at intervals of 10°C through the range. A $\frac{1}{2}$ hour period was observed to stabilize the EUT at each measurement step, and the frequency stability was measured within one minute after application of primary power to the transmitter. Additionally, the power supply voltage of the EUT was varied $\pm 15\%$ nominal and range of input voltages.

7.4. Uncertainty

$\pm 671.83\text{Hz}$

7.5. Test Result of Frequency Stability

Product : V2X DSRC Module
 Test Item : Frequency Stability
 Test Mode : Mode 1: Transmit (10MHz Bandwidth)
 Test Date : 2020/03/19

Chain 0

Test Frequency: 5860 MHz

Temperature (°C)	Voltage (V)	Channel No	Measure Level (MHz)	Deviation (ppm)	Limits (ppm)	Result
20	5	172	5859.99761	0.000	±10	PASS
	5.75		5859.99768	0.012	±10	PASS
	4.80		5859.99754	-0.012	±10	PASS
-30	5		5860.00492	1.247	±10	PASS
-20			5860.00499	1.259	±10	PASS
-10			5860.00448	1.172	±10	PASS
0			5860.00144	0.654	±10	PASS
10			5860.00050	0.493	±10	PASS
30			5859.99717	-0.075	±10	PASS
40			5859.99710	-0.087	±10	PASS
50			5859.99739	-0.038	±10	PASS

Test Frequency: 5890 MHz

Temperature (°C)	Voltage (V)	Channel No	Measure Level (MHz)	Deviation (ppm)	Limits (ppm)	Result
20	5	178	5889.99963	0.000	±10	PASS
	5.75		5889.99949	-0.024	±10	PASS
	4.80		5889.99927	-0.061	±10	PASS
-30	5		5890.00484	0.885	±10	PASS
-20			5890.00463	0.849	±10	PASS
-10			5890.00347	0.652	±10	PASS
0			5890.00101	0.234	±10	PASS
10			5889.99992	0.049	±10	PASS
30			5889.99717	-0.418	±10	PASS
40			5889.99739	-0.380	±10	PASS
50			5889.99754	-0.355	±10	PASS

Test Frequency: 5920 MHz

Temperature (°C)	Voltage (V)	Channel No	Measure Level (MHz)	Deviation (ppm)	Limits (ppm)	Result
20	5	184	5919.99855	0.000	±10	PASS
	5.75		5919.99869	0.024	±10	PASS
	4.80		5919.99848	-0.012	±10	PASS
-30	5		5920.00470	1.039	±10	PASS
-20			5920.00448	1.002	±10	PASS
-10			5920.00311	0.770	±10	PASS
0			5920.00079	0.378	±10	PASS
10			5919.99956	0.171	±10	PASS
30			5919.99717	-0.233	±10	PASS
40			5919.99746	-0.184	±10	PASS
50			5919.99768	-0.147	±10	PASS

Note: Test voltage 4.80V is minimum stable voltage of EUT.

8. EMI Reduction Method During Compliance Testing

No modification was made during testing.