

FCC Part 74 Subpart H
EMI TEST REPORT

of

E.U.T. : Wireless Microphone
(Transmitter)
MODEL : WT-808T
FCC ID. : NTMWT-808T
Working Frequency : 740-806MHz

for

APPLICANT : E-J Electronics Co., Ltd.
ADDRESS : 4F, NO.11, Lane 125, Sec 1, Kuo Kwang Rd., Ta
Li City, Taichung Hsien, Taiwan.

Test Performed by

ELECTRONICS TESTING CENTER, TAIWAN

NO. 34, LIN 5, DING FU TSUN, LINKOU HSIANG

TAIPEI HSIEN, TAIWAN, R.O.C.

Tel:(02) 26023052

Fax:(02)26010910

<http://www.etc.org.tw> ; e-mail : r00@etc.org.tw

Report Number : ET94R-05-043-01

TEST REPORT CERTIFICATION

Applicant : E-J Electronics Co., Ltd.
4F, NO.11, Lane 125, Sec 1, Kuo Kwang Rd., Ta Li City, Taichung Hsien, Taiwan.

Manufacturer : E-J Electronics Co., Ltd.
4F, NO.11, Lane 125, Sec 1, Kuo Kwang Rd., Ta Li City, Taichung Hsien, Taiwan.

Description of EUT

- a) Type of EUT : Wireless Microphone (Transmitter)
- b) Trade Name : E-J
- c) Model No. : WT-808T
- d) Power Supply : Power Adaptor I/P: AC 100-240V(47-63Hz), 0.15A, Max
O/P: DC5V, 1A, 5W, Max; Battery 1.5Vx2
- e) Frequency Range : 740MHz-806MHz

Regulation Applied : FCC Rules and Regulations Part 74 Subpart H (2003)

I HEREBY CERTIFY THAT; The data shown in this report were made in accordance with the procedures given in ANSI C63.4 and the energy emitted by the device was founded to be within the limits applicable. I assume full responsibility for accuracy and completeness of these data.

Note: 1. The result of the testing report relate only to the item tested.

2. The testing report shall not be reproduced expect in full, without the written approval of ETC.

Issued Date : May 24, 2005

Test Engineer : 
(Vicent Chang)

Approve & Authorized Signer : 
Will Yauo, Manager
EMC Dept. II of ELECTRONICS
TESTING CENTER, TAIWAN

Table of Contents	Page
1 GENERAL INFORMATION	1
1.1 Product Description	1
1.2 Characteristics of Device:.....	1
1.3 Test Methodology	1
1.4 Test Facility	1
2 REQUIREMENTS OF PROVISIONS.....	2
2.1 Definition.....	2
2.2 Frequencies Available	2
2.3 Requirements for Radio Equipment on Certification.....	2
2.4 Labeling Requirement	3
3 OUTPUT POWER MEASUREMENT.....	4
3.1 Provision Applicable	4
3.2 Measurement Procedure	4
3.3 Test Data.....	6
3.4 Result Calculation.....	8
3.5 Test Equipment	8
4 MODULATION CHARACTERISTICS	9
4.1 Provisions Applicable	9
4.2 Measurement Method	9
4.3 Measurement Instrument	10
4.4 Measurement Result.....	10
5 OCCUPIED BANDWIDTH OF EMISSION.....	14
5.1 Provisions Applicable.....	14
5.2 Measurement Method	14
5.3 Occupied Bandwidth Test Equipment	14
5.4 Bandwidth Measured.....	15
6 FIELD STRENGTH OF EMISSION	17
6.1 Provisions Applicable.....	17
6.2 Measurement Procedure	17
6.3 Measuring Instrument	18
6.4 Measuring Data.....	19
6.5 Radiated Measurement Photos	27

7 FREQUENCY STABILITY MEASUREMENT	29
7.1 Provisions Applicable.....	29
7.2 Measurement Procedure.....	29
7.3 Measurement Instrument.....	30
7.4 Measurement Data.....	31
8 CONDUCTED EMISSION MEASUREMENT	37
8.1 Description.....	37
8.2 Measurement Procedure.....	37
8.3 Conducted Emission Data.....	38
8.4 Result Data Calculation.....	39
8.5 Conducted Measurement Equipment.....	40
8.6 Photos of Conduction Measuring Setup.....	41
APPENDIX 1 : OCCUPIED EMISSION BANDWIDTH PLOTTED DATA	42
APPENDIX 2 : EMISSION MASK PLOTTED DATA	49
APPENDIX 3 : PLOTTED DATAS OF POWER LINE CONDUCTED EMISSIONS	56

1 GENERAL INFORMATION

1.1 Product Description

- a) Type of EUT : Wireless Microphone (Transmitter)
- b) Trade Name : E-J
- c) Model No. : WT-808T
- d) Power Supply : Power Adaptor I/P: AC 100-240V(47-63Hz), 0.15A, Max
O/P: DC5V, 1A, 5W, Max; Battery 1.5Vx2
- e) Frequency Range : 740MHz-806MHz

1.2 Characteristics of Device:

1. Operating Frequency Range: 744-752 MHz, 794-806 MHz
2. Communication System: Single Emission
3. Type of Modulation: FM, 160KF3E (2M+2DK: 2 x 15+2 x 65 x 1=160kHz)
4. Battery: AAA sized 1.5V *2

1.3 Test Methodology

Both Wireless Handheld Transmitter Microphone conducted and radiated testing were performed according to the procedures in chapter 13 of ANSI C63.4 (2003). and section 2.1046, 2.1047, 2.1049, 2.1051, 2.1053, and 2.1055 of Part 2 of CFR 47

1.4 Test Facility

The open area test site and conducted measurement facility used to collect the radiated data is located on the roof top of Building at No. 34, Lin 5, Ding Fu Tsun, Linkou Hsiang, Taipei Hsien, Taiwan, R.O.C.

This site has been fully described in a report submitted to your office, and accepted in a letter dated June. 30, 2004.

2 REQUIREMENTS OF PROVISIONS

2.1 Definition

Intentional radiator:

A device that intentionally generates and emits radio frequency energy by radiation or induction.

2.2 Frequencies Available

According to sec. 74.802 of Part 74, the following frequencies are available for low power auxiliary station :

Frequencies (MHz)

26.100-26.480	455.000-456.000
54.000-72.000	470.000-488.000
76.000-88.000	488.000-494.000
161.625-161.775	614.000-806.000
174.000-216.000	450.000-451.000
944.000-952.000	

2.3 Requirements for Radio Equipment on Certification

(1) RF Output Power

For transmitters, the power output shall be measured at the RF output terminals.

(2) Modulation Characteristics

For Voice Modulated Communication Equipment, a curve or equivalent data showing the frequency response of the audio modulating circuit over a range of 100 to 5000 Hz shall be submitted.

(3) Occupied Bandwidth

For radiotelephone transmitter, other than single sideband or independent sideband transmitter, when modulated by a 2.5kHz tone at an input level 16 dB greater than that necessary to produce 50 percent modulation.

(4) Spurious Emissions at Antenna Terminals

The radio frequency voltage or power generated within the equipment and appearing on a spurious frequency shall be checked at the equipment output terminal when properly loaded with a suitable artificial antenna.

(5) Field Strength of Spurious Emissions

Measurements shall be made to detect spurious emission that may be radiated directly from the cabinet, control circuits, power leads, or intermediate circuit elements under normal condition of installation and operation.

(6) Frequencies Tolerance

- a) The frequency stability shall be measured with variation of ambient temperature.
- b) The frequency stability shall be measured with variation of primary supply voltage.

2.4 Labeling Requirement

Each equipment for which a type acceptance application is filed on or after May 1,1981, shall bear an identification plate or label pursuant to §.925 (Identification of equipment) and § 2.926 (FCC identifier) .

3 OUTPUT POWER MEASUREMENT

3.1 Provision Applicable

According to §4.861(e)(1)(ii), the output power shall not exceed 250 milliwatts.

3.2 Measurement Procedure

1. Setup the configuration per figure 1 and 2 for frequencies measured below and above 1 GHz respectively, adjusting the input voltage to produce the maximum power.
2. Adjust the analyzer for each frequency measured in chapter 6 on a 1 MHz frequency span and 1MHz resolution bandwidth.
3. The search antenna is to be raised and lowered over a range from 1 to 4 meters in horizontally polarized orientation. Position the highness when the highest value is indicated on spectrum analyzer, then change the orientation of EUT on test table over a range from 0° to 360° , and record the highest value indicated on spectrum analyzer as reference value.
4. Repeat step 3 until all frequencies need to be measured were complete.
5. Repeat step 4 with search antenna in vertical polarized orientations.
6. Replace the EUT with a tuned dipole antenna (horn antenna for above 1 GHz) relative to each frequency in horizontally polarized orientation and as the same polarized orientation with search antenna. Connect the tuned dipole antenna to a standard signal generator (SG) via a low loss cable. Power on the SG and tune the right frequency in measuring as well as set SG at a appreciated output level. Rise and lower the search antenna to get the highest value on spectrum analyzer, and then hold this position. Adjust the SG output to get a identical value derived from step 3 on spectrum analyzer. Record this value for result calculated.
7. Repeat step 6 until all frequencies need to be measured were complete.
8. Repeat step 7 with both dipole antenna (horn antenna for above 1 GHz) and search antenna in vertical polarized orientations.

Figure 1 : Frequencies measured below 1 GHz configuration

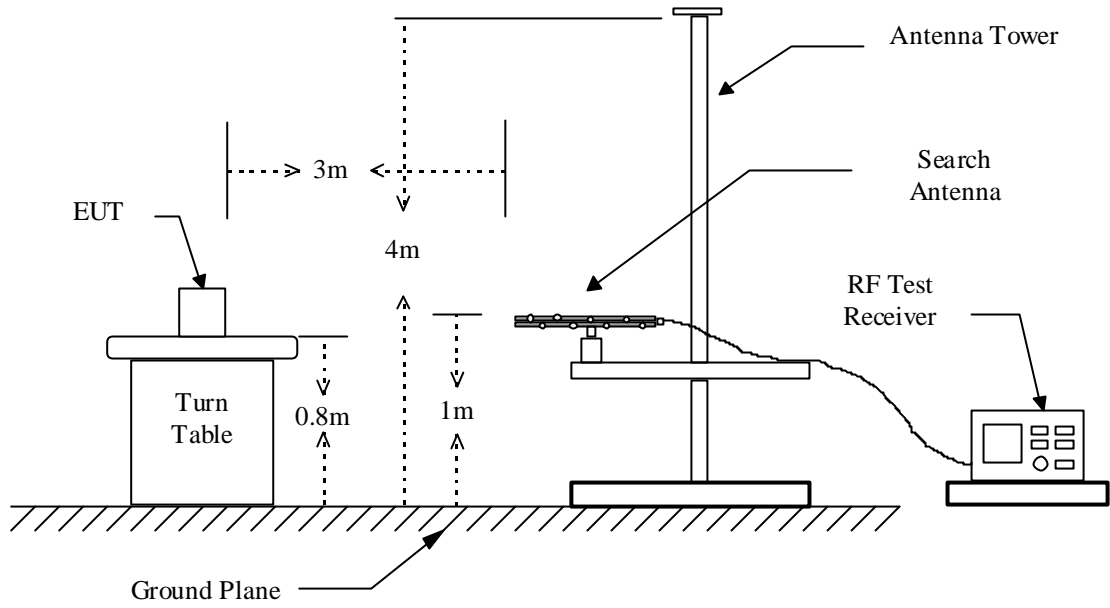
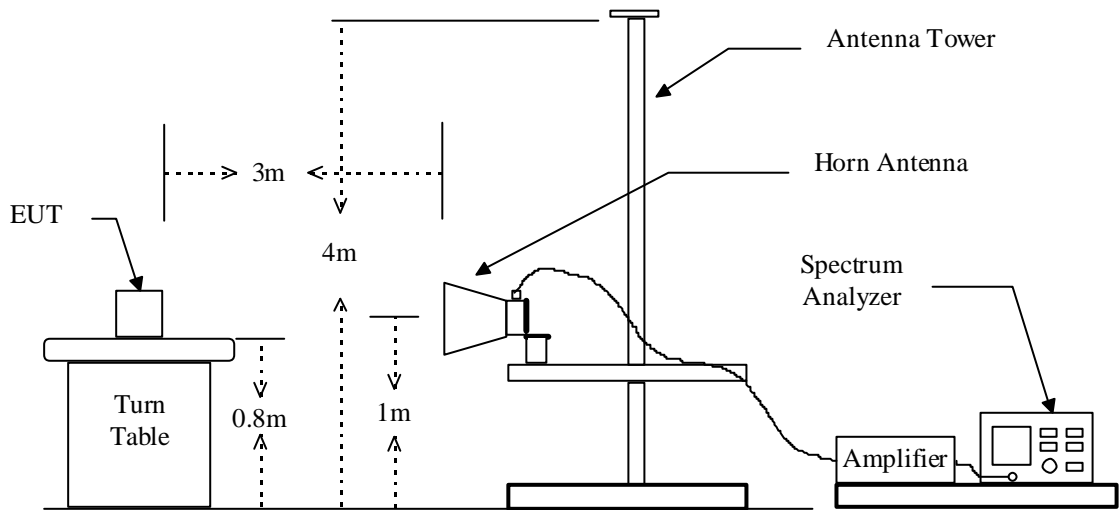

Figure 2 : Frequencies measured above 1 GHz configuration



3.3 Test Data

A) 744.000~752.000 MHz

1. Channel Low (ERP)

Operation Mode : TX Test Date : May 16, 2005

Temperature : 25 °C Humidity : 65 %

Frequency (MHz)	Meter Reading (dB μ V/m)	SG Reading (dBm)	Cable Loss (dB)	Antenna Gain	Result (dBm)	Output Power (mW)	Limit (mW)
744.2096	62.3	-7.7	-2.5	----	-10.2	0.095	250

2. Channel Middle (ERP)

Operation Mode : TX Test Date : May 16, 2005

Temperature : 25 °C Humidity : 65 %

Frequency (MHz)	Meter Reading (dB μ V/m)	SG Reading (dBm)	Cable Loss (dB)	Antenna Gain	Result (dBm)	Output Power (mW)	Limit (mW)
747.8096	62.9	-7.0	-2.5	----	-9.5	0.112	250

3. Channel High (ERP)

Operation Mode : TX Test Date : May 16, 2005

Temperature : 25 °C Humidity : 65 %

Frequency (MHz)	Meter Reading (dB μ V/m)	SG Reading (dBm)	Cable Loss (dB)	Antenna Gain	Result (dBm)	Output Power (mW)	Limit (mW)
751.6096	64.0	-5.9	-2.5	----	-8.4	0.144	250

Note: For measured frequency below 1GHz, a tuned dipole antenna is used.

B) 794.000~806.000 MHz**1. Channel Low (ERP)**Operation Mode : TX Test Date : May 16, 2005Temperature : 25 °C Humidity : 65 %

Frequency (MHz)	Meter Reading (dB μ V/m)	SG Reading (dBm)	Cable Loss (dB)	Antenna Gain	Result (dBm)	Output Power (mW)	Limit (mW)
794.8095	67.8	-2.1	-2.6	----	-4.7	0.338	250

2. Channel Middle (ERP)Operation Mode : TX Test Date : May 16, 2005Temperature : 25 °C Humidity : 65 %

Frequency (MHz)	Meter Reading (dB μ V/m)	SG Reading (dBm)	Cable Loss (dB)	Antenna Gain	Result (dBm)	Output Power (mW)	Limit (mW)
800.4095	67.9	-1.9	-2.6	----	-4.5	0.354	250

3. Channel High (ERP)Operation Mode : TX Test Date : May 16, 2005Temperature : 25 °C Humidity : 65 %

Frequency (MHz)	Meter Reading (dB μ V/m)	SG Reading (dBm)	Cable Loss (dB)	Antenna Gain	Result (dBm)	Output Power (mW)	Limit (mW)
805.3096	67.6	-2.3	-2.6	----	-4.9	0.323	250

Note: For measured frequency below 1GHz, a tuned dipole antenna is used.

3.4 Result Calculation

Result calculation is as following :

Result = SG Reading + Cable Loss + Antenna Gain Corrected

Antenna Gain Corrected : is used for antenna other than dipole to convert radiated power to ERP.

$$\text{mW} = \log^{-1}\left[\frac{\text{Result(dBm)}}{10}\right]$$

3.5 Test Equipment

Equipment	Manufacturer	Model No.	Next Cal. Date
Spectrum Analyzer	R&S	FSP	07/31/2005
Plotter	HP	7440A	N/A
Dipole Antenna	EMCO	3121C	06/06/2005
Signal generator	HP	8656B	11/07/2005

4 MODULATION CHARACTERISTICS

4.1 Provisions Applicable

According to §2.1047 (a), for Voice Modulated Communication Equipment, the frequency response of the audio modulating circuit over a range of 100 to 5000 Hz shall be measured.

4.2 Measurement Method

A) Frequency response of audio circuits

1. Position the EUT as shown in figure 3.
2. Vary the modulating frequency from 100 Hz to 5000 Hz with varying the input voltage from 0V to maximum permitted input voltage, and observe the change in output.

B) Modulation Limit

1. Position the EUT as shown in figure 3, adjust the audio input frequency to 100 Hz and the input level from 0V to maximum permitted input voltage with recording each carrier frequency deviation responding to respective input level.
2. Repeat step 1 with changing the input frequency for 200, 500, 1000, 3000, and 5000 Hz in sequence.

C) Frequency response of all circuits

1. Position the EUT as shown in figure 3.
2. Vary the modulating frequency from 100 Hz to 15000 Hz with constant input voltage (derived from 5.4(a) of this test report), and observe the change in output.

Figure 3 : Modulation characteristic measurement configuration

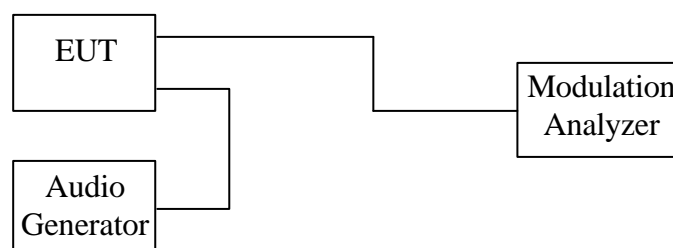

4.3 Measurement Instrument

Equipment	Manufacturer	Model No.	Next Cal. Date
Modulation Analyzer	Hewlett-Packard	8901A	11/30/2005
Multifunction Synthesizer	Hewlett-Packard	8904A	12/23/2005
Oscilloscope	Lecroy	9350A	06/01/2005
Preamplifier	Hewlett-Packard	8447D	08/12/2005
Spectrum	Advantest	R3361C	08/10/2005

4.4 Measurement Result

1. 744.000~752.000 MHz

A). Frequency response

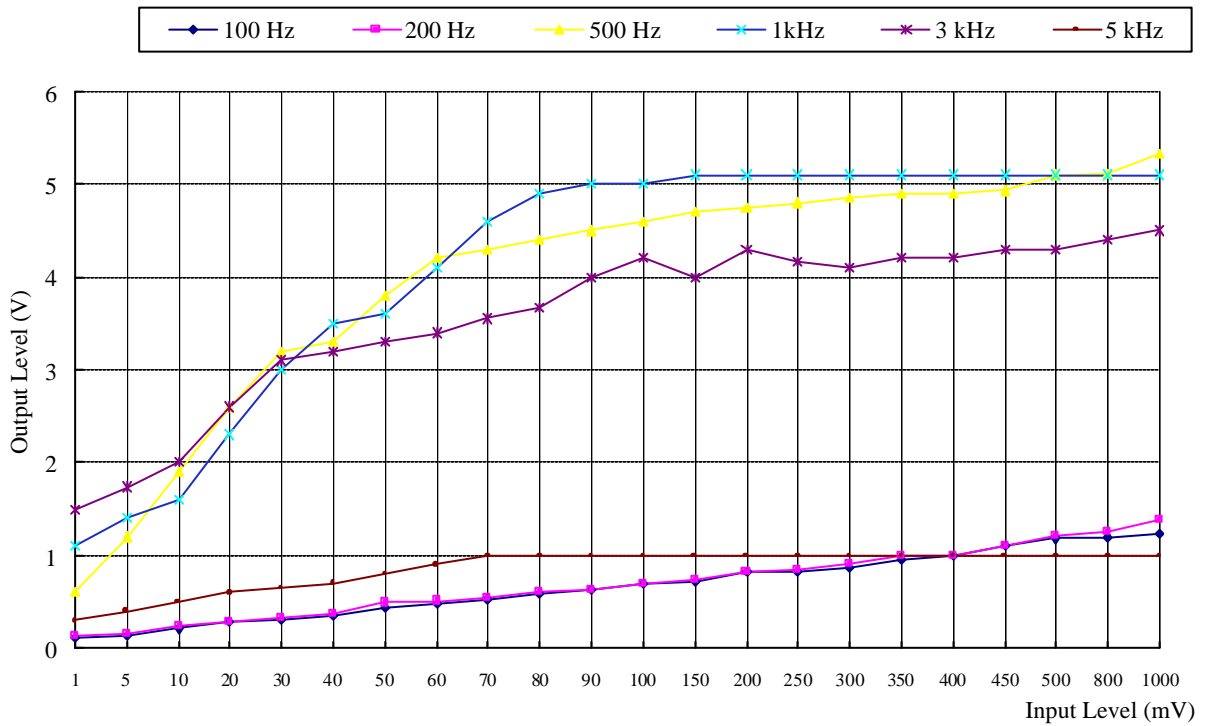

B). Modulation Limit

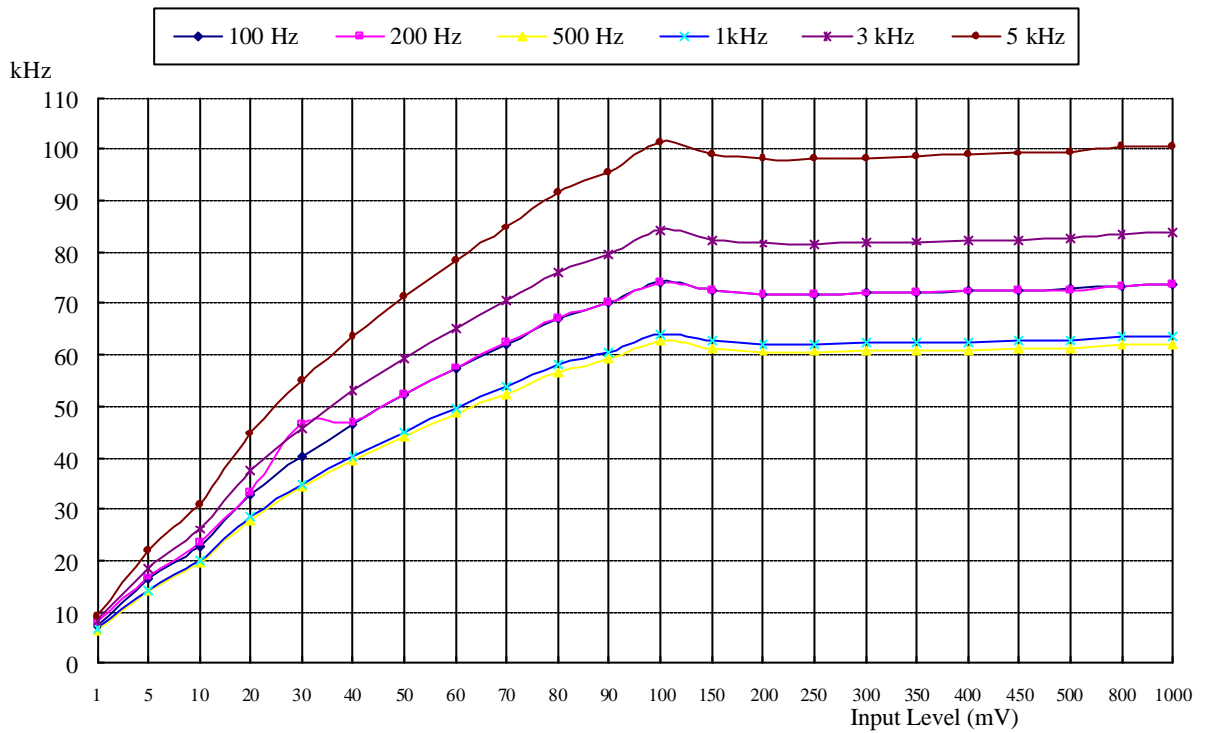

C). Frequency response of all circuits

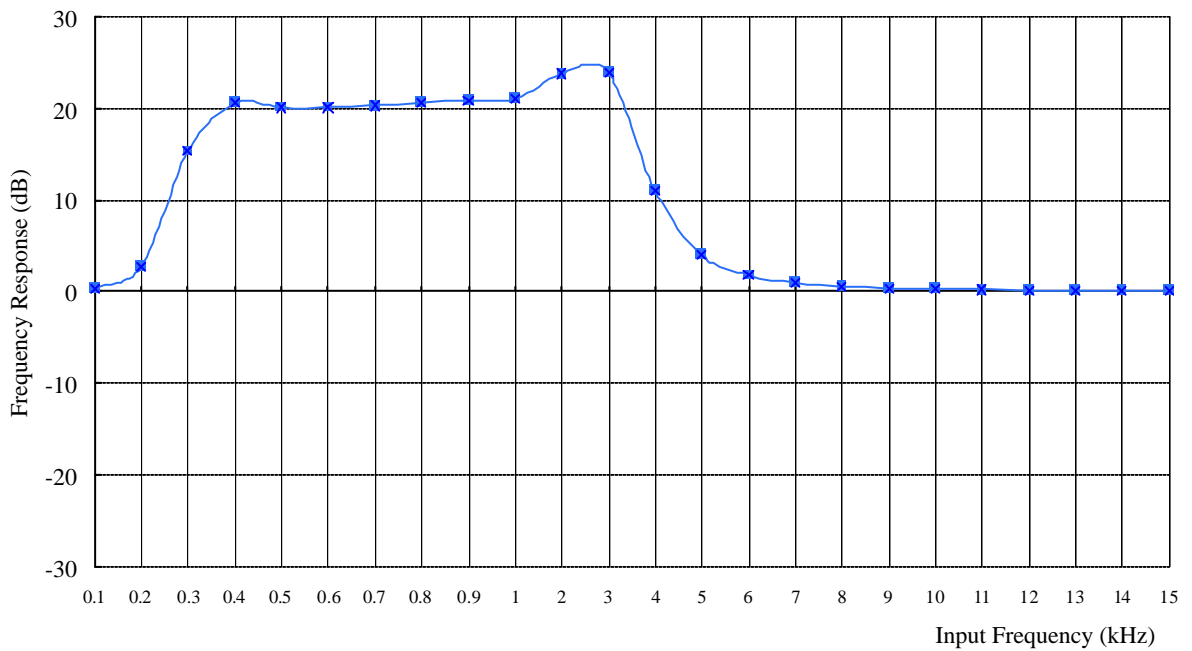

2. 794.000~806.000 MHz

A). Frequency response

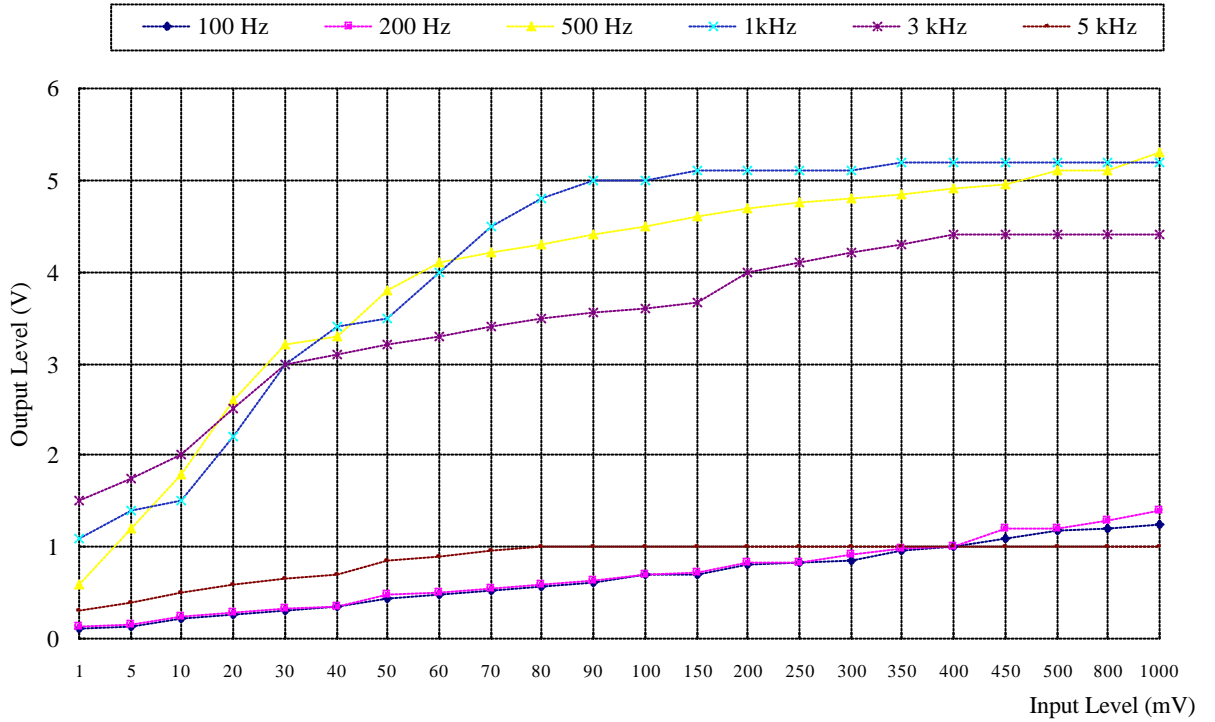

B). Modulation Limit

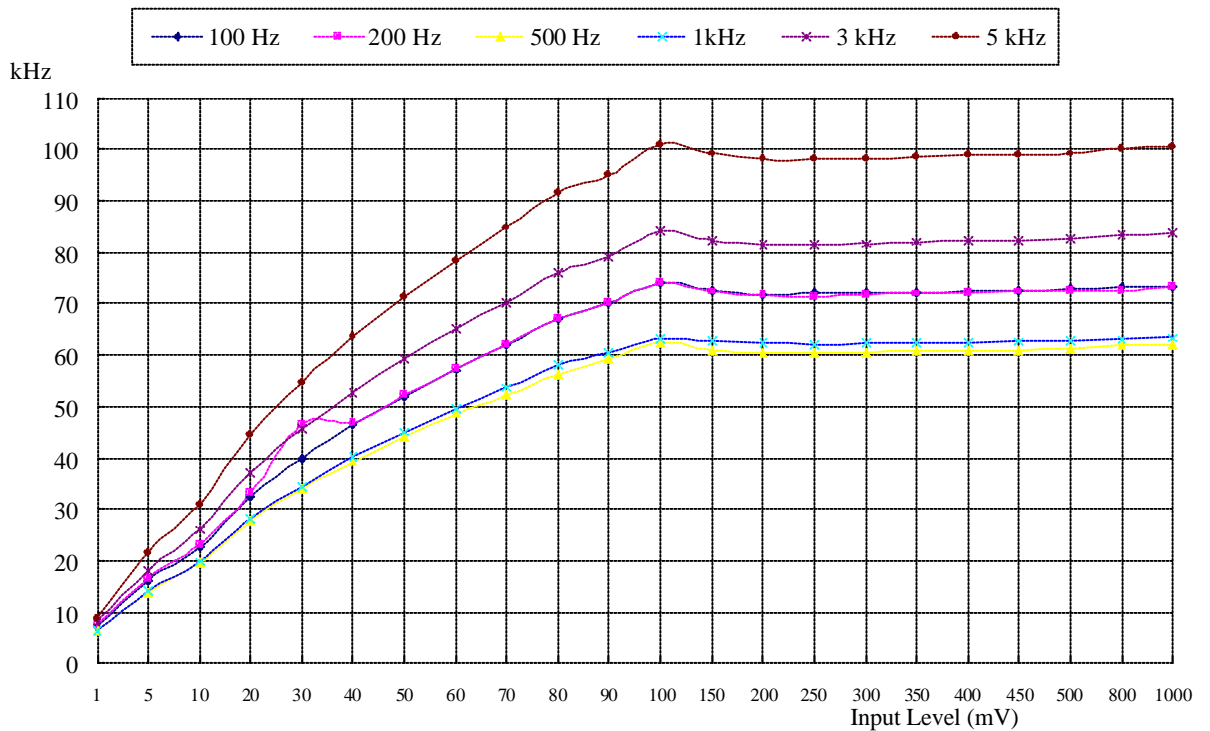

C). Frequency response of all circuits

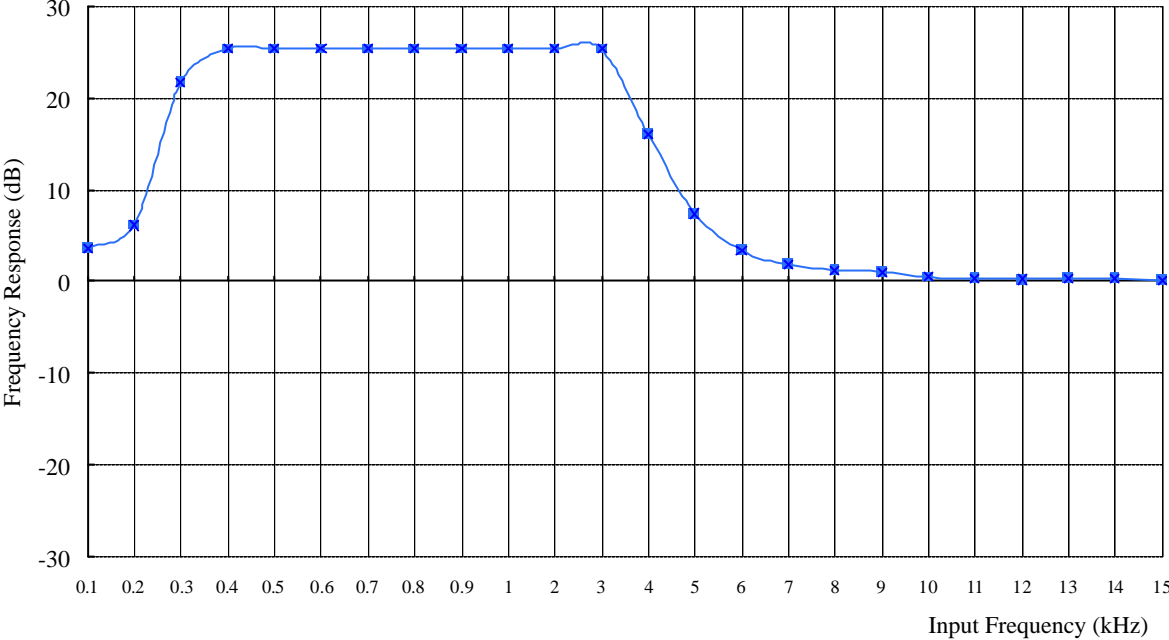

5 OCCUPIED BANDWIDTH OF EMISSION

5.1 Provisions Applicable

According to §2.1049(c)(1), For radiotelephone transmitter, other than single sideband or indenpent sideband transmitter, when modulateed by a 2.5kHz tone at an input level 16 dB greater than that necessary to produce 50 percent modulation.

According to §4.861(e)(5), the frequency emission bandwidth shall not exceed 200 kHz.

5.2 Measurement Method

1. Check the calibration of the measuring instrument using either an internal calibrator or a known signal from an external generator.
2. Position the EUT as shown in figure 4, and Install new batteries in the EUT. Turn on the EUT ant set it to any one convenient frequency within its operating range. Set a reference level on the measuring instrument equal to the highest peak value.
3. Apply a 2.5 kHz modulation signal to EUT and measure the frequencies of the modulated signal from the EUT where it is the specified number of dB below the reference level set in step 2. This is the occupied bandwidth specified.

Figure 4 : Occupied bandwidth measurement configuration

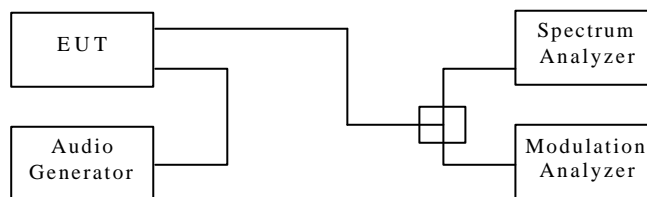

5.3 Occupied Bandwidth Test Equipment

Equipment	Manufacturer	Model No.	Next Cal. Date
Spectrum Analyzer	R&S	FSP	07/31/2005
Modulation Analyzer	Hewlett-Packard	8901A	11/30/2005
Multifunction Synthesizer	Hewlett-Packard	8904A	12/23/2005
Plotter	Hewlett-Packard	7440A	N/A

5.4 Bandwidth Measured

5.4.1 Input Level Derived

1. 744.000~752.000 MHz

Input Audio Frequency : 2.5 kHz, Sine Wave

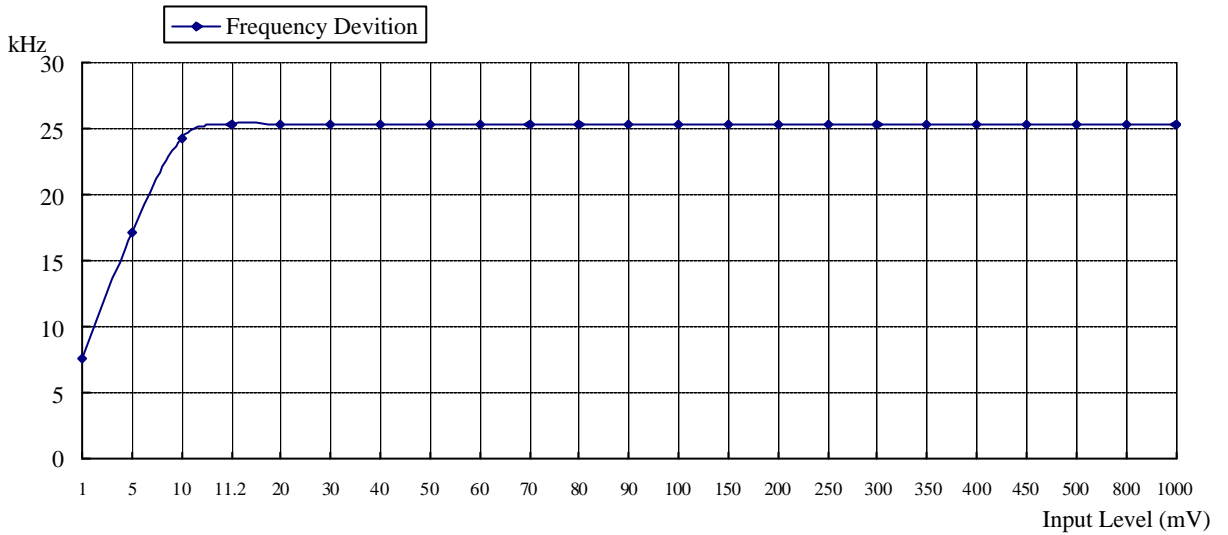

The Level input to produce 50 % modulation is 5.6 mV, therefore the magnitude 16 dB greater than it is 223 mV.

2. 740.000~752.000 MHz

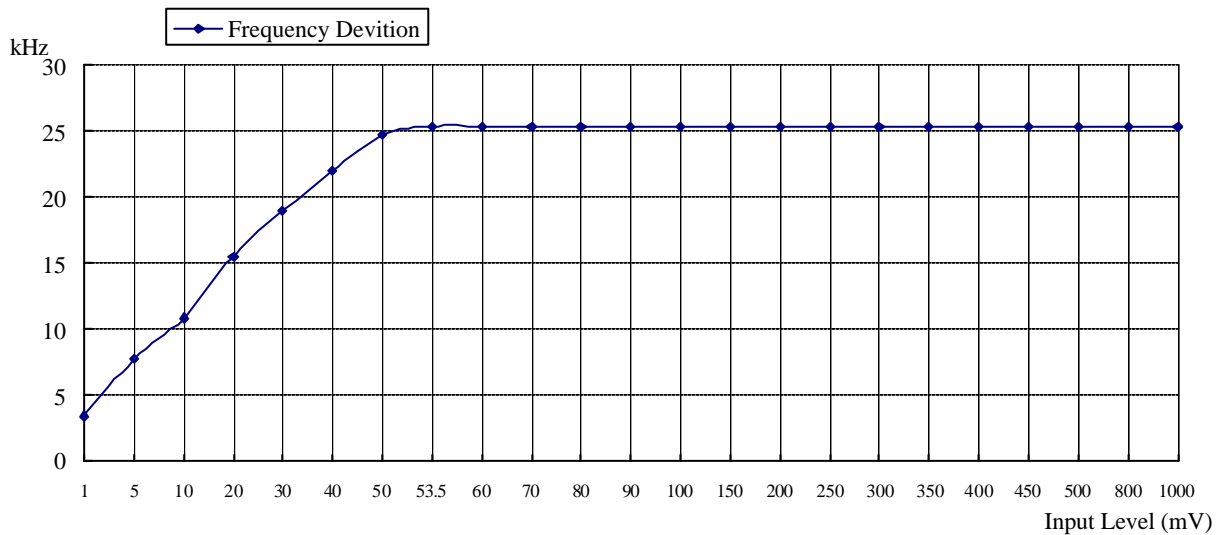

The Level input to produce 50 % modulation is 26.75 mV, therefore the magnitude 16 dB greater than it is 1.064 V.

5.4.2 Occupied Bandwidth Plotted

1. 744.000~752.000 MHz

The Channel Low 26 dB Bandwidth is 176.5KHz.

The Channel Mid 26 dB Bandwidth is 182.5KHz.

The Channel High 26 dB Bandwidth is 189.5KHz.

2. 794.000~806.000 MHz

The Channel Low 26 dB Bandwidth is 185.0KHz.

The Channel Mid 26 dB Bandwidth is 192.0KHz.

The Channel High 26 dB Bandwidth is 195.5KHz.

Please see appendix 1 for plotted data.

6 FIELD STRENGTH OF EMISSION

6.1 Provisions Applicable

According to §1053, measurements shall be made to detect spurious emission that may be radiated directly from the cabinet, control circuits, power leads, or intermediate circuit elements under normal condition of installation and operation. Information submitted shall include the relative radiated power of spurious emission with reference to the rated power output of the transmitter, assuming all emissions are radiated from a halfwave dipole antenna.

According to §4.861(e)(6), the mean power of emissions shall be attenuated below the mean output power of the transmitter in accordance with the following schedule:

- (i) on any frequency removed from the operating frequency by more than 50 percent up to and including 100 percent of the authorized bandwidth: at least 25 dB.
- (ii) on any frequency removed from the operating frequency by more than 100 percent up to and including 250 percent of the authorized bandwidth: at least 35 dB.
- (iii) on any frequency removed from the operating frequency by more than 250 percent of the authorized bandwidth shall be attenuated below the unmodulated carrier by at least 43 plus $10 \text{ Log}(\text{output power in watts})$ dB.

6.2 Measurement Procedure

1. Setup the configuration per figure 1 and 2 for frequencies measured below and above 1 GHz respectively, adjusting the input voltage to produce the maximum power as measured in chapter 3.
2. Adjust the analyzer for each frequency measured in chapter 6 on a 1 MHz frequency span and 1MHz resolution bandwidth.
3. The search antenna is to be raised and lowered over a range from 1 to 4 meters in horizontally polarized orientation. Position the highness when the highest value is indicated on spectrum analyzer, then change the orientation of EUT on test table over a range from 0° to 360° , and record the highest value indicated on spectrum analyzer as reference value.
4. Repeat step 3 until all frequencies need to be measured were complete.
5. Repeat step 4 with search antenna in vertical polarized orientations.
6. Replace the EUT with a tuned dipole antenna (horn antenna for above 1 GHz) relative to each frequency in horizontally polarized orientation and as the same polarized orientation with search antenna. Connect the tuned dipole antenna to a standard signal generator (SG) via a low loss cable. Power on the SG and tune the right frequency in measuring as well as set SG at a appreciated output level. Rise and lower the search antenna to get the highest value on spectrum analyzer, and then hold this position. Adjust the SG output to get a identical value derived from step 3 on spectrum analyzer. Record this value for result calculated.

7. Repeat step 6 until all frequencies need to be measured were complete.
8. Repeat step 7 with both dipole antenna (horn antenna for above 1 GHz) and search antenna in vertical polarized orientations.

6.3 Measuring Instrument

Equipment	Manufacturer	Model No.	Next Cal. Date
Spectrum Analyzer	Hewlett-Packard	8564E	08/11/2005
Horn Antenna	EMCO	3115	08/26/2005
Log periodic Antenna	EMCO	3146	10/05/2005
Biconical Antenna	EMCO	3110B	10/05/2005
Preamplifier	Hewlett-Packard	8449B	09/07/2005
Preamplifier	Hewlett-Packard	8447D	08/12/2005

Measuring instrument setup in frequency band measured is as following :

Frequency Band (MHz)	Instrument	Function	Resolution bandwidth	Video Bandwidth
30 to 1000	Spectrum Analyzer	Peak	100 kHz	100 kHz
Above 1000	Spectrum Analyzer	Peak	1 MHz	1 MHz

6.4 Measuring Data

A) 744.000~752.000 MHz

1. Channel 1

Operation Mode : TX Test Date : May 16, 2005

Temperature : 25 °C Humidity : 65 %

Unmodulated carrier output power is -10.2 dBm , or 0.095 mW (ERP).

The limit of spurious or harmonics is calculated as following :

$$-10.2-[43+10\log(\text{carrier output power in W})], \text{ or } -13\text{dBm}$$

Frequency (MHz)	Meter Reading (dBuV)		SG Reading (dBm)		Antenna Gain	Antenna Gain Corr'	Cable Loss (dB)	Result (dBm)		Limit (dBm)	Margin (dB)
	H	V	H	V				H	V		
1488.419	---	---	---	---	7.3	-2.0	1.3	---	---	-13.0	---
2232.629	---	---	---	---	9.4	-2.0	1.7	---	---	-13.0	---
2976.838	---	---	---	---	9.6	-2.0	1.7	---	---	-13.0	---
3721.048	---	---	---	---	9.6	-2.0	2.1	---	---	-13.0	---
4465.257	---	---	---	---	10.6	-2.0	2.1	---	---	-13.0	---
5209.467	---	---	---	---	10.9	-2.0	2.1	---	---	-13.0	---
5953.676	---	---	---	---	11.7	-2.0	2.6	---	---	-13.0	---
6697.886	---	---	---	---	12.1	-2.0	2.6	---	---	-13.0	---
7442.095	---	---	---	---	11.6	-2.0	2.9	---	---	-13.0	---

Note :

1. Remark “---“ means that the emission level is too weak to be detected.
2. For measured frequency below 1GHz, a tuned dipole antenna is used.
3. Result calculation is as following :

$$\text{Result} = \text{SG Reading} + \text{Cable Loss} + \text{Antenna Gain} + \text{Antenna Gain Corrected}$$
 Antenna Gain Corrected : is used for antenna other than dipole to convert radiated power to ERP.
4. Spurious or harmonics above 1 GHz is too low to be detected or attenuated more than 60 dB from limit value.

2. Channel 8

Operation Mode : TX Test Date : May 16, 2005
 Temperature : 25 °C Humidity : 65 %

Unmodulated carrier output power is -9.5 dBm , or 0.112 mW (ERP).

The limit of spurious or harmonics is calculated as following :

$$-9.5-[43+10\log(\text{carrier output power in W})], \text{ or } -13\text{dBm}$$

Frequency (MHz)	Meter Reading (dBuV)		SG Reading (dBm)		Antenna Gain	Antenna Gain Corr'	Cable Loss (dB)	Result (dBm)		Limit (dBm)	Margin (dB)
	H	V	H	V				H	V		
1495.619	---	---	---	---	9.1	-2.0	1.3	---	---	-13.0	---
2243.429	---	---	---	---	9.4	-2.0	1.7	---	---	-13.0	---
2991.238	---	---	---	---	9.7	-2.0	1.7	---	---	-13.0	---
3739.048	---	---	---	---	9.6	-2.0	2.1	---	---	-13.0	---
4486.857	---	---	---	---	10.9	-2.0	2.1	---	---	-13.0	---
5234.667	---	---	---	---	10.9	-2.0	2.1	---	---	-13.0	---
5982.476	---	---	---	---	11.0	-2.0	2.6	---	---	-13.0	---
6730.286	---	---	---	---	12.1	-2.0	2.6	---	---	-13.0	---
7478.095	---	---	---	---	11.6	-2.0	2.9	---	---	-13.0	---

Note :

1. Remark “---“ means that the emission level is too weak to be detected.
2. For measured frequency below 1GHz, a tuned dipole antenna is used.
3. Result calculation is as following :
 Result = SG Reading +Cable Loss +Antenna Gain +Antenna Gain Corrected
 Antenna Gain Corrected : is used for antenna other than dipole to convert radiated power to ERP.
4. Spurious or harmonics above 1 GHz is too low to be detected or attenuated more than 60 dB from limit value.

3. Channel 16

Operation Mode : TX Test Date : May 16, 2005
 Temperature : 25 °C Humidity : 65 %

Unmodulated carrier output power is -8.4 dBm , or 0.144 mW (ERP).

The limit of spurious or harmonics is calculated as following :

$$-8.4 - [43 + 10 \log(\text{carrier output power in W})], \text{ or } -13 \text{ dBm}$$

Frequency (MHz)	Meter Reading (dBuV)		SG Reading (dBm)		Antenna Gain	Antenna Gain Corr'	Cable Loss (dB)	Result (dBm)		Limit (dBm)	Margin (dB)
	H	V	H	V				H	V		
1503.219	---	---	---	---	9.1	-2.0	1.3	---	---	-13.0	---
2254.829	---	---	---	---	9.3	-2.0	1.7	---	---	-13.0	---
3006.438	---	---	---	---	9.7	-2.0	1.7	---	---	-13.0	---
3758.048	---	---	---	---	9.6	-2.0	2.1	---	---	-13.0	---
4509.657	---	---	---	---	10.9	-2.0	2.1	---	---	-13.0	---
5261.267	---	---	---	---	10.9	-2.0	2.1	---	---	-13.0	---
6012.876	---	---	---	---	11.9	-2.0	2.5	---	---	-13.0	---
6764.486	---	---	---	---	11.8	-2.0	2.5	---	---	-13.0	---
7516.095	---	---	---	---	11.5	-2.0	2.9	---	---	-13.0	---

Note :

1. Remark “---“ means that the emission level is too weak to be detected.
2. For measured frequency below 1GHz, a tuned dipole antenna is used.
3. Result calculation is as following :
 Result = SG Reading +Cable Loss +Antenna Gain +Antenna Gain Corrected
 Antenna Gain Corrected : is used for antenna other than dipole to convert radiated power to ERP.
4. Spurious or harmonics above 1 GHz is too low to be detected or attenuated more than 60 dB from limit value.

B) 794.000~806.000 MHz**1. Channel 3**

Operation Mode : TX Test Date : May 16, 2005
 Temperature : 25 °C Humidity : 65 %

Unmodulated carrier output power is -4.7 dBm , or 0.338 mW (ERP).

The limit of spurious or harmonics is calculated as following :

$$-4.7 - [43 + 10 \log(\text{carrier output power in W})], \text{ or } -13 \text{ dBm}$$

Frequency (MHz)	Meter Reading (dBuV)		SG Reading (dBm)		Antenna Gain	Antenna Gain Corr'	Cable Loss (dB)	Result (dBm)		Limit (dBm)	Margin (dB)
	H	V	H	V				H	V		
1589.619	---	---	---	---	7.3	-2.0	1.3	---	---	-13.0	---
2384.429	---	---	---	---	9.4	-2.0	1.7	---	---	-13.0	---
3179.238	---	---	---	---	9.6	-2.0	1.7	---	---	-13.0	---
3974.048	---	---	---	---	9.6	-2.0	2.1	---	---	-13.0	---
4768.857	---	---	---	---	10.6	-2.0	2.1	---	---	-13.0	---
5563.667	---	---	---	---	10.9	-2.0	2.1	---	---	-13.0	---
6358.476	---	---	---	---	11.7	-2.0	2.6	---	---	-13.0	---
7153.286	---	---	---	---	12.1	-2.0	2.6	---	---	-13.0	---
7948.095	---	---	---	---	11.6	-2.0	2.9	---	---	-13.0	---

Note :

1. Remark “---“ means that the emission level is too weak to be detected.
2. For measured frequency below 1GHz, a tuned dipole antenna is used.
3. Result calculation is as following :
 Result = SG Reading +Cable Loss +Antenna Gain +Antenna Gain Corrected
 Antenna Gain Corrected : is used for antenna other than dipole to convert radiated power to ERP.
4. Spurious or harmonics above 1 GHz is too low to be detected or attenuated more than 60 dB from limit value.

2. Channel 10

Operation Mode : TX Test Date : May 16, 2005
 Temperature : 25 °C Humidity : 65 %

Unmodulated carrier output power is -4.5 dBm , or 0.354 mW (ERP).

The limit of spurious or harmonics is calculated as following :

$$-4.5 - [43 + 10 \log(\text{carrier output power in W})], \text{ or } -13 \text{ dBm}$$

Frequency (MHz)	Meter Reading (dBuV)		SG Reading (dBm)		Antenna Gain	Antenna Gain Corr'	Cable Loss (dB)	Result (dBm)		Limit (dBm)	Margin (dB)
	H	V	H	V				H	V		
1600.819	---	---	---	---	9.1	-2.0	1.3	---	---	-13.0	---
2401.229	---	---	---	---	9.4	-2.0	1.7	---	---	-13.0	---
3201.638	---	---	---	---	9.7	-2.0	1.7	---	---	-13.0	---
4002.048	---	---	---	---	9.6	-2.0	2.1	---	---	-13.0	---
4802.457	---	---	---	---	10.9	-2.0	2.1	---	---	-13.0	---
5602.867	---	---	---	---	10.9	-2.0	2.1	---	---	-13.0	---
6403.276	---	---	---	---	11.0	-2.0	2.6	---	---	-13.0	---
7203.686	---	---	---	---	12.1	-2.0	2.6	---	---	-13.0	---
8004.095	---	---	---	---	11.6	-2.0	2.9	---	---	-13.0	---

Note :

1. Remark “---“ means that the emission level is too weak to be detected.
2. For measured frequency below 1GHz, a tuned dipole antenna is used.
3. Result calculation is as following :
 Result = SG Reading +Cable Loss +Antenna Gain +Antenna Gain Corrected
 Antenna Gain Corrected : is used for antenna other than dipole to convert radiated power to ERP.
4. Spurious or harmonics above 1 GHz is too low to be detected or attenuated more than 60 dB from limit value.

3. Channel High

Operation Mode : TX Test Date : May 16, 2005
 Temperature : 25 °C Humidity : 65 %

Unmodulated carrier output power is -4.9 dBm , or 0.323 mW (ERP).

The limit of spurious or harmonics is calculated as following :

$$-4.9 - [43 + 10 \log(\text{carrier output power in W})], \text{ or } -13 \text{ dBm}$$

Frequency (MHz)	Meter Reading (dBuV)		SG Reading (dBm)		Antenna Gain	Antenna Gain Corr'	Cable Loss (dB)	Result (dBm)		Limit (dBm)	Margin (dB)
	H	V	H	V				H	V		
1610.619	---	---	---	---	9.1	-2.0	1.3	---	---	-13.0	---
2415.929	---	---	---	---	9.3	-2.0	1.7	---	---	-13.0	---
3221.238	---	---	---	---	9.7	-2.0	1.7	---	---	-13.0	---
4026.548	---	---	---	---	9.6	-2.0	2.1	---	---	-13.0	---
4831.857	---	---	---	---	10.9	-2.0	2.1	---	---	-13.0	---
5637.167	---	---	---	---	10.9	-2.0	2.1	---	---	-13.0	---
6442.476	---	---	---	---	11.9	-2.0	2.5	---	---	-13.0	---
7247.786	---	---	---	---	11.8	-2.0	2.5	---	---	-13.0	---
8053.095	---	---	---	---	11.5	-2.0	2.9	---	---	-13.0	---

Note :

1. Remark “---“ means that the emission level is too weak to be detected.
2. For measured frequency below 1GHz, a tuned dipole antenna is used.
3. Result calculation is as following :
 Result = SG Reading +Cable Loss +Antenna Gain +Antenna Gain Corrected
 Antenna Gain Corrected : is used for antenna other than dipole to convert radiated power to ERP.
4. Spurious or harmonics above 1 GHz is too low to be detected or attenuated more than 60 dB from limit value.

C. Emission mask plots

Please see appendix 2 for plotted data.

D. Other Emission**1. 744.000-752.000MHz**

a) Emission frequencies below 1 GHz

Test Date : May 19, 2005 Temperature : 25 °C Humidity : 65 %

Frequency (MHz)	Ant-Pol H/V	Meter Reading (dBuV)	Corrected Factor (dB)	Result @3m (dBuV/m)	Limit @3m (dBuV/m)	Margin (dB)	Table Degree (Deg.)	Ant. High (m)
35.400	V	40.3	-10.9	29.4	40.0	-10.6	188	1.0
43.500	V	44.2	-12.6	31.6	40.0	-8.4	192	1.0
96.960	V	36.5	-13.9	22.6	43.5	-20.9	179	1.0
528.200	V	34.1	-5.0	29.1	46.0	-16.9	189	1.0
680.100	H	33.0	-1.0	32.0	46.0	-14.0	77	1.5
843.900	H	36.6	2.0	38.6	46.0	-7.4	179	1.5

Note :

1. Remark "---" means that the emissions level is too low to be measured.
2. The expanded uncertainty of the radiated emission tests is 3.53 dB.

b) Emission frequencies above 1 GHz

Radiated emission frequencies above 1 GHz to 5 GHz were too low to be measured with a pre-amplifier of 35 dB.

2. 794.000-806.000MHz

a) Emission frequencies below 1 GHz

Test Date : May 19, 2005 Temperature : 25 °C Humidity : 65 %

Frequency (MHz)	Ant-Pol H/V	Meter Reading (dBuV)	Corrected Factor (dB)	Result @3m (dBuV/m)	Limit @3m (dBuV/m)	Margin (dB)	Table Degree (Deg.)	Ant. High (m)
33.780	V	47.8	-10.6	37.2	40.0	-2.8	188	1.0
41.880	V	47.6	-12.2	35.4	40.0	-4.6	192	1.0
123.690	V	34.1	-11.1	23.0	43.5	-20.5	175	1.0
507.900	V	32.8	-4.6	28.2	46.0	-17.8	194	1.0
680.100	H	34.0	-1.0	33.0	46.0	-13.0	92	1.5
748.820	V	32.9	-0.3	32.6	46.0	-13.4	192	1.0

Note :

1. Remark "---" means that the emissions level is too low to be measured.
2. The expanded uncertainty of the radiated emission tests is 3.53 dB.

b) Emission frequencies above 1 GHz

Radiated emission frequencies above 1 GHz to 5 GHz were too low to be measured with a pre-amplifier of 35 dB.

6.5 Radiated Measurement Photos

Mode: Tx



Mode: Charge Tx



7 FREQUENCY STABILITY MEASUREMENT

7.1 Provisions Applicable

According to §.1055 (a)(1), the frequency stability shall be measured with variation of ambient temperature from -30°C to +50°C centigrade, and according to §.1055 (d)(2), the frequency stability shall be measured with reducing primary supply voltage to the battery operating end point which is specified by the manufacturer.

According to §4.861(e)(4), the frequency tolerance of the transmitter shall be 0.005 percent.

7.2 Measurement Procedure

A) Frequency stability versus environmental temperature

1. Setup the configuration per figure 5 for frequencies measured at ambient temperature if it is within 15°C to 25°C. Otherwise, an environmental chamber set for a temperature of 20°C shall be used. Install new batteries in the EUT.
2. Turn on EUT and set SA center frequency to the right frequency needs to be measured. Then set SA RBW to 30 kHz, VBW to 100kHz and frequency span to 500 kHz. Record this frequency to be a reference.
3. Set the temperature of chamber to 50°C. Allow sufficient time (approximately 30 min) for the temperature of the chamber to stabilize. While maintaining a constant temperature inside the chamber, turn the EUT on and measure the EUT operating frequency.
4. Repeat step 2 with a 10°C decreased per stage until the lowest temperature -30°C is measured, record all measurement frequencies.

B) Frequency stability versus input voltage

1. Setup the configuration per figure 7 for frequencies measured at ambient temperature if it is within 15°C to 25°C. Otherwise, an environmental chamber set for a temperature of 20°C shall be used. Install new batteries in the EUT.

2. Set SA center frequency to the right frequency needs to be measured. Then set SA RBW to 30 kHz, VBW to 100kHz and frequency span to 500 kHz. Record this frequency to be a reference.
3. For battery operated only device, supply the EUT primary voltage at the battery operating end point which is specified by the manufacturer and record the frequency.

Figure 5 : Frequency stability measurement configuration

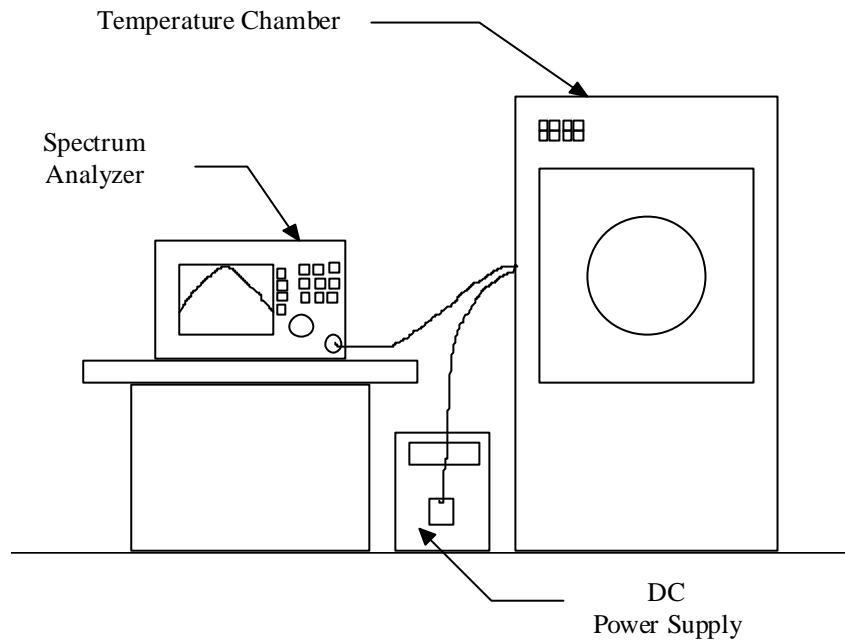

7.3 Measurement Instrument

Equipment	Manufacturer	Model No.	Next Cal. Date
Spectrum Analyzer	HP	8564E	08/11/2005
Temperature Chamber	MALLIER	MCT-2X-M	11/01/2005

7.4 Measurement Data

A1. Frequency stability versus environment temperature

Reference Frequency : 744.2095 MHz Limit : 0.005%							
Environment Temperature (°C)	Power Supplied (Vdc)	Frequency measured with time elapsed					
		2 minute		5 minute		10 minute	
		(MHz)	(%)	(MHz)	(%)	(MHz)	(%)
50	New Batt.	744.2110	0.00021	744.2016	-0.00106	744.2052	-0.00058
40		744.2110	0.00020	744.1948	-0.00198	744.1812	-0.00380
30		744.2157	0.00084	744.2258	0.00219	744.2075	-0.00027
20		744.1914	-0.00244	744.2092	-0.00004	744.2123	0.00038
10		744.2107	0.00016	744.1852	-0.00326	744.1992	-0.00139
0		744.1892	-0.00272	744.2102	0.00010	744.2159	0.00085
-10		744.2300	0.00275	744.2272	0.00238	744.1943	-0.00204
-20		744.2145	0.00067	744.2243	0.00198	744.2256	0.00216
-30		744.2264	0.00228	744.2340	0.00329	744.2277	0.00245

A2. Frequency stability versus end-point supplied voltage (2Vdc)

Reference Frequency : 744.2095 MHz Limit : 0.005%							
Environment Temperature (°C)	Power Supplied (Vdc)	Frequency measured with time elapsed					
		2 minute		5 minute		10 minute	
		(MHz)	(%)	(MHz)	(%)	(MHz)	(%)
25	End-Point	744.2292	0.00265	744.2248	0.00206	744.2256	0.00216

B1. Frequency stability versus environment temperature

Reference Frequency : 747.8095 MHz		Limit : 0.005%					
Environment Temperature (°C)	Power Supplied (Vdc)	Frequency measured with time elapsed					
		2 minute		5 minute		10 minute	
		(MHz)	(%)	(MHz)	(%)	(MHz)	(%)
50	New Batt.	747.7873	-0.00296	747.8361	0.00356	747.7911	-0.00245
40		747.8009	-0.00116	747.8210	0.00154	747.8236	0.00188
30		747.8196	0.00135	747.8311	0.00289	747.8330	0.00315
20		747.7932	-0.00218	747.8380	0.00381	747.8073	-0.00030
10		747.8357	0.00350	747.7919	-0.00235	747.7832	-0.00351
0		747.8251	0.00208	747.8315	0.00295	747.8040	-0.00073
-10		747.8307	0.00284	747.8348	0.00338	747.8176	0.00108
-20		747.7856	-0.00319	747.8028	-0.00090	747.7841	-0.00340
-30		747.8327	0.00310	747.8070	-0.00033	747.8356	0.00349

B2. Frequency stability versus end-point supplied voltage (2Vdc)

Reference Frequency : 747.8095 MHz		Limit : 0.005%					
Environment Temperature (°C)	Power Supplied (Vdc)	Frequency measured with time elapsed					
		2 minute		5 minute		10 minute	
		(MHz)	(%)	(MHz)	(%)	(MHz)	(%)
25	End-Point	747.7909	-0.00249	747.8192	0.00130	747.8122	0.00036

C1. Frequency stability versus environment temperature

Reference Frequency : 751.6095 MHz		Limit : 0.005%					
Environment Temperature (°C)	Power Supplied (Vdc)	Frequency measured with time elapsed					
		2 minute		5 minute		10 minute	
		(MHz)	(%)	(MHz)	(%)	(MHz)	(%)
50	New Batt.	751.5846	-0.00331	751.6152	0.00076	751.6277	0.00242
40		751.6368	0.00363	751.6053	-0.00056	751.6192	0.00129
30		751.6059	-0.00047	751.6160	0.00087	751.5828	-0.00355
20		751.6191	0.00128	751.5837	-0.00343	751.6013	-0.00110
10		751.6326	0.00308	751.6144	0.00066	751.5865	-0.00305
0		751.6234	0.00185	751.5980	-0.00153	751.6376	0.00374
-10		751.6140	0.00060	751.6310	0.00286	751.6160	0.00086
-20		751.5824	-0.00361	751.5888	-0.00275	751.6304	0.00278
-30		751.5878	-0.00289	751.6183	0.00117	751.6044	-0.00068

C2. Frequency stability versus end-point supplied voltage (2Vdc)

Reference Frequency : 751.6095 MHz		Limit : 0.005%					
Environment Temperature (°C)	Power Supplied (Vdc)	Frequency measured with time elapsed					
		2 minute		5 minute		10 minute	
		(MHz)	(%)	(MHz)	(%)	(MHz)	(%)
25	End-Point	751.5958	-0.00182	751.6044	-0.00067	751.6110	0.00021

D1. Frequency stability versus environment temperature

Reference Frequency : 794.8095 MHz		Limit : 0.005%					
Environment Temperature (°C)	Power Supplied (Vdc)	Frequency measured with time elapsed					
		2 minute		5 minute		10 minute	
		(MHz)	(%)	(MHz)	(%)	(MHz)	(%)
50	New Batt.	794.8081	-0.00017	794.8285	0.00239	794.7913	-0.00230
40		794.8013	-0.00103	794.8252	0.00197	794.8251	0.00196
30		794.7990	-0.00132	794.8011	-0.00106	794.8374	0.00351
20		794.8326	0.00290	794.8009	-0.00108	794.8176	0.00103
10		794.8185	0.00113	794.7926	-0.00213	794.8215	0.00151
0		794.7993	-0.00129	794.7857	-0.00299	794.8028	-0.00084
-10		794.8037	-0.00073	794.8195	0.00126	794.7984	-0.00140
-20		794.7977	-0.00149	794.8078	-0.00022	794.8313	0.00274
-30		794.7869	-0.00284	794.8335	0.00302	794.7946	-0.00188

D2. Frequency stability versus end-point supplied voltage (2Vdc)

Reference Frequency : 794.8095 MHz		Limit : 0.005%					
Environment Temperature (°C)	Power Supplied (Vdc)	Frequency measured with time elapsed					
		2 minute		5 minute		10 minute	
		(MHz)	(%)	(MHz)	(%)	(MHz)	(%)
25	End-Point	794.8238	0.00180	794.7900	-0.00245	794.7824	-0.00341

E1. Frequency stability versus environment temperature

Reference Frequency : 800.4095 MHz		Limit : 0.005%					
Environment Temperature (°C)	Power Supplied (Vdc)	Frequency measured with time elapsed					
		2 minute		5 minute		10 minute	
		(MHz)	(%)	(MHz)	(%)	(MHz)	(%)
50	New Batt.	800.4075	-0.00025	800.4199	0.00129	800.3845	-0.00312
40		800.4238	0.00179	800.3837	-0.00322	800.4188	0.00116
30		800.4093	-0.00003	800.3892	-0.00253	800.3939	-0.00195
20		800.4392	0.00371	800.3994	-0.00126	800.4141	0.00058
10		800.4243	0.00185	800.4312	0.00271	800.3823	-0.00340
0		800.3804	-0.00363	800.4355	0.00325	800.3958	-0.00171
-10		800.4007	-0.00109	800.3902	-0.00241	800.4012	-0.00103
-20		800.4028	-0.00083	800.4362	0.00333	800.4204	0.00136
-30		800.4297	0.00253	800.4342	0.00309	800.4027	-0.00085

E2. Frequency stability versus end-point supplied voltage (2Vdc)

Reference Frequency : 800.4095 MHz		Limit : 0.005%					
Environment Temperature (°C)	Power Supplied (Vdc)	Frequency measured with time elapsed					
		2 minute		5 minute		10 minute	
		(MHz)	(%)	(MHz)	(%)	(MHz)	(%)
25	End-Point	800.4054	-0.00057	800.4083	-0.00022	800.4287	0.00233

F1. Frequency stability versus environment temperature

Reference Frequency : 805.3095 MHz		Limit : 0.005%					
Environment Temperature (°C)	Power Supplied (Vdc)	Frequency measured with time elapsed					
		2 minute		5 minute		10 minute	
		(MHz)	(%)	(MHz)	(%)	(MHz)	(%)
50	New Batt.	805.3051	-0.00055	805.3378	0.00352	805.3189	0.00116
40		805.2831	-0.00328	805.3271	0.00219	805.3070	-0.00031
30		805.3135	0.00049	805.3368	0.00339	805.3226	0.00163
20		805.3097	0.00003	805.3254	0.00198	805.2951	-0.00178
10		805.3400	0.00378	805.2790	-0.00379	805.3254	0.00198
0		805.2896	-0.00247	805.2816	-0.00346	805.3278	0.00228
-10		805.3007	-0.00109	805.3149	0.00067	805.2791	-0.00377
-20		805.2901	-0.00241	805.3074	-0.00026	805.3343	0.00308
-30		805.2997	-0.00121	805.2900	-0.00242	805.3293	0.00246

F2. Frequency stability versus end-point supplied voltage (2Vdc)

Reference Frequency : 805.3095 MHz		Limit : 0.005%					
Environment Temperature (°C)	Power Supplied (Vdc)	Frequency measured with time elapsed					
		2 minute		5 minute		10 minute	
		(MHz)	(%)	(MHz)	(%)	(MHz)	(%)
25	End-Point	805.2860	-0.00291	805.3109	0.00018	805.2986	-0.00135

8 CONDUCTED EMISSION MEASUREMENT

8.1 Description

For unintentional and intentional device, Line Conducted Emission Limits are in accordance to 15.107(a) and 15.207(a) respectively.

8.2 Measurement Procedure

1. Setup the configuration per figure 3.
2. A preliminary scan with a spectrum monitor is performed to identify the frequency of emission that has the highest amplitude relative to the limit by operating the EUT in selected modes of operation, typical cable positions, and with a typical system configuration.
3. Record the 6 or 8 highest emissions relative to the limit.
4. Measure each frequency obtained from step 3 by a test receiver set on quasi peak detector function, and then record the accuracy frequency and emission level. If all emissions measured in the specified band are attenuated more than 20 dB from the limit, this step would be ignored, and the peak detector function would be used.
5. Confirm the highest three emissions with variation of the EUT cable configuration and record the final data.
6. Repeat all above procedures on measuring each operation mode of EUT.

Figure 3 : Conducted emissions measurement configuration

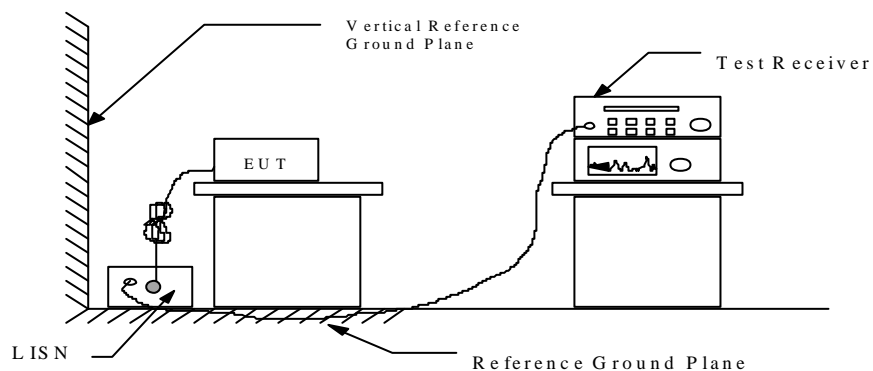

8.3 Conducted Emission Data

1. 744.000-752.000MHz

Operation Mode : TX & Charge

Test Date : May 17, 2005 Temperature : 25 °C Humidity : 65 %

Frequency (MHz)	Meter Reading (dBuV)				Factor (dB)	Result (dBuV)				Limit (dBuV)		Margins (dBuV)	
	Q.P. Value		AVG. Value			Q.P. Value		AVG. Value		Q.P. Value	AVG. Value	Q.P.	AVG.
	N	L1	N	L1		N	L1	N	L1				
0.2984	48.8	47.3	----	----	0.2	49.0	47.5	----	----	60.3	50.3	-11.2	----
0.5937	42.1	44.4	----	----	0.3	42.4	44.7	----	----	56.0	46.0	-11.3	----
0.8984	36.0	36.4	----	----	0.3	36.3	36.7	----	----	56.0	46.0	-19.3	----
1.7851	41.6	40.4	----	----	0.5	42.1	40.9	----	----	56.0	46.0	-13.9	----
2.0859	40.7	40.1	----	----	0.5	41.2	40.6	----	----	56.0	46.0	-14.8	----
2.3867	38.2	39.2	----	----	0.5	38.7	39.7	----	----	56.0	46.0	-16.3	----

Note : 1. Please see appendix 3 for Plotted Data

2. The expanded uncertainty of the conducted emission tests is 2.45 dB.

2. 794.000-806.000MHzOperation Mode : TX & ChargeTest Date : May 17, 2005 Temperature : 25 °C Humidity : 65 %

Frequency (MHz)	Meter Reading (dBuV)				Factor (dB)	Result (dBuV)				Limit (dBuV)		Margins (dBuV)	
	Q.P. Value		AVG. Value			Q.P. Value		AVG. Value		Q.P. Value	AVG. Value	Q.P.	AVG.
	N	L1	N	L1		N	L1	N	L1				
0.2867	48.3	46.4	----	----	0.2	48.5	46.6	----	----	60.6	50.6	-12.1	----
0.8110	39.4	43.7	----	----	0.3	39.7	44.0	----	----	56.0	46.0	-12.0	----
1.1601	40.6	40.0	----	----	0.3	40.9	40.3	----	----	56.0	46.0	-15.1	----
1.7343	40.9	39.6	----	----	0.4	41.3	40.0	----	----	56.0	46.0	-14.7	----
2.3085	34.4	40.5	----	----	0.5	34.9	41.0	----	----	56.0	46.0	-15.0	----
3.1953	38.6	38.5	----	----	0.6	39.2	39.1	----	----	56.0	46.0	-16.8	----

*Note : 1. Please see appendix 3 for Plotted Data**2. The expanded uncertainty of the conducted emission tests is 2.45 dB.***8.4 Result Data Calculation**

The result data is calculated by adding the LISN Factor to the measured reading. The basic equation with a sample calculation is as follows:

$$\mathbf{RESULT = READING + LISN FACTOR}$$

Assume a receiver reading of 22.5 dB μ V is obtained, and LISN Factor is 0.1 dB, then the total of disturbance voltage is 22.6 dB μ V.

$$\text{RESULT} = 22.5 + 0.1 = 22.6 \text{ dB}\mu\text{V}$$

$$\begin{aligned} \text{Level in } \mu\text{V} &= \text{Common Antilogarithm}[(22.6 \text{ dB}\mu\text{V})/20] \\ &= 13.48 \mu\text{V} \end{aligned}$$

8.5 Conducted Measurement Equipment

The following test equipment are used during the conducted test.

Equipment	Manufacturer	Model No.	Serial No.	Nest Cal. Date
EMI Test Receiver	Rohde and Schwarz	ESCS30	830986/026	12/06/2005
Line Impedance Stabilization network	Rohde and Schwarz	ESH2-Z5	881362/009	08/10/2005
Line Impedance Stabilization network	Kyoritsu	KNW-407	8-823-6	12/25/2005
Shielded Room	Riken	----	----	N/A
Monitor	IBM	E54	----	N/A
Printer	HP	LASERJET 1000	----	N/A
Computer	ACER	Veriton 7500G	----	N/A

8.6 Photos of Conduction Measuring Setup

Mode : Charge Tx



Appendix 1 : Occupied Emission Bandwidth Plotted Data

744.000~752.00MHz

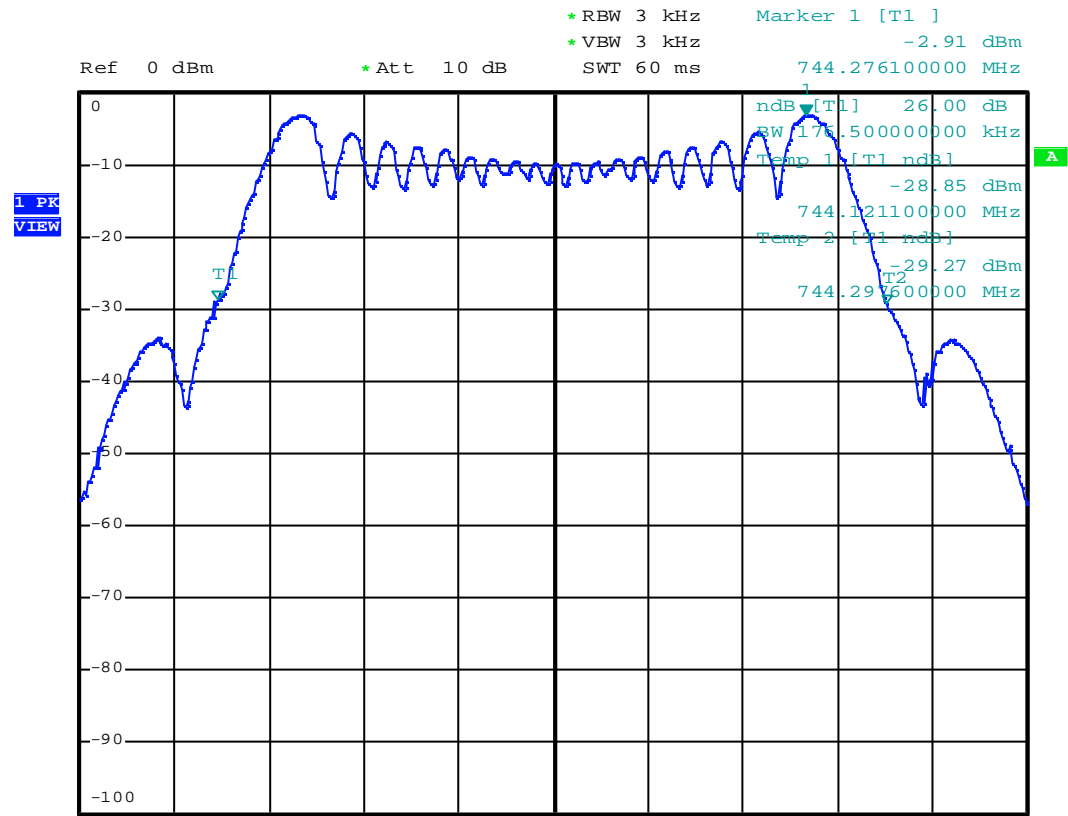

Date: 18.MAY.2005 12:33:03

740.000~752.000MHz

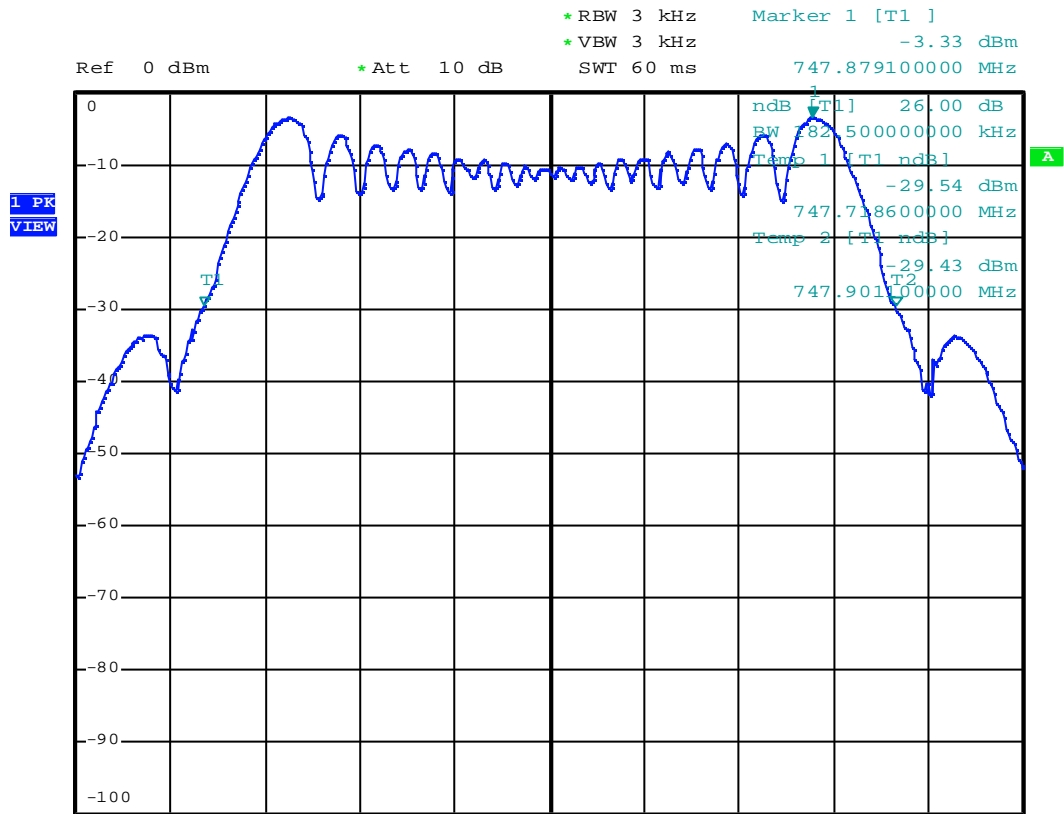

Date: 18.MAY.2005 12:48:51

740.000~752.000MHz

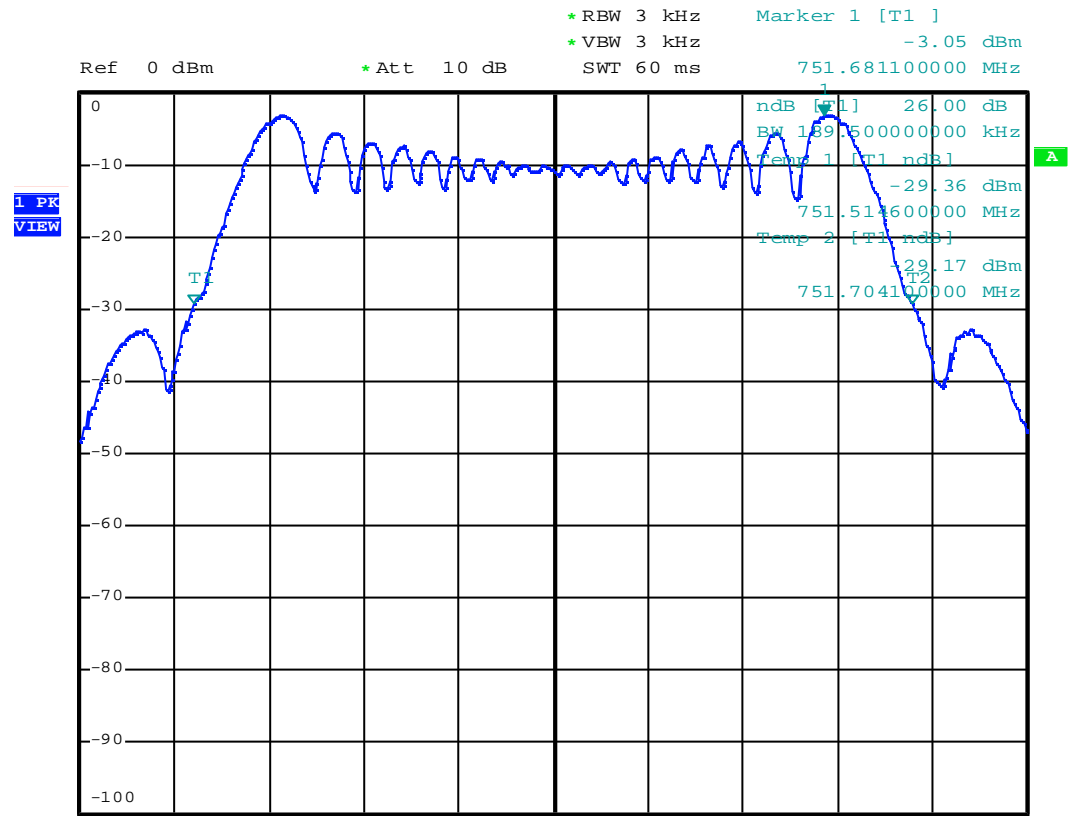

Date: 18.MAY.2005 12:18:57

794.000~806.00MHz

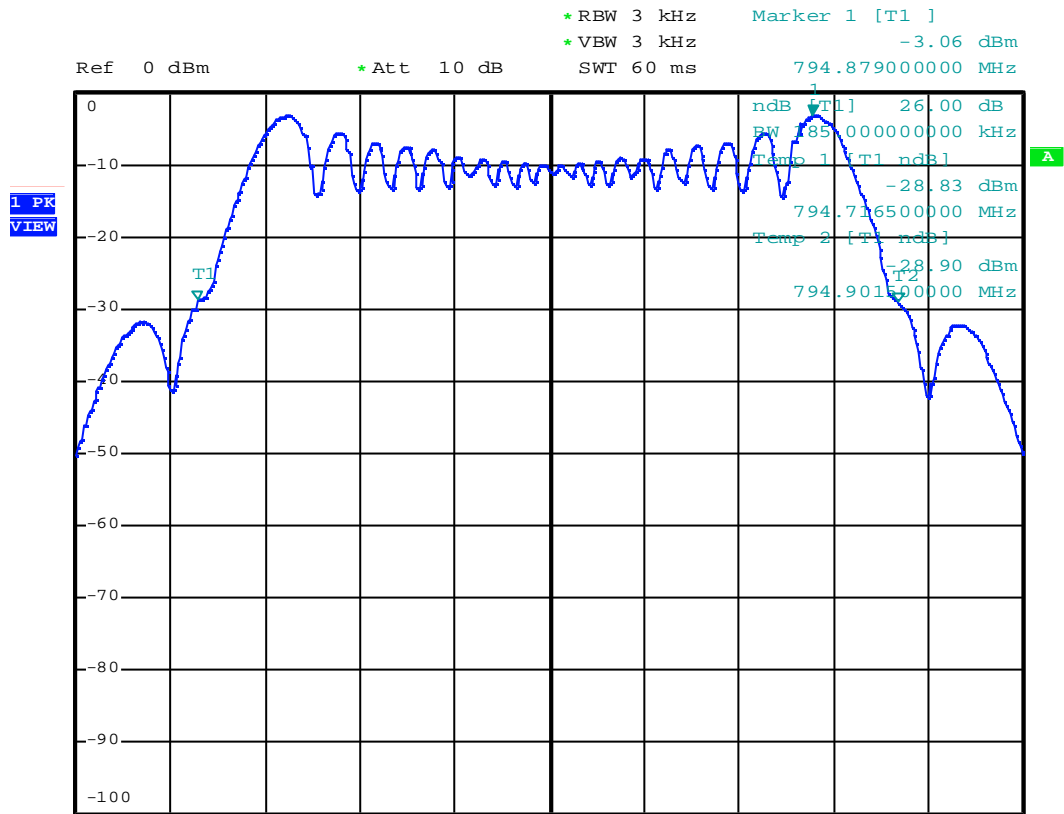

Date: 16.MAY.2005 17:24:26

790.000~806.00MHz

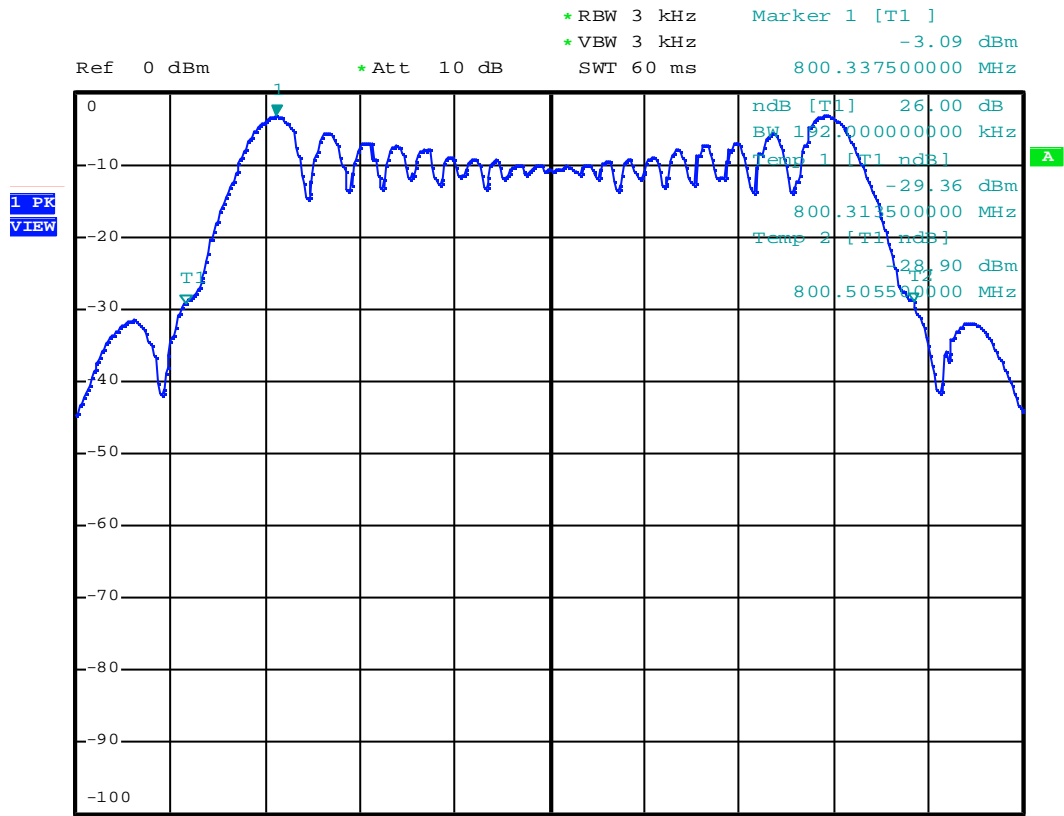

Date: 16.MAY.2005 17:45:23

790.000~806.000MHz

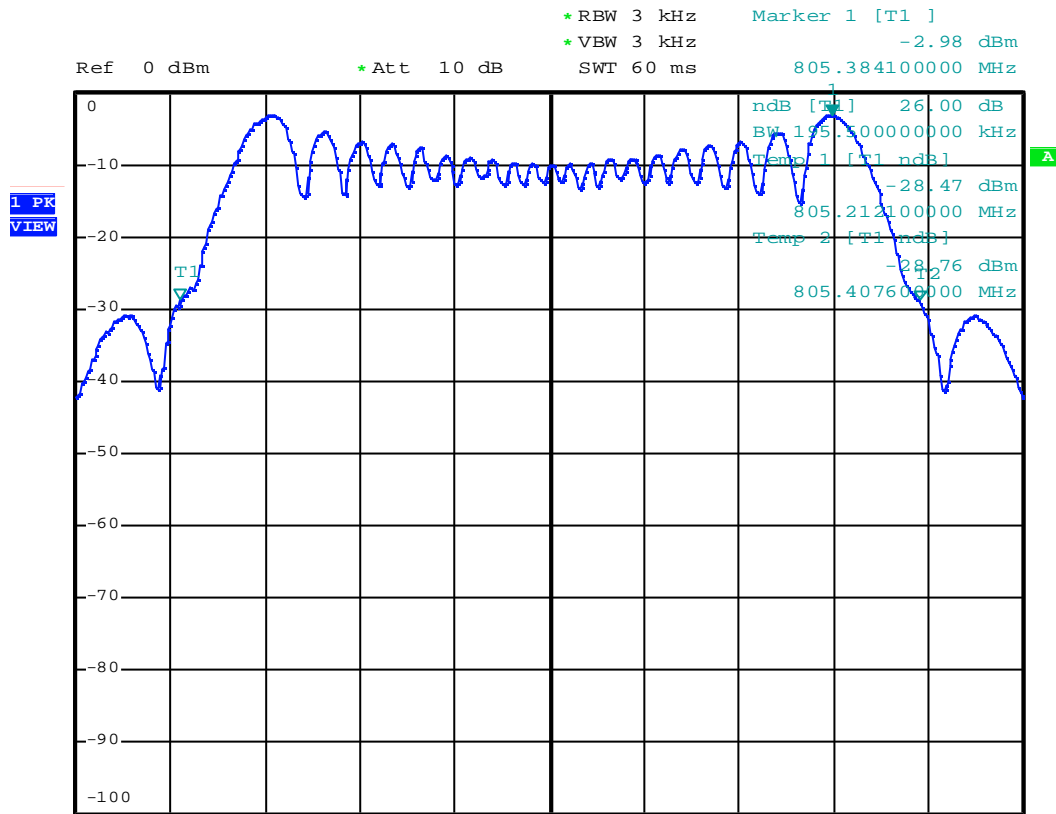

Date: 16.MAY.2005 18:22:49

Appendix 2 : Emission Mask Plotted Data

740.000~752.000MHz

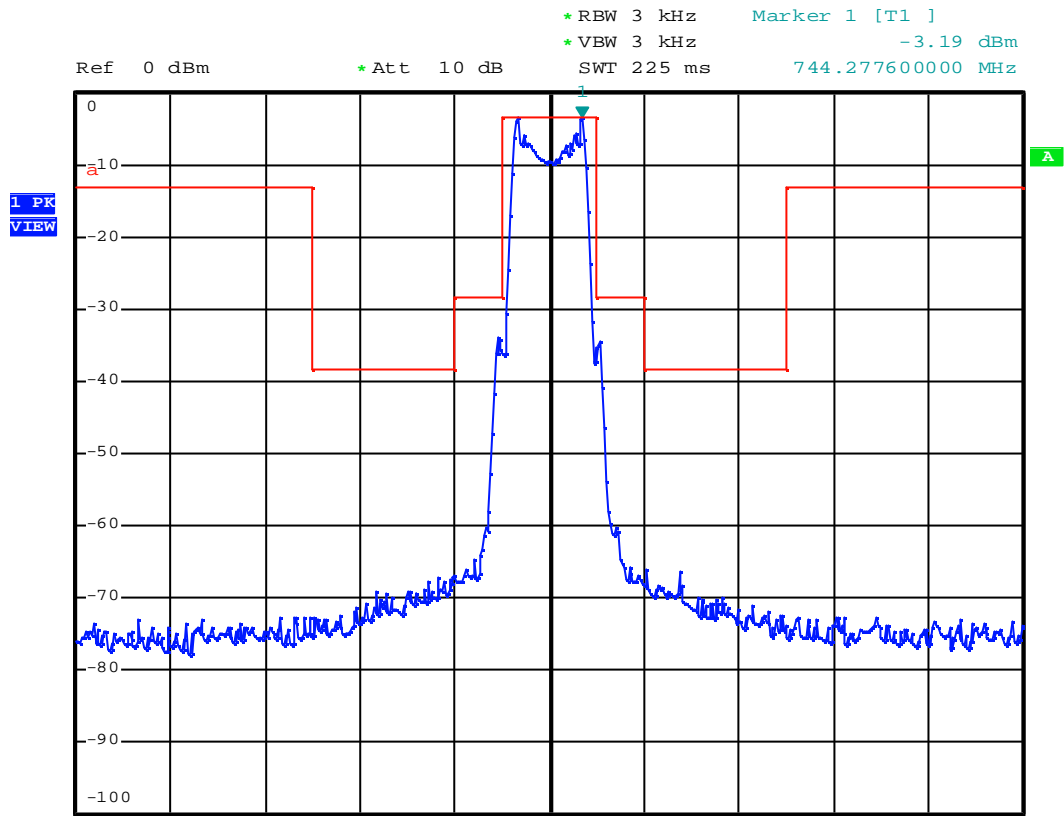

Date: 18.MAY.2005 12:31:13

740.000~752.000MHz

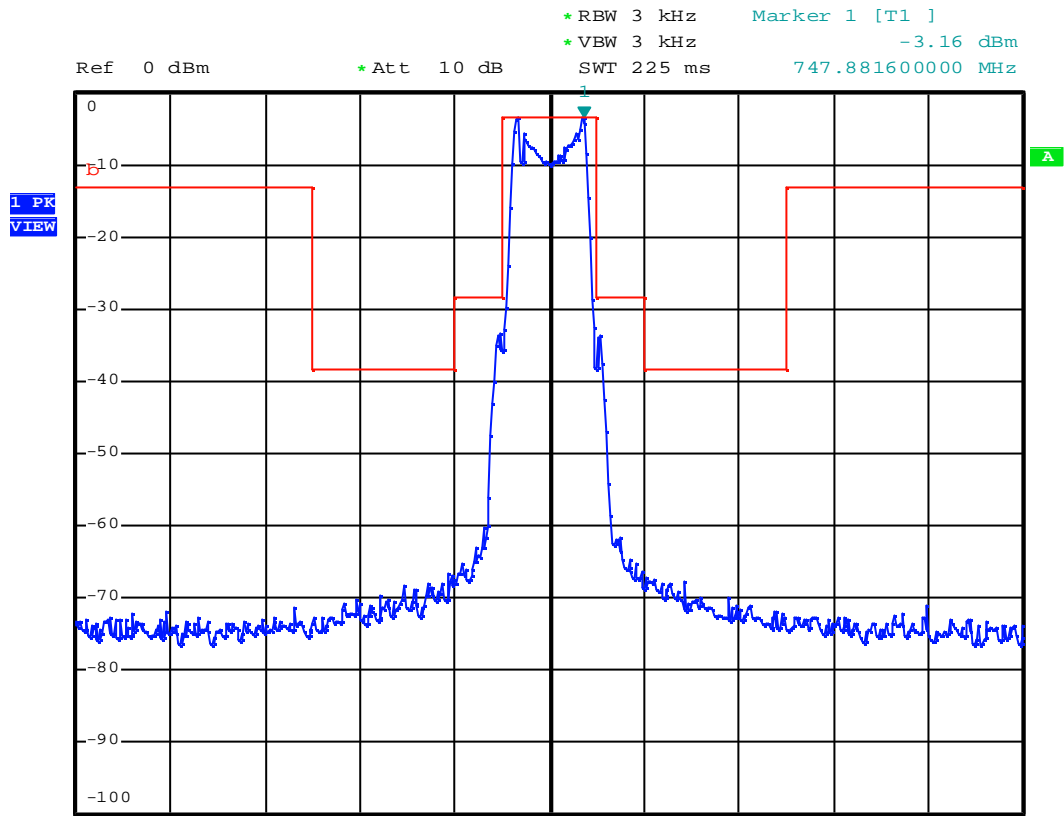

Date: 18.MAY.2005 12:47:15

740.000~752.00MHz

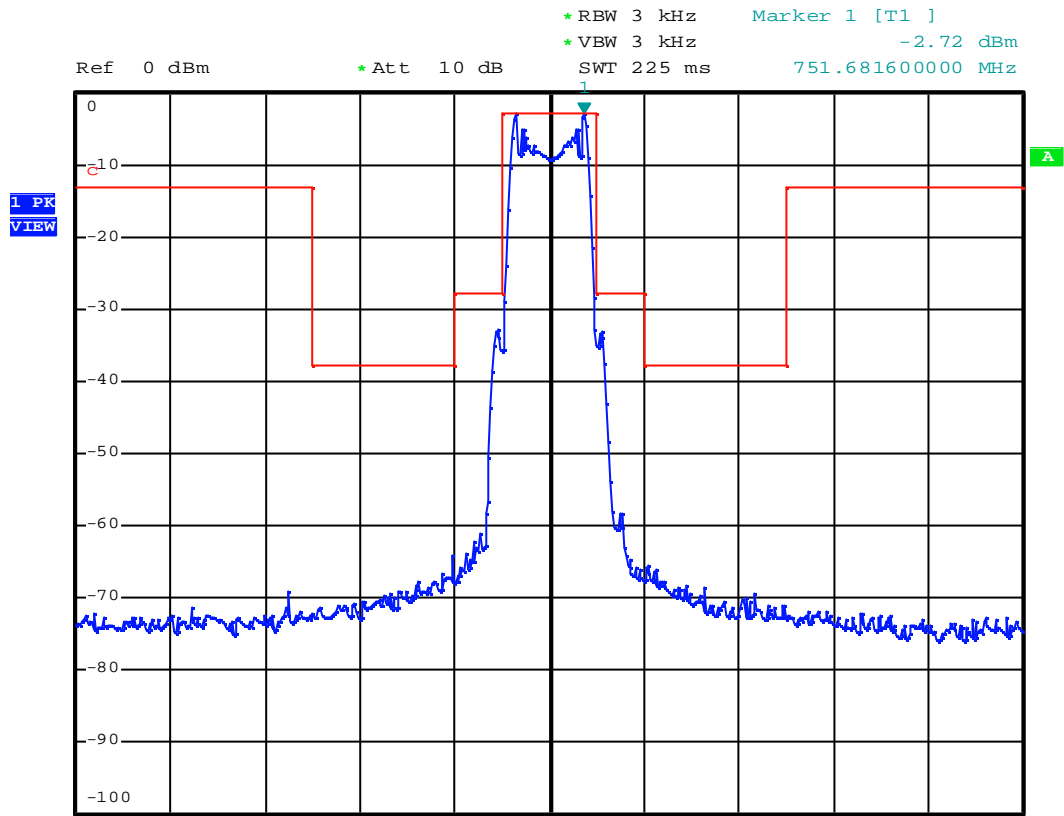

Date: 18.MAY.2005 12:16:09

794.000~806.00MHz

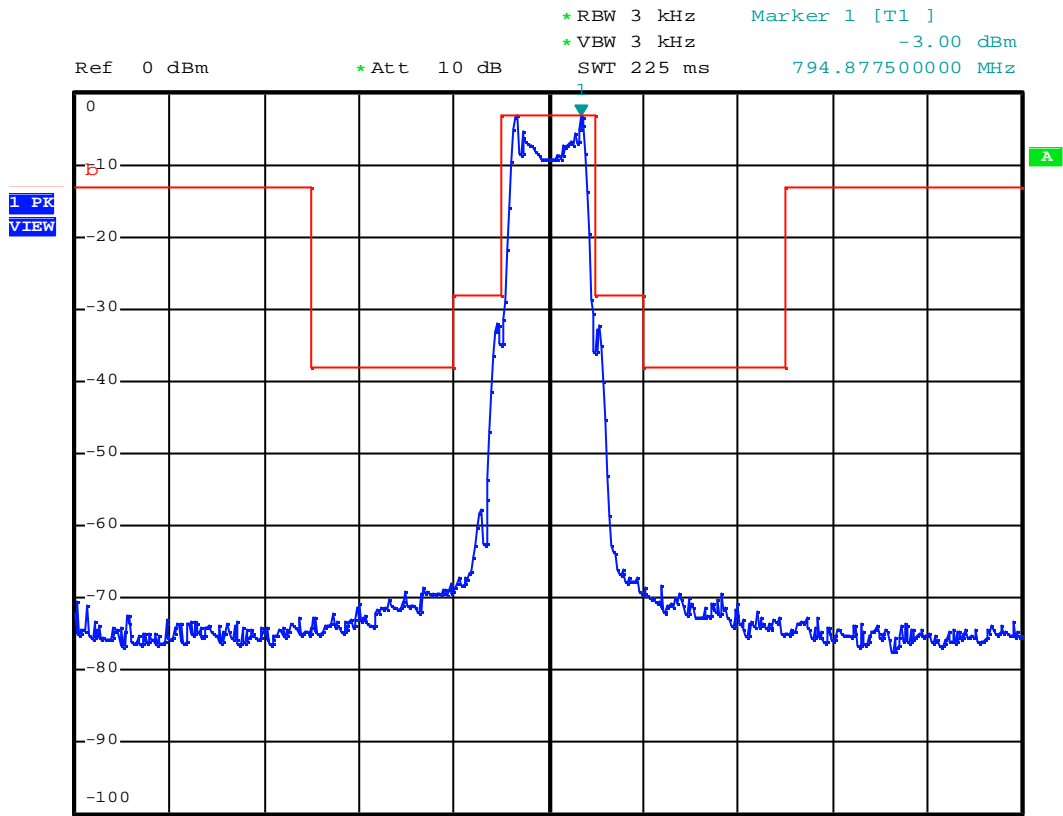

Date: 16.MAY.2005 18:07:08

794.000~806.00MHz

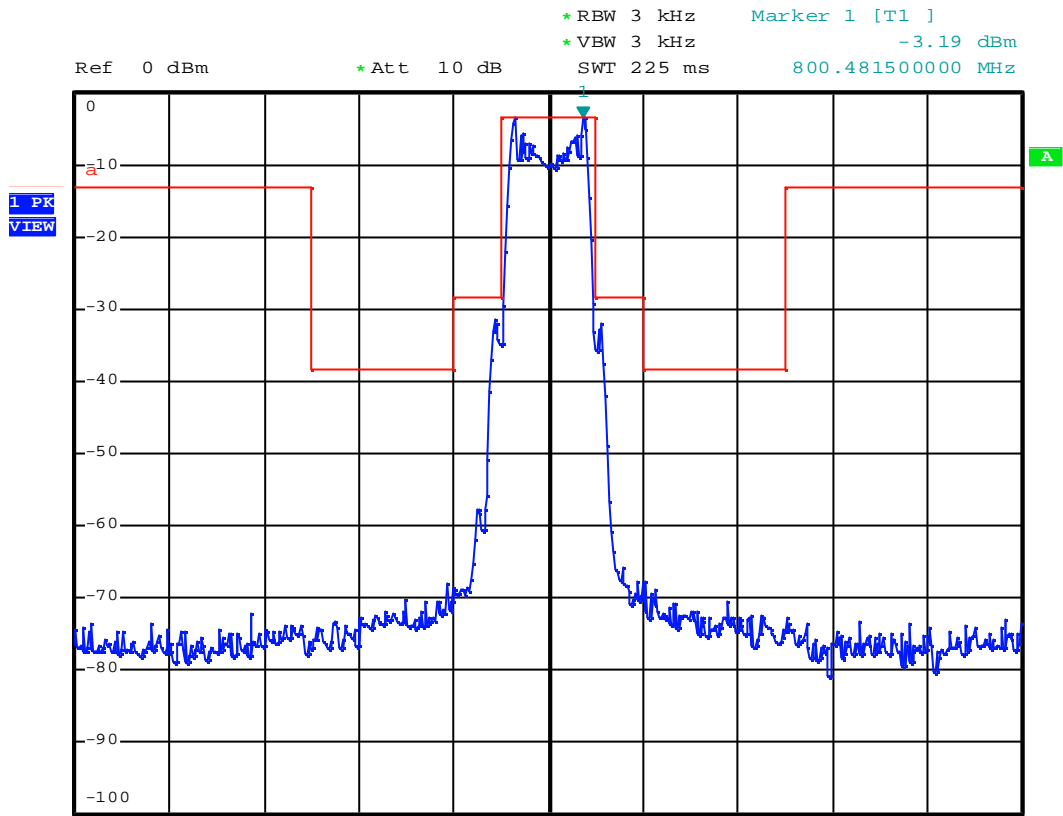

Date: 16.MAY.2005 17:41:33

794.000~806.00MHz

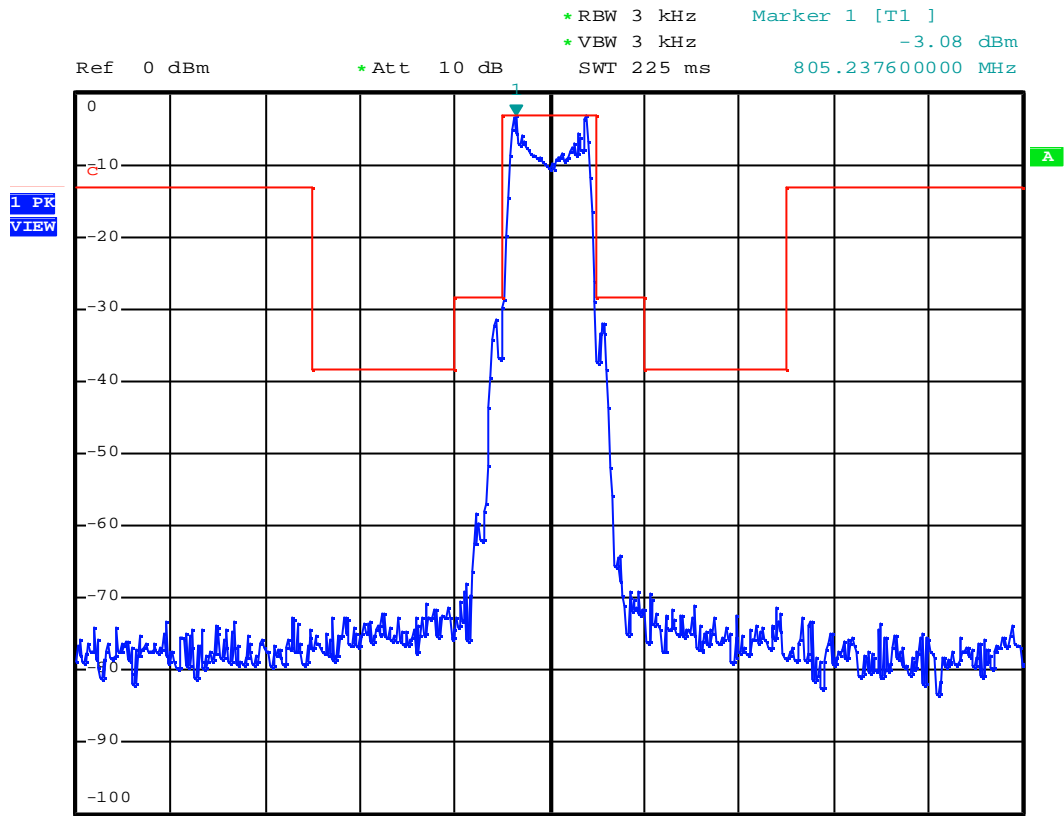

Date: 16.MAY.2005 18:20:27

Appendix 3 : Ploted Datas of Power Line Conducted Emissions

744.000-752.000MHz

CONDUCTION EMISSION TEST

Peak Value

EUT: TX 744-752
Manuf:
Op Cond: CHARGE
Operator:
Test Spec:
Comment: N
THE MEASUREMENT PLOT: PEAK VALUE

Final Measurement: Detector: X QP
 Meas Time: 1sec
 Peaks: 8
 Acc Margin: 25 dB

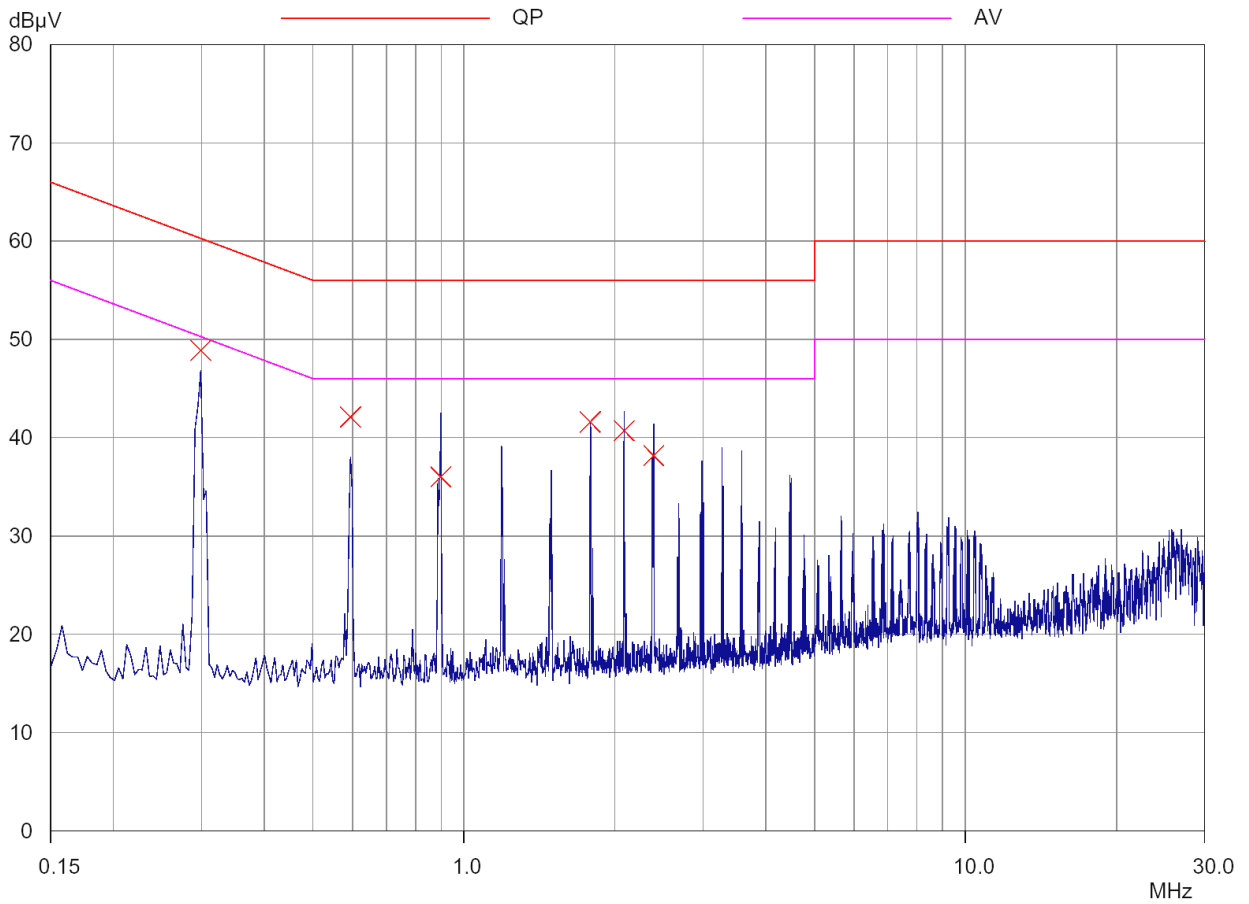

744.000-752.000MHz

CONDUCTION EMISSION TEST

Peak Value

EUT: TX 744-752
Manuf:
Op Cond: CHARGE
Operator:
Test Spec:
Comment: L1
THE MEASUREMENT PLOT: PEAK VALUE

Final Measurement: Detector: X QP
 Meas Time: 1sec
 Peaks: 8
 Acc Margin: 25 dB

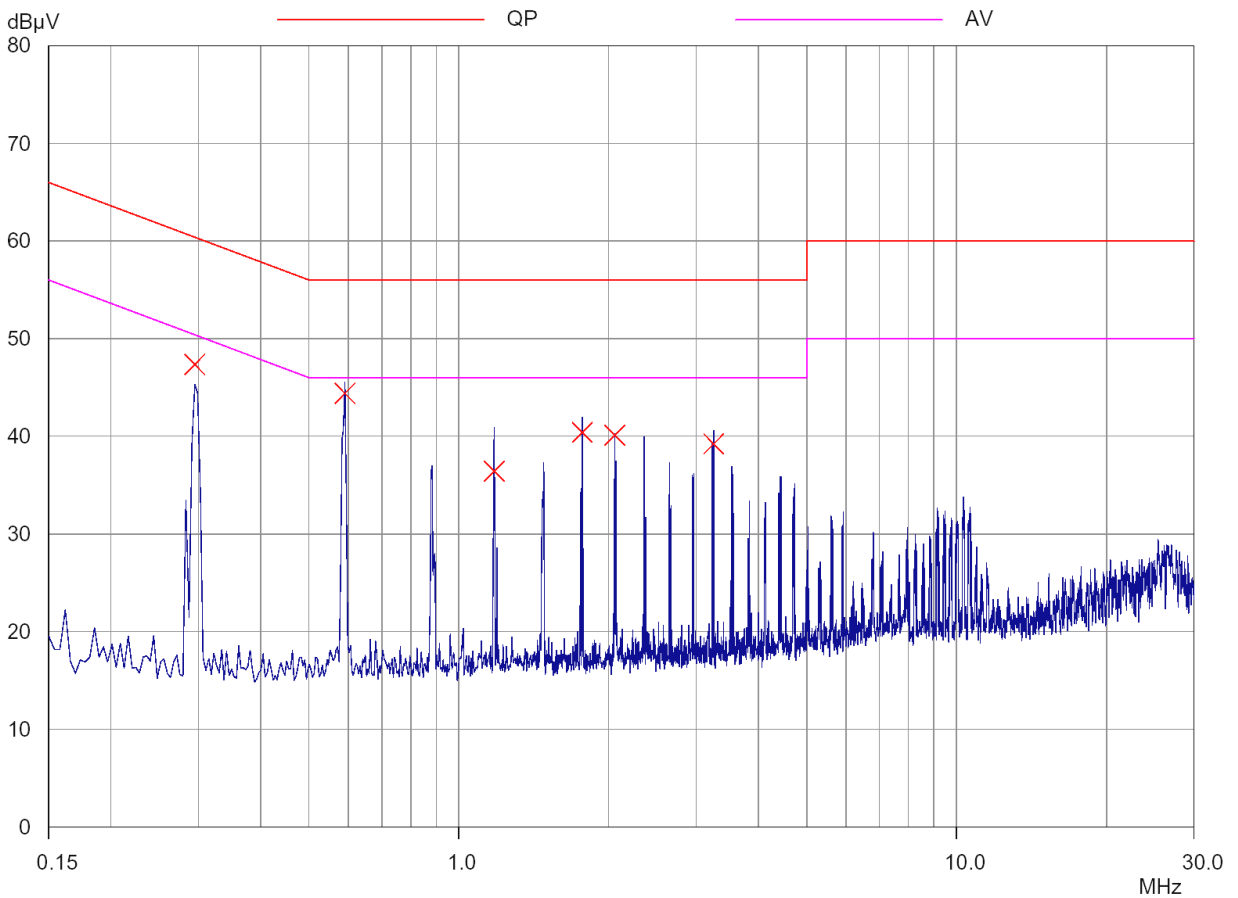

794.000~806.00MHz

CONDUCTION EMISSION TEST

Peak Value

EUT: TX 794-806
Manuf:
Op Cond: CHARGE
Operator:
Test Spec:
Comment: N
THE MEASUREMENT PLOT: PEAK VALUE

Final Measurement: Detector: X QP
 Meas Time: 1sec
 Peaks: 8
 Acc Margin: 25 dB

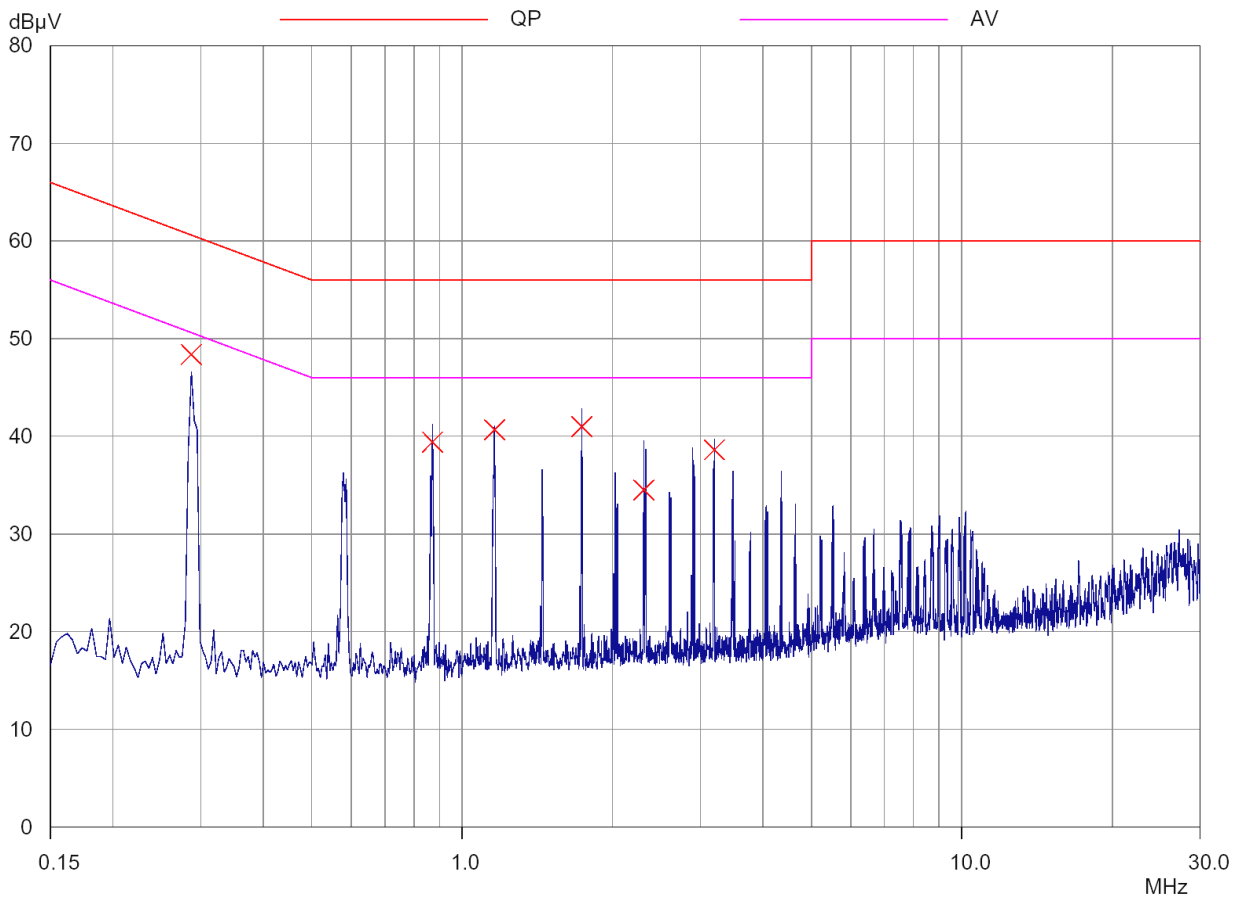

794.000~806.00MHz

CONDUCTION EMISSION TEST

Peak Value

EUT: TX 794-806
Manuf:
Op Cond: CHARGE
Operator:
Test Spec:
Comment: L1
THE MEASUREMENT PLOT: PEAK VALUE

Final Measurement: Detector: X QP
 Meas Time: 1sec
 Peaks: 8
 Acc Margin: 25 dB

