

USER'S GUIDE

WIRELESS PORTABLE SOUND SYSTEM

Compact, Lightweight
Clear sound quality
High output power

Operating Manual for GPA-750W Series

Simple Introduction

Thank you for purchasing this wireless portable sound system GPA-750W series. Rich, full sound and tons of power, the GPA-750W series is ideally suited for large areas. The wireless, music, amplifier and speaker are conveniently combined into one box. This manual includes the complete functions and operations of the wireless portable sound systems. Please read this manual carefully in order to operate and use this system to its fullest potential.

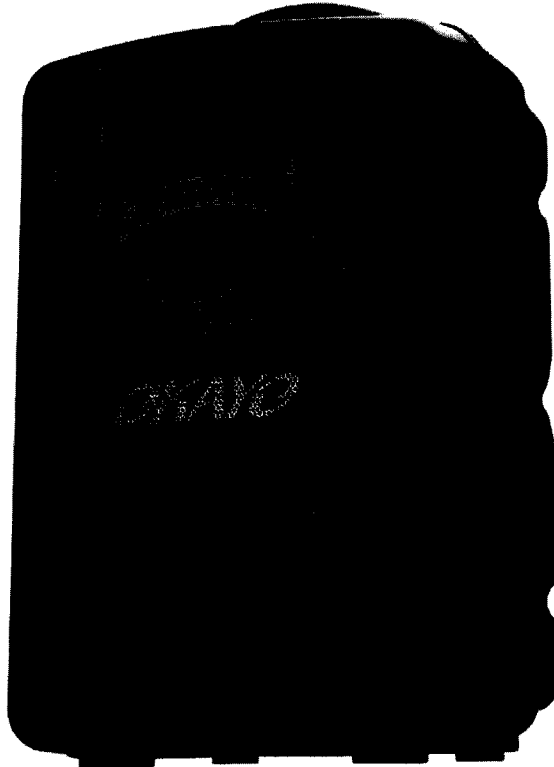

Front Panel Configuration of GPA-750W Series

GPA-750W Series

A: Handle

B: 1" Horn

C: 8" Woofer Speaker

D: Speaker Mesh

E: Heat Sink

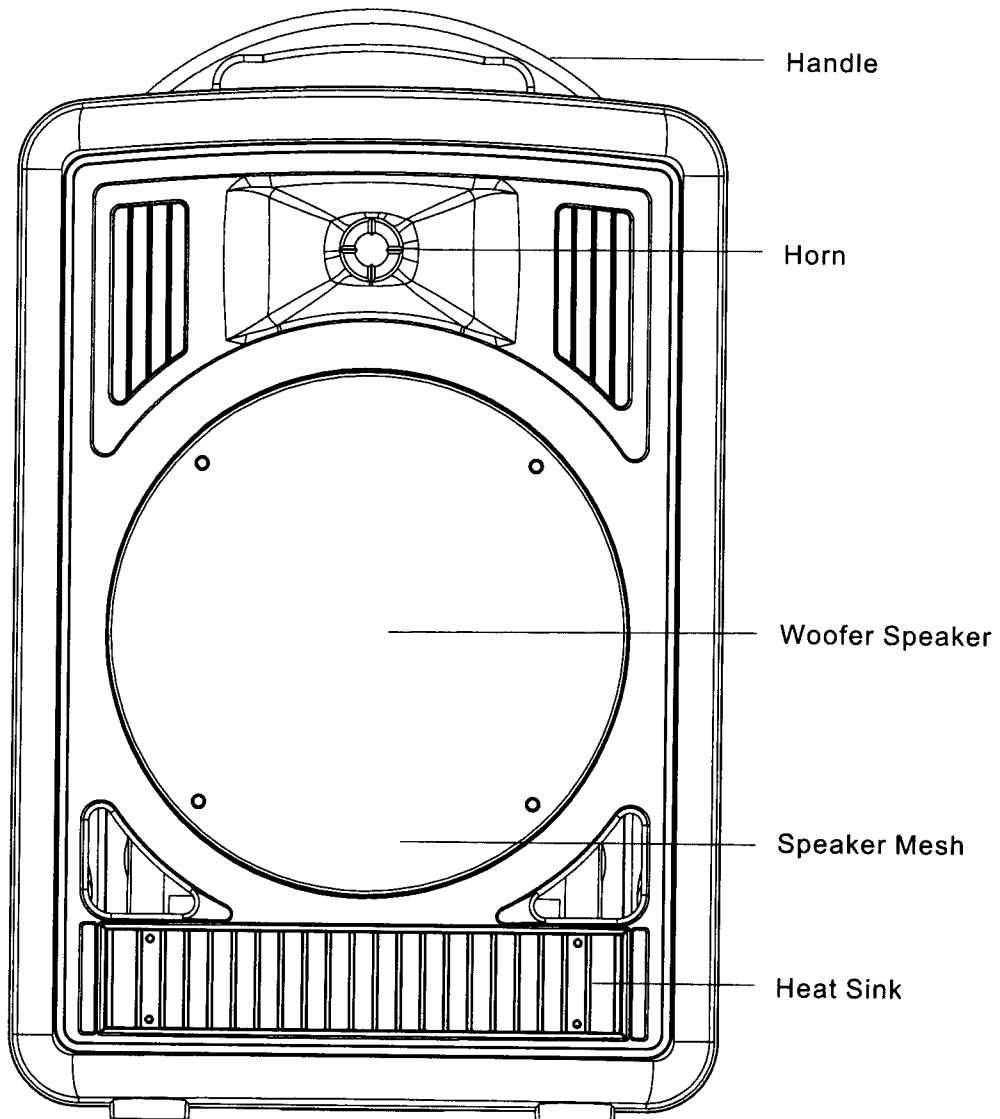

Rear Panel Configuration of GPA-750W Series

GPA-750WU

- A: Wireless Microphone System
- B: Anti-Shock CD/MP3 Player
- C: Power Switch
- D: Operating System
- E: Aux In/Out
- F: Speak Out
- G: Power Supply

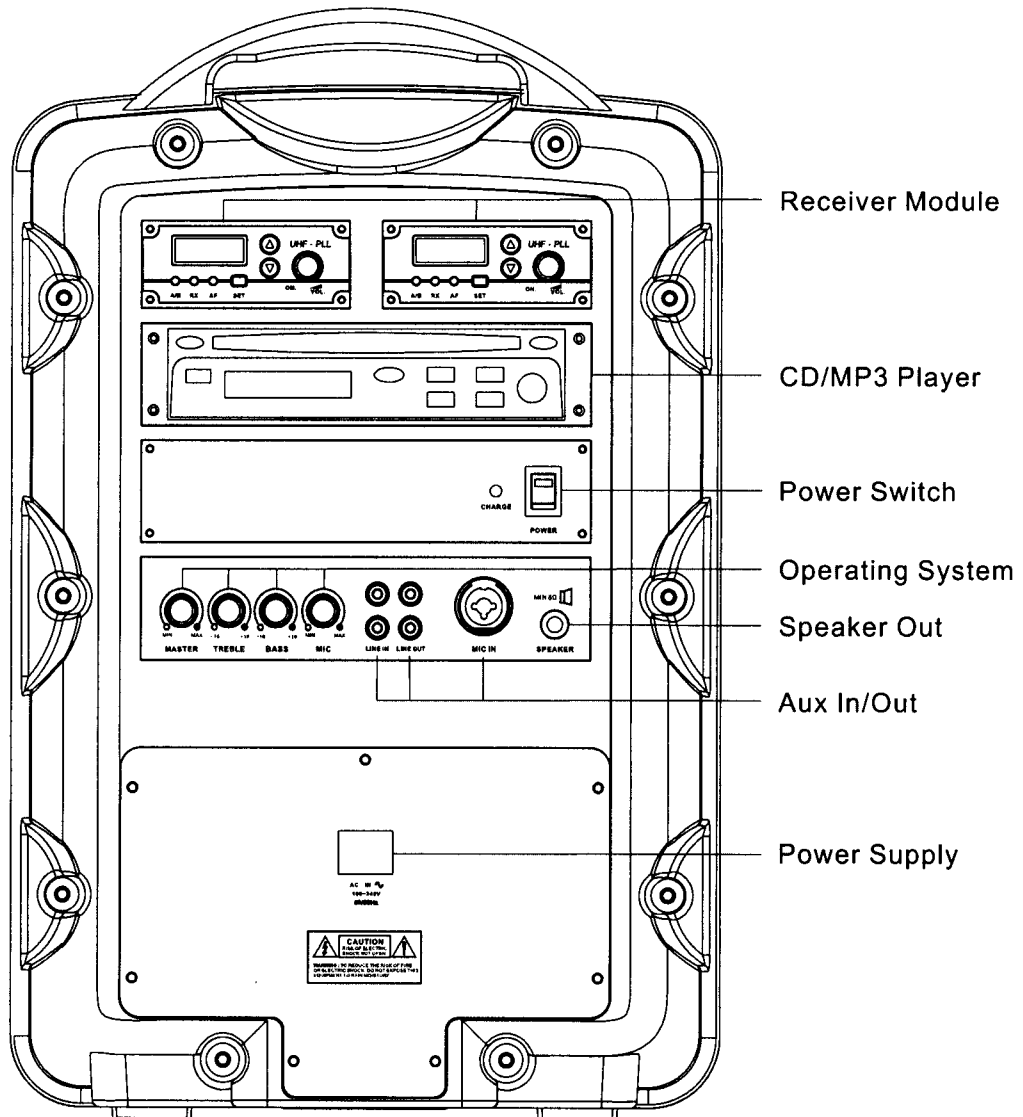

GPA-750WE

- | | |
|--------------------------------|--------------------------|
| A : Wireless Microphone System | E : Aux In/Out |
| B : Anti-Shock CD/MP3 Player | F : Speak Out |
| C : Power Switch | G : Power Supply |
| D : Operating System | H1 : Digital Echo System |

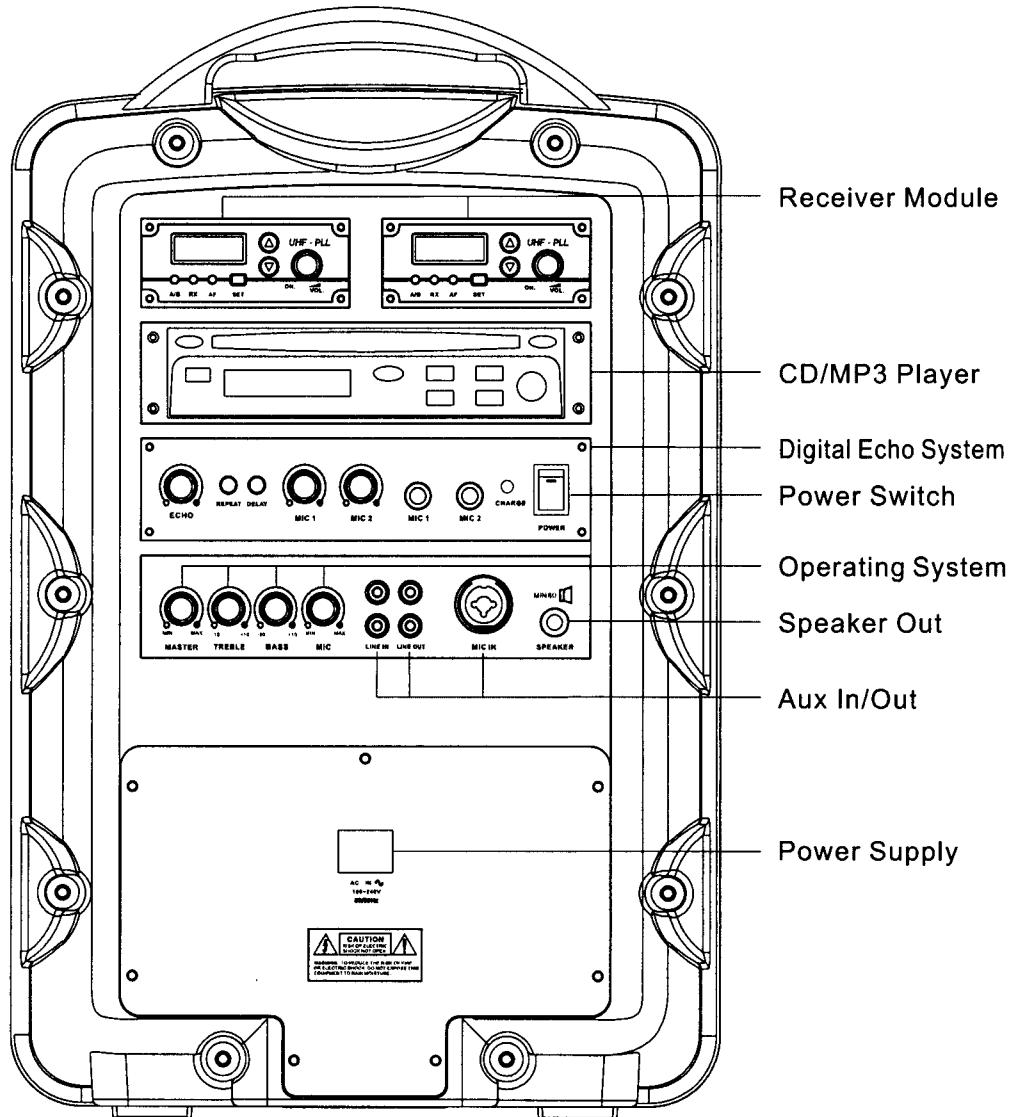

GPA-750WT

- A : Wireless Microphone System E : Aux In/Out
B : Anti-Shock CD/MP3 Player F : Speak Out
C : Power Switch G : Power Supply
D : Operating System H2: Audio Link System

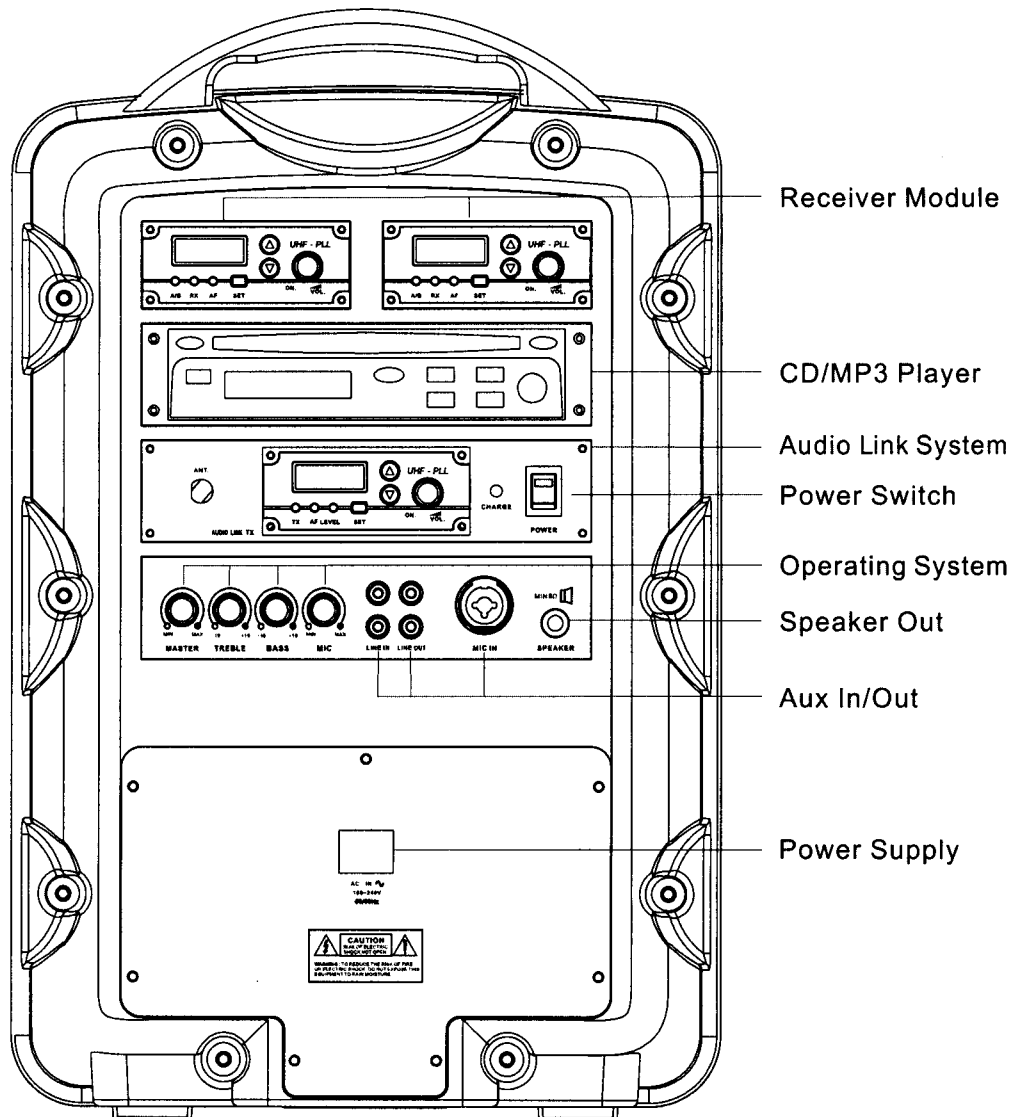

Description of Functions for GPA-750W Series

A. Wireless Microphone System

1. LCD display
2. A/B diversity indicator
3. RX audio indicator
4. AF audio level indicator
5. Setting enter
6. Up/Down selector
7. Power switch & mic. Volume

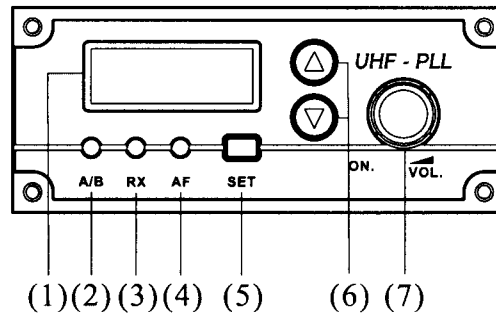

B. Anti-Shock CD/MP3 Player

1. Programming the track
2. Power switch
3. LCD display
4. Shuffle / repeat
5. Stop CD/MP3 play / eject for disc out
6. Search and play the previous track
7. Search and play the next track
8. Play and pause CD/MP3
9. CD volume
10. CD slot
11. Folder

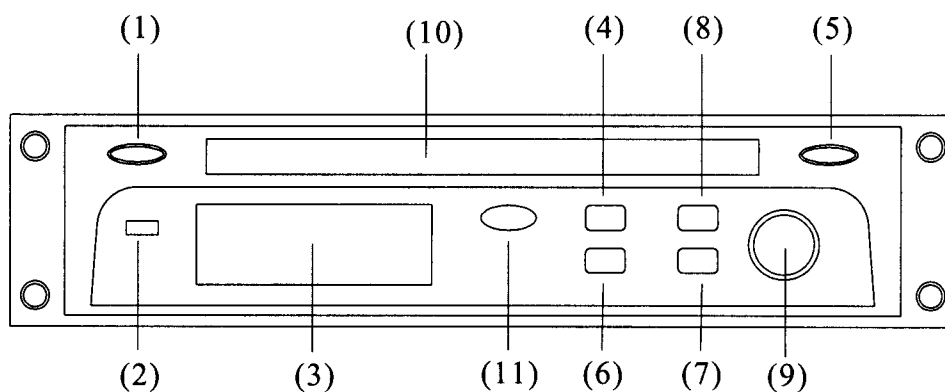

C. Power Switch

1. Power LED
2. Charging Indicator
3. Power on/off switch

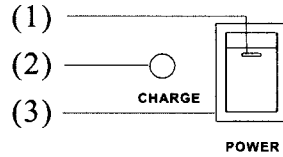

D. Operating System

1. Master volume control
2. Treble adjustment
3. Bass adjustment
4. Mic. Volume control

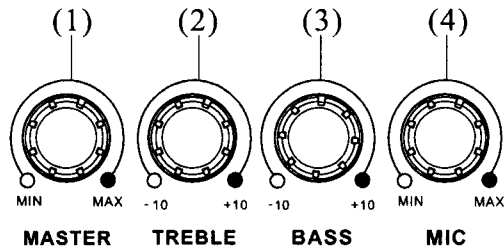

E. Aux In/Out

1. Line in for RCA jack
2. Line out for RCA jack
3. Mic. In for XLR or phone jack

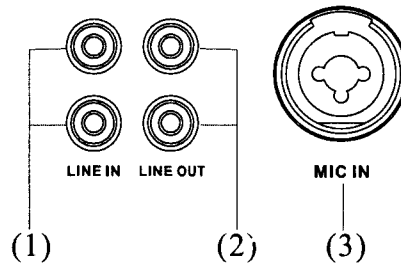

F. Speaker Out

1. Speaker out

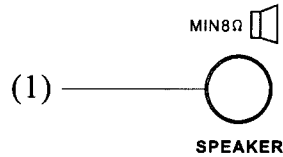

G. Power Supply

1. AC switching power supply
2. Battery
3. Battery cover

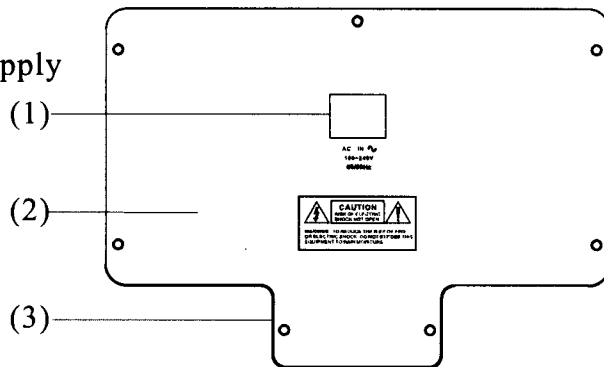

H1. Digital Echo System (for GPA-750WE only)

1. Power switch and volume control
2. Repeated times control
3. Delay times control
4. Wired mic. 1 volume control
5. Wired mic. 2 volume control
6. Wired mic. 1 input for phone jack
7. Wired mic. 2 input for phone jack

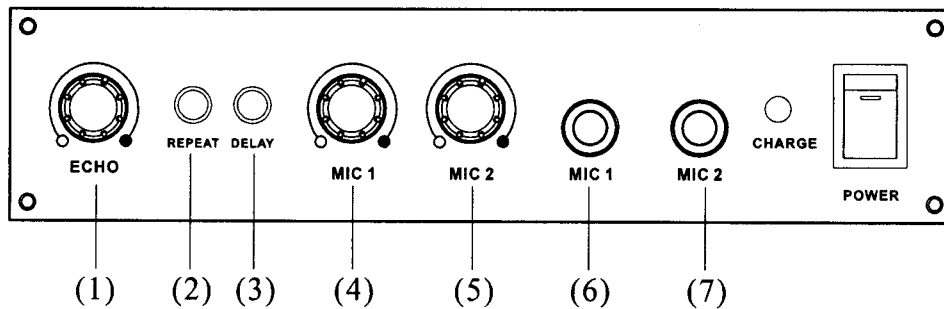

H2. Audio Link System (for GPA-750WT only)

1. Antenna seat
2. LCD display
3. TX audio indicator
4. Low audio level indicator
5. High audio level indicator
6. Setting enter
7. Up/Down selector
8. Power switch and volume control

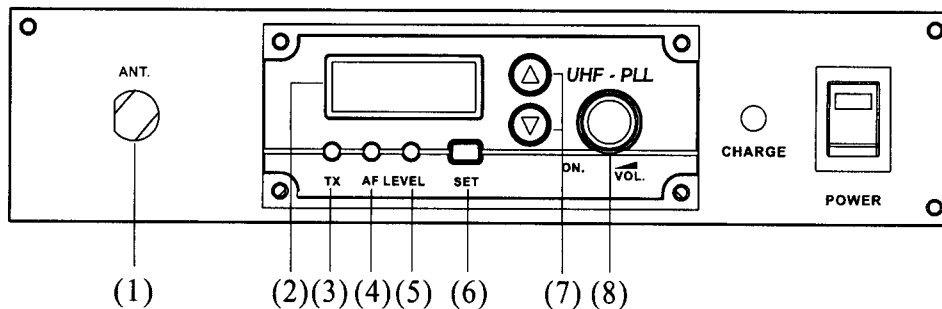

Description of Functions for Handheld Microphone

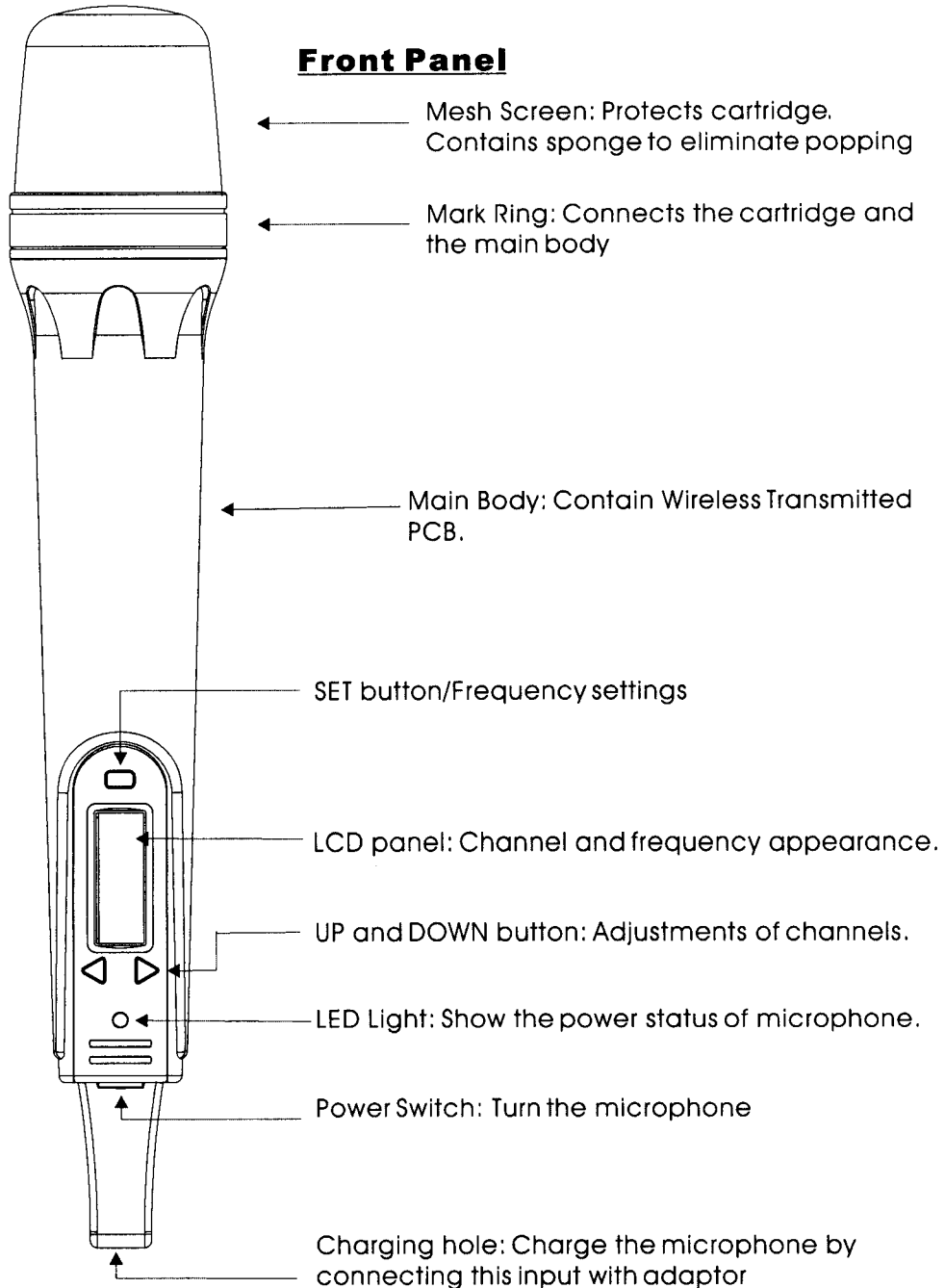

Description of Functions for Handheld Microphone

Rear Panel

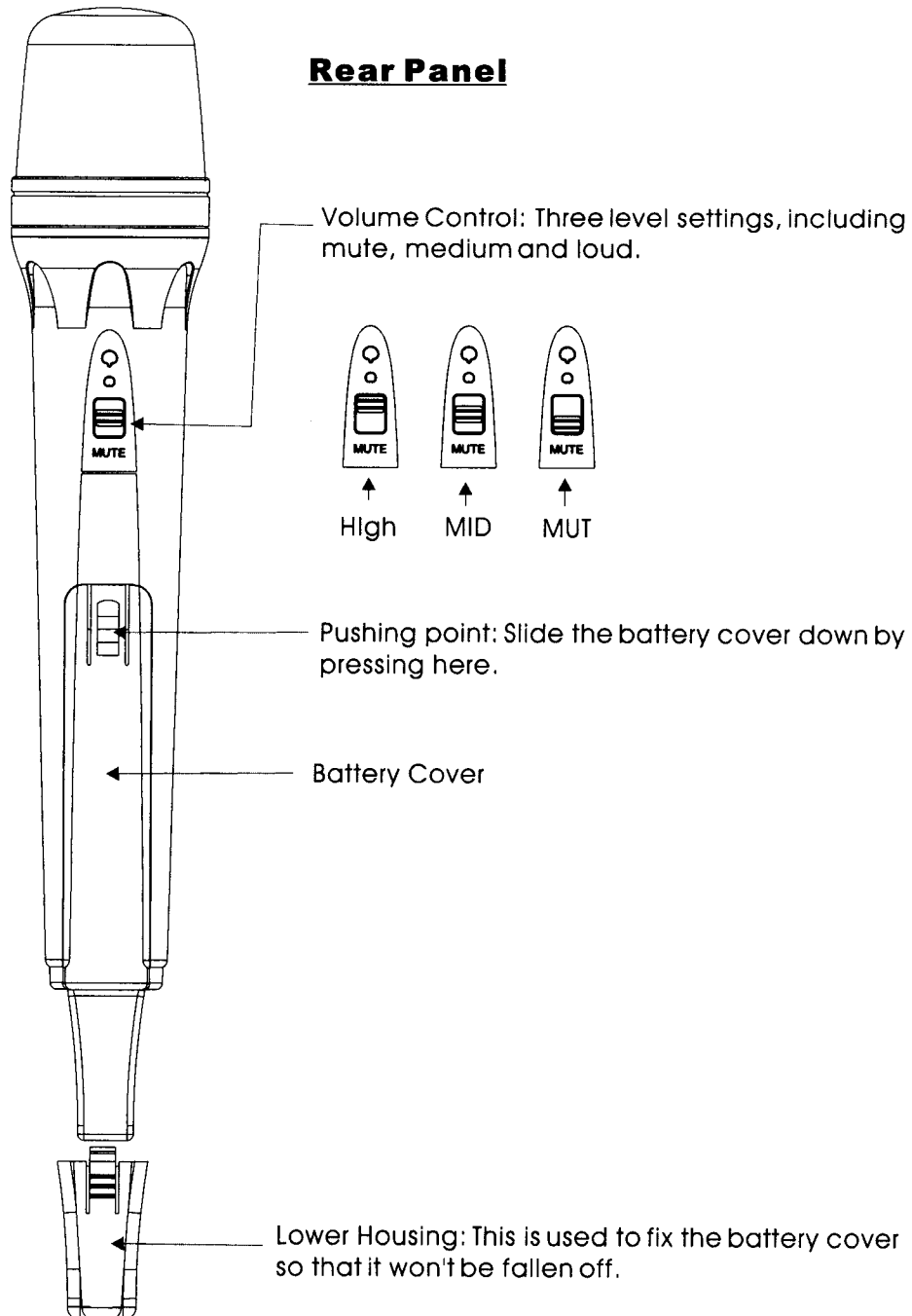

Description of Functions for Body Pack Transmitter

1. 3.5mm Mic. input jack
2. Power switch
3. Mute button
4. Antenna
5. Power light
6. Built-in Mic.
7. Charging Jack
8. LCD light
9. Set button
10. Up/Down button
11. Sensitivity control
12. 3.5mm Aux input jack
13. Belt clip
14. Battery compartment
15. Battery cover

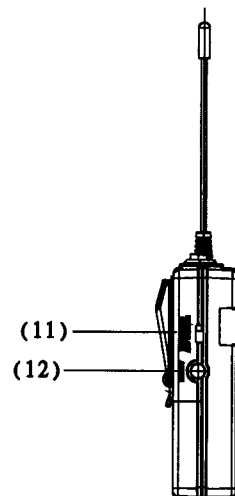
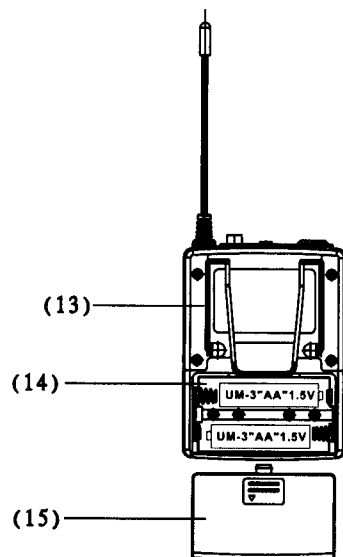
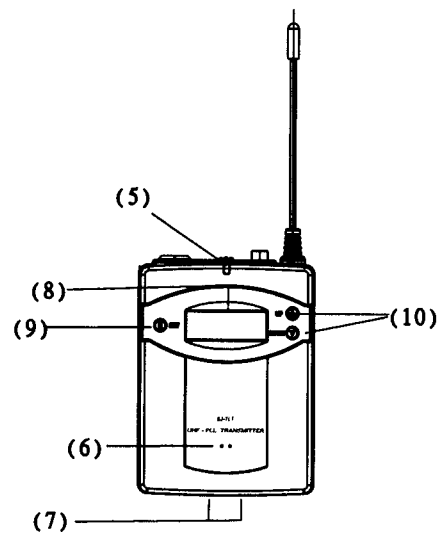
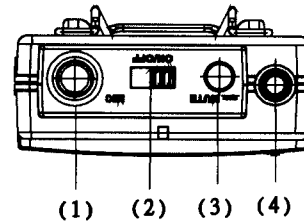

Cautions Before Using the System

1. There is AC switching power built inside the system. Before using AC power, please note that the voltage is at 100~240V, and then connect the AC power cord from the AC IN (**G3**) to the outlet.
2. For first time use, please charge the battery over 8 hrs, to maintain the good quality and operating of the battery. When charging, the charging indicator (**G2**) lights RED. When charging almost full, the indicator will flash Red and Green. After the battery is fully charged, the indicator lights Green.
3. This system has the circuit of auto protection for battery. It could protect the battery from being overcharged and overused. When the power switch LED (**G1**) lights red, it shows that the power remain only 30%. When the power switch keep flash, then it will turn off automatically soon, to protect the battery.

Installation and Operation of Portable Sound System

A. Wireless Mic. Receiver (Please see the page 7)

This system can be built in one or two receiver, for PLL 96/16-CH design, the channel could be selected freely.

- a. Turn the power switch (**A7**) clockwise to turn on the receiver.
- b. The LCD display (**A1**) will show On and then the channel used before turning off last time.
- c. To select the channel, press the set button (**A5**) and the channel in LCD flash. Press up or down button (**A6**) to select the channel to use, and then press enter the setting.
- d. Turn the volume control to the proper position.
- e. When receiving the signals, the A/B diversity indicator (**A2**) will light RED or Green to show the diversity condition. The RX indicator (**A3**) will show the receiving condition and the AF indicator (**A4**) will show the audio level condition.

B. Anti-Shock CD/MP3 Player (Please see the page 7)

- a. Push the power (**B2**) to turn on the player. Put the CD in the CD slot(**B10**) or push Stop/Eject button (**B5**) to take out the CD inside the slot.
 - b. Press Play/Pause button (**B8**) and turn the volume control (**B9**) clockwise to start or pause the playing, and adjust the proper volume. And then push Stop/Eject button to stop or change the CD or MP3 disc.
 - c. Press forward (**B7**) or Reward (**B6**) button each time could forward or backward the song sequence. Keep pushing the forward or reward button could forward or backward the playing song.
 - d. Repeat/Shuffle (**B4**) has three modes, one for repeating one song, and the other for repeating all songs. When press to Shuffle mode, the songs will be played randomly.
 - e. Program setting:
 - Step 1: Press Prog button (**B1**) to start the program setting
 - Step 2: Select the song (please see point c. and f.)
 - Step 3: Press Repeat (**B4**) to enter the program
 - Step 4: Press Play (**B4**) to play the programmed songs in memory
- ※ Please note that the program will reset once press the Prog button again.
- f. To select the folder for MP3, press Folder button (**B11**), and then use Forward or Reward button to select.

C. Tone Control (Please see the page 8)

- a. Turn the Treble control (**D2**) to adjust the treble tone by turning the treble control counterclockwise to decrease the treble, and turn clockwise to increase the treble. If the control stay center, the sound will be original.
- b. Turn the Bass control (**D3**) to adjust the treble tone by turning the bass control counterclockwise to decrease the bass, and turn clockwise to increase the bass. If the control stay center, the sound will be original.

D. Aux In/Out (Please see the page 8)

- a. This system contains Line In, Line Out, and Mic. In for external audio application.
- b. Insert the Line In (**E1**) with RCA jack to add external audio sources, such as CD, or iPod. Turn Master control to adjust the volume.
- c. Insert the Line In (**E2**) with RCA jack to output the signal to other audio applications, such as cassette recorder, or mixer.
- d. Insert the Mic. In (**E3**) with XLR or 6.3mm phone jack to use wired microphone. Turn the Mic. In (**D4**) to adjust to the proper volume.

E. Speaker Out (Please see the page 8)

- a. This system could be connected to other speaker.
- b. Insert the Line In (**E1**) with RCA jack to add external audio sources, such as CD, or iPod. Turn Master control to adjust the volume.
- c. Insert the Line In (**E2**) with RCA jack to output the signal to other audio applications, such as cassette recorder, or mixer.
- d. Insert the Mic. In (**E3**) with XLR or phone jack to use wired microphone. Turn the Mic. In (**D4**) to adjust to the proper volume.

F. Digital Echo System (Please see the page 9)

- a. Turn the power switch (**H1-1**) clockwise to turn on the echo system.
- b. Turn the repeat button (**H1-2**) and delay button (**H1-3**) to adjust the echo effect required.
- c. To use wired microphone, insert the Mic. In (**H1-4**) and Mic. In 2 (**H1-5**). Then adjust the volume by turning Mic. 1 (**H1-6**) and Mic. 2 (**H1-7**) clockwise to the proper position.

G. Audio Link System (Please see the page 9)

- a. Turn the power switch **(H2-8)** clockwise to turn on the transmitter.
- b. The LCD display **(H2-2)** will show On and then the channel used before turning off last time.
- c. To select the channel, press the set button **(H2-6)** and the channel in LCD flash. Press up or down button **(H2-7)** to select the channel to transmit, and then press set button again to enter the setting.
- d. Turn the volume control **(H2-8)** to the proper position.
- e. When transmitting the signals, the TX indicator **(H2-3)** will light Green to show the transmitting condition. The AF Level indicator lights Yellow **(H2-4)** to show the low audio, lights Red **(H2-5)** to show the high audio.

Installation and Operation of Handheld Microphone

A. Battery-Insert Steps:

1. Turn off the microphone before inserting batteries.
2. Take the lower housing off.
3. Press the upper point of battery cover (see xx) and slide it down.
4. Insert 2 disposable batteries (2 pieces of 1.5V type) or rechargeable batteries (2 pieces of 1.2V type).
5. Please be aware of its polarity while inserting batteries.
6. Slide the battery cover back to the original position.
7. Put the lower housing back to the lower part of the microphone.

B. Turn-On Steps:

1. Turn the power on by keep pressing its power switch for about one to two seconds till its LED light turns to RED.

On

Importantly, please take off the lower housing while pressing its power switch. Besides, only click the bottom side of this switch, this microphone can be Operated.

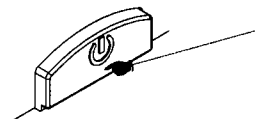

2. While this LED light reveals as the same diagram as you can see below, it means you have turn the microphone on successfully.

 CH.08

: The 8th Channel.

 107.9 MHz

: If you want to know which frequency you are utilizing, please press the button of UP or DOWN so as to see the Frequency.

C. Turn-Off steps:

1. Please keep pressing the power switch for about one to two seconds till the LCD panel appears OFF and then it will be turned off.

OFF

D. Frequency Settings:

1. Press SET for around 2 seconds.
2. The LCD panel will turn to bright and keep flashing.
3. Channel can be increased while pressing the button of UP.
4. Channel can be decreased while pressing the button of DOWN.
5. After confirming the channel you want, click the button of SET again and this channel has then been set up.

E. Meanings of LCD appearance:

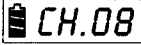
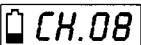
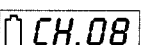
1. : While the battery shows three squares, it means this microphone is full charged.
2. : While there is only one square, the microphone is insufficient electricity.
3. : While it shows nothing in the battery, this microphone will be turned off automatically after flashing three times.

F. Battery Charging Steps:

1. Noted the specification of batteries you will charge needs to be NiMH AA 1.2V. (Its charging function can only be limited to the batteries with 2100mAh or even lower amperage.)

2. It would be better if you use the adapter our company offers, whose output is DC 5V, to charge the microphone.

3. Charging status:

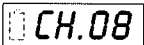
a)  The square of battery is flashing: Non-Rechargeable batteries or Non-Insert batteries. Please check batteries.

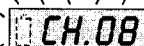
b)  The square of battery is flashing and bright LCD: Failing, rusted or over-temperature batteries.

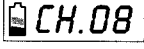
c)  The squares of battery show up accordingly: Batteries are charging successfully.

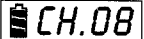
D)  Three squares are shown up at the same time: Batteries Have been full charged.

*** Please note the microphone will be turned off automatically while it is being charged.**

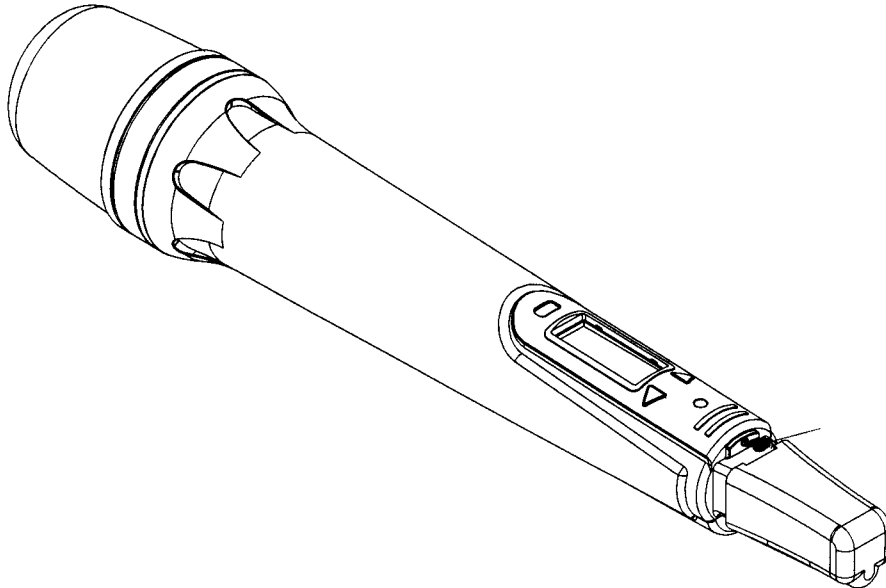

G. Trouble Shooting:

1. LED light doesn't appear while pressing power switch.
 - a) Please check if you have inserted batteries or if batteries are less Electricity.
 - b) Please check if you put the polarity of batteries in the correct way.
2. LCD shows Err while you turn it off.
 - a) Click buttons of SET, UP and DOWN at the same time in order to turn the microphone off automatically. After that, you can turn it on as the usual way. (see B)
 - b) The microphone will be turned off automatically after this graph flashes about ten times. Thereafter, press buttons of SET, UP and DOWN at the same time. Then, when you press its power switch for around one to two seconds, noted to keep three buttons mentioned above. Please keep away the power switch when LCD panel appears the word "ON" and flash once. Finally, you can turn the microphone on as usual.
 - c) If the solutions a) and b) can't resolve the problem you face, please send the product back to us for repairing.
3. LCD panel shows unusual graphs.
 - a) Take off the batteries from the microphone and re-insert them.
4. No sounds.
 - a) Check if the frequency of the transmitter is the same as that of the Receiver.
 - b) Check if the volume of the transmitter and receiver is too slow.
 - c) Check if the distance between the transmitter and the receiver is too far.
 - d) Check if the transmitter or the receiver is too close to any metal Materials or products.

5. Voice Disturbance.

- a) Please select different frequency while two transmitters are operated at the same time so as to avoid any potential disturbances, such as interference, unclear voices or no responds, occurred. Please check if any other wireless products, such as wireless microphones, televisions or radios and so on, nearby. If so, please Tune and adjust the frequency to the one, which is not interfered.

H. Q&A

1. Q: How long can the microphone be operated while it is full charged?
A: Chargeable batteries with 1300mA will take about 8 hours and that with 1600 mA will take 10 hours. However, if the batteries you use are disposable, the microphone can be operated for around 13 hours while it is full charged.
2. Q: How long does the microphone need to be charged while its chargeable batteries are used up?
A: It will take around 4 to 5 hours if the batteries are 1300 mA which is our Standard batteries.

Installation and Operation of Bodypack Transmitter

A. Battery-Insert Steps:

1. Turn off the microphone before inserting batteries.
2. Take the battery cover off.
3. Insert 2 disposable batteries (2 pieces of 1.5V AA type) or rechargeable batteries (2 pieces of 1.2V AA type).
4. Please be aware of its polarity while inserting batteries.
5. Slide the battery cover back to its original position.

B. Turn-On Steps:

1. Switch the power to ON position
2. Power Light will turn to RED then LCD will show in order of "On"

On

=> "battery status and channel"



If there is no other operation, LCD light will disappear automatically in 5 seconds.

C. Frequency Settings:

1. Press SET button for around 2 seconds.
2. The current frequency will keep flashing then release SET button.
3. Pressing UP or DOWN button for selecting channels.
4. When channel is selected press SET button again. The current frequency will stop flashing and stay on the channel selected.

D. Meanings of LCD appearance:

1. It shows channel 08 and the status of battery is full.
2. It shows low-battery, batteries need to be changed or rechargeable batteries need to recharge.
3. While battery status is flashing it means out of power and will keep flashing for three times then switch off automatically.

E. Battery Charging Steps:

1. Ensure the batteries are rechargeable batteries.
2. Switch Power to OFF position.
3. Insert EJ-7LT into its own designed intelligent charger stand (HDC-809).
4. Then it will recharge automatically.
5. For more details of charger stand please refer to HDC-809 user guide.

F. Turn-Off Steps:

1. Switch the power to OFF position.
2. LCD light will appear and show "OFF" 

If there is no the other operation, Power Light, LCD will switch off automatically.

G. Trouble Shooting

1. Following the Turn-On steps and it does not work
 - a) Please check if batteries inserted or if batteries are out of electricity.
 - b) Please check if polarity of batteries are on the correct position.
2. LCD shows Err while turn on.
 - a) Switch power OFF, Then Follow the Turn-On step resume again.
 - b) If following up above procedure and still can not solve the problem, please send back to manufacturer.
3. Install Microphone on Transmitter and no out put from Receiver.
 - a) Please check if Transmitter and Receiver are on the same channel.
 - b) Please check if "MUTE" is switched off.
 - c) Please check if the volume control of receiver is switched to a proper position.
 - d) Please check if Transmitter and Receiver are within the operating range.
4. Voice Disturbance.
 - a) When two Transmitters are being used, please select different frequencies. If voice disturbance still occurs please select the other channel until it is not interfered.
 - b) Please check if any other wireless products, such as wireless microphones, televisions or radios and so on, nearby. As these products might cause interference. If so, please adjust the other frequencies.

Maintenance

Avoid Excessive Heat

Don't leave transmitter or receiver in hot sun, on a radiator, or near other sources of high temperature.

Avoid Rough Handling

Transmitter and receiver may be damaged if dropped.

Fully Charge Batteries

Before storing, please fully charge the batteries in both transmitter and receiver. If possible, please recharge once a month during storage and again before first use.

Remove Batteries

Remove the internal batteries when storing the unit for a long break or vacation.

Replace Batteries

Danger of explosion if the batteries are incorrectly replaced.
Replace only with the same or the equivalent type.

Battery Terminals

Keep the contacts clean and inspect them often to ensure they are not corroded. If they become corroded, polish them with a pencil eraser.

CAUTION

Danger of explosion if the battery is incorrectly replaced.
Replace only with the same or the equivalent type.



Specifications

Portable Amplifier Speaker

◦ Sensitivity	95 dB, 1Watt @ 1 M
◦ Maximum SPL	112 dB
◦ Frequency response	20 Hz ~ 20 kHz (audio)
◦ Spears	8" LF woofer, 1" HF horn
◦ Receiver module	DR-701 * 2 @ diversity
◦ Output power	50 W RMS, 80 W MAX.
◦ Signal to noise ratio	Up 70 dB
◦ CD/MP3 player	Built-in
◦ Audio link TX	Built-in TX-701 transmitter
◦ Audio input	XLR-Mic. In, RCA-Line in
◦ Audio output	RCA-Line out, SPK Out (unswitched)
◦ Control volume	Mic., Line, Bass, Treble, Master
◦ Power requirement	96-264V AC/32V DC, switching power supply
◦ Battery	12V, 2.9Ah* 2 (Lead-Acid) rechargeable batteries
◦ Operating life	3 ~ 4 Hours
◦ Charging time	4 ~ 6 Hours
◦ Dimensions (D*W*H)	300 * 230 * 470 mm
◦ Weight	12 kg

Bodypack Transmitter

◦ Mike	Condenser mic.
◦ RF output	10mW (according to regulation)
◦ Spurious emission	Less than 250 mW
◦ Display status	LCD indicator displays channel or frequency, battery life
◦ Channel select	SET, UP, DOWN key
◦ AF controls	Mute switch, Hi/Mid/Low switch
◦ Audio input	Mic in, Aux in
◦ Battery	1.2 V (Ni-MH 1300 mAh) * 2 AA type rechargeable battery 1.5V * 2 AA Alkaline disposable
◦ Battery life Ni-MH rechargeable	11 hours typical
◦ Battery life Alkaline disposable	14 hours typical
◦ Housing	Aluminium
◦ Dimensions (L * W * H)	88 * 64 * 24 mm
◦ Weight with battery	170 g

Handheld Microphone

◦ Mike	Cordiod condenser capsule or dynamic capsule
◦ RF output	10mW (according to regulation)
◦ Spurious emission	Less than 250 nW
◦ Display status	LCD indicator displays channel or frequency, battery life
◦ Channel select	SET, UP, DOWN key
◦ AF controls	Hi/Low/Mute switch
◦ Battery	1.2 V (Ni-MH 1300 mAh) * 2 AA type rechargeable battery 1.5V * 2 AA Alkaline disposable
◦ Battery life Ni-MH rechargeable	11 hours typical
◦ Battery life Alkaline disposable	14 hours typical
◦ Antenna	Built-in
◦ Dimensions (Dia * L)	46 * 264 mm
◦ Weight with battery	280 g

Audio Link Transmitter Module

◦ RF output	10mW or 30mW (according to regulation)
◦ Spurious emission	Less than 250 nW
◦ Display status	LCD indicator displays channel or frequency
◦ Channel select	SET, UP, DOWN key
◦ Antenna	Built-in or external
◦ Dimensions (L * W * H)	88 * 64 * 24 mm
◦ Weight	170 g

Receiver Module

◦ Antenna mode	Diversity
◦ Sensitivity	4 μ V @ 30 dB SINAD
◦ Double intermediate	110.6 Mhz / 10.7 MHz
◦ Display status	LCD indicator displays channel or frequency
◦ Channel select	SET, UP, DOWN key
◦ RF spurious rejection	70 dB
◦ Adjacent channel performance	68 dB @ 250kHz
◦ IMD rejection	58 dB
◦ Antenna	Built-in or external
◦ Dimensions (L * W * H)	128 * 88 * 37 mm
◦ Weight	110 g

Digital Echo Module

◦ Input sensitivity	10 mV
◦ Delay time	340 ms ~ 110 ms
◦ Audio input	6.3 ϕ -Mic in * 2
◦ Controls	Echo, Repeat, Delay, MIC1, MIC2

Key Specifications / Overall System

◦ Oscillation type	PLL synthesized control OSC
◦ Carrier frequency range	Group 1. 740 ~ 752 MHz (96 ch.) Group 2. 794 ~ 806 MHz (96 ch.) Group 3. 863 ~ 865 MHz (16 ch.)
◦ Adjustable frequency	Pre-programmed max. 96 switchable channels
◦ Switching bandwidth	Max. 12 MHz
◦ Ambient temperature	-10 °C ~ 50 °C
◦ Maximum deviation	50 kHz, with level limiting
◦ Dynamic range	110 dB
◦ T. H. D.	Less than 0.5%
◦ Pre/De- emphasis	50 μ s
◦ Squelch	Tone key and noise lock dual-squelch
◦ Frequency response	70 Hz ~ 16 kHz (wireless)
◦ Operating range	50 ~ 70 M (open field) with built-in antenna

Notice : The changes or modifications not expressly approved by the party responsible for compliance could void the user's authority to operate the equipment.

IMPORTANT NOTE: To comply with the FCC RF exposure compliance requirements, no change to the antenna or the device is permitted. Any change to the antenna or the device could result in the device exceeding the RF.