



Hermon Laboratories Ltd.
P.O. Box 23, Binyamina 3055001, Israel
Tel. +972 4628 8001
Fax. +972 4628 8277
E-mail: mail@hermonlabs.com

TEST REPORT

ACCORDING TO: FCC 47CFR part 15 subpart C § 15.247 (DTS) and subpart B,
RSS-247 issue 2, RSS-Gen issue 5, ICES-003 Issue 6

FOR:

ST Engineering Telematics Wireless Ltd.
Water meter sequencer
Model: Sequencer
FCC ID: NTASQUNCR
IC: 4732A-SQUNCR

This report is in conformity with ISO/IEC 17025. The "A2LA Accredited" symbol endorsement applies only to the tests and calibrations that are listed in the scope of Hermon Laboratories accreditation. The test results relate only to the items tested. This test report shall not be reproduced in any form except in full with the written approval of Hermon Laboratories Ltd.

Table of contents

1	Applicant information	3
2	Equipment under test attributes	3
3	Manufacturer information	3
4	Test details	3
5	Tests summary	4
6	EUT description	5
6.1	General information	5
6.2	Test configuration	5
6.3	Changes made in EUT	5
6.4	Transmitter characteristics	6
7	Transmitter tests according to 47CFR part 15 subpart C and RSS-247 requirements	7
7.1	Minimum 6 dB bandwidth	7
7.2	Peak output power	11
7.3	Field strength of spurious emissions	15
7.4	Band edge emissions at RF antenna connector	30
7.5	Maximum power spectral density (PSD)	33
7.6	Conducted emissions	37
7.7	Antenna requirements	40
8	Unintentional emissions	41
8.1	Conducted emissions	41
8.2	Radiated emission measurements	46
9	APPENDIX A Test equipment and ancillaries used for tests	51
10	APPENDIX B Measurement uncertainties	52
11	APPENDIX C Test laboratory description	53
12	APPENDIX D Specification references	53
13	APPENDIX E Test equipment correction factors	54
14	APPENDIX F Abbreviations and acronyms	64

1 Applicant information

Client name: ST Engineering Telematics Wireless Ltd.
Address: 26 Hamelacha street, POB 1911, Holon, 5811801, Israel
Telephone: +972 3557 5700
Fax: +972 3557 5703
E-mail: itsikk@telematics-wireless.com
Contact name: Mr. Itsik Kanner

2 Equipment under test attributes

Product name: Water meter sequencer
Product type: Transceiver
Model(s): Sequencer
Serial number: 20212
Hardware version: REV A
Software release: 10.03
Receipt date 22-Feb-21

3 Manufacturer information

Manufacturer name: ST Engineering Telematics Wireless Ltd.
Address: 26 Hamelacha street, POB 1911, Holon, 5811801, Israel
Telephone: +972 3557 5700
Fax: +972 3557 5703
E-Mail: itsikk@telematics-wireless.com
Contact name: Mr. Itsik Kanner

4 Test details

Project ID: 41612
Location: Hermon Laboratories Ltd. P.O. Box 23, Binyamina 3055001, Israel
Test started: 28-Feb-21
Test completed: 30-Mar-21
Test specification(s): FCC 47CFR part 15 subpart C § 15.247 (DTS), subpart B;
RSS-247 issue 2, RSS-Gen issue 5, ICES-003 Issue 6: 2019 (updated)



5 Tests summary

Test	Status
Transmitter characteristics	
FCC section 15.247(a)(2) / RSS-247 section 5.2(a), 6 dB bandwidth	Pass
FCC section 15.247(b)(3) / RSS-247 section 5.4(d), Peak output power	Pass
FCC section 15.247(i) / RSS-102 section 2.5.2, RF exposure	Pass, the exhibit to the application of certification is provided
FCC section 15.247(d) / RSS-247 section 5.5, Radiated spurious emissions	Pass
FCC section 15.247(d) / RSS-247 section 5.5, Emissions at band edges	Pass
FCC section 15.247(e) / RSS-247 section 5.2(b), Peak power density	Pass
FCC section 15.203 / RSS-Gen section 6.8, Antenna requirement	Pass
FCC section 15.207(a) / RSS-Gen section 8.8, Conducted emission	Pass
Unintentional emissions	
FCC section 15.107 / ICES-003, Section 6.1, Class B, Conducted emission at AC power port	Pass
FCC section 15.109 / RSS-Gen section 7.3 / ICES-003, Section 6.2, Class B, Radiated emission	Pass

Testing was completed against all relevant requirements of the test standard. The results obtained indicate that the product under test complies in full with the requirements tested.

The test results relate only to the items tested. Pass/ fail decision was based on nominal values.

This test report supersedes the previously issued test report identified by Doc ID: TELRAD_FCC.41612.

	Name and Title	Date	Signature
Tested by:	Mrs. E. Pitt, test engineer	March 30, 2021	
Reviewed by:	Mrs. M. Cherniavsky, certification engineer	April 5, 2021	
Approved by:	Mr. S. Samokha, Technical Manager, EMC and Radio	April 28, 2021	

6 EUT description

Note: The following data in this clause is provided by the customer and represents his sole responsibility

6.1 General information

The EUT, Sequencer, communicates with water meters in LoRa system. The operating frequency band is 902 to 928 MHz, LoRa type of modulation, 500 kHz (DTS).

6.2 Test configuration

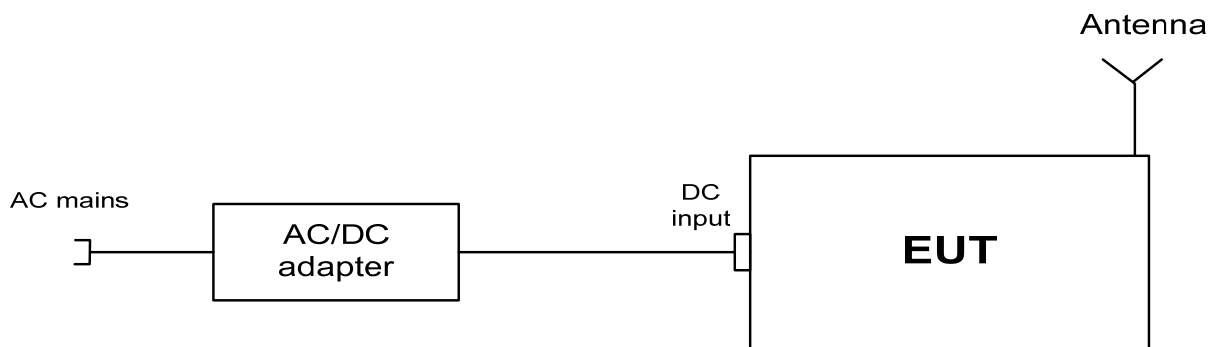

6.3 Changes made in EUT

No changes were implemented in the EUT during testing.



6.4 Transmitter characteristics

Type of equipment						
X	Stand-alone (Equipment with or without its own control provisions)					
	Combined equipment (Equipment where the radio part is fully integrated within another type of equipment)					
	Plug-in card (Equipment intended for a variety of host systems)					
Intended use		Condition of use				
	fixed	Always at a distance more than 2 m from all people				
X	mobile	Always at a distance more than 20 cm from all people				
	portable	May operate at a distance closer than 20 cm to human body				
Assigned frequency range		902-928 MHz				
Operating frequency range		903-927 MHz				
Maximum rated output power		At transmitter 50 Ω RF output connector		NA		
		Peak output power		20.7 dBm		
Is transmitter output power variable?		X	No			
			Yes	continuous variable		
			Yes	stepped variable with stepsize		dB
			Yes	minimum RF power		dBm
			Yes	maximum RF power		dBm
Antenna connection						
unique coupling	X	standard connector	integral	with temporary RF connector		
				without temporary RF connector		
Antenna/s technical characteristics						
Type	Manufacturer		Model number		Gain	
Omni directional	Kenbotong Communication Ltd.		TQX-900LC		2.5 dBi	
Transmitter aggregate data rate/s		46875 bps				
Type of modulation		LoRa				
Modulating test signal (baseband)		PRBS				
Transmitter power source						
	Battery	Nominal rated voltage	VDC	Battery type		
	DC	Nominal rated voltage	VDC			
X	AC mains	Nominal rated voltage	120 VAC	Frequency	60 Hz	
Common power source for transmitter and receiver			X	yes	no	



Test specification: Section 15.247(a)(2) / RSS-247 section 5.2(a), 6 dB bandwidth			
Test procedure: ANSI C63.10 section 11.8.1			
Test mode: Compliance		Verdict: PASS	
Date(s): 28-Feb-21			
Temperature: 25 °C	Relative Humidity: 48 %	Air Pressure: 1019 hPa	Power: 120 VAC
Remarks:			

7 Transmitter tests according to 47CFR part 15 subpart C and RSS-247 requirements

7.1 Minimum 6 dB bandwidth

7.1.1 General

This test was performed to measure 6 dB bandwidth of the EUT carrier frequency. Specification test limits are given in Table 7.1.1.

Table 7.1.1 The 6 dB bandwidth limits

Assigned frequency, MHz	Modulation envelope reference points*, dBc	Minimum bandwidth, kHz
902.0 – 928.0	6.0	500.0
2400.0 – 2483.5		
5725.0 – 5850.0		

* - Modulation envelope reference points provided in terms of attenuation below the peak of modulated carrier.

7.1.2 Test procedure

7.1.2.1 The EUT was set up as shown in Figure 7.1.1, energized and its proper operation was checked.

7.1.2.2 The EUT was set to transmit modulated carrier.

7.1.2.3 The transmitter minimum 6 dB bandwidth was measured with spectrum analyzer as frequency delta between reference points on modulation envelope and provided in Table 7.1.2 and associated plot.

Figure 7.1.1 The 6 dB bandwidth test setup

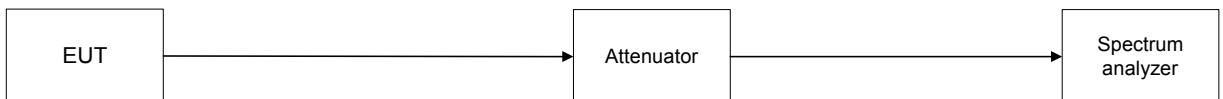



Test specification: Section 15.247(a)(2) / RSS-247 section 5.2(a), 6 dB bandwidth			
Test procedure: ANSI C63.10 section 11.8.1			
Test mode: Compliance		Verdict: PASS	
Date(s): 28-Feb-21			
Temperature: 25 °C	Relative Humidity: 48 %	Air Pressure: 1019 hPa	Power: 120 VAC
Remarks:			

Table 7.1.2 The 6 dB bandwidth test results

ASSIGNED FREQUENCY BAND: 902.0 – 928.0MHz
DETECTOR USED: Peak
SWEEP MODE: Max hold
SWEEP TIME: Auto
RESOLUTION BANDWIDTH: 100 kHz
VIDEO BANDWIDTH: 300 kHz
MODULATION ENVELOPE REFERENCE POINTS: 6.0 dBc
MODULATION: LoRa
BIT RATE: 46875 bps

Carrier frequency, MHz	6 dB bandwidth, kHz	Limit, kHz	Margin, kHz	Verdict
Low frequency				
903.0	610.152	500.0	110.152	Pass
Mid frequency				
915.0	607.691	500.0	110.152	Pass
High frequency				
927.0	608.634	500.0	110.152	Pass

Reference numbers of test equipment used

HL 3818	HL 3902	HL 4135	HL 5589				
---------	---------	---------	---------	--	--	--	--

Full description is given in Appendix A.



Test specification: Section 15.247(a)(2) / RSS-247 section 5.2(a), 6 dB bandwidth			
Test procedure: ANSI C63.10 section 11.8.1			
Test mode: Compliance		Verdict: PASS	
Date(s): 28-Feb-21			
Temperature: 25 °C	Relative Humidity: 48 %	Air Pressure: 1019 hPa	Power: 120 VAC
Remarks:			

Plot 7.1.1 The 6 dB bandwidth test result at low frequency

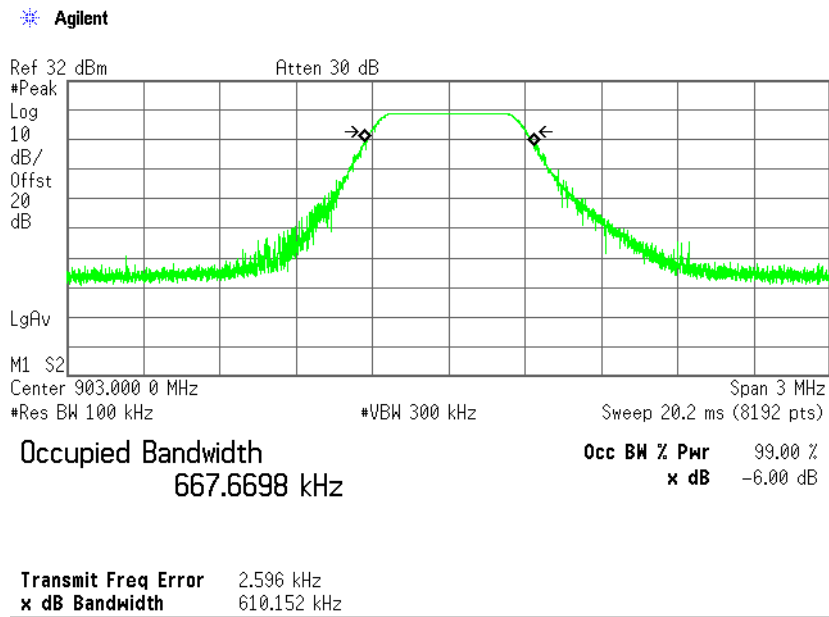

Plot 7.1.2 The 6 dB bandwidth test result at mid frequency

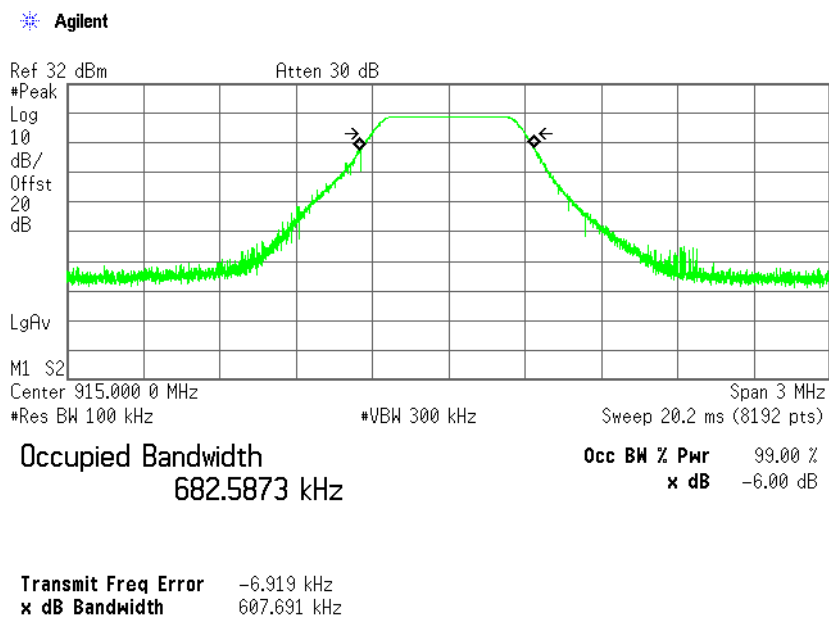



HERMON LABORATORIES

Test specification: Section 15.247(a)(2) / RSS-247 section 5.2(a), 6 dB bandwidth			
Test procedure: ANSI C63.10 section 11.8.1			
Test mode: Compliance		Verdict: PASS	
Date(s): 28-Feb-21			
Temperature: 25 °C	Relative Humidity: 48 %	Air Pressure: 1019 hPa	Power: 120 VAC
Remarks:			

Plot 7.1.3 The 6 dB bandwidth test result at high frequency

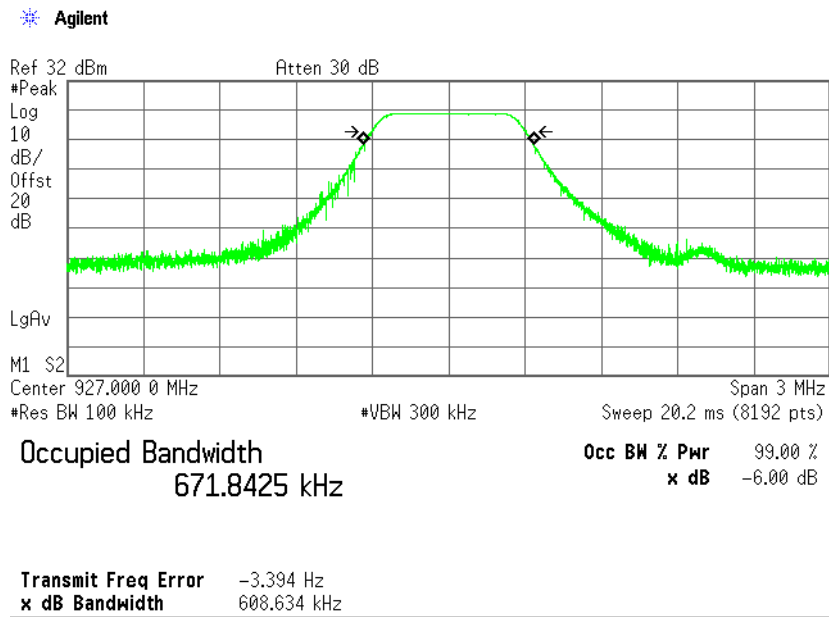



Test specification: Section 15.247(b)(3) / RSS-247 section 5.4(d), Maximum output power			
Test procedure: ANSI C63.10 section 11.9.2.2.4			
Test mode: Compliance		Verdict: PASS	
Date(s): 14-Mar-21			
Temperature: 25 °C	Relative Humidity: 49 %	Air Pressure: 1013 hPa	Power: 120 VAC
Remarks:			

7.2 Peak output power

7.2.1 General

This test was performed to measure the maximum peak output power at the transmitter RF antenna connector. Specification test limits are given in Table 7.2.1.

Table 7.2.1 Peak output power limits

Assigned frequency range, MHz	Maximum antenna gain, dBi	Peak output power*	
		W	dBm
902.0 – 928.0	6.0	1.0	30.0
2400.0 – 2483.5			
5725.0 – 5850.0			

*- If transmitting antennas of directional gain greater than 6 dBi are used, the peak output power limit shall be reduced below the stated value as follows:

by 1 dB for every 3 dB that the directional gain of antenna exceeds 6 dBi for fixed point-to-point transmitters operate in 2400-2483.5 MHz band;

without any corresponding reduction for fixed point-to-point transmitters operate in 5725-5850 MHz band;
by the amount in dB that the directional gain of antenna exceeds 6 dBi for the rest of transmitters.

7.2.2 Test procedure

7.2.2.1 The EUT was set up as shown in Figure 7.2.1, energized and its proper operation was checked.

7.2.2.2 The EUT was adjusted to produce maximum available for end user RF output power.

7.2.2.3 The resolution bandwidth of spectrum analyzer was set wider than 6 dB bandwidth of the EUT and the maximum peak output power was measured as provided in Table 7.2.2 and associated plots.

Figure 7.2.1 Peak output power test setup

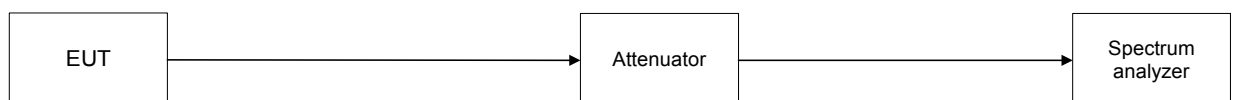



Test specification: Section 15.247(b)(3) / RSS-247 section 5.4(d), Maximum output power			
Test procedure: ANSI C63.10 section 11.9.2.2.4			
Test mode: Compliance		Verdict: PASS	
Date(s): 14-Mar-21			
Temperature: 25 °C	Relative Humidity: 49 %	Air Pressure: 1013 hPa	Power: 120 VAC
Remarks:			

Table 7.2.2 Peak output power test results

ASSIGNED FREQUENCY: 902.0 – 928.0MHz
 MODULATION: LoRa
 MODULATING SIGNAL: PRBS
 BIT RATE: 46875 bps
 TRANSMITTER OUTPUT POWER SETTINGS: Maximum
 DETECTOR USED: Peak
 EUT 6 dB BANDWIDTH: 0.62 MHz
 RESOLUTION BANDWIDTH: 1 MHz
 VIDEO BANDWIDTH: 3 MHz

Carrier frequency, MHz	Spectrum analyzer reading, dBm	External attenuation, dB	Cable loss, dB	Peak output power, dBm	Limit, dBm	Margin*, dB	Verdict
903.00	20.63	Included	Included	20.63	30.0	-9.37	Pass
915.00	20.70	Included	Included	20.70	30.0	-9.30	Pass
927.00	20.35	Included	Included	20.35	30.0	-9.65	Pass

* - Margin = Peak output power – specification limit.

Note: Maximum peak output power was obtained at Unom input power voltage.

Reference numbers of test equipment used

HL 3901	HL 4135	HL 4355	HL 5626				
---------	---------	---------	---------	--	--	--	--

Full description is given in Appendix A.



HERMON LABORATORIES

Test specification: Section 15.247(b)(3) / RSS-247 section 5.4(d), Maximum output power			
Test procedure: ANSI C63.10 section 11.9.2.2.4			
Test mode: Compliance		Verdict: PASS	
Date(s): 14-Mar-21			
Temperature: 25 °C	Relative Humidity: 49 %	Air Pressure: 1013 hPa	Power: 120 VAC
Remarks:			

Plot 7.2.1 Peak output power at low frequency and Unom

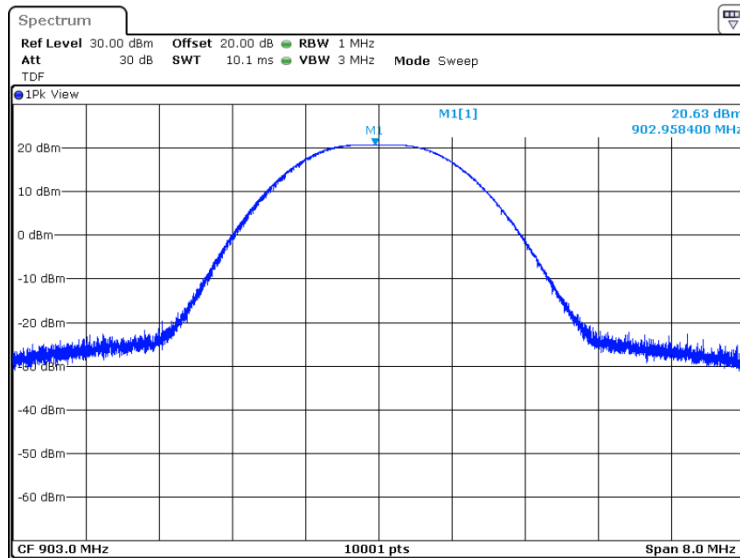

Plot 7.2.2 Peak output power at mid frequency and Unom

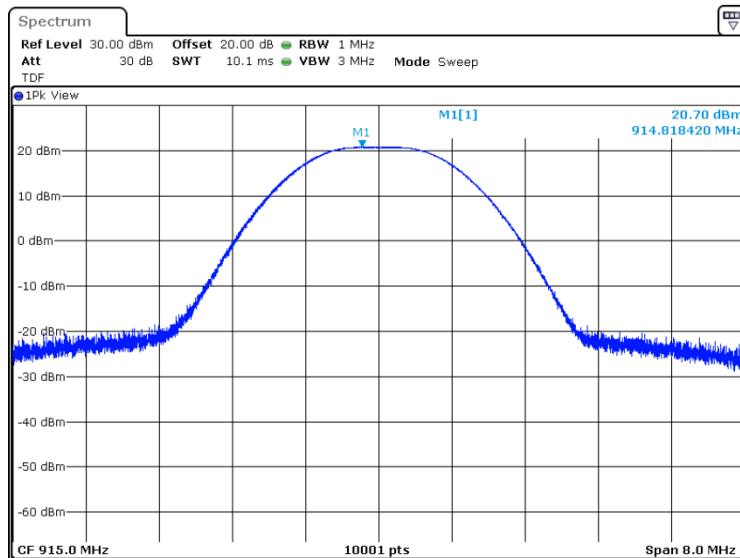



HERMON LABORATORIES

Test specification: Section 15.247(b)(3) / RSS-247 section 5.4(d), Maximum output power			
Test procedure: ANSI C63.10 section 11.9.2.2.4			
Test mode: Compliance		Verdict: PASS	
Date(s): 14-Mar-21			
Temperature: 25 °C	Relative Humidity: 49 %	Air Pressure: 1013 hPa	Power: 120 VAC
Remarks:			

Plot 7.2.3 Peak output power at high frequency and Unom

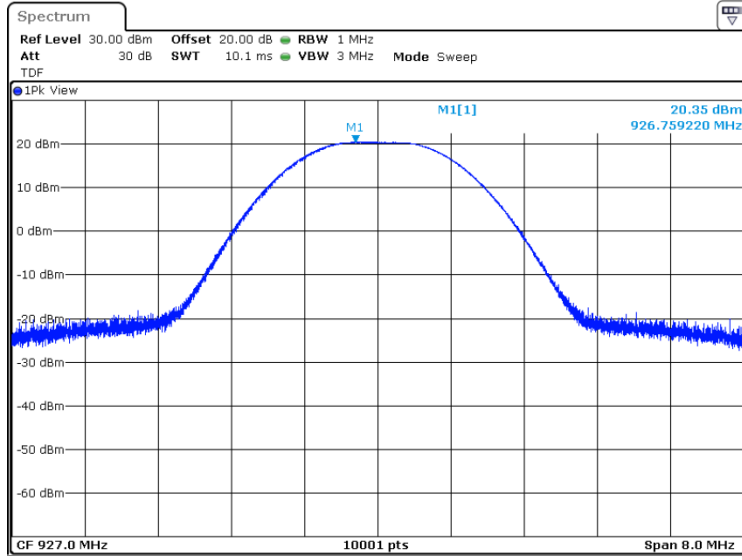



Test specification: Section 15.247(d) / RSS-247 section 5.5, Radiated spurious emissions			
Test procedure: ANSI C63.10 section 11.12.1			
Test mode: Compliance		Verdict: PASS	
Date(s): 30-Mar-21			
Temperature: 23 °C	Relative Humidity: 50 %	Air Pressure: 1012 hPa	Power: 120 VAC
Remarks:			

7.3 Field strength of spurious emissions

7.3.1 General

This test was performed to measure field strength of spurious emissions from the EUT. Specification test limits are given in Table 7.3.1.

Table 7.3.1 Radiated spurious emissions limits

Frequency, MHz	Field strength at 3 m within restricted bands, dB(μV/m)*			Attenuation of field strength of spurious versus carrier outside restricted bands, dBc***
	Peak	Quasi Peak	Average	
0.009 – 0.090	148.5 – 128.5	NA	128.5 – 108.5**	20.0
0.090 – 0.110	NA	108.5 – 106.8**	NA	
0.110 – 0.490	126.8 – 113.8	NA	106.8 – 93.8**	
0.490 – 1.705	NA	73.8 – 63.0**	NA	
1.705 – 30.0*		69.5		
30 – 88		40.0		
88 – 216		43.5		
216 – 960		46.0		
960 - 1000		54.0		
1000 – 10 th harmonic	74.0	NA	54.0	

*- The limit for 3 m test distance was calculated using the inverse square distance extrapolation factor as follows:

$$\text{Lim}_{S_2} = \text{Lim}_{S_1} + 40 \log (S_1/S_2),$$

where S₁ and S₂ – standard defined and test distance respectively in meters.

** - The limit decreases linearly with the logarithm of frequency.

*** - The field strength limits applied from the lowest radio frequency generated in the device, without going below 9 kHz up to the tenth harmonic of the highest fundamental frequency.

7.3.2 Test procedure for spurious emission field strength measurements in 9 kHz to 30 MHz band

7.3.2.1 The EUT was set up as shown in Figure 7.3.1, energized and the performance check was conducted.

7.3.2.2 The specified frequency range was investigated with antenna connected to spectrum analyzer/ EMI receiver. To find maximum radiation the turntable was rotated 360° and the measuring antenna was rotated around its vertical axis.

7.3.2.3 The worst test results (the lowest margins) were recorded and shown in the associated plots.

7.3.3 Test procedure for spurious emission field strength measurements above 30 MHz

7.3.3.1 The EUT was set up as shown in Figure 7.3.2, Figure 7.3.3, energized and the performance check was conducted.

7.3.3.2 The specified frequency range was investigated with antenna connected to spectrum analyzer/ EMI receiver. To find maximum radiation the turntable was rotated 360°, the measuring antenna height was changed from 1 to 4 m, its polarization was switched from vertical to horizontal.

7.3.3.3 The worst test results (the lowest margins) were recorded and shown in the associated plots.



Test specification: Section 15.247(d) / RSS-247 section 5.5, Radiated spurious emissions			
Test procedure: ANSI C63.10 section 11.12.1			
Test mode: Compliance		Verdict: PASS	
Date(s): 30-Mar-21			
Temperature: 23 °C	Relative Humidity: 50 %	Air Pressure: 1012 hPa	Power: 120 VAC
Remarks:			

Figure 7.3.1 Setup for spurious emission field strength measurements below 30 MHz

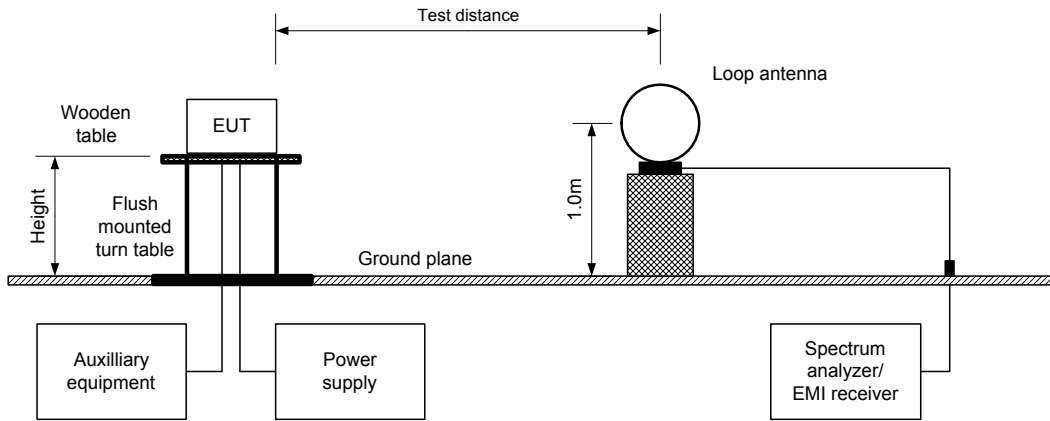
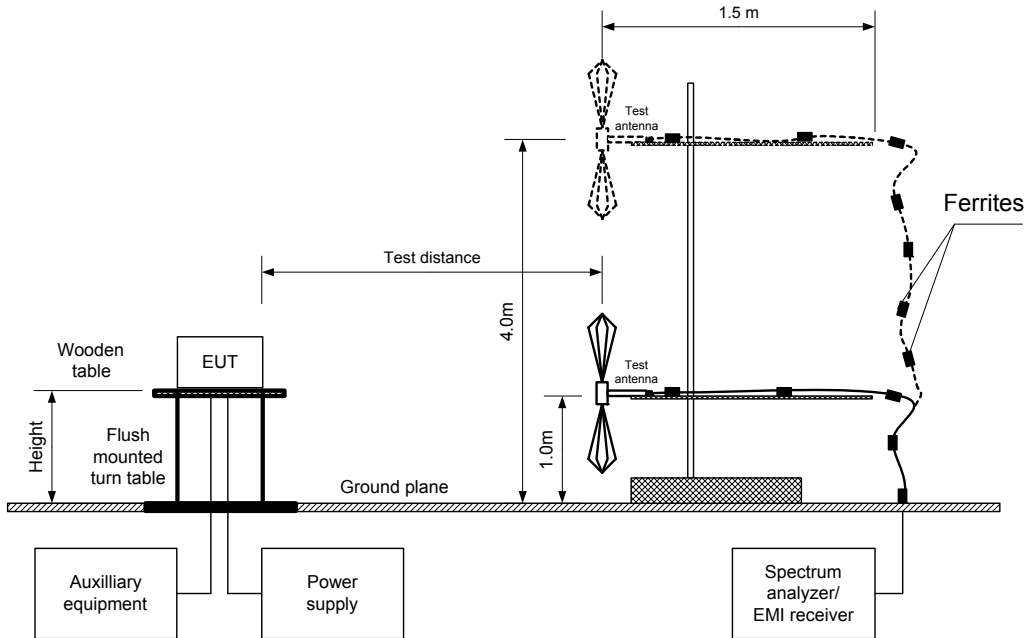

Figure 7.3.2 Setup for spurious emission field strength measurements in 30 -1000 MHz





Test specification: Section 15.247(d) / RSS-247 section 5.5, Radiated spurious emissions			
Test procedure: ANSI C63.10 section 11.12.1			
Test mode: Compliance		Verdict: PASS	
Date(s): 30-Mar-21			
Temperature: 23 °C	Relative Humidity: 50 %	Air Pressure: 1012 hPa	Power: 120 VAC
Remarks:			

Figure 7.3.3 Setup for spurious emission field strength measurements above 1000 MHz

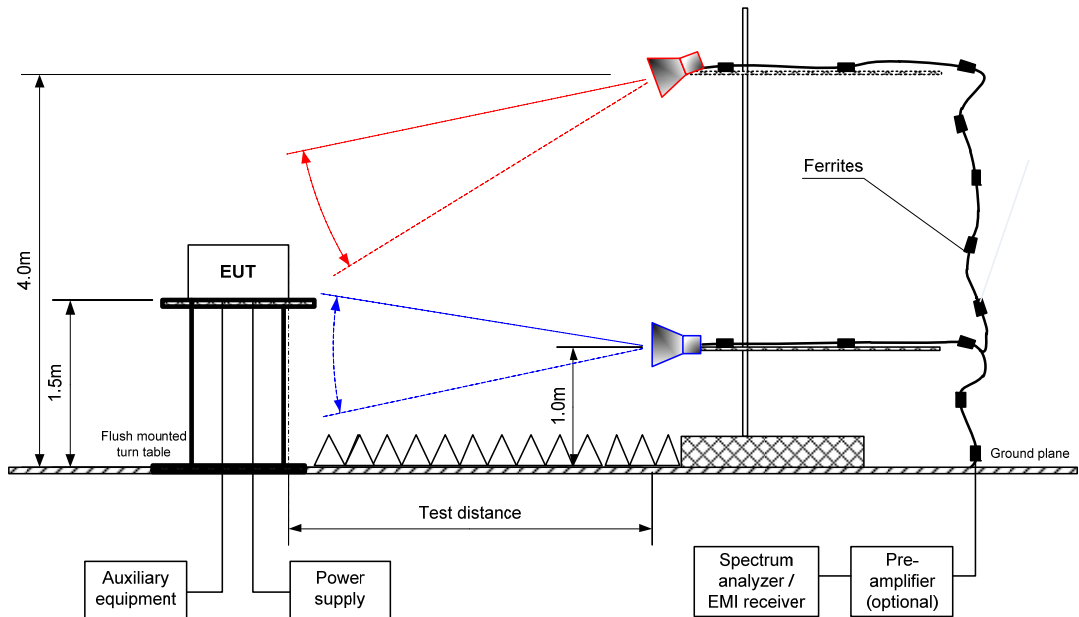



Test specification: Section 15.247(d) / RSS-247 section 5.5, Radiated spurious emissions			
Test procedure: ANSI C63.10 section 11.12.1			
Test mode: Compliance		Verdict: PASS	
Date(s): 30-Mar-21			
Temperature: 23 °C	Relative Humidity: 50 %	Air Pressure: 1012 hPa	Power: 120 VAC
Remarks:			

Table 7.3.2 Field strength of emissions outside restricted bands

ASSIGNED FREQUENCY: 902.0 -928.0MHz
 INVESTIGATED FREQUENCY RANGE: 0.009 -10000 MHz
 TEST DISTANCE: 3 m
 MODULATION: LoRa
 BIT RATE: 46875 bps
 TRANSMITTER OUTPUT POWER SETTINGS: Maximum
 DETECTOR USED: Peak
 RESOLUTION BANDWIDTH: 100 kHz
 VIDEO BANDWIDTH: 300 kHz
 TEST ANTENNA TYPE: Active loop (9 kHz – 30 MHz)
 Biconilog (30 MHz – 1000 MHz)
 Double ridged guide (above 1000 MHz)

Frequency, MHz	Field strength of spurious, dB(µV/m)	Antenna polarization	Antenna height, m	Azimuth, degrees*	Field strength of carrier, dB(µV/m)	Attenuation below carrier, dBc	Limit, dBc	Margin, dB**	Verdict
1806	49.8	Vertical	1.7	-180	114.4	64.6	20.0	44.6	Pass
1830	53.8	Vertical	1.5	-164	107.7	53.9		33.9	
1854	61.3	Vertical	1.5	-172	106.8	45.5		25.5	

*- EUT front panel refers to 0 degrees position of turntable.

**- Margin = Attenuation below carrier – specification limit.



Test specification: Section 15.247(d) / RSS-247 section 5.5, Radiated spurious emissions			
Test procedure: ANSI C63.10 section 11.12.1			
Test mode: Compliance		Verdict: PASS	
Date(s): 30-Mar-21			
Temperature: 23 °C	Relative Humidity: 50 %	Air Pressure: 1012 hPa	Power: 120 VAC
Remarks:			

Table 7.3.3 Field strength of spurious emissions above 1 GHz within restricted bands

ASSIGNED FREQUENCY BAND: 902.0 -928.0MHz
 INVESTIGATED FREQUENCY RANGE: 0.009 -10000 MHz
 TEST DISTANCE: 3 m
 MODULATION: LoRa
 BIT RATE: 46875 bps
 TRANSMITTER OUTPUT POWER SETTINGS: Maximum
 DETECTOR USED: Peak
 RESOLUTION BANDWIDTH: 1000 kHz
 TEST ANTENNA TYPE: Double ridged guide

Frequency, MHz	Antenna			Peak field strength			Average field strength				Verdict
	Polarization	Height, m	Azimuth, degrees*	Measured, dB(µV/m)	Limit, dB(µV/m)	Margin, dB**	Measured, dB(µV/m)	Calculated, dB(µV/m)	Limit, dB(µV/m)	Margin, dB***	
Low carrier frequency											
2709	Vertical	1.7	-172	42.8	74	-31.2	42.8	22.5	54	-31.5	Pass
id carrier frequency											
2745	Vertical	1.5	-164	43.4	74	-30.6	43.4	23.1	54	-30.9	Pass
High carrier frequency											
2781	Vertical	1.5	-180	60.1	74	-13.9	60.1	39.8	54	-14.2	Pass

*- EUT front panel refers to 0 degrees position of turntable.
 **- Margin = Measured field strength - specification limit.
 ***- Margin = Calculated field strength - specification limit,
 where Calculated field strength = Measured field strength + average factor.

Table 7.3.4 Average factor calculation

Transmission pulse		Transmission burst		Transmission train duration, ms	Average factor, dB
Duration, ms	Number of pulses during 100 msec	Duration, ms	Period, ms		
9.615	1.0	NA	NA	NA	-20.34

*- Average factor was calculated as follows
 for pulse train shorter than 100 ms: $Average\ factor = 20 \times \log_{10} \left(\frac{Pulse\ duration}{Pulse\ period} \times \frac{Burst\ duration}{Train\ duration} \times Number\ of\ bursts\ within\ pulse\ train \right)$
 for pulse train longer than 100 ms: $Average\ factor = 20 \times \log_{10} \left(\frac{Pulse\ duration}{Pulse\ period} \times \frac{Burst\ duration}{100ms} \times Number\ of\ bursts\ within\ 100ms \right)$



Test specification: Section 15.247(d) / RSS-247 section 5.5, Radiated spurious emissions			
Test procedure: ANSI C63.10 section 11.12.1			
Test mode: Compliance		Verdict: PASS	
Date(s): 30-Mar-21			
Temperature: 23 °C	Relative Humidity: 50 %	Air Pressure: 1012 hPa	Power: 120 VAC
Remarks:			

Table 7.3.5 Field strength of spurious emissions below 1 GHz within restricted bands

ASSIGNED FREQUENCY:	902.0 -928.0MHz
INVESTIGATED FREQUENCY RANGE:	0.009 -10000 MHz
TEST DISTANCE:	3 m
MODULATION:	LoRa
BIT RATE:	46875 bps
DUTY CYCLE:	Maximum
TRANSMITTER OUTPUT POWER SETTINGS:	902.0 -928.0MHz
RESOLUTION BANDWIDTH:	1.0 kHz (9 kHz – 150 kHz) 9.0 kHz (150 kHz – 30 MHz) 120 kHz (30 MHz – 1000 MHz)
VIDEO BANDWIDTH:	> Resolution bandwidth
TEST ANTENNA TYPE:	Active loop (9 kHz – 30 MHz) Biconilog (30 MHz – 1000 MHz)

Frequency, MHz	Peak emission, dB(μV/m)	Quasi-peak			Antenna polarization	Antenna height, m	Turn-table position**, degrees	Verdict
		Measured emission, dB(μV/m)	Limit, dB(μV/m)	Margin, dB*				
Low carrier frequency								
37.828595	30.38	22.50	40.00	-17.50	V	1.00	-167.0	Pass
Mid carrier frequency								
38.011939	29.45	21.59	40.00	-18.41	V	1.02	57.0	Pass
High carrier frequency								
38.145104	32.73	25.08	40.00	-14.92	V	1.02	161.0	Pass

*- Margin = Measured emission - specification limit.

**- EUT front panel refer to 0 degrees position of turntable.

Reference numbers of test equipment used

HL 0446	HL 3903	HL 4355	HL 4360	HL 5085	HL 5288	HL 5902	HL 4339
---------	---------	---------	---------	---------	---------	---------	---------

Full description is given in Appendix A.



Test specification: Section 15.247(d) / RSS-247 section 5.5, Radiated spurious emissions			
Test procedure: ANSI C63.10 section 11.12.1			
Test mode: Compliance		Verdict: PASS	
Date(s): 30-Mar-21			
Temperature: 23 °C	Relative Humidity: 50 %	Air Pressure: 1012 hPa	Power: 120 VAC
Remarks:			

Table 7.3.6 Restricted bands according to FCC section 15.205

MHz	MHz	MHz	MHz	MHz	GHz
0.09 - 0.11	8.37625 - 8.38675	73 - 74.6	399.9 - 410	2690 - 2900	10.6 - 12.7
0.495 - 0.505	8.41425 - 8.41475	74.8 - 75.2	608 - 614	3260 - 3267	13.25 - 13.4
2.1735 - 2.1905	12.29 - 12.293	108 - 121.94	960 - 1240	3332 - 3339	14.47 - 14.5
4.125 - 4.128	12.51975 - 12.52025	123 - 138	1300 - 1427	3345.8 - 3358	15.35 - 16.2
4.17725 - 4.17775	12.57675 - 12.57725	149.9 - 150.05	1435 - 1626.5	3600 - 4400	17.7 - 21.4
4.20725 - 4.20775	13.36 - 13.41	156.52475 - 156.52525	1645.5 - 1646.5	4500 - 5150	22.01 - 23.12
6.215 - 6.218	16.42 - 16.423	156.7 - 156.9	1660 - 1710	5350 - 5460	23.6 - 24
6.26775 - 6.26825	16.69475 - 16.69525	162.0125 - 167.17	1718.8 - 1722.2	7250 - 7750	31.2 - 31.8
6.31175 - 6.31225	16.80425 - 16.80475	167.72 - 173.2	2200 - 2300	8025 - 8500	36.43 - 36.5
8.291 - 8.294	25.5 - 25.67	240 - 285	2310 - 2390	9000 - 9200	Above 38.6
8.362 - 8.366	37.5 - 38.25	322 - 335.4	2483.5 - 2500	9300 - 9500	

Table 7.3.7 Restricted bands according to RSS-Gen

MHz	MHz	MHz	MHz	MHz	GHz
0.09 - 0.11	8.291 - 8.294	16.80425 - 16.80475	399.9 - 410	3260 - 3267	10.6 - 12.7
2.1735 - 2.1905	8.362 - 8.366	25.5 - 25.67	608 - 614	3332 - 3339	13.25 - 13.4
3.020 - 3.026	8.37625 - 8.38675	37.5 - 38.25	960 - 1427	3345.8 - 3358	14.47 - 14.5
4.125 - 4.128	8.41425 - 8.41475	73 - 74.6	1435 - 1626.5	3500 - 4400	15.35 - 16.2
4.17725 - 4.17775	12.29 - 12.293	74.8 - 75.2	1645.5 - 1646.5	4500 - 5150	17.7 - 21.4
4.20725 - 4.20775	12.51975 - 12.52025	108 - 138	1660 - 1710	5350 - 5460	22.01 - 23.12
5.677 - 5.683	12.57675 - 12.57725	156.52475 - 156.52525	1718.8 - 1722.2	7250 - 7750	23.6 - 24
6.215 - 6.218	13.36 - 13.41	156.7 - 156.9	2200 - 2300	8025 - 8500	31.2 - 31.8
6.26775 - 6.26825	16.42 - 16.423	240 - 285	2310 - 2390	9000 - 9200	36.43 - 36.5
6.31175 - 6.31225	16.69475 - 16.69525	322 - 335.4	2655 - 2900	9300 - 9500	Above 38.6



Test specification: Section 15.247(d) / RSS-247 section 5.5, Radiated spurious emissions			
Test procedure: ANSI C63.10 section 11.12.1			
Test mode: Compliance		Verdict: PASS	
Date(s): 30-Mar-21			
Temperature: 23 °C	Relative Humidity: 50 %	Air Pressure: 1012 hPa	Power: 120 VAC
Remarks:			

Plot 7.3.1 Radiated emission measurements from 9 kHz to 30 MHz at the low carrier frequency

TEST SITE: Semi anechoic chamber
 TEST DISTANCE: 3 m
 ANTENNA POLARIZATION: Vertical

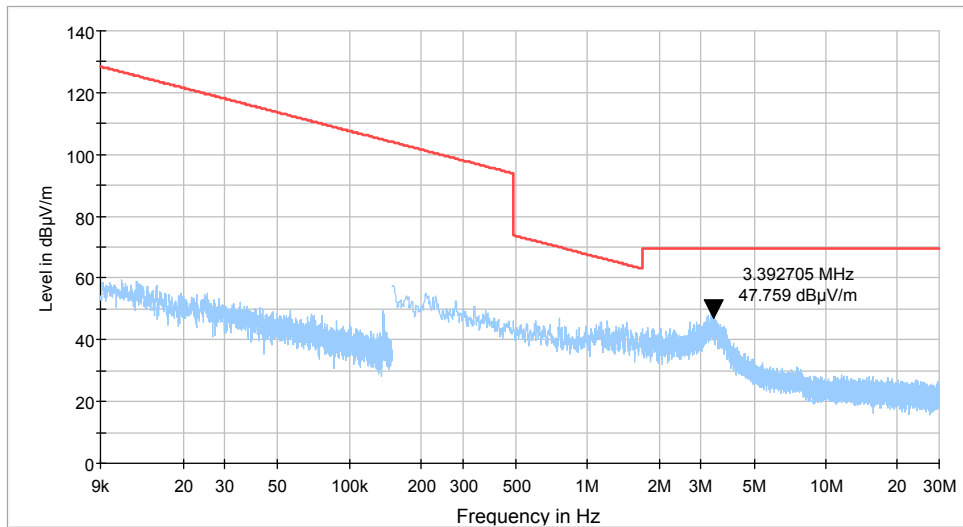

Plot 7.3.2 Radiated emission measurements from 9 kHz to 30 MHz at the mid carrier frequency

TEST SITE: Semi anechoic chamber
 TEST DISTANCE: 3 m
 ANTENNA POLARIZATION: Vertical

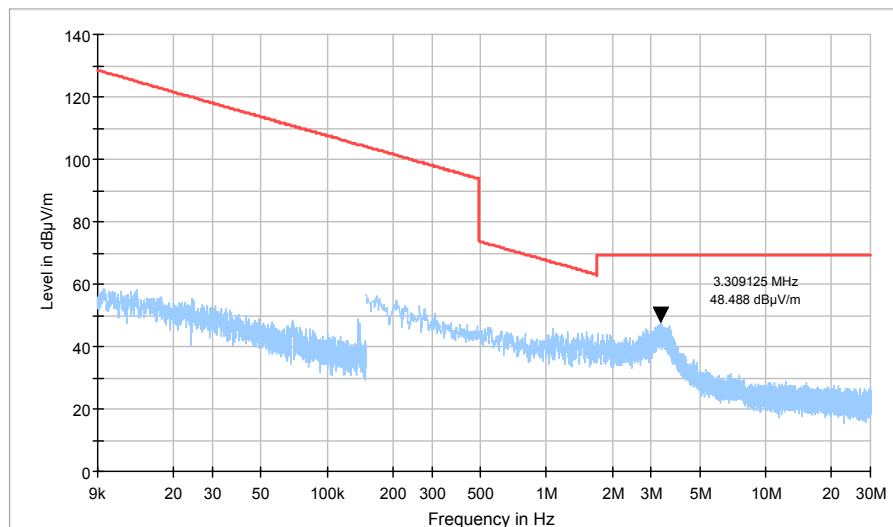



Test specification: Section 15.247(d) / RSS-247 section 5.5, Radiated spurious emissions			
Test procedure: ANSI C63.10 section 11.12.1			
Test mode: Compliance		Verdict: PASS	
Date(s): 30-Mar-21			
Temperature: 23 °C	Relative Humidity: 50 %	Air Pressure: 1012 hPa	Power: 120 VAC
Remarks:			

Plot 7.3.3 Radiated emission measurements from 9 kHz to 30 MHz at the high carrier frequency

TEST SITE: Semi anechoic chamber
 TEST DISTANCE: 3 m
 ANTENNA POLARIZATION: Vertical

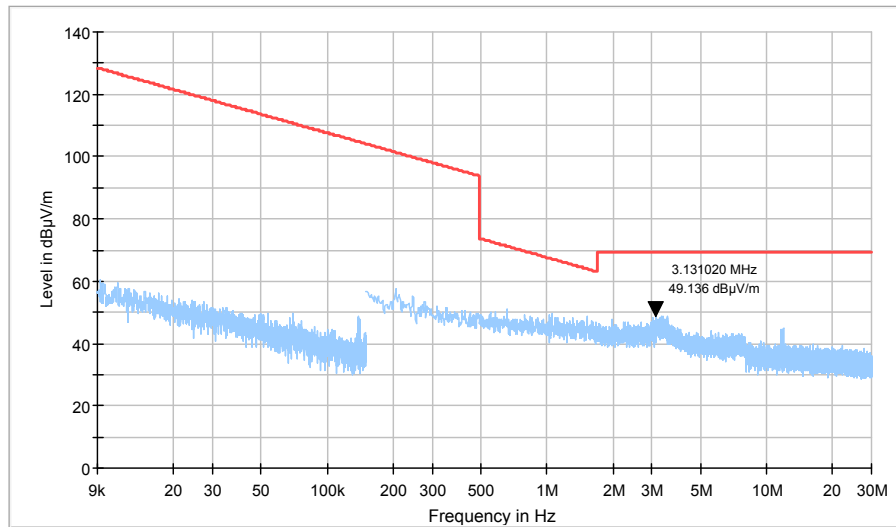

Plot 7.3.4 Radiated emission measurements from 30 to 800 MHz at the low carrier frequency

TEST SITE: Semi anechoic chamber
 TEST DISTANCE: 3 m
 ANTENNA POLARIZATION: Vertical and Horizontal

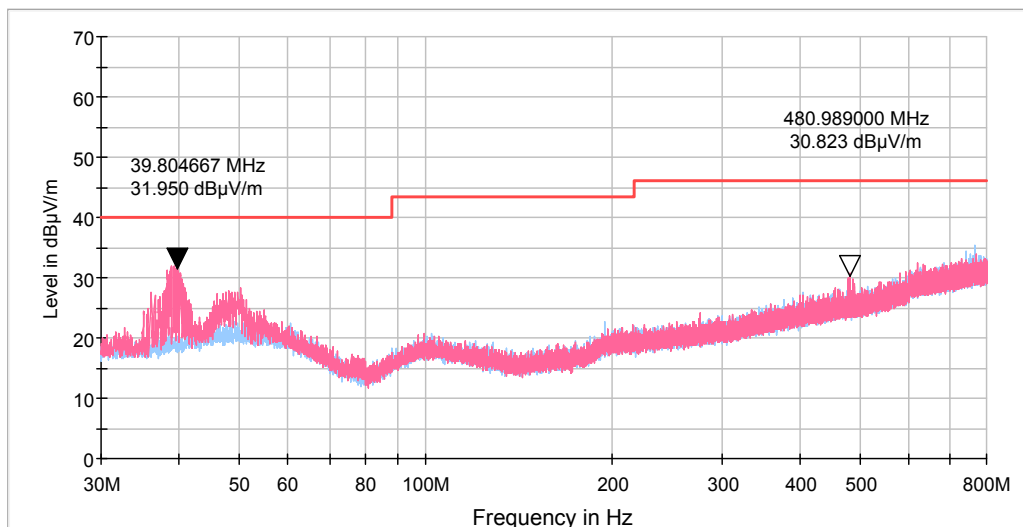



Test specification: Section 15.247(d) / RSS-247 section 5.5, Radiated spurious emissions			
Test procedure: ANSI C63.10 section 11.12.1			
Test mode: Compliance		Verdict: PASS	
Date(s): 30-Mar-21			
Temperature: 23 °C	Relative Humidity: 50 %	Air Pressure: 1012 hPa	Power: 120 VAC
Remarks:			

Plot 7.3.5 Radiated emission measurements from 30 to 800 MHz at the mid carrier frequency

TEST SITE: Semi anechoic chamber
 TEST DISTANCE: 3 m
 ANTENNA POLARIZATION: Vertical and Horizontal

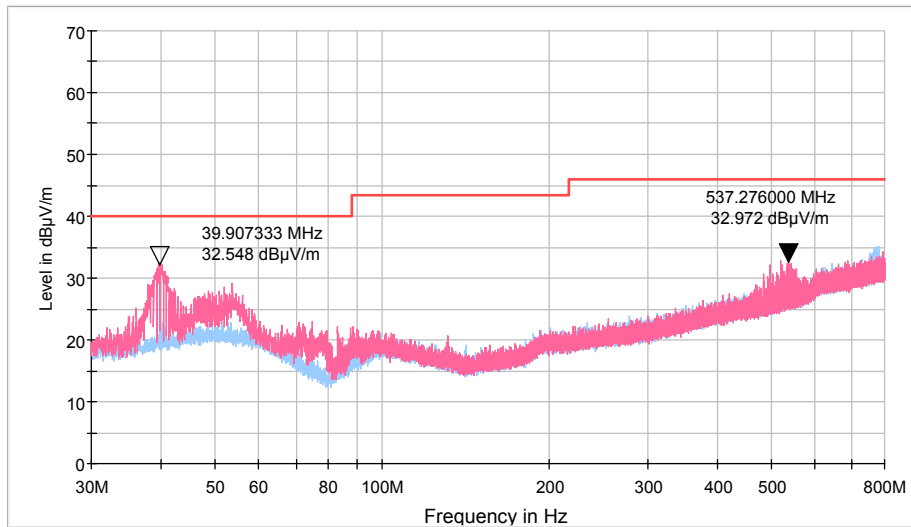

Plot 7.3.6 Radiated emission measurements from 30 to 800 MHz at the high carrier frequency

TEST SITE: Semi anechoic chamber
 TEST DISTANCE: 3 m
 ANTENNA POLARIZATION: Vertical and Horizontal

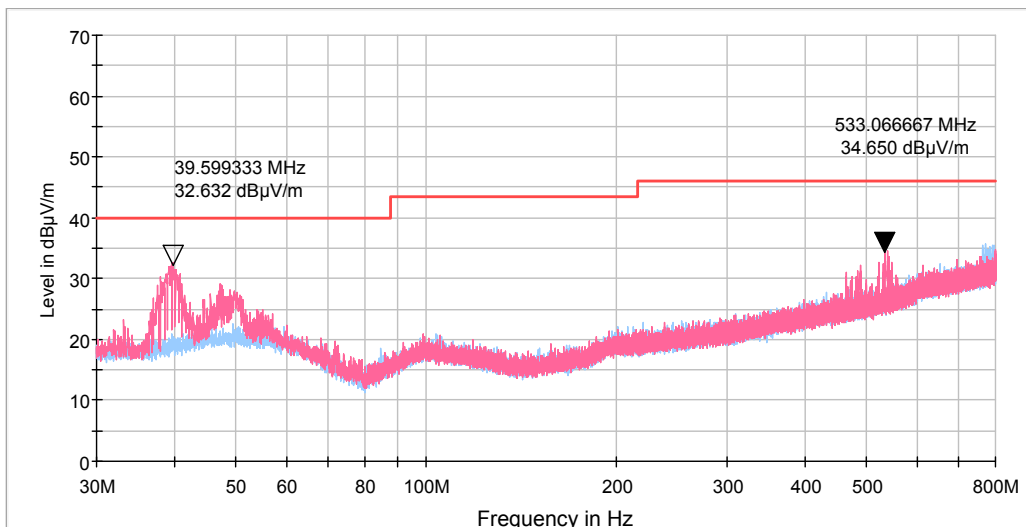



Test specification: Section 15.247(d) / RSS-247 section 5.5, Radiated spurious emissions			
Test procedure: ANSI C63.10 section 11.12.1			
Test mode: Compliance		Verdict: PASS	
Date(s): 30-Mar-21			
Temperature: 23 °C	Relative Humidity: 50 %	Air Pressure: 1012 hPa	Power: 120 VAC
Remarks:			

Plot 7.3.7 Radiated emission measurements from 800 to 1000 MHz at the low carrier frequency

TEST SITE: Semi anechoic chamber
TEST DISTANCE: 3 m
ANTENNA POLARIZATION: Vertical and Horizontal

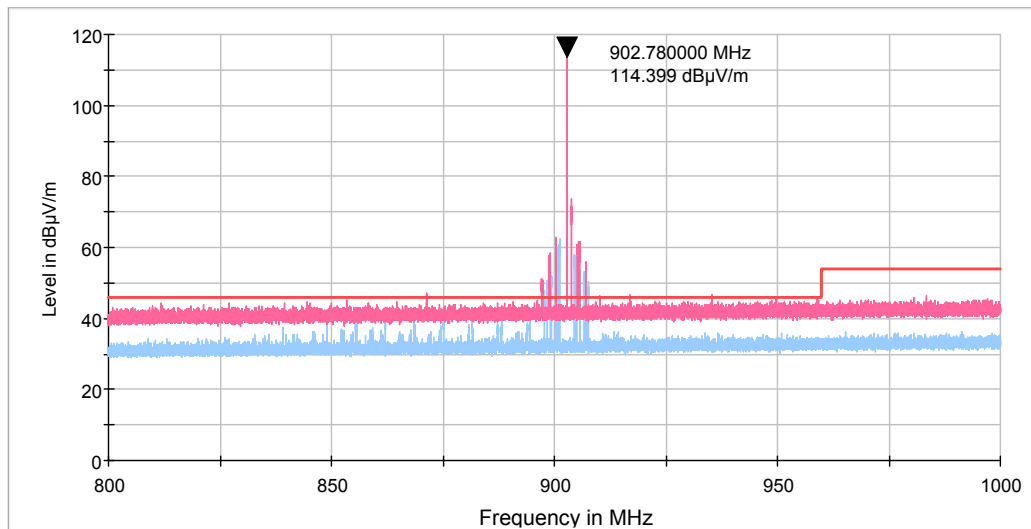

Plot 7.3.8 Radiated emission measurements from 800 to 1000 MHz at the mid carrier frequency

TEST SITE: Semi anechoic chamber
TEST DISTANCE: 3 m
ANTENNA POLARIZATION: Vertical and Horizontal

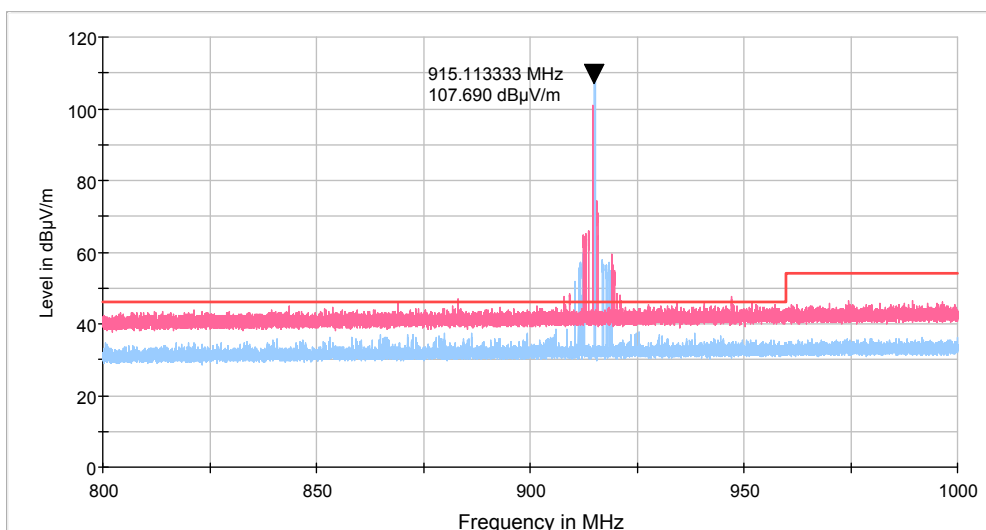



Test specification: Section 15.247(d) / RSS-247 section 5.5, Radiated spurious emissions			
Test procedure: ANSI C63.10 section 11.12.1			
Test mode: Compliance		Verdict: PASS	
Date(s): 30-Mar-21			
Temperature: 23 °C	Relative Humidity: 50 %	Air Pressure: 1012 hPa	Power: 120 VAC
Remarks:			

Plot 7.3.9 Radiated emission measurements from 800 to 1000 MHz at the high carrier frequency

TEST SITE: Semi anechoic chamber
 TEST DISTANCE: 3 m
 ANTENNA POLARIZATION: Vertical and Horizontal

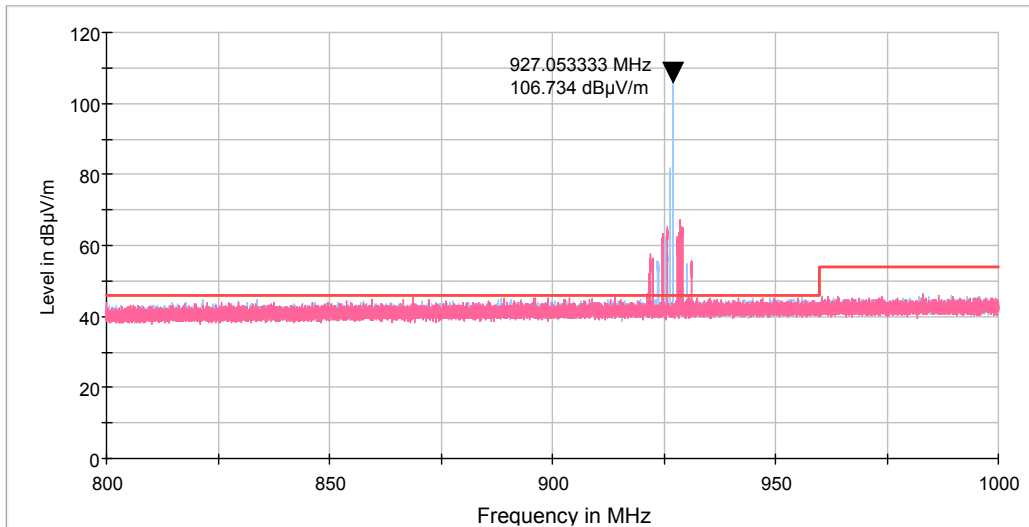

Plot 7.3.10 Radiated emission measurements from 1 to 10 GHz at the low carrier frequency

TEST SITE: Semi anechoic chamber
 TEST DISTANCE: 3 m
 ANTENNA POLARIZATION: Vertical and Horizontal

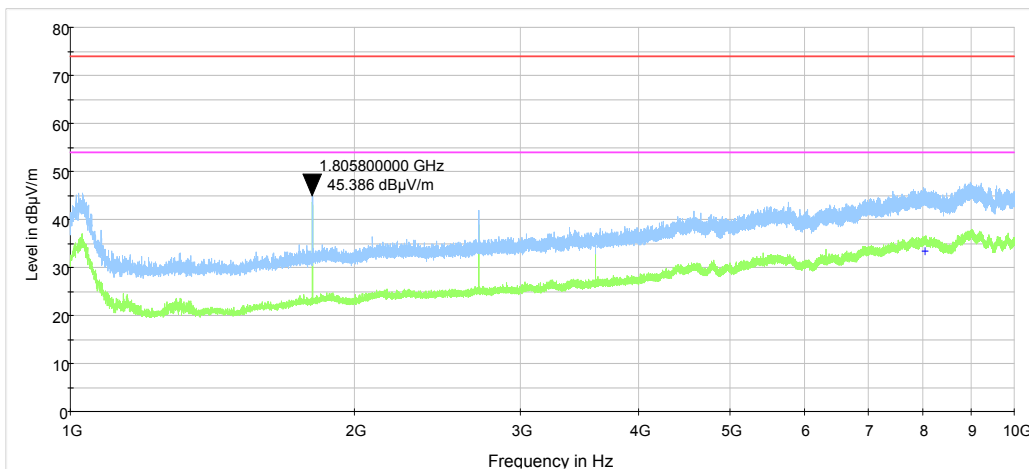



Test specification: Section 15.247(d) / RSS-247 section 5.5, Radiated spurious emissions			
Test procedure: ANSI C63.10 section 11.12.1			
Test mode: Compliance		Verdict: PASS	
Date(s): 30-Mar-21			
Temperature: 23 °C	Relative Humidity: 50 %	Air Pressure: 1012 hPa	Power: 120 VAC
Remarks:			

Plot 7.3.11 Radiated emission measurements from 1 to 10 GHz at the mid carrier frequency

TEST SITE: Semi anechoic chamber
TEST DISTANCE: 3 m
ANTENNA POLARIZATION: Vertical and Horizontal

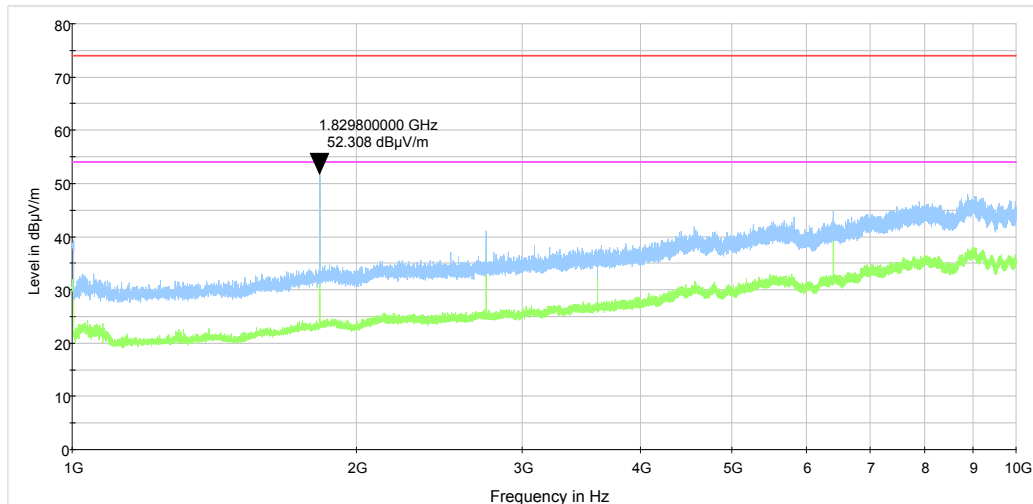

Plot 7.3.12 Radiated emission measurements from 1 to 10 GHz at the high carrier frequency

TEST SITE: Semi anechoic chamber
TEST DISTANCE: 3 m
ANTENNA POLARIZATION: Vertical and Horizontal

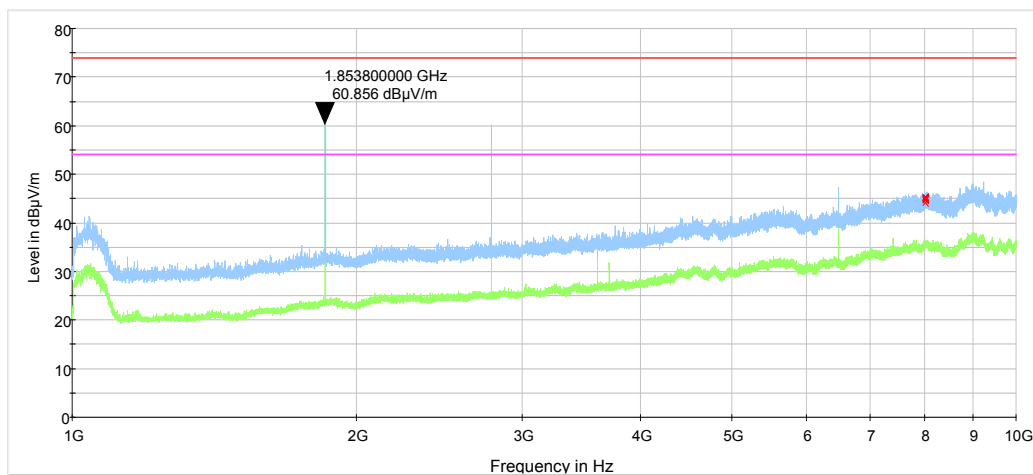



HERMON LABORATORIES

Test specification: Section 15.247(d) / RSS-247 section 5.5, Radiated spurious emissions			
Test procedure: ANSI C63.10 section 11.12.1			
Test mode: Compliance		Verdict: PASS	
Date(s): 30-Mar-21			
Temperature: 23 °C	Relative Humidity: 50 %	Air Pressure: 1012 hPa	Power: 120 VAC
Remarks:			

Plot 7.3.13 Transmission pulse duration

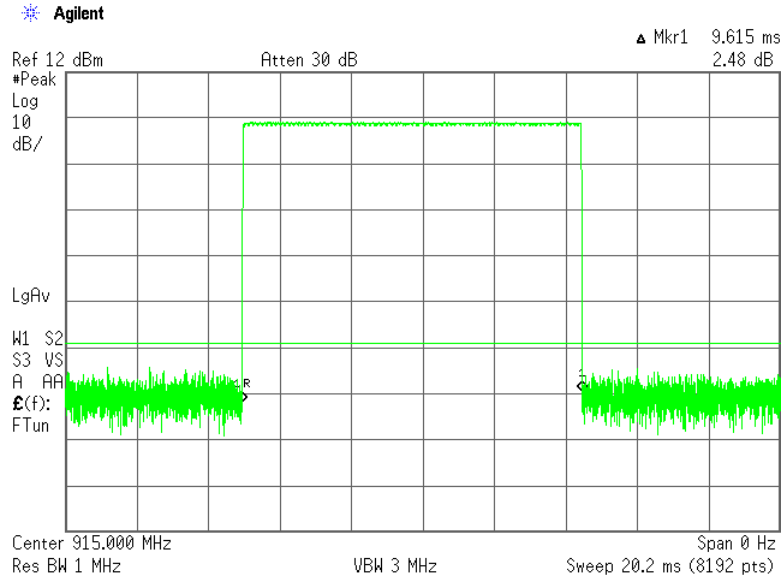



HERMON LABORATORIES

Test specification: Section 15.247(d) / RSS-247 section 5.5, Radiated spurious emissions			
Test procedure: ANSI C63.10 section 11.12.1			
Test mode: Compliance		Verdict: PASS	
Date(s): 30-Mar-21			
Temperature: 23 °C	Relative Humidity: 50 %	Air Pressure: 1012 hPa	Power: 120 VAC
Remarks:			

Plot 7.3.14 Transmission pulse period

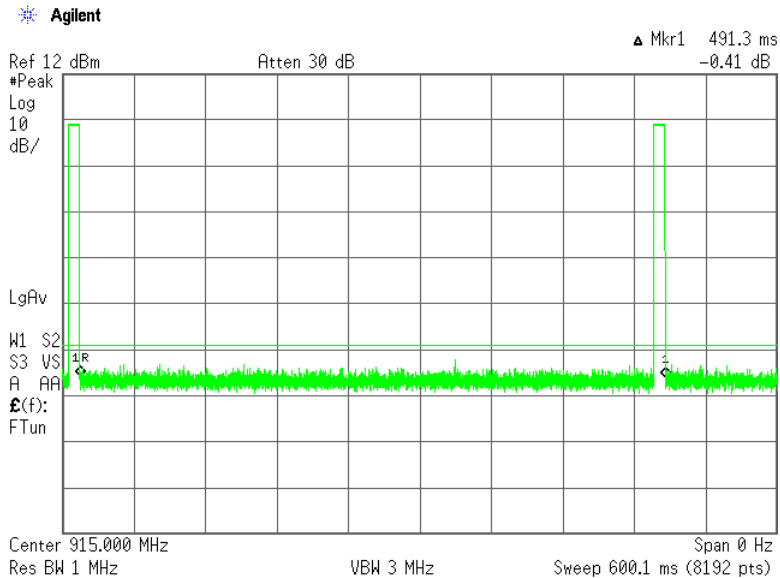
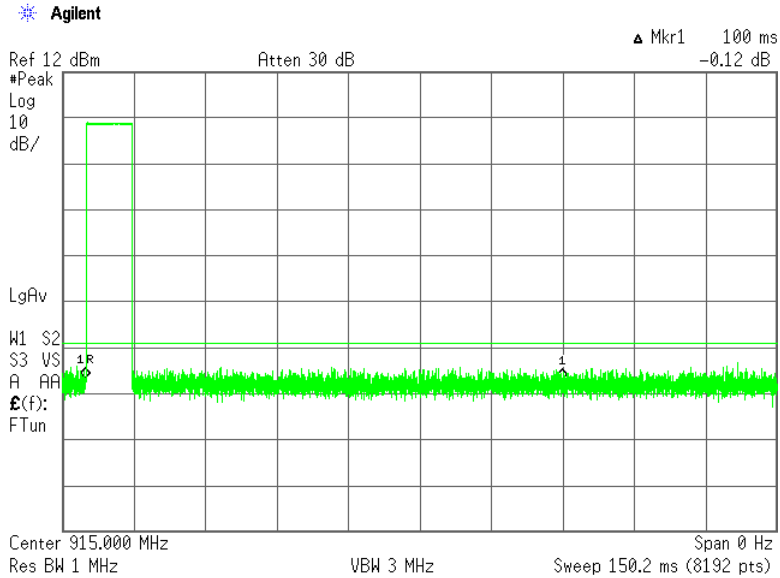



Test specification: Section 15.247(d) / RSS-247 section 5.5, Band edge emissions			
Test procedure: ANSI C63.10 section 11.13.2			
Test mode: Compliance		Verdict: PASS	
Date(s): 28-Feb-21			
Temperature: 25 °C	Relative Humidity: 46 %	Air Pressure: 1019 hPa	Power: 120 VAC
Remarks:			

7.4 Band edge emissions at RF antenna connector

7.4.1 General

This test was performed to measure band edge emissions at RF antenna connector. Specification test limits are given in Table 7.4.1.

Table 7.4.1 Band edge emission limits

Output power	Assigned frequency, MHz	Attenuation below carrier*, dBc
Peak	902.0 – 928.0	20.0
	2400.0 – 2483.5	
	5725.0 – 5850.0	
Averaged over a time interval	902.0 – 928.0	30.0
	2400.0 – 2483.5	
	5725.0 – 5850.0	

* - Band edge emission limit is provided in terms of attenuation below the peak of modulated carrier measured with the same resolution bandwidth.

7.4.2 Test procedure

- 7.4.2.1 The EUT was set up as shown in Figure 7.4.1, energized normally modulated at the maximum data rate and its proper operation was checked.
- 7.4.2.2 The EUT was adjusted to produce maximum available to end user RF output power at the lowest carrier frequency.
- 7.4.2.3 The spectrum analyzer span was set to capture the carrier frequency and associated modulation products. The resolution bandwidth was set wider than 1 % of the frequency span.
- 7.4.2.4 The spectrum analyzer was set in max hold mode and allowed trace to stabilize. The highest emission level within the authorized band was measured.
- 7.4.2.5 The maximum band edge emission and modulation product outside of the band were measured as provided in Table 7.4.2 and associated plots and referenced to the highest emission level measured within the authorized band.
- 7.4.2.6 The above procedure was repeated with the EUT adjusted to produce maximum RF output power at the highest carrier frequency.

Figure 7.4.1 Band edge emission test setup

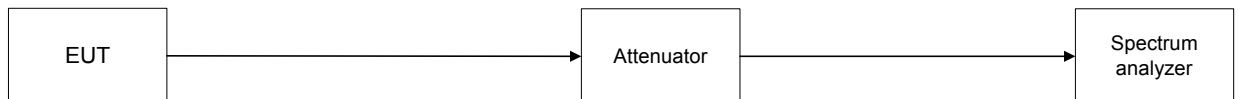



Test specification: Section 15.247(d) / RSS-247 section 5.5, Band edge emissions			
Test procedure: ANSI C63.10 section 11.13.2			
Test mode: Compliance		Verdict: PASS	
Date(s): 28-Feb-21			
Temperature: 25 °C	Relative Humidity: 46 %	Air Pressure: 1019 hPa	Power: 120 VAC
Remarks:			

Table 7.4.2 Band edge emission test results

ASSIGNED FREQUENCY RANGE: 902.0 -928.0MHz
DETECTOR USED: Peak
MODULATION: LoRa
BIT RATE: 46875 bps
TRANSMITTER OUTPUT POWER SETTINGS: Maximum
RESOLUTION BANDWIDTH: ≥ 1% of the span
VIDEO BANDWIDTH: ≥ RBW

Frequency, MHz	Band edge emission, dBm	Emission at carrier, dBm	Attenuation below carrier, dBc	Limit, dBc	Margin, dB*	Verdict
Low carrier - Peak power						
902.00	-29.72	20.89	50.61	20.0	30.61	Pass
High carrier - Peak power						
928.00	-25.24	20.65	45.89	20.0	25.58	Pass

*- Margin = Attenuation below carrier – specification limit.

Reference numbers of test equipment used

HL 3818	HL 3902	HL 4135	HL 5589				
---------	---------	---------	---------	--	--	--	--

Full description is given in Appendix A.



Test specification: Section 15.247(d) / RSS-247 section 5.5, Band edge emissions			
Test procedure: ANSI C63.10 section 11.13.2			
Test mode: Compliance		Verdict: PASS	
Date(s): 28-Feb-21			
Temperature: 25 °C	Relative Humidity: 46 %	Air Pressure: 1019 hPa	Power: 120 VAC
Remarks:			

Plot 7.4.1 The highest band edge emission at low carrier frequency

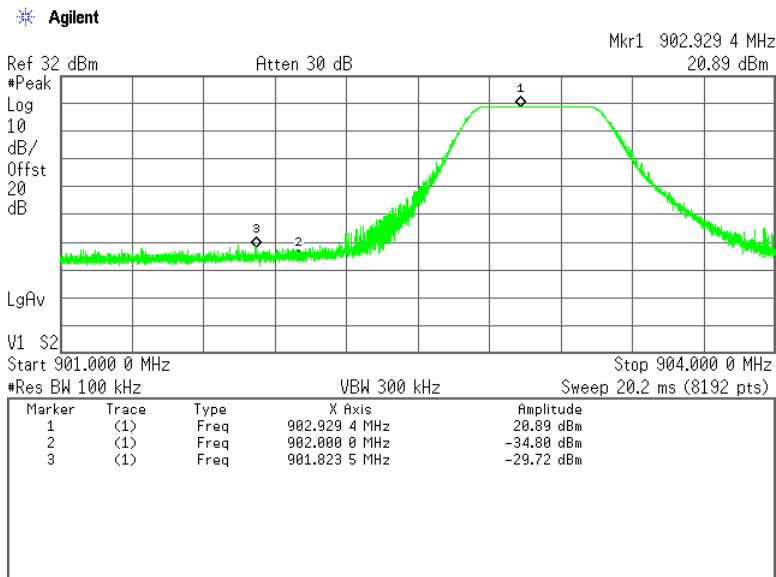

Plot 7.4.2 The highest band edge emission at high carrier frequency

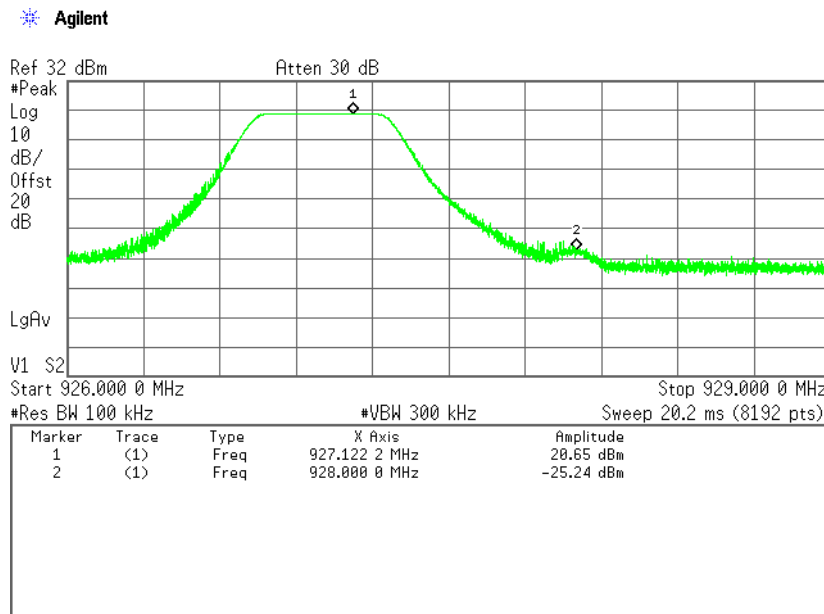



Test specification: Section 15.247(e) / RSS-247 section 5.2(b), Maximum power spectral density			
Test procedure: ANSI C63.10 section 11.10.2			
Test mode: Compliance		Verdict: PASS	
Date(s): 14-Mar-21			
Temperature: 25 °C	Relative Humidity: 49 %	Air Pressure: 1013 hPa	Power: 120 VAC
Remarks:			

7.5 Maximum power spectral density (PSD)

7.5.1 General

This test was performed to measure the peak spectral power density at the transmitter RF antenna connector. Specification test limits are given in Table 7.5.1.

Table 7.5.1 Peak spectral power density limits

Assigned frequency range, MHz	Measurement bandwidth, kHz	Peak spectral power density, dBm
902.0 – 928.0	3.0	8.0

7.5.2 Test procedure

7.5.2.1 The EUT was set up as shown in Figure 7.5.1, energized and its proper operation was checked.

7.5.2.2 The EUT was adjusted to produce maximum available to end user RF output power.

7.5.2.3 The frequency span of spectrum analyzer was set to 1.5 times the OBW of the transmitter. Peak detector with resolution bandwidth set to $3\text{ kHz} \leq \text{RBW} \leq 100\text{ kHz}$, video bandwidth wider than resolution bandwidth, auto sweep time was allowed for trace stabilization.

7.5.2.4 Spectrum analyzer was set in peak hold mode, sufficient number of sweeps was allowed for trace stabilization and peak spectral power density was measured as provided in Table 7.5.2 and the associated plots.

Figure 7.5.1 Peak spectral power density test setup

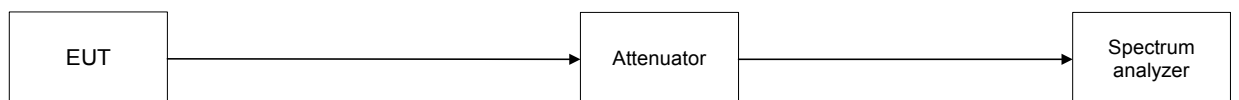



Test specification: Section 15.247(e) / RSS-247 section 5.2(b), Maximum power spectral density			
Test procedure: ANSI C63.10 section 11.10.2			
Test mode: Compliance		Verdict: PASS	
Date(s): 14-Mar-21			
Temperature: 25 °C	Relative Humidity: 49 %	Air Pressure: 1013 hPa	Power: 120 VAC
Remarks:			

Table 7.5.2 Peak spectral power density test results

ASSIGNED FREQUENCY: 902.0 – 928.0MHz
 MODULATION: LoRa
 MODULATING SIGNAL: PRBS
 BIT RATE: 46875 bps
 TRANSMITTER OUTPUT POWER SETTINGS: Maximum
 DETECTOR USED: Peak
 RESOLUTION BANDWIDTH: 3 kHz
 VIDEO BANDWIDTH: 10 kHz

Carrier frequency, MHz	Spectrum analyzer reading, dBm	External attenuation, dB	Cable loss, dB	Peak power density, dB(mW/3 kHz)	Limit, dBm	Margin*, dB	Verdict
903.00	6.27	included	included	6.27	8.0	-1.73	Pass
915.00	7.11	included	included	7.11	8.0	-0.89	Pass
927.00	6.20	included	included	6.20	8.0	-1.80	Pass

* - Margin = Peak power density – specification limit.

Reference numbers of test equipment used

HL 3901	HL 4135	HL 4355	HL 5626				
---------	---------	---------	---------	--	--	--	--

Full description is given in Appendix A.



HERMON LABORATORIES

Test specification: Section 15.247(e) / RSS-247 section 5.2(b), Maximum power spectral density			
Test procedure: ANSI C63.10 section 11.10.2			
Test mode: Compliance		Verdict: PASS	
Date(s): 14-Mar-21			
Temperature: 25 °C	Relative Humidity: 49 %	Air Pressure: 1013 hPa	Power: 120 VAC
Remarks:			

Plot 7.5.1 Peak spectral power density at low frequency within 6 dB band

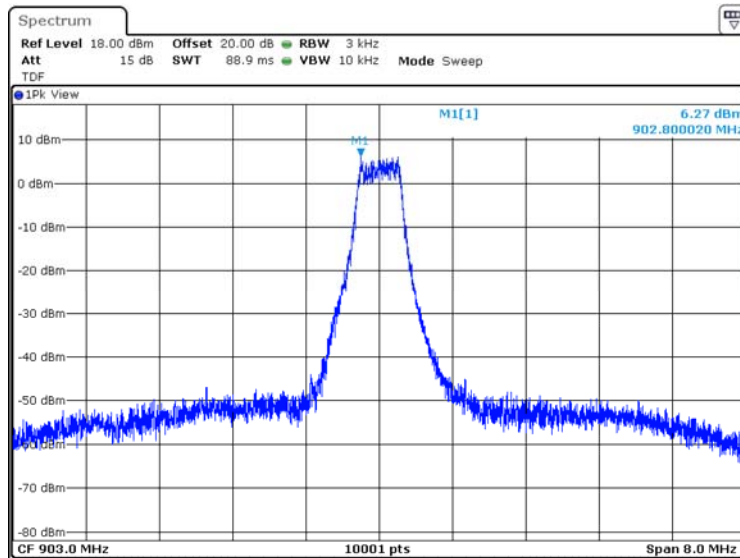

Plot 7.5.2 Peak spectral power density at mid frequency within 6 dB band

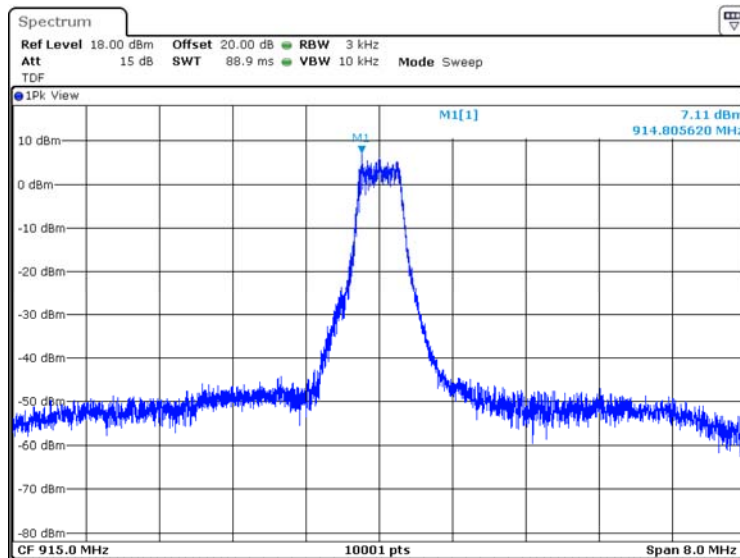



HERMON LABORATORIES

Test specification: Section 15.247(e) / RSS-247 section 5.2(b), Maximum power spectral density			
Test procedure: ANSI C63.10 section 11.10.2			
Test mode: Compliance		Verdict: PASS	
Date(s): 14-Mar-21			
Temperature: 25 °C	Relative Humidity: 49 %	Air Pressure: 1013 hPa	Power: 120 VAC
Remarks:			

Plot 7.5.3 Peak spectral power density at high frequency within 6 dB band

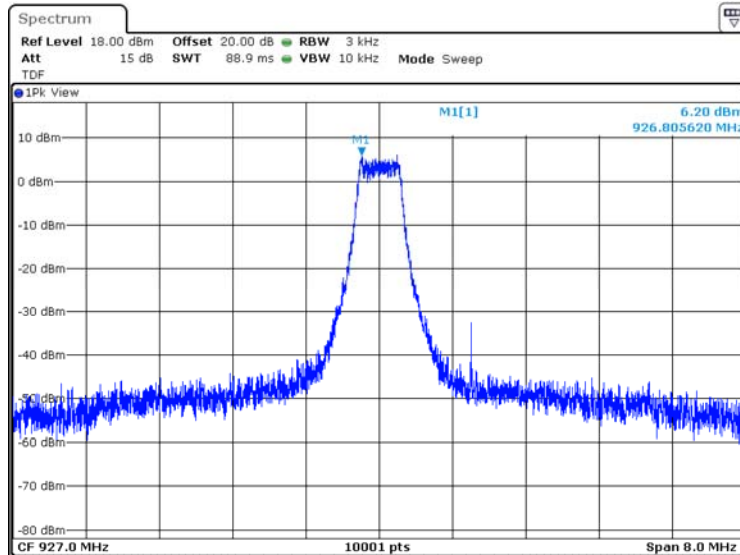



Test specification: FCC section 15.207(a), RSS-Gen section 8.8, Conducted emission			
Test procedure: ANSI C63.10 section 6.2			
Test mode: Compliance		Verdict: PASS	
Date(s): 28-Feb-21			
Temperature: 20.5 °C	Relative Humidity: 50 %	Air Pressure: 1013 hPa	Power: 120 VAC
Remarks:			

7.6 Conducted emissions

7.6.1 General

This test was performed to measure common mode conducted emissions at the mains power port. Specification test limits are given in Table 7.6.1.

Table 7.6.1 Limits for conducted emissions

Frequency, MHz	Limit, dB(μV)	
	QP	AVRG
0.15 - 0.5	66 - 56*	56 - 46*
0.5 - 5.0	56	46
5.0 - 30	60	50

* - The limit decreases linearly with the logarithm of frequency.

7.6.2 Test procedure

7.6.2.1 The EUT was set up as shown in Figure 7.6.1 and associated photographs, energized and the performance check was conducted.

7.6.2.2 The measurements were performed at power terminals with the LISN, connected to a spectrum analyzer while unused coaxial connector of the LISN was terminated with 50 Ohm.

7.6.2.3 The position of the device cables was varied to determine maximum emission level.

7.6.2.4 The worst test results (the lowest margins) were recorded in Table 7.6.2 and shown in the associated plots.

Figure 7.6.1 Setup for conducted emission measurements, table-top equipment

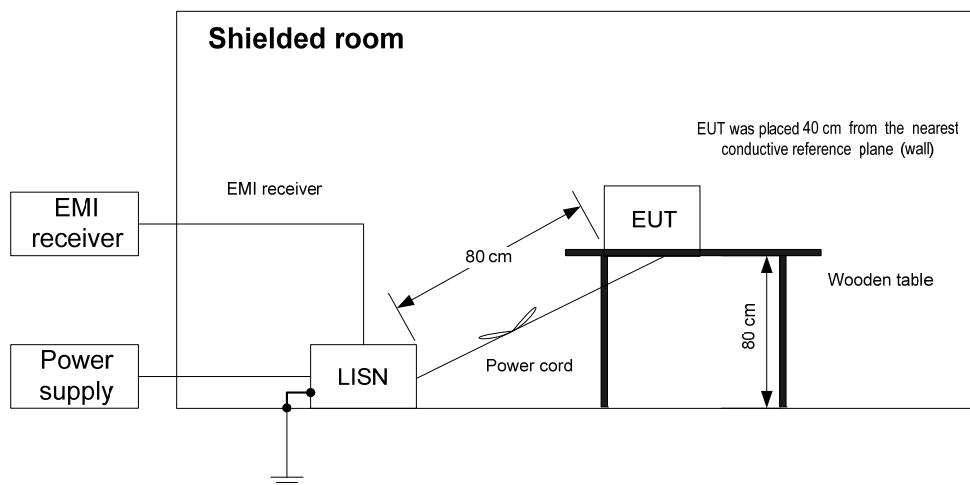



Test specification: FCC section 15.207(a), RSS-Gen section 8.8, Conducted emission			
Test procedure: ANSI C63.10 section 6.2			
Test mode: Compliance		Verdict: PASS	
Date(s): 28-Feb-21			
Temperature: 20.5 °C	Relative Humidity: 50 %	Air Pressure: 1013 hPa	Power: 120 VAC
Remarks:			

Table 7.6.2 Conducted emission test results

LINE: AC mains
EUT OPERATING MODE: Transmit
EUT SET UP: TABLE-TOP
TEST SITE: SHIELDED ROOM
FREQUENCY RANGE: 150 kHz - 30 MHz
RESOLUTION BANDWIDTH: 9 kHz

Frequency, MHz	Peak emission, dB(µV)	Quasi-peak			Average			Line ID	Verdict
		Measured emission, dB(µV)	Limit, dB(µV)	Margin, dB*	Measured emission, dB(µV)	Limit, dB(µV)	Margin, dB*		
All emissions were found at least 20 dB below limit								L1	Pass
All emissions were found at least 20 dB below limit								L2	Pass

*- Margin = Measured emission - specification limit.

Reference numbers of test equipment used

HL 0787	HL 2382	HL 3016	HL 5476	HL 5694	HL 5707		
---------	---------	---------	---------	---------	---------	--	--

Full description is given in Appendix A.



HERMON LABORATORIES

Test specification: FCC section 15.207(a), RSS-Gen section 8.8, Conducted emission			
Test procedure: ANSI C63.10 section 6.2			
Test mode: Compliance		Verdict: PASS	
Date(s): 28-Feb-21			
Temperature: 20.5 °C	Relative Humidity: 50 %	Air Pressure: 1013 hPa	Power: 120 VAC
Remarks:			

Plot 7.6.1 Conducted emission measurements

LINE: L1
LIMIT: Class B
EUT OPERATING MODE: Transmit
LIMIT: QUASI-PEAK, AVERAGE
DETECTOR: PEAK

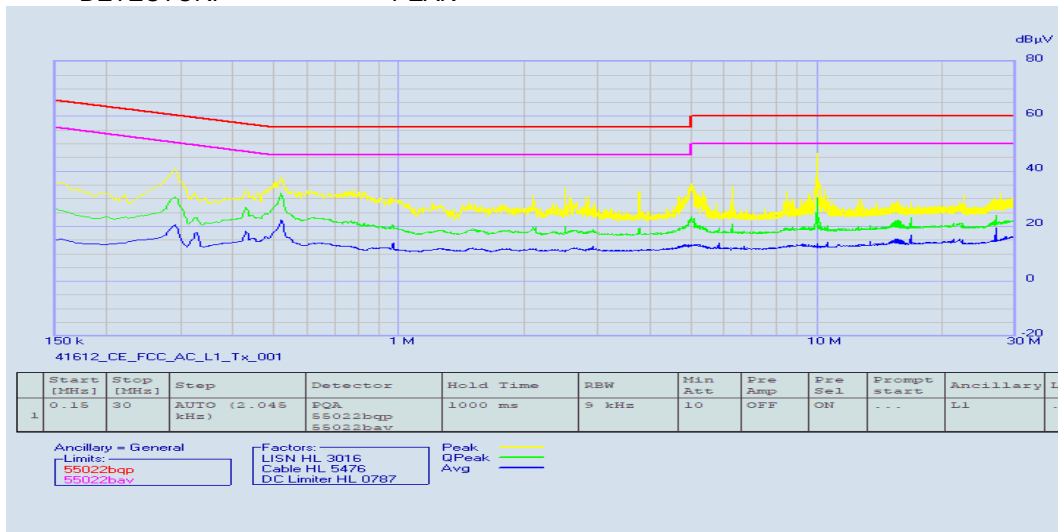

Plot 7.6.2 Conducted emission measurements

LINE: L2
LIMIT: Class B
EUT OPERATING MODE: Transmit
LIMIT: QUASI-PEAK, AVERAGE
DETECTOR: PEAK

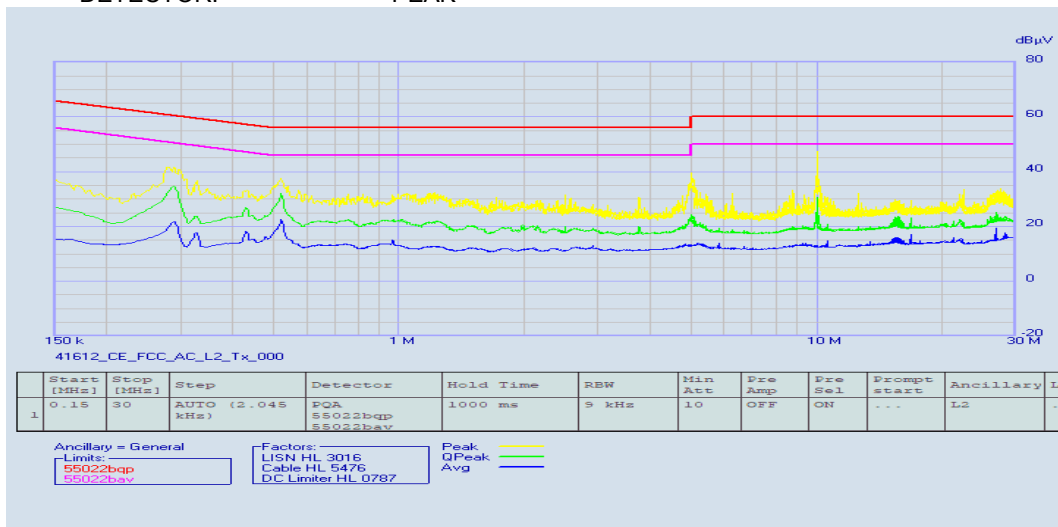



Test specification: FCC section 15.203, RSS-Gen section 6.8, Antenna requirement			
Test procedure: Visual inspection			
Test mode: Compliance		Verdict: PASS	
Date(s): 28-Feb-21			
Temperature: 25 °C	Relative Humidity: 50 %	Air Pressure: 1013 hPa	Power: 120 VAC
Remarks:			

7.7 Antenna requirements

The EUT was verified for compliance with antenna requirements. A transmitter shall be designed to ensure that no antenna other than that furnished by the responsible party will be used with the device. It may be either permanently attached or employs a unique antenna connector for every antenna proposed for use with the EUT. This requirement does not apply to professionally installed transmitters. The rationale for compliance with the above requirements was either visual inspection results or supplier declaration. The summary of results is provided in Table 7.7.1.

Table 7.7.1 Antenna requirements

Requirement	Rationale	Verdict
The transmitter antenna is permanently attached	NA	Comply
The transmitter employs a unique antenna connector	NA	
The transmitter requires professional installation	Supplier declaration	



Test specification: FCC Part 15, Section 107 / ICES-003 section 6.1, Conducted emission at AC power port			
Test procedure: ANSI C63.4, Section 12.2.4			
Test mode: Compliance		Verdict: PASS	
Date(s): 28-Feb-21			
Temperature: 20.5 °C	Relative Humidity: 50 %	Air Pressure: 1013 hPa	Power: 120 VAC
Remarks:			

8 Unintentional emissions

8.1 Conducted emissions

8.1.1 General

This test was performed to measure common mode conducted emissions at the mains power port. Specification test limits are given in Table 8.1.1.

Table 8.1.1 Limits for conducted emissions

Frequency, MHz	Class B limit, dB(μV)		Class A limit, dB(μV)	
	QP	AVRG	QP	AVRG
0.15 - 0.5	66 - 56*	56 - 46*	79	66
0.5 - 5.0	56	46	73	60
5.0 - 30	60	50	73	60

* - The limit decreases linearly with the logarithm of frequency.

8.1.2 Test procedure

- 8.1.2.1 The EUT was set up as shown in Figure 8.1.1 and associated photographs, energized and the performance check was conducted.
- 8.1.2.2 The measurements were performed at power terminals with the LISN, connected to a spectrum analyzer while unused coaxial connector of the LISN was terminated with 50 Ohm.
- 8.1.2.3 The position of the device cables was varied to determine maximum emission level.
- 8.1.2.4 The worst test results (the lowest margins) were recorded in Table 8.1.2 and shown in the associated plots.



Test specification: FCC Part 15, Section 107 / ICES-003 section 6.1, Conducted emission at AC power port			
Test procedure: ANSI C63.4, Section 12.2.4			
Test mode: Compliance		Verdict: PASS	
Date(s): 28-Feb-21			
Temperature: 20.5 °C	Relative Humidity: 50 %	Air Pressure: 1013 hPa	Power: 120 VAC
Remarks:			

Figure 8.1.1 Setup for conducted emission measurements, table-top equipment

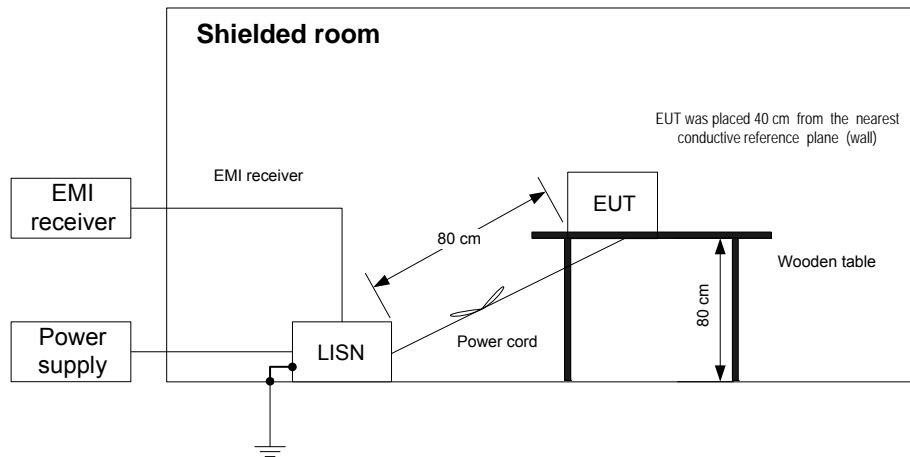

Photograph 8.1.1 Setup for conducted emission measurements





Test specification: FCC Part 15, Section 107 / ICES-003 section 6.1, Conducted emission at AC power port			
Test procedure: ANSI C63.4, Section 12.2.4			
Test mode: Compliance		Verdict: PASS	
Date(s): 28-Feb-21			
Temperature: 20.5 °C	Relative Humidity: 50 %	Air Pressure: 1013 hPa	Power: 120 VAC
Remarks:			

Table 8.1.2 Conducted emission test results

LINE: AC mains
EUT OPERATING MODE: Stand-by and receive
EUT SET UP: TABLE-TOP
TEST SITE: SHIELDED ROOM
FREQUENCY RANGE: 150 kHz - 30 MHz
RESOLUTION BANDWIDTH: 9 kHz

Frequency, MHz	Peak emission, dB(µV)	Quasi-peak			Average			Line ID	Verdict
		Measured emission, dB(µV)	Limit, dB(µV)	Margin, dB*	Measured emission, dB(µV)	Limit, dB(µV)	Margin, dB*		
All emissions were found at least 20 dB below limit								L1	Pass
All emissions were found at least 20 dB below limit								L2	Pass

*- Margin = Measured emission - specification limit.

Reference numbers of test equipment used

HL 0787	HL 2382	HL 3016	HL 5476	HL 5694	HL 5707		
---------	---------	---------	---------	---------	---------	--	--

Full description is given in Appendix A.



HERMON LABORATORIES

Test specification: FCC Part 15, Section 107 / ICES-003 section 6.1, Conducted emission at AC power port			
Test procedure: ANSI C63.4, Section 12.2.4			
Test mode: Compliance		Verdict: PASS	
Date(s): 28-Feb-21			
Temperature: 20.5 °C	Relative Humidity: 50 %	Air Pressure: 1013 hPa	Power: 120 VAC
Remarks:			

Plot 8.1.1 Conducted emission measurements

LINE: L1
LIMIT: Class B
EUT OPERATING MODE: Stand-by and receive
LIMIT: QUASI-PEAK, AVERAGE
DETECTOR: PEAK

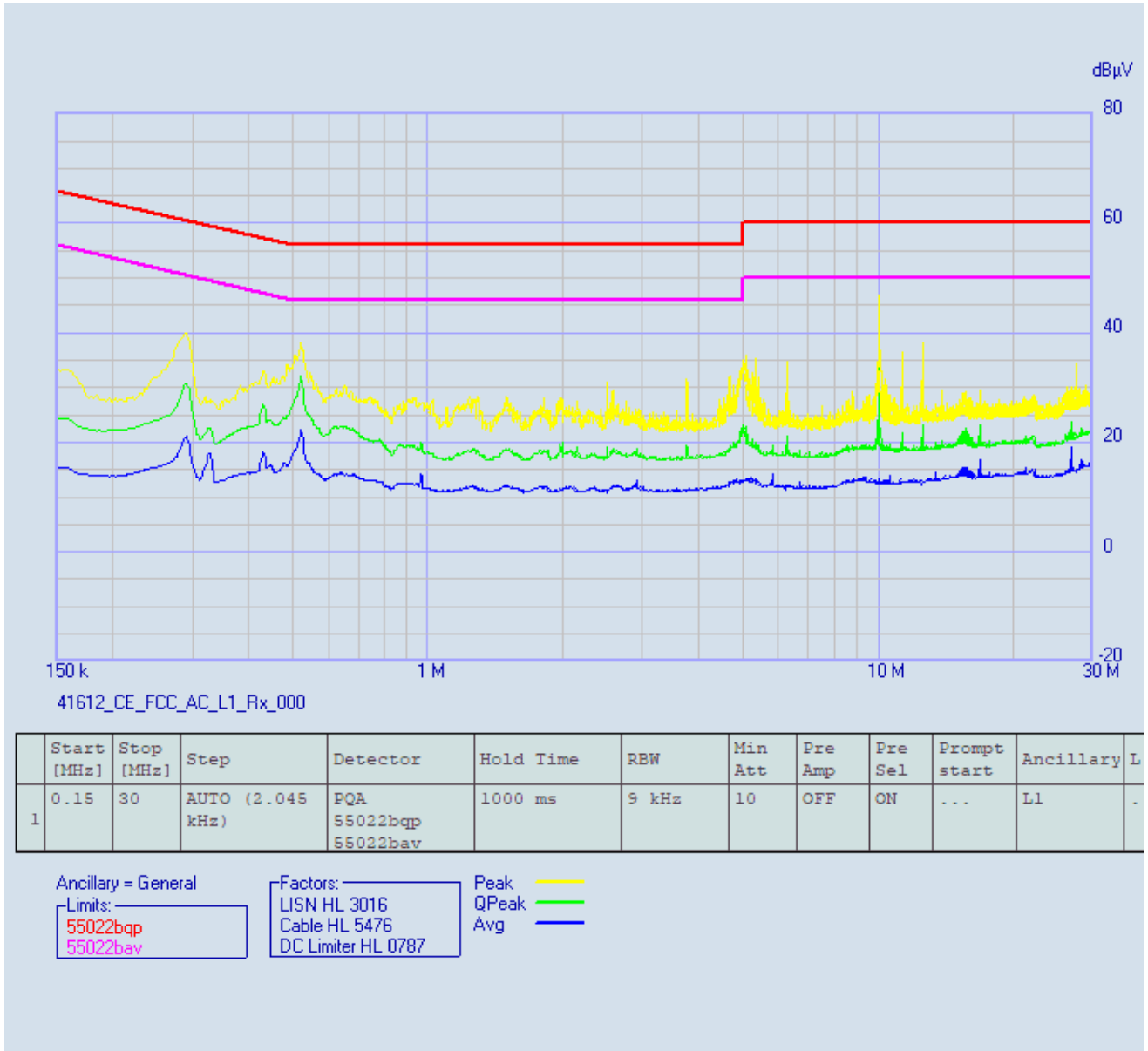



HERMON LABORATORIES

Test specification: FCC Part 15, Section 107 / ICES-003 section 6.1, Conducted emission at AC power port			
Test procedure: ANSI C63.4, Section 12.2.4			
Test mode: Compliance		Verdict: PASS	
Date(s): 28-Feb-21			
Temperature: 20.5 °C	Relative Humidity: 50 %	Air Pressure: 1013 hPa	Power: 120 VAC
Remarks:			

Plot 8.1.2 Conducted emission measurements

LINE: L2
 LIMIT: Class B
 EUT OPERATING MODE: Stand-by and receive
 LIMIT: QUASI-PEAK, AVERAGE
 DETECTOR: PEAK

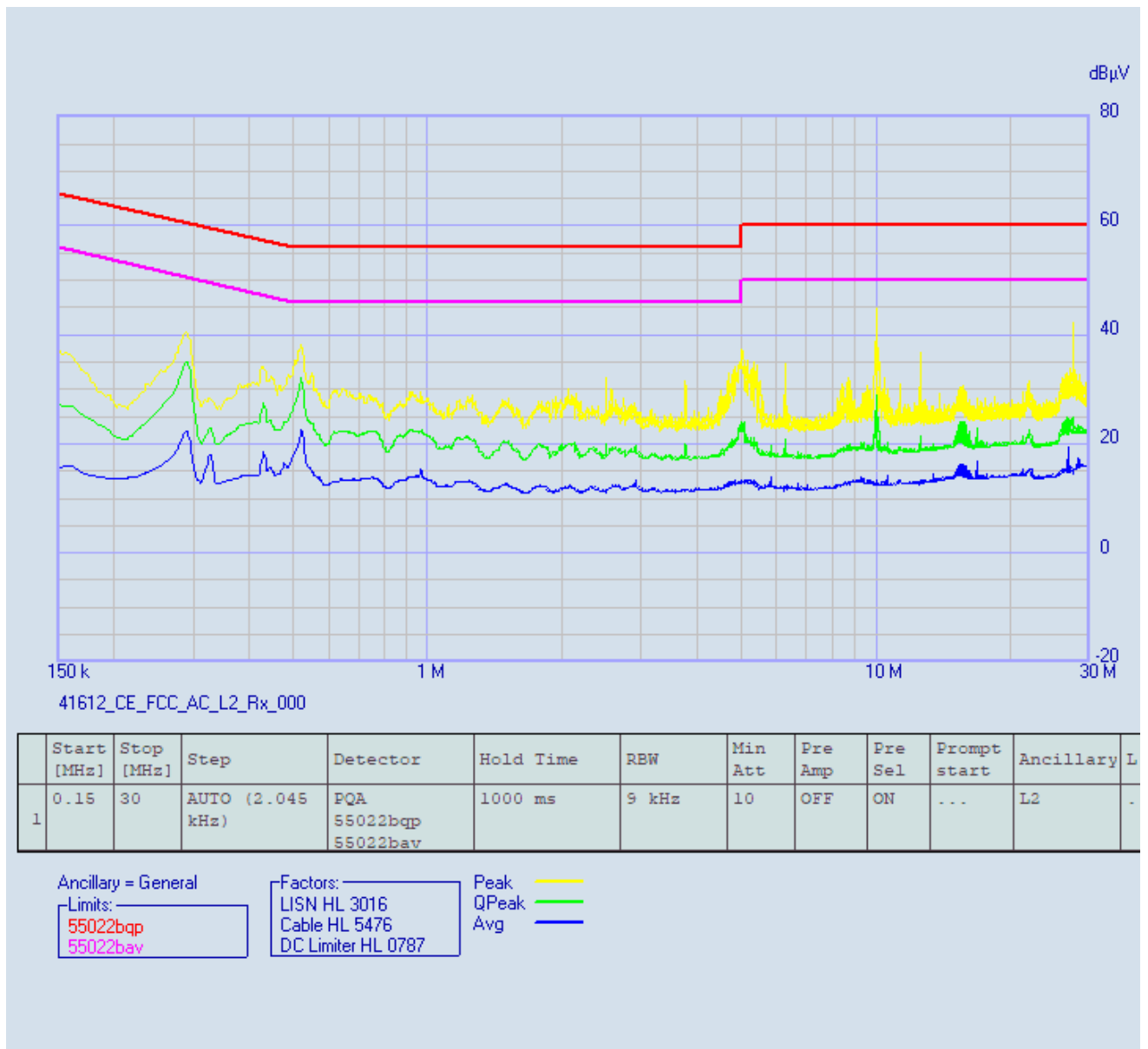



Test specification: FCC Part 15, Section 109 / RSS-Gen, Section 7.3 / ICES-003 section 6.2, Class B, Radiated emission			
Test procedure: ANSI C63.4, Section 12.2.5			
Test mode: Compliance		Verdict: PASS	
Date(s): 30-Mar-21			
Temperature: 23 °C	Relative Humidity: 50 %	Air Pressure: 1012 hPa	Power: 120 VAC
Remarks:			

8.2 Radiated emission measurements

8.2.1 General

This test was performed to measure radiated emissions from the EUT enclosure. Specification test limits are given in Table 8.2.1 and Table 8.2.2.

Table 8.2.1 Radiated emission limits according to FCC Part 15, Section 109

Frequency, MHz	Class B limit, dB(μV/m)		Class A limit, dB(μV/m)	
	10 m distance	3 m distance	10 m distance	3 m distance
30 - 88	29.5*	40.0	39.0	49.5*
88 - 216	33.0*	43.5	43.5	54.0*
216 - 960	35.5*	46.0	46.4	56.9*
960 - 5 th harmonic**	43.5*	54.0	49.5	60.0*

* - The limit for test distance other than specified was calculated using the inverse linear distance extrapolation factor as follows: $Lim_{S_2} = Lim_{S_1} + 20 \log(S_1/S_2)$, where S_1 and S_2 – standard defined and test distance respectively in meters.

Table 8.2.2 Radiated emission limits according to RSS-210, Section 7.3

Frequency, MHz	Field strength limit at 3 m test distance, dB(μV/m)
30 - 88	40.0
88 - 216	43.5
216 - 960	46.0
960 - 5 th harmonic**	54.0

** - harmonic of the highest frequency the EUT generates, uses, operates or tunes to.

8.2.2 Test procedure

8.2.2.1 The EUT was set up as shown in Figure 8.2.1 and associated photographs, energized and the performance check was conducted.

8.2.2.2 The specified frequency range was investigated with biconilog antenna connected to EMI receiver. To find maximum radiation the turntable was rotated 360°, the measuring antenna height was changed from 1 to 4 m, its polarization was switched from vertical to horizontal and the EUT cables position was varied.

8.2.2.3 The worst test results (the lowest margins) were provided in the associated tables and plots.



Test specification: FCC Part 15, Section 109 / RSS-Gen, Section 7.3 / ICES-003 section 6.2, Class B, Radiated emission			
Test procedure: ANSI C63.4, Section 12.2.5			
Test mode: Compliance	Verdict: PASS		
Date(s): 30-Mar-21			
Temperature: 23 °C	Relative Humidity: 50 %	Air Pressure: 1012 hPa	Power: 120 VAC
Remarks:			

Figure 8.2.1 Setup for radiated emission measurements in anechoic chamber, table-top equipment

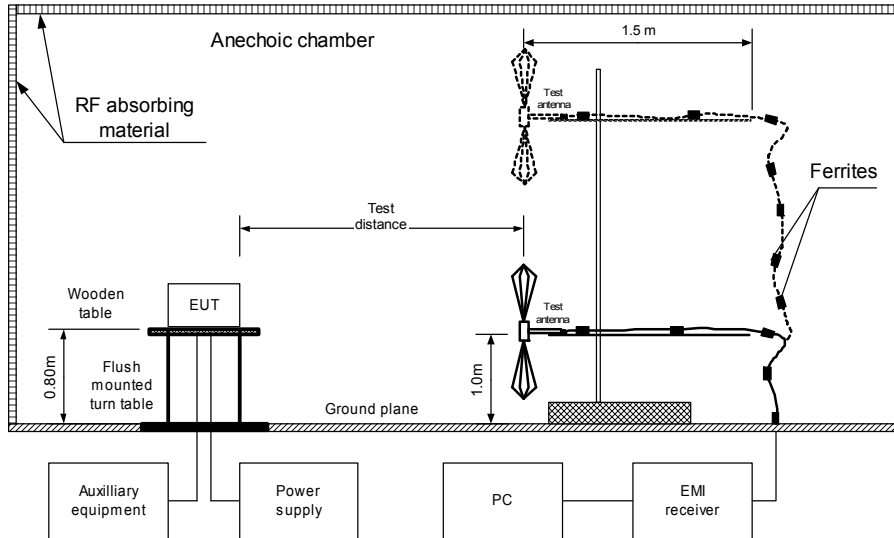



Test specification:	FCC Part 15, Section 109 / RSS-Gen, Section 7.3 / ICES-003 section 6.2, Class B, Radiated emission		
Test procedure:	ANSI C63.4, Section 12.2.5		
Test mode:	Compliance	Verdict:	PASS
Date(s):	30-Mar-21		
Temperature: 23 °C	Relative Humidity: 50 %	Air Pressure: 1012 hPa	Power: 120 VAC
Remarks:			

Photograph 8.2.1 Setup for radiated emission measurements, general view



Photograph 8.2.2 Setup for radiated emission measurements, EUT cabling





Test specification: FCC Part 15, Section 109 / RSS-Gen, Section 7.3 / ICES-003 section 6.2, Class B, Radiated emission			
Test procedure: ANSI C63.4, Section 12.2.5			
Test mode: Compliance		Verdict: PASS	
Date(s): 30-Mar-21			
Temperature: 23 °C	Relative Humidity: 50 %	Air Pressure: 1012 hPa	Power: 120 VAC
Remarks:			

Table 8.2.3 Radiated emission test results

EUT SET UP: TABLE-TOP
LIMIT: Class B
EUT OPERATING MODE: Stand-by and Receive
TEST SITE: SEMI ANECHOIC CHAMBER
TEST DISTANCE: 3 m
FREQUENCY RANGE: 30 MHz – 1000 MHz
RESOLUTION BANDWIDTH: 120 kHz

Frequency, MHz	Peak emission, dB(µV/m)	Quasi-peak			Antenna polarization	Antenna height, m	Turn-table position**, degrees	Verdict
		Measured emission, dB(µV/m)	Limit, dB(µV/m)	Margin, dB*				
33.714	21.61	13.59	40.0	-26.41	Vertical	1.04	-122.0	Pass
39.524	32.99	27.41	40.0	-12.59	Vertical	1.00	41.0	
39.532	33.27	27.64	40.0	-12.36	Vertical	1.00	48.0	
39.714	32.72	27.34	40.0	-12.66	Vertical	1.00	48.0	
39.909	32.46	26.68	40.0	-13.32	Vertical	1.02	48.0	
46.769	28.90	20.25	40.0	-19.75	Vertical	1.00	-180.0	
47.635	29.19	20.74	40.0	-19.26	Vertical	1.32	-156.0	
49.655	28.11	20.97	40.0	-19.03	Vertical	1.02	57.0	

TEST SITE: SEMI ANECHOIC CHAMBER
TEST DISTANCE: 3 m
FREQUENCY RANGE: 1000 MHz - 5000 MHz
RESOLUTION BANDWIDTH: 1000 kHz

Frequency, MHz	Peak emission, dB(µV/m)	Average			Antenna polarization	Antenna height, m	Turn-table position**, degrees	Verdict
		Measured emission, dB(µV/m)	Limit, dB(µV/m)	Margin, dB*				
All emissions were found at least 20 dB bellow limit								Pass

Reference numbers of test equipment used

HL 3903	HL 4360	HL 4933	HL 5085	HL 5288	HL 5902		
---------	---------	---------	---------	---------	---------	--	--

Full description is given in Appendix A.



Test specification: FCC Part 15, Section 109 / RSS-Gen, Section 7.3 / ICES-003 section 6.2, Class B, Radiated emission			
Test procedure: ANSI C63.4, Section 12.2.5			
Test mode: Compliance		Verdict: PASS	
Date(s): 30-Mar-21			
Temperature: 23 °C	Relative Humidity: 50 %	Air Pressure: 1012 hPa	Power: 120 VAC
Remarks:			

Plot 8.2.1 Radiated emission measurements in 30 - 1000 MHz range, vertical and horizontal antenna polarization

TEST SITE: Semi anechoic chamber
LIMIT: Class B
TEST DISTANCE: 3 m
EUT OPERATING MODE: Receive

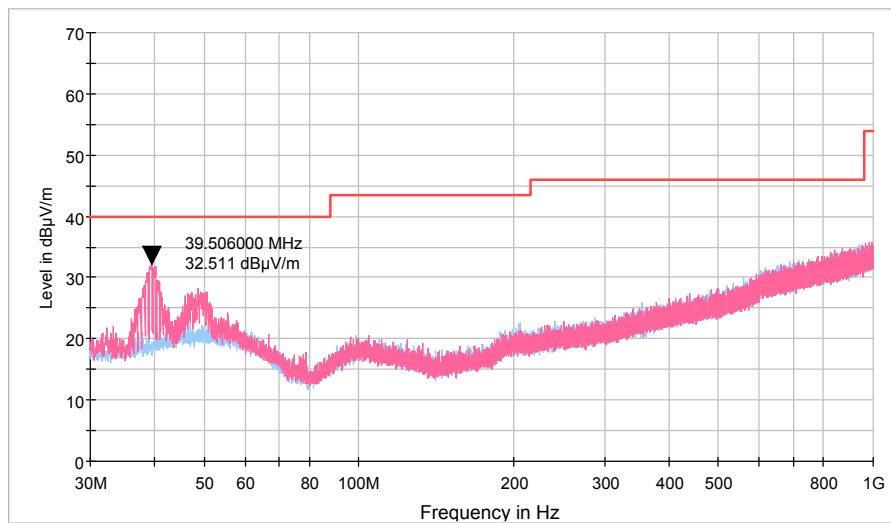

Plot 8.2.2 Radiated emission measurements above 1000 MHz, vertical and horizontal antenna polarization

TEST SITE: Semi anechoic chamber
LIMIT: Class B
TEST DISTANCE: 3 m
EUT OPERATING MODE: Receive

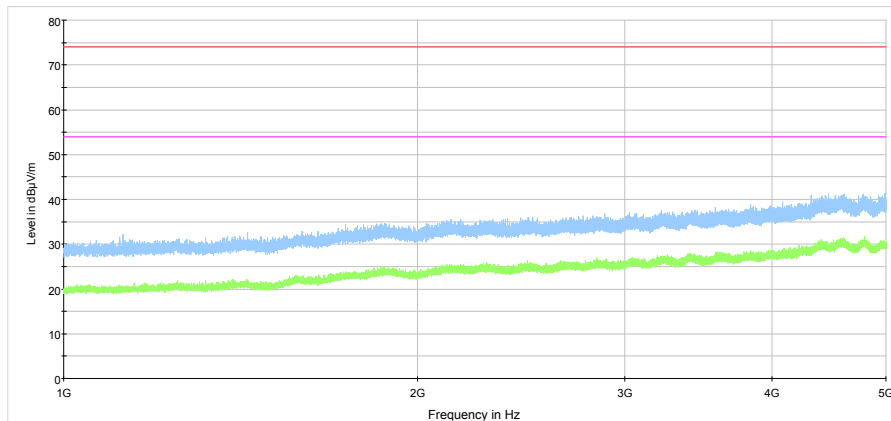



9 APPENDIX A Test equipment and ancillaries used for tests

HL No	Description	Manufacturer	Model	Ser. No.	Last Cal./ Check	Due Cal./ Check
0446	Antenna, Loop, Active, 10 (9) kHz - 30 MHz	EMCO	6502	2857	28-Feb-21	28-Feb-22
0787	Transient Limiter 9 kHz-200 MHz	Hewlett Packard	11947A	3107A01877	06-Oct-20	06-Oct-21
2382	Transformer, Isolation, 230/230, 1.8 kVA	Taiyo Yuden, Inc.	LGY1.8-21	FJ0411	03-Feb-21	03-Feb-22
3016	LISN, Two-line V-network, 9 kHz to 30 MHz, (50 uH+5 Ohm), CISPR16-1, MIL-461E	Rohde & Schwarz	ESH 3-Z5	892239/002	09-Feb-21	09-Feb-22
3818	PSA Series Spectrum Analyzer, 3 Hz- 44 GHz	Agilent Technologies	E4446A	MY48250288	27-Apr-20	27-Apr-21
3901	Microwave Cable Assembly, 40.0 GHz, 3.5 m, SMA/SMA	Huber-Suhner	SUCOFLEX 102A	1225/2A	06-Apr-20	06-Apr-21
3902	Microwave Cable Assembly, 40.0 GHz, 1.5 m, SMA/SMA	Huber-Suhner	SUCOFLEX 102A	1227/2A	06-Apr-20	06-Apr-21
3903	Microwave Cable Assembly, 40.0 GHz, 1.5 m, SMA/SMA	Huber-Suhner	SUCOFLEX 102A	1226/2A	06-Apr-20	06-Apr-21
4135	Shield Box	TESCOM CO., LTD	TC-5916A	5916A000136	23-Apr-20	23-Apr-21
4339	High pass Filter, 50 Ohm, 1000 to 18000 MHz, SMA-FM / SMA-M	Micro-Tronics	HPM50115-02	001	05-Jun-19	05-Jun-21
4355	Signal and Spectrum Analyzer, 9 kHz to 7 GHz	Rohde & Schwarz	FSV 7	101630	09-Sep-20	09-Sep-21
4360	EMI Test Receiver, 20 Hz to 40 GHz	Rohde & Schwarz	ESU40	100322	19-Jan-21	19-Jan-22
4933	Active Horn Antenna, 1 GHz to 18 GHz	COM-POWER CORPORATION	AHA-118	701046	26-Jan-21	26-Jan-22
5085	Attenuator, 4 dB, DC - 6 GHz, 1 W	Mini-Circuits	UNAT-4+	NA	22-May-20	22-May-21
5288	Trilog Antenna, 25 MHz - 8 GHz, 100W	Frankonia	ALX-8000E	00809	08-Feb-19	08-Feb-22
5476	Cable, BNC/BNC, 10.5 m	Western wire	MIL-C-17G	NA	14-May-20	14-May-21
5589	Cable, 50 Ohm, DC to 18 GHz, 1.8 m, SMA/N	Mini Circuits	CBL-6FT-SMNM+	NA	27-Oct-20	27-Oct-21
5626	Precision Fixed Attenuator, 50 Ohm, 5 W, 20 dB, DC to 18 GHz	Mini Circuits	BW-N20W5+	NA	21-Sep-20	21-Sep-21
5694	Temp. & Humidity Meter, (-10 - +50) deg, (10 - 99)% RH	Mad Electronics	HTC-1	NA	13-Dec-20	13-Dec-21
5707	EMI receiver	PMM / Narda	PMM 9010F	060WW91101	01-Feb-21	01-Feb-22
5902	RF cable, 18 GHz, 6.0m, N-type	Huber-Suhner	SF126EA/11N/11N/6000		01-Dec-20	01-Dec-21

10 APPENDIX B Measurement uncertainties

Expanded uncertainty at 95% confidence in Hermon Labs EMC measurements

Test description	Expanded uncertainty
Conducted carrier power at RF antenna connector	Below 12.4 GHz: ± 1.7 dB 12.4 GHz to 40 GHz: ± 2.3 dB
Conducted emissions at RF antenna connector	9 kHz to 2.9 GHz: ± 2.6 dB 2.9 GHz to 6.46 GHz: ± 3.5 dB 6.46 GHz to 13.2 GHz: ± 4.3 dB 13.2 GHz to 22.0 GHz: ± 5.0 dB 22.0 GHz to 26.8 GHz: ± 5.5 dB 26.8 GHz to 40.0 GHz: ± 4.8 dB
Occupied bandwidth	± 8.0 %
Duty cycle, timing (Tx ON / OFF) and average factor measurements	± 1.0 %
Conducted emissions with LISN	9 kHz to 150 kHz: ± 3.9 dB 150 kHz to 30 MHz: ± 3.8 dB
Radiated emissions at 3 m measuring distance Horizontal polarization Vertical polarization	Biconilog antenna: ± 5.3 dB Biconical antenna: ± 5.0 dB Log periodic antenna: ± 5.3 dB Double ridged horn antenna: ± 5.3 dB Biconilog antenna: ± 6.0 dB Biconical antenna: ± 5.7 dB Log periodic antenna: ± 6.0 dB Double ridged horn antenna: ± 6.0 dB

Hermon Laboratories is accredited by A2LA for calibration according to present requirements of ISO/IEC 17025 and NCSL Z540-1. The accreditation is granted to perform calibration of parameters that are listed in the Scope of Hermon Laboratories Accreditation.

Hermon Laboratories calibrates its reference and transfer standards by calibration laboratories accredited to ISO/IEC 17025 by a mutually recognized Accreditation Body or by a recognized national metrology institute. All reference and transfer standards used in the calibration system are traceable to national or international standards.

In-house calibration of all test and measurement equipment is performed on a regular basis according to Hermon Laboratories calibration procedures, manufacturer calibration/verification procedures or procedures defined in the relevant standards. The Hermon Laboratories test and measurement equipment is calibrated within the tolerances specified by the manufacturers and/or by the relevant standards.

11 APPENDIX C Test laboratory description

Tests were performed at Hermon Laboratories Ltd., which is a fully independent, private, EMC, Radio, Safety, Environmental and Telecommunication testing facility.

Hermon Laboratories is recognized and accredited by the Federal Communications Commission (USA) for relevant parts of Code of Federal Regulations 47 (CFR 47), Test Firm Registration Number is 927748, Designation Number is IL1001; Recognized by Innovation, Science and Economic Development Canada for wireless and terminal testing (ISED), ISED #2186A, CAB identifier is IL1001; Certified by VCCI, Japan (the registration numbers for OATS are R-10808 for RE measurements below 1 GHz, G-20112 for RE measurements above 1 GHz, R-11082 for anechoic chamber for RE measurements below 1 GHz, G-10869 for RE measurements above 1 GHz, C-10845 for conducted emissions site and T-11606 for conducted emissions at telecommunication ports).

The laboratory is accredited by American Association for Laboratory Accreditation (USA) according to ISO/IEC 17025 for electromagnetic compatibility, product safety, telecommunications testing, environmental simulation and calibration (for exact scope please refer to Certificate No. 839.01, 839.03 and 839.04).

Address: P.O. Box 23, Binyamina 3055001, Israel.
Telephone: +972 4628 8001
Fax: +972 4628 8277
e-mail: mail@hermonlabs.com
website: www.hermonlabs.com

Person for contact: Mr. Michael Nikishin, EMC&Radio group manager

12 APPENDIX D Specification references

FCC 47CFR part 15: 2020	Radio Frequency Devices
ANSI C63.10: 2013	American National Standard of Procedures for Compliance Testing of Unlicensed Wireless Devices
ANSI C63.2: 2016	American National Standard for Instrumentation-Electromagnetic Noise and Field Strength, 10 kHz to 40 GHz-Specifications
ANSI C63.4: 2014	American National Standard for Methods of Measurement of Radio-Noise Emissions from Low-Voltage Electrical and Electronic Equipment in the Range of 9 kHz to 40 GHz
RSS-247 Issue 2: 2017	Digital Transmission Systems (DTSS), Frequency Hopping Systems (FHSs) and Licence- Exempt Local Area Network (LE-LAN) Devices
RSS-Gen Issue 5 with Am.1: 2019	General Requirements for Compliance of Radio Apparatus
ICES-003 Issue 6: 2019 (updated)	Information Technology Equipment (Including Digital Apparatus)— Limits and Methods of Measurement



13 APPENDIX E Test equipment correction factors

Antenna factor
Active loop antenna
Model 6502, S/N 2857, HL 0446

Frequency, MHz	Measured antenna factor, dBS/m
0.009	-32.5
0.010	-33.4
0.020	-37.9
0.050	-40.6
0.075	-41.0
0.100	-41.2
0.150	-41.2
0.250	-41.2
0.500	-41.3
0.750	-41.3
1.000	-41.4
2.000	-41.4
3.000	-41.4
4.000	-41.5
5.000	-41.5
10.000	-41.8
15.000	-42.2
20.000	-42.9
25.000	-43.9
30.000	-45.4

Antenna factor in dB(1/m) is to be added to receiver meter reading in dB(μ V) to convert it into field strength in dB(μ V/m).



Antenna factor
Trilog antenna
Model ALX-8000E, Frankonia, S/N 00809, HL 5288, 30-1000 MHz

Frequency, MHz	Antenna factor, dB/m		
	Vert Up	Vert Down	Delta
30	-51.19	-51.28	0.09
35	-44.03	-44.12	0.09
40	-43.07	-43.12	0.05
45	-39.61	-39.79	0.18
50	-37.84	-38.14	0.3
60	-34.93	-34.9	0.03
70	-29.76	-29.66	0.1
80	-27.69	-27.82	0.13
90	-29.05	-29.07	0.02
100	-31.19	-31.19	0
120	-31.61	-31.6	0.01
140	-28.13	-28.06	0.07
160	-27.71	-27.75	0.04
180	-26.19	-26.15	0.04
200	-28.2	-28.15	0.05
250	-27.45	-27.47	0.02
300	-29.61	-29.63	0.02
400	-31.77	-31.78	0.01
500	-32.81	-32.81	0
600	-33.64	-33.61	0.03
700	-34.21	-34.21	0
800	-35.66	-35.66	0
900	-36.99	-36.91	0.08
1000	-38	-37.91	0.09

Antenna factor in dB(1/m) is to be added to receiver meter reading in dB(μ V) to convert it into field intensity in dB(μ V/m).



Antenna factor
Active Horn Antenna,
Com-Power Corporation, model: AHA-118, s/n 701046, HL 4933

Frequency, MHz	Measured antenna factor (with preamplifier), dB/m
1000	-16.1
1500	-15.1
2000	-10.9
2500	-11.9
3000	-11.1
3500	-10.6
4000	-8.6
4500	-8.3
5000	-5.9
5500	-5.7
6000	-3.3
6500	-4.0
7000	-2.2
7500	-1.7
8000	1.1
8500	-0.8
9000	-1.5
9500	-0.2

Frequency, MHz	Measured antenna factor (with preamplifier), dB/m
10000	1.8
10500	1.0
11000	0.3
11500	-0.5
12000	3.1
12500	1.4
13000	-0.3
13500	-0.4
14000	2.5
14500	2.2
15000	1.9
15500	0.5
16000	2.1
16500	1.2
17000	0.6
17500	3.1
18000	4.2

The antenna factor shall be added to receiver reading in dB μ V to obtain field strength in dB μ V/m.



Correction factor
Line impedance stabilization network
Model ESH 3-Z5, Rhode&Schwarz, HL 3016

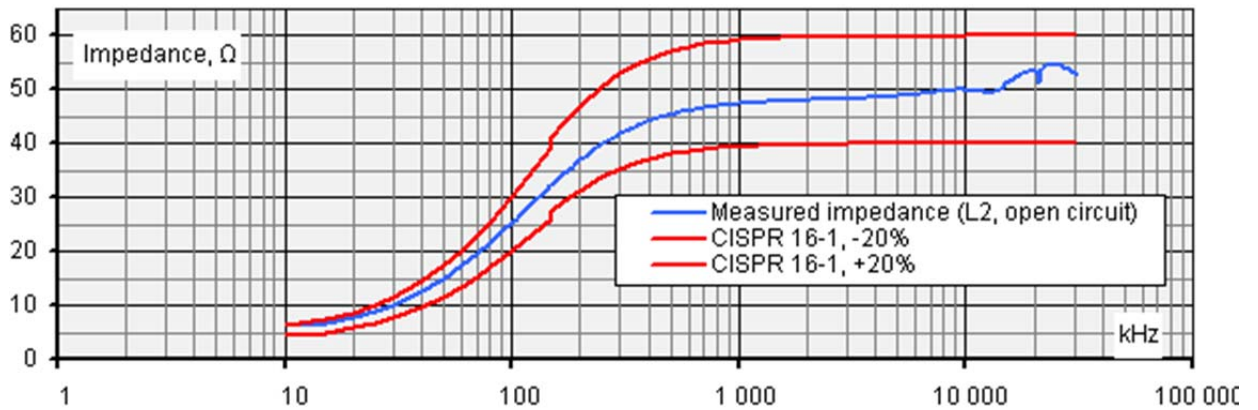
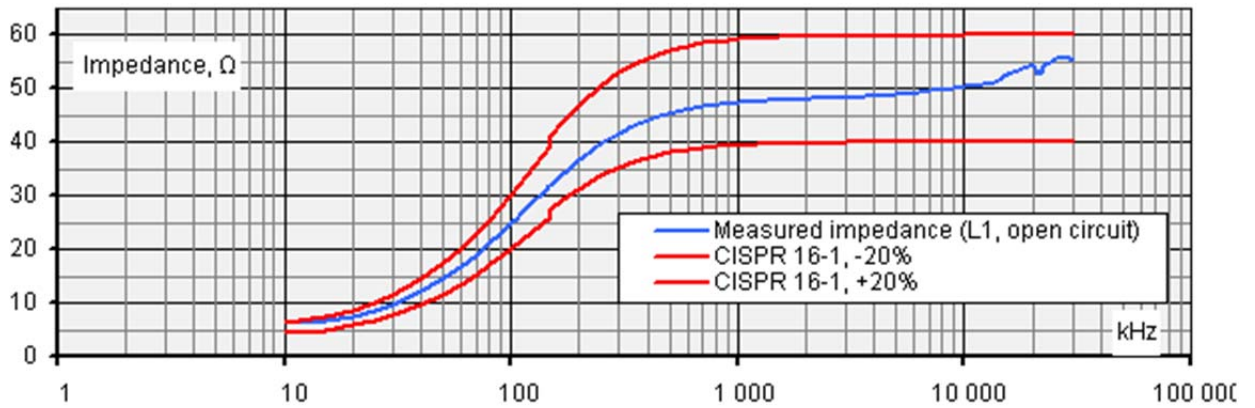



Cable loss
Microwave Cable Assembly, Huber-Suhner, 40 GHz, 3.5 m, SMA-SMA, S/N 1225/2A
HL 3901

Frequency, MHz	Cable loss, dB	Frequency, MHz	Cable loss, dB	Frequency, MHz	Cable loss, dB
10	0.09	9500	4.29	21000	6.67
100	0.41	10000	4.40	22000	6.92
500	0.93	10500	4.52	23000	7.00
1000	1.33	11000	4.64	24000	7.18
1500	1.63	11500	4.76	25000	7.29
2000	1.90	12000	4.87	26000	7.55
2500	2.12	12500	4.99	27000	7.70
3000	2.33	13000	5.11	28000	7.88
3500	2.50	13500	5.20	29000	8.02
4000	2.67	14000	5.31	30000	8.15
4500	2.82	14500	5.42	31000	8.35
5000	2.99	15000	5.51	32000	8.40
5500	3.16	15500	5.58	33000	8.62
6000	3.32	16000	5.68	34000	8.73
6500	3.51	16500	5.78	35000	8.78
7000	3.65	17000	5.91	36000	8.94
7500	3.79	17500	5.99	37000	9.21
8000	3.92	18000	6.07	38000	9.37
8500	4.04	19000	6.36	39000	9.45
9000	4.18	20000	6.49	40000	9.52



Cable loss
Microwave Cable Assembly, Huber-Suhner, 40 GHz, 1.5 m, SMA-SMA, S/N 1227/2A
HL 3902

Frequency, MHz	Cable loss, dB	Frequency, MHz	Cable loss, dB	Frequency, MHz	Cable loss, dB
10	-0.02	9500	1.84	21000	2.93
100	0.15	10000	1.86	22000	3.04
500	0.38	10500	1.93	23000	3.08
1000	0.56	11000	1.99	24000	3.18
1500	0.69	11500	2.04	25000	3.23
2000	0.82	12000	2.10	26000	3.34
2500	0.90	12500	2.15	27000	3.39
3000	0.98	13000	2.21	28000	3.49
3500	1.06	13500	2.25	29000	3.55
4000	1.11	14000	2.29	30000	3.64
4500	1.17	14500	2.34	31000	3.68
5000	1.24	15000	2.36	32000	3.77
5500	1.32	15500	2.40	33000	3.87
6000	1.40	16000	2.45	34000	3.93
6500	1.50	16500	2.48	35000	3.89
7000	1.56	17000	2.56	36000	4.00
7500	1.62	17500	2.58	37000	4.15
8000	1.68	18000	2.60	38000	4.20
8500	1.74	19000	2.80	39000	4.25
9000	1.78	20000	2.85	40000	4.32



Cable loss
Microwave Cable Assembly, Huber-Suhner, 40 GHz, 1.5 m, SMA-SMA, S/N 1226/2A
HL 3903

Frequency, MHz	Cable loss, dB	Frequency, MHz	Cable loss, dB	Frequency, MHz	Cable loss, dB
10	-0.02	9500	1.84	21000	2.98
100	0.15	10000	1.86	22000	3.07
500	0.38	10500	1.93	23000	3.13
1000	0.56	11000	1.99	24000	3.21
1500	0.69	11500	2.04	25000	3.26
2000	0.82	12000	2.10	26000	3.48
2500	0.90	12500	2.15	27000	3.44
3000	0.98	13000	2.21	28000	3.53
3500	1.06	13500	2.25	29000	3.59
4000	1.11	14000	2.29	30000	3.66
4500	1.17	14500	2.34	31000	3.70
5000	1.24	15000	2.36	32000	3.79
5500	1.32	15500	2.40	33000	3.88
6000	1.40	16000	2.45	34000	3.94
6500	1.50	16500	2.48	35000	3.91
7000	1.56	17000	2.56	36000	4.05
7500	1.62	17500	2.58	37000	4.22
8000	1.68	18000	2.60	38000	4.25
8500	1.74	19000	2.84	39000	4.27
9000	1.78	20000	2.88	40000	4.33



Cable loss
Cable, BNC/BNC, 10.5 m MIL-C-17G
Western wire, HL 5476

Frequency, MHz	Cable loss, dB	Frequency, MHz	Cable loss, dB
0.01	0.12	270	3.07
10	0.56	280	3.13
20	0.79	290	3.19
30	0.97	300	3.26
40	1.11	310	3.32
50	1.25	320	3.40
60	1.37	330	3.46
70	1.48	340	3.52
80	1.58	350	3.58
90	1.68	360	3.62
100	1.79	370	3.70
110	1.88	380	3.75
120	1.96	390	3.82
130	2.05	400	3.87
140	2.12	410	3.93
150	2.20	420	3.98
160	2.29	430	4.06
170	2.37	440	4.11
180	2.44	450	4.18
190	2.51	460	4.22
200	2.58	470	4.27
210	2.66	480	4.35
220	2.74	490	4.39
230	2.80	500	4.45
240	2.87		
250	2.93		
260	3.01		



Cable loss
RF Cable, Mini Circuits, 18 GHz, 1.8 m, SMA/N-type
CBL-6FT-SMNM+, S/N 506775/126EA
HL 5589

Frequency, MHz	Cable loss, dB	Frequency, MHz	Cable loss, dB
0.1	0.01	8750	2.47
10	0.04	9000	2.50
30	0.09	9250	2.52
50	0.15	9500	2.56
100	0.21	9750	2.61
250	0.34	10000	2.64
500	0.50	10250	2.68
750	0.61	10500	2.71
1000	0.71	10750	2.74
1250	0.80	11000	2.77
1500	0.88	11250	2.80
1750	0.96	11500	2.83
2000	1.03	11750	2.86
2250	1.10	12000	2.88
2500	1.16	12250	2.92
2750	1.23	12500	2.95
3000	1.29	12750	2.98
3250	1.35	13000	3.01
3500	1.40	13250	3.05
3750	1.47	13500	3.10
4000	1.52	13750	3.12
4250	1.57	14000	3.19
4500	1.64	14250	3.26
4750	1.68	14500	3.32
5000	1.74	14750	3.33
5250	1.79	15000	3.32
5500	1.84	15250	3.34
5750	1.88	15500	3.36
6000	1.93	15750	3.41
6250	1.98	16000	3.41
6500	2.04	16250	3.47
6750	2.10	16500	3.51
7000	2.16	16750	3.53
7250	2.22	17000	3.58
7500	2.27	17250	3.57
7750	2.32	17500	3.62
8000	2.37	17750	3.61
8250	2.40	18000	3.65
8500	2.44		



Cable loss
RF cable, 18 GHz, 6.0m, N-type, Huber-Suhner, S/N 511435/126EA,
SF126EA/11N/11N/6000, HL 5902

Frequency, MHz	Cable loss, dB	Frequency, MHz	Cable loss, dB	Frequency, MHz	Cable loss, dB	Frequency, MHz	Cable loss, dB
0.1	0.00	4800	3.24	10000	4.82	15200	6.08
1	0.01	4900	3.30	10100	4.85	15300	6.11
10	0.07	5000	3.32	10200	4.87	15400	6.12
30	0.18	5100	3.37	10300	4.91	15500	6.14
50	0.25	5200	3.40	10400	4.93	15600	6.15
100	0.41	5300	3.42	10500	4.95	15700	6.18
200	0.56	5400	3.46	10600	4.99	15800	6.20
300	0.68	5500	3.50	10700	5.01	15900	6.23
400	0.76	5600	3.53	10800	5.03	16000	6.22
500	0.87	5700	3.56	10900	5.06	16100	6.26
600	1.03	5800	3.58	11000	5.08	16200	6.29
700	1.14	5900	3.63	11100	5.12	16300	6.30
800	1.23	6000	3.67	11200	5.13	16400	6.33
900	1.34	6100	3.69	11300	5.16	16500	6.35
1000	1.43	6200	3.73	11400	5.18	16600	6.37
1100	1.51	6300	3.76	11500	5.22	16700	6.40
1200	1.59	6400	3.80	11600	5.24	16800	6.43
1300	1.66	6500	3.81	11700	5.25	16900	6.46
1400	1.73	6600	3.83	11800	5.28	17000	6.47
1500	1.78	6700	3.87	11900	5.32	17100	6.49
1600	1.82	6800	3.91	12000	5.33	17200	6.51
1700	1.87	6900	3.91	12100	5.35	17300	6.53
1800	1.89	7000	3.93	12200	5.38	17400	6.56
1900	1.95	7100	3.95	12300	5.39	17500	6.60
2000	1.99	7200	3.98	12400	5.43	17600	6.62
2100	2.02	7300	4.02	12500	5.46	17700	6.60
2200	2.06	7400	4.04	12600	5.48	17800	6.63
2300	2.11	7500	4.07	12700	5.50	17900	6.64
2400	2.16	7600	4.11	12800	5.52	18000	6.66
2500	2.21	7700	4.15	12900	5.57		
2600	2.29	7800	4.17	13000	5.57		
2700	2.32	7900	4.20	13100	5.60		
2800	2.38	8000	4.22	13200	5.61		
2900	2.44	8100	4.26	13300	5.64		
3000	2.47	8200	4.30	13400	5.67		
3100	2.53	8300	4.32	13500	5.70		
3200	2.57	8400	4.35	13600	5.71		
3300	2.61	8500	4.39	13700	5.73		
3400	2.67	8600	4.43	13800	5.74		
3500	2.71	8700	4.45	13900	5.80		
3600	2.76	8800	4.47	14000	5.82		
3700	2.80	8900	4.49	14100	5.85		
3800	2.85	9000	4.53	14200	5.86		
3900	2.89	9100	4.55	14300	5.87		
4000	2.93	9200	4.57	14400	5.92		
4100	2.98	9300	4.61	14500	5.93		
4200	3.01	9400	4.64	14600	5.95		
4300	3.05	9500	4.68	14700	5.97		
4400	3.10	9600	4.70	14800	6.01		
4500	3.12	9700	4.73	14900	6.04		
4600	3.18	9800	4.78	15000	6.04		
4700	3.21	9900	4.80	15100	6.08		



14 APPENDIX F Abbreviations and acronyms

A	ampere
AC	alternating current
A/m	ampere per meter
AM	amplitude modulation
AVRG	average (detector)
cm	centimeter
dB	decibel
dBm	decibel referred to one milliwatt
dB(μ V)	decibel referred to one microvolt
dB(μ V/m)	decibel referred to one microvolt per meter
dB(μ A)	decibel referred to one microampere
DC	direct current
EIRP	equivalent isotropically radiated power
ERP	effective radiated power
EUT	equipment under test
F	frequency
GHz	gigahertz
GND	ground
H	height
HL	Hermon laboratories
Hz	hertz
k	kilo
kHz	kilohertz
LO	local oscillator
m	meter
MHz	megahertz
min	minute
mm	millimeter
ms	millisecond
μ s	microsecond
NA	not applicable
NB	narrow band
OATS	open area test site
Ω	Ohm
PM	pulse modulation
PS	power supply
ppm	part per million (10^{-6})
QP	quasi-peak
RE	radiated emission
RF	radio frequency
rms	root mean square
Rx	receive
s	second
T	temperature
Tx	transmit
V	volt
WB	wideband

END OF DOCUMENT