

EMC Laboratory

MMR TRANSCEIVER

Manufactured by
Tadiran-Telematics

EMC Test Report

According to FCC Part 15 Requirements

June. 2002

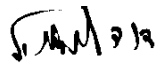
REPAIRED: D. Lanuel  DATE July 10, 2002

APPROVED: S. Cohen  DATE July 10, 2002

Table of Contents

<i>Para</i>	<i>Page</i>
<u>1. TEST DATA INFORMATION</u>	4
1.1. <u>DESCRIPTION OF EQUIPMENT UNDER TEST</u>	4
1.2. <u>APPLICANT INFORMATION</u>	4
1.3. <u>TEST PERFORMANCE</u>	4
<u>2. TEST SUMMARY AND SIGNATURES</u>	5
2.1. <u>TEST PERFORMED BY</u>	5
2.2. <u>TEST REPORT PREPARED BY</u>	5
2.3. <u>TEST REPORT APPROVED BY</u>	5
<u>3. GENERAL INFORMATION</u>	6
3.1. <u>SPECIFICATION REFERENCE</u>	6
3.2. <u>APPLICABLE DOCUMENTS</u>	6
3.3. <u>EUT DESCRIPTION</u>	7
<u>4. ADMINISTRATIVE DATA</u>	8
4.1. <u>SCOPE</u>	8
4.2. <u>ADMINISTRATIVE DATA</u>	8
4.3. <u>CERTIFICATION AND QUALIFICATIONS</u>	8
4.4. <u>MEASUREMENT REPEATABILITY INFORMATION</u>	8
4.5. <u>MEASURING EQUIPMENT CALIBRATION</u>	9
<u>ANTENNAS CALIBRATION</u>	9
<u>5. OUT OF BAND RADIATED FIELD STRENGTH MEASUREMENT TEST ACCORDING TO 15.249 & 15.209</u>	10
5.1. <u>GENERAL</u>	10
5.2. <u>TEST RESULTS SUMMARY & CONCLUSIONS</u>	10
5.3. <u>LIMITS OF RADIATED INTERFERENCE FIELD STRENGTH ACCORDING 15.209</u>	10
5.4. <u>LIMITS OF RADIATED INTERFERENCE FIELD STRENGTH ACCORDING 15.209</u>	10
5.5. <u>TEST INSTRUMENTATION AND EQUIPMENT</u>	11
5.6. <u>PRELIMINARY TEST PROCEDURE</u>	13
5.7. <u>PRELIMINARY RESULTS</u>	14
<u>6. FINAL RADIATED INTERFERENCE FIELD STRENGTH MEASUREMENT</u>	28
6.1. <u>TEST INSTRUMENTATION AND EQUIPMENT</u>	28
6.2. <u>TEST SETUP</u>	28
6.3. <u>FINAL TEST RESULTS</u>	30
<u>7. CONDUCTED EMISSIONS, AC POWR LEADS ACCORDING TO FCC 15.207</u>	31
<u>FREQUENCY RANGE: 450 kHz – 30 MHz</u>	31
7.1. <u>EQUIPMENT UNDER TEST DESCRIPTION AND OPERATION</u>	31
7.2. <u>TEST RESULTS SUMMARY & CONCLUSIONS</u>	31
7.3. <u>LIMITS OF CONDUCTED EMISSION AT MAINS TERMINALS</u>	31
7.4. <u>TEST INSTRUMENTATION AND EQUIPMENT</u>	31
7.5. <u>TEST SETUP</u>	31
7.6. <u>TEST PROCEDURE</u>	34
<u>8. EUT INTRODUCTION</u>	42
8.1. <u>THE FOLLOWING DOCUMENT DESCRIBES THE TECHNICAL SPECIFICATION OF THE METER & MONITORING READER BOARD (CALLED MMR) FOR THE USA MARKET</u>	42
8.2. <u>THE MMR IS A COMPACT 2-WAY HALF DUPLEX RF UNIT OPERATES AT 902-928 MHz ISM BAND</u>	42
8.3. <u>DEFINITIONS, ABBREVIATION AND ACRONYMS</u>	42
<u>9. MMR DESCRIPTION</u>	42

<u>9.1.</u>	<u>OPERATIONAL MODES</u>	42
<u>9.2.</u>	<u>BOARD LAYOUT AND SIZE</u>	42
10.	<u>ELECTRICAL PERFORMANCE</u>	43
<u>10.1.</u>	<u>TRANSMIT UNIT</u>	43
<u>10.2.</u>	<u>RECEIVE UNIT</u>	44
<u>10.3.</u>	<u>EXTERNAL INTERFACES</u>	44
<u>10.4.</u>	<u>ANTENNA</u>	45
<u>10.5.</u>	<u>POWER SOURCE</u>	45
<u>10.6.</u>	<u>ENVIRONMENTAL CONDITIONS</u>	45
11.	<u>MMR CIRCUIT BOARD LAYOUT PHOTOGRAPH</u>	46
<u>11.1.</u>	<u>PRINT SIDE LAYOUT PHOTOGRAPH</u>	46
<u>11.2.</u>	<u>COMPONENT SIDE LAYOUT PHOTOGRAPH</u>	47
<u>11.3.</u>	<u>RECEIVER/ TRANSMITTER AREA COMPONENT SIDE LAYOUT</u>	48

1. TEST DATA INFORMATION

1.1. Description of equipment Under Test.

Equipment Under Test: **MMR-1**

Serial Numbers: **0001**
Mode of Operation: **RX MODE – 916.3MHz**
TX MODE – 916.3MHz

Year of Manufacture: **2002**

1.2. Applicant Information:

Applicant: **TADIRAN Telematics Ltd.**
Applicant Address: **26 HAMELACHA St. HOLON 58117**

Telephone: **972-3-5575773**

FAX: **972-3-5575753**
The testing was observed by the following applicant's personnel: **Mr. Genik Anatoly**
Mr. slava Snitkovski

1.3. Test Performance:

Date of reception for testing: **10/6/02**

Dates of testing: **11/6/02**
Test Laboratory Location: **TADIRAN EMC LAB , Hashoftim 26 Holon**
58102
ISRAEL
Tel :972-3-5574476 Fax: 972-3-5575320
Federal Communication Commission (FCC),
Code of Federal Regulations 47,
FCC Docket 89-103,
Part 15: Radio Frequency Devices,
Sections 15.107 & 15.109 & 15.209, & 15.249
Class B

Applicable
EMC Specification:

2. TEST SUMMARY AND SIGNATURES.

TADIRAN EMC Laboratory has completed testing of EUT in accordance with the requirements of the FCC Part 15 Regulations for Class B equipment.

The EUT has been found to comply with the emission requirements of the FCC Part 15 Regulations for parts 15.107&15.207&15.249:

2.1. Test performed by:

Mr. D. Lanuel Test Engineer



2.2. Test Report prepared by:

Mr. D. Lanuel Test Engineer

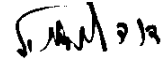

2.3. Test Report Approved by:

Mr. Samuel Cohen EMC Lab. Manager



3. GENERAL INFORMATION

3.1. Specification Reference

- Section 15.107: Limits of Mains Terminal Interference Voltage (Conducted Emission) in the 0.45MHz to 30MHz frequency range. For Unintentional Radiators.**
- Section 15.207: Limits of Mains Terminal Interference Voltage (Conducted Emission) in the 0.45MHz to 30MHz frequency range. For Intentional Radiators.**
- Section 15.109: Limits of Radiated Interference Field Strength in the 30MHz to 1000MHz frequency range.**
- Section 15.209: Limits of Radiated Interference Field Strength in the 30MHz to 1000MHz frequency range.**
- Section 15.249: Limits of Radiated Interference Field Strength in the 9kHz to 40GHz frequency range, for Intentional Radiators operating in Freq Range 902MHz –928MHz**

3.2. Applicable Documents.

- 3.1 Federal Communication Commission (FCC), Code of Federal Regulations 47, FCC Docket 89-103, Part 15: Radio Frequency Devices, Sections 15.107 & 15.109.**
- 3.2 FCC/OET, Laboratory Measurement Procedures MP-4, July 1987, "FCC Procedures for Measuring RF Emissions from Computing Devices".**
- 3.3 FCC/Office of Science and Technology OST-55, August 1982, "Characteristics of Open Field Test Sites".**
- 3.4 FCC/OET, "FCC Procedure for Measuring Electromagnetic Emissions from Digital Devices", TP-5, March 1989.**
- 3.5 FCC/OET, "Understanding the FCC Regulations Concerning Computing Devices", OST-62, May 1984**
- 3.6 International Special Committee On Radio Interference (CISPR) Publication 16, First Edition 1977, "CISPR Specification for Radio Interference Measuring Apparatus and Measurement Methods".**
- 3.7 American National Standard, "Specifications for Electromagnetic Noise and Field Strength Instrumentation, 9KHz to 1GHz", ANSI C63.2, 1987.**
- 3.8 American National Standard, "Method of Measurement Electromagnetic Emissions from Low-Voltage Electrical and Electronic Equipment in the range of 9KHz to 40GHz", ANSI C63.4, 1992.**

3.3. EUT description

3.3.1. The MMR is a compact 2-way half duplex RF unit operates at the ISM band, 916.3MHz.

- The MMR Receiver is used for wireless data collection (transmitted from water meters)
- The MMR Transmitter is used for wireless programming of the water meter transceiver

3.3.2. EUT Block Diagram

- A block diagram of the MMR is described below.

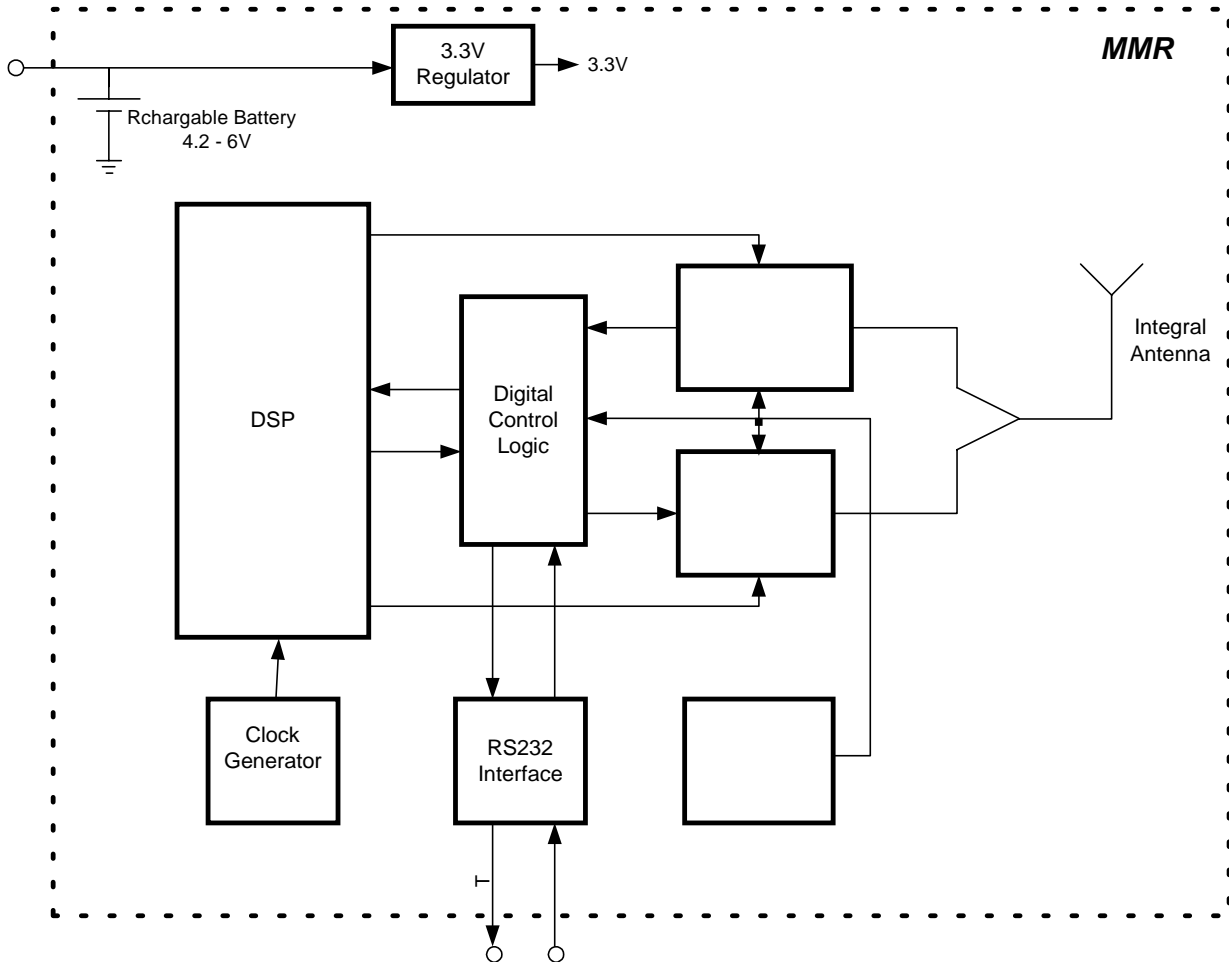

3.3.3. Equipment Photographs

Refer to Appendix A

3.3.4. EUT Test Configuration

- The EUT test configuration for Conducted and Radiated Emission measurements is given in figures 2,3.
- Auxiliary test equipment list for radiated emission test is given in table 2
- Auxiliary test equipment list for Conducted emission test is given in table 3

4. ADMINISTRATIVE DATA

4.1. Scope

This document describes the measurement procedures and tests for Radiated and conducted emission testing of the MMR Manufactured by TADIRAN-Telematics.

4.2. Administrative Data

The test was performed by the TADIRAN / EMC Laboratory, 26 Hashoftim St. P.O.B. 267, 58102 Holon, ISRAEL.

4.3. Certification And Qualifications

I Certify that TADIRAN / EMC Laboratory. Conducted the tests performed in order to obtain a technical data presented in this application. Also based on the results of this enclosed data I have concluded that the equipment tested meets or exceeds the requirements of the Rules and regulations governing this application.

TADIRAN / EMC Laboratory, 26 Hashoftim St. P.O.B. 267, 58102 Holon, ISRAEL was established in 1975 to provide Electromagnetic Compatibility testing, Consulting and Engineering. All facility are equipped with modern Automated test equipment and staffed with experienced EMC test engineers. Engineering support is a standard feather of our sites, we are ready to support and assist our customers in meeting the compliance requirements.

Our qualifications include:

Quality assurance MIL-I-45208A

Calibration per MIL-STD-45662A

FCC Listed

ISO 9001 Approved By The International Certification Network "IQNet"

ISO 9001 Approved By the Standards Institute of Israel.

Approved by I.D.F for Compliance with regulation.

Approved by I.A.F for Compliance with regulation

TADIRAN / EMC Laboratory has previously performed FCC testing of similar equipment. Appendix A includes an FCC approval of our application for licensing of a previous generation of a Transceiver product operating under the requirements of FCC part 15.247 for intentional radiator equipment. As well as evidence for our accreditation by ISO 9001 & listing by FCC.

4.4. Measurement Repeatability information

The test data presented in this report has been acquired using the guidelines set forth in FCC Part 15 .The test data presented in this document are valid only for the equipment identified under the test conditioned described. Repeatability of these tests results will only be achieved with identical test conditions. This conditions include: the same test distance, EUT height, measurement site characteristics and the same EUT System components, The system must have the same interconnecting cables arranged in identical placement to that in the test set-up, with the system and /or EUT functioning in identical mode of operation (i.e. software and so on) as on the date of the test. Any deviation from the test conditions and the environment on the date of test may result in measurement repeatability difficulties. All changes made to the EUT during the course of testing as identified in this test report must be incorporated into the EUT or identical modes to ensure compliance with the FCC regulations.

4.5. MEASURING EQUIPMENT CALIBRATION

4.5.1. Receiving System Calibration

The equipment calibration is traceable. Calibration is performed under the MIL-STD-45662A requirements

Antennas calibration

Biconical and Log-periodic antennas are calibrated by using the reference antenna method according to ANSI C63.5-1988, when the reference antenna is the Robert`s antenna.

Double-ridged guide antennas (1-18 GHz) are calibrated by using two identical antenna methods according to ANSI C63.2-1987 and SAE ARP-958

Calibration of listed above antennas is performed periodically once a year

Robert antenna is calibrated every three years by using the reference antenna method according to ANSI C63.5-1988, when the reference antenna is the calibrated Robert antenna.

Antennas, which are used according to military standards tests, are calibrated every two years by using two identical antenna methods according to SAE ARP-958.

5. OUT OF BAND RADIATED FIELD STRENGTH MEASUREMENT TEST ACCORDING TO 15.249 & 15.209

Testing Engineer: D.Lanuel *[Signature]*

Date 11/06/02

5.1. General

The test was performed to measure Radiated emission at RX Mode and Out of Band Spurious emissions at TX Mode.

5.2. Test Results Summary & Conclusions

5.2.1. The EUT was found in compliance with 15.209 & 15.249 Requirements

5.3. Limits of Radiated Interference Field Strength according 15.209

The test unit shall meet the limits of Table 1 for Class B equipment.

Table 1 Limits For Class B equipment

Frequency Range (MHz)	Quasi-peak Limits (dBμV/m)
30 - 88	40
88 - 216	43
216 - 960	46
Above 960	54

5.4. Limits of Radiated Interference Field Strength according 15.209

The test unit shall meet the limits of Table 1 for Class B equipment.

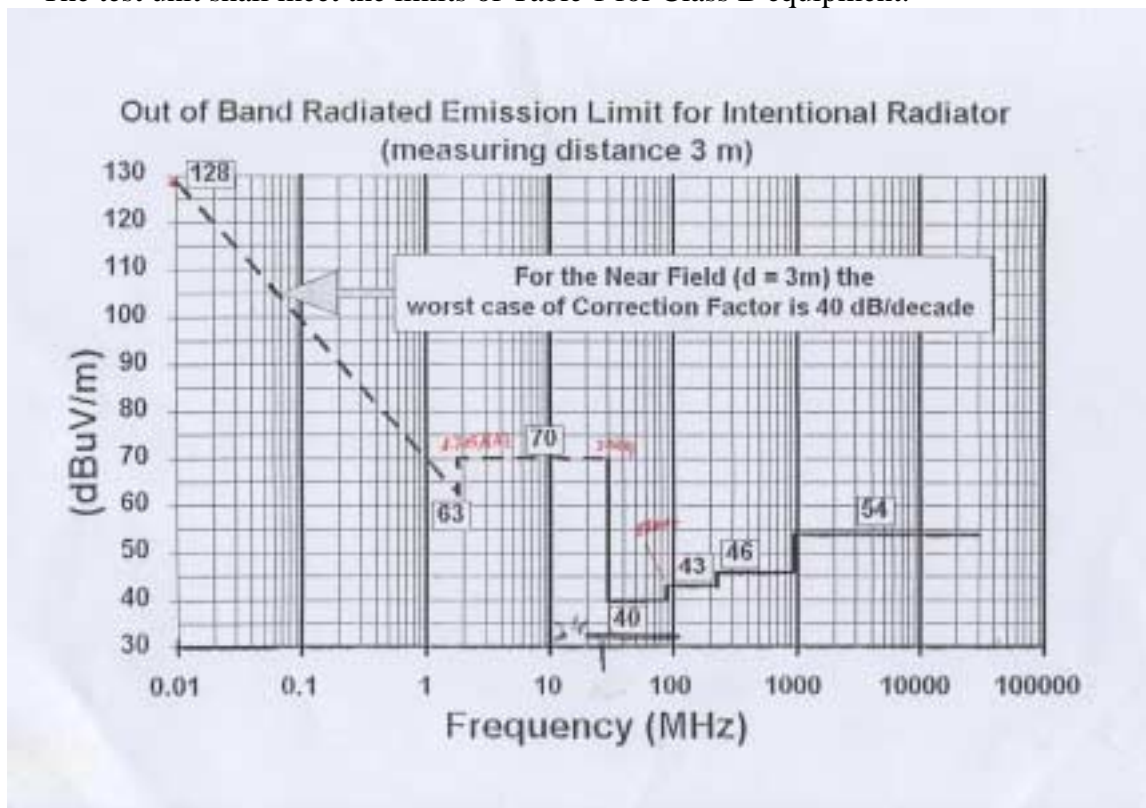

5.5. Test Instrumentation and Equipment

Table RE-A Test Instrumentation and Equipment

Item	Model	Manufacturer	Next Date Calibration
Spectrum Analyzer	8597A	HP	01/08/02
Spectrum Analyzer	8593E	HP	31/01/03
Biconical Antenna	94455-1	ZINGER	10.04.03
Log-Periodic Antenna	AT-1000	AR	10.04.03
Low Noise Amplifier (0-1GHz)	AM-1300-N	MITEQ	14.01.03
Low Noise Amplifier (1-2GHz)	SMC-09	MITEQ	14.01.03
Low Noise Amplifier (2-6GHz)	MWA-02060-4025	ELISRA	14.01.03
Low Noise Amplifier (6-18GHz)	MWA-06180-4165	ELISRA	06.06.03

5.5.1. The measuring system block diagram shown in Figure RE-1.

5.5.2. EUT orientation and antenna position shown in Figure RE-2

5.5.3. Cables configuration shown in Figure RE-3

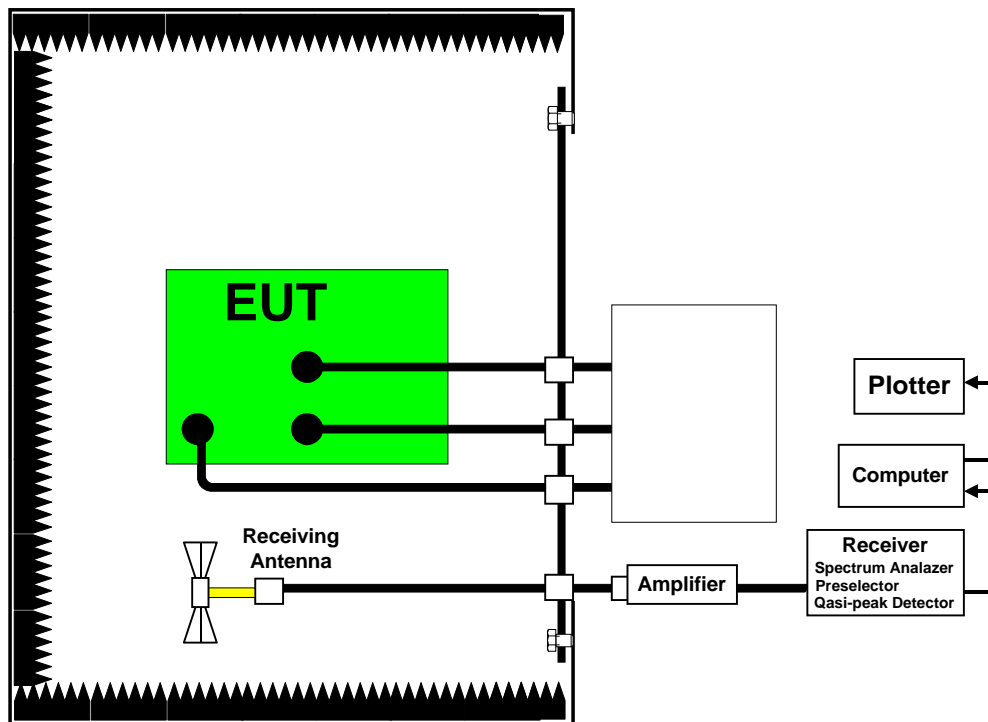

Absorber-Lined Shielded Room

Figure RE-1

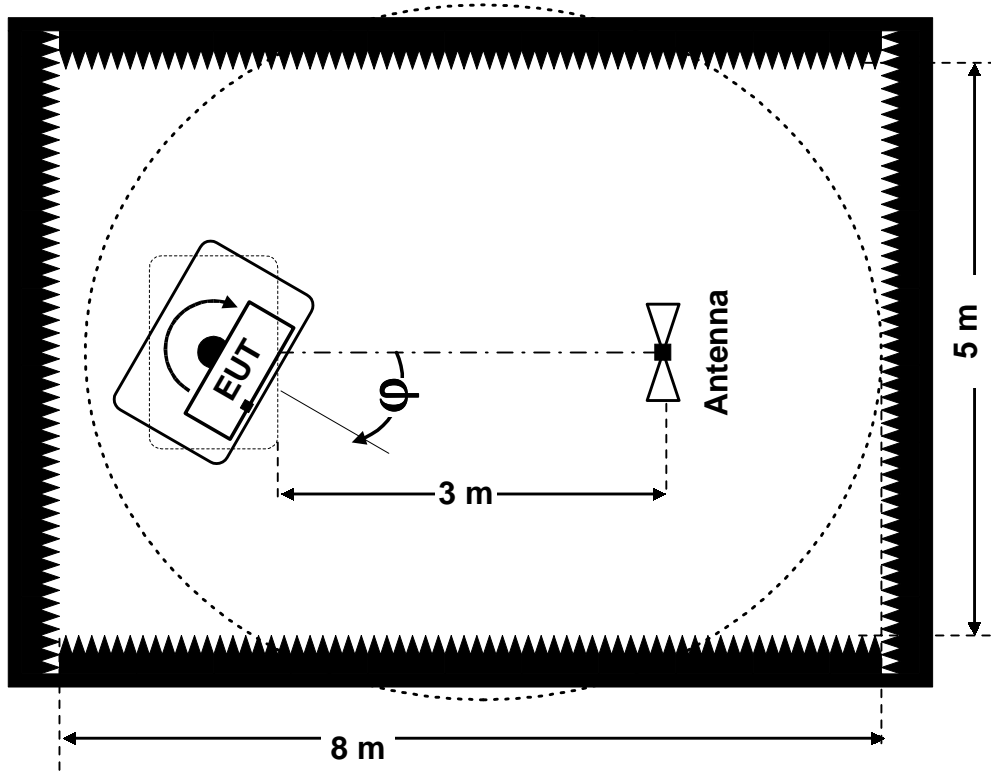

Figure RE-2

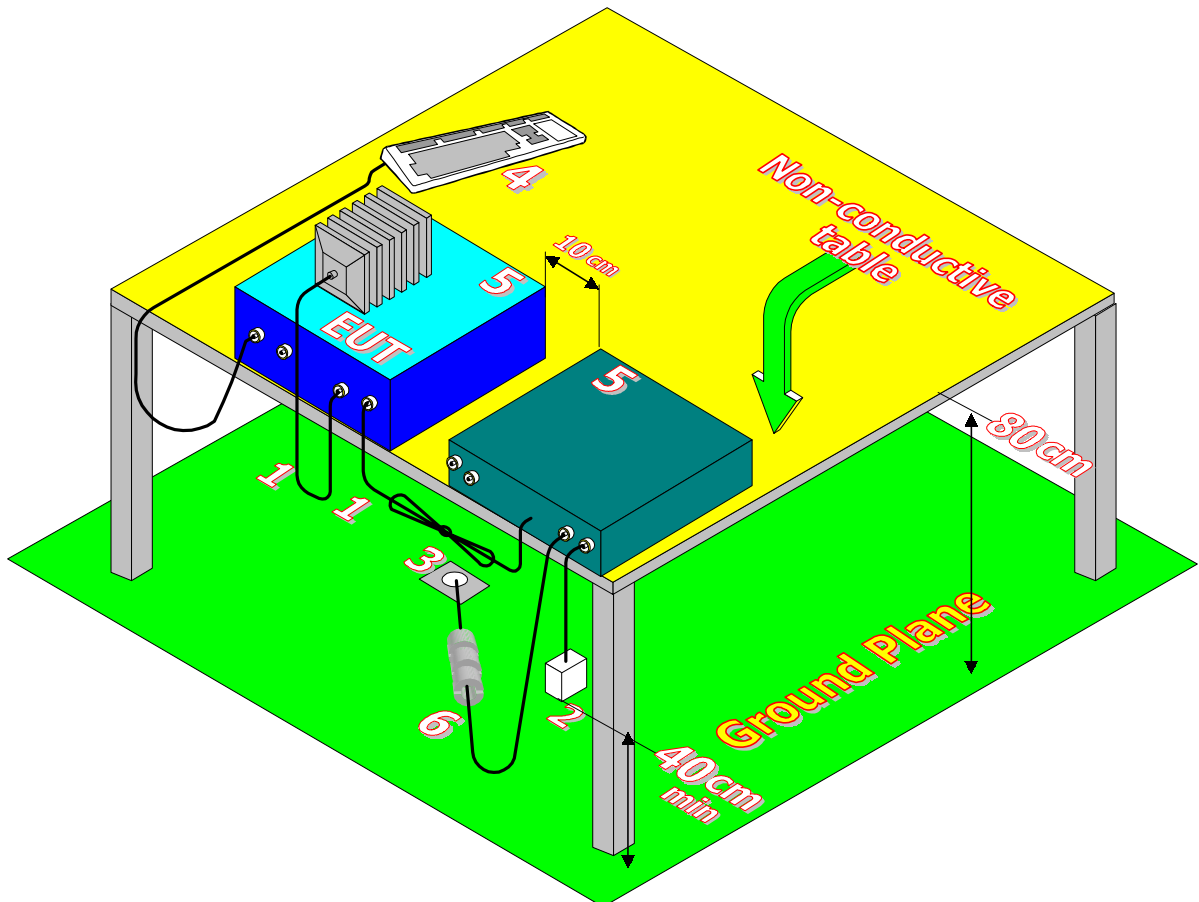

Figure RE-3

1. If cables, which hang closer than 40 cm to the horizontal ground plane cannot be shortened to the appropriate length, the excess shall be folded back and forth forming a bundle 30 cm to 40 cm long.
2. The end of I/O signal cables, which are not connected to a peripheral, may be terminated, if required to proper operation using correct terminating impedance.
3. Main junction boxes shall be flush with, and bonded directly to, metal ground plane
4. Cables of hand operated devices such as keyboards, mouses; etc. shall be placed as for normal usage.
5. Peripherals shall be placed at distance 10 cm from each other and from the controller, except for the monitor which, if for an acceptable installation practice, shall be placed directly on top of the controller.
6. Mains cables, telephone lines or other connections to auxiliary equipment located outside the test area shall drape to the floor, be fitted with ferrite clamps or ferrite tubes placed on the floor at the point where the cable reaches the floor and then routed to the place where they leave the turn table. No extension cords shall be used to mains receptacle.
7. Ferrite clamps or ferrite tubes. No more than one cable per clamp.

5.6. Preliminary Test Procedure

- 5.6.1. Maintain setup in absorber-lined shielded room as shown in Figures RE-1, RE-2 and RE-3.
- 5.6.2. Turn on the EUT for TX-916.3MHz mode and allow sufficient time for stabilization.
- 5.6.3. Monitor the frequency range of interest at a fixed antenna height and EUT azimuth.
- 5.6.4. Rotate the EUT 360° to maximize the suspected highest amplitude signal.
- 5.6.5. Move the antenna over its full-allowed range of travel to maximize the suspected highest amplitude signal.
- 5.6.6. Change the polarity of the antenna and repeat step d and e. Compare the result suspected highest amplitude signal with that found for the other polarity. Select and note the higher of the two signals. The signal is termed the highest observed signal with the respect to the limit.
- 5.6.7. Repeat testing for each operational mode of the EUT.
- 5.6.8. Choose six highest emissions relative to limit and record antenna heights and polarities, EUT configuration for each emission frequency.
- 5.6.9. Perform measurements for selected frequencies using quasi-peak detector.

5.7. Preliminary Results

Table RE-B Preliminary Test Results for RX Mode 15.107

Mode Of Operation	Antenna Polarization	Frequency Range MHz	Res. BW (kHz)	Plot No.	Compliance Y/N
RX-916.3MHz	Vertical	30-200	120	Plot RE/1	Y
	Horizontal			Plot RE/2	Y
	Vertical	200-1000		Plot RE/3	Y
	Horizontal			Plot RE/4	Y

Table RE-B Preliminary Test Results for TX Mode Spurious According 15.249

Mode Of Operation	Antenna Polarization	Frequency Range MHz	Res. BW (kHz)	Plot No.	Compliance Y/N
TX-916.3MHz	Vertical	902-928	120	Plot RE/5	Y
	Horizontal	902-928		Plot RE/6	Y

Table RE-B Preliminary Test Results for TX Mode 15.209

Mode Of Operation	Antenna Polarization	Frequency Range MHz	Res. BW (kHz)	Plot No.	Compliance Y/N	
TX MODE 916.3MHz	Vertical	0.009-0.15	0.2	Plot RE/7	Y	
	Horizontal	0.15-30	9	Plot RE/8	Y	
TX-916.3MHz	Vertical	30-200	120	Plot RE/9	Y	
	Horizontal			Plot RE/10	Y	
	Vertical	200-902		Plot RE/11	Y	
	Horizontal			Plot RE/12	Y	
	Vertical	902-928		Plot RE/13	Y	
	Horizontal			Plot RE/14	Y	
	Vertical	928-1000		Plot RE/15	Y	
	Horizontal			Plot RE/16	Y	
	Vertical	1000-2000		1000	Plot RE/17	Y
	Horizontal				Plot RE/18	Y
	Vertical	2000-2800			Plot RE/19	Y
	Horizontal				Plot RE/20	Y
	Vertical	2800-6000			Plot RE/21	Y
	Horizontal				Plot RE/22	Y
	Vertical	6000-9200			Plot RE/23	Y
	Horizontal				Plot RE/24	Y

Table RE-E Six Highest Emissions RX Mode 15.107

Mode Of Operation	Freq. (MHz)	Quasi-peak Reading (*) (dB μ V/m)	Limit (dB μ V/m)	Margin (dB)	Polarity Ver/Hor	Height (m)	Azimuth Angle ϕ (deg)
RX	99.7	25.1	43.5	18.4	V	2.1	-25
	200.0	31.0	46	27	H	2.0	-25
	296.0	42.0	46	4	H	1.8	-25
	500.0	27.0	46	19	H	1.8	-25
	704.0	31.0	46	15	H	1.9	-25
	844.0	35.0	46	11	V	2.0	-25
	908.0	30.0	46	16	H	2.0	-25

(*) Resolution B/W = 120 kHz

Table RE-E Six Highest Emissions Spurious TX Mode 15.209

Mode Of Operation	Freq. (MHz)	Quasi-peak Reading (*) (dB μ V/m)	Limit (dB μ V/m)	Margin (dB)	Polarity Ver/Hor	Height (m)	Azimuth Angle ϕ (dig)
	231.0	34.0	46.0	12	V	2.4	-25
	704.0	38.0	46.0	8	V	2.4	-25
	845.0	44.5	46.0	1.5	V	2.4	-25
	1100.0	42.0	54.0	8	V	1.8	-25
	1200.0	46.0	54.0	12	V	1.8	-25
	3664.0	46.0	54.0	12	H	1.8	-25

Table RE-E Six Highest Emissions Spurious TX Mode 15.209

Mode Of Operation	Freq. (MHz)	Quasi-peak Reading (*) (dB μ V/m)	Limit (dB μ V/m)	Margin (dB)	Polarity Ver/Hor	Height (m)	Azimuth Angle ϕ (deg)
	902.0	41.0	46.0	5	H	2.4	-25

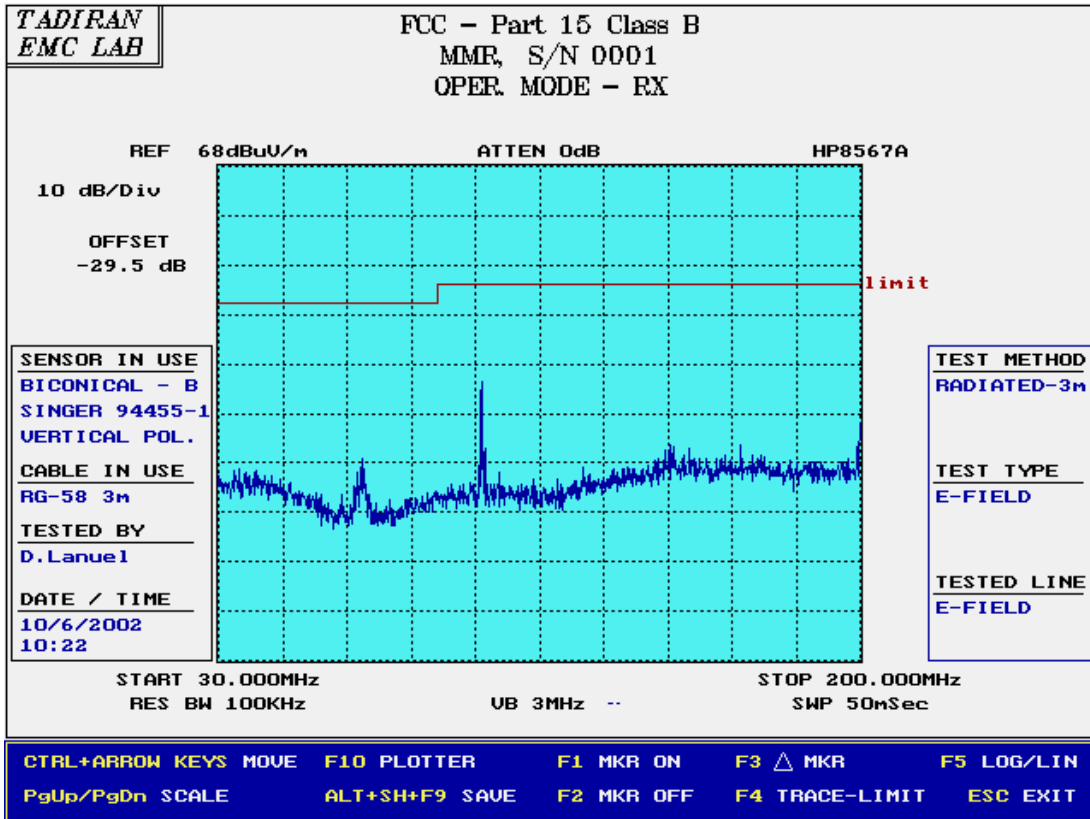

PLOT RE/ 1

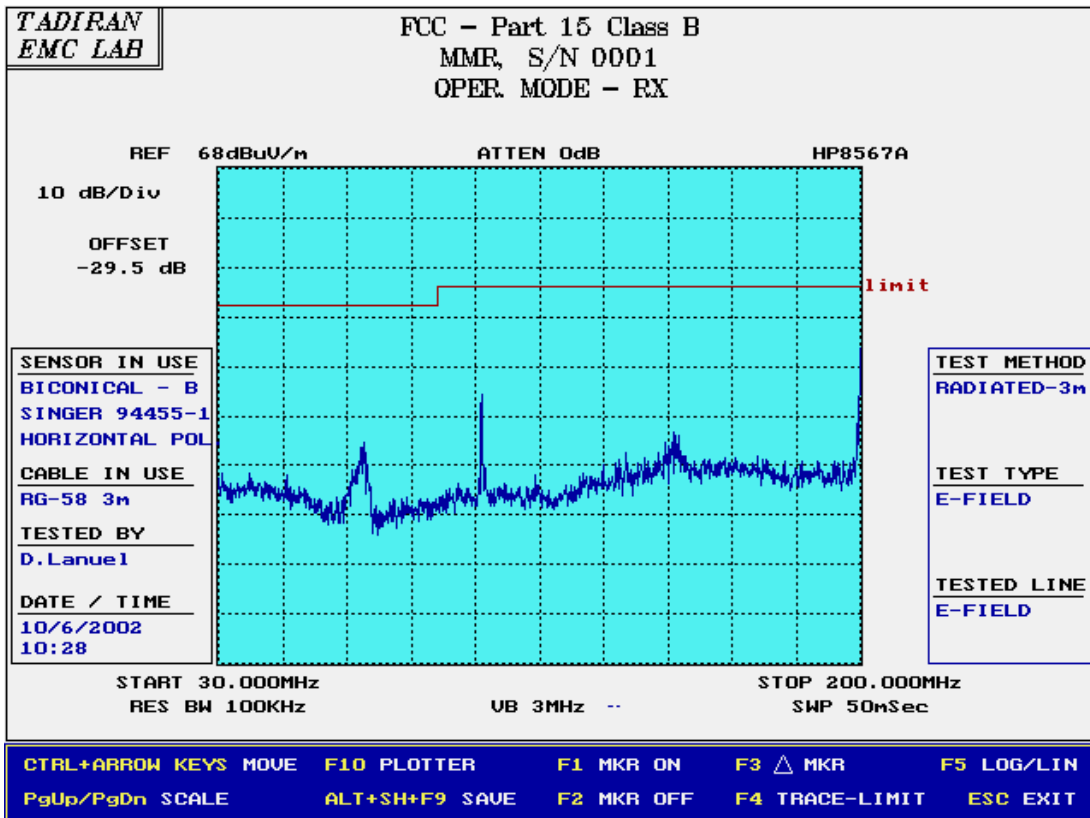

PLOT RE/ 2

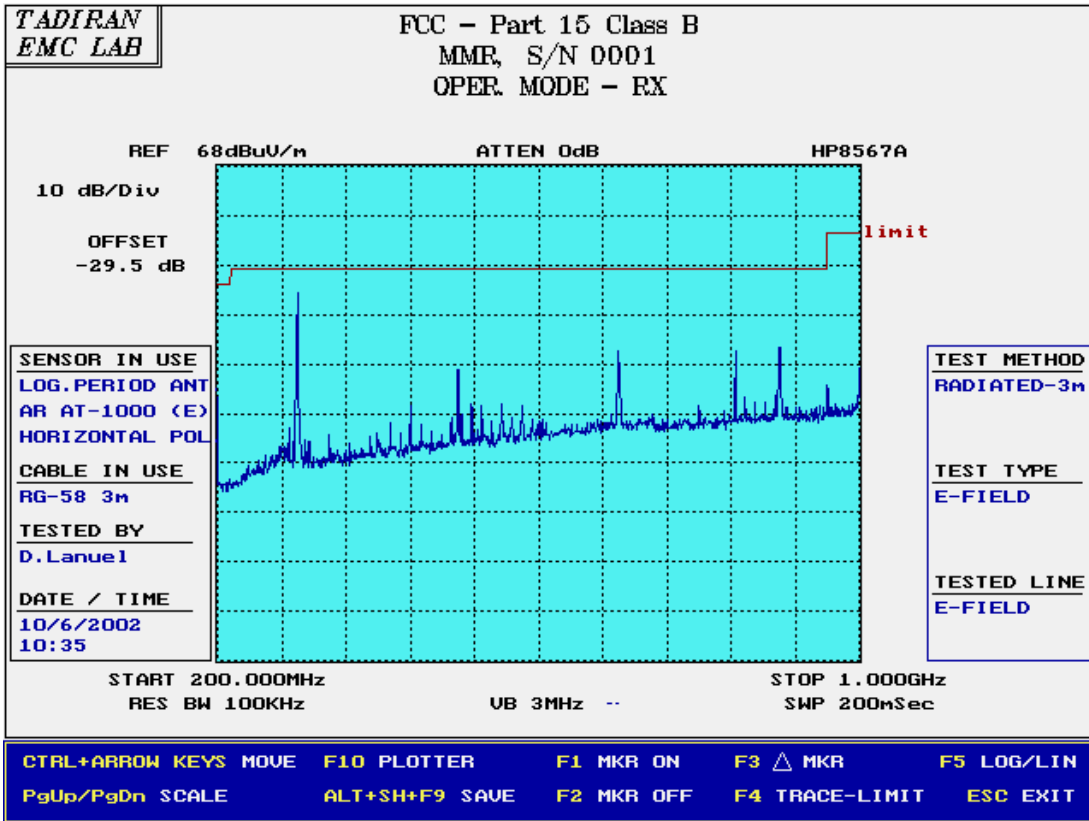

PLOT RE/ 3

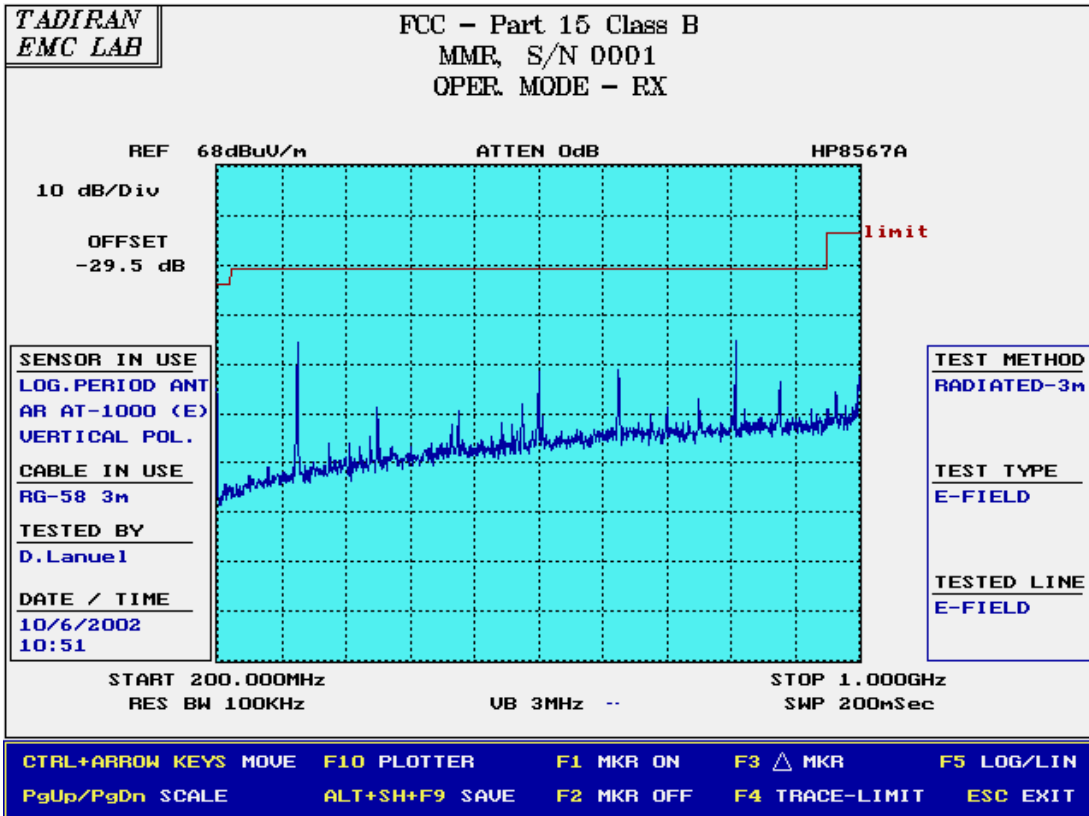

PLOT RE/ 4

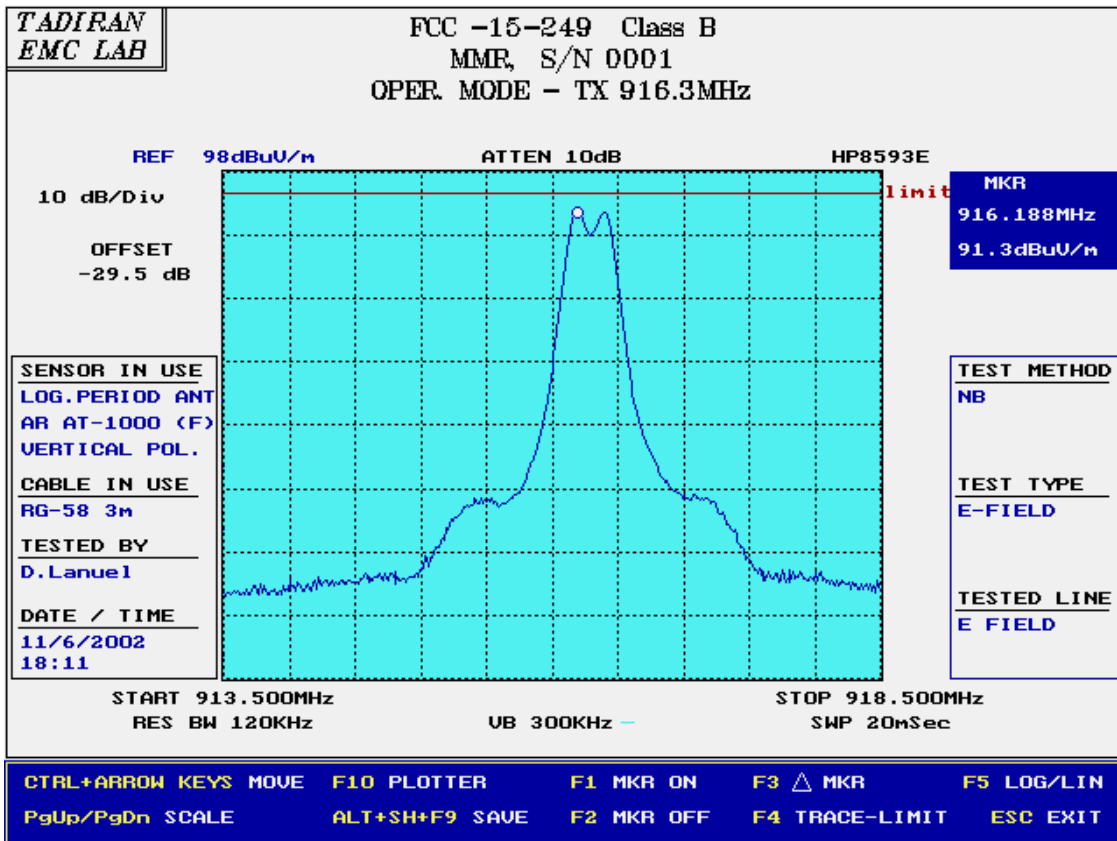

PLOT RE/ 5

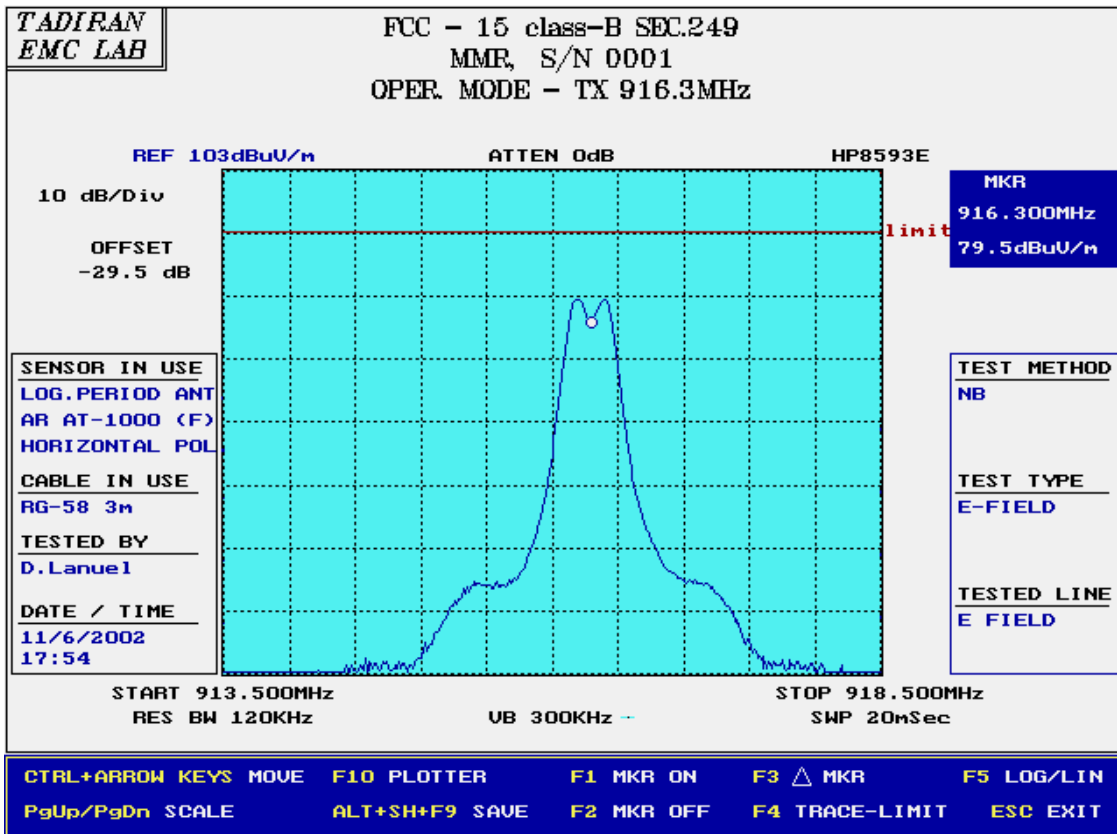

PLOT RE/ 6

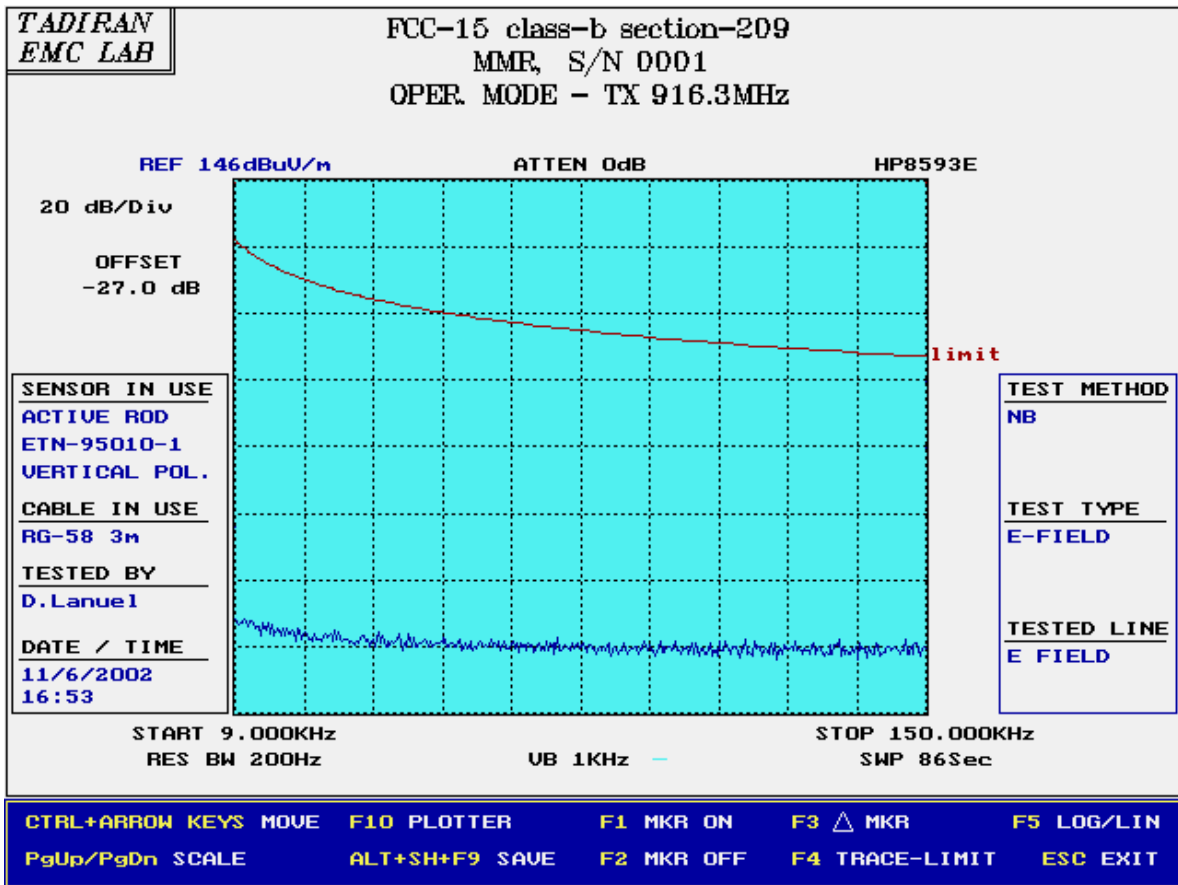

PLOT RE/ 7

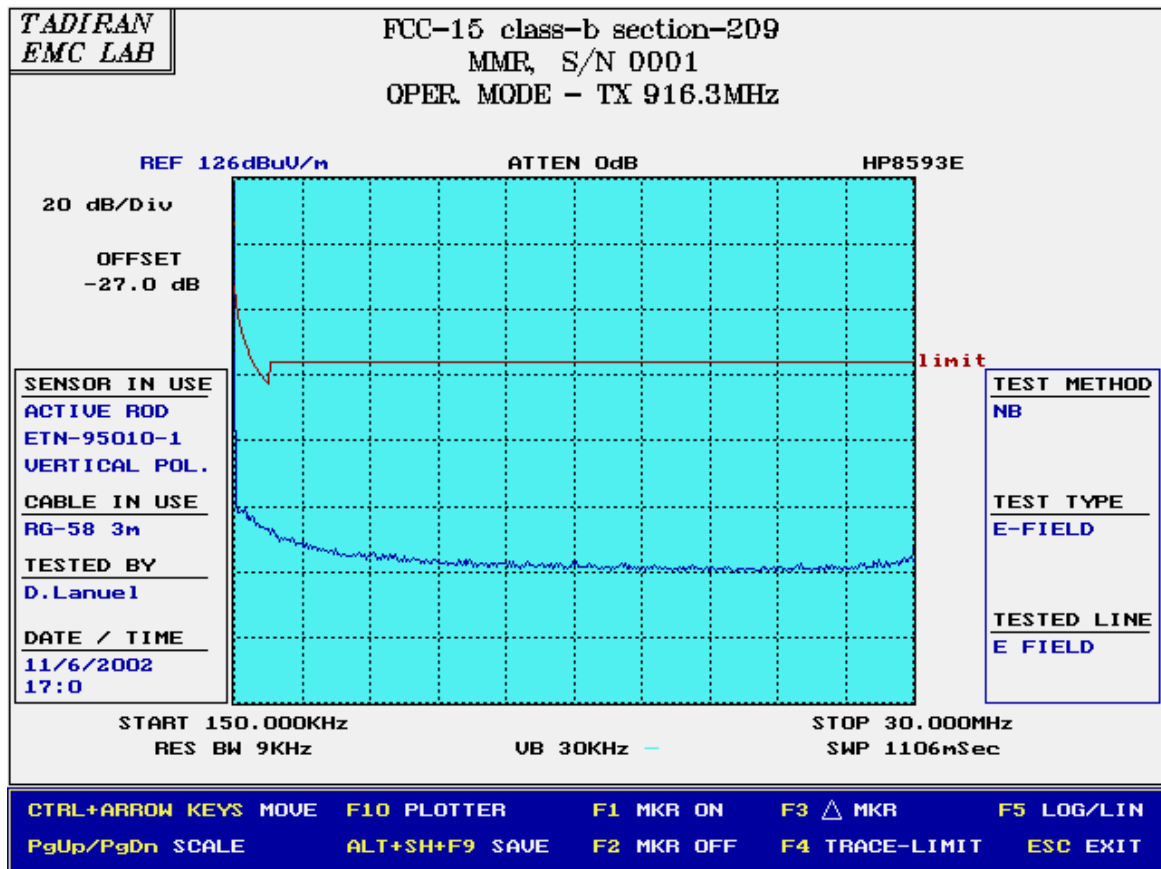

PLOT RE/ 8

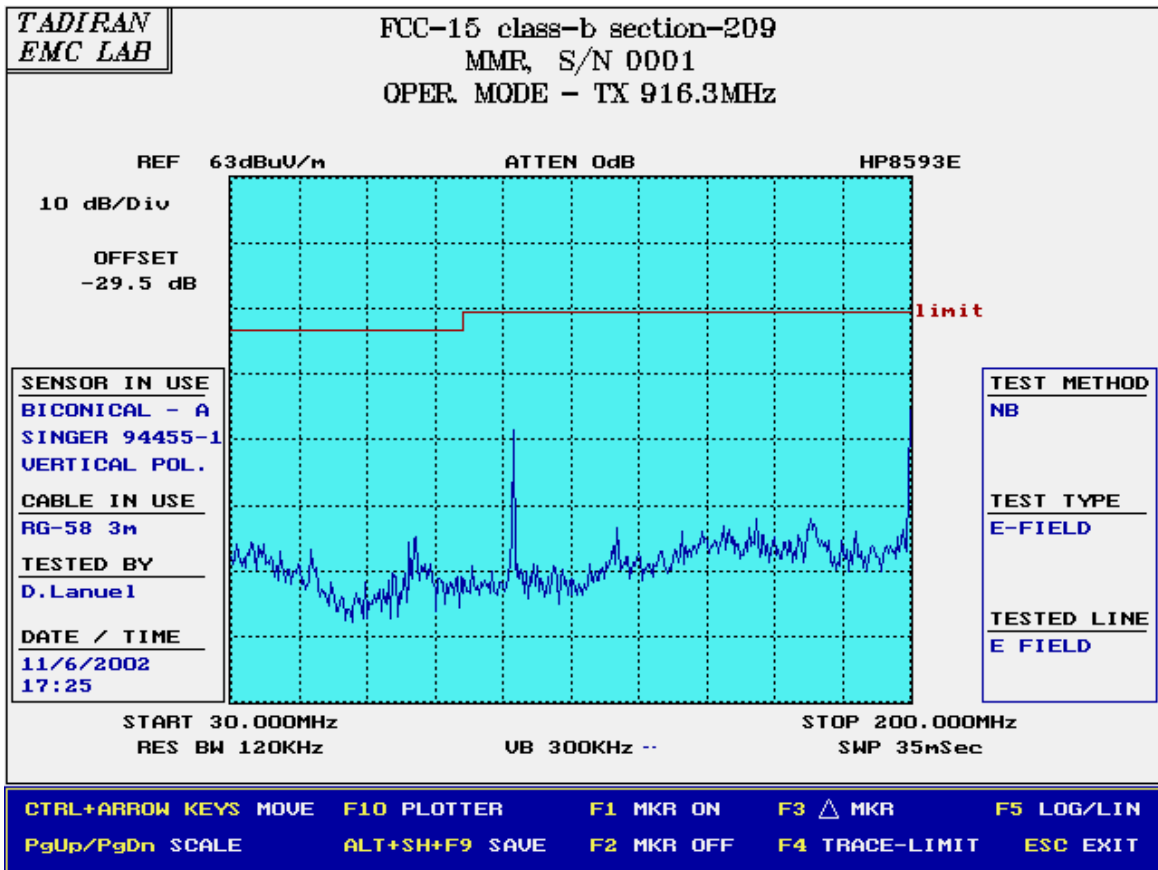

PLOT RE/ 9

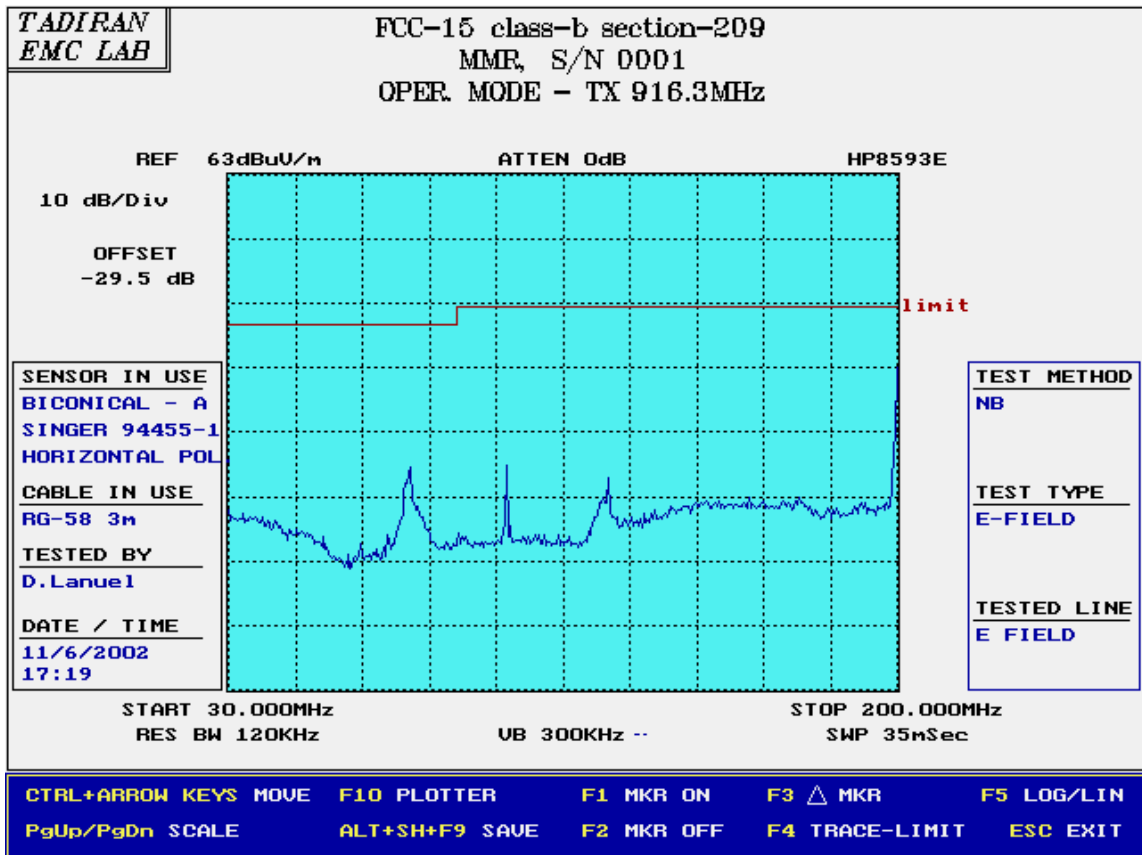

PLOT RE/ 10

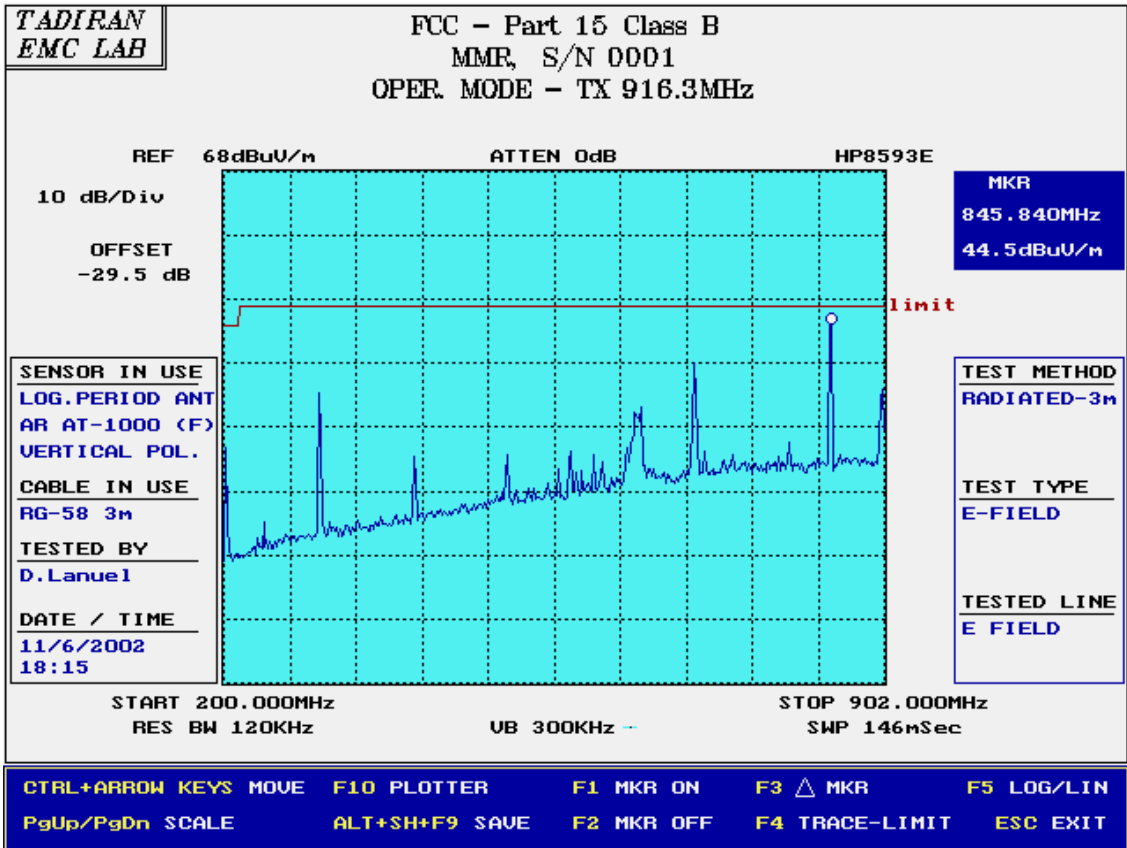

PLOT RE/ 11

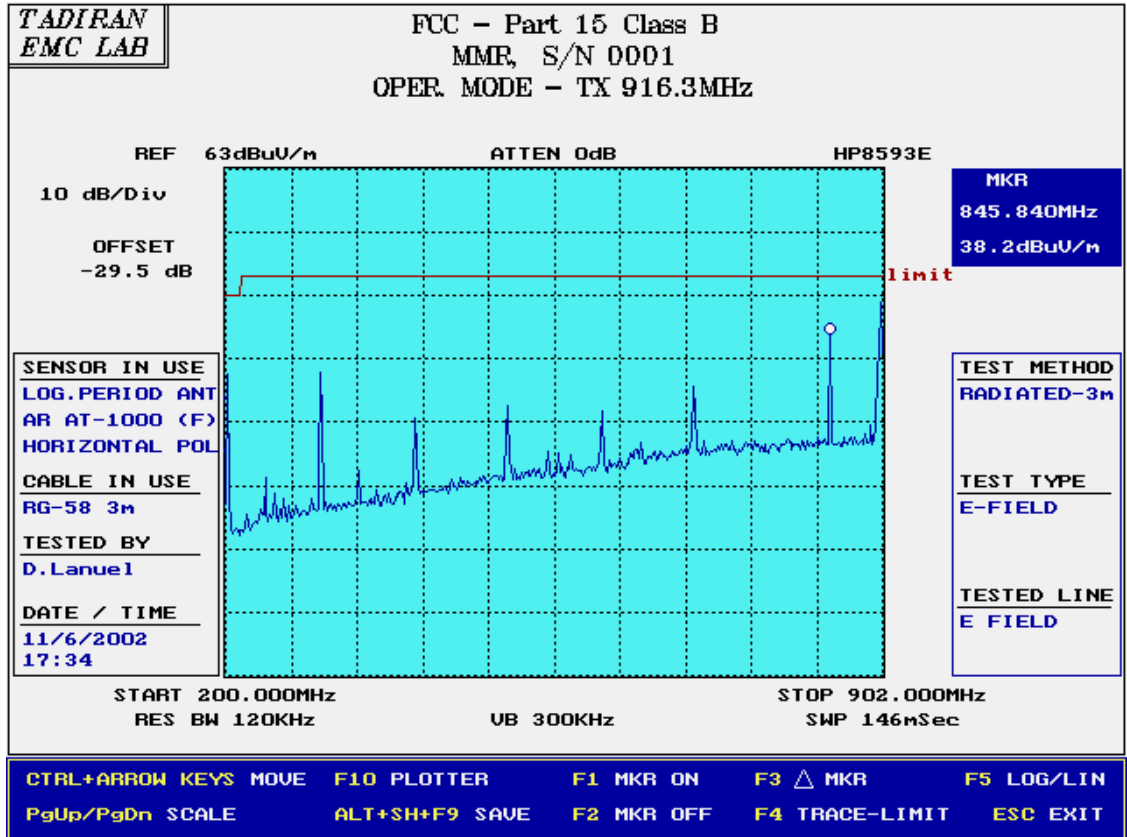

PLOT RE/ 12

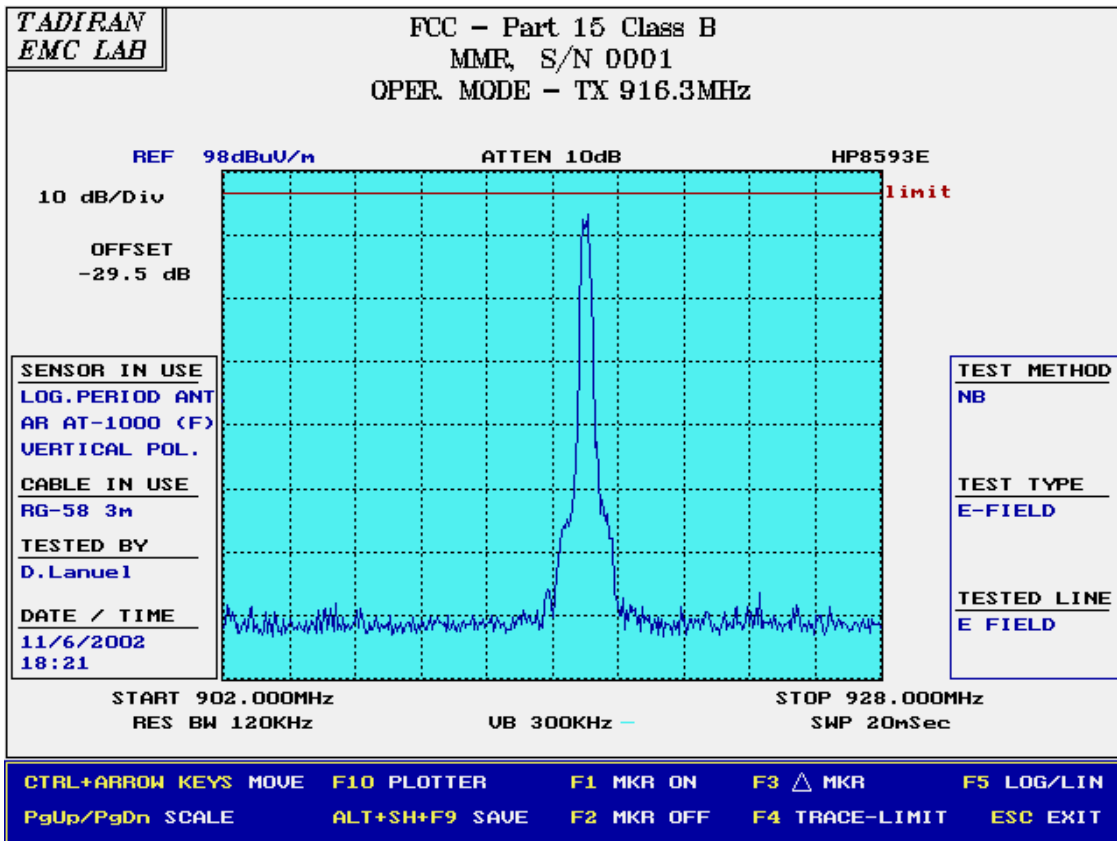

PLOT RE/ 13

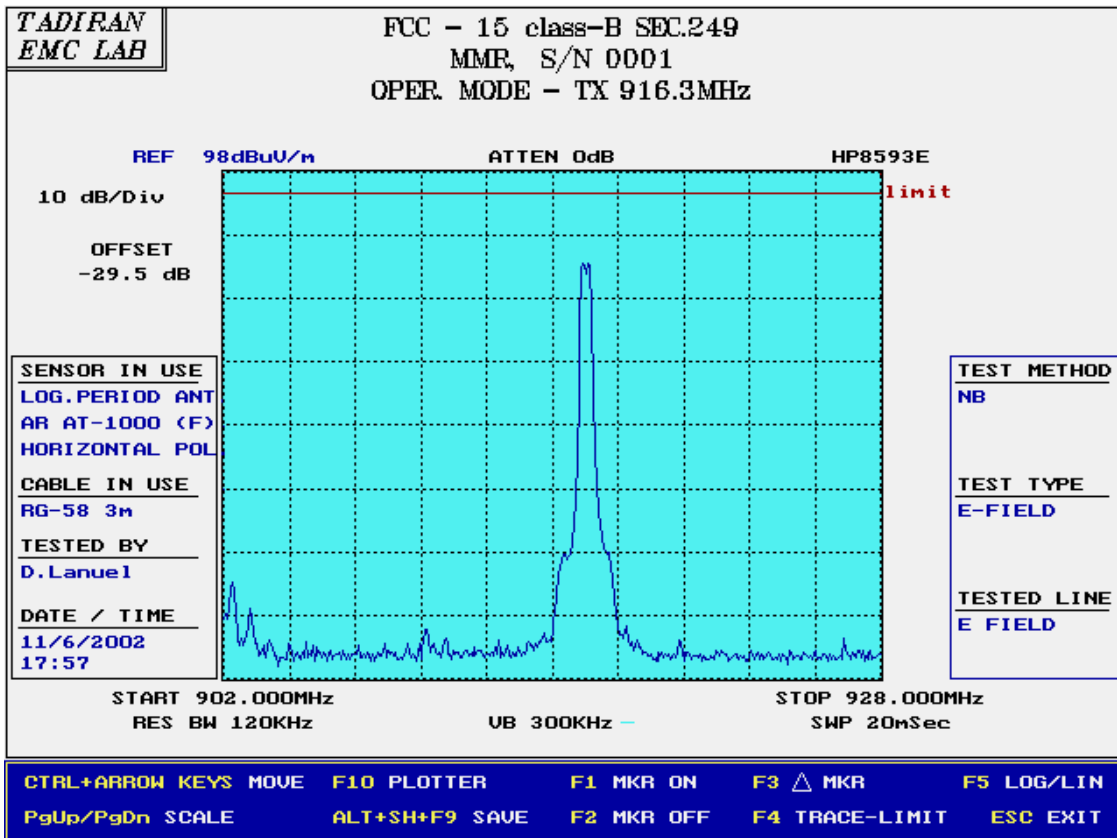

PLOT RE/ 14

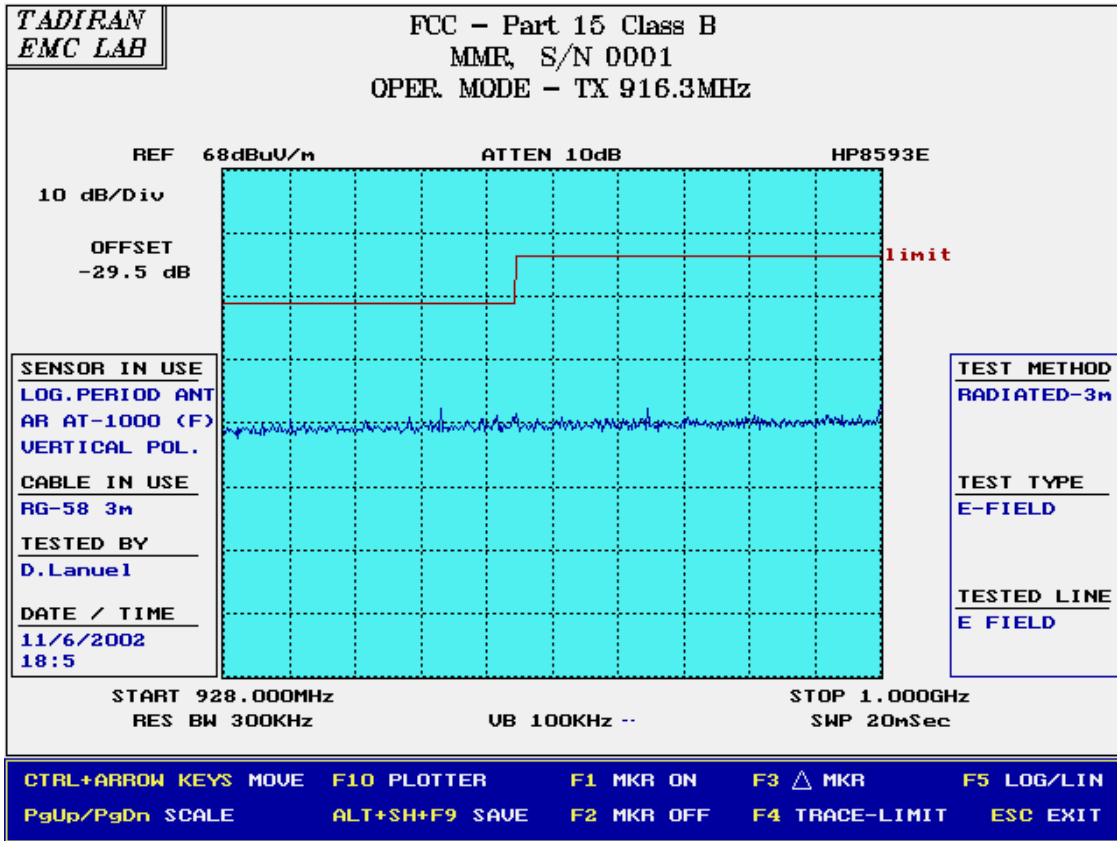

PLOT RE/ 15

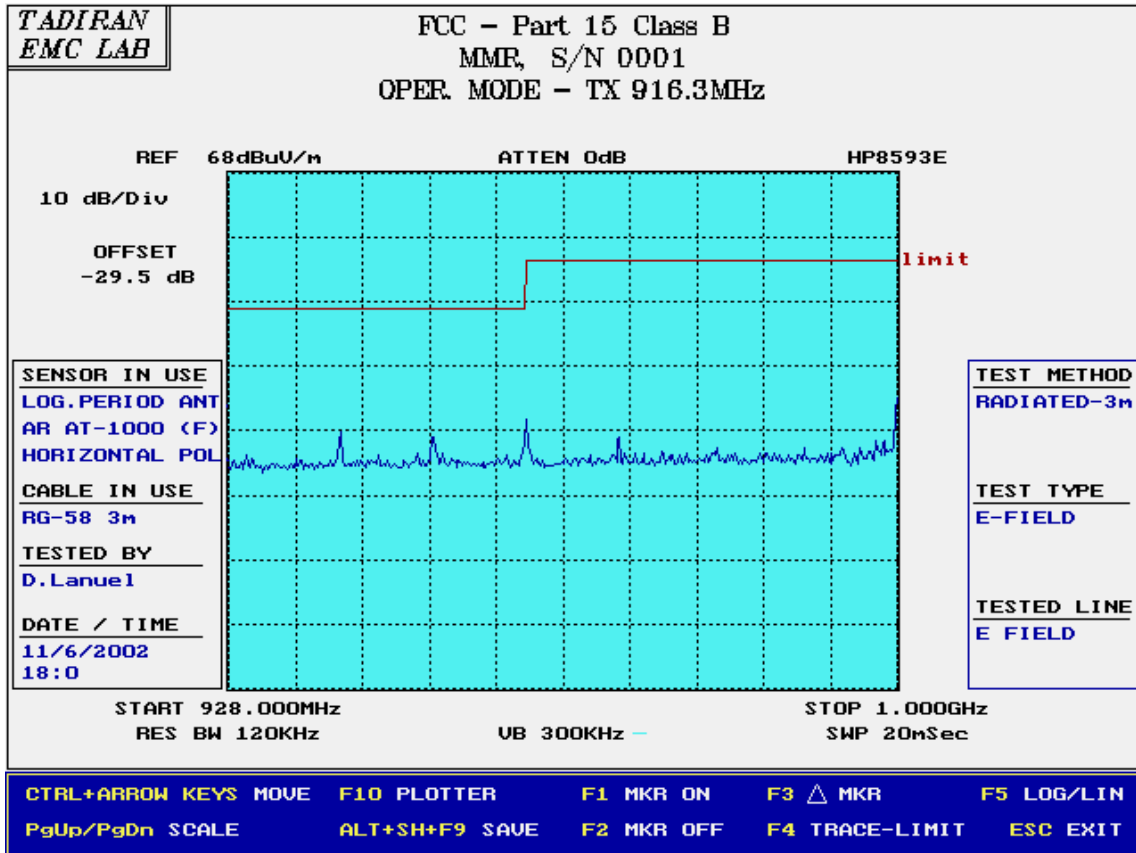

PLOT RE/ 16

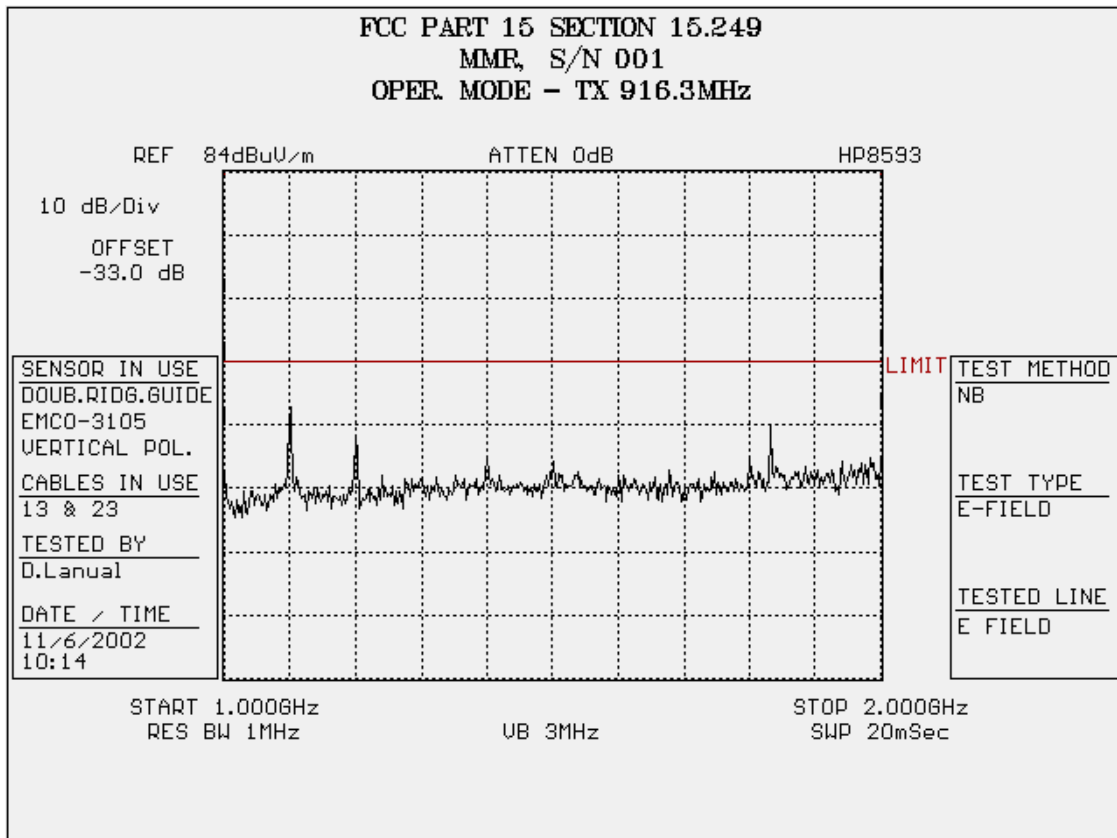

PLOT RE/ 17

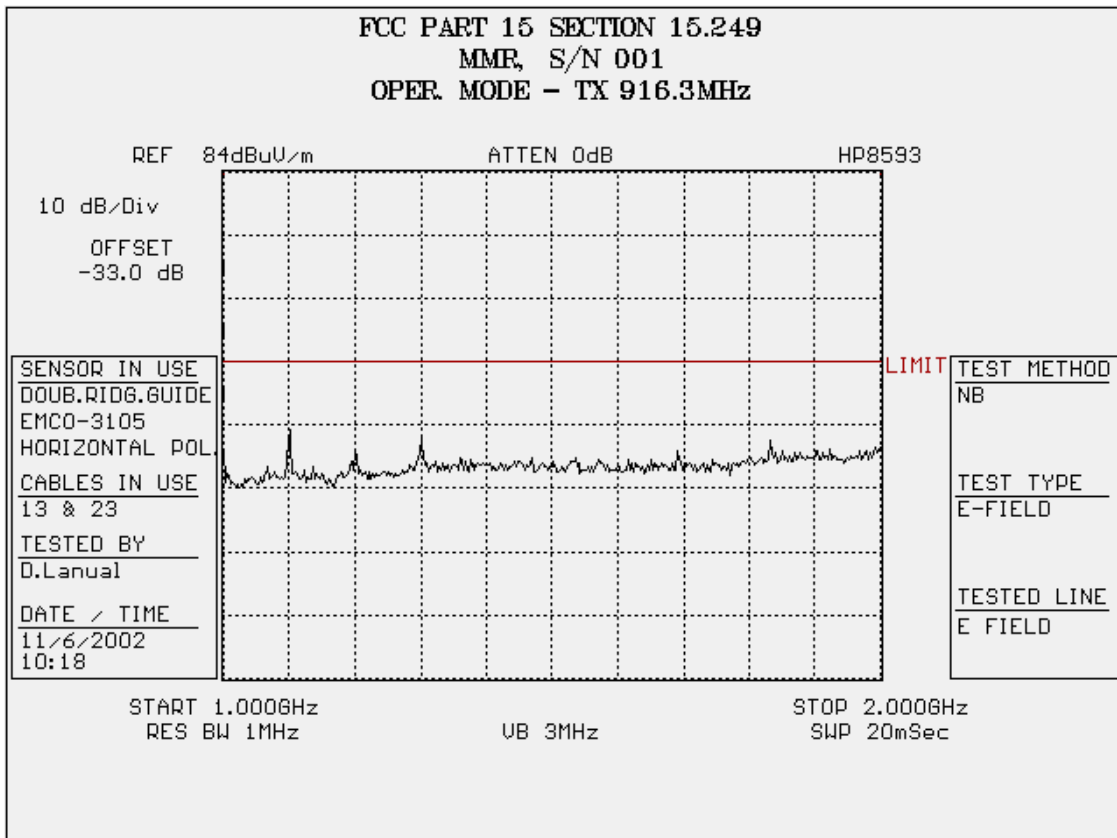

PLOT RE/ 18

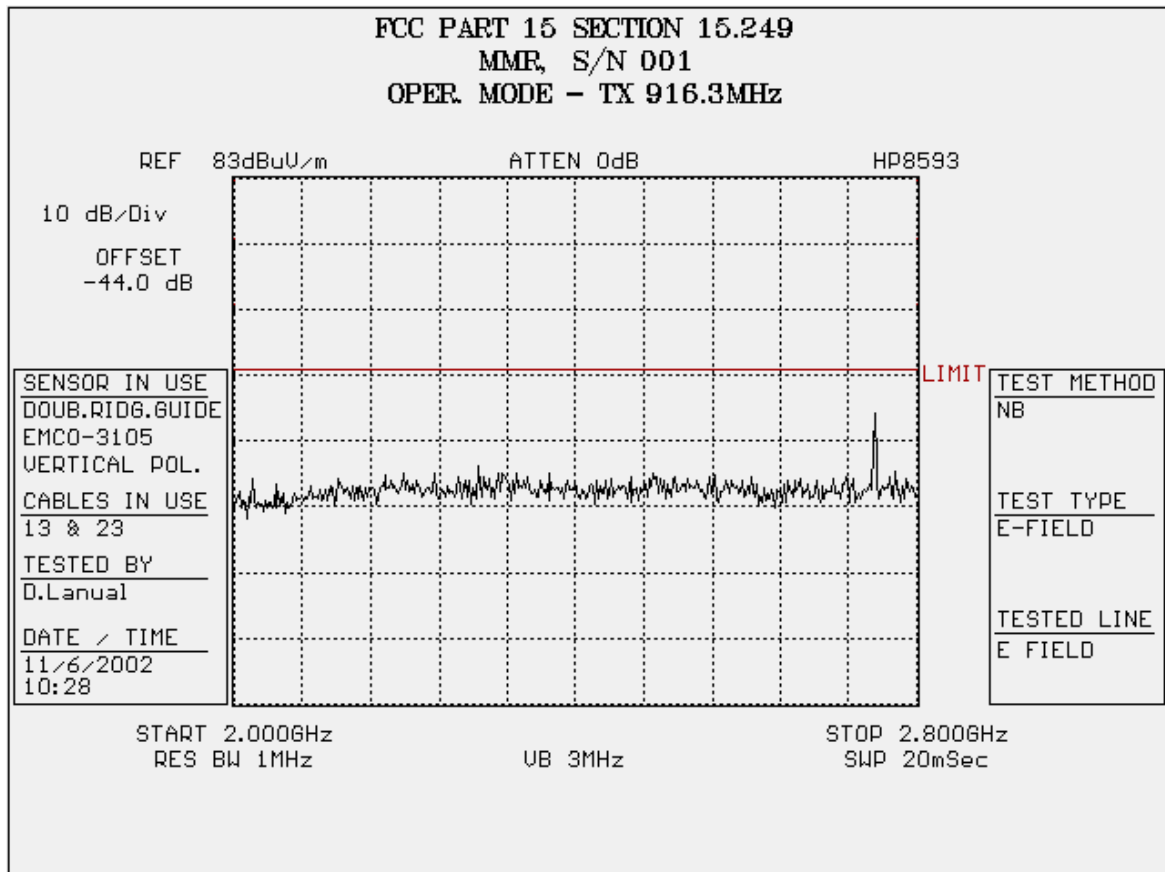

PLOT RE/ 19

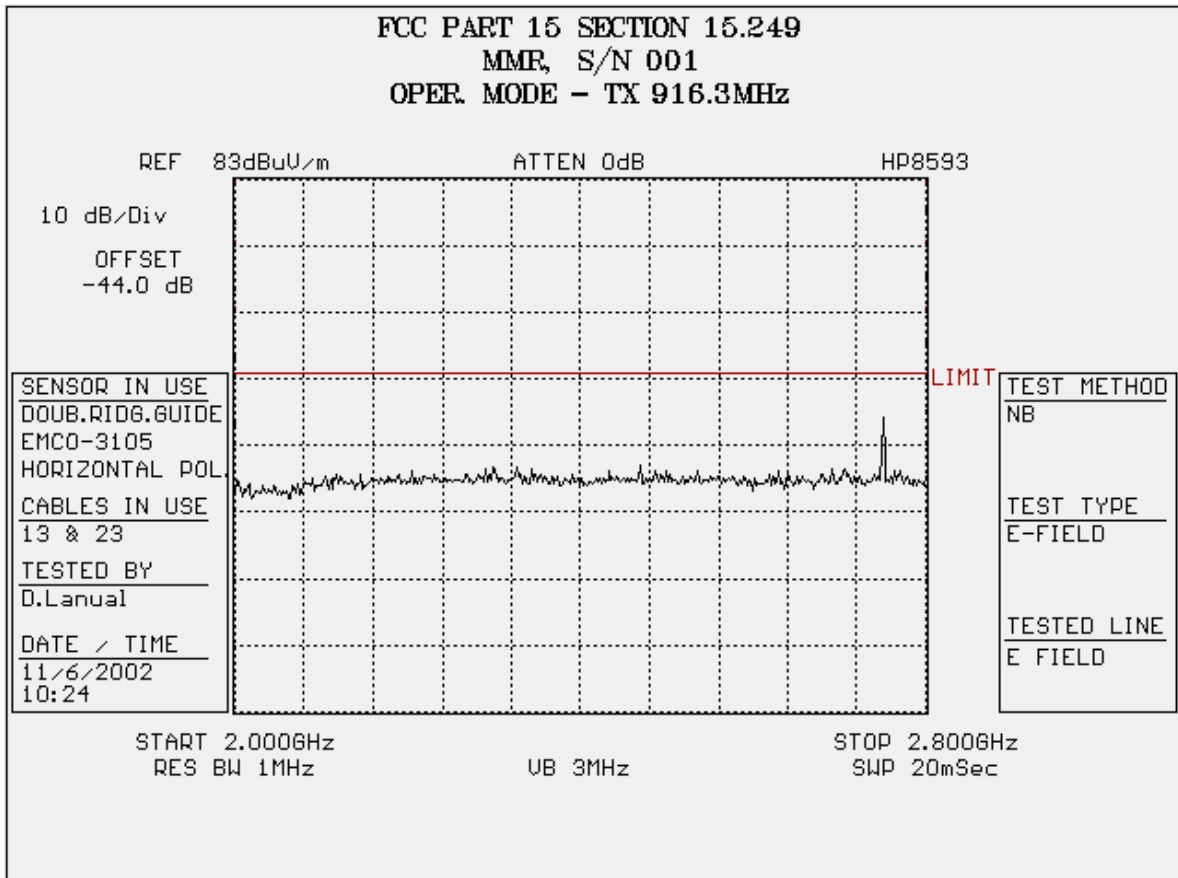

PLOT RE/ 20

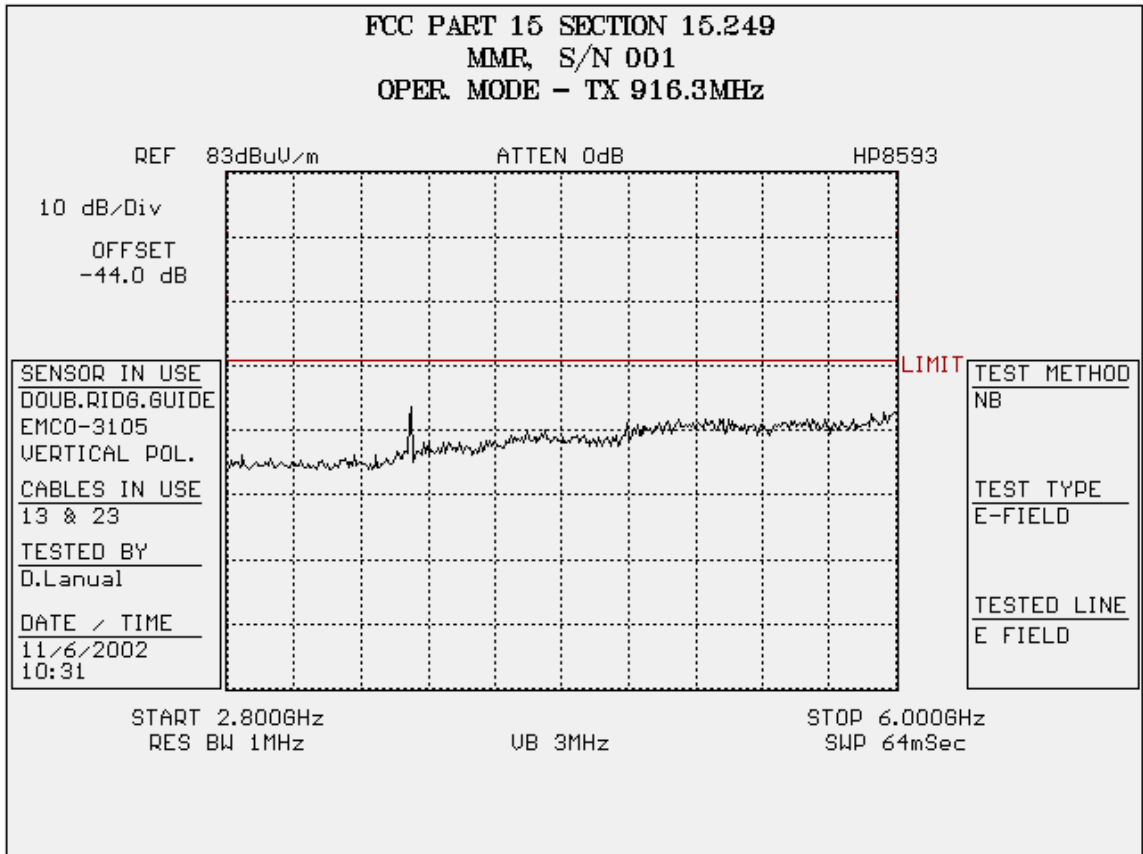

PLOT RE/ 21

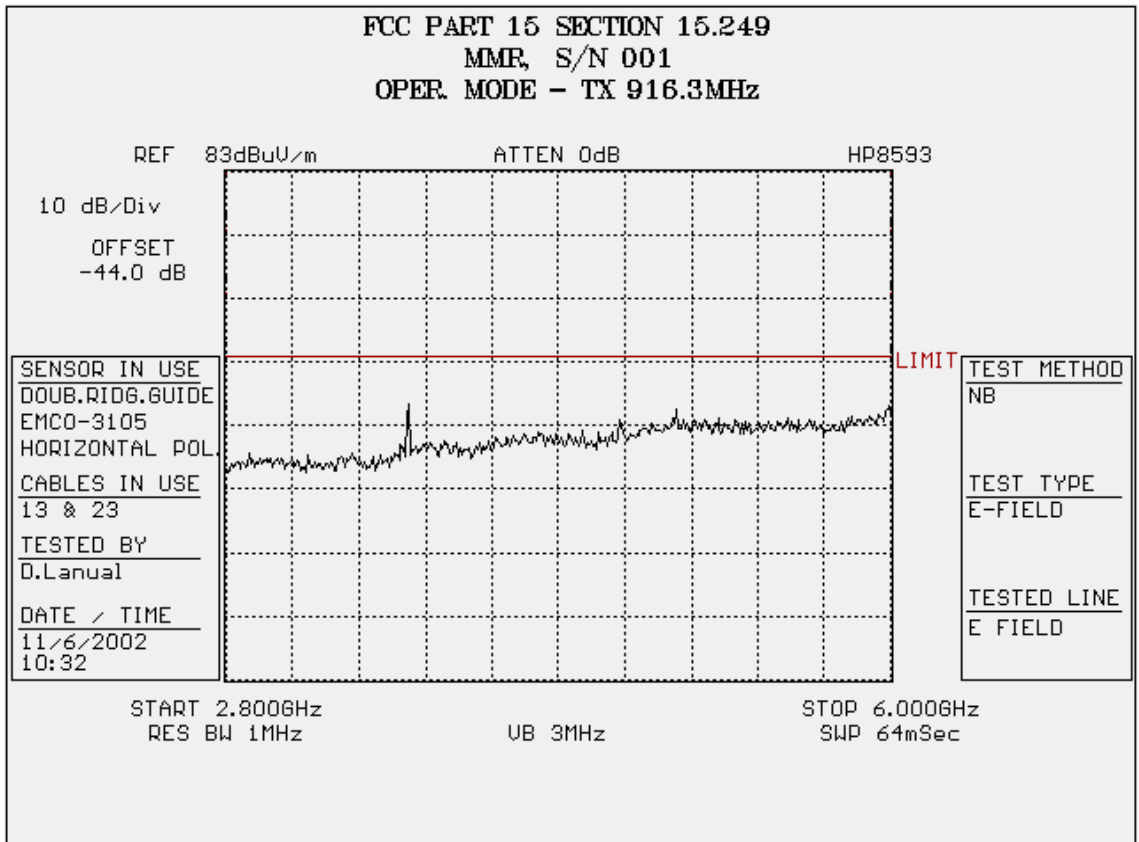

PLOT RE/ 22

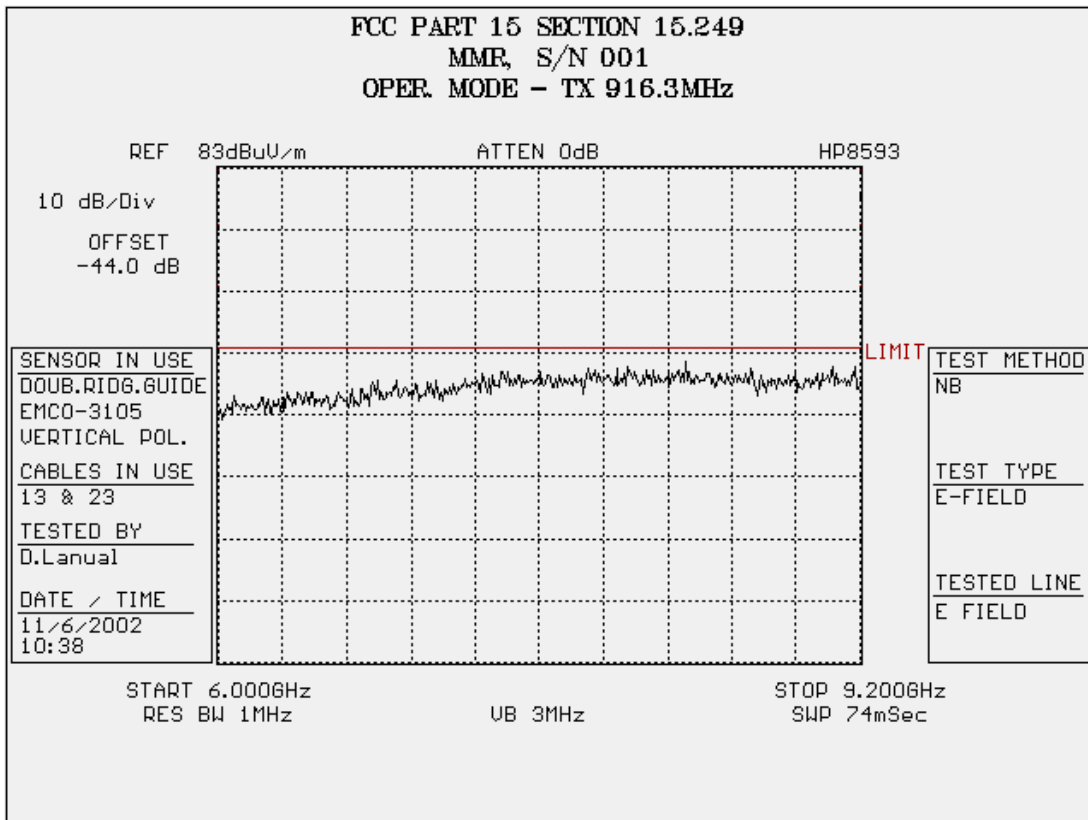

PLOT RE/ 23

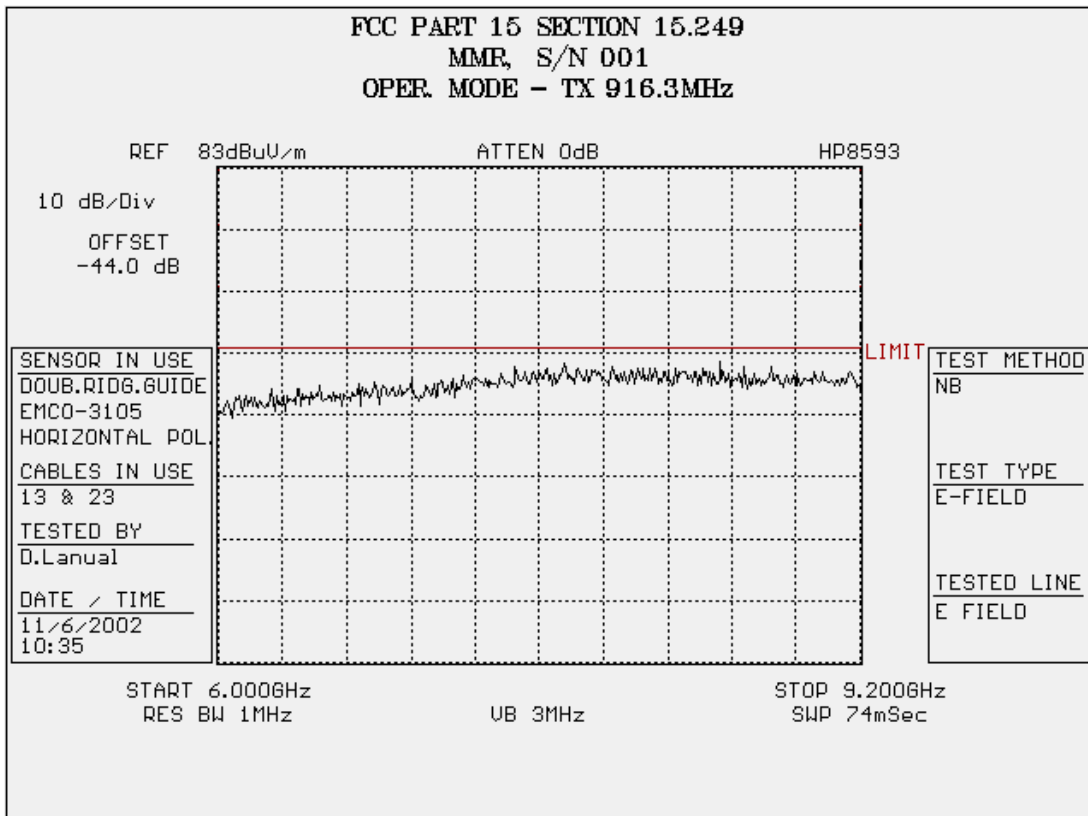

PLOT RE/ 24

6. FINAL RADIATED INTERFERENCE FIELD STRENGTH MEASUREMENT

Testing Engineer: D.Lanuel *[Signature]*

Date 16/06/02

6.1. Test Instrumentation and Equipment

Table RE-A Test Instrumentation and Equipment

Item	Model	Manufacturer	Next Date Cal.
Spectrum Analyzer	8568B+opt 462	HP	11.12.02
Preselector	85685A	HP	19/8/02
Quasi-Peak Detector	85650	HP	19/8/02
Biconical Antenna, (20 MHz - 200 MHz)	94455-1	Singer	10.04.03
Log-Periodic Antenna, (200-1000MHz)	AT-1000	AR	10.04.03
Computer	PENTIUM	IBM Compatible	N.P.C.R

6.2. Test Setup

- 6.2.1. The measuring system block diagram shown in Figure RE-1.
- 6.2.2. EUT orientation and antenna position shown in Figure RE-2
- 6.2.3. Cables configuration shown in Figure RE-3

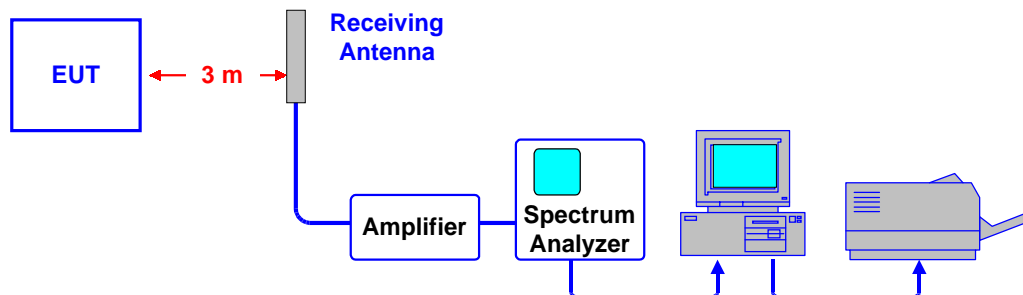

Figure RE-1

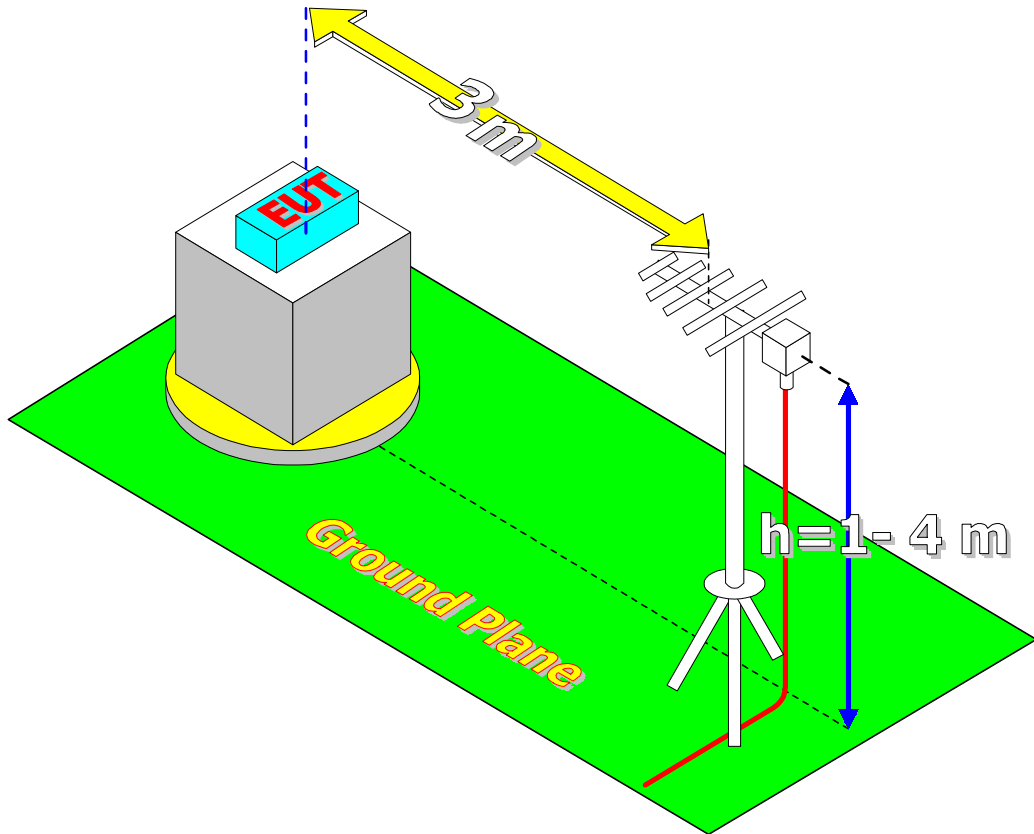
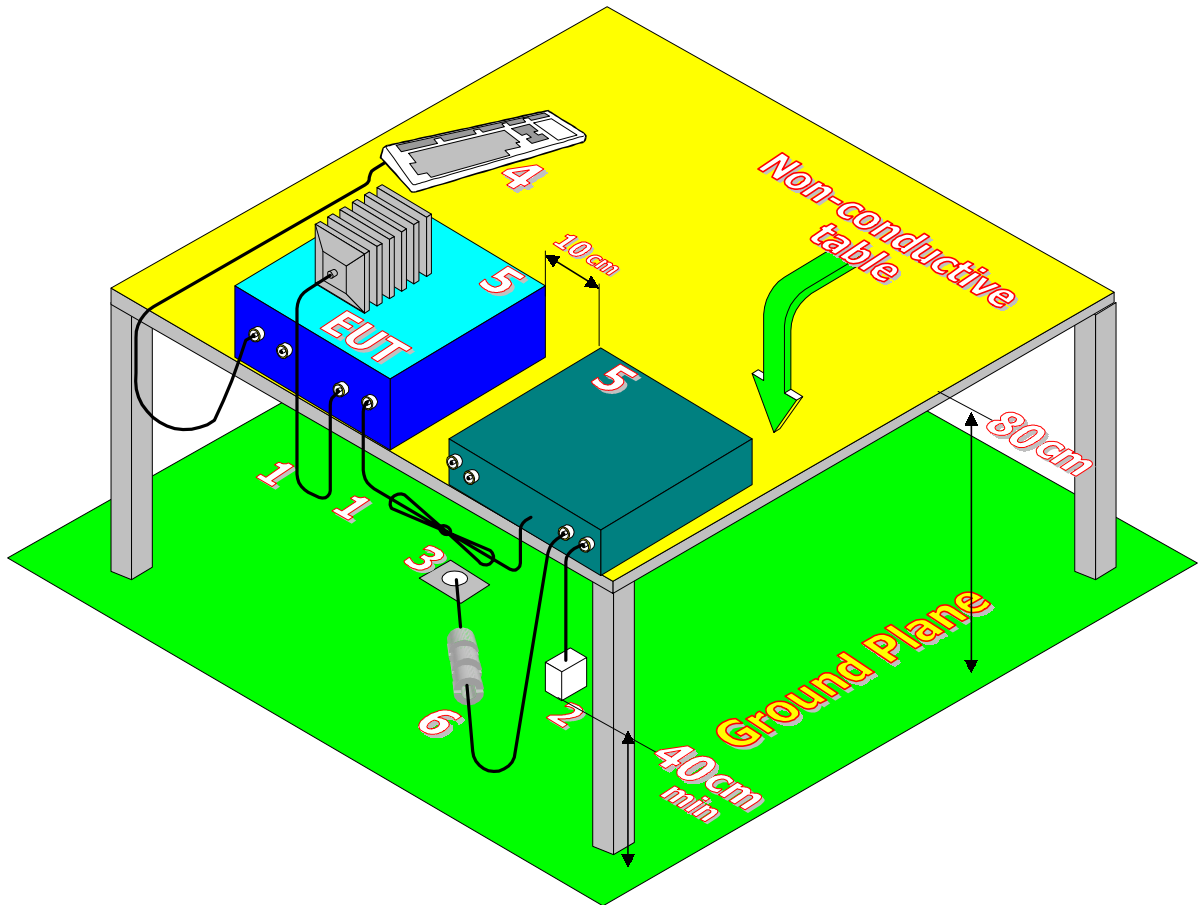

Figure RE-2



1. If cables, which hang closer than 40 cm to the horizontal ground plane cannot be shortened to the appropriate length, the excess shall be folded back and forth forming a bundle 30 cm to 40 cm long.
2. The end of I/O signal cables, which are not connected to a peripheral, may be terminated, if required to proper operation using correct terminating impedance.
4. Main junction boxes shall be flush with, and bonded directly to, metal ground plane
4. Cables of hand operated devices such as keyboards, mouses; etc. shall be placed as for normal usage.
5. Peripherals shall be placed at distance 10 cm from each other and from the controller, except for the monitor which, if for an acceptable installation practice, shall be placed directly on top of the controller.
6. Mains cables, telephone lines or other connections to auxiliary equipment located outside the test area shall drape to the floor, be fitted with ferrite clamps or ferrite tubes placed on the floor at the point where the cable reaches the floor and then routed to the place where they leave the turn table. No extension cords shall be used to mains receptacle.
7. Ferrite clamps or ferrite tubes. No more than one cable per clamp.

6.3. Final Test Results

Table RE-F Six Highest Emissions RX Mode 15.107

Mode Of Operation	Freq. (MHz)	Quasi-peak Reading (*) (dBμV/m)	Limit (dBμV/m)	Margin (dB)	Polarity Ver/Hor	Height (m)	Azimuth Angle φ (deg)
	200.0	30.0	46	28	H	2.0	-25
RX	296.0	39.0	46	7	H	1.8	-25
	500.0	26.0	46	20	H	1.8	-25
	704.0	31.0	46	15	H	1.9	-25
	844.0	34.0	46	12	V	2.0	-25
	908.0	30.0	46	16	H	2.0	-25

(*) Resolution B/W = 120 kHz

Table RE-G Six Highest Emissions Spurious TX Mode 15.209

Mode Of Operation	Freq. (MHz)	Quasi-peak Reading (*) (dBμV/m)	Limit (dBμV/m)	Margin (dB)	Polarity Ver/Hor	Height (m)	Azimuth Angle φ (deg)
	231.0	34.0	46.0	12	V	2.4	-25
TX	704.0	37.0	46.0	9	V	2.4	-25
	845.0	41.0	46.0	5	V	2.4	-25
	1100.0	40.0	54.0	8	V	1.8	-25
	1200.0	45.0	54.0	12	V	1.8	-25
	3664.0	45.0	54.0	12	H	1.8	-25

(*) Resolution B/W = 120 kHz

Table RE-H Six Highest Emissions Spurious TX Mode 15.249

Mode Of Operation	Freq. (MHz)	Quasi-peak Reading (*) (dBμV/m)	Limit (dBμV/m)	Margin (dB)	Polarity Ver/Hor	Height (m)	Azimuth Angle φ (deg)
TX	902.0	40.0	46.0	6	H	2.4	-25

(*) Resolution B/W = 120 kHz

**7. CONDUCTED EMISSIONS, AC POWER LEADS
ACCORDING TO FCC 15.207**

Frequency Range: 450 kHz – 30 MHz

Testing Engineer: D.Lanuel *D.Lanuel*

Date : 4-8/7/02

7.1. Equipment Under Test Description and Operation
MMR, FAT, S/N 0001 manufactured by TADIRAN-Telematics

7.1.1. Modes of Operation

The MMR was set to **Battery Charge at RX Mode and TX Mode**

7.1.2. Operating Voltage 110 V, AC 50Hz

7.2. Test Results Summary & Conclusions

The MMR complies with FCC, Part 15.207 conducted emissions requirement.

7.3. Limits of Conducted Emission at Mains Terminals

The test unit shall meet the limits of Table 1 for FCC Part 15 Para 15.207 equipment.

Table 1 Limits for intentional radiator according 15.207

Frequency Range MHz	Quasi-peak Limits dBμV
0.45 – 30	48

7.4. Test Instrumentation and Equipment

Table CD-A – Test Instrumentation and Equipment

Item	Model	Manufacturer	Next Date Calibration
Spectrum Analyzer	8593E	HP	31/01/03
Signal Generator	2017	Marconi	1/08/02
LISN	FCC-LISN-3B	FISCHER	31/08/02

7.5. Test Setup

7.5.1. Calibration setup shown in Figure CE-1.

7.5.2. The testing setup shown in Figure CE-2.

7.5.3. Equipment and cable configuration shown in Figure CE-3.

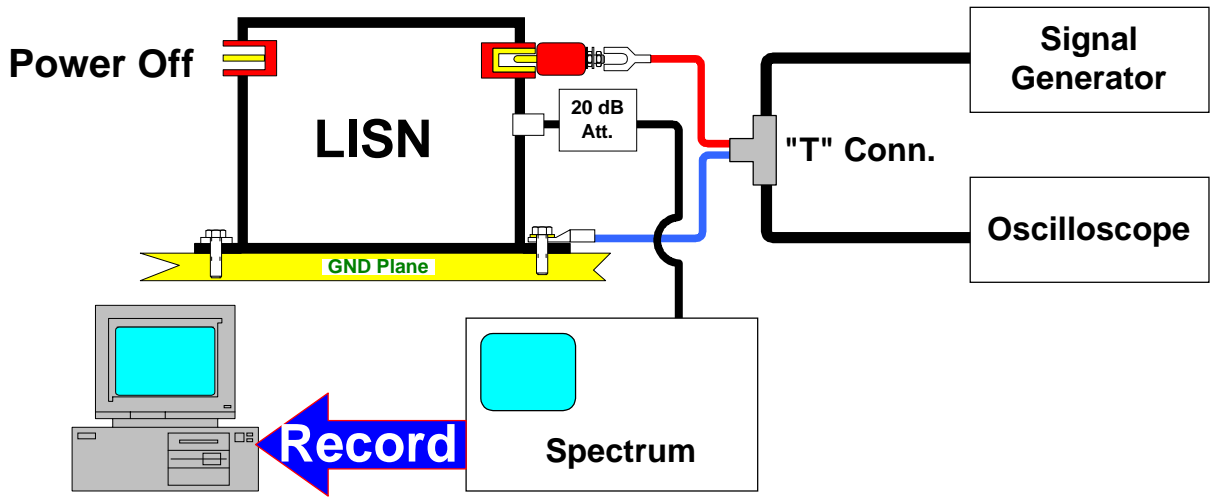

Figure CE-1

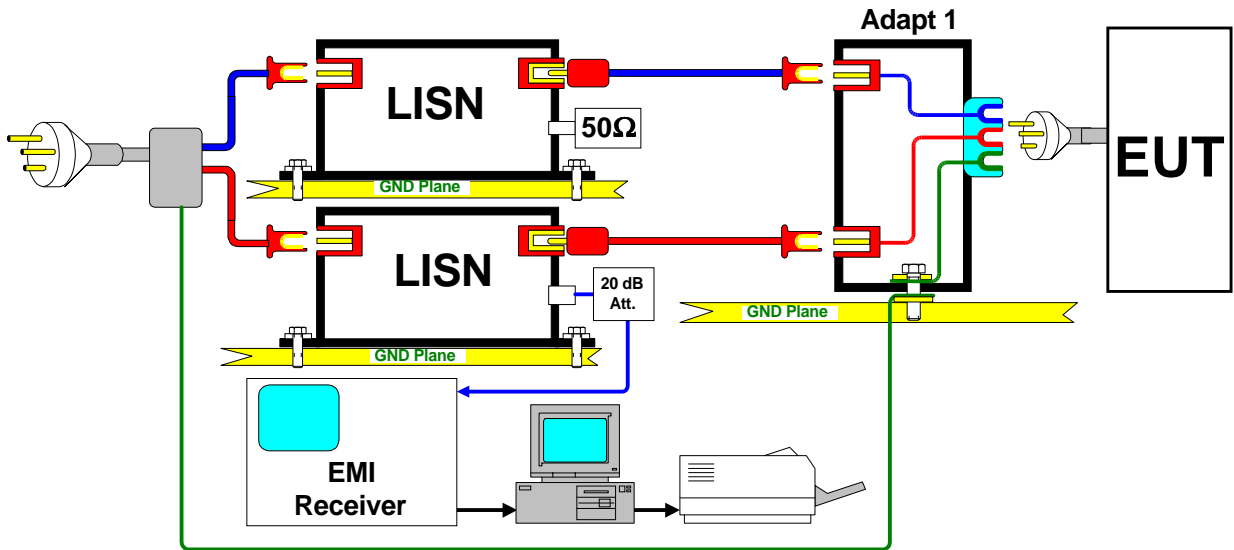

Figure CE-2

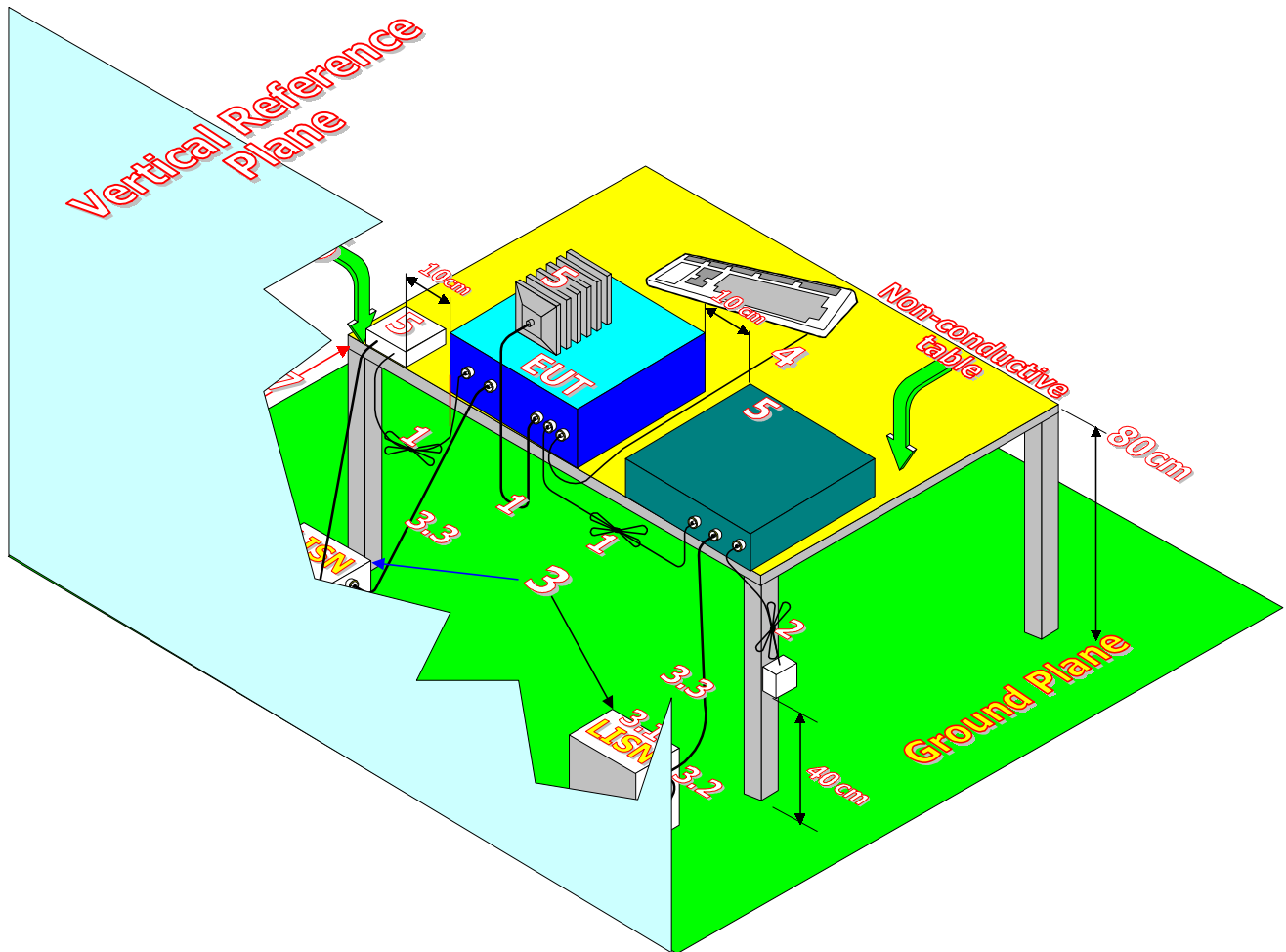

Figure CE-3

- 1 Interconnecting cables that hang closer than 40 cm to the horizontal ground plane shall be folded back and forth forming a bundle 30 cm to 40 cm long, hanging approximately in the middle between ground plane and table.
- 2 I/O cables are connected to a peripheral shall be bundled in the center. The end of the cable may be terminated if required using correct terminating impedance.
- 3 The total length shall not exceed 1 m.
- 3 EUT is connected to one LISN. Unused LISN connectors shall be terminated in 50 Ω.
- 4 All other equipment powered from second LISN
- 5 A multiple outer strip can be used for multiple power cords of non-EUT equipment.
- 6 LISN at least 80 cm from nearest part of EUT chassis.
- 7 Cables of hand operated devices such as keyboards, mouses; etc. have to be placed as close as possible to the host Non-EUT components being tested.
- 8 Rear of EUT, including peripherals shall be all aligned and flush with the rear tabletop.
- 9 Rear tabletop shall be 40 cm removed from a vertical conducting plane that bonded to the floor ground plane.

7.6. Test Procedure

The test procedure shall be as follows:

7.6.1. Calibration.

Perform the measured system check using the calibration setup shown in Figure CE-1.

7.6.2. Turn on the measurement equipment and allow sufficient time for stabilization.

7.6.3. Apply the calibrated signal level, which is 6 dB below the limit given in Table 1 at 450kHz, 1 MHz and 10 MHz to the power output terminal of LISN.

7.6.4. Scan the spectrum analyzer for each frequency in the same manner as a normal data scan. Verify that the spectrum analyzer indicates a level within ± 3 dB of injected level. Correction factor shall be applied for LISN and 20 dB for attenuator.

7.6.5. EUT Testing. Perform emission data scan using the measurement setup shown in Figures CE-2 and CE-3.

7.6.6. Turn on the EUT for TX-916.3 MHz operational mode and allow sufficient time for stabilization.

7.6.7. Select (Phase) lead for testing.

7.6.8. Scan the spectrum analyzer over the applicable frequency range

7.6.9. Repeat (2) and (3) for (Neutral) lead.

7.6.10. Repeat testing for RX operational mode.

7.6.11. Choose six highest emissions relative to limit and feel Table CE-D.

7.6.12. Perform measurements for selected frequencies using quasi-peak detector.

Table CE-B Calibration Results

Lead P/N	Frequency MHz	Plot No.	Test Signal DBuV(peak)	Result dBuV	Deviation dB
Phase	0.45	CE-CAL/ 1	42	42.1	0.1
	1.0	CE-CAL/ 2	42	42.1	0.1
	10	CE-CAL/ 3	42	41.2	0.2
Neutral	0.45	CE-CAL/ 4	42	42.4	0.4
	1.0	CE-CAL/ 5	42	42.1	0.1
	10	CE-CAL/ 6	42	40.8	1.2

Table CE-C Test Results 15.207

Lead P/N	Mode of Operation	Frequency Range (MHz)	Resolution BW (kHz)	Plot No.	Comply. Y/N
Phase	TX	0.45 – 30	9	CE/ 1	Y
Neutral		0.45 – 30		CE/ 2	Y
Phase	RX	0.45 – 30	9	CE/ 3	Y
Neutral		0.45 – 30		CE/ 4	Y

Table CE-D Six Highest Emissions

Lead P/N	Mode of Operation	Freq. (MHz)	Receiver Detector	Reading (dB μ V)	Limit (dB μ)	Margin (dB)
PHASE	TX	1.115	QUPEAK	38.7	48	9.3
Neutral		1.115	QUPEAK	37.3	48	10.7
PHASE	RX	1.115	QUPEAK	25	48	23
Neutral		1.115	QUPEAK	27.7	48	20.3

(*) Resolution B/W = 9 kHz

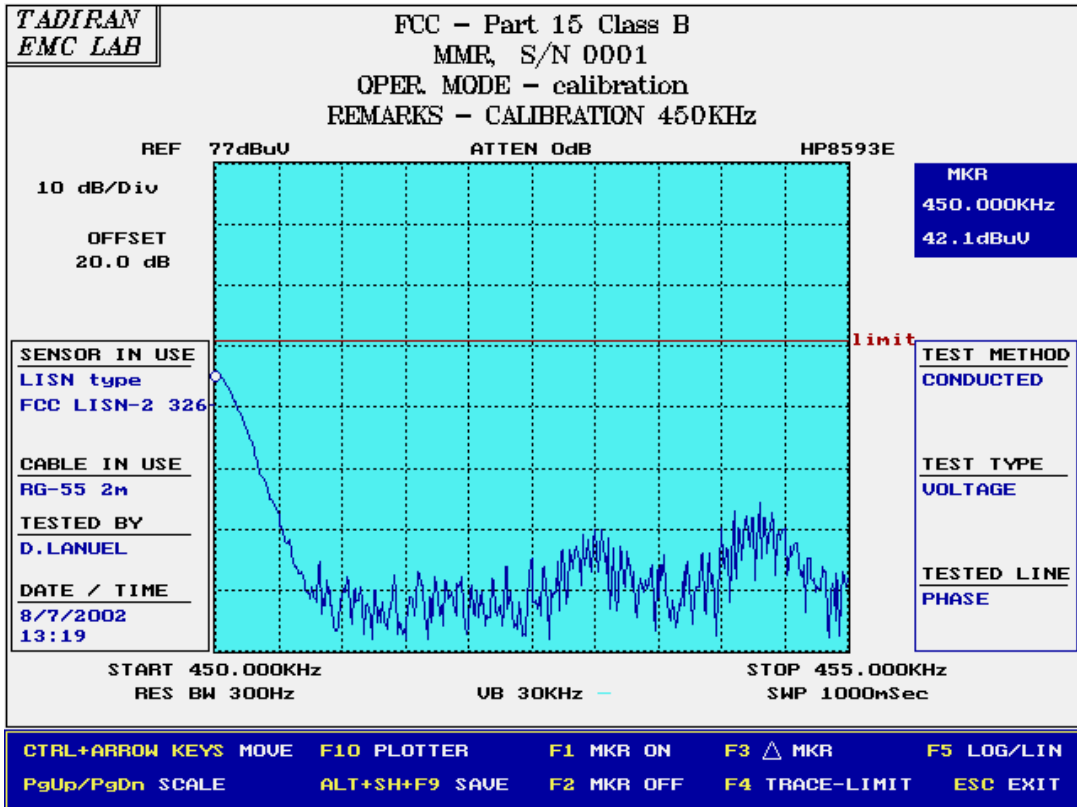

Plot Cal/ 1

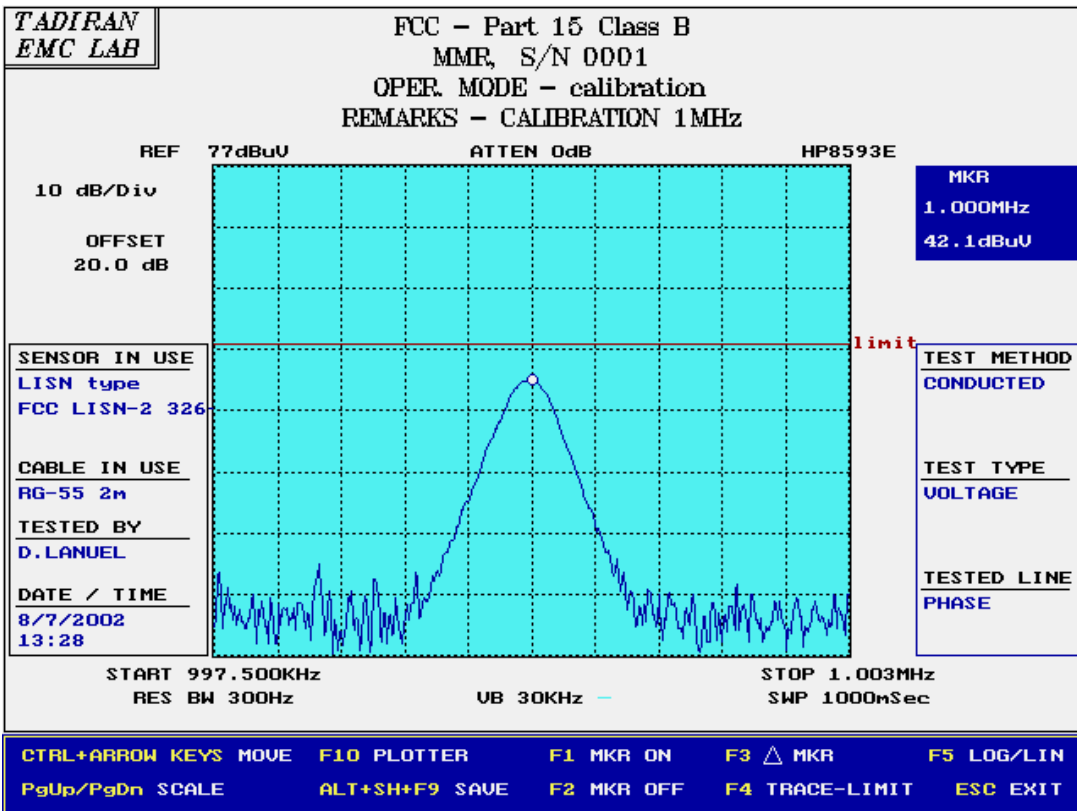

Plot Cal/ 2

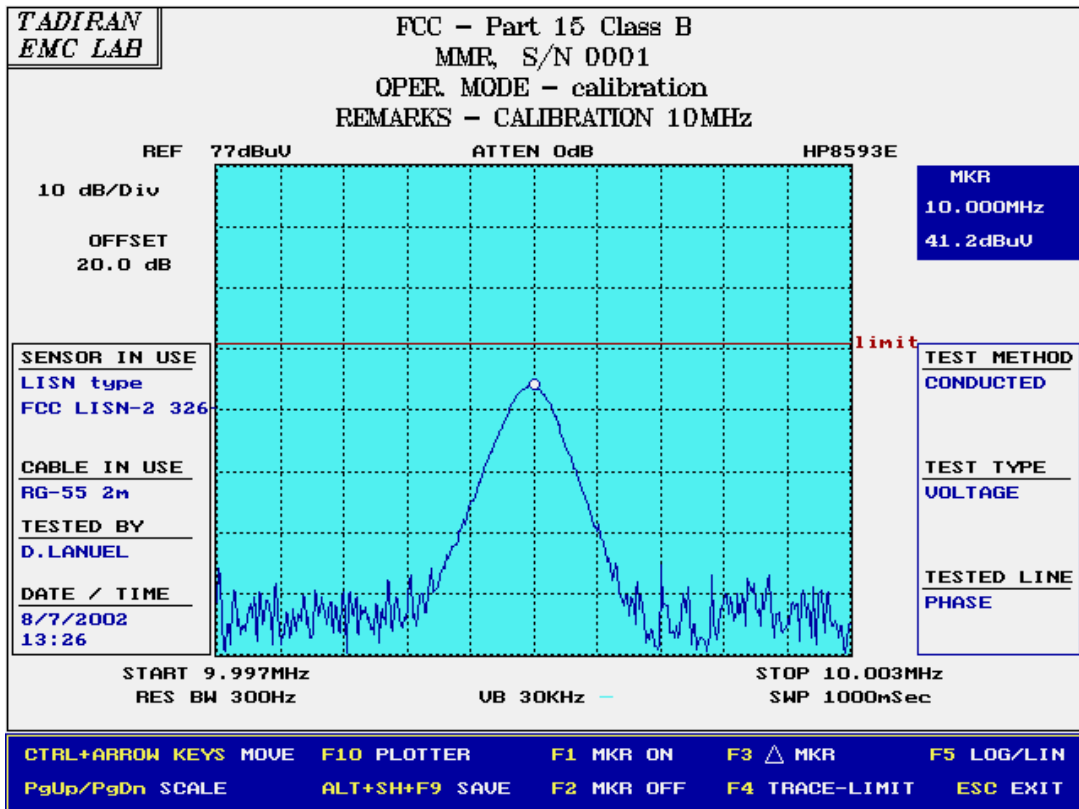

Plot Cal/ 3

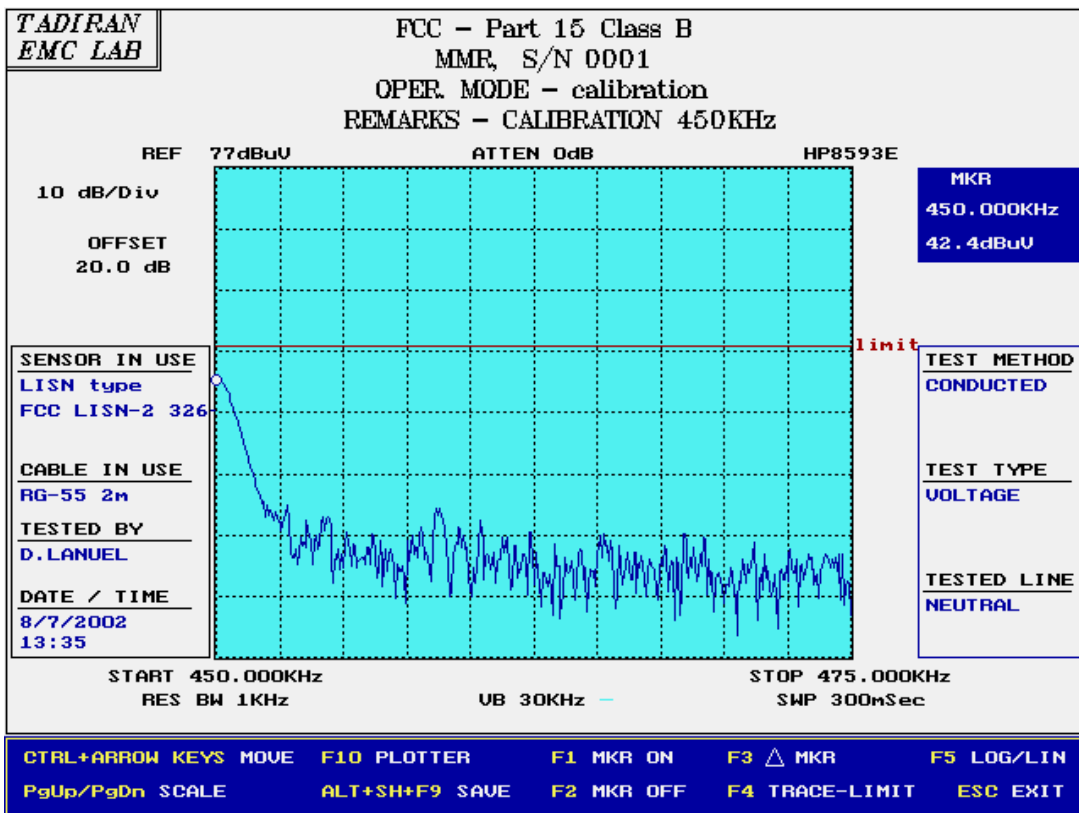

Plot Cal/ 4

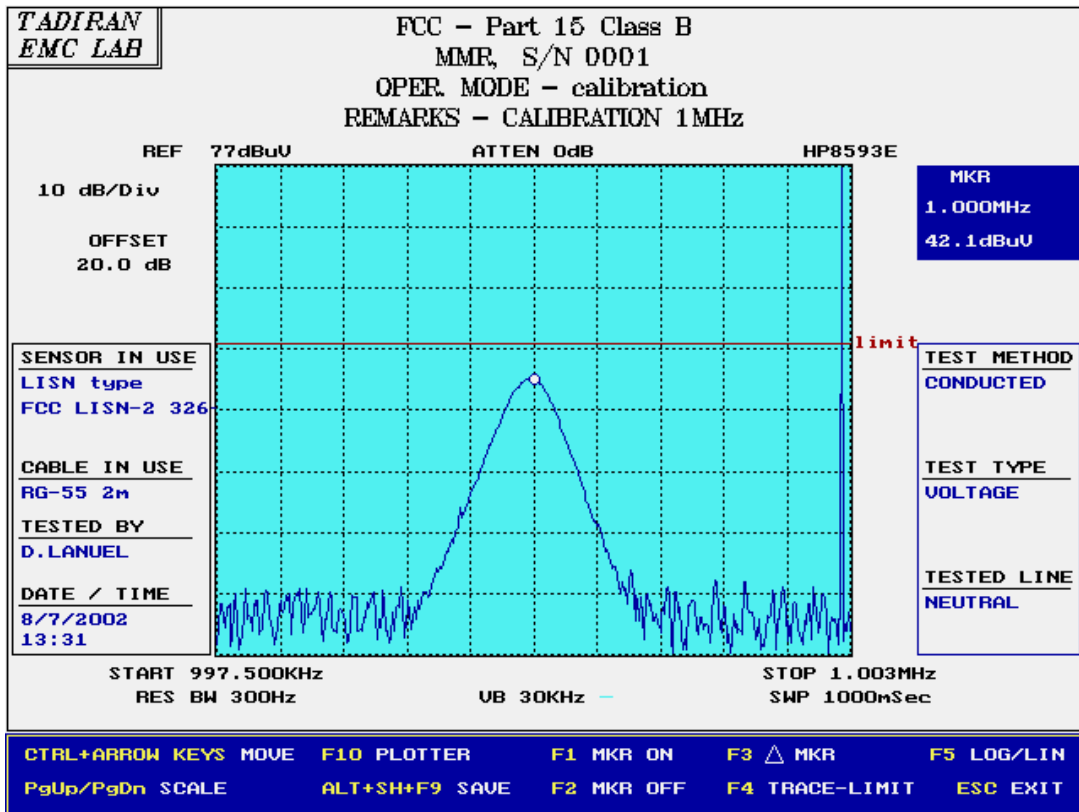

Plot Cal/ 5

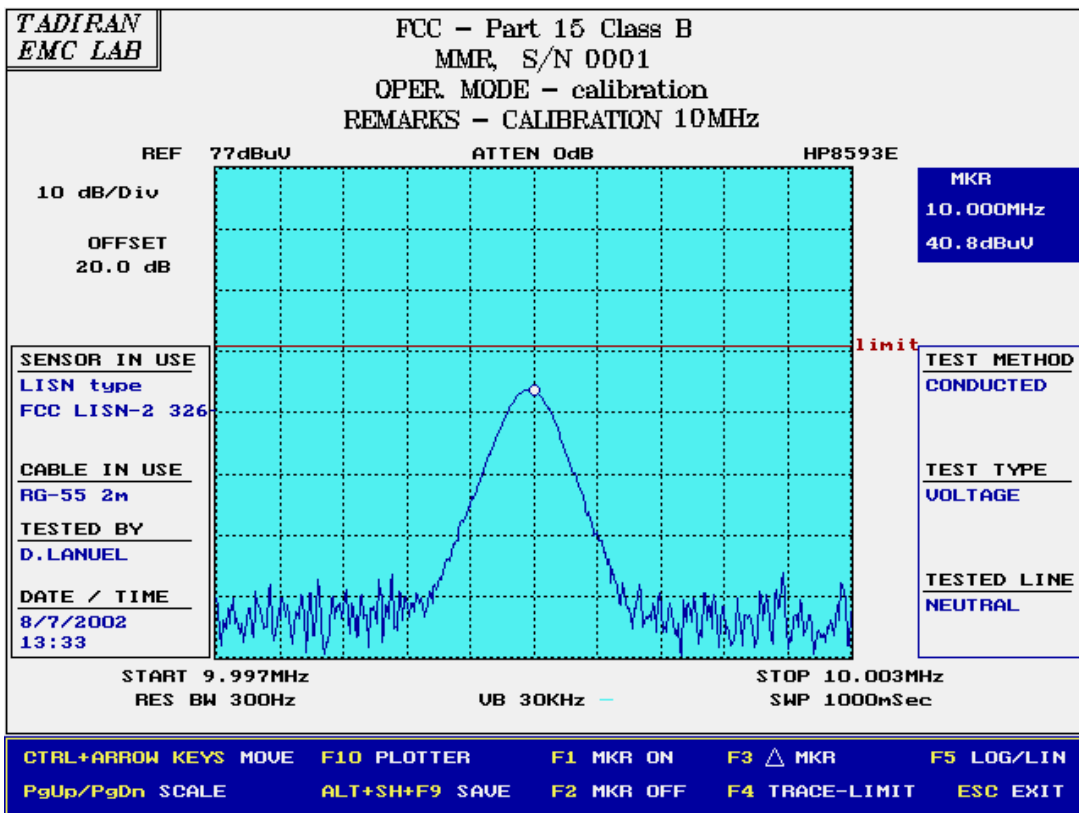

Plot Cal/ 6

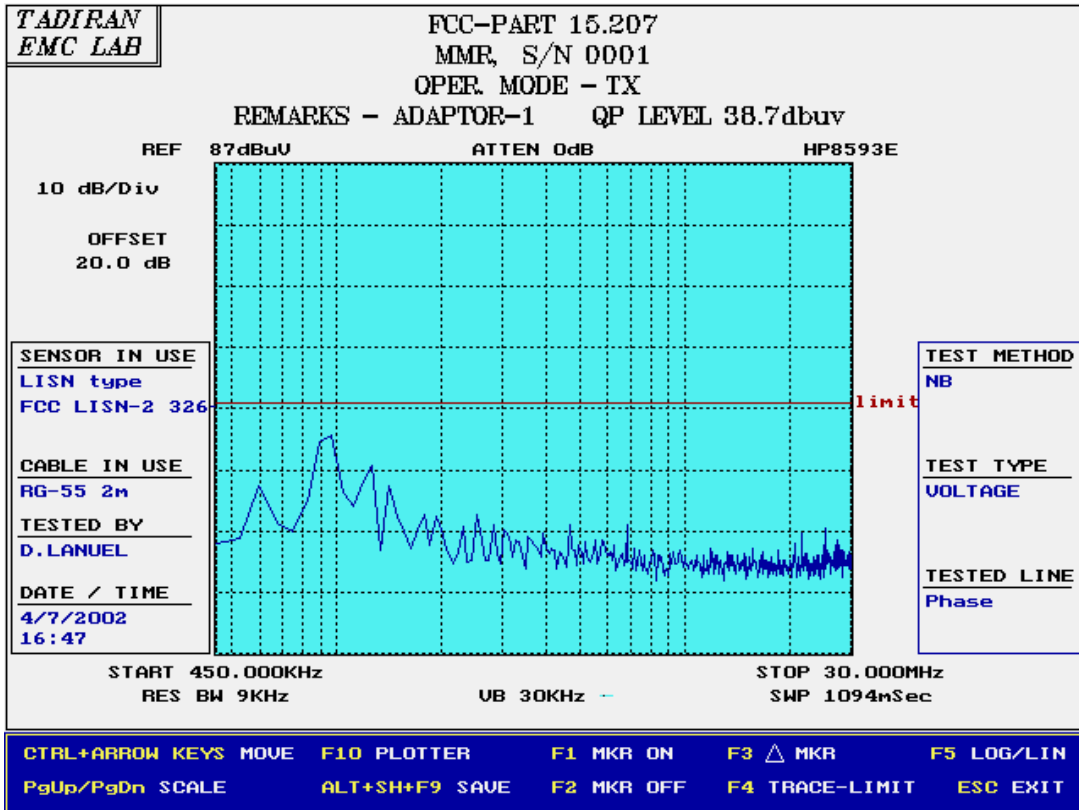

PLOT CE/ 1

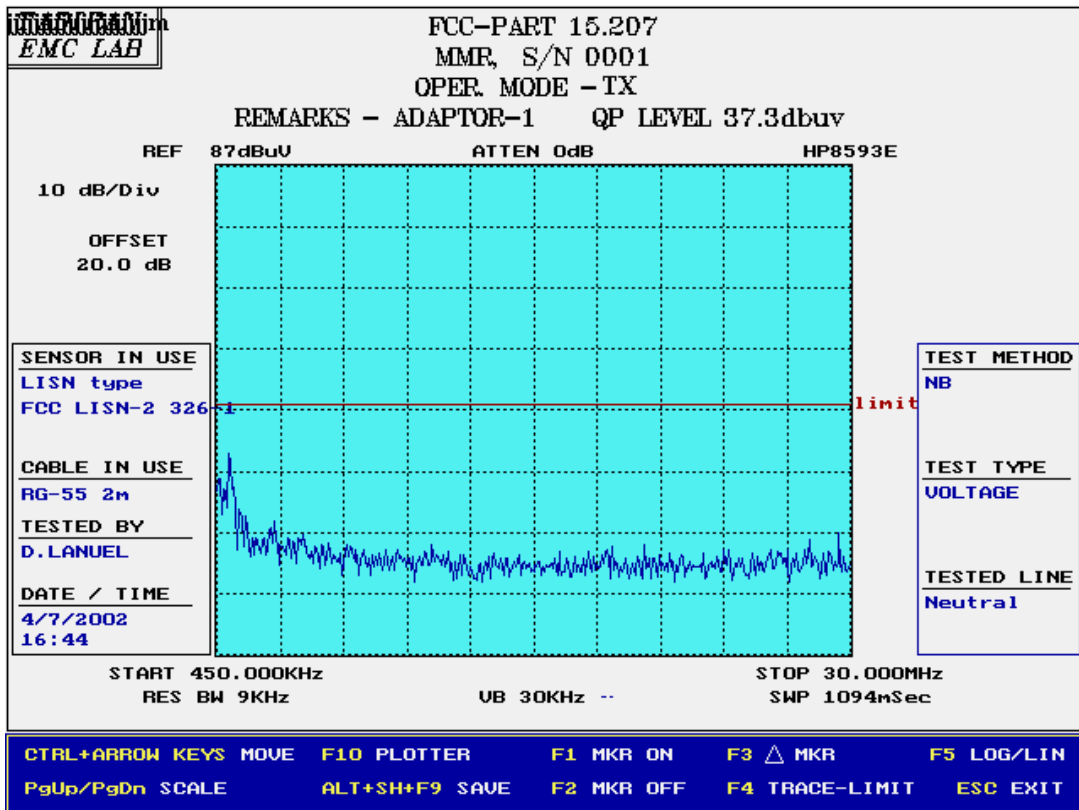

PLOT CE/ 2

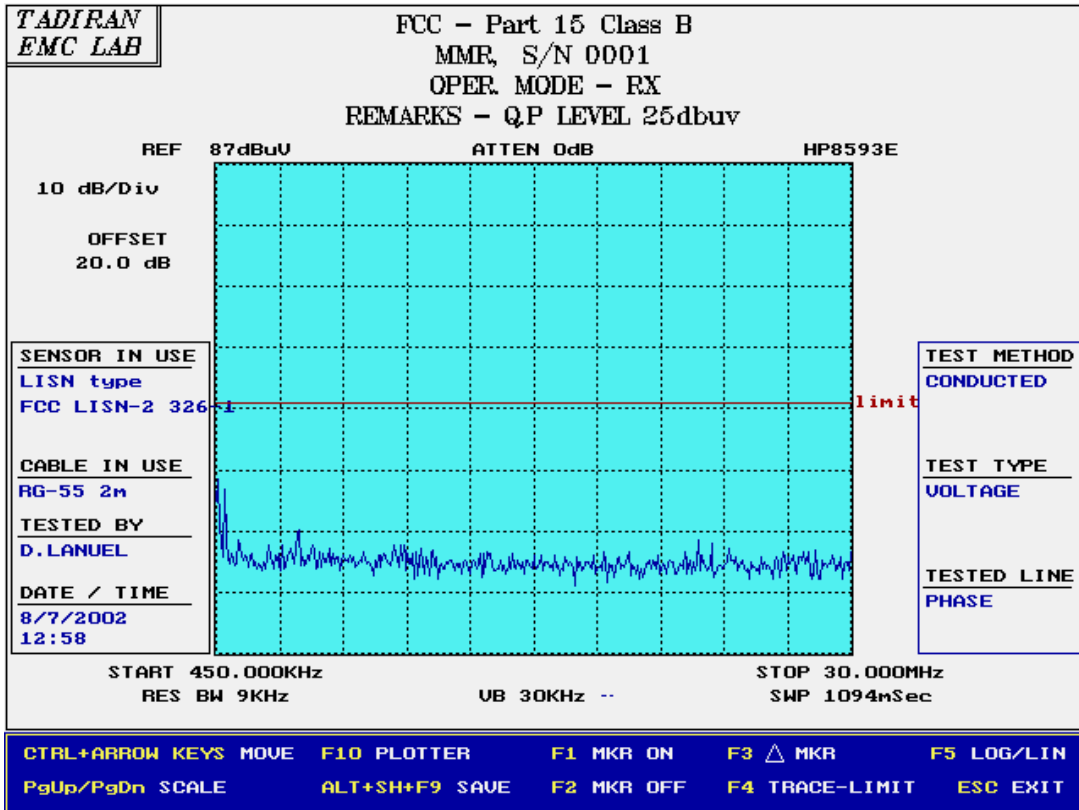

PLOT CE/ 3

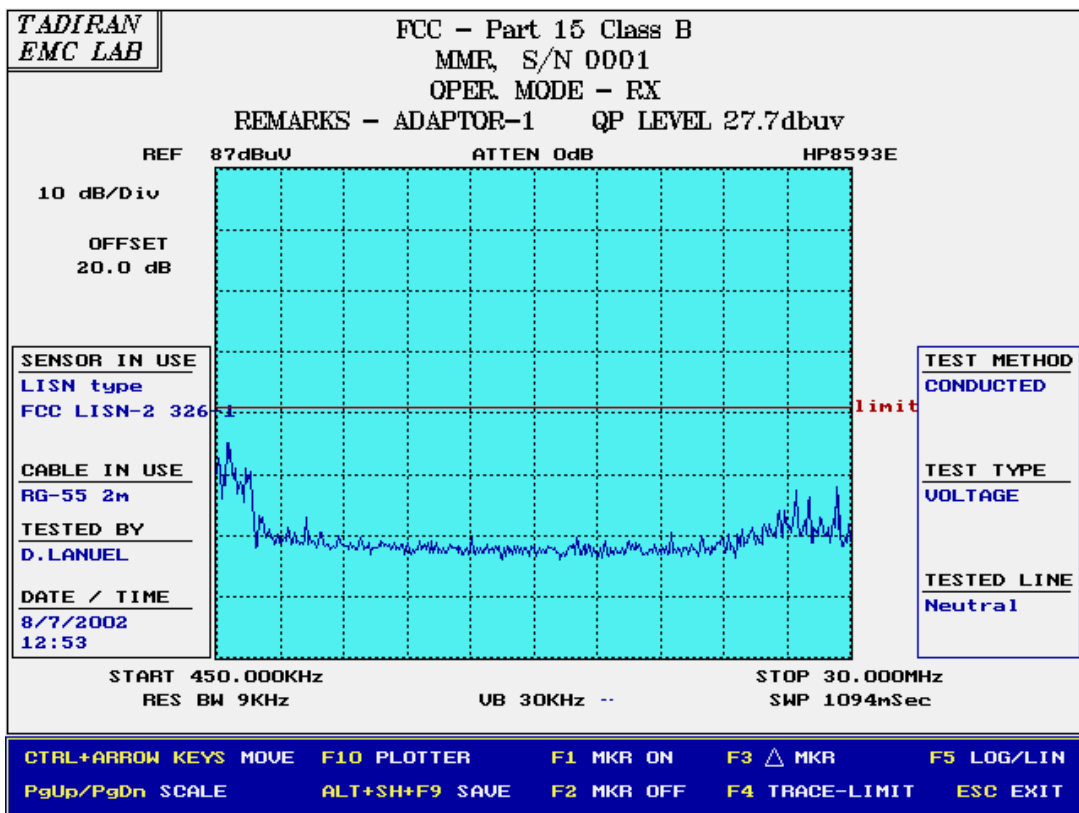

PLOT CE/ 4